



User Guide

HD Pan/Tilt Wi-Fi Camera

NC450

CONTENTS

Chapter 1 About This Guide	1
1.1 Conventions.....	1
1.2 Overview of This Guide.....	1
1.3 More Info	2
Chapter 2 Get to Know Your Camera	3
2.1 Product Overview	3
2.2 Panel Appearance	3
2.2.1 Front Panel.....	3
2.2.2 Rear Panel	4
Chapter 3 Set Up Your Camera	6
3.1 Set up the Camera with the tpCamera App	6
3.2 Position Your Camera.....	8
Chapter 4 Configure Your Camera	11
4.1 Log in to Your Camera.....	11
4.2 Live View	13
4.3 Basic.....	15
4.3.1 Basic > Status	15
4.3.2 Basic > Network.....	17
4.3.3 Basic > Wireless Connection.....	18
4.3.4 Basic > Cloud Setting	20
4.3.5 Basic > LED	21
4.4 Advanced.....	22
4.4.1 Advanced > Status.....	22
4.4.2 Advanced > Network.....	22
4.4.3 Advanced > Wireless Connection.....	26
4.4.4 Advanced > Cloud Setting	27
4.4.5 Advanced > Video.....	27
4.4.6 Advanced > Sound Detection	29
4.4.7 Advanced > Motion Detection.....	30
4.4.8 Advanced > SD Card	31
4.4.9 Advanced > Notification Delivery.....	33
4.4.10 Advanced > LED.....	35
4.5 System.....	35
4.5.1 Account	35
4.5.2 Date/Time.....	37
4.5.3 Management.....	39
4.5.4 System Log	41

Chapter 1 About This Guide

This guide is a complement to Quick Installation Guide. The Quick Installation Guide instructs you on quick setup, and this guide provides details of each function and shows you the way to configure these functions appropriate to your needs.

When using this guide, please notice that features of the TP-Link Camera may vary slightly depending on the model and software version you have, and on your location, and language. All images, parameters and descriptions documented in this guide are used for demonstration only.

1.1 Conventions

In this Guide, the following conventions are used:

Convention	Description
<u>Teal Underlined</u>	Hyperlinks are teal underlined. You can click to redirect to a website or a specific section.
Teal	Contents to be emphasized and texts on the web page are in teal, including the menus, items, buttons, etc.
 Note	Ignoring this type of note might result in a malfunction or damage to the device.

1.2 Overview of This Guide

Chapter	Introduction
Chapter 1 About This Guide	Introduces the guide structure and conventions.
Chapter 2 Get to Know Your Camera	Introduces the features, application and appearance of the camera.
Chapter 3 Set Up Your Camera	Introduces how to quickly set up the camera using the tpCamera app and how to position your camera.
Chapter 4 Configure Your Camera	Introduces how to configure the camera using the built-in web management page.

1.3 More Info

The latest software, management app and utility can be found at Download Center at <http://www.tp-link.com/support>.

The Quick Installation Guide can be found where you find this guide or inside the product package.

Specifications can be found on the product page at <http://www.tp-link.com>.

A Technical Support Forum is provided for you to discuss our products at <http://forum.tp-link.com>.

Our Technical Support contact information can be found at the Contact Technical Support page at <http://www.tp-link.com/support>.

Chapter 2 Get to Know Your Camera

2.1 Product Overview

TP-Link NC450 HD Pan/Tilt Wi-Fi Camera is a cloud-based Wi-Fi video monitoring device with live streaming and remote viewing, which makes it easy to stay connected with what you care most.

- Easy to install with tpCamera app
- Remote monitoring via TP-Link Cloud website or tpCamera app
- Get notifications when motion or sound is detected, and view alerts history
- View clearer images with HD resolution
- View clearly in the dark with night vision
- Stay in touch with 2-way audio
- Save the image and video in the Micro SD card
- Patrol a large area with pan and tilt

2.2 Panel Appearance

2.2.1 Front Panel

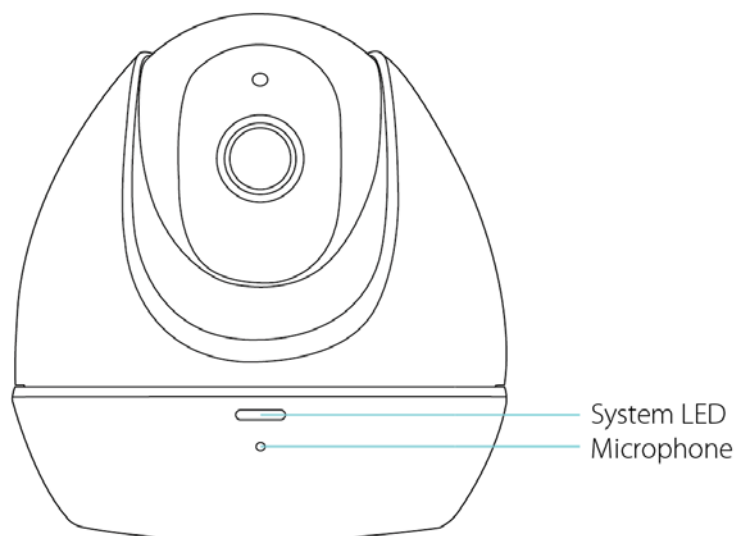

Front Panel

➤ System LED:

Status	Indication
Flashing Red	The camera is starting up.
Solid Red	The camera has started up, but not connected to any network.
Flashing Green	The camera is in firmware upgrade procedure.
	The camera is connecting to a network.
Solid Green	The camera is connected to a network.
	The camera is transferring data.

- **Microphone:** The camera has a built-in internal microphone. This microphone is hidden in the pinhole located on the front panel.

2.2.2 Rear Panel

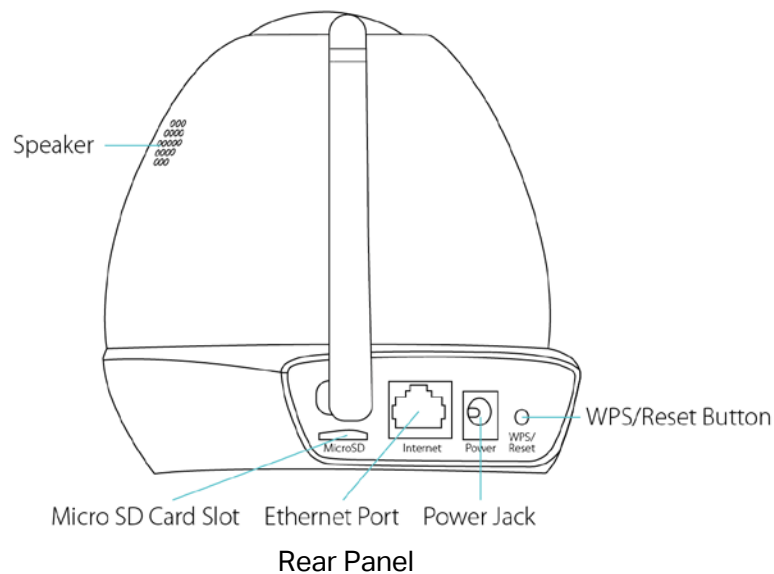

- **Speaker:** For audio output.
- **Micro SD Card Slot:** For holding the micro SD card.
- **Internet Port:** For connecting the camera to your router via an Ethernet cable.
- **Power Jack:** For connecting the camera to a power socket via the provided power adapter.
- **WPS/Reset Button:** The switch for the WPS and Reset function. To use the WPS function, press it for about 2 seconds. To use the Reset function, press and hold for more than 5 seconds.
 - **Used as the WPS button:**

If your wireless router supports WPS (Wi-Fi Protected Setup), you can connect the camera to your Wi-Fi network using WPS. Press the **WPS** or **QSS** button on your

router. Within 2 minutes, press the **WPS/Reset** button on the camera for about 2 seconds, then the LED above this button will start flashing quickly. When this LED becomes solid on, the WPS is successful.

- **Used as the Reset button:**

With the camera powered on, press and hold the **WPS/Reset** button (for more than 5 seconds) until the System LED turns off. Then release the button and wait the camera to reset to its factory default settings.

➤ **WPS LED:**

Status	Indication
Flashing Green	The camera starts booting up.
	The camera is connecting to a network by WPS function.
Off	The camera has boot up.
	The camera failed to be added to a network by WPS function.
Solid Green	The camera has been successfully added to a network by WPS function. This process will last in the first two minutes.

Chapter 3 Set Up Your Camera

3.1 Set up the Camera with the tpCamera App

Step 1. Connect the camera to the network your smartphone is on.

- 1) Power on the camera using the provided power adapter as shown.
- 2) Connect a smartphone to the router as shown.
- 3) Connect the camera to the router via wired or wireless connection, and then wait till the camera's system LED become solid green.

Wired: Connect the camera to the router's LAN port via an Ethernet cable or the provided passive PoE injector.

- Via an Ethernet cable

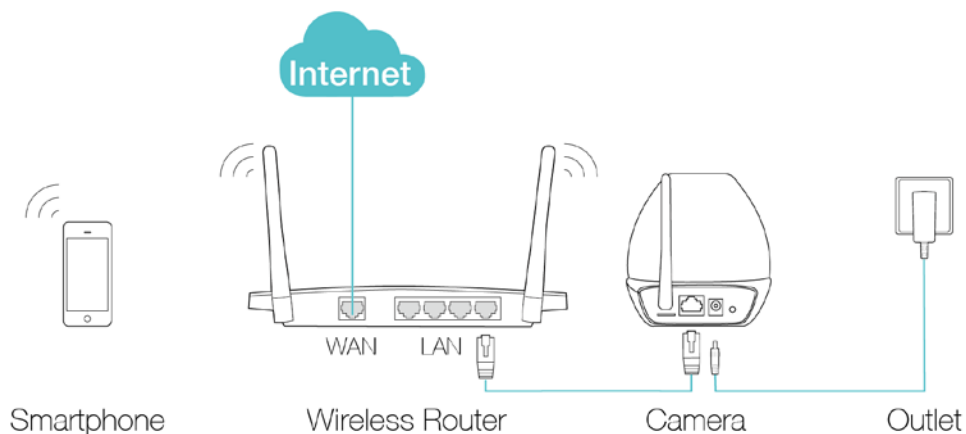

- Via the provided passive PoE injector

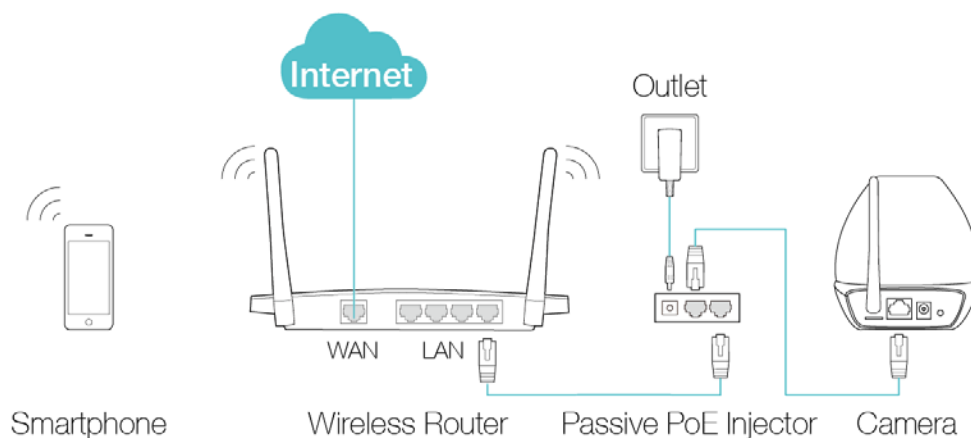

Wireless:

➤ Via web management page

You can set the wireless connection using the basic settings on the web management page. (Refer to [4.3.3 Basic > Wireless Connection](#)).

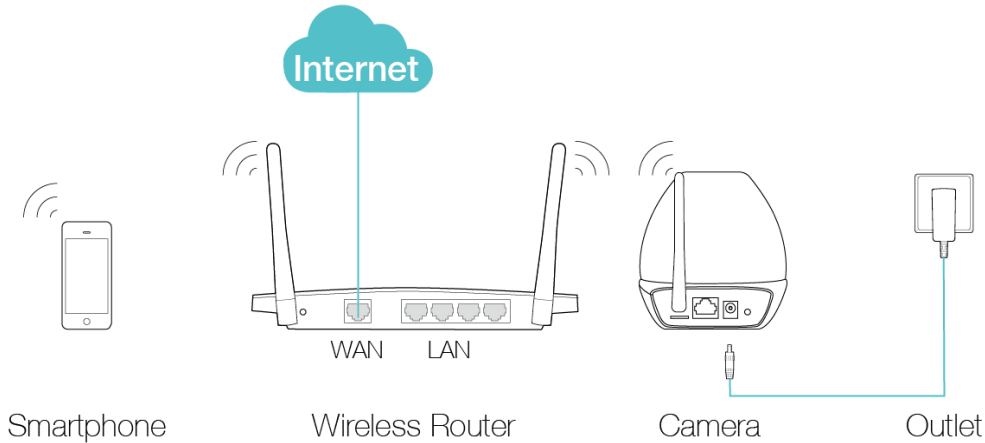

➤ Via WPS/QSS button

If your wireless router supports WPS, you can connect the camera to your Wi-Fi network using WPS. Press the **WPS** or **QSS** button on your router. Within 2 minutes, press the **WPS/Reset** button on the back of the camera for about 2 seconds, then the LED above this button will start flashing quickly. When this LED becomes solid on, the WPS is successful and the camera is connected to the router wirelessly.

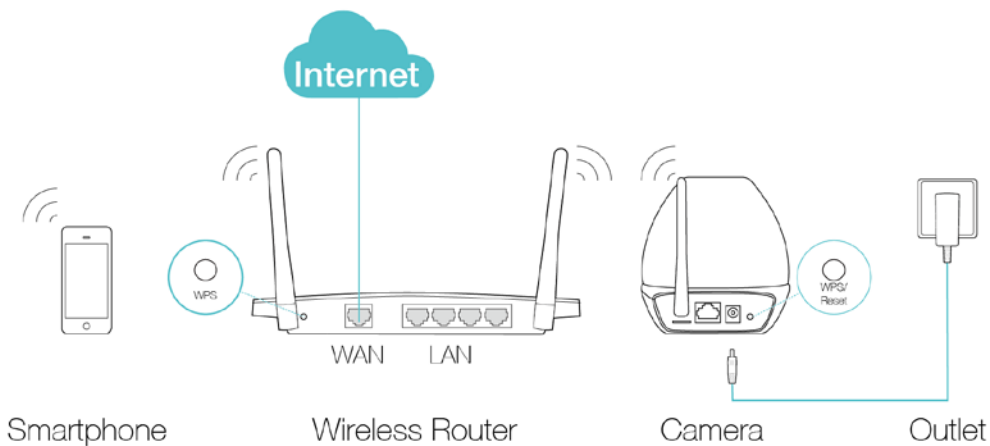

Step 2. Download and install the tpCamera app.

You can download the free **tpCamera** app from the App Store or Google play. You can also scan the QR code below to download the tpCamera app.



Step 3. Add the camera to your TP-Link ID.

Launch the [tpCamera](#) app, log in with your TP-Link ID or create one if you do not have a TP-Link ID. Then follow the app instructions to add your new camera to your TP-Link ID.

When you reach the [My Cam](#) screen, you have successfully added your camera and can start to use your camera.

Note:

You can enable Email and App notification in the app, which will inform you immediately of any detected movement or sound by sending the snapshots. The time interval between each Email notification alert is 10 minutes while the time interval for App notification is 3 minutes.

3.2 Position Your Camera

Before positioning your camera, please keep these safety guidelines in mind:

- Keep your camera out of reach of children and pets.
- Use your camera only indoors, and keep it out of direct sunlight. Make sure its operating temperature is in the range of 0-40°C (32-104°F).
- Pick a location which is close enough to a wall outlet.
- Use only the power adapter that comes with this camera in the package.

You can place your camera to your desired location. Just unplug and replug it without having to go through the app's setup again. Place the camera within the coverage of your wireless network. You can place the camera in various ways:

- Place it on a flat surface.
- Mount it on the wall or ceiling with the provided screws and base.

Detailed instructions on mounting your camera to a wall or ceiling are shown as follows.

Wall Mounting

Get the provided accessories for camera's wall mounting ready, and follow the instructions below to mount the camera. After relocating your camera, remember to power on it.

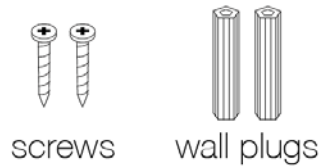

- A) Place the paper drill guide where you want the camera. Check the alignment using a level.
- B) Using a 0.24 inch (6mm) drill bit, drill holes through the two circles on the guide. Remove the paper.
- C) Insert the two anchors into the holes and place the camera mount over the anchor.
- D) Attach the camera and use the screws to secure it.

1 Drill Holes

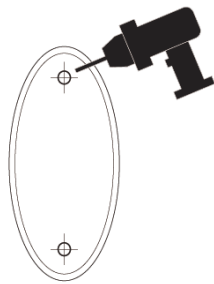

2 Mount Base

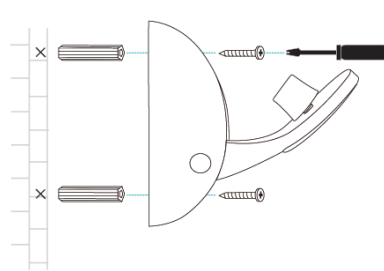

3 Secure Camera

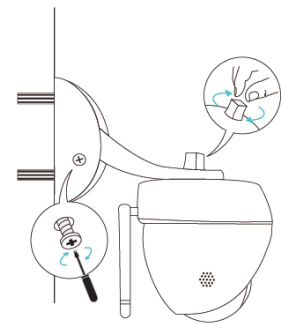

Ceiling Mounting

Get the provided accessories for camera's wall mounting ready, and follow the instructions below to mount the camera. After relocating your camera, remember to power on it.

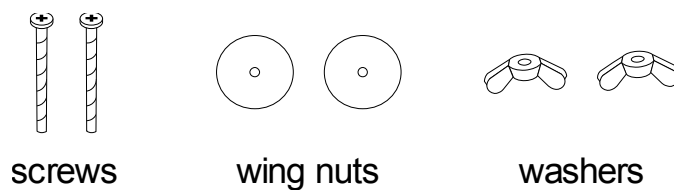

- A) Place the paper drill guide where you want the camera*.
- *Camera placement can affect viewing angle. For best results, place the camera near a wall or corner.
- B) Using a 0.24 inch (6mm) drill bit, drill holes through the two circles on the guide. Remove the paper.
- C) Attach the camera mount using the screws, washers, and wingnuts.
- D) Attach the camera and use the screws to secure it.

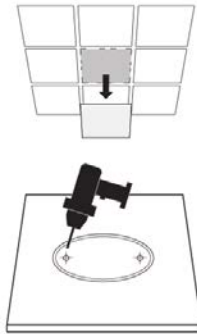
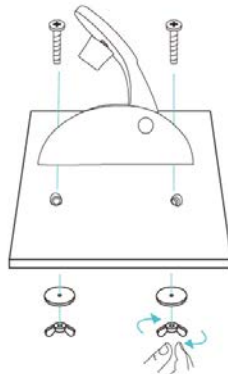
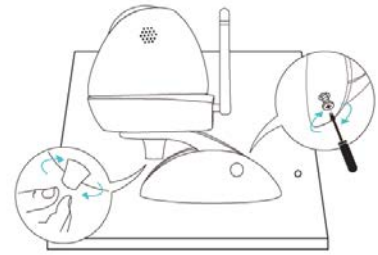
1 Drill Holes**2** Mount Base**3** Secure Camera

When you finish positioning your camera, use the tpCamera app to check that your camera can see what you want to keep an eye on. Adjust its position if needed.

Chapter 4 Configure Your Camera

This chapter shows how to use the camera's web management page to configure the camera locally. In addition to the web management page, you can use the tpCamera app and TP-Link Cloud (<http://www.tplinkcloud.com>) to view and manage your camera remotely.

4.1 Log in to Your Camera

1. Connect a computer to the router that your camera is connected to. You can connect the computer to the router using an Ethernet cable or via the wireless connection.
2. Find the management IP address of the camera from the web management page of the connected router. Here we use the web management page of TP-Link router for demonstration.

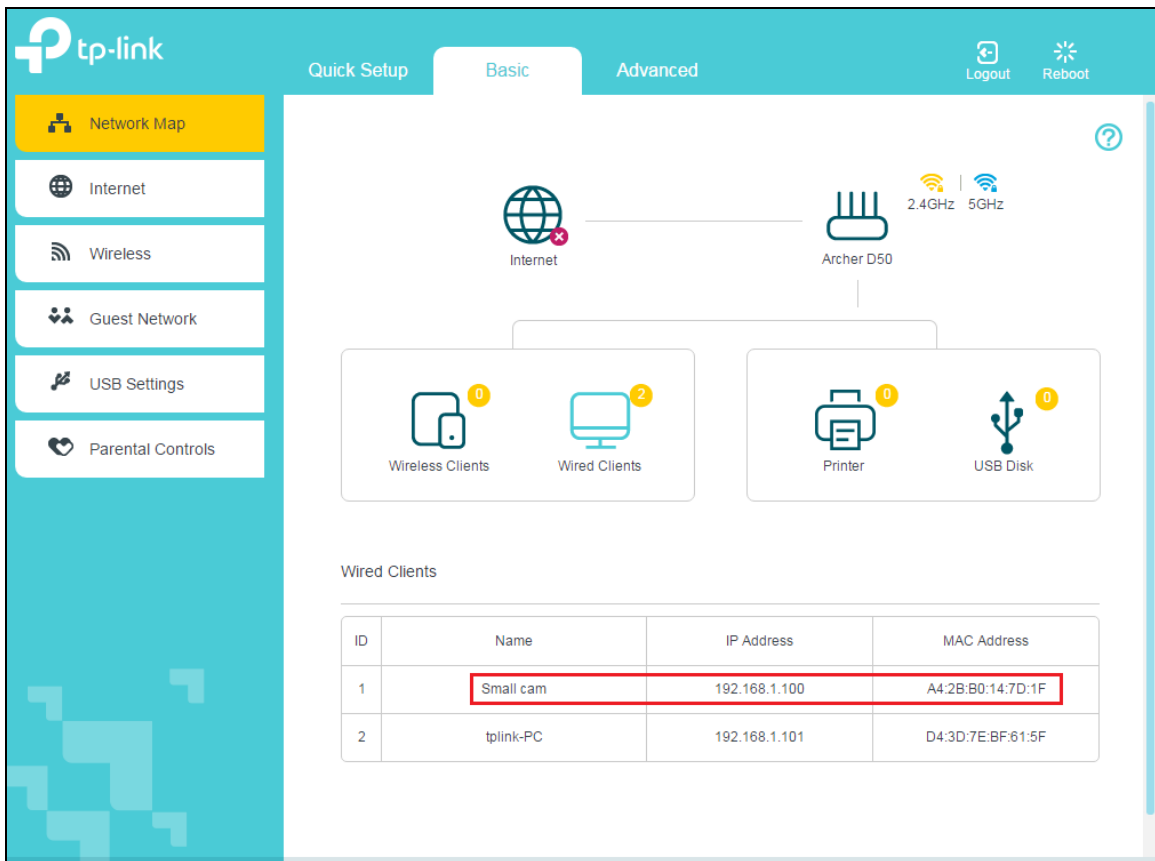

The screenshot shows the TP-Link web management interface for an Archer D50 router. The 'Basic' tab is selected, and the 'Wired Clients' section is expanded. A table lists the connected wired clients, with the 'Small cam' entry highlighted in red.

ID	Name	IP Address	MAC Address
1	Small cam	192.168.1.100	A4:2B:B0:14:7D:1F
2	tplink-PC	192.168.1.101	D4:3D:7E:BF:61:5F

3. On a computer that connects to the same router as the camera does, open a web browser, type in the camera's IP address in the address field, and press **Enter**. Here we use `http://192.168.1.100` for demonstration.

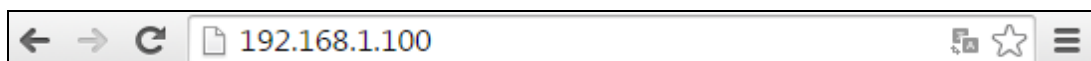

4. Enter the default username and password ([admin/admin](#)). Click [Login](#).

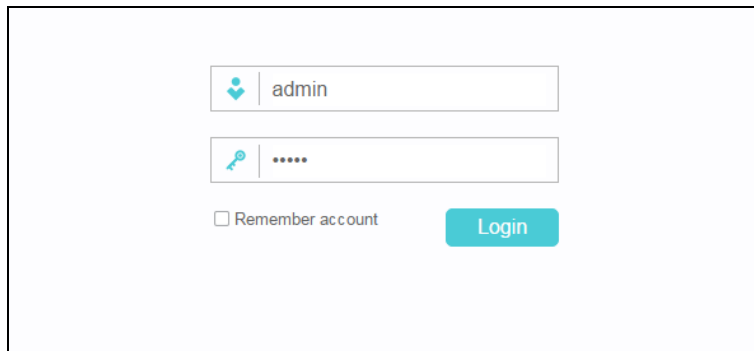

The image shows a login form with two input fields. The first field contains the text 'admin' and has a user icon to its left. The second field contains six dots and has a key icon to its left. Below the fields is a checkbox labeled 'Remember account' and a teal 'Login' button.

5. Create a new password for your camera to enhance security. Click [OK](#).

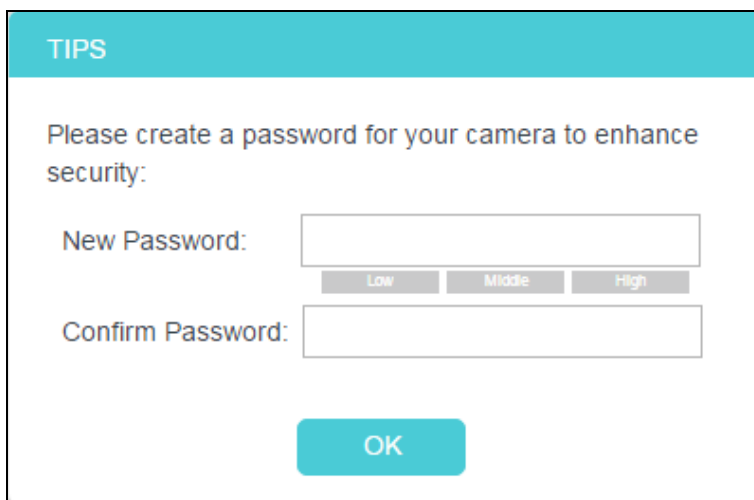

The image shows a screen with a teal header labeled 'TIPS'. Below the header, the text reads 'Please create a password for your camera to enhance security:'. There are two input fields: 'New Password:' and 'Confirm Password:'. Between the two fields are three buttons labeled 'Low', 'Middle', and 'High'. A teal 'OK' button is at the bottom.

 **Note:**

For the administrator, the default password is [admin](#). For subsequent logins, use your password you have created.



If you log in to the camera as an administrator, you can perform all the settings provided by the camera.



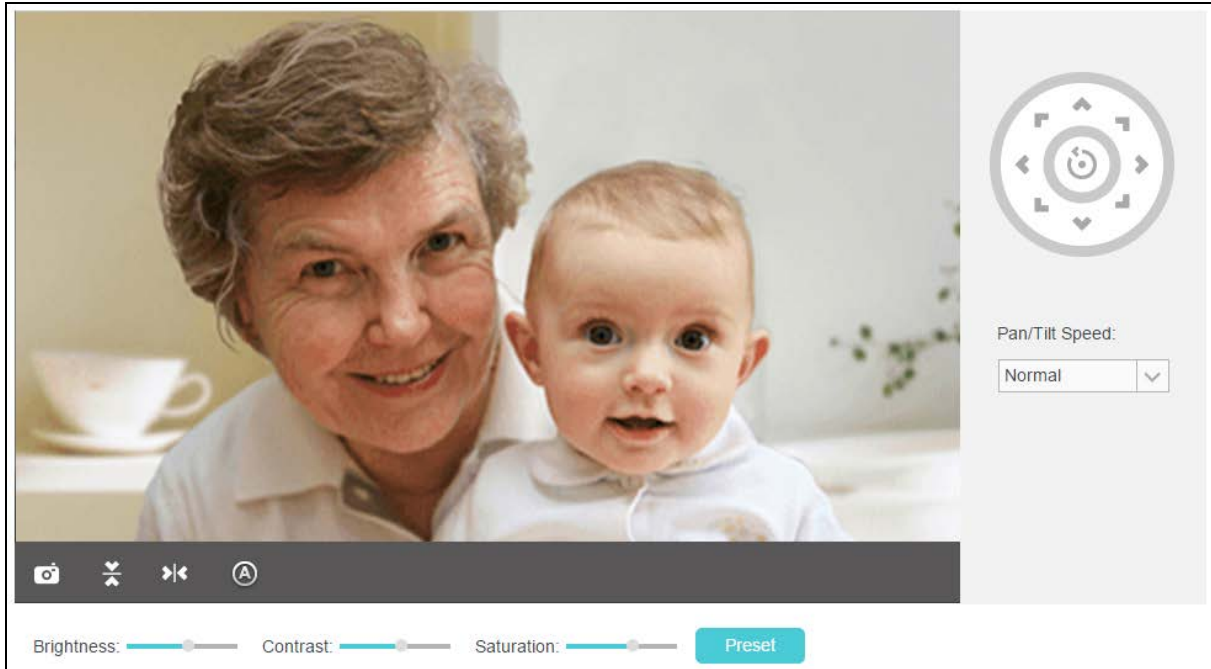

If you log in to the camera as a common user, you can only view the Live View. After logging as administrator, you can add up to five user accounts in the Account menu (Go to [System > Account](#)).

4.2 Live View

The Live View screen shows you the live video feed from your camera. On this screen, you can capture a picture.



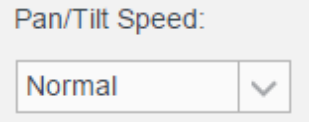

Symbols	Meaning	Note								
	Click to capture a still image shot by the camera.	The image file will be automatically saved to your computer.								
	Click to vertically flip the current image.	If the camera is installed upside down, Flip Image and Mirror should both be checked. <table border="0" style="margin-top: 10px;"> <tr> <td style="text-align: center; padding: 5px;">Normal</td> <td style="text-align: center; padding: 5px;">Mirror</td> </tr> <tr> <td style="text-align: center; padding: 5px;"><i>Image</i></td> <td style="text-align: center; padding: 5px;"><i>image</i></td> </tr> <tr> <td style="text-align: center; padding: 5px;">Flip</td> <td style="text-align: center; padding: 5px;">Mirror + Flip</td> </tr> <tr> <td style="text-align: center; padding: 5px;"><i>image</i></td> <td style="text-align: center; padding: 5px;"><i>Image</i></td> </tr> </table>	Normal	Mirror	<i>Image</i>	<i>image</i>	Flip	Mirror + Flip	<i>image</i>	<i>Image</i>
Normal	Mirror									
<i>Image</i>	<i>image</i>									
Flip	Mirror + Flip									
<i>image</i>	<i>Image</i>									
	Click to horizontally flip the current image.									

	<p>Click to select the Auto/Day/Night mode.</p>	<p> Auto: This mode will automatically switch between Day and Night modes based on the amount of available lighting.</p> <p> Day: This sets the camera to always be in the Day mode.</p> <p> Night: This sets the camera to always be in the Night mode.</p>
	<p>Click to set the camera's position.</p>	<p>Click on the directional arrows on the pan/tilt wheel to manually control the pan and tilt functions of the camera. At any time, you can click the Return button in the center of the wheel to return the camera to its initial position.</p>
	<p>Set the speed of the camera's movement for each press of a pan or tilt arrow on the pan/tilt wheel.</p>	<p>Select the pan/tilt speed from the drop-down list: Fast, Normal, Slow.</p>

 **Note:**

Use the camera's pan and tilt controls via the web management page or tpCamera app instead of rotating the camera forcibly, which may cause damage to the camera.

- **Brightness:** Drag the **Brightness:**  slider to adjust the brightness level of camera. Large value will brighten the current displayed screen.
- **Contrast:** Drag the **Contrast:**  slider to adjust the contrast level of the camera. Large value will contrast the current displayed screen heavily.
- **Saturation:** Drag the **Saturation:**  slider to adjust the saturation level of the camera. Large value will saturate the current displayed screen to be more colorful.
- **Preset:** Click the [Preset](#) button to restore to factory image settings.

4.3 Basic

Click the [Basic](#) menu to display the submenus including [Status](#), [Network](#), [Wireless Connection](#), [Cloud Setting](#), and [LED](#).

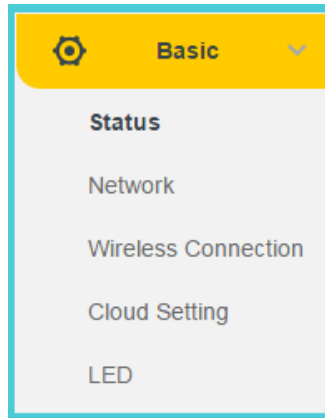

4.3.1 Basic > Status

The [Status](#) page displays the current configuration information of the camera. All the information is read-only.

Basic	
Camera Name:	NC450 2.0
Model:	NC450 2.0
Firmware:	1.2.0 Build 161123 Rel.05AB533A
Current Viewers:	0
Cloud Server	
Connection Status:	Not registered
Username:	-
Wireless	
Connection Status:	Disconnected
Wireless Network Name:	-
Channel:	-
Rate/Signal Strength:	-
Security:	-
Network	
Connection Type:	Dynamic IP
MAC Address:	A4-2B-B0-14-7D-1F
LAN IP Address:	192.168.1.100
Subnet Mask:	255.255.255.0
Default Gateway:	192.168.1.23
Primary DNS Server:	192.168.1.23
Secondary DNS Server:	0.0.0.0
Video Profile 1	
Resolution:	1280*720
Frame Rate:	15
Image Quality:	High
Light Frequency:	Auto

4.3.2 Basic > Network

On this page, you can configure your camera's IP address which is used to access and configure the camera.

- **Dynamic IP:** Select this option when a DHCP server is installed on the network to issue IP address assignment. With this setting, the IP address of the camera is assigned automatically.

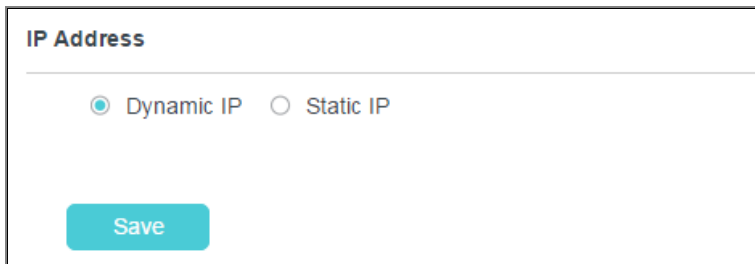

The screenshot shows the 'IP Address' configuration page. At the top, there are two radio buttons: 'Dynamic IP' (which is selected) and 'Static IP'. Below the radio buttons is a teal 'Save' button.

- **Static IP:** Select this option when a static or fixed IP address is obtained for the camera. A static IP address will ease your access to the camera in the future. Add your camera's static IP information to your router to avoid IP conflicts.

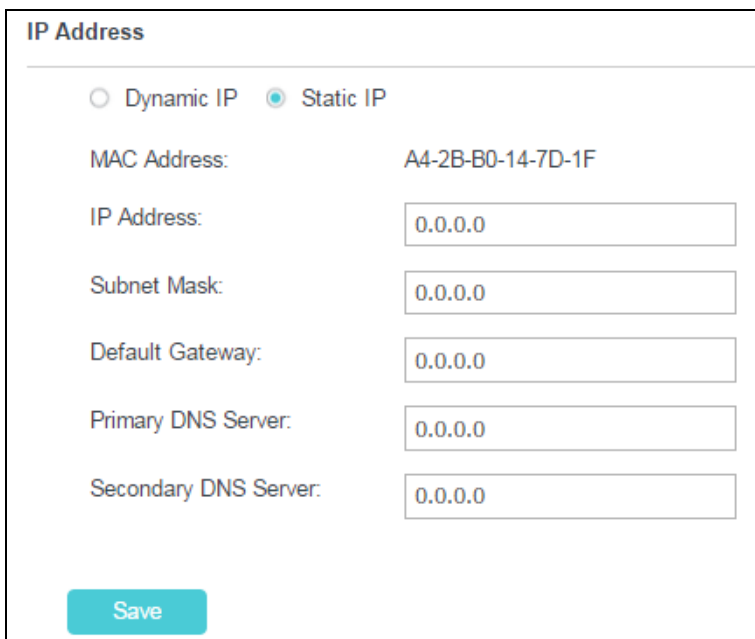

The screenshot shows the 'IP Address' configuration page with 'Static IP' selected. The 'MAC Address' is displayed as 'A4-2B-B0-14-7D-1F'. Below it are input fields for 'IP Address', 'Subnet Mask', 'Default Gateway', 'Primary DNS Server', and 'Secondary DNS Server', all containing the value '0.0.0.0'. A teal 'Save' button is at the bottom.

- **MAC Address:** Displays the Ethernet MAC address of the camera. The MAC address is read-only.
- **IP Address:** Enter a fixed IP address for the camera in dotted-decimal notation.
- **Subnet Mask:** Enter the subnet mask in dotted-decimal notation. The default value is "0.0.0.0."
- **Default Gateway:** Enter the default gateway in dotted-decimal notation.

- **Primary DNS Server:** Enter a DNS address in dotted-decimal notation.
- **Secondary DNS Server:** Enter a DNS address in dotted-decimal notation.

Click [Save](#) to save and enable the settings.

4.3.3 Basic > Wireless Connection

The camera's wireless function is enabled by default. This function helps to connect your camera to a wireless network wirelessly. If you don't want to use this function, just select the Disable option.

Wireless Connection

Enable Disable

Wireless Network List: [Scan](#)

Wireless Network Name	Signal	Security	MAC Address
No wireless network found, please click the Scan button to refresh the list.			

Wireless Network Name: TP-LINK_859F [Manually](#)

Password: show password

[Connect](#)

- **Scan:** Click to scan the available wireless network. You will get or refresh the Wireless Network List as shown below.

Wireless Connection

Enable Disable

Wireless Network List: Scan

Wireless Network Name	Signal	Security	MAC Address
TP-LINK_7B00	📶	WPA/WPA2-PSK	BC-5F-F6-12-0E-BD
TP-LINK_859F	📶	WPA/WPA2-PSK	50-C7-BF-03-85-9F
TP-LINK_C540	📶	WPA2-PSK	E8-FC-AF-FD-59-BC
TP-LINK_6H8U	📶	WPA2-PSK	E8-FC-AF-F4-37-CF

Wireless Network Name: TP-LINK_859F Manually

Password: show password

Connect

- **Wireless Network Name:** Displays the wireless network's name. Make sure the camera and your PC connect to the same wireless network; otherwise your PC can't access the camera.
- **Signal:** Displays the strength of the wireless signal.
- **Security:** Displays the wireless network's security mode.
- **MAC Address:** Displays the MAC address of the router.

To connect your camera to a wireless network, follow the steps below:

1. Click [Scan](#) to get and refresh the Wireless Network List.
2. Select a wireless network from the wireless network list.
3. If the wireless network's security mode is [None](#), simply click [Connect](#). If the security mode requires a password, enter the wireless network's password and then click [Connect](#). You can select [show password](#) to display what you've entered.

4. A pop-up screen will prompt you for the wireless network modification. Click [Change](#), and then click [OK](#) on the next pop-up screen. The camera will connect to the wireless network that you have selected.

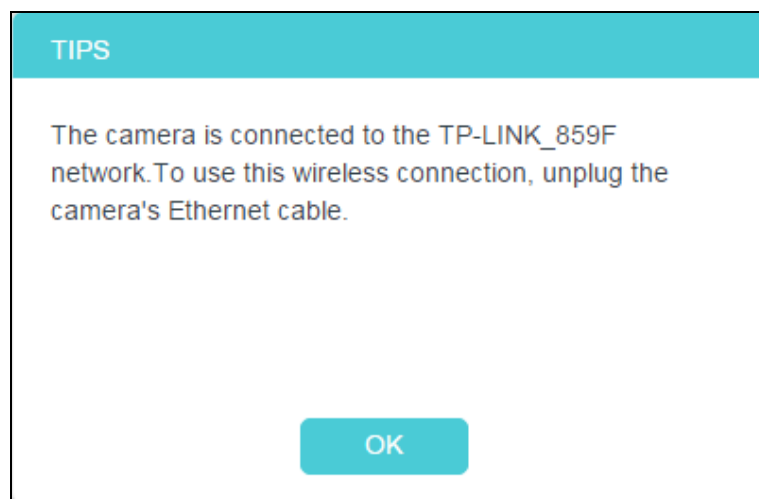
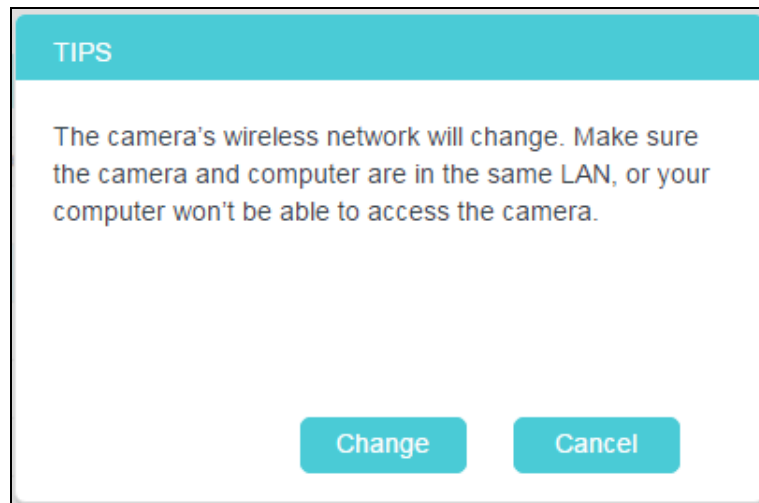

5. To log in to the web management page of the camera, you need to connect your computer to the router that your camera is connected to. Refer to [4.1 Log in to Your Camera](#) to find the IP address of your camera and log in to the camera again.

4.3.4 Basic > Cloud Setting

A Cloud Camera can be viewed anytime and anywhere over the internet with TP-Link Cloud service. On this page, you can add the camera to your TP-Link ID.

 **Note:**

1. You can register a TP-Link ID in the tpCamera app only. If you do not get the tpCamera app, please refer to the [Step 2 Download and install the tpCamera app](#) in [3.1 Set up the Camera with the tpCamera App](#) to register a TP-Link ID.

- To add a camera to your TP-Link ID, make sure that the camera is connected to the internet.

Add Your Camera to TP-Link ID

If you already have a TP-Link ID, to add your camera to your account, just enter the TP-Link ID and password, and then click [Register](#).

Cloud Setting

Add your camera to Cloud account

Please enter your Cloud account and password:

Account:

Password:

Camera Name:

With Cloud service, you can view your cloud cameras anytime and anywhere over the Internet. Go to www.tplinkcloud.com.

[Register](#)

- **Account:** Enter your TP-Link ID. Either E-mail address or username is allowed.
- **Password:** Enter your TP-Link ID's password.
- **Camera Name:** The default value is the camera model. You can change it to an easy-to-remember one. Camera name can contain up to 31 characters. It cannot contain the following characters: \ / : = & ' " < > { }.

After your camera is registered successfully, you can go to <http://www.tplinkcloud.com> to view it.

4.3.5 Basic > LED

The camera's LED is on by default. If you want to turn it off, select [Off](#) and click [Save](#).

LED

LED: On Off

[Save](#)

4.4 Advanced

Click the [Advanced](#) menu to display the submenus including [Status](#), [Network](#), [Wireless Connection](#), [Cloud Setting](#), [Video](#), [Sound Detection](#), [Motion Detection](#), [SD Card](#), [Notification Delivery](#) and [LED](#).

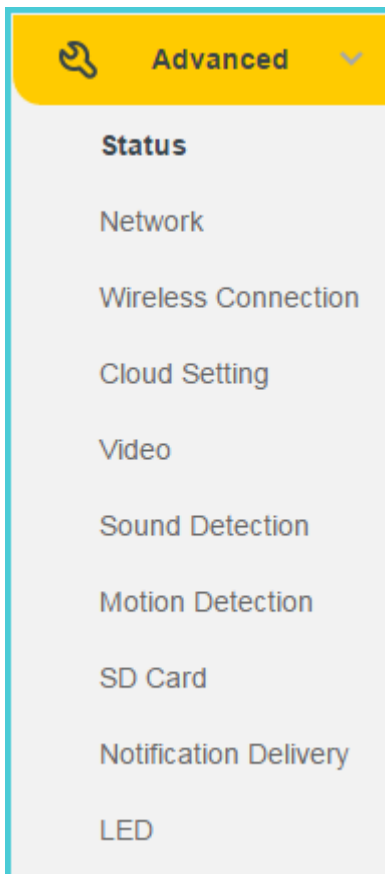

4.4.1 Advanced > Status

Refer to [4.3.1 Basic > Status](#).

4.4.2 Advanced > Network

On this page, you can configure the network settings of the camera.

IP Address

Dynamic IP Static IP

Fallback IP:

HTTP

HTTP Port:

Bonjour:

Bonjour: Enable Disable

Bonjour Name: NC450 2.0-147d1f

Save

IP Address

On this section, you can configure your camera's IP address which is used to access and configure the camera.

- **Dynamic IP:** Select this option when a DHCP server is installed on the network to issue IP address assignment. With this setting, the IP address of the camera is assigned automatically.

IP Address

Dynamic IP Static IP

Fallback IP:

- **Fallback IP:** If the camera cannot get a dynamic IP address from a DHCP server within limited tries, the camera will assign a default IP address, 192.168.0.10, by itself as the Fallback IP address.
- **Static IP:** Select this option when a static or fixed IP address is obtained for the camera. A static IP address will ease your access to the camera in the future. Add your camera's static IP information to your router to avoid IP conflicts.

IP Address

Dynamic IP Static IP

MAC Address: A4-2B-B0-14-7D-1F

IP Address:

Subnet Mask:

Default Gateway:

Primary DNS Server:

Secondary DNS Server:

- **MAC Address:** Displays the Ethernet MAC address of the camera. The MAC address is read-only.
- **IP Address:** Enter a fixed IP address for the camera in dotted-decimal notation.
- **Subnet Mask:** Enter the subnet mask in dotted-decimal notation. The default value is "0.0.0.0".
- **Default Gateway:** Enter the default gateway in dotted-decimal notation.
- **Primary DNS Server:** Enter a DNS address in dotted-decimal notation.
- **Secondary DNS Server:** Enter a DNS address in dotted-decimal notation.
- **Fallback IP:** If the camera cannot get a valid static IP address, the camera will assign a default IP address, 192.168.0.10, by itself as the Fallback IP address.

HTTP (Hypertext Transfer Protocol)

This feature allows you to access and manage your camera via its IP address. Web browser access normally uses the standard HTTP service port 80. The camera uses HTTP port 80 by default. For greater security, you can change the port to a custom one.

When HTTP port is set to 80, you can access the camera by typing its IP address (for example, <http://192.168.1.100>) on a web browser. When HTTP port is set to another value (for example, 2000), you need to enter <http://192.168.1.100:2000> instead.

HTTP	
HTTP Port:	<input type="text" value="80"/>

- **HTTP Port:** The default value is 80. If you want to use a port number other than 80, enter a port number between 1 and 65535.

Bonjour

Bonjour, also known as zero-configuration networking, enables automatic discovery of computers, devices, and services on IP networks. Bonjour uses industry standard IP protocols to allow devices to automatically discover each other without the need to enter IP addresses or configure DNS servers.

Bonjour:	
Bonjour:	<input checked="" type="radio"/> Enable <input type="radio"/> Disable
Bonjour Name:	NC450 2.0-147d1f
<input type="button" value="Save"/>	

- **Bonjour:** To enable or disable the Bonjour service.
- **Bonjour Name:** Displays the Bonjour name. By default, it is a combination of device name and the last six characters of the camera's MAC address.





Click [Save](#) to save and enable the settings.

4.4.3 Advanced > Wireless Connection

Wireless Connection

Enable
 Disable

Wireless Network List:
[Scan](#)

Wireless Network Name	Signal	Security	MAC Address
TP-LINK_7B00		WPA/WPA2-PSK	BC-5F-F6-12-0E-BD
TP-LINK_859F		WPA/WPA2-PSK	50-C7-BF-03-85-9F
TP-LINK_C540		WPA2-PSK	E8-FC-AF-FD-59-BC
TP-LINK_6H8U		WPA2-PSK	E8-FC-AF-F4-37-CF

Wireless Network Name:
[Manually](#)

Password:
 show password

[Connect](#)

You can set the wireless connection manually besides the basic settings for wireless connection (Refer to [4.3.3 Basic > Wireless Connection](#)).

For example, a hidden wireless network does not broadcast its SSID, and you cannot find it from the Wireless Network List. If you want to connect the camera to a hidden wireless network, you need to make it manually. Click the [Manually](#) button. Then enter the wireless network name, select the security type and encryption type of the wireless network, enter the password if needed, and click [Connect](#).

Wireless Connection

Enable Disable

Wireless Network List: Scan

Wireless Network Name	Signal	Security	MAC Address
TP-LINK_7B00		WPA/WPA2-PSK	BC-5F-F6-12-0E-BD
TP-LINK_859F		WPA/WPA2-PSK	50-C7-BF-03-85-9F
TP-LINK_C540		WPA2-PSK	E8-FC-AF-FD-59-BC
TP-LINK_6H8U		WPA2-PSK	E8-FC-AF-F4-37-CF

Wireless Network Name: Auto

Security: ▼

Encryption: ▼

Password: show password

Connect

4.4.4 Advanced > Cloud Setting

Refer to [4.3.4 Basic > Cloud Setting](#).

4.4.5 Advanced > Video

On this page, you can configure the video settings for your camera.

Video

Video Profile 1:

Coding Format	Resolution	Frame Rate	Mode	Image Quality
H.264	1280*720	15FPS <input type="button" value="v"/>	VBR	High <input type="button" value="v"/>

Backlight Compensation: Enable Disable

Light Frequency:

Time Stamp&On-Screen Display (OSD): Enable Disable

- **Coding Format:** Displays the video coding format of the camera.
- **Resolution:** Displays the video resolution of the camera. Higher resolution offers better quality, but will require more bandwidth to stream.
- **Frame Rate:** Select the frame rate to use for the video stream from the drop-down list. Higher settings offer smoother video streams, but will require more bandwidth.
- **Mode:** Displays the bit rate mode of the camera. This camera uses the VBR (variable bit rate) mode. In this mode, the bit rate varies to keep consistent video quality. It allows a higher bit rate (and therefore requires more bandwidth) to be allocated to dynamic scenes while less bit rate to be allocated to static scenes.
- **Image Quality:** Select the image quality from the drop-down list: High and Low. High settings offer better quality, but it may require more bandwidth to stream.
- **Backlight Compensation:** If enabled, this feature will compensate for bright backgrounds so foreground objects aren't silhouetted.

Enabled

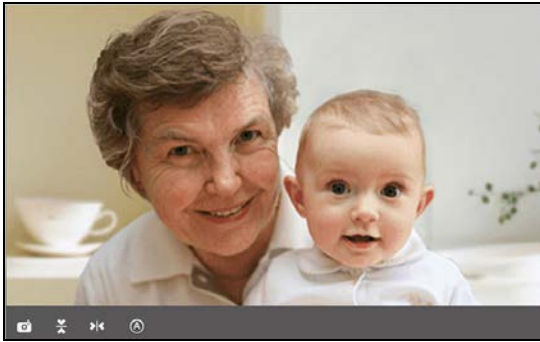

Disabled



- **Light Frequency:** Select the frequency used by your lighting and power to help reduce image flicker. The default setting is Auto, which is recommended.
- **Time Stamp&On-Screen Display (OSD):** If enabled, the current time of your camera, which can be set on the [System > Date/Time](#) page, will be displayed on the [Live View](#) screen. Meanwhile, you can set the OSD text to be displayed with the time stamp. We use [NC450](#) as the OSD text for demonstration here.

Time Stamp&On-Screen Enable Disable

Display (OSD):

OSD Text:

[Save](#)

Enabled

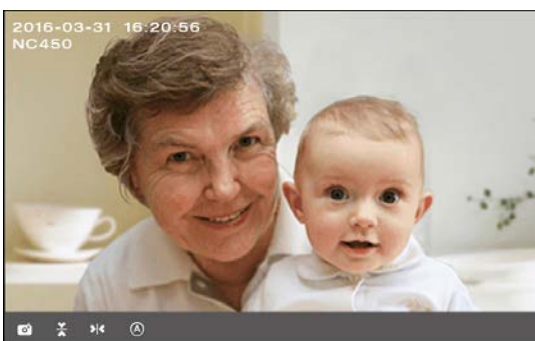

Disabled

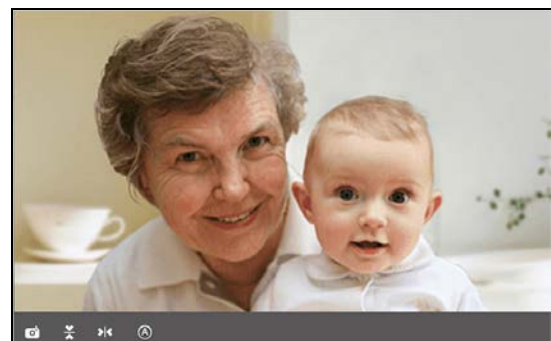

Click [Save](#) to save and enable the settings.

4.4.6 Advanced > Sound Detection

Sound detection allows your camera to detect a loud sound, which can be used to trigger snapshots. Refer to [4.4.9 Advanced > Notification Delivery](#) for more details.

Sound Detection

Sound Detection: Enable Disable

Sensitivity: Medium ▼

Threshold: Quiet home ▼

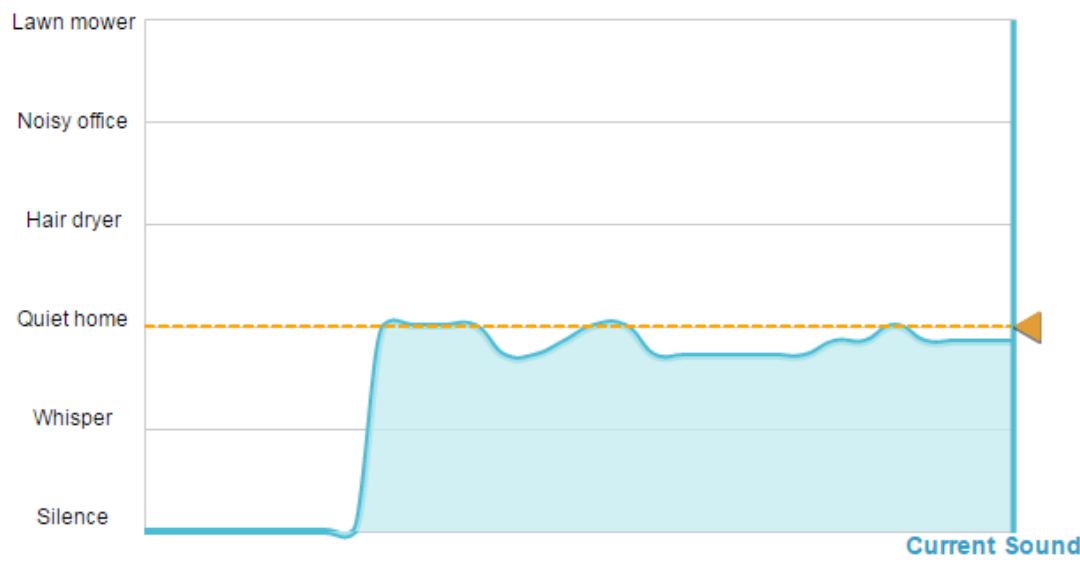

Tips: You can also drag the arrow to set the threshold for sound detection

Current Sound

Save

- **Sound Detection:** To enable or disable the sound detection function.
- **Sensitivity:** Specify the level of difference between current sound and the threshold you set. Select one of the three levels of sensitivity from the drop-down list: High, Medium, and Low.
- **Threshold:** Select the threshold of sound level. You can also drag the arrow in the diagram to set the threshold. Snapshots will be triggered and sent to FTP server when current sound exceeds the threshold. And notification messages will be sent to the tpCamera app in your smartphone.

Click [Save](#) to save and enable the settings.

4.4.7 Advanced > Motion Detection

Motion detection allows you to specify areas and sensitivity of your camera's video to monitor for motion, which can be used to trigger snapshots. Refer to [4.4.9 Advanced > Notification Delivery](#) for more details.

Motion Detection

Motion Detection: Enable Disable

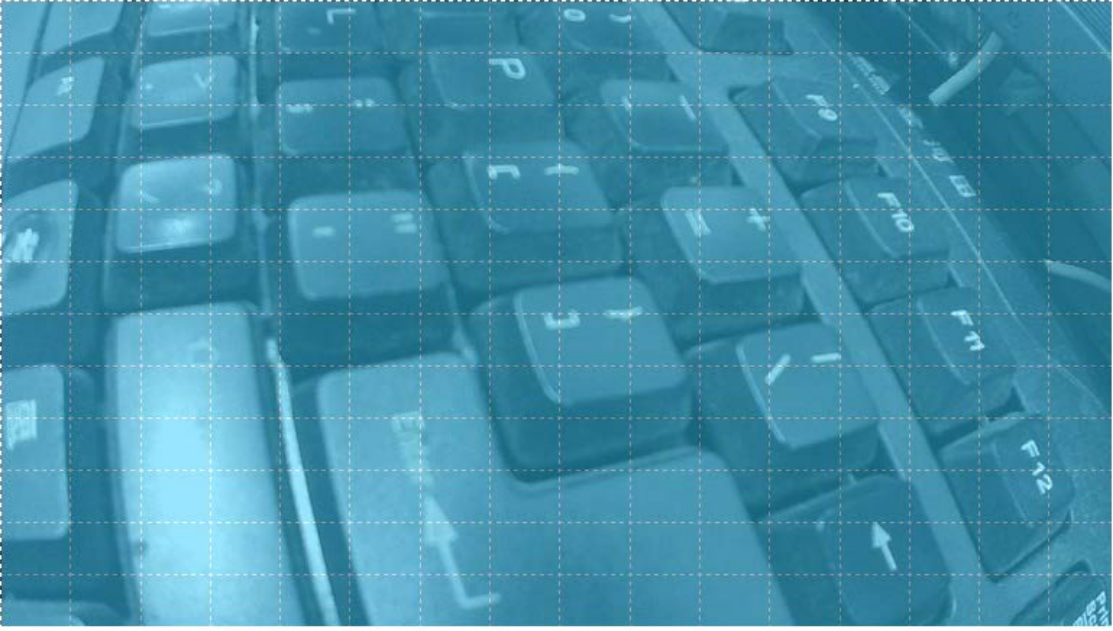

Sensitivity: Medium ▼

[Save](#)

- **Motion Detection:** To enable or disable the motion detection function. The area with blue mask indicates that it is the area with motion detection on. All areas are selected by default. You can drag your mouse to draw specific areas that you want to monitor.
- **Sensitivity:** Select one of the three levels of sensitivity from the drop-down list: High, Medium, and Low. Snapshots will be triggered and sent to FTP when the motion meets the level of sensitivity. And notification messages will be sent to the tpCamera app in your smartphone.

Click [Save](#) to save and enable the settings.

4.4.8 Advanced > SD Card

SD Card function allows you to save snapshots and videos in your SD card. The SD card is not provided, and you need to insert a micro SD card into the SD card slot on the back of the camera.

SD Card

Please Insert SD Card

After inserting a micro SD card, go to [Advanced > Sound Detection](#) or [Advanced > Motion Detection](#) to set the detections according to your needs. Then when an event occurs, the corresponding snapshot and video will be saved in the micro SD card automatically.

 **Note:**

If the micro SD card capacity is insufficient, it will overwrite the oldest data.

SD Card

Path: / Back

Type	Name	Size	Total Items	Date
	20160925		9	2016/09/25 00:08:37

Total: 941.68MB Used: 13.20MB Free: 928.48MB

- **Back:** Click to go back to the previous path of the folder.
- **Type:** Displays the type of the file or folder, such as the photo, video, and file.
- **Name:** Displays the name of the file or folder.
- **Size:** Displays the size of the file.
- **Total Items:** Displays the number of the files in the folder.
- **Date:** Displays the recording time of the file or folder.

The micro SD card capacity is displayed at the bottom of the table.

 **Note:**

The Wi-Fi camera supports 24-hour recording. If you enable the 24-hour Recording function, remember to save your previous recordings in your SD card to avoid them being overwritten. If the 24-hour Recording function is disabled, the SD card recording triggered by motion detection or sound detection will last from 15s to 60s (depending on how long the motion or sound lasts). If the event continues beyond 60s, the camera will start a new recording.

4.4.9 Advanced > Notification Delivery

Notification Delivery settings are available only after the motion detection or sound detection function is enabled. It is used to inform you immediately by sending the snapshots triggered by a detected motion or sound to the specified FTP server.

The screenshot shows the 'Notification Delivery' settings interface. At the top, the title 'Notification Delivery' is displayed. Below it, there is a 'Target:' label followed by an unchecked checkbox and the text 'FTP'. At the bottom of the screen, there is a teal 'Save' button.

Select **FTP**, and you can configure your camera to send snapshots to a specified FTP server on the following screen:

The screenshot shows the 'Notification Delivery' settings interface with the 'FTP' target selected. The 'Target:' label is followed by a checked checkbox and the text 'FTP'. Below this, there are several configuration fields: 'FTP Server/Port:' with an input field and a separate box containing '21'; 'Username:' with an input field; 'Password:' with an input field; 'Path:' with an input field containing '/'; and 'Passive Mode:' with an unchecked checkbox. At the bottom, there are two teal buttons: 'Test' and 'Save'.

- **FTP Server/Port:** Enter the IP or the domain (IP/domain without prefix ftp://) and the port of the FTP server that you will be connecting to. The port is 21 by default.

 **Note:**

The FTP server you set and the camera should be in the same LAN.

- **Username:** Enter the username that is used to log in to your FTP server.
- **Password:** Enter the password that is used to log in to your FTP server.
- **Path:** Enter the path to the destination on the FTP server.

- **Passive Mode:** Enabling passive mode may help you reach your FTP server if your camera is behind a router protected by a firewall.

To set up a FTP to receive notification, follow the steps below:

Notification Delivery

Target: FTP

FTP Server/Port: :

Username:

Password:

Path:

Passive Mode:

1. Enter an IP address or domain of your FTP server, e.g. 192.168.1.168
2. Remain the FTP port number as the default value: 21.
3. Enter your username to log in to the FTP server, e.g. test.
4. Enter your password to log in to the FTP server.
5. Enter the path to the destination on the FTP server, e.g. /test
6. Enable **Passive Mode**.
7. Click **Save** to save and enable the settings.

Click **Test**, and a test JPEG snapshot will be sent to the specified FTP server to check whether your settings are correct.

If the settings are tested correct, click **OK**.

If the settings are tested incorrect, check your network and FTP settings and try again later.

4.4.10 Advanced > LED

Refer to [4.3.5 Basic > LED](#).

4.5 System

Click the [System](#) menu to display the submenus including [Account](#), [Date/Time](#), [Management](#), and [System Log](#).

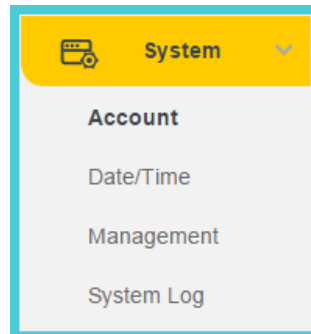

4.5.1 Account

On this page, you can change the administrator's password and manage the user account(s) that are allowed to access to your camera.



- **User Name:** Displays the name of the user account.
- **User Group:** Displays the group that the user account is in. Different user group has different limits of authority.
 - **admin:** This group has all authority of configuration. It can only have one account: admin.
 - **user:** This group can only view the Live View. It can have up to five accounts.

Add a New User Account

You can create a new user account to provide viewing access for your camera's video. User accounts will only be able to access the Live View section of the web management page, but cannot access any other parts or change any settings.

To add a new user account, follow the steps below:

1. Click [Add](#), and you will see the following screen.

The screenshot shows a web interface titled "Account". At the top, there is a table with two columns: "User Name" and "User Group". Both columns contain the text "admin". Below the table are three buttons: "Add", "Change Password", and "Delete". Underneath these buttons is a section titled "Add a New User Account". This section contains three input fields: "Username:" with the value "test", "Password:" with five dots, and "Confirm Password:" with five dots. At the bottom left of this section is a "Save" button.

2. Enter a username for your new account.
3. Enter a password for your new account. The password should contain 5 to 20 characters.
4. Enter the password again to confirm it.
5. Click [Save](#) to save and enable the settings.

Change Password

You can change the password of all the accounts here.

 **Note:**

The default account and password are both [admin](#). Everyone who knows the camera's IP address can access the device with all configuration authority. It is necessary to change the default password if the device is intended to be accessed only by administrator.

To change password, follow the steps below:

1. Select a user account in the list whose password you want to change
2. Click [Change Password](#), and you will see the following screen.

Account

User Name	User Group
admin	admin

[Add](#) [Change Password](#) [Delete](#)

Change Password

Current User: admin

Old Password:

New Password:

Confirm Password:

[Save](#)

3. Enter the current password in the Old Password textbox.
4. Enter a new password.
5. Enter the new password again to confirm it.
6. Click [Save](#) to save and enable the settings.

Delete a User Account

You can delete a user account except admin here. Click a user entry in the list and click [Delete](#).

4.5.2 Date/Time

On this page, you can configure the settings of the internal system clocks for your camera.

Date/Time

Time Configuration:

Current Time: 2016-09-27 04:12:42

Time Zone: (GMT) Greenwich Mean Time: Dublin, Edinburgh, Lisbon, London ▼

Automatic Time Configuration:

Synchronize With NTP Server

NTP Service

<<

▼

Set NTP Server from Dynamic IP

Set Date And Time Manually:

Set Date And Time Manually:

[Save](#)

- **Current Time:** Displays the current date and time of the camera.
- **Time Zone:** Select the time zone for the region where the camera is installed from the drop-down list.
- **Synchronize With NTP Server:** Select this option to specify the NTP server name to synchronize the date and time of the camera with those of the time server, known as the NTP (Network Time Protocol) server.
 - **NTP Service:** You can either enter a domain name of the NTP server or select one which will be filled in automatically from the drop-down list.
 - **Set NTP Server from Dynamic IP:** You can use the NTP server applied in the DHCP server on the network.
- **Set Date and Time Manually:** Select this option to set the date and time of the camera manually. If enabled, you will see the following screen:

Date/Time

Time Configuration:

Current Time: 2016-09-27 04:13:16

Time Zone: (GMT) Greenwich Mean Time: Dublin, Edinburgh, Lisbon, London ▼

Automatic Time Configuration:

Synchronize With NTP Server

Set Date And Time Manually:

Set Date And Time Manually:

year 2016 ▼ month 09 ▼ day 27 ▼

hour 04 ▼ minute 12 ▼ second 23 ▼

[Copy Your Computer's Time Settings](#)

[Save](#)

- [Copy Your Computer's Time Settings](#): Click this button to copy your computer's current time settings.

Click [Save](#) to save and enable the settings.

4.5.3 Management

On this page, you can reboot the camera, backup and restore the camera's current settings, reset factory settings, and update the camera's software.

Reboot

Reboot your camera: [Reboot](#)

Backup and Restore

Back up current settings: [Backup](#)

Restore settings from a backup file:

[Browse](#)
[Restore](#)

Restore factory default settings: [Reset](#)

Update

Upgrade from a file on your hard disk:

[Browse](#)
[Upgrade](#)

- **Reboot:** Click [Reboot](#) and then click [Reboot](#) on the pop-up screen to confirm. The reboot will not change the camera's setting. After rebooting, you need to log in to this page again.
- **Backup:** Click [Backup](#) and follow the instructions on the browser to save the setting data file to your specified location.
- **Browse:** Click [Browse](#) to locate the saved backup file.
- **Restore:** Click [Restore](#), and then the camera will start rebooting. The settings will be restored to the previous configuration.
- **Reset:** Click [Reset](#) to restore the camera to its factory defaults. Don't turn off the camera while resetting. After resetting, you need to add the camera to your TP-Link ID again, find out the IP address of your camera (refer to [4.1 Log in to Your Camera](#)), and then use the default username and password (admin/admin) to log in to this web management page.
- **Browse:** Click [Browse](#) to locate the saved upgrade file.
- **Upgrade:** Before update, download the latest firmware from the product page at <http://www.tp-link.com>, and then use decompression software to extract the file. Click [Browse](#) and select the downloaded firmware upgrade file. Then click [Upgrade](#) to update the camera's software to the latest version. Wait for the upgrading process to complete, and the camera will reboot automatically.

 Note:

The firmware upgrade procedure must not be interrupted, or the camera may be damaged. When upgrading firmware, do not unplug the camera or your computer, or close the web management page until the process is complete.

4.5.4 System Log

On this page, you can review any changes and events happened to your camera. The system starts logging automatically after startup.

System Log

Time	Module	Level	Content
2016-09-27/04:16:19	UserManage	NOTICE	Add User test success
2016-09-27/04:07:48	UserManage	NOTICE	Del User test success
2016-09-27/04:07:09	UserManage	NOTICE	Add User test success
2016-09-27/03:32:10	NetSwitch	NOTICE	Link status: wired
2016-09-27/03:29:14	NetSwitch	INFO	LAN gateway: 192.168.1.23
2016-09-27/03:29:14	NetSwitch	NOTICE	LAN IP: 192.168.1.101
2016-09-27/03:28:59	NetSwitch	INFO	LAN gateway: 192.168.31.1
2016-09-27/03:28:59	NetSwitch	NOTICE	Link status: wireless

level
module

- **Time:** Displays the time when the log event occurs. The log can get the correct time after you configure on the Date/Time page. (Go to [Advanced > Date/Time](#))
- **Module:** Displays the module to which the log information belongs. You can specify the module by selecting one from the Module drop-down list at the bottom.
- **Level:** Displays the severity level of the log information. You can specify the level by selecting one from the Level drop-down list at the bottom.
- **Content:** Displays the details of the log information.
- **Refresh:** Click [Refresh](#) to refresh the log information.
- **Save Log:** You may be asked to use this function when contacting our technical support for troubleshooting.
- **Clear:** Click [Clear](#) to clear all the log information.
- **Log Control:** You may be asked to use this function when contacting our technical support for troubleshooting.

COPYRIGHT & TRADEMARKS

Specifications are subject to change without notice. TP-Link is a registered trademark of TP-Link Technologies Co., Ltd. Other brands and product names are trademarks or registered trademarks of their respective holders.

No part of the specifications may be reproduced in any form or by any means or used to make any derivative such as translation, transformation, or adaptation without permission from TP-Link Technologies Co., Ltd. Copyright © 2017 TP-Link Technologies Co., Ltd. All rights reserved.

<http://www.tp-link.com>

FCC STATEMENT



This equipment has been tested and found to comply with the limits for a Class B digital device, pursuant to part 15 of the FCC Rules. These limits are designed to provide reasonable protection against harmful interference in a residential installation. This equipment generates, uses and can radiate radio frequency energy and, if not installed and used in accordance with the instructions, may cause harmful interference to radio communications. However, there is no guarantee that interference will not occur in a particular installation. If this equipment does cause harmful interference to radio or television reception, which can be determined by turning the equipment off and on, the user is encouraged to try to correct the interference by one or more of the following measures:

- Reorient or relocate the receiving antenna.
- Increase the separation between the equipment and receiver.
- Connect the equipment into an outlet on a circuit different from that to which the receiver is connected.
- Consult the dealer or an experienced radio/ TV technician for help.

This device complies with part 15 of the FCC Rules. Operation is subject to the following two conditions:

- 1) This device may not cause harmful interference.
- 2) This device must accept any interference received, including interference that may cause undesired operation.

Any changes or modifications not expressly approved by the party responsible for compliance could void the user's authority to operate the equipment.

Note: The manufacturer is not responsible for any radio or TV interference caused by unauthorized modifications to this equipment. Such modifications could void the user's authority to operate the equipment.

FCC RF Radiation Exposure Statement:

This equipment complies with FCC RF radiation exposure limits set forth for an uncontrolled environment. This device and its antenna must not be co-located or operating in conjunction with any other antenna or transmitter.

"To comply with FCC RF exposure compliance requirements, this grant is applicable to only Mobile Configurations. The antennas used for this transmitter must be installed to provide a separation distance of at least 20 cm from all persons and must not be co-located or operating in conjunction with any other antenna or transmitter."

CE Mark Warning

CE 1588

This is a class B product. In a domestic environment, this product may cause radio interference, in which case the user may be required to take adequate measures.

Adapter shall be installed near the equipment and shall be easily accessible.

Caution

Please make sure the temperature for adapter will be from 0 °C to 40 °C.

RF Exposure Information

This device meets the EU requirements (1999/5/EC Article 3.1a) on the limitation of exposure of the general public to electromagnetic fields by way of health protection.

The device complies with RF specifications when the device used at 20 cm from your body.

Canadian Compliance Statement

This device complies with Industry Canada license-exempt RSSs. Operation is subject to the following two conditions:

- 1) This device may not cause interference, and
- 2) This device must accept any interference, including interference that may cause undesired operation of the device.

Le présent appareil est conforme aux CNR d'Industrie Canada applicables aux appareils radio exempts de licence. L'exploitation est autorisée aux deux conditions suivantes:

- 1) l'appareil ne doit pas produire de brouillage;
- 2) l'utilisateur de l'appareil doit accepter tout brouillage radioélectrique subi, même si le brouillage est susceptible d'en compromettre le fonctionnement.

This radio transmitter (IC: 8853A-NC450/ Model: NC450) has been approved by Industry Canada to operate with the antenna types listed below with the maximum permissible gain indicated. Antenna types not included in this list (Appendix A), having a gain greater than the maximum gain indicated for that type, are strictly prohibited for use with this device.

Le présent émetteur radio (IC: 8853A-NC450/ Model: NC450) a été approuvé par Industrie Canada pour fonctionner avec les types d'antenne énumérés ci-dessous et ayant un gain admissible maximal. Les types d'antenne non inclus dans cette liste (Annexe A), et dont le gain est supérieur au gain maximal indiqué, sont strictement interdits pour l'exploitation de l'émetteur.

Radiation Exposure Statement:

This equipment complies with IC radiation exposure limits set forth for an uncontrolled environment. This equipment should be installed and operated with minimum distance 20cm between the radiator & your body.

Déclaration d'exposition aux radiations:

Cet équipement est conforme aux limites d'exposition aux rayonnements IC établies pour un environnement non contrôlé. Cet équipement doit être installé et utilisé avec un minimum de 20 cm de distance entre la source de rayonnement et votre corps.

Industry Canada Statement

CAN ICES-3 (B)/NMB-3(B)

Korea Warning Statements:

당해 무선설비는 운용중 전파혼신 가능성이 있음.

NCC Notice

注意！

依據 低功率電波輻射性電機管理辦法

第十二條 經型式認證合格之低功率射頻電機，非經許可，公司、商號或使用者均不得擅自變更頻率、加大功率或變更原設計之特性或功能。

第十四條 低功率射頻電機之使用不得影響飛航安全及干擾合法通行；經發現有干擾現象時，應立即停用，並改善至無干擾時方得繼續使用。前項合法通信，指依電信規定作業之無線電信。低功率射頻電機需忍受合法通信或工業、科學以及醫療用電波輻射性電機設備之干擾。

BSMI Notice

安全諮詢及注意事項

- 請使用原裝電源供應器或只能按照本產品注明的電源類型使用本產品。
- 清潔本產品之前請先拔掉電源線。請勿使用液體、噴霧清潔劑或濕布進行清潔。
- 注意防潮，請勿將水或其他液體潑灑到本產品上。
- 插槽與開口供通風使用，以確保本產品的操作可靠並防止過熱，請勿堵塞或覆蓋開口。
- 請勿將本產品置放於靠近熱源的地方。除非有正常的通風，否則不可放在密閉位置中。
- 請不要私自打開機殼，不要嘗試自行維修本產品，請由授權的專業人士進行此項工作。





Продукт сертифіковано згідно с правилами системи УкрСЕПРО на відповідність вимогам нормативних документів та вимогам, що передбачені чинними законодавчими актами України.



Safety Information

- When product has power button, the power button is one of the way to shut off the product; when there is no power button, the only way to completely shut off power is to disconnect the product or the power adapter from the power source.
- Don't disassemble the product, or make repairs yourself. You run the risk of electric shock and voiding the limited warranty. If you need service, please contact us.
- Avoid water and wet locations.
- Adapter shall be installed near the equipment and shall be easily accessible.
- The plug considered as disconnect device of adapter.
-  Use only power supplies which are provided by manufacturer and in the original packing of this product. If you have any questions, please don't hesitate to contact us.

Explanation of the symbols on the product label

Symbol	Explanation
	DC voltage
	Indoor use only
	<p>RECYCLING</p> <p>This product bears the selective sorting symbol for Waste electrical and electronic equipment (WEEE). This means that this product must be handled pursuant to European directive 2012/19/EU in order to be recycled or dismantled to minimize its impact on the environment.</p> <p>User has the choice to give his product to a competent recycling organization or to the retailer when he buys a new electrical or electronic equipment.</p>