



# Omada

EAP110-Outdoor  
EAP225-Outdoor

## Installation Guide

Indoor/Outdoor Access Point

## Overview Package Contents

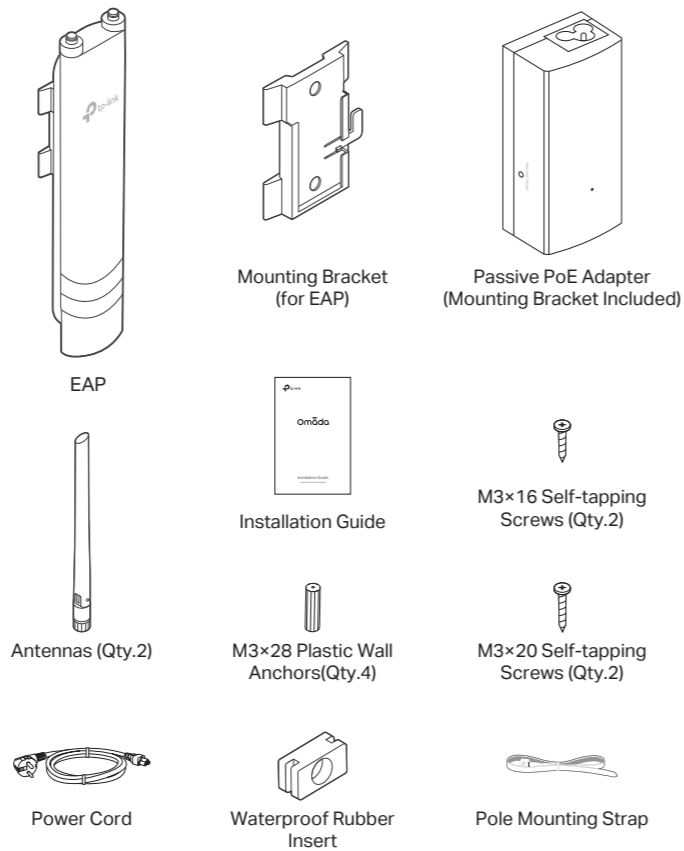

## Panel Layout

### The Panel of EAP

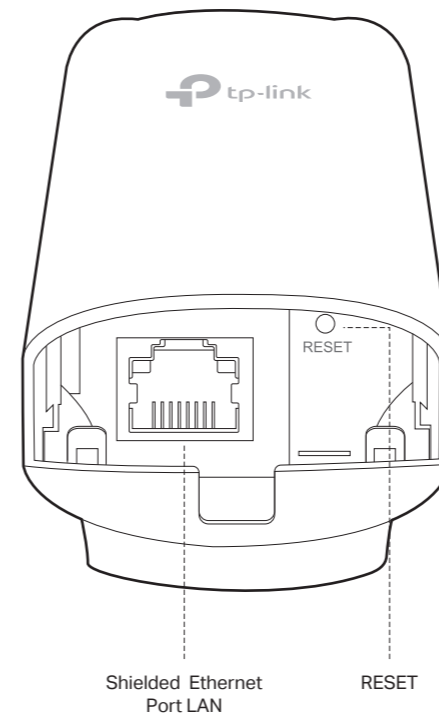

## SYS LED Explanation

LED Status	Indication
Flashes green twice	Initialization is completed.
Solid green	The device is initializing or working properly .
Flashes red	System errors. RAM, Flash, Ethernet, WLAN or firmware may be malfunctioning.
Flashes yellow	Firmware update is in progress. Do not disconnect or power off the device.
Double flashes red, green, yellow	The device is being reset to its factory default settings.

## Passive PoE Adapter

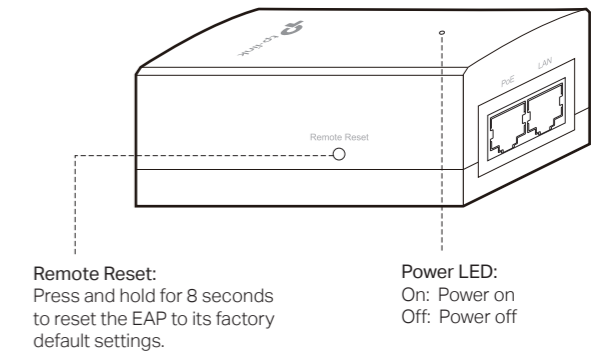

**Remote Reset:**  
Press and hold for 8 seconds to reset the EAP to its factory default settings.

**Power LED:**  
On: Power on  
Off: Power off

Note: EAP225-Outdoor does not support the Remote Reset feature.

## Typical Network Topology

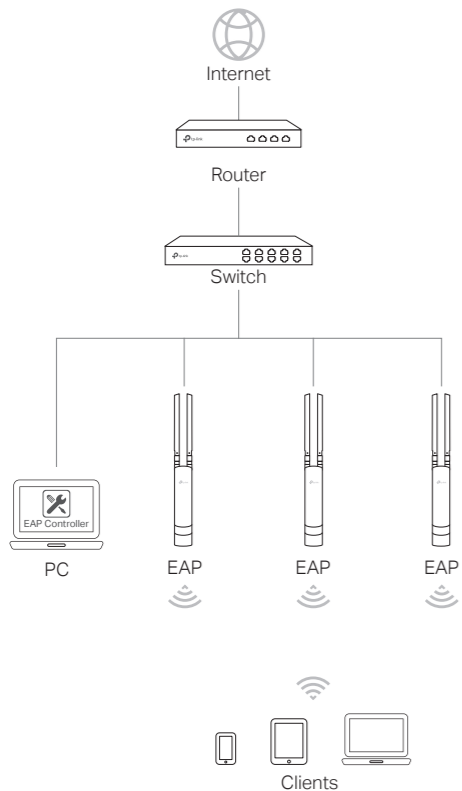

## Lightning and ESD Protection

Before mounting EAP, you should consider Lightning and ESD Protection to ensure safety.

Proper grounding is extremely important for outdoor devices. By using a shielded CAT5e (or above) cable for connection, you can reduce the damage of ESD attacks.

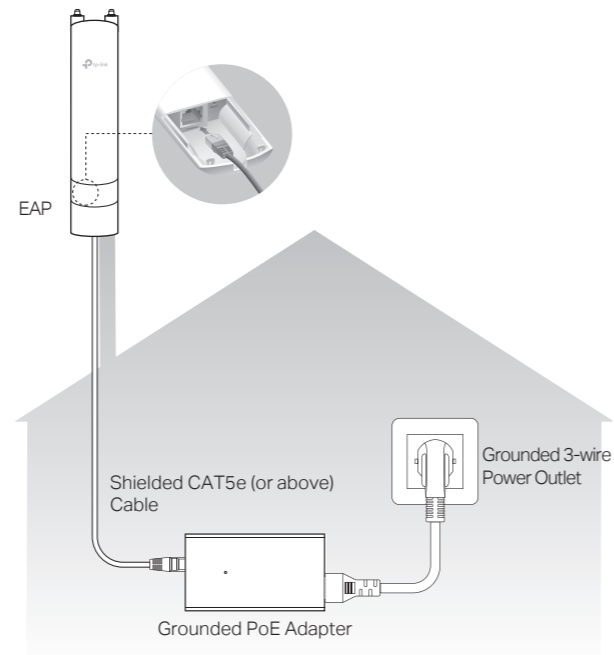

## Hardware Installation

### Mount EAP

- The EAP can be pole-mounted or wall-mounted when working independently.
- The EAP can be mounted on an external antenna when working with an external antenna.

#### Option 1: Pole Mounting

##### Step 1:

Lead the end of the pole mounting strap through the back of the EAP.

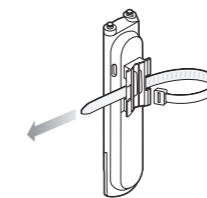

##### Step 2:

Position the EAP and wrap the pole mounting strap around the pole. Feed the end through the screw-block and tighten the strap until the EAP is secure.

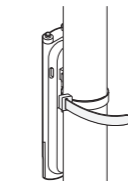

##### Step 3:

Connect the antennas to the EAP.

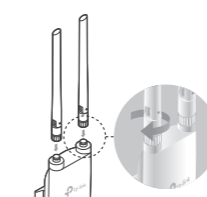

#### Option 2: Wall Mounting

##### Step 1:

Place the mounting bracket (for EAP) in the right position. Mark two positions for the screw holes. Drill two 6mm holes for the screws at the marked positions.

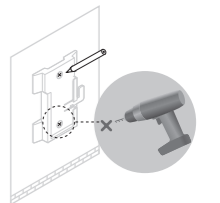

##### Step 2:

Insert the plastic wall anchors into the 6mm holes. Align the bracket (for EAP) to the plastic wall anchors and drive the self-tapping screws into the anchors through the bracket (for EAP).

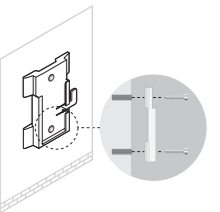

##### Step 3:

Align the mounting tabs on the back of the EAP with the slot of the mounting bracket (for EAP). Push and slide the EAP downward until it locks into place.

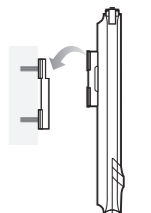

##### Step 4:

Connect the antennas to the EAP.

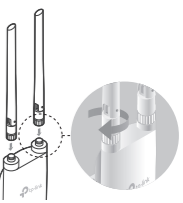

### Option 3: Mounting the EAP on an Antenna

Note: Sector antenna is used as a demonstration below.

#### Step 1:

Align the mounting tabs on the back of the EAP with the slot of the mounting bracket (for EAP). Push and slide the EAP downward until it locks into place.



#### Step 2:

Align the mounting tabs on the mounting bracket (for EAP) with the four slots of the mounting bracket on the antenna. Push and slide the EAP downward until it locks into place.



#### Step 3:

Connect the RF cables from the EAP to the corresponding connectors on the antenna.



#### Step 4:

Attach the protective cap. Push and slide the protective cap down over the EAP until it firmly locks into place.



- Sector or omni antennas need to be purchased additionally.
- TL-ANT2415MS/TL-ANT5819MS/TL-ANT2410MO are available for the EAP.

### Connect Cables

#### Step 1:

Firmly grasp the rear of the interface cover and pull it downward.



#### Step 2:

Use an adequate Ethernet cable to connect the LAN port. The length of cable is up to 100m for steady power supply. Shielded CAT5e (or above) cable is recommended.



#### Step 3:

Attach the waterproof rubber insert to the groove at the underside of the device for waterproofing and replace the cover until it firmly locks into place.



### Power On

The EAP can be powered via the provided passive PoE adapter or a PSE device (such as a PoE switch).

#### Via Passive PoE Adapter

##### Connecting the PoE Adapter

Connect the EAP to a Power over Ethernet (PoE) adapter as follows:

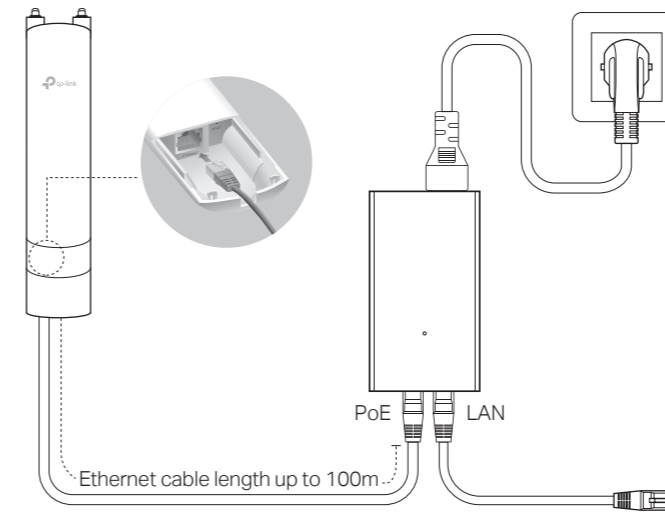

### Mounting the PoE Adapter (Optional)

Note: To ensure the passive PoE adapter is attached most securely, it is recommended to install the adapter with the Ethernet port facing upward.

#### Step 1:

Remove the mounting bracket from the passive PoE Adapter. Drill two holes on the wall and insert the plastic wall anchors into the holes. Secure the mounting bracket to the wall. Make sure the shoulders at the corners of the mounting bracket are on the outside and pointing upward.

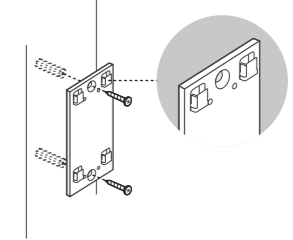

#### Step 2:

Attach the passive PoE adapter to the mounting bracket (for PoE Adapter) by sliding the adapter in the direction of the arrows until it locks into place.

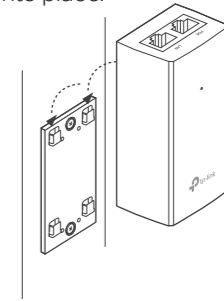

### Via PoE Switch

Connect an Ethernet cable from the PoE switch to the ETHERNET port.

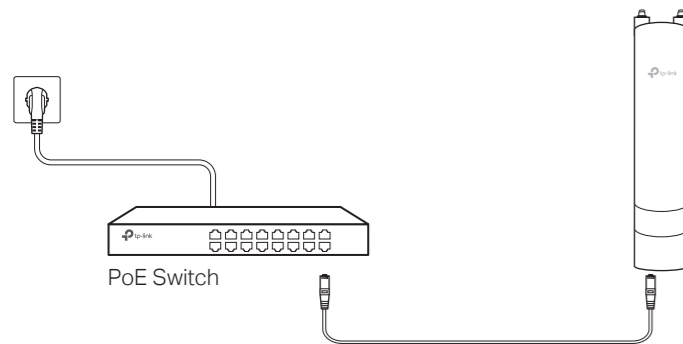

## Software Configuration

The EAP supports two configuring options:

- To configure and manage mass EAPs via centralized controller software, please refer to **Option 1**.
- To configure a single EAP via a web browser directly, please refer to **Option 2**.

### Option 1: Via EAP Controller

#### Step 1: Installing the EAP Controller

On the PC, download the EAP Controller installation file from <http://www.tp-link.com/en/download/EAP-Controller.html>. Run the file and follow the wizard to install the EAP Controller.

#### Step 2: Configuring the EAP Controller

Launch the EAP Controller and follow the step-by-step instructions to complete the Quick Setup. After the wizard is finished, a login screen will appear.

#### Step 3: Logging in to the EAP Controller

Enter the admin name and password you created and click **Sign In**. Then you can further configure the EAP Controller.

For detailed configurations, please visit <http://www.tp-link.com/support> to download the User Guide of EAP Controller in the download center.

### Option 2: Via Web Browser

#### Step 1: Connecting to the EAP Device

Power on the EAP and connect wirelessly by using the default SSID (format: TP-Link\_2.4GHz/5GHz\_XXXXXX) printed on the product label.

#### Step 2: Logging in to the EAP Device

Launch a web browser and enter <http://tplinkeap.net> in the address bar. Use **admin** for both Username and Password to log in.

#### Step 3: Configuring the EAP device

Set up a new Username and Password for secure management purpose. Modify the wireless parameters and reconnect your wireless devices to the new wireless network.

For detailed configurations, please visit <http://www.tp-link.com/support> to download the User Guide of EAP in the download center.

#### Attention:

For EAP225-Outdoor, in EU member states and EFTA countries, the operation in the frequency range 5150MHz - 5350MHz is only permitted indoors. For EAP Controller, go to **Access Point** page and select the desired EAP to specify the channel. For web browser, go to **Wireless > Wireless Settings** to specify the channel.

AT	BE	BG	CH	CY	CZ	DE	DK	EE	EL	ES	FI	FR	HR	HU	IE
IS	IT	LI	LT	LU	LV	MT	NL	NO	PL	PT	RO	SE	SI	SK	UK



For technical support, User Guide and other information, please visit <http://www.tp-link.com/support>, or simply scan the QR code.



The products of TP-Link partly contain software code developed by third parties, including software code subject to the GNU General Public License ("GPL"). As applicable, the terms of the GPL and any information on obtaining access to the respective GPL Code used in TP-Link products are available to you in GPL-Code-Centre under (<http://www.tp-link.com/en/support/gpl/>). The respective programs are distributed WITHOUT ANY WARRANTY and are subject to the copyrights of one or more authors. For details, see the GPL Code and other terms of the GPL.