



Business Networking Solution

# Installation Guide

SafeStream Multi-WAN Router

TL-ER6020/TL-R480T+

TL-ER5120/TL-ER6120



## About this Installation Guide

---

This Installation Guide describes the hardware characteristics, installation methods and the points that should be attended to during the installation. This Installation Guide is structured as follows:

### Chapter 1 Introduction

This chapter describes the external components of the router.

### Chapter 2 Installation

This chapter illustrates how to install the router.

### Chapter 3 Connection

This chapter illustrates how to do the physical connection of the router.

### Appendix A Troubleshooting

### Appendix B Hardware Specifications

## Audience

---

This Installation Guide is for:



Network Engineer

Network Administrator

## Conventions

---

- Some models featured in this guide may be unavailable in your country or region. For local sales information, visit <http://www.tp-link.com>.
- The figures in Chapter 2 to Chapter 3 are for demonstration purposes only. Your router may differ in appearance from that depicted.
- This guide uses the specific formats to highlight special messages. The following table lists the notice icons that are used throughout this guide.

	Remind to be careful. A caution indicates a potential which may result in device damage.
	Remind to take notice. The note contains the helpful information for a better use of the product.

## Related Document

---

This Installation Guide is also available in PDF on our website. To obtain the latest documentation and product information, please visit the official website:

<http://www.tp-link.com>

# Contents

---

Chapter 1	Introduction	01
1.1	Product Overview	01
1.2	Appearance	01
Chapter 2	Installation	04
2.1	Package Contents	04
2.2	Safety Precautions	04
2.3	Installation Tools	06
2.4	Product Installation	06
Chapter 3	Connection	08
3.1	WAN Port	08
3.2	LAN Port	08
3.3	Verify Installation	08
3.4	Power On	08
3.5	Initialization	09
3.6	Accessing the Router	09
Appendix A	Troubleshooting	10
Appendix B	Hardware Specifications	11

# Chapter 1 Introduction

## 1.1 Product Overview

The TP-Link SafeStream Multi-WAN Router TL-ER6020/TL-ER6120/TL-R480T+/TL-ER5120 provides three adjustable ports that can be set to either LAN or WAN, which enable the users to configure the amount of WAN ports based on need and connect multiple Internet lines for bandwidth expansion. The router possesses excellent data processing capability and multiple powerful functions.

Abundant WAN Connection Type, DHCP and MAC Clone provide basic network connection capacity. Load Balance, NAT, and Routing provide advanced transmission functions. TL-ER6020/TL-ER6120 is also a VPN Router which supports VPN features including IPsec, PPTP and L2TP.

## 1.2 Appearance

### Front Panel

The front panel of TL-ER6020 is shown as the following figure.

Figure 1-1 Front Panel of TL-ER6020

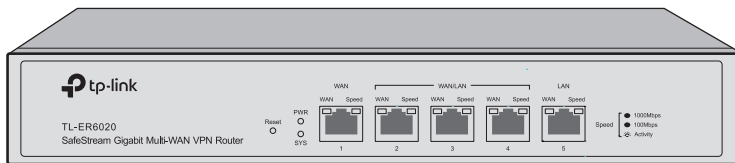

The front panel of TL-ER6120 is shown as the following figure.

Figure 1-2 Front Panel of TL-ER6120

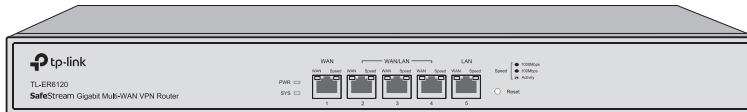

The front panel of TL-ER5120 is shown as the following figure.

Figure 1-3 Front Panel of TL-ER5120

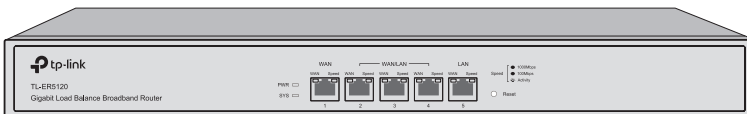

The front panel of TL-R480T+ is shown as the following figure.

Figure 1-4 Front Panel of TL-480T+

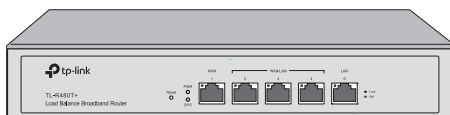

## LEDs

For TL-ER6120/TL-ER6020/TL-ER5120

LED	Indication
PWR	<b>On:</b> The router is powered on. <b>Off:</b> The router is powered off or the power supply is abnormal.
SYS	<b>Flashing:</b> The router works properly. <b>On or Off:</b> The router works improperly.
Speed	<b>Green On:</b> Running at 1000Mbps without data transmission. <b>Green Flashing:</b> Running at 1000Mbps and is transmitting or receiving data. <b>Yellow On:</b> Running at 100Mbps without data transmission. <b>Yellow Flashing:</b> Running at 100Mbps and is transmitting or receiving data. <b>Off:</b> No device is linked to the corresponding port or the port is running at 10Mbps.
WAN	<b>On:</b> The port is working in WAN mode. <b>Off:</b> The port is working in LAN mode.

For TL-R480T+

LED	Indication
PWR	<b>On:</b> The router is powered on. <b>Off:</b> The router is powered off or the power supply is abnormal.
SYS	<b>Flashing:</b> The router works properly. <b>On or Off:</b> The router works improperly.
Link/Act	<b>On:</b> There is a device connected to the corresponding port but not active. <b>Flashing:</b> The corresponding port is transmitting or receiving data. <b>Off:</b> No device is linked to the corresponding port.

## Interface Description

Interface	Description
WAN	The WAN port is designed to connect the router to a DSL/Cable modem or Ethernet by the RJ45 cable.
LAN	The LAN port is designed to connect the router to the local PCs or switches by the RJ45 cable.

## Reset

Use the button to restore the router to the factory defaults. With the router powered on, use a pin to press and hold the Reset button (about 5 seconds) until the SYS LED flashes quickly. Then release the button and wait for the router rebooting to its factory default settings.

## ▪ Rear Panel

The rear panel is shown as the following figure. Here we take TL-ER6020 as an example.

Figure 1-5 Rear Panel

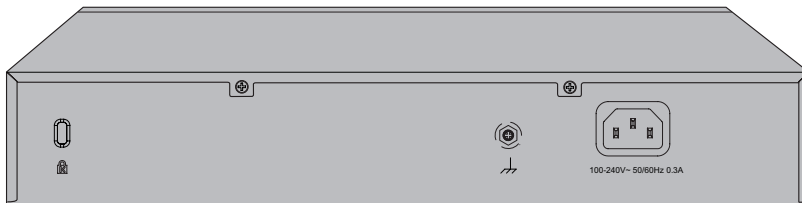

## Power Socket

Connect the female connector of the power cord here, and the male connector to the AC power outlet. Please make sure the voltage of the power supply meets the requirement of the input voltage (100-240V~ 50/60Hz).

## Grounding Terminal

The router already comes with lightning protection mechanism. You can also ground the router through the PE (Protecting Earth) cable of AC cord or with Ground Cable. For detailed information, please refer to the **Lightning Protection Guide** from the training center of our website <http://www.tp-link.com/en/configuration-guides.html>.

## Kensington

The kensington lock port is used to connect to a kensington lock to secure your router.



### Caution:

Please use the provided power cord.

## Chapter 2 Installation

---

### 2.1 Package Contents

---

Make sure that the package contains the following items. If any of the listed items is damaged or missing, please contact your distributor.

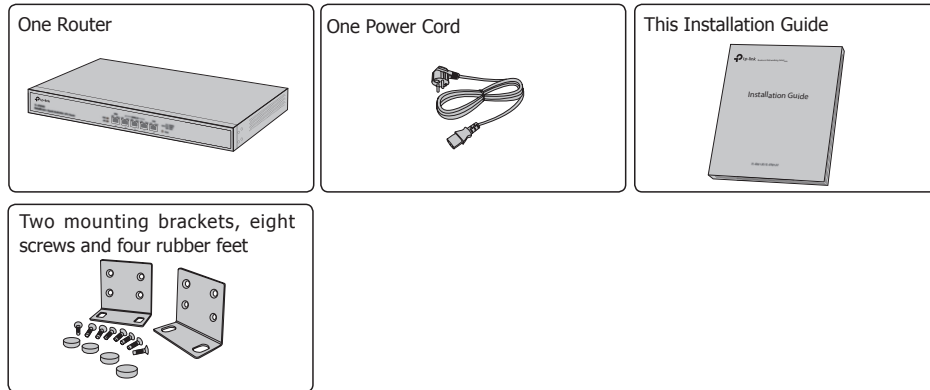

### 2.2 Safety Precautions

---

To avoid any device damage and bodily injury caused by improper use, please observe the following rules.

#### ■ Safety Precautions

- Keep the power off during the installation.
- Wear an ESD-preventive wrist strap, and make sure that the wrist strap has a good skin contact and is well grounded.
- Use only the power cord provided with the router.
- Make sure that the supply voltage matches the specifications indicated on the rear panel of the router.
- Ensure the vent hole is well ventilated and unblocked.
- Do not open or remove the cover of the router.
- Before cleaning the device, cut off the power supply. Do not clean it by the waterish cloth, and never use any other liquid cleaning method.
- Place the device with its bottom surface downward.



## Site Requirements

### Temperature/Humidity



Please keep a proper temperature and humidity in the equipment room. Too high/low humidity may lead to bad insulation, electricity leakage, mechanical property changes and corrosions. Too high temperature may accelerate aging of the insulation materials and can thus significantly shorten the service life of the device. For normal temperature and humidity of the device, please check the following table.

Environment	Temperature	Humidity
Operating	0°C to 40°C	10% to 90%RH Non-condensing
Storage	-40°C to 70°C	5% to 90%RH Non-condensing

### Clearness



The dust accumulated on the router can be absorbed by static electricity and result in poor contact of metal contact points. Some measures have been taken for the device to prevent static electricity, but too strong static electricity can cause deadly damage to the electronic elements on the internal circuit board. To avoid the effect of static electricity on the operation of the router, please attach much importance to the following items:

- Dust the device regularly, and keep the indoor air clean.
- Keep the device well grounded and ensure static electricity has been transferred.

### Electromagnetic Interference



Electronic elements including capacitance and inductance on the device can be affected by external interferences, such as conducted emission by capacitance coupling, inductance coupling, and impedance coupling. To decrease the interferences, please make sure to take the following measures:

- Use the power supply that can effectively filter interference from the power grid.
- Keep the device far from high-frequency, strong-current devices, such as radio transmitting station.
- Use electromagnetic shielding when necessary.

## Lightening Protection



Extremely high voltage currents can be produced instantly when lightning occurs and the air in the electric discharge path can be instantly heated up to 20,000°C. As this instant current is strong enough to damage electronic devices, more effective lightning protection measures should be taken.

- Ensure the rack and device are well earthed.
- Make sure the power socket has a good contact with the ground.
- Keep a reasonable cabling system and avoid induced lightning.
- Use the signal SPD (Surge Protective Device) when wiring outdoor.



### Note:

For detailed lightning protection measures, please refer to the Lightning Protection Guide from the training center of our website <http://www.tp-link.com/en/configuration-guides.html>.

## Installation Site

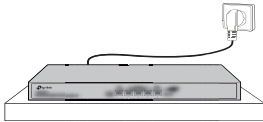

When installing the device on a rack or a flat workbench, please note the following items:

- The rack or workbench is flat and stable, and sturdy enough to support the weight of 5.5kg at least.
- The rack or workbench has a good ventilation system. The equipment room is well ventilated.
- The rack is well grounded. Keep the power socket less than 1.5 meters away from the device.

## 2.3 Installation Tools

- Phillips screwdriver
- ESD-preventive wrist wrap
- Cables



### Note:

These tools are not provided with our product. If needed, please self purchase them.

## 2.4 Product Installation

### ■ Desktop Installation

To install the device on the desktop, please follow the steps:

1. Set the device on a flat surface strong enough to support the entire weight of the device with all fittings.
2. Remove the adhesive backing papers from the rubber feet.

- Turnover the device and attach the supplied rubber feet to the recessed areas on the bottom at each corner of the device.

Figure 2-1 Desktop Installation

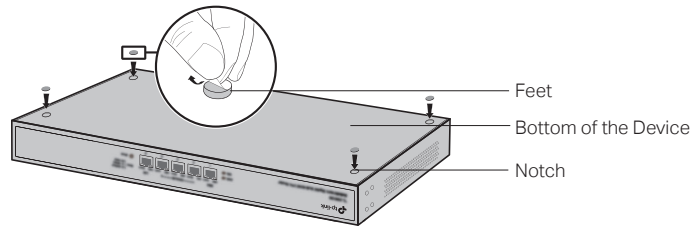

### ▪ Rack Installation

To install the device in an EIA standard-sized, 19-inch rack, follow the instructions described below:

- Check the grounding and stability of the rack.
- Secure the supplied rack-mounting brackets to each side of the device with supplied screws, as illustrated in the following figure.

Figure 2-2 Bracket Installation

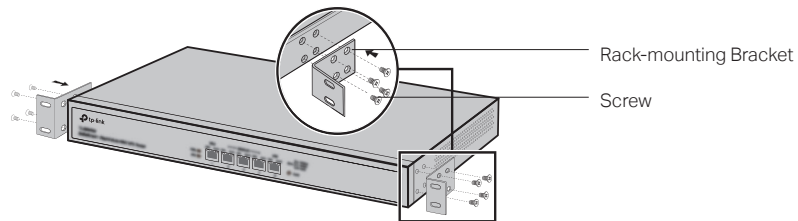

- After the brackets are attached to the device, use suitable screws (not provided) to secure the brackets to the rack, as illustrated in the following figure.

Figure 2-3 Rack Installation

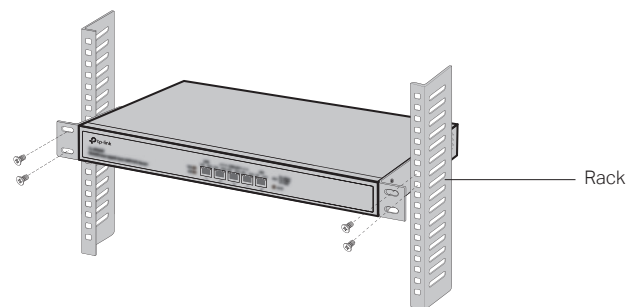

#### Caution:

- Please set 5~10cm gaps around the device for air circulation.
- Please avoid any heavy thing placed on the device.
- Please mount devices in sequence from the bottom to top of the rack and ensure a certain clearance between devices for the purpose of heat dissipation.

## Chapter 3 Connection

---

### 3.1 WAN Port

---

Please connect the WAN port of the router to the interface provided by ISP via Ethernet cable.

### 3.2 LAN Port

---

Connect a LAN port of the router to the computer by RJ45 cable as the following figure shows.

Figure 3-1 Connecting the LAN Port

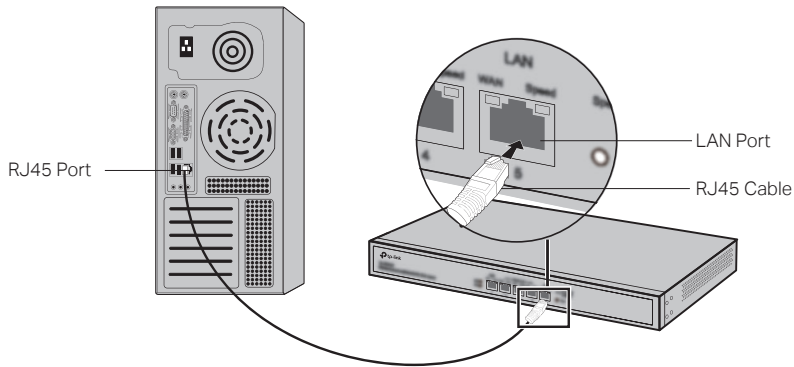

**Note:**

If the router is connecting to Server/Switch or other Ethernet devices, please make sure the RJ45 cable is less than 100m.

---

### 3.3 Verify Installation

---

After completing the installation, please verify the following items:

- There are 5~10cm of clearance around the sides of the device for ventilation and the air flow is adequate.
- The voltage of the power supply meets the requirement of the input voltage of the device.
- The power socket, device and rack are well grounded.
- The device is correctly connected to other network devices.

### 3.4 Power On

---

Plug the female connector of the provided power cord into the power socket of the device, and the male connector into a power outlet as the following figure shows.

Figure 3-2 Connecting to Power Supply

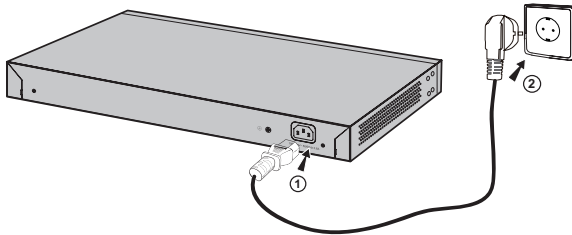

**Note:**

The figure is to illustrate the application and principle. The power plug you get from the package and the socket in your situation will comply with the regulation in your country, so they may differ from the figure above.

---

### 3.5 Initialization

---

After the device is powered on, it begins the Power-On Self-Test. A series of tests run automatically to ensure the device functions properly. During this time, its LED indicators will respond as follows:

- The PWR LED will light on all the time.
- The WAN and Speed LED will light on for about one second then turn off during the initialization.
- The SYS LED will flash quickly during the initialization. After the initialization finished, the SYS LED will flash every second continuously.

### 3.6 Accessing the Router

---

After the initialization finished, you can access and manage the router using the GUI (Graphical User Interface). To access the router using the GUI, open a web browser and type the default management address <http://192.168.0.1> in the address field, then press the Enter key. Create a username and a password for subsequent login attempts. Use the username and password set previously to log in to the router.

For the detailed configurations, please refer to the Configuration Guide. The guide can be found on the download center of our official website: <http://www.tp-link.com/en/download-center.html>.

## Appendix A Troubleshooting

---

### **Q1. What should I do if I forget the username and password for the router's web management page?**

Please restore the router to factory defaults. The default management address of the router is `http://192.168.0.1`. You can manually set a new username and password for login. All current settings will be cleared once the router is restored. If you have a backup of your configurations, you can import it after the factory restore is complete.

### **Q2. Why does the PWR LED work abnormally?**

The PWR LED should be lit up when the power system works normally. If the PWR LED worked abnormally, please try the following:

1. Make sure that the power cable is connected properly, and the power contact is normal.
2. Make sure the voltage of the power supply meets the requirement of the input voltage of the router.

### **Q3. What should I do if I can't access the web management page?**

You are recommended to check the following:

1. If the computer is set to a static or fixed IP address, change its settings to obtain an IP address automatically.
2. Enter `http://192.168.0.1` in the web browser and press Enter.
3. Use another web browser and try again.
4. Restore the router to its factory default settings and repeat the steps above.

### **Q4. Why is the web management page not displaying completely?**

If you can access the web management page, but some of the configuration content is missing, please try the following:

1. Update your web browser or try a different web browser.
2. If pop-ups are being blocked, please lower the security level of your web browser.

## Appendix B Hardware Specifications

Item	Content
Standards	<p>TL-ER6020: IEEE 802.3, IEEE 802.3i, IEEE 802.3u, IEEE 802.3ab, IEEE 802.1x, IEEE 802.1q, TCP/IP, DHCP, ICMP, NAT, PPPoE, SNTP, HTTP, DNS, L2TP/PPTP/IPSec</p> <p>TL-ER6120: IEEE 802.3, IEEE 802.3u, IEEE 802.3ab, IEEE 802.3x, TCP/IP, DHCP, ICMP, NAT, PPPoE, SNTP, HTTP, DNS, L2TP/PPTP/IPSec</p> <p>TL-ER5120: IEEE 802.3, IEEE 802.3u, IEEE 802.3ab, IEEE 802.3x, TCP/IP, DHCP, ICMP, NAT, PPPoE, SNTP, HTTP, DNS</p> <p>TL-R480T+: IEEE 802.3, IEEE 802.3i, IEEE 802.3u, IEEE 802.3x, IEEE 802.1q, TCP/IP, DHCP, ICMP, NAT, PPPoE, SNTP, HTTP, DNS</p>
Transmission Medium	<p>TL-ER6120/ TL-ER5120/ TL-ER6020:            10Base-T: UTP/STP of Cat. 3 or above(≤100m)            100Base-TX: UTP/STP of Cat. 5 or above(≤100m)            1000Base-T: UTP/STP of Cat.5e or above(≤100m)</p> <p>TL-R480T+:            10Base-T: UTP/STP of Cat. 3 or above(≤100m)            100Base-TX: UTP/STP of Cat. 5 or above(≤100m)</p>
LEDs	<p>TL-ER6120/ TL-ER5120/ TL-ER6020: PWR, SYS, WAN, Speed</p> <p>TL-R480T+: PWR, SYS, Link/Act</p>
Power	100-240V~ 50/60Hz 0.3A
Operating Temperature	0°C to 40°C (32°F to 104°F)
Storage Temperature	-40°C to 70°C (-40°F to 158°F)
Operating Humidity	10% to 90%RH Non-condensing
Storage Humidity	5% to 90%RH Non-condensing

## FCC STATEMENT

This equipment has been tested and found to comply with the limits for a Class A digital device, pursuant to part 15 of the FCC Rules. These limits are designed to provide reasonable protection against harmful interference when the equipment is operated in a commercial environment. This equipment generates, uses, and can radiate radio frequency energy and, if not installed and used in accordance with the instruction manual, may cause harmful interference to radio communications. Operation of this equipment in a residential area is likely to cause harmful interference in which case the user will be required to correct the interference at his own expense.

This device complies with part 15 of the FCC Rules. Operation is subject to the following two conditions:

- 1) This device may not cause harmful interference.
- 2) This device must accept any interference received, including interference that may cause undesired operation.

Any changes or modifications not expressly approved by the party responsible for compliance could void the user's authority to operate the equipment.

## CE Mark Warning



This is a Class A product. In a domestic environment, this product may cause radio interference, in which case the user may be required to take adequate measures.



Продукт сертифіковано згідно с правилами системи УкрСЕПРО на відповідність вимогам нормативних документів та вимогам, що передбачені чинними законодавчими актами України.

## Safety Information

- Keep the device away from water, fire, humidity or hot environments.
- Do not attempt to disassemble, repair, or modify the device.
- Do not use damaged charger or USB cable to charge the device.
- Do not use any other chargers than those recommended



Please read and follow the above safety information when operating the device. We cannot guarantee that no accidents or damage will occur due to improper use of the device. Please use this product with care and operate at your own risk.

この装置は、クラスA情報技術装置です。この装置を家庭環境で使用すると電波妨害を引き起こすことがあります。この場合には使用者が適切な対策を講ずるよう要求されることがあります。 VCCI-A

## Industry Canada Statement

CAN ICES-3 (A)/NMB-3(A)

## BSMI Notice

安全諮詢及注意事項

- 1) 請使用原裝電源供應器或只能按照本產品注明的電源類型使用本產品。
- 2) 清潔本產品之前請先拔掉電源線。請勿使用液體、噴霧清潔劑或濕布進行清潔。
- 3) 注意防潮，請勿將水或其他液體潑灑到本產品上。
- 4) 插槽與開口供通風使用，以確保本產品的操作可靠並防止過熱，請勿堵塞或覆蓋開口。
- 5) 請勿將本產品置放於靠近熱源的地方。除非有正常的通風，否則不可放在密閉位置中。
- 6) 請不要私自打開機殼，不要嘗試自行維修本產品，請由授權的專業人士進行此項工作。



此為甲類資訊技術設備，于居住環境中使用時，可能會造成射頻擾動，在此種情況下，使用者會被要求採取某些適當的對策。

限用物質含有情況標示聲明書

產品元件名稱	限用物質及其化學符號					
	鉛 Pb	鎘 Cd	汞 Hg	六價鉻 CrVI	多溴聯苯 PBB	多溴二苯醚 PBDE
PCB	○	○	○	○	○	○
外殼	○	○	○	○	○	○
電源供應板	-	○	○	○	○	○

備考1. "超出0.1 wt %" 及 "超出0.01 wt %" 系指限用物質之百分比含量超出百分比含量基準值。  
備考2. "○" 系指該項限用物質之百分比含量未超出百分比含量基準值。  
備考3. "-" 系指該項限用物質為排除項目。

## Explanation of the symbols on the product label

Symbol	Explanation
	AC voltage
	Indoor use only.
	<p><b>RECYCLING</b></p> <p>This product bears the selective sorting symbol for Waste electrical and electronic equipment (WEEE). This means that this product must be handled pursuant to European directive 2012/19/EU in order to be recycled or dismantled to minimize its impact on the environment.</p> <p>User has the choice to give his product to a competent recycling organization or to the retailer when he buys a new electrical or electronic equipment.</p>





For technical support, User Guide and other information, please visit <http://www.tp-link.com/support>, or simply scan the QR code.