

TP-LINK®

AP300

User Guide

AC1200 Wireless Gigabit Access Point

Contents

About This Guide	1
Chapter 1. Get to Know About Your AP Device	2
1. 1. Product Overview	3
1. 2. Main Features	3
1. 3. Panel Layout	4
1. 3. 1.Top View	4
1. 3. 2.The Back Panel	5
1. 4. Position Your AP Device	6
Chapter 2. Operation Modes	7
2. 1. Determine the Mode	8
2. 2. Connect Your AP Device	8
Chapter 3. Log into Your AP Device	10
Chapter 4. Set Up Wireless Connections	13
4. 1. Quick Setup	14
4. 2. WPS	16
4. 3. Manually set up a wireless connection	18
4. 4. Check the connection status	24
Chapter 5. Customize Your Network and Security Settings	25
5. 1. Change the LAN Settings	26
5. 2. Specify DHCP Server Settings	26
5. 3. MAC Filtering	28
5. 4. Advanced Wireless Settings	30
Chapter 6. Manage Your AP Device	33
6. 1. System Log	34
6. 2. Test the Network Connectivity	34
6. 3. Upgrade the Firmware	36
6. 4. Backup and Restore Configuration Settings	37
6. 5. Change the Management Account	38





6.6.	Throughput Monitor	39
6.7.	Statistics	40
6.8.	SNMP Management	40
6.9.	Ping Watchdog.....	41
6.10.	LEDs Control	42
	FAQ	43
	Specifications	47

About This Guide

This guide provides details of each function and shows how to configure the AP device appropriate to your needs. In addition to this guide, a Quick Installation Guide is also released with each TP-LINK AP device, you are suggested to configure your AP device for quick Internet setup by following the published Quick Installation Guide before you get started with a further configuration.

Conventions

In this guide the following conventions are used:

Convention	Description
AP device	Stands for 11AC Wireless Gigabit Access Point without any explanation.
parameters	Parameters provided in the screenshots are just references for setting up the device, which may differ from the actual situation. You can set the parameters according to your demand.
screenshots	The demonstrated screenshots may look a little different from the actual web page of your device due to the various firmware versions. Please just configure your product based on the actual web page.
<i>Blue Italic</i>	Hyperlinks are in blue italic. You can click to redirect to a website or a specific section.
Blue	Contents to be emphasized and texts on the web page are in blue, including the menus, items, buttons, etc.
>	The menu structures to show the path to load the corresponding page. For example, Advanced > Wireless > WPS means the WPS function page is under the Wireless menu that is located in the Advanced tab.
 Note:	Ignoring this type of note might result in a malfunction or damage to the device.
 Tips:	Indicates important information that helps you make better use of your device.
symbols on the web page	<ul style="list-style-type: none"> click to edit the corresponding entry. click to delete the corresponding entry. click to enable or disable the corresponding entry.

Chapter 1

Get to Know About Your AP Device

This chapter introduces what the AP device can do and shows its main features and appearance.

This chapter contains the following sections:

- *Product Overview*
- *Main Features*
- *Panel Layout*
- *Position Your AP Device*

1.1. Product Overview

What This Product Does

The TP-LINK Wireless AC Access Point is designed to establish or expand a scalable high-speed wireless AC network or to connect multiple Ethernet enabled devices such as game consoles, digital media adapters, printers, or network attached storage devices to a wireless network. The AP supports a host of different functions that make your wireless networking experience more flexible than ever before. Now, you can enjoy a better Internet experience when downloading, gaming or video streaming.

802.11ac - The Next Generation of Wi-Fi

TP-LINK's Wireless AC Access Point comes with the next generation Wi-Fi standard - 802.11ac, backward compatible with 802.11n and 3 times faster than wireless N speeds. With higher power efficiency and robust security, 802.11ac is the perfect way to accelerate a home multimedia network and solve congestion that multiple devices may cause.

Concurrent Dual Band - More Bandwidth, Less Interference

With the high wireless speeds over the crystal clear 5GHz band and the 2.4GHz band, the Wireless AC Access Point offers you the flexibility of two dedicated networks and ensures amazing wireless performance. Simple tasks such as sending e-mails or web browsing can be handled by the 2.4GHz band while bandwidth intensive tasks like online gaming or HD video streaming can be processed by the 5GHz band – all at the same time.

Broad Wi-Fi Coverage and Targeted Connection

Featuring multiple detachable external antennas and high power amplifiers, the Wireless AC Access Point is able to boost Wi-Fi coverage throughout your home. Advanced Beamforming technology enables it to focus Wi-Fi signal on connected devices, delivering a more targeted and highly efficient wireless connection.

Multiple Operating Modes - Easy to Build WLAN

Supports AP, Bridge/Repeater, Client and Multi-SSID operation modes to enable various wireless applications to give you a more dynamic and comprehensive experience when using the AP device. Multiple operating modes also helps you easily build wireless network for hard-to-wire locations or eliminate wireless dead zone.

1.2. Main Features

Wireless and Wired Performance

- Supports 802.11ac - The next generation of Wi-Fi, compatible with 802.11n

- Support simultaneous 2.4GHz and 5GHz connections
- Multiple detachable external antennas and high power amplifiers provide stable signals and optimal wireless coverage
- Up to 4 SSIDs and VLAN support
- Provides WPA/WPA2, WPA-PSK/WPA2-PSK authentication, TKIP/AES encryption security
- Supports MAC filter, throughput monitor
- Easy one-touch WPA wireless security encryption with the WPS button
- Supports firmware upgrade and Web management
- Supports system log and Traffic Statistics

1.3. Panel Layout

1.3.1. Top View

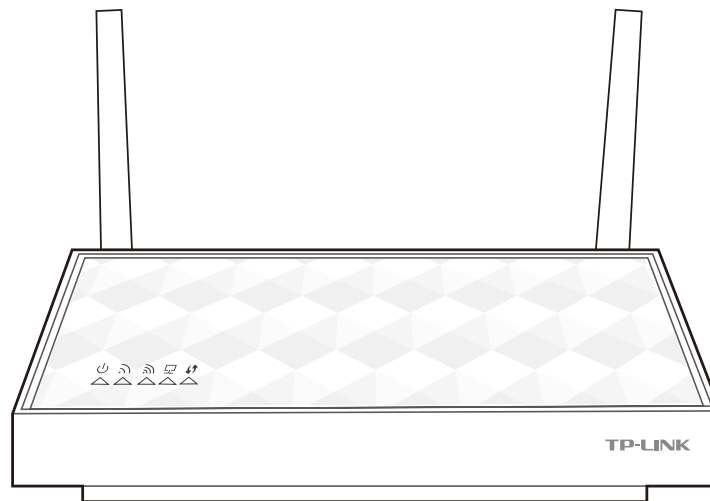





The AP device's LEDs are located on the top panel. You can check the AP device's working status by following the LED Explanation table (view from left to right).

LED Explanation

Name	Status	Indication
⏻ (Power)	On	System initialization completes.
	Blinking	System initialization or firmware upgrade is in process. Do not disconnect or power off the AP device.
	Off	Power is off. Please ensure that the power adapter is connected correctly.

LED Explanation

Name	Status	Indication
 (Wireless 2.4GHz)	On	The wireless 2.4GHz band is working properly (in AP/Multi-SSID mode). The host AP's 2.4GHz network is selected (in Repeater/Bridge/Client mode).
	Off	The wireless 2.4GHz band is disabled (in AP/Multi-SSID mode). The host AP's 2.4GHz is not selected (in Repeater/Bridge/Client mode).
 (Wireless 5GHz)	On	The wireless 5GHz band is working properly (in AP/Multi-SSID mode). The host AP's 5GHz network is selected (in Repeater/Bridge/Client mode).
	Off	The wireless 5GHz band is disabled (in AP/Multi-SSID mode). The host AP's 5GHz is not selected (in Repeater/Bridge/Client mode).
 (LAN)	On	A device is connected to the Ethernet port.
	Off	No device is connected to the Ethernet port.
 (WPS)	Slow blinking	WPS connection is in process.
	On	WPS connection is successful. It will turn off after 5 minutes.
	Quick blinking	WPS connection is failed.
	Solid orange	The signal strength is too weak (in Repeater/Bridge/Client mode).
	Off	The device is disconnected from the host network (in Repeater/Bridge/Client mode).

Note:

After a device is successfully added to the network by WPS function, the WPS LED will keep on for about 5 minutes and then turn off.

1.3.2. The Back Panel

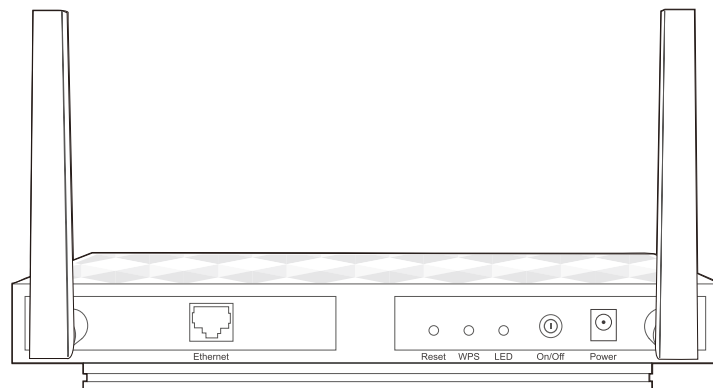

The AP device's back panel shows the connection ports, buttons and antennas. Refer to the following for detailed instructions (view from left to right).

Item	Description
Ethernet	One LAN 10/100/1000Mbps Auto-Negotiation RJ45 Port connects to a network device.
Reset	The switch for the reset function. With the device powered on, use a pin to press and hold the Reset button for five seconds until the Power LED starts blinking, then release the button.
WPS	Press and hold this button for two seconds to enable the WPS function. When the WPS LED blinks slowly, the device is trying to connect or to be connected.
LED	Press this button to turn on or turn off the LEDs.
On/Off	The switch for the power. Press it to power on or off the AP device.
Power	The power port connects to the provided power adapter.
Antennas	Used for wireless operation and data transmit. Upright them for the best Wi-Fi performance.

1.4. Position Your AP Device

- Place your AP device in a well-ventilated place far from any heater or heating vent
- Avoid direct irradiation of any strong light (such as sunlight)
- Keep at least 2 inches (5 cm) of clear space around your AP device
- Operating Temperature: 0°C~40°C (32°F~104°F)
- Operating Humidity: 10%~90%RH, Non-condensing

Generally, your AP device is placed on a horizontal surface. It also can be mounted on the wall as shown below.

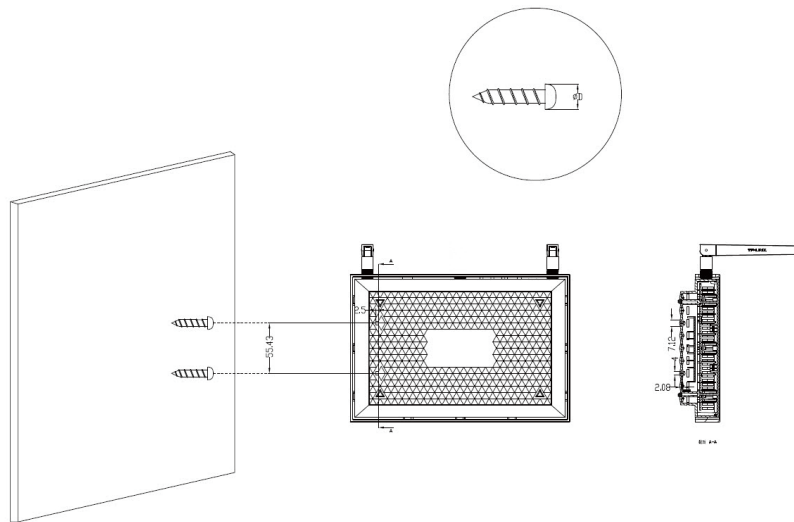

Note:

The diameter of the screw, $4\text{mm} < D < 7\text{mm}$, and the distance of two screws is 55.43mm. The screw that projects from the wall needs around 3.5mm based, and the length of the screw need to be at least 20mm to withstand the weight of the product.

Chapter 2

Operation Modes

The AP device supports four modes to satisfy user's diversified network requirements including Access Point mode, Repeater/Bridge mode, Client mode and multi-SSID mode. This chapter introduces typical usage scenarios of each mode. You can choose the desired scenario according to your needs, and refer to this part for hardware connection instruction.

- *Determine the Mode*
- *Connect Your AP Device*

2.1. Determine the Mode

Use the following scenarios to determine an appropriate operating mode for your network needs.

Modes	Scenarios
Access Point mode (Default mode)	You want to be able to access the Internet wirelessly, but this place only has an Ethernet port (wired network) available. you need to transform the existing wired network to a wireless network.
Repeater/Bridge mode	You are in a Wi-Fi dead-zone or a place with weak wireless signal. You want to have a greater effective range of the wireless signal throughout your home or office.
Client mode	You have a wired device with an Ethernet port and no wireless capability, for example, a Smart TV, Media Player, or game console. You want to connect it to the Internet wirelessly.
Multi-SSID mode	You want to divide the existing Wi-Fi network into several networks for different people with different access level and authority, for example, the guests, the host, the children and the parents.

2.2. Connect Your AP Device

Follow the figures below to connect your AP device.

Note:

AP300 is used for demonstration in this guide.

- **Access Point mode**

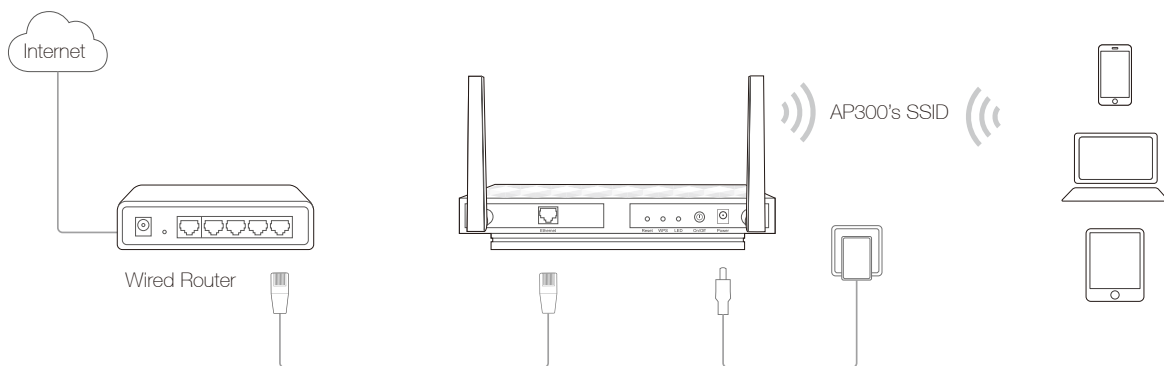

• Repeater/Bridge mode

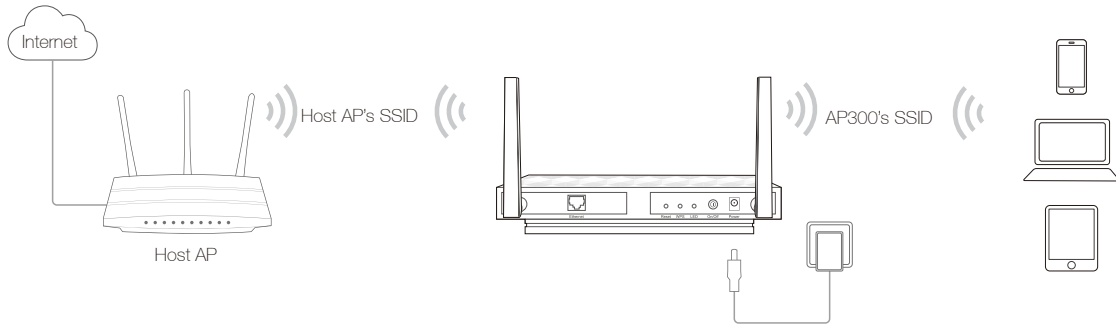

• Client mode

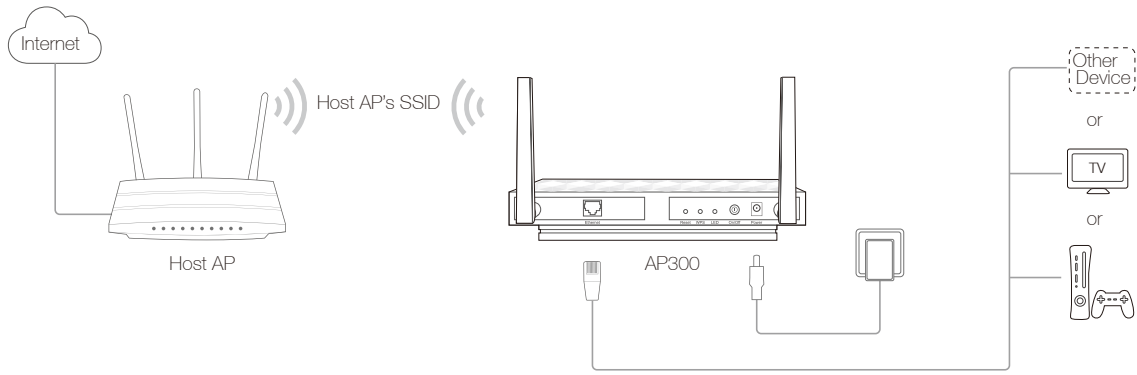

• Multi-SSID mode

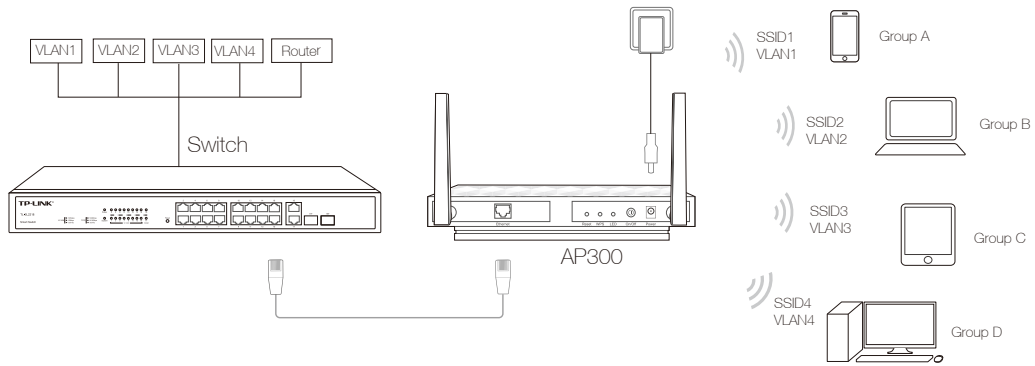

Chapter 3

Log into Your AP Device

With the Web-based management page, it is easy to configure and manage the AP device. The Web-based utility can be used on any Windows, Macintosh or UNIX OS with a Web browser, such as Microsoft Internet Explorer, Mozilla Firefox or Apple Safari.

Follow the steps below to log into your AP device.

1. Set up the TCP/IP Protocol in [Obtain an IP address automatically](#) mode on your computer.
2. Launch your Web browser. Enter <http://tplinkap.net> in the address field and Press Enter (PC) or Return (Mac).



3. Upon initial login, please enter [admin](#) in the username and password fields.

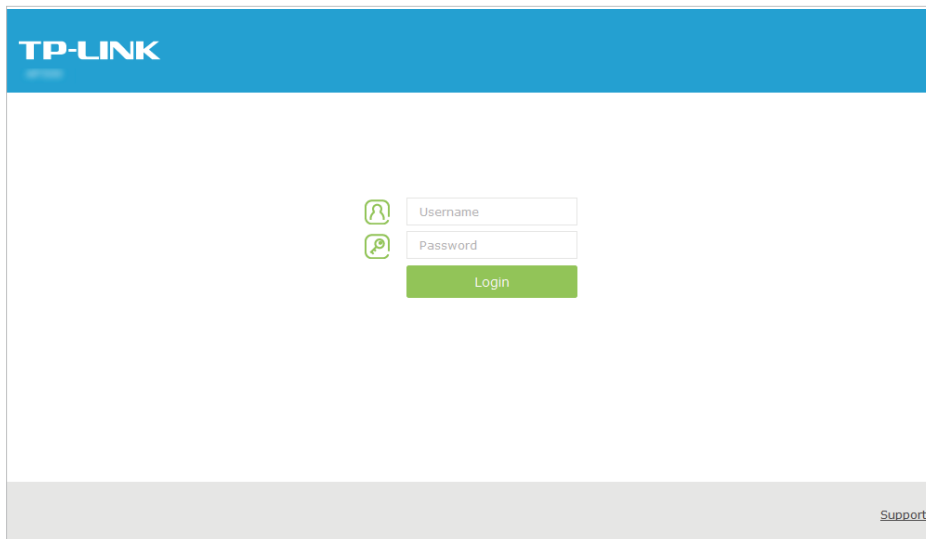

4. In the following pop-up window, it is recommended to change the device's username and password from its default settings for network security. Enter and confirm new username and password, then click [Confirm](#).

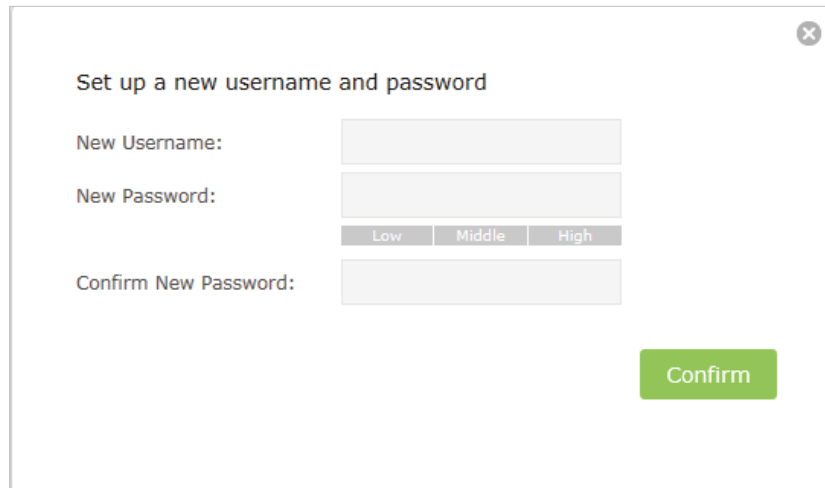

The screenshot shows a web form titled "Set up a new username and password" with a close button (X) in the top right corner. The form contains three input fields: "New Username:", "New Password:", and "Confirm New Password:". The "New Password:" field has a strength indicator below it with three segments labeled "Low", "Middle", and "High". A green "Confirm" button is located at the bottom right of the form.

5. For subsequent logins, you only need to enter the username and password that you have set to log in.

Note:

If the login window does not appear, please refer to [FAQ > Q3. I cannot log into the AP device's web management page, what can I do?](#)

Chapter 4

Set Up Wireless Connections

This chapter introduces how to connect your AP device to the wireless network. The AP device is equipped with a web-based Quick Setup wizard. You can also set up the wireless connection by the WPS feature or manually add a wireless connection.

This chapter contains the following sections:

- *Quick Setup*
- *WPS*
- *Manually set up a wireless connection*
- *Check the connection status*

4.1. Quick Setup

Quick Setup wizard allows you to quickly configure your AP device step by step. Choose the suitable operation mode according to your network environment and follow the step-by-step instructions.

1. Visit <http://tplinkap.net>, and log in with the username and password you set for the AP device.
2. Go to [Quick Setup](#) on the top of the page, and follow the on-screen instructions to configure your AP device.

4.2. WPS

WPS (Wi-Fi Protected Setup) feature can help you to quickly and securely connect to a network. WPS functions differently in different operation modes. In Access Point and Multi-SSID modes, the WPS feature can be used only when the network security is set to None or WPA2-PSK/AES. In Repeater/Bridge and Client modes, this device can use WPS (Push button method) to connect to Host network while local wireless networks do not support the WPS feature.

This section will guide you to add a new wireless device to an existing network quickly by the WPS feature. There are two ways to use this feature: by push button method and by PIN (Personal Identification Number). The PIN method can only be applied in Access Point and Multi-SSID modes.

Push Button Method

Follow the steps below to use WPS by push button method.

1. Press the WPS button on the real panel of the AP device. The WPS LED will blink slowly, which shows the function has been triggered and the device is trying to connect or to be connected. This process may take up to 2 minutes.

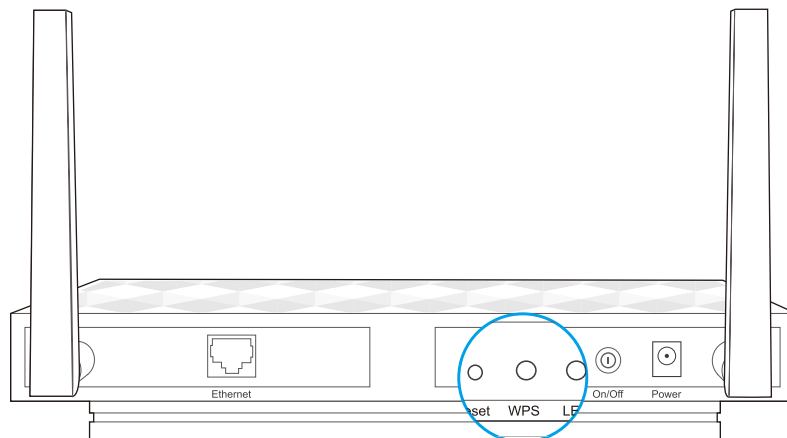

2. Press the WPS button of the device you want to connect to in 2 minutes.

Note:

The order to press the WPS button of the AP device and the device to be connected can be in reverse.

3. If the AP device's WPS LED is solid on, it shows the WPS connection is successful. If the AP device's WPS LED blinks quickly, it shows the WPS connection is failed. Please perform the steps again.

Note:

1. If the WPS connection is successful, after about 5 minutes, the WPS LED will turn off.
2. If the connection still fails, contact the technical support.

PIN Method

Other devices can connect to this AP device by WPS with the AP device's PIN and the AP device can connect to other devices by entering their PINs. The PIN method can only be applied in Access Point and Multi-SSID modes.

The screenshot shows a web interface for WPS configuration. At the top, the title is "WPS" with a green question mark icon. Below the title, there are three sections:

- Enable WPS:** A toggle switch is currently set to "On".
- Device's PIN:** A toggle switch is currently set to "On". Below it, the "Device's PIN" is displayed as "12345670". There are two buttons: "Generate" and "Default".
- WPS Wizard:** A section with the heading "WPS Wizard". It contains a "Select a setup method:" label followed by two radio buttons: "Push Button (Recommended)" (which is selected) and "PIN". Below this, there is a line of text: "Press the physical WPS button on the device or click the Connect button on this page." At the bottom of this section is a blue "Connect" button.

Follow the steps below to use WPS by PIN method.

1. Visit <http://tplinkap.net>, then log in with the username and password you set for the AP device.
2. Go to [Advanced](#) > [Wireless](#) > [WPS](#). There are also two ways to use WPS PIN method: using the AP device's PIN and using the wireless client's PIN.

➤ Using the AP Device's PIN

- 1) Toggle On [Enable Device's PIN](#) to allow wireless clients to connect to the device using the Device's PIN.
- 2) Click [Generate](#) to generate a new PIN randomly or click [Default](#) to restore the current PIN to the factory default PIN. Using this PIN to connect to the AP device. The default PIN can be found on the label of the AP device.

➤ Using the wireless client's PIN

- 1) Select the [PIN](#) as the setup method.

- 2) Entering the wireless client's WPS PIN into [Enter the client's WPS PIN](#) field and click [Connect](#).

📌 Note:

Selecting [Push button method \(Recommended\)](#) is equal to pressing the physical WPS button on the device.

4.3. Manually set up a wireless connection

Follow the steps below to check or modify your wireless connection settings.

1. Visit <http://tplinkap.net>, then log in with the username and password you set for the AP device.
2. Go to [Advanced](#) > [Wireless](#) > [Basic Settings](#).

Basic Settings 2.4GHz | 5GHz

2.4GHz Wireless: Enable Wireless Radio

Wireless Network Name (SSID): Hide SSID

Mode: ▼

Channel Width: ▼

Channel/Frequency: ▼

Security: ▼

Version: Auto WPA-PSK WPA2-PSK

Encryption: Auto AES TKIP

Password:

Group Key Update Period:

3. Select the [Operation mode](#) from the drop-down list.

➤ **Access Point Mode**

If Access Point mode is selected, please take the following steps:

Basic Settings 2.4GHz | 5GHz

2.4GHz Wireless: Enable Wireless Radio

Wireless Network Name (SSID): Hide SSID

Mode:

Channel Width:

Channel/Frequency:

Security:

Version: Auto WPA-PSK WPA2-PSK

Encryption: Auto AES TKIP

Password:

Group Key Update Period:

- 1) Select the wireless network [2.4GHz](#) or [5GHz](#). Here we take [2.4GHz](#) for demonstration.
- 2) The wireless radio is enabled by default. Customize the [Wireless Network Name \(SSID\)](#) and [Security](#) settings. The AP device provides four security options, None, WPA/WPA2 - Personal, WPA/WPA2 - Enterprise and WEP. The default WPA/WPA2 - Personal is recommended. Enter a [Password](#) below to prevent unauthorized access to your AP device.

Note:

1. It is recommended to keep the default settings for other parameters. If it is necessary to change the related parameters, please refer to the help page.
2. Tick [Hide SSID](#) if you want to hide this wireless network name.

- 3) Click [Save](#) to save all your settings.

In addition

- [Mode](#) - Select the transmission mode for your wireless client devices, [802.11b/g/n mixed](#), [802.11g/n mixed](#) or [802.11n only](#) for [2.4GHz](#) and [802.11a/n/ac mixed](#), [802.11n/ac mixed](#) or [802.11ac only](#) for [5GHz](#). It is recommended to keep the default settings.
- [Channel Width](#) - Select a channel width for the wireless network, [40MHz](#) or [20MHz](#) for [2.4GHz](#) and [80MHz](#), [40MHz](#) or [20MHz](#) for [5GHz](#).
- [Channel/Frequency](#) - Select an operating channel for the wireless network. The default channel is [Auto](#), which finds the best channel available automatically. It is recommended to leave the channel to [Auto](#) if you are not experiencing the intermittent wireless connection issue.

➤ Repeater/Bridge Mode

If Repeater/Bridge mode is selected, please take the following steps:

Basic Settings

Wireless: 2.4GHz 5GHz

Host SSID: Wireless Scanner

Host MAC Address: Lock to AP

Security: ▼

Save

Extended Wireless Settings 2.4GHz | 5GHz

2.4GHz Wireless: Enable Wireless Radio

Wireless Network Name (SSID): Same as Host AP Hide SSID

Security: ▼

Version: Auto WPA-PSK WPA2-PSK

Encryption: Auto AES TKIP

Password:

Group Key Update Period:

Save

- 1) Select the wireless network **2.4GHz** or **5GHz** to connect. Here we take **2.4GHz** for demonstration.
- 2) Enter the exact same wireless settings of the Host network that you want to connect to. Or click **Wireless Scanner** and choose a Host network from the list. Once a network is selected, its SSID, MAC address and security settings (except the password) will be automatically filled in the respective fields. If the selected network is protected, enter the password.
- 3) Click **Save** to save the settings.
- 4) Select the wireless network **2.4GHz** or **5GHz** to configure the extended wireless settings. Here we take **2.4GHz** for demonstration.
- 5) The wireless radio is enabled by default. Customize the **Wireless Network Name (SSID)** and **Security** settings. The AP device provides four security options, None, WPA/WPA2 - Personal, WPA/WPA2 - Enterprise and WEP. The default WPA/WPA2 - Personal is recommended. Enter a **Password** below to prevent unauthorized access to your AP device.

Note:

1. If you want to automatically copy the same SSID and security settings as the Host AP, click the [Same as Host AP](#) button .
2. If you want to hide this wireless network name, tick [Hide SSID](#).

6) Click [Save](#) to save the settings.

➤ Client Mode

If Client mode is selected, please take the following steps:

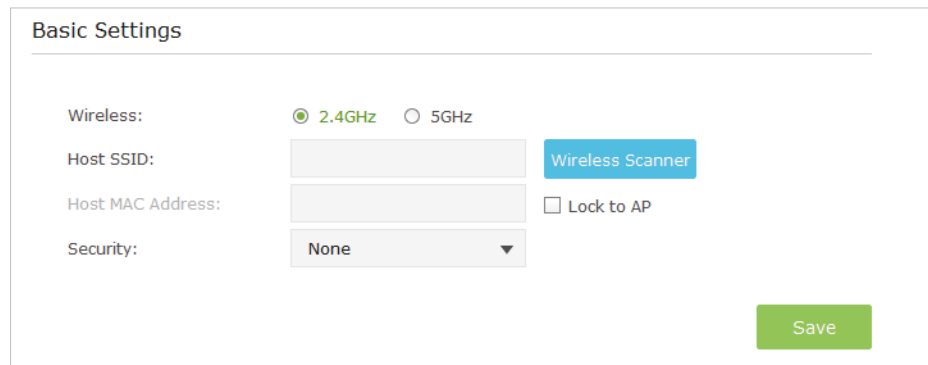

The screenshot shows a 'Basic Settings' form with the following elements:

- Wireless:** Radio buttons for 2.4GHz (selected) and 5GHz.
- Host SSID:** A text input field with a blue 'Wireless Scanner' button to its right.
- Host MAC Address:** A text input field with a 'Lock to AP' checkbox to its right.
- Security:** A dropdown menu currently showing 'None'.
- Save:** A green button at the bottom right of the form.

- 1) Select the wireless network [2.4GHz](#) or [5GHz](#) to connect. Here we take [2.4GHz](#) for demonstration.
- 2) Enter the exact same wireless settings of the Host network that you want to connect to. Or click [Wireless Scanner](#) and choose a Host network from the list. Once a network is selected, its SSID, MAC address and security settings (except the password) will be automatically filled in the respective fields. If the selected network is protected, enter the password.
- 3) Click [Save](#) to save the settings.

➤ Multi-SSID Mode

If Multi-SSID mode is selected, please take the following steps:

Basic Settings 2.4GHz | 5GHz

SSID Name	Hide SSID	VLAN ID	Security	Status	Modify
TP-LINK_7AFF_1	Disabled	1	WPA/WPA2-Personal		
TP-LINK_7AFF_2	Disabled	1	WPA/WPA2-Personal		
TP-LINK_7AFF_3	Disabled	1	WPA/WPA2-Personal		
TP-LINK_7AFF_4	Disabled	1	WPA/WPA2-Personal		

Mode:

Channel Width:

Channel/Frequency:

- 1) The list will show the information of the Multi-SSID. The icon means this SSID is enabled, and you can click it to disable. While the icon means this SSID is disabled, and you can click it to enable.
- 2) Click the icon to modify the SSID, VLAN ID, wireless security and other settings of the corresponding network.

TP-LINK_7AFF_1	Disabled	1	WPA/WPA2-Personal		
SSID Name:	<input type="text" value="TP-LINK_7AFF_1"/>	<input type="checkbox"/> Hide SSID	VLAN ID:	<input type="text" value="1"/>	
Security:	<input type="text" value="WPA/WPA2-Personal"/>		Version:	<input type="radio"/> Auto <input type="radio"/> WPA-PSK <input checked="" type="radio"/> WPA2-PSK	
Encryption:	<input type="radio"/> Auto <input checked="" type="radio"/> AES <input type="radio"/> TKIP		Password:	<input type="text" value="12345670"/>	
Group Key Update Period:	<input type="text" value="86400"/>				
				<input type="button" value="Cancel"/>	<input type="button" value="OK"/>

Note:

Tick [Hide SSID](#) if you want to hide this wireless network name.

- 3) Click **OK** to save the settings.

4.4. Check the connection status

After finishing the configuration, please go to *Advanced* > *Status* to check the connection status. Here we take Access Point mode as a demonstration. The status page of other modes are different. Click each element of the topology, its status will show below.

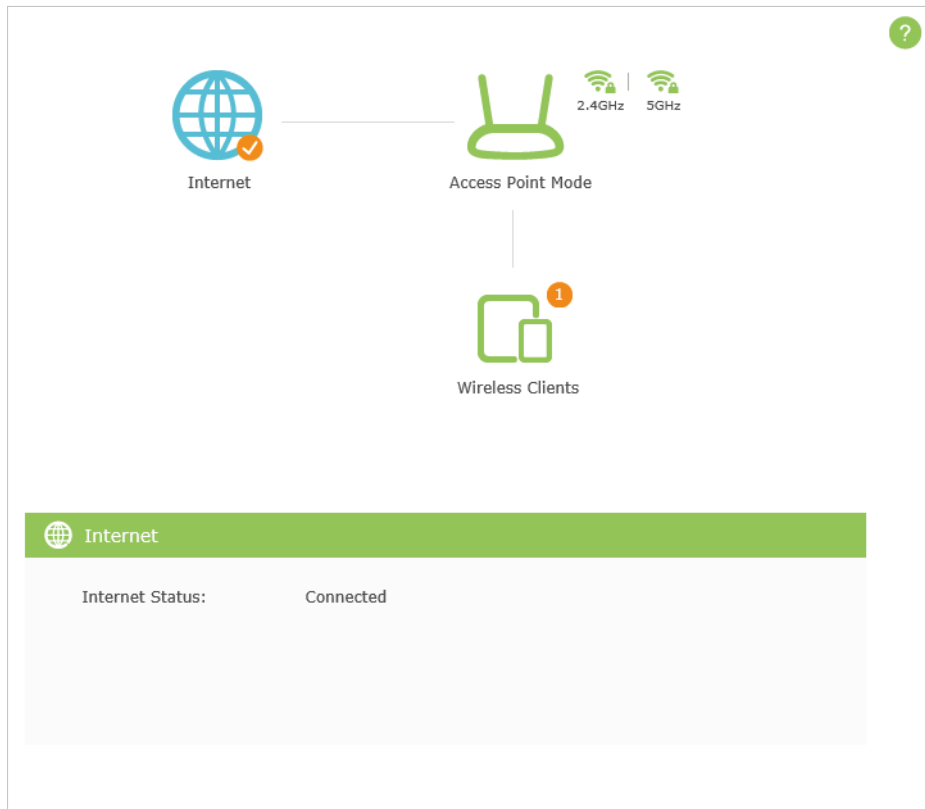

Chapter 5

Customize Your Network and Security Settings

This chapter guides you on how to configure advanced network and security settings that are available for this AP device.

This chapter contains the following sections:

- *Change the LAN Settings*
- *Specify DHCP Server Settings*
- *MAC Filtering*
- *Advanced Wireless Settings*

5.1. Change the LAN Settings

The AP device is preset to [Obtain an IP address automatically](#), which allows the device to dynamically obtain an IP address and gateway from the main router/AP. You just need to enter <http://tplinkap.net> into the address bar to log into the web-based management page. It is recommended to keep the default LAN settings to avoid IP conflict with the main router/AP or other device on your local network. If it is necessary to change the LAN settings, for example, your network requires a specific IP subnet, please perform the following steps.

1. Visit <http://tplinkap.net>, and log in with the username and password you set for the AP device.
2. Go to [Advanced](#) > [Network](#) > [LAN](#) page.



LAN Settings

Obtain an IP address automatically

Use the following IP address

IP Address:

Subnet Mask:

Default Gateway: (Optional)

Save

3. Select [Use the following IP address](#) option and type in a new IP Address appropriate to your needs.
4. Leave the [Subnet Mask](#) and [Default Gateway](#) as it is.
5. Click [Save](#).

Note:

After changing the IP address, you should enter the new IP address or use the domain name tplinkap.net to log into the web-based management page.

5.2. Specify DHCP Server Settings

By default, the DHCP (Dynamic Host Configuration Protocol) Server is set to [Auto](#). If the DHCP server of the host router/AP is disabled, the device's DHCP server will automatically assign valid IP addresses to clients. If the DHCP server of the host router/AP is enabled, the device's DHCP server will be unable to avoid IP conflict. You can switch [On](#) (enable) or [Off](#) (disable) the DHCP server. If [Off](#) is selected and there is no other DHCP server within your LAN, you have to configure the IP address for each client manually.

➤ DHCP Settings

1. Visit <http://tplinkap.net>, and log in with the username and password you set for the AP device.
2. Go to [Advanced](#) > [Network](#) > [DHCP Server](#).

DHCP Settings

DHCP Server: Auto On Off

IP Address Pool: 192.168.0.100 - 192.168.0.199

Address Lease Time: 1 (1-2880) minutes

Default Gateway: 192.168.0.254 (Optional)

Primary DNS: 0.0.0.0 (Optional)

Secondary DNS: 0.0.0.0 (Optional)

Save

3. Switch [On](#) the [DHCP server](#).
4. Enter the starting and ending IP address in the [IP Address Pool](#).
5. Enter other parameters if the ISP offers, the Default Gateway is automatically filled which is the same as the LAN IP address of the AP device.
6. Click [Save](#).

➤ Check the DHCP Clients

1. Visit <http://tplinkap.net>, and log in with the username and password you set for the AP device.
2. Go to [Advanced](#) > [Network](#) > [DHCP Client List](#) to check the DHCP Client List.

DHCP Client List

Total Clients: 0

ID	Client Name	MAC Address	Assigned IP Address	Leased Time
--	--	--	--	--

➤ To reserve an IP address for a specified client device:

1. Visit <http://tplinkap.net>, and log in with the username and password you set for the AP device.
2. Go to [Advanced](#) > [Network](#) > [IP Address Reservation](#).
3. Click [Add](#).

IP Address Reservation

+ Add - Delete

<input type="checkbox"/>	ID	MAC Address	Reserved IP Address	Status	Modify
<input type="checkbox"/>	--	--	--	--	--

MAC Address: [View Devices](#)

Reserved IP Address:

Enable this entry

[Cancel](#) [OK](#)

4. Click [View Devices](#) or enter the MAC address of the client device.
5. Enter the IP address to set to the client device.
6. Select the [Enable this entry](#) checkbox.
7. Click [OK](#).

The IP address reservation is configured successfully, and you can see the rule shown as below.

IP Address Reservation

+ Add - Delete

<input type="checkbox"/>	ID	MAC Address	Reserved IP Address	Status	Modify
<input type="checkbox"/>	1	BC-6C-21-07-5D-DE	192.168.0.140	💡	✎ 🗑️

5.3. MAC Filtering

MAC Filtering is used to allow or block specific client devices from accessing your network. When a device is blocked, it is unable to connect to the Internet through your network or communicate with other devices in the LAN.

To use MAC Filtering, enable this function and specify a blacklist or whitelist. If MAC Filtering is disabled (Off), all devices, including the blacklisted ones, are allowed to access your network.

1. Visit <http://tplinkap.net>, and log in with the username and password you set for the AP device.
2. Go to [Advanced](#) > [Network](#) > [MAC Filtering](#) and toggle on the MAC filtering function.

MAC Filter ?

MAC Filter: On

Filter Rules

Select the Filter Rule:

Blacklist (Devices in this list are NOT allowed to access your network.)

Whitelist (Devices in this list are allowed to access your network.)

[Save](#)

Devices in Black List

[+ Add](#) [- Delete](#)

<input type="checkbox"/>	ID	MAC Address	Description	Status	Modify
--	--	--	--	--	--

3. Select the filtering rule: [Blacklist](#) or [Whitelist](#).

➤ **To add a device to a blacklist or whitelist**

1) Click [Add](#).

Devices in Black List

[+ Add](#) [- Delete](#)

<input type="checkbox"/>	ID	MAC Address	Description	Status	Modify
--	--	--	--	--	--

MAC Address: [View Devices](#)

Description:

Enable this Entry



[Cancel](#) [OK](#)

2) Enter the [MAC address](#) of the device or click [View Devices](#) button to choose the device that you want to add in the blacklist or whitelist from the [Access Devices List](#).

3) Enter a brief description of the device.

- 4) Select the [Enable this Entry](#) checkbox.
- 5) Click [OK](#).

➤ **To modify or delete a device from the Blacklist or Whitelist**

In the Blacklist or Whitelist, click the modify icon  or the delete  icon that corresponds to the device that you wish to modify or delete.

Devices in Black List						
					 Add	 Delete
<input type="checkbox"/>	ID	MAC Address	Description	Status	Modify	
<input type="checkbox"/>	1	74-D4-35-98-3F-DF	a		 	

➤ **To delete multiple devices from the Blacklist or Whitelist**

In the Blacklist or Whitelist, select the corresponding checkboxes of the devices to be deleted and click [Delete](#) above the table.

Devices in Black List						
					 Add	 Delete
<input type="checkbox"/>	ID	MAC Address	Description	Status	Modify	
<input checked="" type="checkbox"/>	1	74-D4-35-98-3F-DF	a		 	

5.4. Advanced Wireless Settings

It is recommended to keep the default settings of the advanced wireless settings. If it is necessary to change them, please perform the following steps.

1. Visit <http://tplinkwifi.net>, and log in with the username and password you set for the AP device.
2. Go to [Advanced](#) > [Wireless](#) > [Advanced Settings](#).

Advanced Settings 2.4GHz | 5GHz ?

Beacon Interval:	<input type="text" value="100"/>	(40-1000)
DTIM Period:	<input type="text" value="1"/>	(1-15)
RTS Threshold:	<input type="text" value="2346"/>	(1-2346)
Fragmentation Threshold:	<input type="text" value="2346"/>	(256-2346)
AP Isolation:	<input type="checkbox"/> Enable	
Short GI:	<input checked="" type="checkbox"/> Enable	
WMM:	<input checked="" type="checkbox"/> Enable	

3. Choose the **2.4Ghz** or **5GHz** of the wireless network.

- **Beacon Interval** - Enter a time interval between 40 and 1000 in milliseconds to determine the duration between beacon packets that are transmitted periodically by the device to synchronize the wireless network. The default is 100 milliseconds.
- **DTIM** - This value determines the interval of the Delivery Traffic Indication Message (DTIM). You can specify the value between 1 and 15 Beacon Intervals. The default value is 1, which indicates the DTIM Period is the same as Beacon Interval.
- **RTS Threshold** - Enter a value between 1 and 2346 to determine the packet size of data transmitted through the network. By default, the RTS (Request to Send) Threshold size is 2346. If the packet size is greater than the preset threshold, the device sends Request to Send frames to a particular receiving station and negotiates the sending of a data frame, or else the packet will be sent immediately.
- **Fragmentation Threshold** - Specify the maximum packet size (in bytes) transmitted through the network. If a packet size exceeds the fragmentation threshold, the packet will be fragmented into multiple packets. Note that setting the fragmentation threshold too low may result in poor network performance because of excessive packets. The default and recommended setting is 2346 bytes.
- **AP Isolation** - Select this checkbox to enable the AP Isolation feature that allows you to confine and restrict all wireless devices on your network from interacting with each other, but still able to access the Internet. AP isolation is disabled by default.
- **Short GI** - This function is enabled by default and recommended to increase the data capacity by reducing the Guard Interval (GI) time.

- [WMM](#) - This function guarantees the packets with high-priority messages being transmitted preferentially. It is enabled by default and highly recommended.

4. Click [Save](#).

Chapter 6

Manage Your AP Device

This chapter will show you how to configure and manage your AP device. This chapter includes the following sections:

- *System Log*
- *Test the Network Connectivity*
- *Upgrade the Firmware*
- *Backup and Restore Configuration Settings*
- *Change the Management Account*
- *Throughput Monitor*
- *Statistics*
- *SNMP Management*
- *Ping Watchdog*
- *LEDs Control*

6.1. System Log

The System Log page displays a list of the most recent activities (events) of the network. You can define the type of logs and/or the level of logs you want to view. You can also export the log files to a computer. When the AP device does not work properly, you can save the system log and send it to the technical support for troubleshooting.

➤ To Save the System Log in Local:

1. Visit <http://tplinkap.net>, and log in with the username and password you set for the AP device.
2. Go to *Advanced* > *System Tools* > *System Log*.

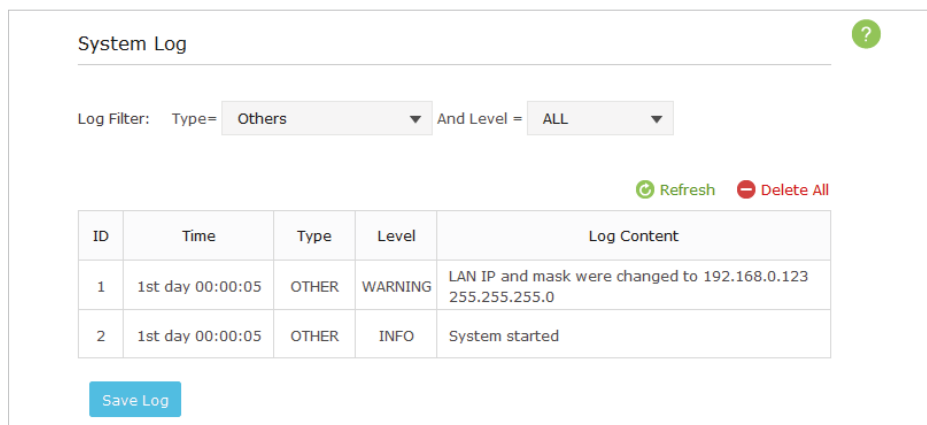

3. Choose the type and level of the system log according to your need.

4. Click [Save Log](#) to save the system log to local.

☞ Tips:

You can use the email to send the saved system log to the technical support for troubleshooting.

Click [Refresh](#) to renew the system log list or click [Delete all](#) to delete all the system logs.

6.2. Test the Network Connectivity

Diagnostics is used to test the connectivity between the AP device and the host or other network devices.

The device provides Ping and Traceroute tools to help you troubleshoot network connectivity problems. The Ping tool sends packets to a target IP address and logs the results, such as the number of packets sent/received, and the round-trip time. The Traceroute tool sends packets to a target IP address and displays the number of hops and time to reach the destination. You can ping and traceroute a local device by its IP address.

1. Visit <http://tplinkwifi.net>, and log in with the username and password you set for the AP device.
2. Go to *Advanced* > *System Tools* > *Diagnostics*.

Diagnostic Tools

Diagnostic Tools: Ping Traceroute

IP Address: 192.168.0.152

Ping Count: 4 (1-50)

Ping Timeout: 800 (100-2000) milliseconds

Ping Packet Size: 64 (4-1472) bytes

Start

➤ **To diagnose using Ping**

- 1) Choose **Ping** as the diagnostic tool to test the connectivity.
- 2) Enter the target **IP Address** of the tested host.
- 3) Specify the **Ping Count**, **Ping Timeout** and **Ping Packet Size**. (Optional)
- 4) Click **Start**.

The figure below indicates the proper connection between the device and the IP address 192.168.0.123 tested through **Ping**.

```

Ping 192.168.0.123 with 64 bytes of data:
Reply from 192.168.0.123 bytes=64 time=1ms TTL=64 seq=1
Reply from 192.168.0.123 bytes=64 time=1ms TTL=64 seq=2
Reply from 192.168.0.123 bytes=64 time=1ms TTL=64 seq=3
Reply from 192.168.0.123 bytes=64 time=1ms TTL=64 seq=4
Ping statistics for 192.168.0.123
    Packets: Sent = 4 Received = 4 Lost = 0
    Approximate round trip times in milliseconds:
        Minimum = 1 Maximum = 1 Average = 1
  
```

➤ **To diagnose using Traceroute**

- 1) Choose **Traceroute** as the diagnostic tool to test the connectivity.

The screenshot shows a web interface titled "Diagnostic Tools" with a help icon in the top right. Under "Diagnostic Tools:", there are two radio buttons: "Ping" (unselected) and "Traceroute" (selected). Below this, the "IP Address:" field contains "192.168.0.152". The "Traceroute Max TTL:" field contains "5" with a range "(1-30)" to its right. A large dashed box represents the output area, which is currently empty. A blue "Start" button is located at the bottom left of the interface.

- 2) Enter the target [IP Address](#) of the tested host.
- 3) Specify the number of hops (to be reached) in the [Traceroute Max TTL](#) (Time to Live) field. The default is 20. (Optional)
- 4) Click [Start](#).

The figure below indicates the proper connection between the AP device and the IP address 192.168.0.123 tested through [Traceroute](#).

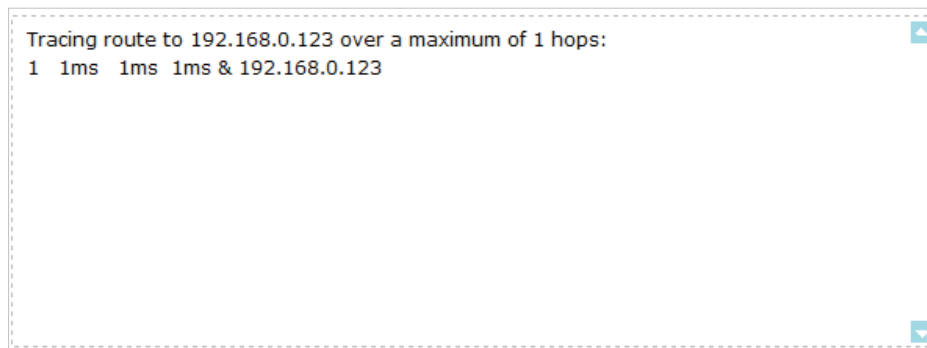

6.3. Upgrade the Firmware

TP-LINK is dedicated to improving and enriching the product features, giving you a better network experience. We will release the latest firmware at TP-LINK official website, you can download the latest firmware file from the [Support](#) page of our website www.tp-link.com and upgrade the firmware to the latest version.

Note:

1. Make sure the latest firmware file matches with the hardware version (as shown in the webpage).
2. Make sure that you have a stable connection between the AP device and your computer. It is NOT recommended to upgrade the firmware wirelessly.

3. Back up your AP device configuration.
4. Do NOT turn off the AP device during the firmware upgrade.

Follow the steps to upgrade the firmware.

1. Download the latest firmware file for the AP device from our website www.tp-link.com.
2. Visit <http://tplinkap.net>, and log in with the username and password you set for the AP device.
3. Go to [Advanced](#) > [System Tools](#) > [Firmware Upgrade](#).

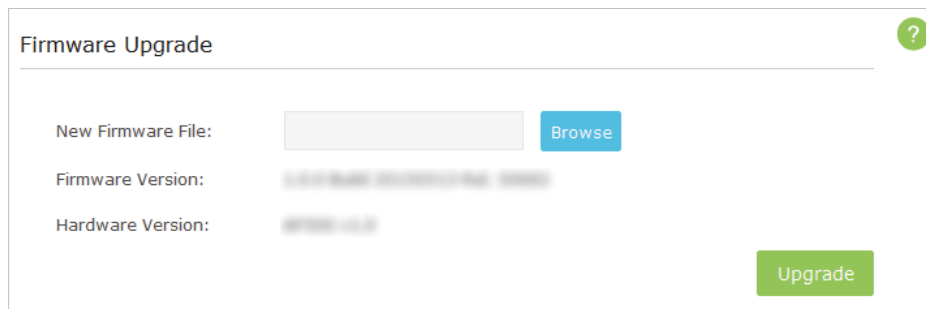

4. Click [Browse](#) to locate the downloaded new firmware file, and click [Upgrade](#).
5. Wait a few moments for the upgrading and rebooting.

6.4. Backup and Restore Configuration Settings

The configuration settings are stored as a configuration file in the AP device. You can backup the configuration file to your computer for future use and restore the AP device to a previous settings from the backup file when needed. Moreover, if necessary you can erase the current settings and reset the AP device to the default factory settings.

1. Visit <http://tplinkap.net>, and log in with the username and password you set for the AP device.
2. Go to [Advanced](#) > [System Tools](#) > [Backup & Restore](#).

➤ To backup configuration settings:

It is highly recommended to back up your current configurations in case a recovery is needed to restore the system to a previous state or from the factory defaults.

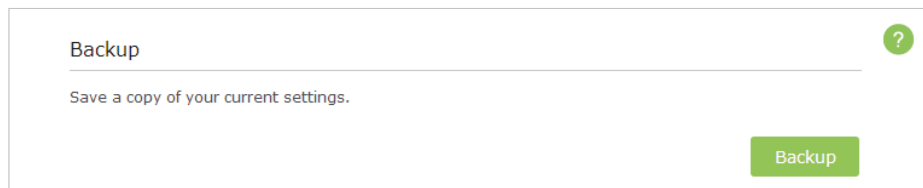

Click [Backup](#) to save a copy of the current settings to your local computer. A '.bin' file of the current settings will be stored to your computer. Make sure to save the backup file to a safe location that you can retrieve and restore the device later, if needed.

➤ **To restore configuration settings:**

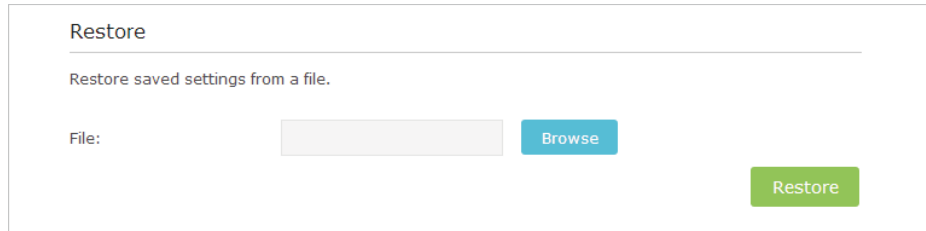

- 1) Click [Browse](#) to locate the backup configuration file stored on your computer, and click [Restore](#).
- 2) Wait a few moments for the restoring and rebooting.

📌 **Note:** During the restoring process, do not turn off or reset the AP device.

➤ **To reset the AP device to factory default settings:**



- 1) Click [Factory Restore](#) to reset the router.
- 2) Wait a few moments for the reset and reboot.

📌 **Note:**

1. During the resetting process, do not turn off the AP device.
2. We strongly recommend you back up the current configuration settings before resetting the AP device.

6.5. Change the Management Account

The account management feature allows you to change your login username and password of the web-based management page.

1. Visit <http://tplinkap.net>, and log in with the username and password you set for the AP device before.
2. Go to [Advanced](#) > [System Tools](#) > [Account Management](#) and complete the settings in [Account Management](#) section.

Account Management ?

Current Username:

Current Password:

New Username:

New Password:

Low
 Middle
 High

Confirm Password: ✔

3. Enter the current username and password.
4. Enter the new username and the new password twice (both case-sensitive). Click [Save](#).

Use the new username and password for subsequent logins.

🔗 **Tips:** Please write down the new login information in a secure place in case you forget it.

6.6. Throughput Monitor

The throughput chart displays the current data traffic of the network. The curves in different colors represent the received (RX) and transmitted (TX) rates of the 2.4GHz and 5GHz frequencies respectively. You can choose to view individual or multiple data rates by selecting the corresponding checkbox.

1. Visit <http://tplinkap.net>, and log in with the username and password you set for the AP device.
2. Go to [Advanced](#) > [Wireless](#) > [Throughput Monitor](#).

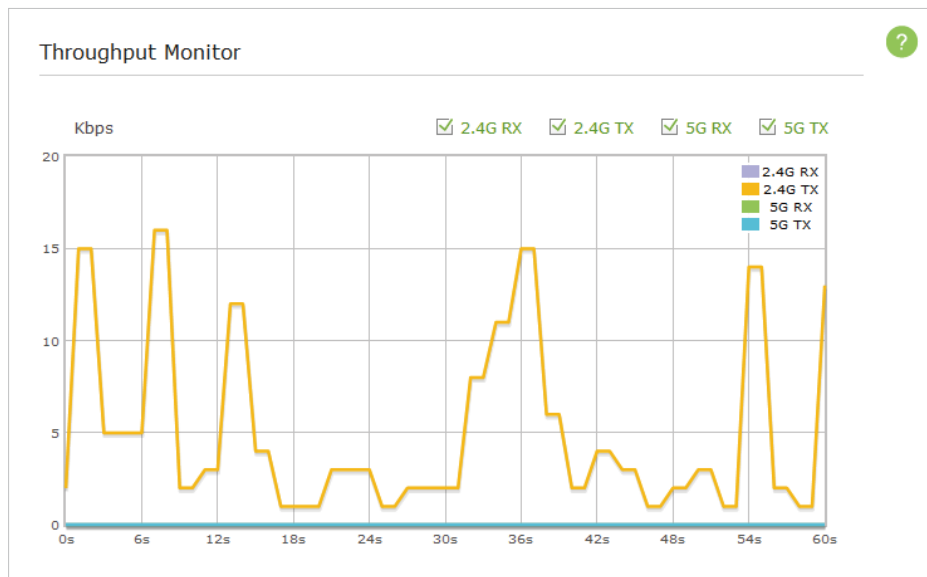

3. Select the corresponding checkbox (2.4G RX, 2.4G TX, 5G RX and 5G TX) to view individual or multiple data rates.

6.7. Statistics

The Statistics page displays the network traffic of wireless stations sent and received, and allows you to monitor the volume of wireless traffic statistics.

1. Visit <http://tplinkap.net>, and log in with the username and password you set for the AP device.
2. Go to *Advanced* > *Wireless* > *Statistics*.

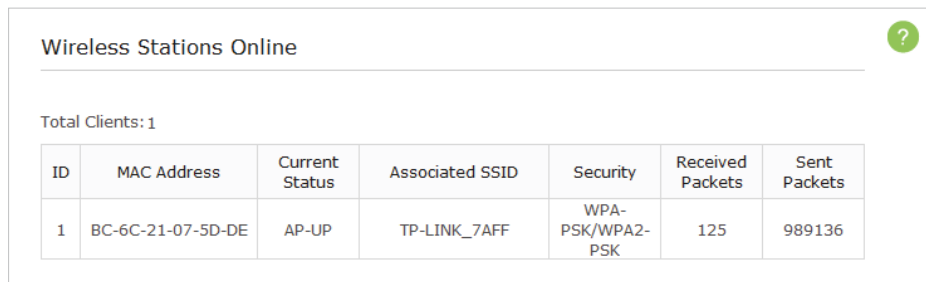

The screenshot shows the 'Wireless Stations Online' section of a web interface. It includes a title bar with a question mark icon, a 'Total Clients: 1' indicator, and a table with the following data:

ID	MAC Address	Current Status	Associated SSID	Security	Received Packets	Sent Packets
1	BC-6C-21-07-5D-DE	AP-UP	TP-LINK_7AFF	WPA-PSK/WPA2-PSK	125	989136

3. Monitor the traffic statistics in *Wireless Stations Online* section.

6.8. SNMP Management

SNMP (Simple Network Management Protocol) is a popular network monitoring and management protocol.

1. Visit <http://tplinkap.net>, and log in with the username and password you set for the AP device.
2. Go to *Advanced* > *System Tools* > *SNMP* and complete the settings according to your needs.

Simple Network Management Protocol

SNMP Agent: Enable

SysContact:

SysName:

SysLocation:

Get Community: public

Get Source: 0.0.0.0

Set Community: private

Set Source: 0.0.0.0

Save

3. Select the [SNMP Agent](#) checkbox to enable (or deselect to disable) the SNMP feature.
4. Enter the contact email address in [SysContact](#) field, a user-defined name in [SysName](#) field and the physical location in [SysLocation](#) of the node to be managed.
5. Enter the community name in [Get Community](#) field that allows read-only access to the device's SNMP information. The community name is considered as a group password. The default setting is [public](#).
6. Enter the IP address or subnet in [Get Source](#) field that management systems can read information from this 'get' community.
7. Enter the community name in [Set Community](#) field that allows read/write access to the device's SNMP information. The community name can be considered as a group password. The default setting is private.
8. Enter the IP address or subnet in [Set Source](#) field that management systems can read and write to this 'set' community.
9. Click [Save](#).

Note:

A restricted source can be a specific IP address (e.g. 10.10.10.1), or a subnet - represented as IP/BITS (e.g. 10.10.10.0/24). If 0.0.0.0 is specified as the IP address, the agent will accept all requests under the corresponding community name.

6.9. Ping Watchdog

The Ping Watchdog feature allows you to continuously ping a specific remote host for connection status using a user-defined IP address (or an Internet gateway). If it is unable to ping the target IP address under the user-defined constraints, this device will automatically reboot.

1. Visit <http://tplinkap.net>, and log in with the username and password you set for the AP device.

- Go to *Advanced > System Tools > Ping Watchdog* and complete the settings according to your needs.

Ping Watchdog

Ping Watchdog: Enable

IP Address To Ping:

Ping Interval: (10-300) seconds

Startup Delay: (60-300) seconds



Fail Count To Reboot: (1-65535)

Save

- Select the **Ping Watchdog** checkbox to enable the function.
- Enter the IP address of the target host in **IP Address To Ping** field that you want to send ping packets to.
- Enter the time interval (in seconds) between two continuous ping packets in **Ping Interval** field.
- Enter the time delay (in seconds) before the first ping packet is sent out when the device is restarted in **Startup Delay** field.
- Enter a number of ping count(s) that the device can send continuously in **Fail Count To Reboot** field. If the value is exceeded, the device will restart automatically.
- Click **Save**.

6. 10. LEDs Control

The LEDs indicate AP device's activities and behavior. You can turn on or turn off the AP device's LEDs from the web-based management page.

- Visit <http://tplinkap.net>, and log in with the username and password you set for the AP device.
- Click the **LED On** or **LED Off** icon on the top right corner of the page. The icon  displays that the LEDs is on and you can click it to turn off the LEDs. The icon  displays that the LEDs is off and you can click it to turn on the LEDs.

FAQ

Q1. What can I do if I forgot my wireless password?

The default password is labeled at the back of the AP device. If the password has been altered, please connect the AP device to the computer using a cable and follow the steps below:

1. Visit <http://tplinkap.net>, and log in with the username and password you set for the AP device.
2. Go to [Advanced](#) > [Wireless](#) > [Basic settings](#). Locate the password on the page and mark it down for future use.

Q2. How to retrieve the username and password of the web management page?

The default username and password of the web management page are [admin](#) (in lower case). If the password has been altered, please follow the steps below:

1. Reset the router to factory default settings: with the device powered on, use a pin to press and hold the Reset button for five seconds until the Power LED starts blinking, then release the button;
2. Visit <http://tplinkap.net>;
3. Enter [admin](#) (in lower case) as both username and password to log in.

Note: You'll need to reconfigure the AP device. Please mark down your new password for future use.

Q3. I cannot log into the AP device's web management page, what can I do?

This can happen for a variety of reasons, please try the methods below and try again.

1. Make sure the AP device connects to the computer correctly and the corresponding LED indicator(s) light up.
2. Make sure the IP address of your computer is configured as [Obtain an IP address automatically](#) and [Obtain DNS server address automatically](#).
3. Make sure the <http://tplinkap.net> you input is right.
4. Check your computer's settings:
 - 1) Go to [Start](#) > [Control Panel](#) > [Network and Internet](#), and click [View network status and tasks](#);
 - 2) Click [Internet Options](#) on the bottom left;
 - 3) Click [Connections](#), select [Never dial a connection](#);

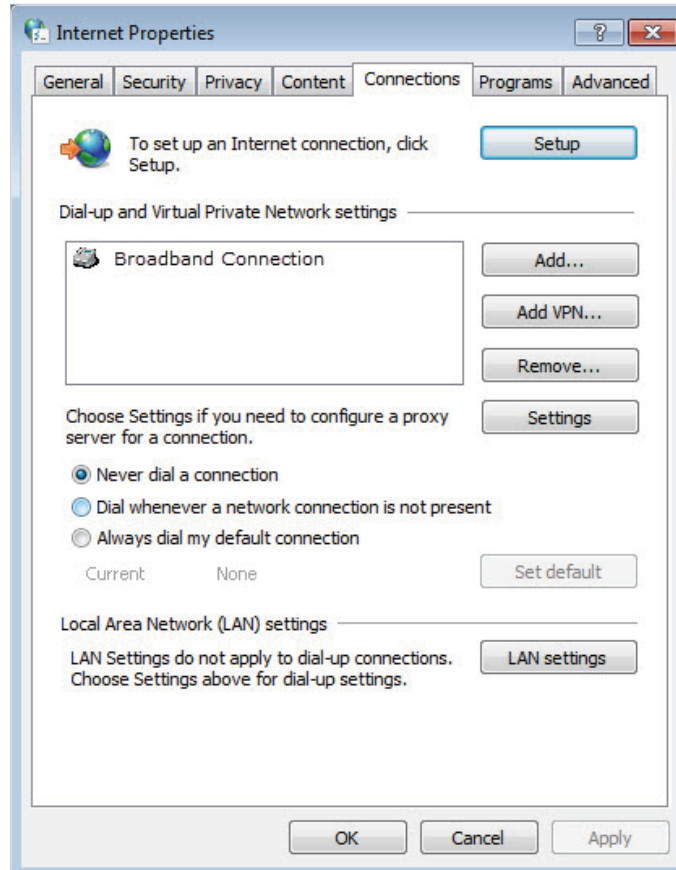

4) Click [LAN settings](#), deselect the following three options and click [OK](#);

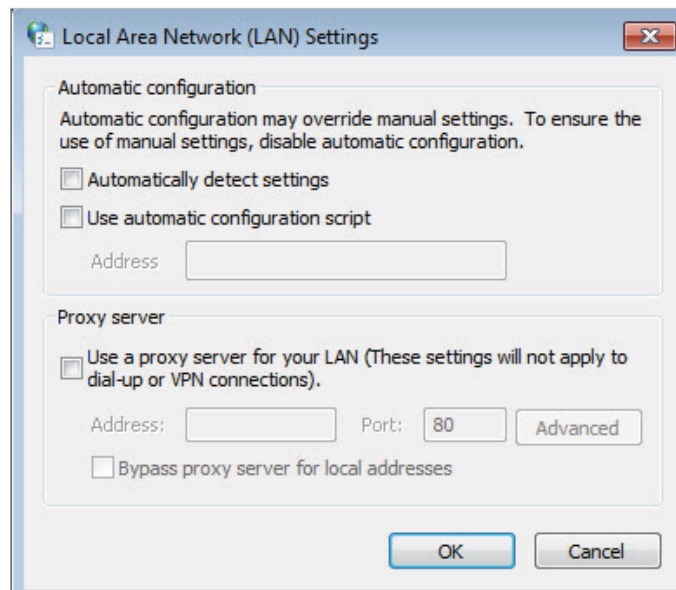

5) Go to [Advanced](#) > [Restore advanced settings](#), click [OK](#) to save the settings.

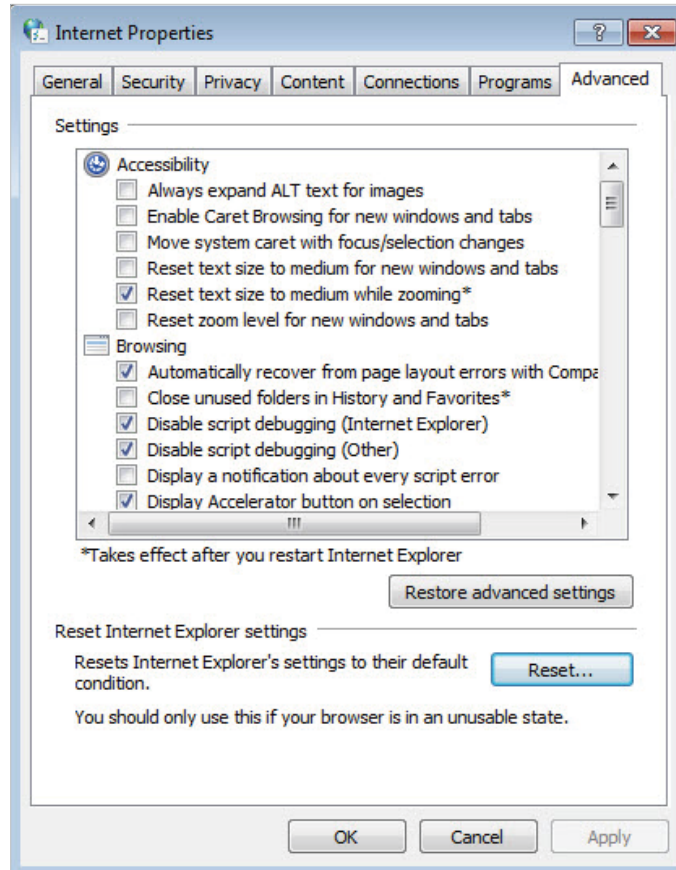

5. Change a web browser or computer and log in again.

6. Reset the AP device to factory default settings: use a pin to press and hold the Reset button for five seconds until the Power LED starts blinking, then release the button.

Note: Upon resetting, all previous configurations will be cleared, and the AP device will reset to the default AP Mode.

Open a web browser and log in again. If login still fails, please contact the technical support.

Q4. What can I do if the login window does not appear?

You can try the following methods to solve the problem:

- Change the computer's static IP address to obtain an IP address automatically.
- Verify if <http://tplinkap.net> or <http://192.168.0.254> is correctly entered in the web browser.
- Use another web browser and try again.
- Reboot your AP device and try again.
- Power off your host AP and enter <http://tplinkap.net> into the web browser to try again.

Q5. What can I do if my wireless is not stable?

It may be caused by too much interference, you can try the following methods:

- Set your wireless channel to a different channel.
- Move the AP device to a new location away from Bluetooth devices and other household electronics, such as cordless phone, microwave, and baby monitor, etc., to minimize signal interference.

Q6. What can I do to maximize my signal strength in Repeater/Bridge mode?

When choosing an ideal location to optimize wireless signal in Repeater/ Bridge mode, please use the following tips.

- **The Best Way is Halfway**

Generally, the ideal location for the repeater is halfway between your wireless router and your wireless clients. If that is not possible, place it closer to your wireless router to ensure stable performance.

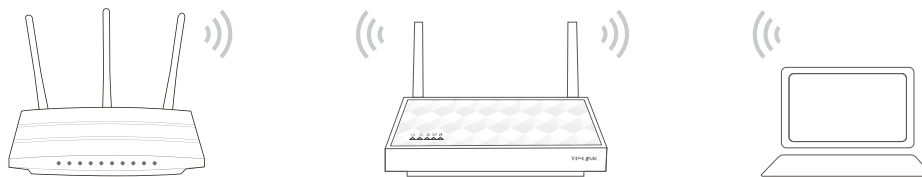

- **Less Obstacles Ensure Better Performance**

Choose a location with less obstacles that may block the signal between the AP device and the host network. An open corridor or a spacious location is ideal.

- **Less Interference Provides More Stability**

Choose a location away from Bluetooth devices and other household electronics, such as cordless phone, microwave, and baby monitor, etc., to minimize signal interference.

Specifications

Hardware	
Ethernet Ports	1 10/100/1000Mbps LAN port
Button	Reset Button, WPS Button, LED On/Off Button, Power On/Off Button
External Power Supply	12V/2A
Antenna	Two Dual Band Detachable Antennas
Wireless	
Wireless Standards	IEEE 802.11ac/n/a 5GHz, IEEE 802.11b/g/n 2.4GHz
Frequency	2.4GHz, 5GHz
Signal Rate	866Mbps at 5GHz, 300Mbps at 2.4GHz
Transmit Power	CE: <20dBm(2.4GHz), <23dBm(5GHz) FCC: <30dBm
Wireless Function	Enable/Disable Wireless Radio, WMM, Wireless Statistics
Wireless Security	64/128-bit WEP, WPA/WPA2, WPA-PSK/WPA-PSK2 encryptions
Software	
DHCP	Server, Client, DHCP Client List, Address Reservation
Quality of Service	WMM
Firewall Security	MAC Filtering
Protocols	Supports IPv4
Management	Account Management, SNMP
Environment	
Operating Temperature	0°C~40°C (32°F ~104°F)
Storage Temperature	-40°C~70°C (-40°F ~158°F)
Operating Humidity	10%~90% non-condensing
Storage Humidity	5%~95% non-condensing

COPYRIGHT & TRADEMARKS

Specifications are subject to change without notice. **TP-LINK** is a registered trademark of TP-Link Technologies Co., Ltd. Other brands and product names are trademarks or registered trademarks of their respective holders.

No part of the specifications may be reproduced in any form or by any means or used to make any derivative such as translation, transformation, or adaptation without permission from TP-Link Technologies Co., Ltd. Copyright © 2016 TP-Link Technologies Co., Ltd. All rights reserved.

FCC STATEMENT



This equipment has been tested and found to comply with the limits for a Class B digital device, pursuant to part 15 of the FCC Rules. These limits are designed to provide reasonable protection against harmful interference in a residential installation. This equipment generates, uses and can radiate radio frequency energy and, if not installed and used in accordance with the instructions, may cause harmful interference to radio communications. However, there is no guarantee that interference will not occur in a particular installation. If this equipment does cause harmful interference to radio or television reception, which can be determined by turning the equipment off and on, the user is encouraged to try to correct the interference by one or more of the following measures:

- Reorient or relocate the receiving antenna.
- Increase the separation between the equipment and receiver.
- Connect the equipment into an outlet on a circuit different from that to which the receiver is connected.
- Consult the dealer or an experienced radio/ TV technician for help.

This device complies with part 15 of the FCC Rules. Operation is subject to the following two conditions:

- 1) This device may not cause harmful interference.
- 2) This device must accept any interference received, including interference that may cause undesired operation.

Any changes or modifications not expressly approved by the party responsible for compliance could void the user's authority to operate the equipment.

Note: The manufacturer is not responsible for any radio or TV interference caused by unauthorized modifications to this equipment. Such modifications could void the user's authority to operate the equipment.

FCC RF Radiation Exposure Statement

This equipment complies with FCC RF radiation exposure limits set forth for an uncontrolled environment. This device and its antenna must not be co-located or operating in conjunction with any other antenna or transmitter.

"To comply with FCC RF exposure compliance requirements, this grant is applicable to only Mobile Configurations. The antennas used for this transmitter must be installed to provide a separation distance of at least 26cm from all persons and must not be co-located or operating in conjunction with any other antenna or transmitter."

This device is restricted in indoor environment only.

CE Mark Warning



This is a class B product. In a domestic environment, this product may cause radio interference, in which case the user may be required to take adequate measures.

RF Exposure Information

This device meets the EU requirements (1999/5/EC Article 3.1a) on the limitation of exposure of the general public to electromagnetic fields by way of health protection. The device complies with RF specifications when the device is used at 32cm from your body.

Restricted to indoor use.

Canadian Compliance Statement

This device complies with Industry Canada license-exempt RSS standard(s). Operation is subject to the following two conditions:

1. This device may not cause interference, and
2. This device must accept any interference, including interference that may cause undesired operation of the device.

Cet appareil est conforme aux normes CNR exemptes de licence d'Industrie Canada. Le fonctionnement est soumis aux deux conditions suivantes:

1. cet appareil ne doit pas provoquer d'interférences et
2. cet appareil doit accepter toute interférence, y compris celles susceptibles de provoquer un fonctionnement non souhaité de l'appareil.

This radio transmitter (IC: 8853A-AP300/ Model: AP300) has been approved by Industry Canada to operate with the antenna types listed below with the maximum permissible gain indicated. Antenna types not included in this list (Specifications), having a gain greater than the maximum gain indicated for that type, are strictly prohibited for use with this device.

Le présent émetteur radio (IC: 8853A-AP300/ Model: AP300) a été approuvé par Industrie Canada pour fonctionner avec les types d'antenne énumérés ci-dessous et ayant un gain admissible maximal. Les types d'antenne non inclus dans cette liste (Specifications), et dont le gain est supérieur au gain maximal indiqué, sont strictement interdits pour l'exploitation de l'émetteur.

Caution:

- 1) The device for operation in the band 5150–5250 MHz is only for indoor use to reduce the potential for harmful interference to co-channel mobile satellite systems;

- 2) For devices with detachable antenna(s), the maximum antenna gain permitted for devices in the band 5725-5850 MHz shall be such that the equipment still complies with the e.i.r.p. limits specified for point-to-point and non-point-to-point operation as appropriate; and

The high-power radars are allocated as primary users (i.e. priority users) of the bands 5250-5350 MHz and 5650-5850 MHz and that these radars could cause interference and/or damage to LE-LAN devices.

Avertissement:

- 1) Le dispositif fonctionnant dans la bande 5150-5250 MHz est réservé uniquement pour une utilisation à l'intérieur afin de réduire les risques de brouillage préjudiciable aux systèmes de satellites mobiles utilisant les mêmes canaux;
- 2) Le gain maximal d'antenne permis pour les dispositifs avec antenne(s) amovible(s) utilisant la bande 5725-5850 MHz doit se conformer à la limitation P.I.R.E spécifiée pour l'exploitation point à point et non point à point, selon le cas.

En outre, les utilisateurs devraient aussi être avisés que les utilisateurs de radars de haute puissance sont désignés utilisateurs principaux (c.-à-d., qu'ils ont la priorité) pour les bandes 5250-5350 MHz et 5650-5850 MHz et que ces radars pourraient causer du brouillage et/ou des dommages aux dispositifs LAN-EL.

Radiation Exposure Statement:

This equipment complies with IC radiation exposure limits set forth for an uncontrolled environment. This equipment should be installed and operated with minimum distance 32cm between the radiator & your body.

Déclaration d'exposition aux radiations:

Cet équipement est conforme aux limites d'exposition aux rayonnements IC établies pour un environnement non contrôlé. Cet équipement doit être installé et utilisé avec un minimum de 32cm de distance entre la source de rayonnement et votre corps.

Industry Canada Statement

CAN ICES-3 (B)/NMB-3(B)

Korea Warning Statements

당해 무선설비는 운용중 전파혼신 가능성이 있음.

NCC Notice

注意!

依據 低功率電波輻射性電機管理辦法

第十二條 經型式認證合格之低功率射頻電機，非經許可，公司、商號或使用者均不得擅自變更頻率、加大功率或變更原設計之特性或功能。

第十四條 低功率射頻電機之使用不得影響飛航安全及干擾合法通行；經發現有干擾現象時，應立即停用，並改善至無干擾時方得繼續使用。前項合法通信，指依電信規定作業之無線電信。低功率射頻電機需忍受合法通信或工業、科學以及醫療用電波輻射性電機設備之干擾。

減少電磁波影響，請妥適使用。

BSMI Notice

安全諮詢及注意事項

- 請使用原裝電源供應器或只能按照本產品注明的電源類型使用本產品。
- 清潔本產品之前請先拔掉電源線。請勿使用液體、噴霧清潔劑或濕布進行清潔。
- 注意防潮，請勿將水或其他液體潑灑到本產品上。
- 插槽與開口供通風使用，以確保本產品的操作可靠並防止過熱，請勿堵塞或覆蓋開口。
- 請勿將本產品置放於靠近熱源的地方。除非有正常的通風，否則不可放在密閉位置中。
- 請不要私自打開機殼，不要嘗試自行維修本產品，請由授權的專業人士進行此項工作。



Продукт сертифіковано згідно с правилами системи УкрСЕПРО на відповідність вимогам нормативних документів та вимогам, що передбачені чинними законодавчими актами України.



Safety Information



- When product has power button, the power button is one of the way to shut off the product; when there is no power button, the only way to completely shut off power is to disconnect the product or the power adapter from the power source.
- Don't disassemble the product, or make repairs yourself. You run the risk of electric shock and voiding the limited warranty. If you need service, please contact us.
- Avoid water and wet locations.

- Adapter shall be installed near the equipment and shall be easily accessible.
- The plug considered as disconnect device of adapter.
-  Use only power supplies which are provided by manufacturer and in the original packing of this product. If you have any questions, please don't hesitate to contact us.

For EU/EFTA, this product can be used in the following countries:

AT	BE	BG	HR	CY	CZ	DK	EE
FI	FR	DE	GR	HU	IE	IT	LV
LT	LU	MT	NL	PL	PT	RO	SK
SI	ES	SE	GB	IS	LI	NO	CH

Explanation of the symbols on the product label

Symbol	Explanation
	DC voltage
	<p>RECYCLING</p> <p>This product bears the selective sorting symbol for Waste electrical and electronic equipment (WEEE). This means that this product must be handled pursuant to European directive 2012/19/ EU in order to be recycled or dismantled to minimize its impact on the environment.</p> <p>User has the choice to give his product to a competent recycling organization or to the retailer when he buys a new electrical or electronic equipment.</p>

DECLARATION OF CONFORMITY

For the following equipment:

Product Description: AC1200 Wireless Gigabit Access Point

Model No.: **AP300**

Trademark: **TP-LINK**

We declare under our own responsibility that the above products satisfy all the technical regulations applicable to the product within the scope of Council Directives:

Directives 1999/5/EC, Directives 2011/65/EU

The above product is in conformity with the following standards or other normative documents

EN 300 328 V1.8.1

EN 301 489-1 V1.9.2 & EN 301 489-17 V2.2.1

EN 60950-1: 2006 + A11: 2009 + A1: 2010 + A12: 2011 + A2: 2013

EN 50385: 2002

EN 301 893 V1.7.1

The product carries the CE Mark:

CE 1588 

Person responsible for making this declaration:



Yang Hongliang
Product Manager of International Business

Date of issue: 2016/2/22