

Installation Guide

JetStream 24-Port Gigabit Stackable Smart Switch
with 4 10GE SFP+ Slots

T1700G-28TQ

About this Installation Guide

This Installation Guide describes the hardware characteristics, installation methods and the points that should be attended to during the installation. This Installation Guide is structured as follows:

Chapter 1 Introduction.

This chapter describes the external components of the switch.

Chapter 2 Installation.

This chapter illustrates how to install the switch.

Chapter 3 Lightning Protection.

This chapter illustrates how to prevent lightning damage.

Chapter 4 Connection.

This chapter illustrates how to do the physical connection of the switch.

Chapter 5 Configuration.

This chapter instructs you to configure the switch via Web Interface and CLI commands.

Appendix A Troubleshooting.

Appendix B Specifications.

Audience



This Installation Guide is for:

Network Engineer

Network Administrator

Conventions

- The figures in Chapter 2 to Chapter 4 are for demonstration purposes only. Your switch may differ in appearance from that depicted.
- This Guide uses the specific formats to highlight special messages. The following table lists the notice icons that are used throughout this guide.

	Remind to be careful. A caution indicates a potential which may result in device damage.
	Remind to take notice. The note contains the helpful information for a better use of the product.

Related Document

The User Guide and CLI Reference Guide of the product are provided on the resource CD. To obtain the latest product information, please visit the official website: <http://www.tp-link.com>

Contents

Chapter 1	Introduction	01
1.1	Product Overview	01
1.2	Appearance	01
Chapter 2	Installation	04
2.1	Package Contents	04
2.2	Safety Precautions	04
2.3	Installation Tools	06
2.4	Product Installation	07
2.5	Stacking Using SFP+ Port	08
Chapter 3	Lightning Protection	10
3.1	Cabling Reasonably	10
3.2	Connect to Ground	12
3.3	Equipotential Bonding	13
3.4	Use Lightning Arrester	14
Chapter 4	Connection	16
4.1	Ethernet Port	16
4.2	SFP+ Port	16
4.3	Verify Installation	16
4.4	Power On	17
4.5	Initialization	17
Chapter 5	Configuration	18
5.1	Configure the Switch via GUI	18
5.2	Configure the Switch Using CLI	19
Appendix A	Troubleshooting	21
Appendix B	Specifications	22

Chapter 1 Introduction

1.1 Product Overview

TP-LINK Gigabit Smart Switch, designed for workgroups and departments, provides wire-speed performance and abundant L2 management features. It provides a variety of service features and multiple powerful functions with high security.

The EIA-standardized framework and smart configuration capacity can provide flexible solutions for a variable scale of networks. QoS and IGMP snooping/filtering optimize voice and video application. Link aggregation increases aggregated bandwidth, optimizing the transport of business critical data. SNMP, RMON, WEB and CLI Log-in bring abundant management policies. TP-LINK Gigabit Smart Switch integrates multiple functions with excellent performance, and is friendly to manage, which can fully meet the need of the users demanding higher networking performance.

T1700G-28TQ also supports stacking of up to 6 units, thus providing flexible scalability and protective redundancy for your networks.

1.2 Appearance

■ Front Panel

The front panel of T1700G-28TQ is shown as the following figure.

Figure 1-1 Front Panel of T1700G-28TQ

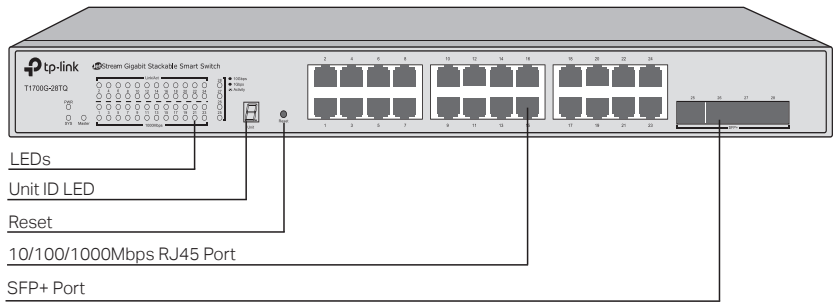

LEDs

LED	Status	Indication
PWR	On	The switch is powered on
	Off	The switch is powered off
	Flashing	Power supply is abnormal
SYS	Flashing	The switch is working normally
	On/Off	The switch is working abnormally

LED	Status	Indication	
Master	On	The switch works as master in the stack system, or does not join any stack system	
	Off	The switch works as stack member in the stack system	
Link/Act	On	There is a device connected to the corresponding port but no activity	
	Flashing	Data is being transmitted or received	
	Off	No device is connected to the corresponding port	
1000Mbps	On	A 1000Mbps device is connected to the corresponding port	
	Off	A 10/100Mbps device or no device is connected to the corresponding port	
25-28	Green	On	A 10Gbps device is connected to the corresponding port, but no activity
		Flashing	Data is being transmitted or received
	Yellow	On	A 1000Mbps device is connected to the corresponding port, but no activity
		Flashing	Data is being transmitted or received
	Off		No device is connected to the corresponding port

Unit ID LED

Designed to display the stack Unit ID of the switch. For the switch that does not join any stack system, it displays its default Unit ID. To modify the default unit number, please logon to the GUI of the switch and go to **Stack→Stack Management→Stack Config** page and configure the New Unit ID. The new Unit ID will take effect after you reboot the switch.

Reset

Press this button for 5 seconds or above to reset the software setting back to factory default settings.

10/100/1000Mbps RJ45 Port

Designed to connect to the device with a bandwidth of 10Mbps, 100Mbps or 1000Mbps. Each has a corresponding Link/Act LED and a 1000Mbps LED.

SFP+ Port

Port 25-28, designed to install the 1Gbps SFP transceiver, 10Gbps SFP+ transceiver or SFP+ cable.

Port Feature

Model	10/100/1000Mbps RJ45 Port	SFP+ Port
T1700G-28TQ	24	4

■ Rear Panel

The rear panel of T1700G-28TQ is shown as the following figure.

Figure 1-2 Rear Panel of T1700G-28TQ

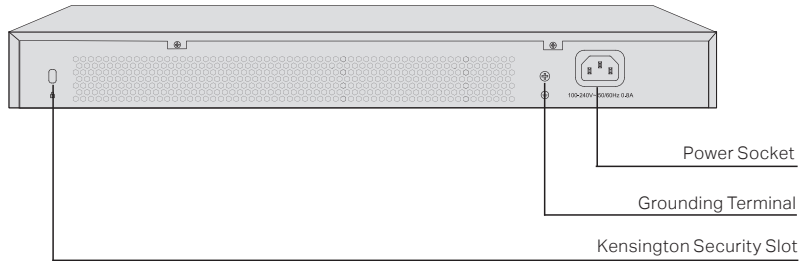

Kensington Security Slot

Secure the lock (not provided) into the security slot to prevent the device from being stolen.

Grounding Terminal

The switch already comes with lightning protection mechanism. You can also ground the switch through the PE (Protecting Earth) cable of AC cord or with Ground Cable. For detailed information, please refer to **Chapter 3 Lightning Protection**.

Power Socket

Connect the female connector of the power cord here, and the male connector to the AC (Alternating Current) power outlet. Please make sure the voltage of the power supply meets the requirement of the input voltage.



Caution:

Please use the provided power cord.

Chapter 2 Installation

2.1 Package Contents

Make sure that the package contains the following items. If any of the listed items is damaged or missing, please contact your distributor.

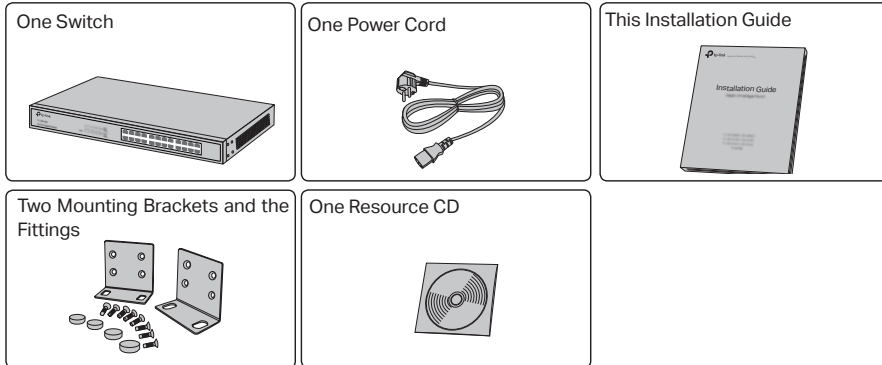

2.2 Safety Precautions

To avoid any device damage and bodily injury caused by improper use, please observe the following rules.

■ Safety Precautions

- Keep the power off during the installation.
- Wear an ESD-preventive wrist strap, and make sure that the wrist strap has a good skin contact and is well grounded.
- Use only the power cord provided with the switch.
- Make sure that the supply voltage matches the specifications indicated on the rear panel of the switch.
- Ensure the vent hole is well ventilated and unblocked.
- Do not open or remove the cover of the switch.
- Before cleaning the device, cut off the power supply. Do not clean it by the waterish cloth, and never use any other liquid cleaning method.

■ Site Requirements

Temperature/Humidity

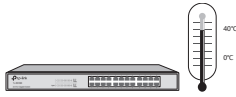

Please keep a proper temperature and humidity in the equipment room. Too high/low humidity may lead to bad insulation, electricity leakage, mechanical property changes and corrossions. Too high temperature may accelerate aging of the insulation materials and can thus significantly shorten the service life of the device. For normal temperature and humidity of the device, please check the following table.

Environment	Temperature	Humidity
Operating	0°C to 40°C	10% to 90%RH Non-condensing
Storage	-40°C to 70°C	5% to 90%RH Non-condensing

Cleanness



The dust accumulated on the switch can be absorbed by static electricity and result in poor contact of metal contact points. Some measures have been taken for the device to prevent static electricity, but too strong static electricity can cause deadly damage to the electronic elements on the internal circuit board. To avoid the effect of static electricity on the operation of the Switch, please attach much importance to the following items:

- Dust the device regularly, and keep the indoor air clean.
- Keep the device well grounded and ensure static electricity has been transferred.

Electromagnetic Interference

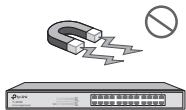

Electronic elements including capacitance and inductance on the device can be affected by external interferences, such as conducted emission by capacitance coupling, inductance coupling, and impedance coupling. To decrease the interferences, please make sure to take the following measures:

- Use the power supply that can effectively filter interference from the power grid.
- Keep the device far from high-frequency, strong-current devices, such as radio transmitting station.
- Use electromagnetic shielding when necessary.

Lightening Protection



Extremely high voltage currents can be produced instantly when lightning occurs and the air in the electric discharge path can be instantly heated up to 20,000°C. As this instant current is strong enough to damage electronic devices, more effective lightning protection measures should be taken.

- Ensure the rack and device are well earthed.
- Make sure the power socket has a good contact with the ground.
- Keep a reasonable cabling system and avoid induced lightning.
- Use the signal SPD (Surge Protective Device) when wiring outdoor.



Note:

For detailed lightning protection measures, please refer to **Chapter 3 Lightning Protection**.

Installation Site

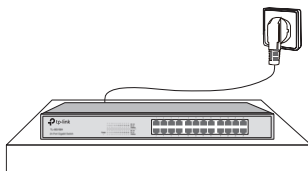

When installing the device on a rack or a flat workbench, please note the following items:

- The rack or workbench is flat and stable, and sturdy enough to support the weight of 5.5kg at least.
- The rack or workbench has a good ventilation system. The equipment room is well ventilated.
- The rack is well grounded. Keep the power socket less than 1.5 meters away from the device.

2.3 Installation Tools

- Phillips screwdriver
- ESD-preventive wrist wrap
- Cables



Note:

These tools are not provided with our product. If needed, please self purchase them.

2.4 Product Installation

■ Desktop Installation

To install the device on the desktop, please follow the steps:

1. Set the device on a flat surface strong enough to support the entire weight of the device with all fittings.
2. Remove the adhesive backing papers from the rubber feet.
3. Turnover the device and attach the supplied rubber feet to the recessed areas on the bottom at each corner of the device.

Figure 2-1 Desktop Installation

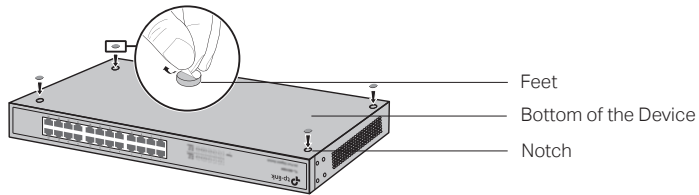

■ Rack Installation

To install the device in an EIA standard-sized, 19-inch rack, follow the instructions described below:

1. Check the grounding and stability of the rack.
2. Secure the supplied rack-mounting brackets to each side of the device with supplied screws, as illustrated in the following figure.

Figure 2-2 Bracket Installation

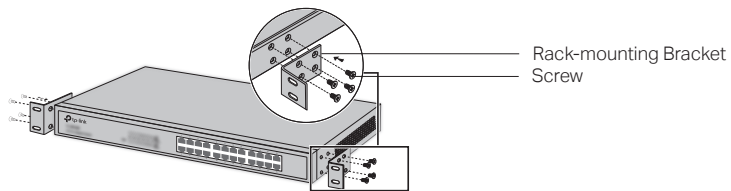

3. After the brackets are attached to the device, use suitable screws (not provided) to secure the brackets to the rack, as illustrated in the following figure.

Figure 2-3 Rack Installation

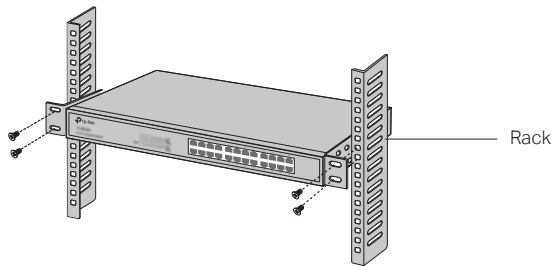

Caution:

- Please set 5 to 10cm gaps around the device for air circulation.
- Please avoid any heavy thing placed on the device.
- Please mount devices in sequence from the bottom to top of the rack and ensure a certain clearance between devices for the purpose of heat dissipation.

2.5 Stacking Using SFP+ Port

You can connect up to 6 switches to form a stack with a single management IP address. Follow the steps below to connect the switches and configure the stack ports, then the switches will automatically elect a master unit and establish a stack. Once the stack is established, you can use any port of any switch in the stack to manage the stack system.

Any SFP+ ports (Port 25-28) on the front panel can be used for stacking. Port 25-26 belong to Stack Port Group 0 and Port 27-28 belong to Stack Port Group 1. Since stack capability cannot be enabled in the two groups simultaneously, you can enable stack feature in either Group 0 or Group 1.

Here is an example of a recommended configuration that uses three rack-mounted switches to form a full-ring stack.

Configuration and Connection

1. Log on to the GUI of each switch, go to **Stack**→**Stack Management**→**Stack Config** page to enable the Stack Capability of port 25 and 26 (port 1/0/25 and 1/0/26 on the GUI). Remember to click **Apply** after the configuration.
2. Power off the switches, and then use the 10G SFP+ cable (TXC432-CU1M/TXC432-CU3M of TP-LINK for example) to connect each switch to the next in a cascade. Finally, connect the last switch in the stack to the first switch, thus forming a ring topology as Figure 2-4 shows. The ring topology system provides redundancy and resiliency to the stack.

Figure 2-4 Stacking Using SFP+ Port

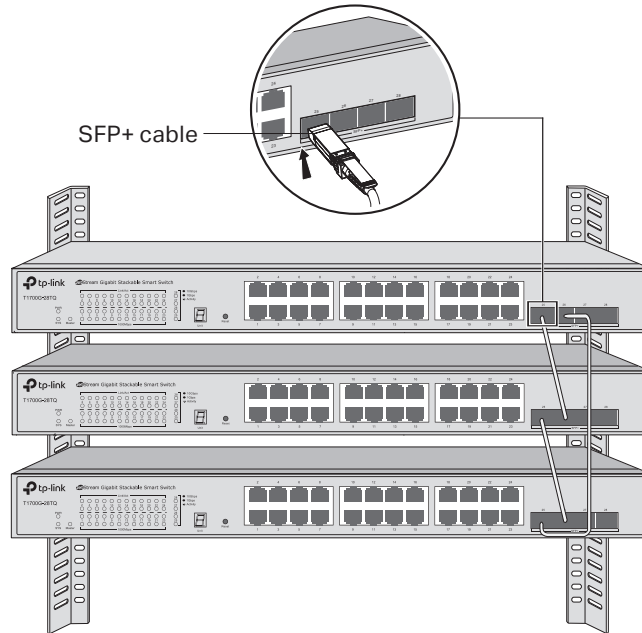

Power On Sequence of the Stack Switches

Since the sequence in which the switches are first powered on might affect the switch that becomes the stack master, please consider the following guidelines before powering on the switches in the stack:

1. If you want a particular switch to become the stack master, power on this switch first. After 1 minute, power on the other switches in the stack. That earliest startup switch will remain the stack master until the next master re-election.
2. If you have no preference as to which switch becomes the stack master, power on all the switches in the stack within 1 minute. The switches will participate in a election to select a master. The Master LED of the selected switch will be on. The switches powered on after 1 minutes don't participate in the election, and they will become member switches.
3. You can access to any member of the stack via Web/SSH/Telnet connection, thus to manage all the switches in the stack.

For more information about stack topology and master election, please refer to "Stack" chapter in the User Guide on the Resource CD.



Caution:

In the process of using TP-LINK SFP+ Cables, please never bend them into a radius of 45mm (1.77 inch) or less, because it may permanently damage the SFP+ Cables.

Chapter 3 Lightning Protection

3.1 Cabling Reasonably

In the actual network environment, you may need cable outdoors and indoors, and the requirements for cabling outdoors and indoors are different. A reasonable cabling system can decrease the damage of induced lightning to devices.



Note:

It's not recommended using Ethernet cables outdoors. When cabling outdoors, please use a signal lightning arrester.

■ **Requirements for Cabling Outdoors**

- Aerial cabling without safeguard is not allowed.

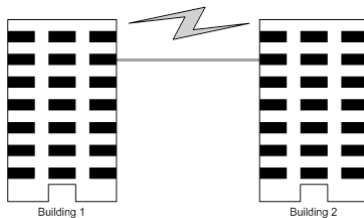

- It's not allowed cabling down the building to connect network devices in different floors.

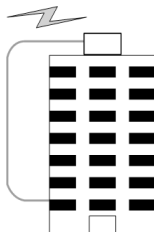

- Outdoor cables should be buried and paved to the indoor through basement. A piece of steel wire should be paved underground along the pipe and connected to the lightning protection terminal of the building for shielding. Before connecting the cable to the device, install a signal lightning arrester on the corresponding port.
- When an aerial cable is set up, the cable should be through a metal pipe (15m long at least) before coming into the building. The two ends of this metal pipe should be grounded. Before connecting the cable to the device, install a signal lightning arrester on the corresponding port.
- It's not necessary to pave STP cables through pipes. The shielded layer of STP cable should be well grounded. Before connecting the cable to the device, install a signal lightning arrester on the corresponding port.

■ **Requirements for Cabling Indoors**

When cabling indoors, keep a certain distance away from the devices that may cause high-frequency interferences, such as down-conductor cable, powerline, power transformer and electromotor.

- The main cable should be paved in the metal raceway of the access shaft. When cabling, keep the loop area formed by the cable itself as small as possible.
- Requirements for the distance between Ethernet cable and other pipelines are shown in the table.

Other Pipelines	Ethernet Cable	
	Min Parallel Net Length L (mm)	Min Parallel-overlapping Net Height H (mm)
Down-conductor	1000	300
PE	50	20
Service pipe	150	20
Compressed air pipe	150	20
Thermal pipe (not wrapped)	500	500
Thermal pipe (wrapped)	300	300
Gas pipe	300	20

The two diagrams below demonstrate parallel net length and parallel-overlapping net height.

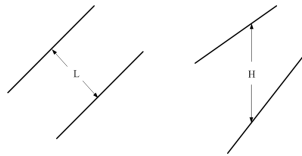

Note:

The above minimum net length/height is required when metal raceway is not used. If any requirements cannot be met, you can add a steel tube or metal raceway for shielding.

- Requirements for the distance between Ethernet cable and high-power electric devices are in following tables.

Cable	Pave Way	Min Parallel Length (mm)
<2kVA powerline	Parallel cabling	130
	One is in the grounded metal raceway or metal pipe	70
	The both are in the grounded metal raceway or metal pipe	10

Cable	Pave Way	Min Parallel Length (mm)
2 to 5kVA powerline	Parallel cabling	300
	One is in the grounded metal raceway or metal pipe	150
	The both are in the grounded metal raceway or metal pipe	80
>5kVA powerline	Parallel cabling	600
	One is in the grounded metal raceway or metal pipe	300
	The both are in the grounded metal raceway or metal pipe	150

Device	Min Distance (m)
Switch case	1.00
Transformer room	2.00
Elevator tower	2.00
Air-conditioner room	2.00

3.2 Connect to Ground

Connecting the device to ground is to quickly release the lightning over-voltage and over-current of the device, which is also a necessary measure to protect the body from electric shock.

In different environments, the device may be grounded differently. The following will instruct you to connect the device to the ground in two ways, connecting to the grounding bar or connecting to the ground via the power cord. Please connect the device to ground in the optimum way according to your specific operation environment.

■ Connecting to the Grounding Bar

If the device is installed in the Equipment Room, where a grounding bar is available, you are recommended to connect the device to the grounding bar as shown in the following figure.

Figure 3-1 Connecting to the Grounding Bar

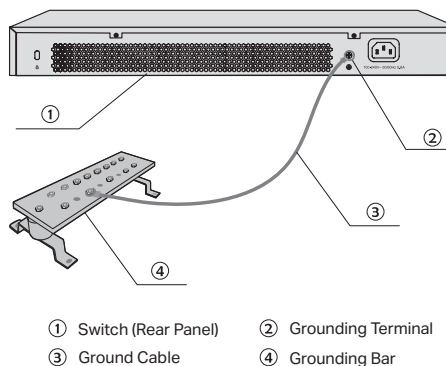

**Note:**

The grounding bar and the ground cable are not provided with our product. If needed, please self purchase them.

■ Connecting to the Ground via the Power Supply

If the device is installed in the normal environment, the device can be grounded via the PE (Protecting Earth) cable of the AC power supply as shown in the following figure.

Figure 3-2 Connecting to the Ground

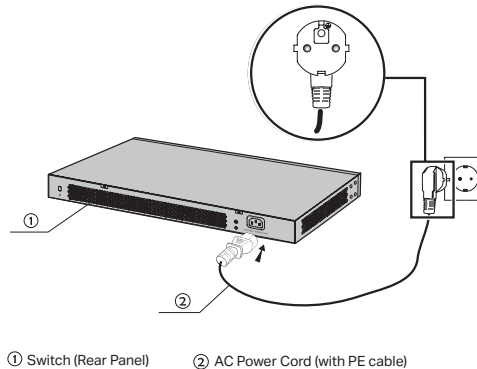
**Note:**

- The figure is to illustrate the application and principle. The power plug you get from the package and the socket in your situation will comply with the regulation in your country, so they may differ from the figure above.
- If you intend to connect the device to the ground via the PE (Protecting Earth) cable of AC power cord, please make sure the PE (Protecting Earth) cable in the electrical outlet is well grounded in advance.

3.3 Equipotential Bonding

Equipotential Bonding is the practice of intentionally electrically connecting all earthed systems to the same grounding grid or connecting the grounding grids of all the earthed systems together through the ground or overground metal so as to create an earthed equipotential zone. When lightning occurs, the high voltage produced by lightning current in all systems will meanwhile exist in their ground cables, and thus all ground cables have the same electrical potential and basically eliminate the electric strikes between the systems.

The figure below illustrates how to practice equipotential bonding in a network.

Figure 3-3 Equipotential Bonding

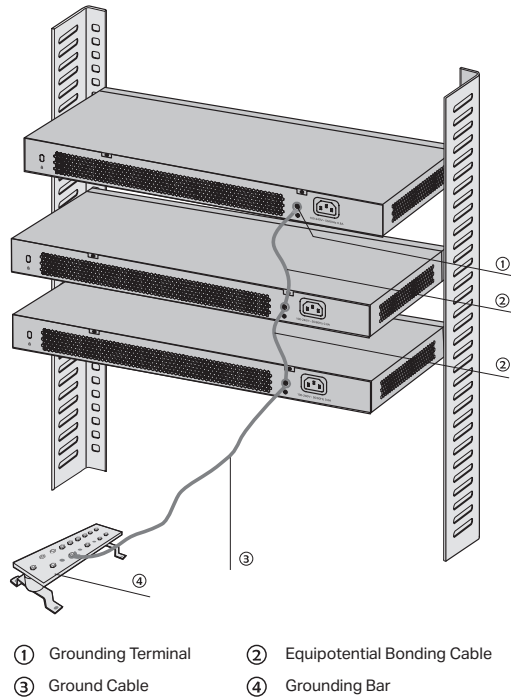

When equipotential bonding, please note that the cable should be copper wrapped Kelly with its area being 6mm^2 at least. The shorter cable the better, and use a grounding bar to establish an equipotential bonding point.



Note:

The equipotential bonding cable and ground cable are not provided with our product. If needed, please self purchase it.

3.4 Use Lightning Arrester

Power lightning arrester and signal lightning arrester are used for lightning protection.

Power lightning arrester is used for limiting the voltage surge due to a lightning. If an outdoor AC power cord should be directly connected to the device, please use a power lightning arrester.



Note:

Power lightning arrester is not provided with our product. If needed, please self purchase it.

Signal lightning arrester is used to protect RJ45 ports of the device from lightning. When cabling outdoors, please install a signal lightning arrester before connecting the cable to the device.

When purchasing or using a signal lightning arrester, please observe the following rules:

- The port rate of the signal lightning arrester should match the rate of the desired port on the device. If it is not matched, this signal lightning arrester will not work. Purchase a standard lightning arrester.
- Install signal lightning arrester near the protected device and connect it to the ground via a shorter ground cable.

Figure 3-4 Equipotential Bonding

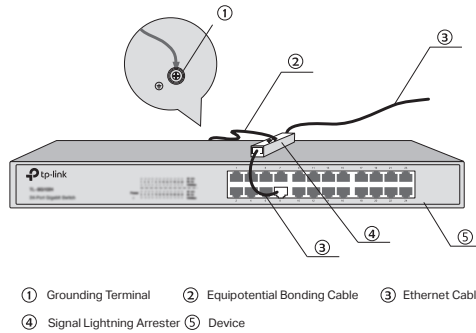

Note:

Signal lightning arrester is not provided with our product. If needed, please self purchase it.

Chapter 4 Connection

4.1 Ethernet Port

Connect a Ethernet port of the switch to the computer by RJ45 cable as the following figure shows.

Figure 4-1 Connecting the RJ45 Port

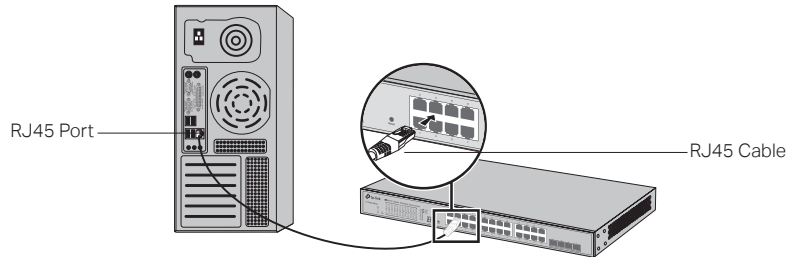

4.2 SFP+ Port

Connect an SFP/SFP+ transceiver or an SFP+ cable to the SFP+ port. Make sure the SFP+ module minimum bend radius is met when using the SFP+ cable.

The SFP+ ports support 10G connection by default. If you are using a gigabit SFP module, please configure the speed of the corresponding SFP+ port as 1000M.

Figure 4-2 Inserting the SFP+ Module

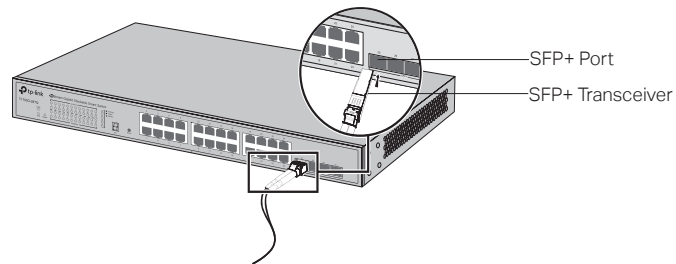

4.3 Verify Installation

After completing the installation, please verify the following items:

- There are 5 to 10cm of clearance around the sides of the device for ventilation and the air flow is adequate.
- The voltage of the power supply meets the requirement of the input voltage of the device.

- The power socket, device and rack are well grounded.
- The device is correctly connected to other network devices.

4.4 Power On

Plug in the negative connector of the provided power cord into the power socket of the device, and the positive connector into a power outlet as the following figure shows.

Figure 4-3 Connecting to Power Supply

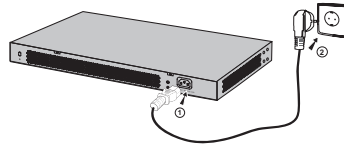

Note:

The figure is to illustrate the application and principle. The power plug you get from the package and the socket in your situation will comply with the regulation in your country, so they may differ from the figure above.

4.5 Initialization

After the device is powered on, it begins the Power-On Self-Test. A series of tests run automatically to ensure the device functions properly. During this time, its LED indicators will respond in the following order:

1. The PWR LED lights on all the time. The SYS LED and the LED indicators of all the ports keep off.
2. After over one minute, the LED indicators of all the ports will flash momentarily and then turn off.
3. A few seconds later, the SYS LED indicator will flash, which represents a successful initialization.

Chapter 5 Configuration

5.1 Configure the Switch via GUI

1. To access the GUI of the switch, open a web browser and type the default management address `http://192.168.0.1` in the address field of the browser, then press the Enter key.

Figure 5-1 Web Browser

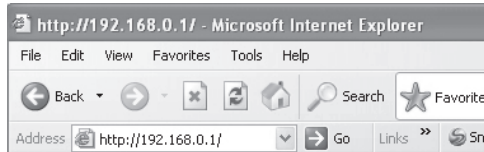

Note: To log on to the GUI of the switch, the IP address of your PC should be set in the same subnet addresses of the switch. The IP address is 192.168.0.x ("x" is any number from 2 to 254), Subnet Mask is 255.255.255.0.

For the detailed instructions as to how to do this, please refer to Appendix B in the User Guide on the Resource CD.

2. Enter admin for the default User Name and Password, both in lower case letters. Then click the Login button or press the Enter key.

Figure 5-2 Login



- After a successful login, the main page will appear as the following figure, and you can configure the function by clicking the setup menu on the left side of the screen.

Figure 5-3 Main Page of the Switch

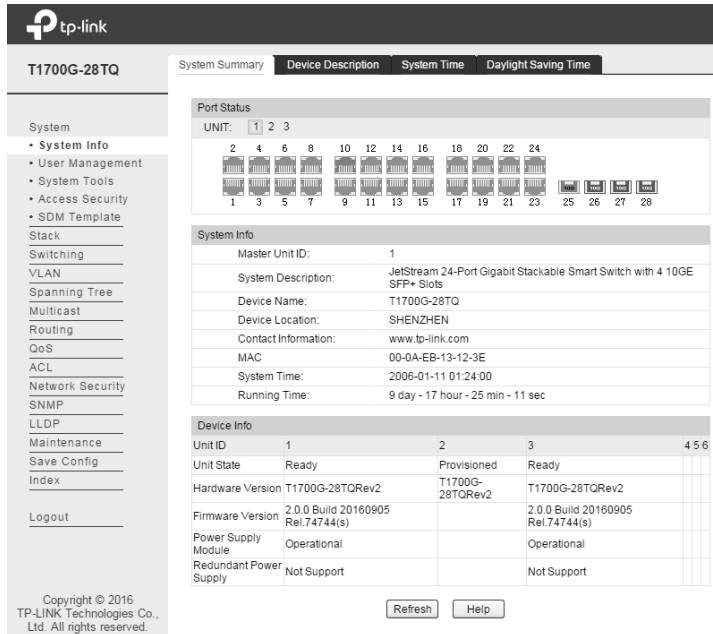

5.2 Configure the Switch Using CLI

You can log on to the switch and access the CLI by Logging on to the switch remotely by a Telnet connection through an Ethernet port. To log on to the switch by a Telnet connection, please take the following steps:

- Make sure the switch and the PC are in the same LAN.
- Click Start and type in **cmd** in the Search programs and files window and press the Enter button.

Figure 5-4 Open the Run window

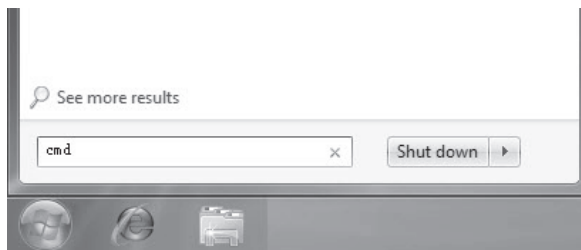

3. Type telnet 192.168.0.1 in the command prompt shown as Figure 5-5, and press the Enter button.

Figure 5-5 Connecting to the Switch

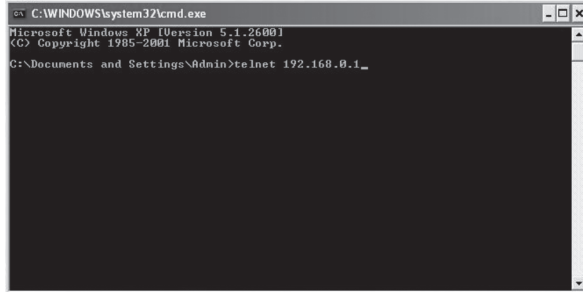

4. Type the default user name and password (both of them are **admin**), then press the **Enter** button so as to enter User EXEC Mode.

Figure 5-6 Enter into the User EXEC Mode

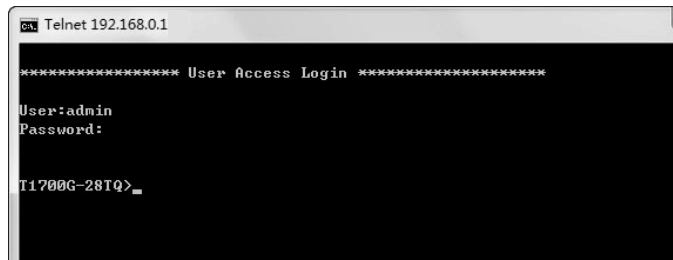

For detailed CLI configuration instructions, please refer to the CLI Reference Guide on the resource CD.

Appendix A Troubleshooting

Q1. What could I do if I forgot the username and password of the switch?

Press the Reset button for at least 5 seconds to reset the system. The system will be reset to the factory default settings, and the default login user name and password are both admin.

Q2. Why does the PWR LED work abnormally?

The PWR LED should be lit up when the power system works normally. If the PWR LED worked abnormally, please take the following steps:

1. Make sure that the power cable is connected properly, and the power contact is normal.
2. Make sure the voltage of the power supply meets the requirement of the input voltage of the switch.

Q3. What could I do if I could not access the web-based configuration page?

You are recommended to check the following items:

1. Check every port LED on the switch and make sure the cable is installed properly.
2. Try another port on the switch and make sure the cable meets the requirement and works normally.
3. Turn off the power. After a while, turn on the power again.
4. Make sure the IP address of your PC is set within the subnet of the switch.
5. If you still cannot access the configuration page, please restore the switch to its factory defaults. Then the computer's IP address should be set as 192.168.0.x ("x" is any number from 2 to 254) and subnet mask as 255.255.255.0.

Appendix B Specifications

Item	Content
Standards	IEEE802.3i, IEEE802.3u, IEEE802.3ab, IEEE802.3ad, IEEE802.3ae, IEEE802.3z, IEEE802.3x, IEEE802.1p, IEEE802.1q, IEEE802.1x, IEEE802.1d, IEEE802.1s, IEEE802.1w
Transmission Medium	10Base-T 2-pair UTP/STP of Cat. 3 or above (maximum 100m)
	100Base-TX 2-pair UTP/STP of Cat. 5 or above (maximum 100m)
	1000Base-T 4-pair UTP/STP of Cat. 5e and Cat. 6 or above (maximum 100m)
	1000Base-SX MMF SFP Module
	1000Base-LX MMF or SMF SFP Module
	1000Base-LX10 SMF SFP Module
	1000Base-BX10 SMF SFP Module
	10GBASE-SR MMF SFP+ Transceiver
10GBASE-LR SMF SFP+ Transceiver	
Transfer Method	Store-and-Forward
MAC Address Learning	Automatically learning, automatically aging
Frame Forward Rate	10Base-T: 14881pps/Port
	100Base-Tx: 148810pps/Port
	1000Base-T: 1488095pps/Port
	1000Base-X: 1488095pps/Port
	10GBASE-SR:14880952pps/Port
10GBASE-LR:14880952pps/Port	
LEDs	PWR, SYS, Master, Link/Act, 1000M, 25, 26, 27, 28, Unit ID LED
Operating Temperature	0°C to 40°C (32°F ~104°F)
Storage Temperature	-40°C to 70°C (-40°F ~158°F)
Operating Humidity	10% to 90%RH Non-condensing
Storage Humidity	5% to 90%RH Non-condensing

FCC STATEMENT

This equipment has been tested and found to comply with the limits for a Class A digital device, pursuant to part 15 of the FCC Rules. These limits are designed to provide reasonable protection against harmful interference when the equipment is operated in a commercial environment. This equipment generates, uses, and can radiate radio frequency energy and, if not installed and used in accordance with the instruction manual, may cause harmful interference to radio communications. Operation of this equipment in a residential area is likely to cause harmful interference in which case the user will be required to correct the interference at his own expense.

This device complies with part 15 of the FCC Rules. Operation is subject to the following two conditions:

- 1) This device may not cause harmful interference.
- 2) This device must accept any interference received, including interference that may cause undesired operation.

Any changes or modifications not expressly approved by the party responsible for compliance could void the user's authority to operate the equipment.

CE Mark Warning



This is a Class A product. In a domestic environment, this product may cause radio interference, in which case the user may be required to take adequate measures.



Продукт сертифіковано згідно с правилами системи УкрСЕПРО на відповідність вимогам нормативних документів та вимогам, що передбачені чинними законодавчими актами України.

Safety Information

- When product has power button, the power button is one of the way to shut off the product; when there is no power button, the only way to completely shut off power is to disconnect the product or the power adapter from the power source.
- Don't disassemble the product, or make repairs yourself. You run the risk of electric shock and voiding the limited warranty. If you need service, please contact us.
- Avoid water and wet locations.

Industry Canada Statement

CAN ICES-3 (A)/NMB-3(A)

