



# CLI Reference Guide

**T1700X-16TS**

## COPYRIGHT & TRADEMARKS

Specifications are subject to change without notice.  <sup>tp-link</sup> is a registered trademark of TP-link Technologies Co., Ltd. Other brands and product names are trademarks or registered trademarks of their respective holders.

No part of the specifications may be reproduced in any form or by any means or used to make any derivative such as translation, transformation, or adaptation without permission from TP-link Technologies Co., Ltd. Copyright © 2016 TP-link Technologies Co., Ltd. All rights reserved.

<http://www.tp-link.com>

# CONTENTS

<b>Preface</b>	<b>1</b>
<b>Chapter 1 Using the CLI</b>	<b>4</b>
1.1 Accessing the CLI	4
1.1.1 Logon by Telnet	4
1.1.2 Logon by SSH	5
1.2 CLI Command Modes	10
1.3 Security Levels	13
1.4 Conventions	14
1.4.1 Format Conventions	14
1.4.2 Special Characters	14
1.4.3 Parameter Format	14
<b>Chapter 2 User Interface</b>	<b>15</b>
2.1 enable	15
2.2 service password-encryption	15
2.3 enable password	16
2.4 enable secret	17
2.5 configure	18
2.6 exit	18
2.7 end	19
2.8 history	19
2.9 history clear	20
<b>Chapter 3 IEEE 802.1Q VLAN Commands</b>	<b>21</b>
3.1 vlan	21
3.2 interface vlan	21
3.3 name	22
3.4 switchport general allowed vlan	23
3.5 switchport pvid	23
3.6 show vlan summary	24
3.7 show vlan brief	24
3.8 show vlan	25
3.9 show interface switchport	25
<b>Chapter 4 MAC-based VLAN Commands</b>	<b>27</b>
4.1 mac-vlan mac-address	27

4.2	mac-vlan .....	28
4.3	show mac-vlan.....	28
4.4	show mac-vlan interface.....	29
<b>Chapter 5</b>	<b>Protocol VLAN Commands.....</b>	<b>30</b>
5.1	protocol-vlan template .....	30
5.2	protocol-vlan vlan .....	31
5.3	protocol-vlan group.....	32
5.4	show protocol-vlan template.....	32
5.5	show protocol-vlan vlan.....	33
<b>Chapter 6</b>	<b>Voice VLAN Commands .....</b>	<b>34</b>
6.1	voice vlan.....	34
6.2	voice vlan aging.....	34
6.3	voice vlan priority.....	35
6.4	voice vlan mac-address.....	36
6.5	switchport voice vlan mode .....	36
6.6	switchport voice vlan security.....	37
6.7	show voice vlan .....	38
6.8	show voice vlan oui .....	38
6.9	show voice vlan switchport.....	39
<b>Chapter 7</b>	<b>Private VLAN Commands .....</b>	<b>40</b>
7.1	private-vlan primary .....	40
7.2	private-vlan community.....	40
7.3	private-vlan isolated.....	41
7.4	private-vlan association.....	42
7.5	switchport private-vlan.....	42
7.6	switchport private-vlan host-association .....	43
7.7	switchport private-vlan mapping.....	44
7.8	show vlan private-vlan.....	45
7.9	show vlan private-vlan interface .....	45
<b>Chapter 8</b>	<b>Etherchannel Commands .....</b>	<b>46</b>
8.1	channel-group.....	46
8.2	port-channel load-balance.....	47
8.3	lACP system-priority.....	48
8.4	lACP port-priority .....	48
8.5	show etherchannel .....	49

8.6	show etherchannel load-balance.....	50
8.7	show lacp.....	50
8.8	show lacp sys-id .....	51
<b>Chapter 9</b>	<b>User Management Commands .....</b>	<b>52</b>
9.1	user name (password).....	52
9.2	user name (secret) .....	53
9.3	user access-control ip-based .....	54
9.4	user access-control mac-based .....	55
9.5	user access-control port-based .....	56
9.6	telnet .....	57
9.7	show user account-list.....	57
9.8	show user configuration.....	58
9.9	show telnet-status.....	58
<b>Chapter 10</b>	<b>HTTP and HTTPS Commands.....</b>	<b>60</b>
10.1	ip http server .....	60
10.2	ip http max-users .....	61
10.3	ip http session timeout.....	61
10.4	ip http secure-server.....	62
10.5	ip http secure-protocol.....	63
10.6	ip http secure-ciphersuite .....	63
10.7	ip http secure-max-users.....	64
10.8	ip http secure-session timeout.....	65
10.9	ip http secure-server download certificate.....	65
10.10	ip http secure-server download key .....	66
10.11	show ip http configuration.....	67
10.12	show ip http secure-server .....	68
<b>Chapter 11</b>	<b>Binding Table Commands.....</b>	<b>69</b>
11.1	ip source binding .....	69
11.2	ip dhcp snooping .....	70
11.3	ip dhcp snooping vlan.....	71
11.4	ip dhcp snooping information option .....	71
11.5	ip dhcp snooping information strategy .....	72
11.6	ip dhcp snooping information remote-id.....	73
11.7	ip dhcp snooping information circuit-id.....	74
11.8	ip dhcp snooping trust .....	74
11.9	ip dhcp snooping mac-verify.....	75

11.10	ip dhcp snooping limit rate.....	76
11.11	ip dhcp snooping decline rate.....	77
11.12	show ip source binding.....	77
11.13	show ip dhcp snooping.....	78
11.14	show ip dhcp snooping interface.....	78
11.15	show ip dhcp snooping information interface.....	79
<b>Chapter 12 ARP Inspection Commands.....</b>		<b>81</b>
12.1	ip arp inspection(global).....	81
12.2	ip arp inspection(interface).....	81
12.3	ip arp inspection trust.....	82
12.4	ip arp inspection limit-rate.....	83
12.5	ip arp inspection recover.....	84
12.6	show ip arp inspection.....	84
12.7	show ip arp inspection interface.....	85
12.8	show ip arp inspection statistics.....	85
12.9	clear ip arp inspection statistics.....	86
<b>Chapter 13 DoS Defend Commands.....</b>		<b>87</b>
13.1	ip dos-prevent.....	87
13.2	ip dos-prevent type.....	87
13.3	show ip dos-prevent.....	89
<b>Chapter 14 System Log Commands.....</b>		<b>90</b>
14.1	logging buffer.....	90
14.2	logging buffer level.....	90
14.3	logging file flash.....	91
14.4	logging file flash frequency.....	92
14.5	logging file flash level.....	92
14.6	logging host index.....	93
14.7	logging monitor.....	94
14.8	logging monitor level.....	94
14.9	clear logging.....	95
14.10	show logging local-config.....	96
14.11	show logging loghost.....	96
14.12	show logging buffer.....	97
14.13	show logging flash.....	97
<b>Chapter 15 SSH Commands.....</b>		<b>99</b>

15.1	ip ssh server .....	99
15.2	ip ssh version.....	99
15.3	ip ssh algorithm .....	100
15.4	ip ssh timeout.....	101
15.5	ip ssh max-client.....	101
15.6	ip ssh download .....	102
15.7	remove public-key .....	103
15.8	show ip ssh.....	103
<b>Chapter 16 IEEE 802.1X Commands .....</b>		<b>104</b>
16.1	dot1x system-auth-control .....	104
16.2	dot1x handshake .....	105
16.3	dot1x auth-method.....	105
16.4	dot1x accounting .....	106
16.5	dot1x guest-vlan(global) .....	107
16.6	dot1x quiet-period .....	108
16.7	dot1x timeout supplicant-timeout.....	108
16.8	dot1x max-reauth-req .....	109
16.9	dot1x .....	110
16.10	dot1x guest-vlan(interface).....	110
16.11	dot1x port-control.....	111
16.12	dot1x port-method .....	112
16.13	show dot1x global.....	113
16.14	show dot1x interface.....	113
<b>Chapter 17 MAC Address Commands.....</b>		<b>115</b>
17.1	mac address-table static.....	115
17.2	mac address-table aging-time .....	116
17.3	mac address-table filtering .....	116
17.4	mac address-table notification.....	117
17.5	mac address-table notification (interface) .....	118
17.6	mac address-table max-mac-count .....	119
17.7	mac address-table security .....	120
17.8	show mac address-table.....	121
17.9	clear mac address-table .....	122
17.10	show mac address-table aging-time.....	122
17.11	show mac address-table max-mac-count .....	123
17.12	show mac address-table interface.....	124
17.13	show mac address-table count.....	124

17.14	show mac address-table address.....	125
17.15	show mac address-table vlan.....	125
17.16	show mac address-table notification.....	126
17.17	show mac address-table security.....	126
<b>Chapter 18 System Configuration Commands.....</b>		<b>128</b>
18.1	system-time manual.....	128
18.2	system-time ntp.....	128
18.3	system-time dst predefined.....	130
18.4	system-time dst date.....	131
18.5	system-time dst recurring.....	132
18.6	hostname.....	133
18.7	location.....	134
18.8	contact-info.....	134
18.9	ip address.....	135
18.10	ip address-alloc.....	136
18.11	reset.....	137
18.12	reboot.....	137
18.13	reboot-schedule.....	138
18.14	copy running-config startup-config.....	139
18.15	copy startup-config tftp.....	139
18.16	copy tftp startup-config.....	140
18.17	boot application.....	141
18.18	remove backup-image.....	141
18.19	firmware upgrade.....	142
18.20	ping.....	143
18.21	tracert.....	144
18.22	show system-info.....	145
18.23	show image-info.....	145
18.24	show boot.....	146
18.25	show running-config.....	146
18.26	show startup-config.....	147
18.27	show system-time.....	147
18.28	show system-time dst.....	148
18.29	show system-time ntp.....	148
18.30	show cable-diagnostics interface ten-gigabitEthernet.....	149
18.31	show cpu-utilization.....	149
18.32	show memory-utilization.....	150



<b>Chapter 19 IPv6 Address Configuration Commands</b> .....	<b>151</b>
19.1    ipv6 enable .....	151
19.2    ipv6 address autoconfig.....	151
19.3    ipv6 address link-local .....	152
19.4    ipv6 address dhcp .....	153
19.5    ipv6 address ra .....	153
19.6    ipv6 address .....	154
19.7    ipv6 address eui-64 .....	155
19.8    show ipv6 interface.....	155
<b>Chapter 20 Ethernet Configuration Commands</b> .....	<b>157</b>
20.1    interface ten-gigabitEthernet .....	157
20.2    interface range ten-gigabitEthernet.....	157
20.3    description .....	158
20.4    shutdown .....	159
20.5    flow-control .....	159
20.6    duplex .....	160
20.7    jumbo .....	161
20.8    speed .....	161
20.9    storm-control pps.....	162
20.10   storm-control.....	163
20.11   bandwidth .....	164
20.12   clear counters .....	164
20.13   show interface status.....	165
20.14   show interface counters.....	166
20.15   show interface configuration.....	166
20.16   show storm-control .....	167
20.17   show bandwidth .....	167
<b>Chapter 21 QoS Commands</b> .....	<b>169</b>
21.1    qos .....	169
21.2    qos dscp .....	170
21.3    qos queue cos-map .....	170
21.4    qos queue dscp-map .....	171
21.5    qos queue mode .....	172
21.6    qos queue weight .....	173
21.7    show qos interface.....	175
21.8    show qos cos-map.....	175

21.9	show qos dscp-map.....	176
21.10	show qos queue mode .....	176
21.11	show qos status .....	177
<b>Chapter 22 Port Mirror Commands .....</b>		<b>178</b>
22.1	monitor session destination interface.....	178
22.2	monitor session source interface.....	179
22.3	show monitor session.....	180
<b>Chapter 23 Port Isolation Commands .....</b>		<b>181</b>
23.1	port isolation .....	181
23.2	show port isolation interface.....	182
<b>Chapter 24 Loopback Detection Commands.....</b>		<b>183</b>
24.1	loopback-detection(global) .....	183
24.2	loopback-detection interval.....	183
24.3	loopback-detection recovery-time .....	184
24.4	loopback-detection(interface).....	184
24.5	loopback-detection config.....	185
24.6	loopback-detection recover .....	186
24.7	show loopback-detection global .....	186
24.8	show loopback-detection interface.....	187
<b>Chapter 25 ACL Commands.....</b>		<b>188</b>
25.1	access-list create.....	188
25.2	mac access-list .....	188
25.3	access-list standard.....	189
25.4	access-list extended.....	190
25.5	access-list ipv6 .....	191
25.6	rule.....	192
25.7	access-list policy name.....	193
25.8	access-list policy action.....	194
25.9	access-list bind acl(interface).....	195
25.10	access-list bind acl(vlan) .....	195
25.11	access-list bind(interface).....	196
25.12	access-list bind(vlan).....	196
25.13	show access-list .....	197
25.14	show access-list policy .....	198
25.15	show access-list bind.....	198

<b>Chapter 26</b>	<b>MSTP Commands</b>	<b>199</b>
26.1	debug spanning-tree	199
26.2	spanning-tree(global)	200
26.3	spanning-tree mode	200
26.4	spanning-tree mst configuration	201
26.5	spanning-tree mst instance	202
26.6	spanning-tree priority	202
26.7	spanning-tree tc-defend	203
26.8	spanning-tree hold-count	204
26.9	spanning-tree timer	204
26.10	spanning-tree max-hops	205
26.11	instance	206
26.12	name	207
26.13	revision	207
26.14	spanning-tree(interface)	208
26.15	spanning-tree common-config	208
26.16	spanning-tree mst	210
26.17	spanning-tree bpdufilter	210
26.18	spanning-tree bpduguard	211
26.19	spanning-tree guard loop	212
26.20	spanning-tree guard root	212
26.21	spanning-tree guard tc	213
26.22	spanning-tree mcheck	214
26.23	show spanning-tree active	214
26.24	show spanning-tree bridge	215
26.25	show spanning-tree interface	215
26.26	show spanning-tree interface-security	216
26.27	show spanning-tree mst	217
<b>Chapter 27</b>	<b>IGMP Snooping Commands</b>	<b>218</b>
27.1	ip igmp snooping(global)	218
27.2	ip igmp snooping(interface)	218
27.3	ip igmp snooping rtime	219
27.4	ip igmp snooping mtime	220
27.5	ip igmp snooping report-suppression	220
27.6	ip igmp snooping immediate-leave	221
27.7	ip igmp snooping drop-unknown	221
27.8	ip igmp snooping last-listener query-interval	222

27.9	ip igmp snooping last-listener query-count.....	223
27.10	ip igmp snooping vlan-config.....	223
27.11	ip igmp snooping vlan-config (router-ports-forbidden).....	225
27.12	ip igmp snooping multi-vlan-config.....	226
27.13	ip igmp snooping multi-vlan-config (router-ports-forbidden).....	227
27.14	ip igmp snooping multi-vlan-config (source-ip-replace).....	228
27.15	ip igmp snooping querier vlan.....	228
27.16	ip igmp snooping querier vlan (general query).....	229
27.17	ip igmp snooping max-groups.....	230
27.18	ip igmp snooping authentication.....	231
27.19	ip igmp snooping accounting.....	232
27.20	ip igmp profile.....	232
27.21	deny.....	233
27.22	permit.....	234
27.23	range.....	234
27.24	ip igmp filter.....	235
27.25	clear ip igmp snooping statistics.....	235
27.26	show ip igmp snooping.....	236
27.27	show ip igmp snooping interface.....	236
27.28	show ip igmp snooping vlan.....	237
27.29	show ip igmp snooping multi-vlan.....	238
27.30	show ip igmp snooping groups vlan.....	238
27.31	show ip igmp snooping groups.....	239
27.32	show ip igmp snooping querier.....	240
27.33	show ip igmp profile.....	241
<b>Chapter 28 MLD Snooping Commands.....</b>		<b>242</b>
28.1	ipv6 mld snooping(global).....	242
28.2	ipv6 mld snooping(interface).....	242
28.3	ipv6 mld snooping rtime.....	243
28.4	ipv6 mld snooping mtime.....	243
28.5	ipv6 mld snooping report-suppression.....	244
28.6	ipv6 mld snooping immediate-leave.....	245
28.7	ipv6 mld snooping drop-unknown.....	245
28.8	ipv6 mld snooping last-listener query-inteval.....	246
28.9	ipv6 mld snooping last-listener query-count.....	246
28.10	ipv6 mld snooping vlan-config.....	247
28.11	ipv6 mld snooping vlan-config (router-ports-forbidden).....	248

28.12	ipv6 mld snooping multi-vlan-config .....	249
28.13	ipv6 mld snooping multi-vlan-config (router-ports-forbidden) .....	250
28.14	ipv6 mld snooping multi-vlan-config (source-ip-replace) .....	251
28.15	ipv6 mld snooping querier vlan.....	252
28.16	ipv6 mld snooping querier vlan (general query).....	252
28.17	ipv6 mld snooping max-groups .....	253
28.18	ipv6 mld profile.....	254
28.19	deny .....	255
28.20	permit.....	256
28.21	range.....	256
28.22	ipv6 mld filter.....	257
28.23	clear ipv6 mld snooping statistics.....	257
28.24	show ipv6 mld snooping .....	258
28.25	show ipv6 mld snooping interface .....	258
28.26	show ipv6 mld snooping vlan .....	259
28.27	show ipv6 mld snooping multi-vlan.....	260
28.28	show ipv6 mld snooping groups vlan .....	260
28.29	show ipv6 mld snooping groups .....	261
28.30	show ipv6 mld snooping querier.....	262
28.31	show ipv6 mld profile .....	263
<b>Chapter 29</b>	<b>SNMP Commands.....</b>	<b>264</b>
29.1	snmp-server.....	264
29.2	snmp-server view .....	264
29.3	snmp-server group .....	265
29.4	snmp-server user.....	267
29.5	snmp-server community .....	268
29.6	snmp-server host.....	269
29.7	snmp-server engineID .....	271
29.8	snmp-server traps snmp.....	271
29.9	snmp-server traps link-status .....	272
29.10	snmp-server traps.....	273
29.11	snmp-server traps vlan.....	274
29.12	rmon history .....	275
29.13	rmon event.....	276
29.14	rmon alarm.....	277
29.15	rmon statistics.....	278
29.16	show snmp-server .....	279

29.17	show snmp-server view .....	280
29.18	show snmp-server group .....	280
29.19	show snmp-server user .....	280
29.20	show snmp-server community .....	281
29.21	show snmp-server host .....	281
29.22	show snmp-server engineID .....	282
29.23	show rmon history .....	282
29.24	show rmon event .....	283
29.25	show rmon alarm .....	283
29.26	show rmon statistics .....	284
<b>Chapter 30 LLDP Commands .....</b>		<b>285</b>
30.1	lldp .....	285
30.2	lldp hold-multiplier .....	285
30.3	lldp timer .....	286
30.4	lldp receive .....	287
30.5	lldp transmit .....	288
30.6	lldp snmp-trap .....	288
30.7	lldp tlv-select .....	289
30.8	lldp med-fast-count .....	290
30.9	lldp med-status .....	290
30.10	lldp med-tnv-select .....	291
30.11	lldp med-location .....	292
30.12	show lldp .....	293
30.13	show lldp interface .....	293
30.14	show lldp local-information interface .....	294
30.15	show lldp neighbor-information interface .....	294
30.16	show lldp traffic interface .....	295
<b>Chapter 31 ARP Commands .....</b>		<b>296</b>
31.1	arp .....	296
31.2	clear arp-cache .....	297
31.3	arp timeout .....	297
31.4	show arp .....	298
31.5	show ip arp (interface) .....	298
31.6	show ip arp summary .....	299
<b>Chapter 32 Static Routes Commands .....</b>		<b>300</b>
32.1	interface vlan .....	300

32.2	interface loopback .....	300
32.3	switchport.....	301
32.4	interface range port-channel .....	302
32.5	description .....	302
32.6	shutdown .....	303
32.7	interface port-channel.....	304
32.8	ip route.....	304
32.9	ipv6 routing .....	305
32.10	ipv6 route .....	306
32.11	show interface vlan.....	306
32.12	show ip interface.....	307
32.13	show ip interface brief.....	308
32.14	show ip route .....	308
32.15	show ip route specify .....	309
32.16	show ip route summary .....	310
32.17	show ipv6 interface.....	310
32.18	show ipv6 route .....	311
32.19	show ipv6 route summary .....	311
<b>Chapter 33 SDM Template Commands.....</b>		<b>313</b>
33.1	sdm prefer.....	313
33.2	show sdm prefer .....	314
<b>Chapter 34 AAA Commands .....</b>		<b>315</b>
34.1	aaa enable .....	315
34.2	tacacs-server host .....	316
34.3	show tacacs-server.....	317
34.4	radius-server host.....	317
34.5	show radius-server .....	319
34.6	aaa group.....	319
34.7	server .....	320
34.8	show aaa group .....	320
34.9	aaa authentication login.....	321
34.10	aaa authentication enable .....	322
34.11	aaa authentication dot1x default .....	323
34.12	aaa accounting dot1x default .....	324
34.13	show aaa authentication.....	324
34.14	show aaa accounting.....	325
34.15	line telnet .....	325

34.16	login authentication(telnet) .....	326
34.17	line ssh.....	327
34.18	login authentication(ssh) .....	327
34.19	enable authentication(telnet).....	328
34.20	enable authentication(ssh) .....	329
34.21	ip http login authentication.....	329
34.22	ip http enable authentication .....	330
34.23	show aaa global.....	331
<b>Chapter 35 DHCP Relay Commands .....</b>		<b>332</b>
35.1	service dhcp relay.....	332
35.2	ip helper-address.....	332
35.3	ip dhcp relay information .....	333
35.4	ip dhcp relay information policy.....	333
35.5	ip dhcp relay information custom.....	334
35.6	ip dhcp relay information circuit-id.....	335
35.7	ip dhcp relay information remote-id.....	335
35.8	show ip dhcp relay.....	336



# Preface

This Guide is intended for network administrator to provide referenced information about CLI (Command Line Interface). The device mentioned in this Guide stands for T1700X-16TS JetStream 10-Gigabit Smart Switch without any explanation. The commands in this guide apply to these models if not specially noted, and T1700X-16TS is taken as an example model in the example commands.

## Overview of this Guide

### **Chapter 1: Using the CLI**

Provide information about how to use the CLI, CLI Command Modes, Security Levels and some Conventions.

### **Chapter 2: User Interface**

Provide information about the commands used to switch between five CLI Command Modes.

### **Chapter 3: IEEE 802.1Q VLAN Commands**

Provide information about the commands used for configuring IEEE 802.1Q VLAN.

### **Chapter 4: MAC-based VLAN Commands**

Provide information about the commands used for configuring MAC-based VLAN

### **Chapter 5: Protocol VLAN Commands**

Provide information about the commands used for configuring Protocol VLAN.

### **Chapter 6: Voice VLAN Commands**

Provide information about the commands used for configuring Voice VLAN.

### **Chapter 7: Private VLAN Commands**

Provide information about the commands used for configuring Protocol VLAN.

### **Chapter 8: Etherchannel Commands**

Provide information about the commands used for configuring LAG (Link Aggregation Group) and LACP (Link Aggregation Control Protocol).

### **Chapter 9: User Management Commands**

Provide information about the commands used for user management.

### **Chapter 10: HTTP and HTTPS Commands**

Provide information about the commands used for configuring the HTTP and HTTPS logon.

### **Chapter 11: Binding Table Commands**

Provide information about the commands used for binding the IP address, MAC address, VLAN and the connected Port number of the Host together.

## **Chapter 12: ARP Inspection Commands**

Provide information about the commands used for protecting the switch from the ARP cheating or ARP Attack.

## **Chapter 13: DoS Defend Command**

Provide information about the commands used for DoS defend and detecting the DoS attack.

## **Chapter 14: System Log Commands**

Provide information about the commands used for configuring system log.

## **Chapter 15: SSH Commands**

Provide information about the commands used for configuring and managing SSH (Security Shell).

## **Chapter 16: IEEE 802.1X Commands**

Provide information about the commands used for configuring IEEE 802.1X function.

## **Chapter 17: MAC Address Commands**

Provide information about the commands used for Address configuration.

## **Chapter 18: System Configuration Commands**

Provide information about the commands used for configuring the System information and System IP, reboot and reset the switch, upgrade the switch system and commands used for cable test.

## **Chapter 19: IPv6 Address Configuration Commands**

Provide information about the commands used for configuring the System IPv6 addresses.

## **Chapter 20: Ethernet Configuration Commands**

Provide information about the commands used for configuring the Bandwidth Control, Negotiation Mode, and Storm Control for ethernet ports.

## **Chapter 21: QoS Commands**

Provide information about the commands used for configuring the QoS function.

## **Chapter 22: Port Mirror Commands**

Provide information about the commands used for configuring the Port Mirror function.

## **Chapter 23: Port Isolation Commands**

Provide information about the commands used for configuring Port Isolation function.

## **Chapter 24: Loopback Detection Commands**

Provide information about the commands used for configuring the Loopback Detection function.

## **Chapter 25: ACL Commands**

Provide information about the commands used for configuring the ACL (Access Control List).

**Chapter 26: MSTP Commands**

Provide information about the commands used for configuring the MSTP (Multiple Spanning Tree Protocol).

**Chapter 27: IGMP Snooping Commands**

Provide information about the commands used for configuring the IGMP Snooping (Internet Group Management Protocol Snooping).

**Chapter 28: MLD Snooping Commands**

Provide information about the commands used for configuring the MLD Snooping (Multicast Listener Discovery Snooping).

**Chapter 29: SNMP Commands**

Provide information about the commands used for configuring the SNMP (Simple Network Management Protocol) functions.

**Chapter 30: LLDP Commands**

Provide information about the commands used for configuring LLDP function.

**Chapter 31: ARP Commands**

Provide information about the commands used for configuring the ARP (Address Resolution Protocol) functions.

**Chapter 32: Static Routes Commands**

Provide information about the commands used for configuring the Static Route function.

**Chapter 33: SDM Template Commands**

Provide information about the commands used for configuring the SDM templates.

**Chapter 34: AAA Commands**

Provide information about the commands used for configuring AAA (authentication, authorization and accounting).

**Chapter 35: DHCP Relay Commands**

Provide information about the commands used for configuring the DHCP Relay function.

# Chapter 1 Using the CLI

## 1.1 Accessing the CLI

You can log on to the switch and access the CLI by logging on to the switch remotely by a Telnet or SSH connection through an Ethernet port.

### 1.1.1 Logon by Telnet

To log on to the switch by a Telnet connection, please take the following steps:

1. Click **Start** and type in **cmd** in the Search programs and files window and press the **Enter** button.

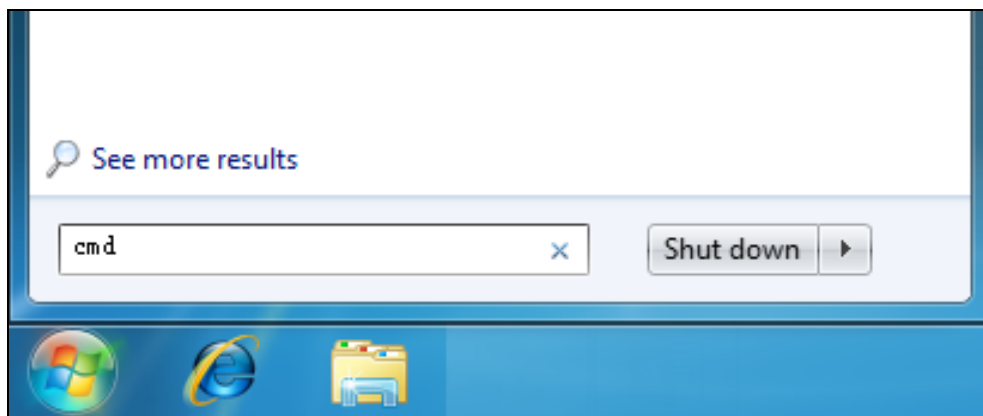

Figure 1-1 Run Window

2. Type in **telnet *the switch's IP address*** (By default, it is 192.168.0.1) in the prompt cmd window and press **Enter**.

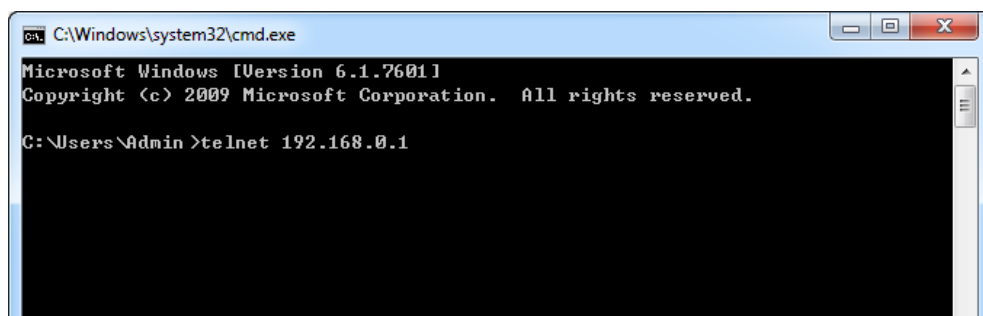

Figure 1-2 Type in the telnet command

3. Type in the User name and Password (the factory default value for both of them are admin) and press the **Enter** button to enter User EXEC Mode , which is shown as Figure 1-2.

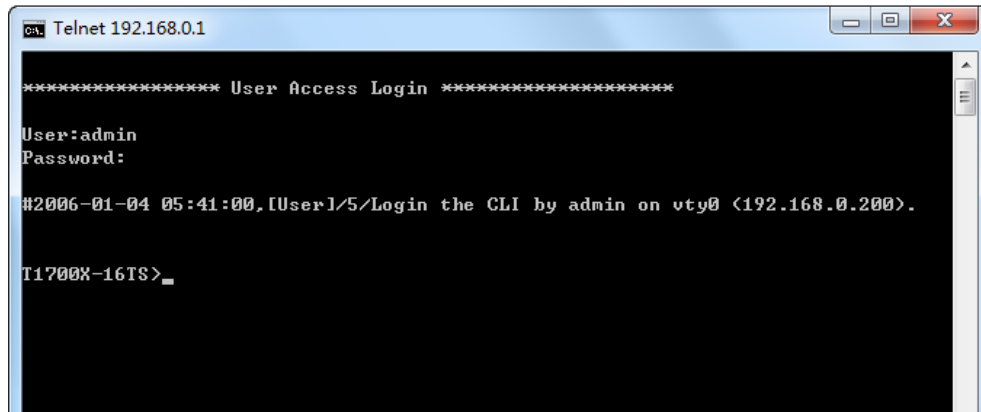

Figure 1-2 Log in the Switch

4. Type in **enable** command to enter Privileged EXEC Mode.

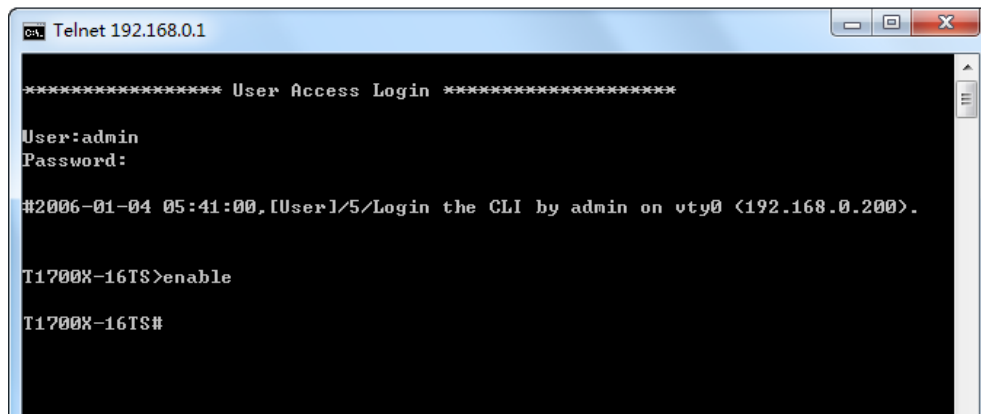

Figure 1-3 Enter into Priviledged EXEC Mode

### 1.1.2 Logon by SSH

To log on by SSH, a Putty client software is recommended. There are two authentication modes to set up an SSH connection:

**Password Authentication Mode:** It requires username and password, which are both **admin** by default.

**Key Authentication Mode:** It requires a public key for the switch and a private key for the SSH client software. You can generate the public key and the private key through Putty Key Generator.

#### **Note:**

Before SSH login, please follow the steps shown in Figure 1-4 to enable the SSH function through Telnet connection.

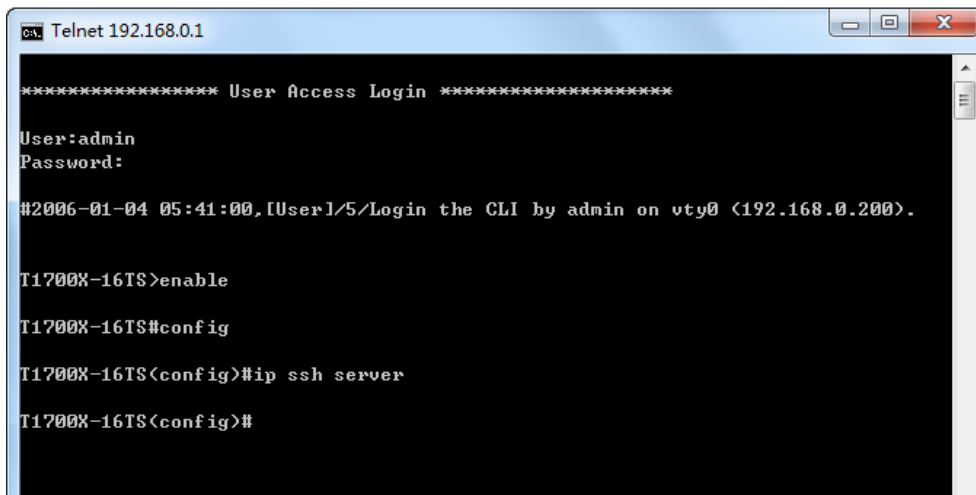

Figure 1-4 Enable SSH function

➤ **Password Authentication Mode**

1. Open the software to log on to the interface of PuTTY. Enter the IP address of the switch into **Host Name** field; keep the default value 22 in the **Port** field; select **SSH** as the Connection type.

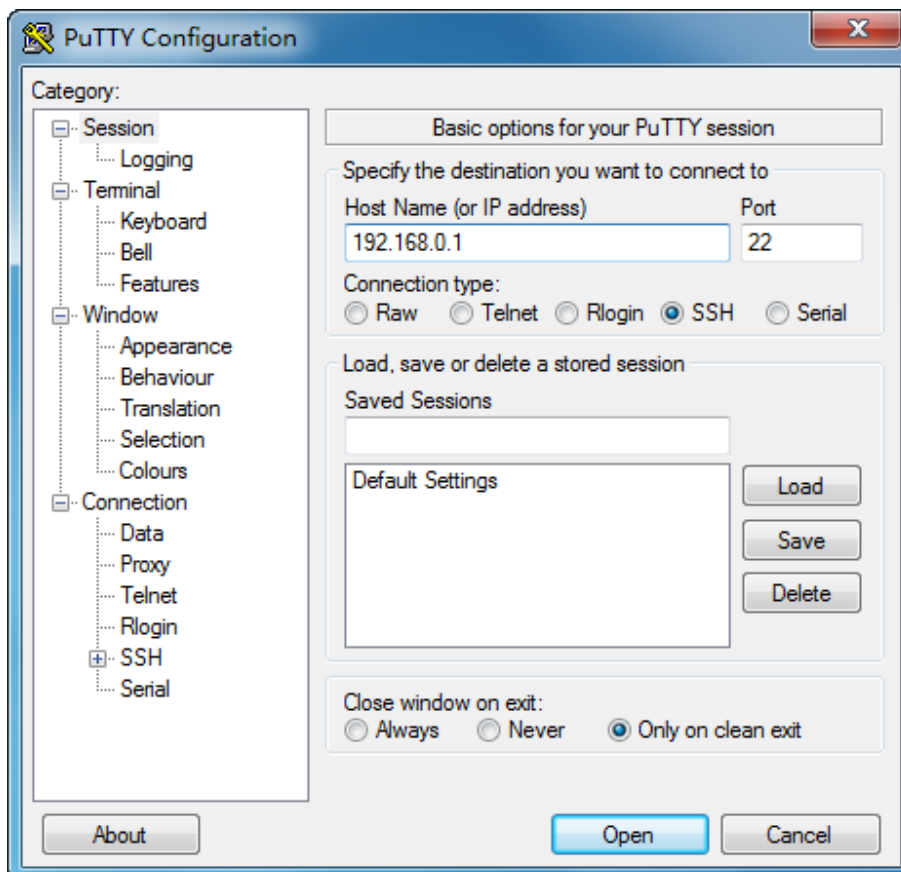

Figure 1-5 SSH Connection Config

2. Click the **Open** button in the above figure to log on to the switch. Enter the login user name and password to log on the switch, and then enter enable to enter Privileged EXEC Mode, so you can continue to configure the switch.

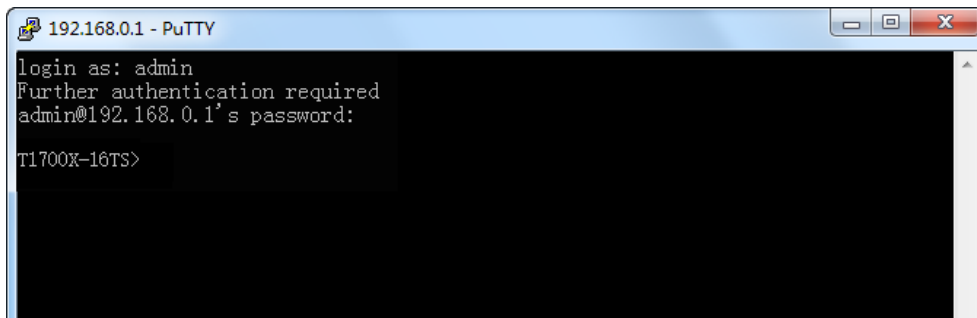

Figure 1-6 Log on the Switch

### ➤ Key Authentication Mode

1. Select the key type and key length, and generate SSH key.

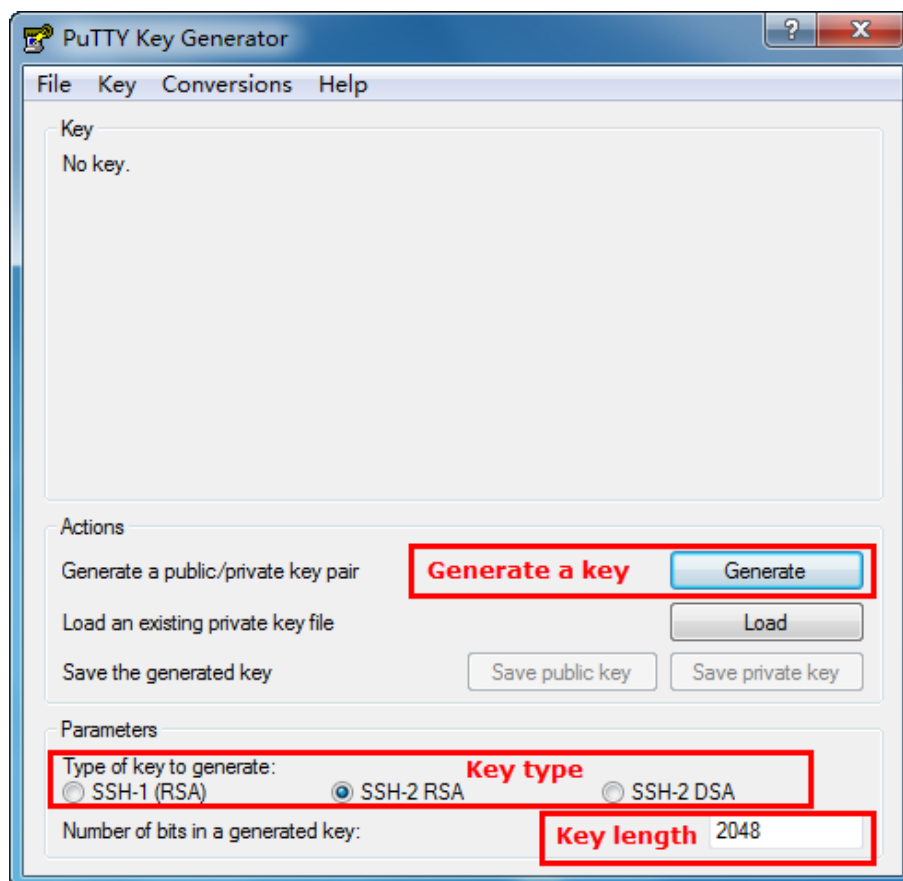

Figure 1-7 Generate SSH Key

### ⚠ Note:

1. The key length is in the range of 512 to 3072 bits.
2. During the key generation, randomly moving the mouse quickly can accelerate the key generation.

2. After the key is successfully generated, please save the public key and private key to a TFTP server.

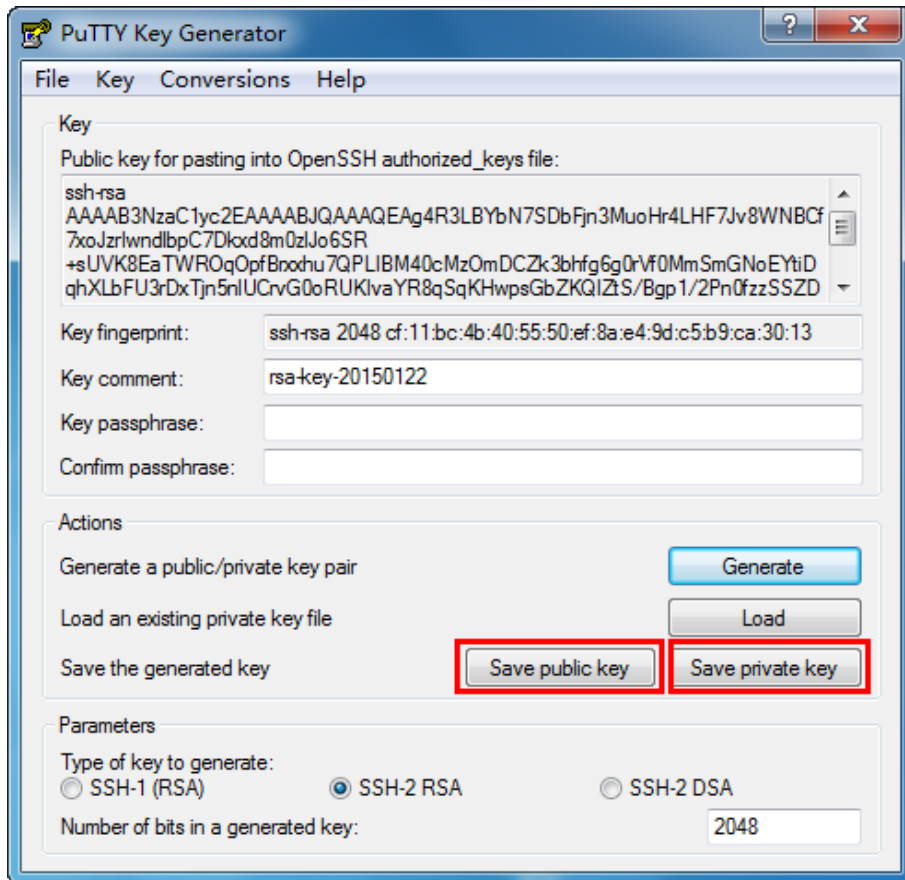

Figure 1-8 Save the Generated Key

3. Log on to the switch by Telnet and download the public key file from the TFTP server to the switch, as the following figure shows:



Figure 1-9 Download the Public Key



**Note:**

1. The key type should accord with the type of the key file.
2. The SSH key downloading can not be interrupted.
4. After the public key is downloaded, please log on to the interface of PuTTY and enter the IP address for login.

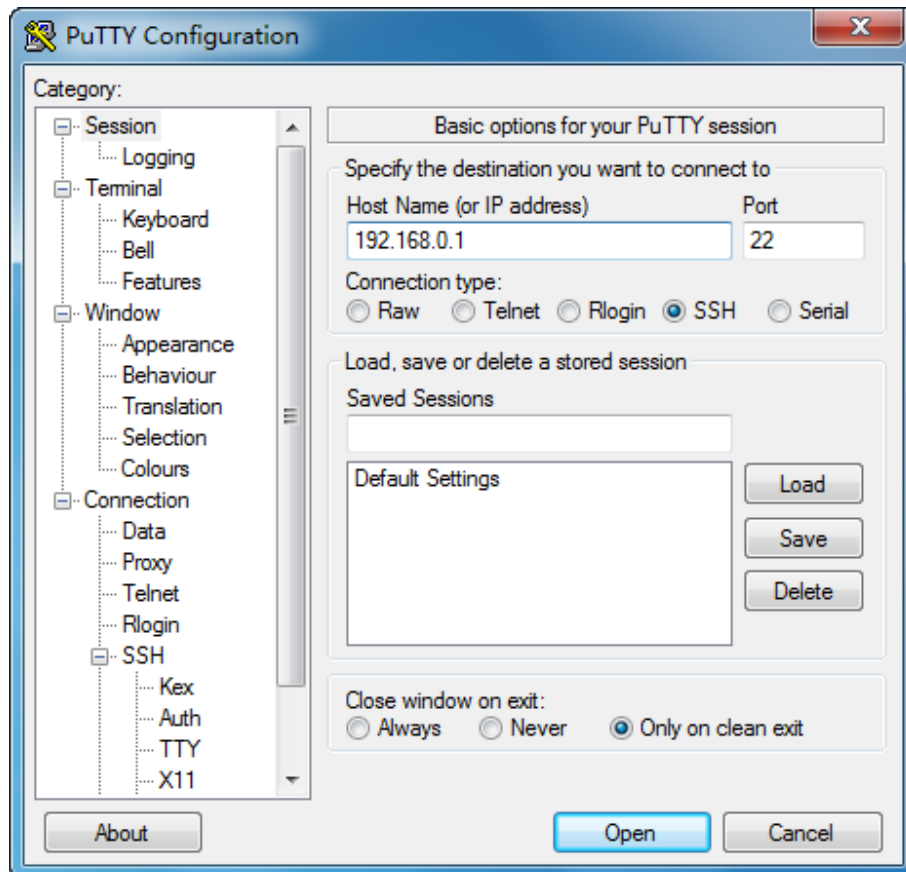

Figure 1-10 SSH Connection Config

5. Click **Browse** to download the private key file to SSH client software and click **Open**.

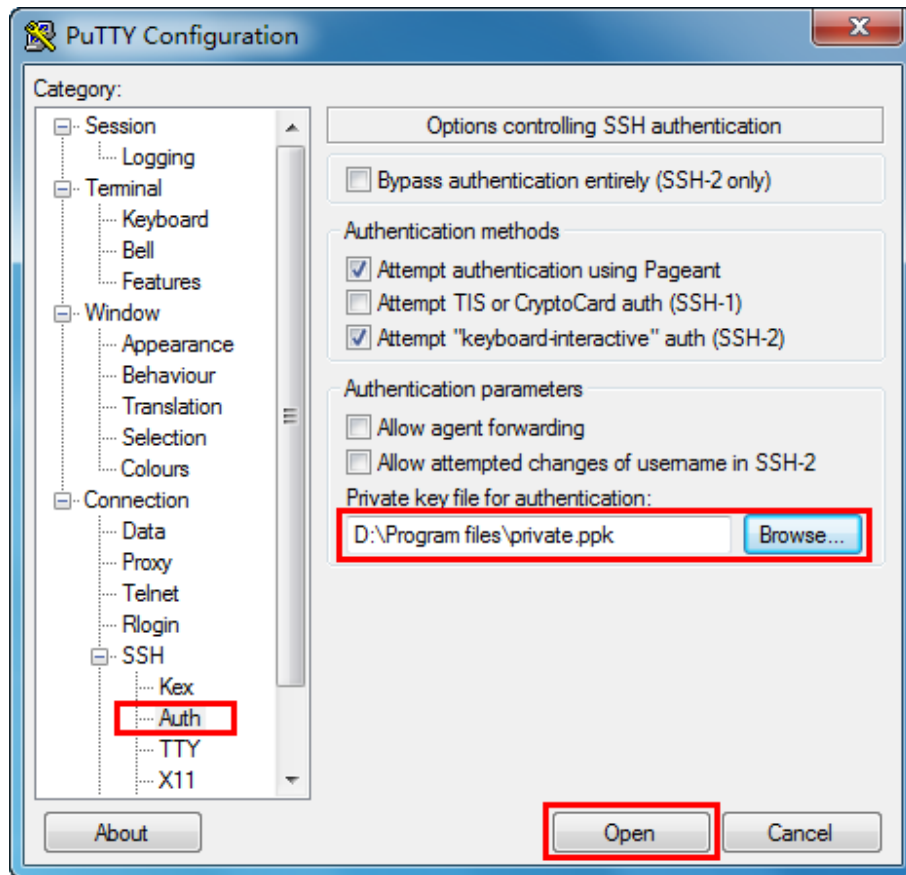

Figure 1-11 Download the Private Key

6. After successful authentication, please enter the login user name. If you log on to the switch without entering password, it indicates that the key has been successfully downloaded.

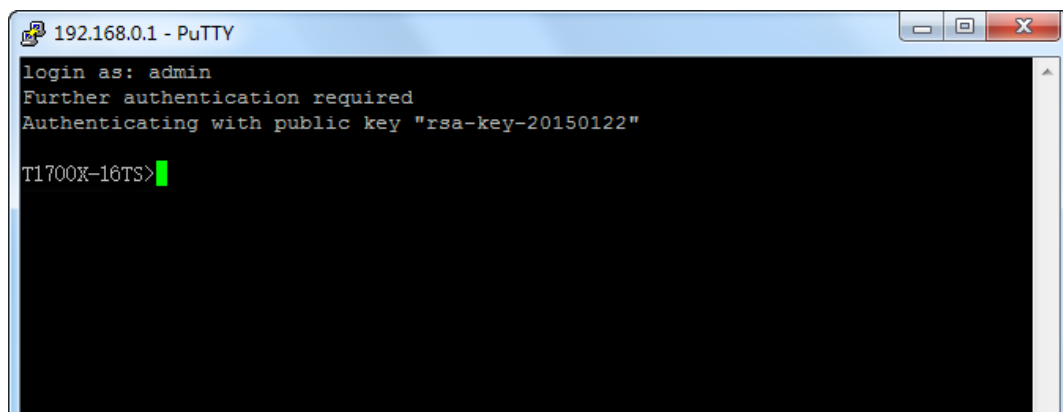
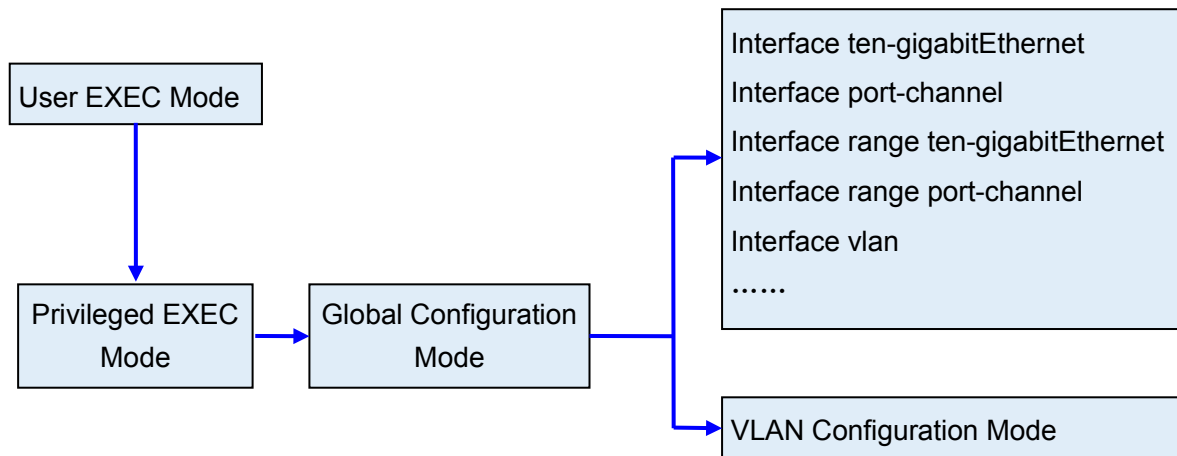

Figure 1-12 Log on the Switch

## 1.2 CLI Command Modes

The CLI is divided into different command modes: User EXEC Mode, Privileged EXEC Mode, Global Configuration Mode, Interface Configuration Mode and VLAN Configuration Mode.

Interface Configuration Mode can also be divided into Interface Ethernet, Interface link-aggregation and some other modes, which is shown as the following diagram.



The following table gives detailed information about the Accessing path, Prompt of each mode and how to exit the current mode and access the next mode.

Mode	Accessing Path	Prompt	Logout or Access the next mode
User EXEC Mode	Primary mode once it is connected with the switch.	<b>T1700X-16TS&gt;</b>	Use the <b>exit</b> command to disconnect the switch. Use the <b>enable</b> command to access Privileged EXEC mode.
Privileged EXEC Mode	Use the <b>enable</b> command to enter this mode from User EXEC mode.	<b>T1700X-16TS#</b>	Enter the <b>exit</b> command to return to User EXEC mode. Enter <b>configure</b> command to access Global Configuration mode.
Global Configuration Mode	Use the <b>configure</b> command to enter this mode from Privileged EXEC mode.	<b>T1700X-16TS (config)#</b>	Use the <b>exit</b> or the <b>end</b> command or press <b>Ctrl+Z</b> to return to Privileged EXEC mode. Use the <b>interface ten-gigabitEthernet port</b> or <b>interface range ten-gigabitEthernet port-list</b> command to access interface Configuration mode. Use the <b>vlan vlan-list</b> to access VLAN Configuration mode.

Mode	Accessing Path	Prompt	Logout or Access the next mode
Interface Configuration Mode	Layer 2 Interface: Use the <b>interface ten-gigabitEthernet port</b> , <b>interface port-channel lagid</b> , <b>interface range ten-gigabitEthernet port-list</b> or <b>interface port-channel lag-list</b> command to enter this mode from Global Configuration mode.	<b>T1700X-16TS (config-if)#</b>  or <b>T1700X-16TS(config-if-range)#</b>	Use the <b>end</b> command or press <b>Ctrl+Z</b> to return to Privileged EXEC mode. Enter the <b>exit</b> or the <b>#</b> command to return to Global Configuration mode. A port number must be specified in the <b>interface</b> command.
Interface Configuration Mode	Layer 3 Interface: Use the <b>no switchport</b> command to enter Routed Port mode from Interface Configuration mode. Use the <b>interface vlan vlan-id</b> command to enter VLAN Interface mode from Global Configuration mode. Use the <b>interface loopback id</b> command to enter Loopback Interface mode from Global Configuration mode.	<b>T1700X-16TS (config-if)#</b>  or <b>T1700X-16TS(config-if-range)#</b>	Use the <b>switchport</b> command to switch to the Layer 2 interface mode. Use the <b>end</b> command or press <b>Ctrl+Z</b> to return to Privileged EXEC mode. Enter the <b>exit</b> or the <b>#</b> command to return to Global Configuration mode.
VLAN Configuration Mode	Use the <b>vlan vlan-list</b> command to enter this mode from Global Configuration mode.	<b>T1700X-16TS (config-vlan)#</b>	Use the <b>end</b> command or press <b>Ctrl+Z</b> to return to Privileged EXEC mode. Enter the <b>exit</b> command or the <b>#</b> command to return to Global configuration mode.



**Note:**

1. The user is automatically in User EXEC Mode after the connection between the PC and the switch is established by a Telnet/SSH connection.
2. Each command mode has its own set of specific commands. To configure some commands, you should access the corresponding command mode firstly.

- **Global Configuration Mode:** In this mode, global commands are provided, such as the Spanning Tree, Schedule Mode and so on.
  - **Interface Configuration Mode:** In this mode, users can configure one or several ports, different ports corresponds to different commands
    - a). Interface ten-gigabitEthernet: Configure parameters for an Ethernet port, such as Duplex-mode, flow control status.
    - b). Interface range ten-gigabitEthernet: Configure parameters for several Ethernet ports.
    - c). Interface port-channel: Configure parameters for a Ethernet channel.
    - d). Interface range port-channel: Configure parameters for several Ethernet channels.
    - e). Interface vlan: Configure parameters for the vlan-port.
  - **VLAN Configuration Mode:** In this mode, users can create a VLAN and add a specified port to the VLAN.
3. Some commands are global, that means they can be performed in all modes:
- **show:** display all information of switch, for example: statistic information, port information, VLAN information.
  - **history:** Display the commands history.

## 1.3 Security Levels

This switch's security is divided into two levels: User level and Admin level.

User level only allows users to do some simple operations in User EXEC Mode; Admin level allows you to monitor, configure and manage the switch in Privileged EXEC Mode, Global Configuration Mode, Interface Configuration Mode and VLAN Configuration Mode.

Users get the privilege to the User level once logging in by Telnet/SSH. However, Guest users are restricted to access the CLI.

Users can enter Privileged EXEC mode from User EXEC mode by using the **enable** command. In default case, no password is needed. In Global Configuration Mode, you can configure password for Admin level by **enable password** command. Once password is configured, you are required to enter it to access Privileged EXEC mode.

## 1.4 Conventions

### 1.4.1 Format Conventions

The following conventions are used in this Guide:

- Items in square brackets [ ] are optional
- Items in braces { } are required
- Alternative items are grouped in braces and separated by vertical bars. For example: **speed** { auto | 100 | 1000 | 10000 }
- Bold indicates an unalterable keyword. For example: **show logging**
- Normal Font indicates a constant (several options are enumerated and only one can be selected). For example: **mode** {dynamic | static | permanent}
- Italic Font indicates a variable (an actual value must be assigned). For example: **bridge aging-time** *aging-time*

### 1.4.2 Special Characters

You should pay attention to the description below if the variable is a character string:

- These six characters " < > , \ & can not be input.
- If a blank is contained in a character string, single or double quotation marks should be used, for example 'hello world', "hello world", and the words in the quotation marks will be identified as a string. Otherwise, the words will be identified as several strings.

### 1.4.3 Parameter Format

Some parameters must be entered in special formats which are shown as follows:

- MAC address must be entered in the format of xx:xx:xx:xx:xx:xx.
- One or several values can be typed for a port-list or a vlan-list using comma to separate. Use a hyphen to designate a range of values, for instance, 1/0/1, 1/0/3-5, 1/0/7 indicates choosing port 1/0/1, 1/0/3, 1/0/4, 1/0/5, 1/0/7.

## Chapter 2 User Interface

### 2.1 enable

#### Description

The **enable** command is used to access Privileged EXEC Mode from User EXEC Mode.

#### Syntax

**enable**

#### Command Mode

User EXEC Mode

#### Privilege Requirement

None.

#### Example

If you have set the password to access Privileged EXEC Mode from User EXEC Mode:

```
T1700X-16TS>enable
Password:
T1700X-16TS#
```

### 2.2 service password-encryption

#### Description

The **service password-encryption** command is used to encrypt the password when the password is defined or when the configuration is written, using the symmetric encryption algorithm. Encryption prevents the password from being readable in the configuration file. To disable the global encryption function, please use **no service password-encryption** command.

#### Syntax

**service password-encryption**  
**no service password-encryption**

#### Command Mode

Global Configuration Mode

## Privilege Requirement

Only Admin level users have access to these commands.

## Example

Enable the global encryption function:

```
T1700X-16TS(config)# service password-encryption
```

## 2.3 enable password

### Description

The **enable password** command is used to set or change the password for users to access Privileged EXEC Mode from User EXEC Mode. To remove the password, please use **no enable password** command. This command uses the symmetric encryption.

### Syntax

```
enable password { [ 0 ] password | 7 encrypted-password }  
no enable password
```

### Parameter

0 — Specify the encryption type. 0 indicates that an unencrypted password will follow. By default, the encryption type is 0.

*password* — Super password, a string from 1 to 31 alphanumeric characters or symbols. The password is case sensitive, allows digits, English letters (case sensitive), underlines and sixteen special characters ( ! \$ % ' ( ) \* , - . / [ ] { } ). By default, it is empty.

7 — Indicates a symmetric encrypted password with fixed length will follow.

*encrypted-password* — A symmetric encrypted password with fixed length, which you can copy from another switch's configuration file. After the encrypted password is configured, you should use the corresponding unencrypted password if you re-enter this mode.

### Command Mode

Global Configuration Mode

### Privilege Requirement

Only Admin level users have access to these commands.



## User Guidelines

If the password you configured here is unencrypted and the global encryption function is enabled in [service password-encryption](#), the password in the configuration file will be displayed in the symmetric encrypted form.

## Example

Set the super password as “admin” and unencrypted to access Privileged EXEC Mode from User EXEC Mode:

```
T1700X-16TS(config)#enable password 0 admin
```

## 2.4 enable secret

### Description

The **enable secret** command is used to set a secret password, which is using an MD5 encryption algorithm, for users to access Privileged EXEC Mode from User EXEC Mode. To return to the default configuration, please use **no enable secret** command. This command uses the MD5 encryption.

### Syntax

```
enable secret { [ 0 ] password | 5 encrypted-password }  
no enable secret
```

### Parameter

0 — Specify the encryption type. 0 indicates that an unencrypted password will follow. By default, the encryption type is 0.

*password* — Super password, a string from 1 to 31 alphanumeric characters or symbols. The password is case sensitive, allows digits, English letters (case sensitive), underlines and sixteen special characters ( ! \$ % ' ( ) \* , - . / [ ] { } ). By default, it is empty. The password in the configuration file will be displayed in the MD5 encrypted form.

5 — Indicates an MD5 encrypted password with fixed length will follow.

*encrypted-password* — An MD5 encrypted password with fixed length, which you can copy from another switch’s configuration file. After the encrypted password is configured, you should use the corresponding unencrypted password if you re-enter this mode.

### Command Mode

Global Configuration Mode

## Privilege Requirement

Only Admin level users have access to these commands.

## User Guidelines

If both the **enable password** and **enable secret** are defined, you must enter the password set in **enable secret**.

## Example

Set the secret password as “admin” and unencrypted to access Privileged EXEC Mode from User EXEC Mode. The password will be displayed in the encrypted form.

```
T1700X-16TS(config)#enable secret 0 admin
```

## 2.5 configure

### Description

The **configure** command is used to access Global Configuration Mode from Privileged EXEC Mode.

### Syntax

```
configure
```

### Command Mode

Privileged EXEC Mode

### Privilege Requirement

Only Admin, Operator and Power User level users have access to these commands.

### Example

Access Global Configuration Mode from Privileged EXEC Mode:

```
T1700X-16TS# configure
T1700X-16TS(config)#
```

## 2.6 exit

### Description

The **exit** command is used to return to the previous Mode from the current Mode.

### Syntax

```
exit
```

## Command Mode

Privileged EXEC Mode and Any Configuration Mode

## Privilege Requirement

None.

## Example

Return to Global Configuration Mode from Interface Configuration Mode, and then return to Privileged EXEC Mode:

```
T1700X-16TS(config-if)# exit
T1700X-16TS(config)#exit
T1700X-16TS#
```

## 2.7 end

### Description

The **end** command is used to return to Privileged EXEC Mode.

### Syntax

```
end
```

### Command Mode

Privileged EXEC Mode and Any Configuration Mode

### Privilege Requirement

Only Admin level users have access to these commands.

### Example

Return to Privileged EXEC Mode from Interface Configuration Mode:

```
T1700X-16TS(config-if)#end
T1700X-16TS#
```

## 2.8 history

### Description

The **history** command is used to show the latest 20 commands you entered in the current mode since the switch is powered.

### Syntax

```
history
```

### Command Mode

Privileged EXEC Mode and any Configuration Mode

## Privilege Requirement

None.

## Example

Show the commands you have entered in the current mode:

```
T1700X-16TS (config)# history  
1 history
```

## 2.9 history clear

### Description

The **history clear** command is used to clear the commands you have entered in the current mode, therefore these commands will not be shown next time you use the **history** command.

### Syntax

```
history clear
```

### Command Mode

Privileged EXEC Mode and any Configuration Mode

### Privilege Requirement

Only Admin, Operator and Power User level users have access to these commands.

## Example

Clear the commands you have entered in the current mode:

```
T1700X-16TS(config)#history clear
```

## Chapter 3 IEEE 802.1Q VLAN Commands

VLAN (Virtual Local Area Network) technology is developed for the switch to divide the LAN into multiple logical LANs flexibly. Hosts in the same VLAN can communicate with each other, regardless of their physical locations. VLAN can enhance performance by conserving bandwidth, and improve security by limiting traffic to specific domains.

### 3.1 vlan

#### Description

The **vlan** command is used to create IEEE 802.1Q VLAN and enter VLAN Configuration Mode. To delete the IEEE 802.1Q VLAN, please use **no vlan** command.

#### Syntax

```
vlan vlan-list
no vlan vlan-list
```

#### Parameter

*vlan-list* — Specify IEEE 802.1Q VLAN ID list, ranging from 2 to 4094, in the format of 2-3, 5. It is multi-optional.

#### Command Mode

Global Configuration Mode

#### Privilege Requirement

Only Admin, Operator and Power User level users have access to these commands.

#### Example

Create VLAN 2-10 and VLAN 100:

```
T1700X-16TS(config)# vlan 2-10,100
```

Delete VLAN 2:

```
T1700X-16TS(config)# no vlan 2
```

### 3.2 interface vlan

#### Description

The **interface vlan** command is used to create VLAN Interface and enter Interface VLAN Mode. To delete VLAN Interface, please use **no interface vlan** command.

## Syntax

```
interface vlan vlan-id  
no interface vlan vlan-id
```

## Parameter

*vlan-id* — Specify IEEE 802.1Q VLAN ID, ranging from 1 to 4094.

## Command Mode

Global Configuration Mode

## Privilege Requirement

Only Admin, Operator and Power User level users have access to these commands.

## Example

Create VLAN Interface 2:

```
T1700X-16TS(config)# interface vlan 2
```

## 3.3 name

### Description

The **name** command is used to assign a description to a VLAN. To clear the description, please use **no name** command.

### Syntax

```
name descript  
no name
```

### Parameter

*descript* —String to describe the VLAN, which contains 16 characters at most.

### Command Mode

VLAN Configuration Mode(VLAN)

### Privilege Requirement

Only Admin, Operator and Power User level users have access to these commands.

### Example

Specify the name of VLAN 2 as “group1”:

```
T1700X-16TS(config)# vlan 2  
T1700X-16TS(config-vlan)# name group1
```

## 3.4 switchport general allowed vlan

### Description

The **switchport general allowed vlan** command is used to add the desired General port to IEEE 802.1Q VLAN and specify the port's type. To delete the corresponding VLAN(s), please use **no switchport general allowed vlan** command.

### Syntax

```
switchport general allowed vlan vlan-list { tagged | untagged }  
no switchport general allowed vlan vlan-list
```

### Parameter

*vlan-list* — Specify IEEE 802.1Q VLAN ID list, ranging from 2 to 4094, in the format of 2-3, 5. It is multi-optional.

tagged | untagged — Egress rule, untagged or tagged. Tagged: All packets forwarded by the port are tagged. The packets contain VLAN information. Untagged: Packets forwarded by the port are untagged.

### Command Mode

Interface Configuration Mode (interface ten-gigabitEthernet / interface range ten-gigabitEthernet / interface port-channel / interface range port-channel)

### Privilege Requirement

Only Admin, Operator and Power User level users have access to these commands.

### Example

Add port 4 it to VLAN 2 and configure the type of port 1/0/4 as tagged:

```
T1700X-16TS(config)# interface ten-gigabitEthernet 1/0/4  
T1700X-16TS(config-if)# switchport general allowed vlan 2 tagged
```

## 3.5 switchport pvid

### Description

The **switchport pvid** command is used to configure the PVID for the switch ports.

### Syntax

```
switchport pvid vlan-id
```

### Parameter

*vlan-id* — VLAN ID, ranging from 1 to 4094.

## Command Mode

Interface Configuration Mode (interface ten-gigabitEthernet / interface range ten-gigabitEthernet / interface port-channel / interface range port-channel)

## Privilege Requirement

Only Admin, Operator and Power User level users have access to these commands.

## Example

Specify the PVID of port 1/0/2 as 2:

```
T1700X-16TS(config)# interface ten-gigabitEthernet 1/0/2
T1700X-16TS(config-if)# switchport pvid 2
```

## 3.6 show vlan summary

### Description

The **show vlan summary** command is used to display the summarized information of IEEE 802.1Q VLAN.

### Syntax

```
show vlan summary
```

### Command Mode

Privileged EXEC Mode and Any Configuration Mode

### Privilege Requirement

None.

### Example

Display the summarized information of IEEE 802.1Q VLAN:

```
T1700X-16TS(config)# show vlan summary
```

## 3.7 show vlan brief

### Description

The **show vlan brief** command is used to display the brief information of IEEE 802.1Q VLAN.

### Syntax

```
show vlan brief
```



## Command Mode

Privileged EXEC Mode and Any Configuration Mode

## Privilege Requirement

None.

## Example

Display the brief information of IEEE 802.1Q VLAN:

```
T1700X-16TS(config)# show vlan brief
```

## 3.8 show vlan

### Description

The **show vlan** command is used to display the information of IEEE 802.1Q VLAN.

### Syntax

```
show vlan [ id vlan-id ]
```

### Parameter

*vlan-id* — Specify IEEE 802.1Q VLAN ID, ranging from 1 to 4094. It is multi-optional. Using the **show vlan** command without parameter displays the detailed information of all VLANs.

## Command Mode

Privileged EXEC Mode and Any Configuration Mode

## Privilege Requirement

None.

## Example

Display the information of vlan 5:

```
T1700X-16TS(config)# show vlan id 5
```

## 3.9 show interface switchport

### Description

The **show interface switchport** command is used to display the IEEE 802.1Q VLAN configuration information of the specified port/LAG.

### Syntax

```
show interface switchport [ ten-gigabitEthernet port | port-channel lagid ]
```

## Parameter

*port* — The port number.

*lagid* — The ID of the LAG.

## Command Mode

Privileged EXEC Mode and Any Configuration Mode

## Privilege Requirement

None.

## Example

Display the VLAN configuration information of all ports and LAGs:

```
T1700X-16TS(config)# show interface switchport
```

## Chapter 4 MAC-based VLAN Commands

MAC VLAN (Virtual Local Area Network) is the way to classify the VLANs based on MAC Address. A MAC address is relative to a single VLAN ID. The untagged packets and the priority-tagged packets coming from the MAC address will be tagged with this VLAN ID.

### 4.1 mac-vlan mac-address

#### Description

The **mac-vlan mac-address** command is used to create a MAC-based VLAN entry. To delete a MAC-based VLAN entry, please use the **no mac-vlan mac-address** command.

#### Syntax

```
mac-vlan mac-address mac-addr vlan vlan-id [description descript]
```

```
no mac-vlan mac-address mac-addr
```

#### Parameter

*mac-addr* — MAC address, in the format of XX:XX:XX:XX:XX:XX.

*vlan-id* — Specify IEEE 802.1Q VLAN ID, ranging from 1 to 4094.

*descript* — Give a description to the MAC address for identification, which contains 8 characters at most.

#### Command Mode

Global Configuration Mode

#### Privilege Requirement

Only Admin, Operator and Power User level users have access to these commands.

#### Example

Create VLAN 2 with the MAC address 00:11:11:01:01:12 and the name "TP":

```
T1700X-16TS(config)#mac-vlan mac-address 00:11:11:01:01:12 vlan 2  
description TP
```

## 4.2 mac-vlan

### Description

The **mac-vlan** command is used to enable a port for the MAC-based VLAN feature. Only the port is enabled can the configured MAC-based VLAN take effect. To disable the MAC-based VLAN function, please use **no mac-vlan** command. All the ports are disabled by default.

### Syntax

```
mac-vlan
no mac-vlan
```

### Command Mode

Interface Configuration Mode (interface ten- gigabitEthernet / interface range ten- gigabitEthernet)

### Privilege Requirement

Only Admin, Operator and Power User level users have access to these commands.

### Example

Enable the Gigabit Ethernet port 1/0/3 for the MAC-based VLAN feature:

```
T1700X-16TS(config)#interface ten-gigabitEthernet 1/0/3
T1700X-16TS(config-if)#mac-vlan
```

## 4.3 show mac-vlan

### Description

The **show mac-vlan** command is used to display the information of the MAC-based VLAN entry. MAC address and VLAN ID can be used to filter the displayed information.

### Syntax

```
show mac-vlan { all | mac-address mac-addr | vlan vlan-id }
```

### Command Mode

Privileged EXEC Mode and Any Configuration Mode

## Privilege Requirement

None.

## Parameter

*mac-addr* — MAC address, in the format of XX:XX:XX:XX:XX:XX.

*vlan-id* — Specify IEEE 802.1Q VLAN ID, ranging from 1 to 4094.

## Example

Display the information of all the MAC-based VLAN entry:

```
T1700X-16TS(config)#show mac-vlan all
```

## 4.4 show mac-vlan interface

### Description

The **show mac-vlan interface** command is used to display the port state of MAC-based VLAN.

### Syntax

```
show mac-vlan interface
```

### Command Mode

Privileged EXEC Mode and Any Configuration Mode.

### Privilege Requirement

None.

### Example

Display the enable state of all the ports:

```
T1700X-16TS(config)#show mac-vlan interface
```

## Chapter 5 Protocol VLAN Commands

Protocol-based VLAN (Virtual Local Area Network) is the way to classify VLANs based on Protocols. A Protocol corresponds to a VLAN ID. The untagged packets and the priority-tagged packets matching the protocol template will be tagged with this VLAN ID.

### 5.1 protocol-vlan template

#### Description

The **protocol-vlan template** command is used to create Protocol-based VLAN template. To delete Protocol-based VLAN template, please use **no protocol-vlan template** command.

#### Syntax

```
protocol-vlan template name protocol-name frame { ether_2 ether-type type | snap ether-type type | llc dsap dsap_type ssap ssap_type }  
no protocol-vlan template template-idx
```

#### Parameter

*protocol-name* — Give a name for the Protocol-based VLAN Template , which contains 8 characters at most.

**ether\_2 ether-type type** — Specify the Ethernet type.

**snap ether-type type** — Specify the Ethernet type.

**llc dsap dsap\_type ssap ssap\_type** — Specify the DSAP type and the SSAP type.

*template-idx* — The number of the Protocol-based VLAN Template. You can get the template corresponding to the number by the [show protocol-vlan template](#) command.

#### Command Mode

Global Configuration Mode

#### Privilege Requirement

Only Admin, Operator and Power User level users have access to these commands.

## Example

Create a Protocol-based VLAN template named “TP” whose Ethernet protocol type is 0x2024:

```
T1700X-16TS(config)#protocol-vlan template name TP frame ether_2
ether-type 2024
```

## 5.2 protocol-vlan vlan

### Description

The **protocol-vlan vlan** command is used to create a Protocol-based VLAN. To delete a Protocol-based VLAN, please use **no protocol-vlan** command.

### Syntax

```
protocol-vlan vlan vlan-id { template template-idx }
no protocol-vlan vlan group-idx
```

### Parameter

*vlan-vid* —— Specify IEEE 802.1Q VLAN ID, ranging from 1-4094.

*template-idx* ——The number of the Protocol-based VLAN Template. You can get the template corresponding to the number by the [show protocol-vlan template](#) command.

*group-idx* ——The number of the Protocol-based VLAN entry. You can get the Protocol-based VLAN entry corresponding to the number by the [show protocol-vlan vlan](#) command.

### Command Mode

Global Configuration Mode

### Privilege Requirement

Only Admin, Operator and Power User level users have access to these commands.

### Example

Create Protocol-based VLAN 2 and bind it with Protocol-based VLAN Template 3:

```
T1700X-16TS(config)# protocol-vlan vlan 2 template 3
```

## 5.3 protocol-vlan group

### Description

The **protocol-vlan group** command is used to add the port to a specified protocol group. To remove the port from this protocol group, please use **no protocol-vlan group** command.

### Syntax

```
protocol-vlan group index  
no protocol-vlan group index
```

### Command Mode

Interface Configuration Mode (interface ten-gigabitEthernet / interface range ten-gigabitEthernet)

### Privilege Requirement

Only Admin, Operator and Power User level users have access to these commands.

### Parameter

*index* — Specify the protocol group ID.

### Example

Add Ten-Gigabit Ethernet port 1/0/12 to protocol group 1:

```
T1700X-16TS(config)#interface ten-gigabitEthernet 1/0/12  
T1700X-16TS(config-if)#protocol-vlan group 1
```

## 5.4 show protocol-vlan template

### Description

The **show protocol-vlan template** command is used to display the information of the Protocol-based VLAN templates.

### Syntax

```
show protocol-vlan template
```

### Command Mode

Privileged EXEC Mode and Any Configuration Mode



## Privilege Requirement

None.

## Example

Display the information of the Protocol-based VLAN templates:

```
T1700X-16TS(config)# show protocol-vlan template
```

# 5.5 show protocol-vlan vlan

## Description

The **show protocol-vlan vlan** command is used to display the information about Protocol-based VLAN entry.

## Syntax

```
show protocol-vlan vlan
```

## Command Mode

Privileged EXEC Mode and Any Configuration Mode

## Privilege Requirement

None.

## Example

Display information of the Protocol-based VLAN entry:

```
T1700X-16TS(config)# show protocol-vlan vlan
```

## Chapter 6 Voice VLAN Commands

Voice VLANs are configured specially for voice data stream. By configuring Voice VLANs and adding the ports with voice devices attached to voice VLANs, you can perform QoS-related configuration for voice data, ensuring the transmission priority of voice data stream and voice quality.

### 6.1 voice vlan

#### Description

The **voice vlan** command is used to enable Voice VLAN function. To disable Voice VLAN function, please use **no voice vlan** command.

#### Syntax

**voice vlan** *vlan-id*

**no voice vlan**

#### Parameter

*vlan-id* —— Specify IEEE 802.1Q VLAN ID, ranging from 2 to 4094.

#### Command Mode

Global Configuration Mode

#### Privilege Requirement

Only Admin, Operator and Power User level users have access to these commands.

#### Example

Enable the Voice VLAN function for VLAN 10:

```
T1700X-16TS(config)# voice vlan 10
```

### 6.2 voice vlan aging

#### Description

The **voice vlan aging** command is used to set the aging time for a voice VLAN. To restore to the default aging time for the Voice VLAN, please use **no voice vlan aging** command.

#### Syntax

**voice vlan aging** *time*

**no voice vlan aging**

### Parameter

*time* — Aging time (in minutes) to be set for the Voice VLAN. It ranges from 1 to 43200 minutes and the default value is 1440 minutes.

### Command Mode

Global Configuration Mode

### Privilege Requirement

Only Admin, Operator and Power User level users have access to these commands.

### Example

Set the aging time for the Voice VLAN as 1 minute:

```
T1700X-16TS(config)# voice vlan aging 1
```

## 6.3 voice vlan priority

### Description

The **voice vlan priority** command is used to configure the priority for the Voice VLAN. To restore to the default priority, please use **no voice vlan priority** command.

### Syntax

**voice vlan priority** *pri*

**no voice vlan priority**

### Parameter

*pri* — Priority, ranging from 0 to 7, and the default value is 6.

### Command Mode

Global Configuration Mode

### Privilege Requirement

Only Admin, Operator and Power User level users have access to these commands.

### Example

Configure the priority of the Voice VLAN as 5:

```
T1700X-16TS(config)# voice vlan priority 5
```

## 6.4 voice vlan mac-address

### Description

The **voice vlan mac-address** command is used to create Voice VLAN OUI. To delete the specified Voice VLAN OUI, please use **no voice vlan mac-address** command.

### Syntax

**voice vlan mac-address** *mac-addr* **mask** *mask* [ **description** *descript* ]

**no voice vlan mac-address** *mac-addr*

### Parameter

*mac-addr* — The OUI address of the voice device, in the format of XX:XX:XX:XX:XX:XX.

*mask* — The OUI address mask of the voice device, in the format of XX:XX:XX:XX:XX:XX.

*descript* — Give a description to the OUI for identification which contains 16 characters at most.

### Command Mode

Global Configuration Mode

### Privilege Requirement

Only Admin, Operator and Power User level users have access to these commands.

### Example

Create a Voice VLAN OUI described as TP-Phone with the OUI address 00:11:11:11:11:11 and the mask address FF:FF:FF:00:00:00:

```
T1700X-16TS(config)#voice vlan mac-address 00:11:11:11:11:11 mask  
FF:FF:FF:00:00:00 description TP-Phone
```

## 6.5 switchport voice vlan mode

### Description

The **switchport voice vlan mode** command is used to configure the Voice VLAN mode for the Ethernet port.

### Syntax

**switchport voice vlan mode** { manual | auto }

## Parameter

manual | auto — Port mode.

## Command Mode

Interface Configuration Mode (interface ten-gigabitEthernet / interface range ten-gigabitEthernet / interface port-channel / interface range port-channel)

## Privilege Requirement

Only Admin, Operator and Power User level users have access to these commands.

## Example

Configure the port 1/0/3 to operate in the auto voice VLAN mode:

```
T1700X-16TS(config)# interface ten-gigabitEthernet 1/0/3
T1700X-16TS(config-if)# switchport voice vlan mode auto
```

# 6.6 switchport voice vlan security

## Description

The **switchport voice vlan security** command is used to enable the Voice VLAN security feature. To disable the Voice VLAN security feature, please use **no switchport voice vlan security** command.

## Syntax

**switchport voice vlan security**

**no switchport voice vlan security**

## Command Mode

Interface Configuration Mode (interface ten-gigabitEthernet / interface range ten-gigabitEthernet / interface port-channel / interface range port-channel)

## Privilege Requirement

Only Admin, Operator and Power User level users have access to these commands.

## Example

Enable port 1/0/3 for the Voice VLAN security feature:

```
T1700X-16TS(config)# interface ten-gigabitEthernet 1/0/3
T1700X-16TS(config-if)# switchport voice vlan security
```

## 6.7 show voice vlan

### Description

The **show voice vlan** command is used to display the global configuration information of Voice VLAN.

### Syntax

```
show voice vlan
```

### Command Mode

Privileged EXEC Mode and Any Configuration Mode

### Privilege Requirement

Only Admin, Operator and Power User level users have access to these commands.

### Example

Display the configuration information of Voice VLAN globally:

```
T1700X-16TS(config)# show voice vlan
```

## 6.8 show voice vlan oui

### Description

The **show voice vlan oui** command is used to display the configuration information of Voice VLAN OUI.

### Syntax

```
show voice vlan oui
```

### Command Mode

Privileged EXEC Mode and Any Configuration Mode

### Privilege Requirement

Only Admin, Operator and Power User level users have access to these commands.

### Example

Display the configuration information of Voice VLAN OUI:

```
T1700X-16TS(config)# show voice vlan oui
```

## 6.9 show voice vlan switchport

### Description

The **show voice vlan switchport** command is used to display the Voice VLAN configuration information of a specified port/LAG.

### Syntax

```
show voice vlan switchport [ ten-gigabitEthernet port | port-channel lagid ]
```

### Parameter

*port* — The Ethernet port number.

*lagid* — The ID of the LAG.

### Command Mode

Privileged EXEC Mode and Any Configuration Mode

### Privilege Requirement

Only Admin, Operator and Power User level users have access to these commands.

### Example

Display the Voice VLAN configuration information of all ports and LAGs:

```
T1700X-16TS(config)# show voice vlan switchport
```

Display the Voice VLAN configuration information of port 1/0/2:

```
T1700X-16TS(config)# show voice vlan switchport ten-gigabitEthernet  
1/0/2
```

## Chapter 7 Private VLAN Commands

Private VLANs are configured specially for saving VLAN resource of uplink devices and decreasing broadcast.

### 7.1 private-vlan primary

#### Description

The **private-vlan primary** command is used to configure the designated VLAN as the primary VLAN of the Private VLAN. To remove the primary VLAN property of the current VLAN, please use **no private-vlan primary** command.

#### Syntax

```
private-vlan primary  
no private-vlan primary
```

#### Command Mode

VLAN Configuration Mode (VLAN)

#### Privilege Requirement

Only Admin and Operator level users have access to these commands.

#### Example

Configure the VLAN 3 as the primary VLAN of the private VLAN:

```
T1700X-16TS(config)#vlan 3  
T1700X-16TS(config-vlan)#private-vlan primary
```

### 7.2 private-vlan community

#### Description

The **private-vlan community** command is used to configure the designated VLAN as the community VLAN of the Private VLAN. To remove the community VLAN property of the current VLAN, please use **no private-vlan community** command.

#### Syntax

```
private-vlan community
```



**no private-vlan community**

### Command Mode

VLAN Configuration Mode (VLAN)

### Privilege Requirement

Only Admin and Operator level users have access to these commands.

### Example

Configure the VLAN 4 as the community VLAN of the private VLAN:

```
T1700X-16TS(config)#vlan 4
T1700X-16TS(config-vlan)#private-vlan community
```

## 7.3 private-vlan isolated

### Description

The **private-vlan isolated** command is used to configure the designated VLAN as the isolated VLAN of the Private VLAN. To remove the isolated VLAN property of the current VLAN, please use **no private-vlan isolated** command.

### Syntax

```
private-vlan isolated
no private-vlan isolated
```

### Command Mode

VLAN Configuration Mode (VLAN)

### Privilege Requirement

Only Admin and Operator level users have access to these commands.

### Example

Configure the VLAN 3 as the isolated VLAN of the private VLAN:

```
T1700X-16TS(config)#vlan 3
T1700X-16TS(config-vlan)#private-vlan isolated
```

## 7.4 private-vlan association

### Description

The **private-vlan association** command is used to associate primary VLAN with secondary VLAN. To exterminate the currently association, please use **no private-vlan association** command.

### Syntax

```
private-vlan association vlan_list  
no private-vlan association vlan_list
```

### Parameter

*vlan\_list* — Secondary VLAN ID, ranging from 2 to 4094.

### Command Mode

VLAN Configuration Mode (VLAN)

### Privilege Requirement

Only Admin and Operator level users have access to these commands.

### Example

Associate primary VLAN 3 with community VLAN 4 as a private VLAN:

```
T1700X-16TS(config)#vlan 3  
T1700X-16TS(config-vlan)#private-vlan association 4
```

## 7.5 switchport private-vlan

### Description

The **switchport private-vlan** command is used to configure the private VLAN mode for the switchport. To invalid the configuration, please use **no switchport private-vlan** command.

### Syntax

```
switchport private-vlan { promiscuous | host }  
no switchport private-vlan
```

### Parameter

promiscuous | host — Configure the private VLAN mode for the switchport.

## Command Mode

Interface Configuration Mode (interface ten-gigabitEthernet / interface range ten-gigabitEthernet)

## Privilege Requirement

Only Admin and Operator level users have access to these commands.

## Example

Configure the port 1/0/3 as “host”:

```
T1700X-16TS(config)#interface ten-gigabitEthernet 1/0/3
T1700X-16TS(config-if)#switchport private-vlan host
```

# 7.6 switchport private-vlan host-association

## Description

The **switchport private-vlan host-association** command is used to add host type port to private VLAN. To remove the port from Private VLAN, please use **no switchport private-vlan host-association** command.

## Syntax

**switchport private-vlan host-association** *primary\_vlan\_id secondary\_vlan\_id*  
*vlantype*

**no switchport private-vlan host-association**

## Parameter

*primary-vlan-id* — Primary VLAN ID, ranging from 2 to 4094.

*secondary-vlan-id* — Secondary VLAN ID, ranging from 2 to 4094.

*vlantype* — Specify the type of the secondary VLAN, either *community* or *isolated*.

## Command Mode

Interface Configuration Mode (interface ten-gigabitEthernet / interface range ten-gigabitEthernet)

## Privilege Requirement

Only Admin and Operator level users have access to these commands.

## Example

Configure host type port 1/0/3 as a member of primary VLAN 3 and secondary VLAN 4, with the type of VLAN 4 as community:

```
T1700X-16TS(config)#interface ten-gigabitEthernet 1/0/3
T1700X-16TS(config-if)#switchport private-vlan host-association 3 4
community
```

## 7.7 switchport private-vlan mapping

### Description

The **switchport private-vlan mapping** command is used to add promiscuous type port to private VLAN. To remove the port from Private VLAN, please use **no switchport private-vlan mapping** command.

### Syntax

```
switchport private-vlan mapping primary_vlan_id secondary_vlan_id
no switchport private-vlan mapping
```

### Parameter

*primary-vlan-id* — Primary VLAN ID, ranging from 2 to 4094.

*secondary-vlan-id* — Secondary VLAN ID, ranging from 2 to 4094.

### Command Mode

Interface Configuration Mode (interface ten-gigabitEthernet / interface range ten-gigabitEthernet)

### Privilege Requirement

Only Admin and Operator level users have access to these commands.

## Example

Configure promiscuous type port 1/0/3 as a member of primary VLAN 3 and secondary VLAN 4:

```
T1700X-16TS(config)#interface ten-gigabitEthernet 1/0/3
T1700X-16TS(config-if)#switchport private-vlan mapping 3 4
```

## 7.8 show vlan private-vlan

### Description

The **show vlan private-vlan** command is used to display the Private VLAN configuration information of the switch.

### Syntax

```
show vlan private-vlan
```

### Command Mode

Privileged EXEC Mode and Any Configuration Mode

### Privilege Requirement

Only Admin and Operator level users have access to these commands.

### Example

Display the configuration information of all Private VLAN:

```
T1700X-16TS(config)#show vlan private-vlan
```

## 7.9 show vlan private-vlan interface

### Description

The **show vlan private-vlan interface** command is used to display the Private VLAN configuration information of the specified port(s).

### Syntax

```
show vlan private-vlan interface [ ten-gigabitEthernet port ]
```

### Parameter

*port* — The list of Ethernet ports.

### Command Mode

Privileged EXEC Mode and Any Configuration Mode

### Privilege Requirement

Only Admin and Operator level users have access to these commands.

### Example

Display the configuration information of all the Ethernet ports:

```
T1700X-16TS(config)#show vlan private-vlan interface
```

## Chapter 8 Etherchannel Commands

Etherchannel Commands are used to configure LAG and LACP function.

LAG (Link Aggregation Group) is to combine a number of ports together to make a single high-bandwidth data path, which can highly extend the bandwidth. The bandwidth of the LAG is the sum of bandwidth of its member port.

LACP (Link Aggregation Control Protocol) is defined in IEEE802.3ad and enables the dynamic link aggregation and disaggregation by exchanging LACP packets with its partner. The switch can dynamically group similarly configured ports into a single logical link, which will highly extend the bandwidth and flexibly balance the load.

### 8.1 channel-group

#### Description

The **channel-group** command is used to add a port to the EtherChannel Group and configure its mode. To delete the port from the EtherChannel Group, please use **no channel-group** command.

#### Syntax

```
channel-group num mode { on | active | passive }  
no channel-group
```

#### Parameter

*num* — The number of the EtherChannel Group, ranging from 1 to 6.  
on — Enable the static LAG.  
active — Enable the active LACP mode.  
passive — Enable the passive LACP mode.

#### Command Mode

Interface Configuration Mode (interface ten-gigabitEthernet / interface range ten-gigabitEthernet)

#### Privilege Requirement

Only Admin, Operator and Power User level users have access to these commands.

#### Example

Add ports 2-4 to EtherChannel Group 1 and enable the static LAG:

```
T1700X-16TS(config)# interface range ten-gigabitEthernet 1/0/2-4
T1700X-16TS(config-if-range)# channel-group 1 mode on
```

## 8.2 port-channel load-balance

### Description

The **port-channel load-balance** command is used to configure the Aggregate Arithmetic for LAG. To return to the default configurations, please use **no port-channel load-balance** command.

### Syntax

```
port-channel load-balance { src-mac | dst-mac | src-dst-mac | src-ip | dst-ip | src-dst-ip }
```

```
no port-channel load-balance
```

### Parameter

src-mac — The source MAC address. When this option is selected, the Aggregate Arithmetic will be based on the source MAC address of the packets.

dst-mac — The destination MAC address. When this option is selected, the Aggregate Arithmetic will be based on the destination MAC address of the packets.

src-dst-mac — The source and destination MAC address. When this option is selected, the Aggregate Arithmetic will be based on the source and destination MAC addresses of the packets. The Aggregate Arithmetic for LAG is “src-dst-mac” by default.

src-ip — The source IP address. When this option is selected, the Aggregate Arithmetic will be based on the source IP address of the packets.

dst-ip — The destination IP address. When this option is selected, the Aggregate Arithmetic will be based on the destination IP address of the packets.

src-dst-ip — The source and destination IP address. When this option is selected, the Aggregate Arithmetic will be based on the source and destination IP addresses of the packets.

### Command Mode

Global Configuration Mode

## Privilege Requirement

Only Admin, Operator and Power User level users have access to these commands.

## Example

Configure the Aggregate Arithmetic for LAG as "src-dst-ip":

```
T1700X-16TS(config)# port-channel load-balance src-dst-ip
```

## 8.3 lacp system-priority

### Description

The **lacp system-priority** command is used to configure the LACP system priority globally. To return to the default configurations, please use **no lacp system-priority** command.

### Syntax

```
lacp system-priority pri
```

```
no lacp system-priority
```

### Parameter

*pri* — The system priority, ranging from 0 to 65535. It is 32768 by default.

### Command Mode

Global Configuration Mode

### Privilege Requirement

Only Admin, Operator and Power User level users have access to these commands.

### Example

Configure the LACP system priority as 1024 globally:

```
T1700X-16TS(config)# lacp system-priority 1024
```

## 8.4 lacp port-priority

### Description

The **lacp port-priority** command is used to configure the LACP port priority for specified ports. To return to the default configurations, please use **no lacp port-priority** command.



## Syntax

**lacp port-priority** *pri*

**no lacp port-priority**

## Parameter

*pri* — The port priority, ranging from 0 to 65535. It is 32768 by default.

## Command Mode

Interface Configuration Mode (interface ten-gigabitEthernet / interface range ten-gigabitEthernet)

## Privilege Requirement

Only Admin, Operator and Power User level users have access to these commands.

## Example

Configure the LACP port priority as 1024 for ports 1-3:

```
T1700X-16TS(config)# interface range ten-gigabitEthernet 1/0/1-3
```

```
T1700X-16TS(config-if-range)# lacp port-priority 1024
```

Configure the LACP port priority as 2048 for port 4:

```
T1700X-16TS(config)# interface ten-gigabitEthernet 1/0/4
```

```
T1700X-16TS(config-if)# lacp port-priority 2048
```

## 8.5 show etherchannel

### Description

The **show etherchannel** command is used to display the EtherChannel information.

### Syntax

```
show etherchannel [ channel-group-num ] { detail | summary }
```

### Parameter

*channel-group-num* — The EtherChannel Group number, ranging from 1 to 6. By default, it is empty, and will display the information of all EtherChannel Groups.

**detail** — The detailed information of EtherChannel.

**summary** — The EtherChannel information in summary.

## Command Mode

Privileged EXEC Mode and Any Configuration Mode

## Privilege Requirement

None.

## Example

Display the detailed information of EtherChannel Group 1:

```
T1700X-16TS(config)# show etherchannel 1 detail
```

## 8.6 show etherchannel load-balance

### Description

The **show etherchannel load-balance** command is used to display the Aggregate Arithmetic of LAG.

### Syntax

```
show etherchannel load-balance
```

### Command Mode

Privileged EXEC Mode and Any Configuration Mode

### Privilege Requirement

None.

### Example

Display the Aggregate Arithmetic of LAG:

```
T1700X-16TS(config)# show etherchannel load-balance
```

## 8.7 show lacp

### Description

The **show lacp** command is used to display the LACP information for a specified EtherChannel Group.

### Syntax

```
show lacp [ channel-group-num ] { internal | neighbor }
```

### Parameter

*channel-group-num* — The EtherChannel Group number, ranging from 1 to 6. By default, it is empty, and will display the information of all LACP groups.

internal — The internal LACP information.

neighbor — The neighbor LACP information.

### Command Mode

Privileged EXEC Mode and Any Configuration Mode

### Privilege Requirement

None.

### Example

Display the internal LACP information of EtherChannel Group 1:

```
T1700X-16TS(config)# show lacp 1 internal
```

## 8.8 show lacp sys-id

### Description

The **show lacp sys-id** command is used to display the LACP system priority globally.

### Syntax

```
show lacp sys-id
```

### Command Mode

Privileged EXEC Mode and Any Configuration Mode

### Privilege Requirement

None.

### Example

Display the LACP system priority:

```
T1700X-16TS(config)# show lacp sys-id
```

## Chapter 9 User Management Commands

User Manage Commands are used to manage the user's logging information by Web, Telnet or SSH, so as to protect the settings of the switch from being randomly changed.

### 9.1 user name (password)

#### Description

The **user name** command is used to add a new user or modify the existed users' information. To delete the existed users, please use **no user name** command. This command uses the symmetric encryption.

#### Syntax

```
user name name [ privilege admin | operator | power_user | user ] password
{ [ 0 ] password | 7 encrypted-password }

no user name name
```

#### Parameter

*name* —— Type a name for users' login, which contains 16 characters at most, composed of digits, English letters and under dashes only.

admin | operator | power\_user | user —— Access level. “admin” means that you can edit, modify and view all the settings of different functions. “operator” means that you can edit, modify and view most of the settings of different functions. “power-user” means that you can edit, modify and view some of the settings of different functions. “user” means that you can only view some of the settings of different functions without the right to edit or modify. It is “admin” by default. For more details about privilege restrictions, please refer to the **Privilege Requirement** part in each command.

0 —— Specify the encryption type. 0 indicates that an unencrypted password will follow. By default, the encryption type is 0.

*password* —— Users' login password, a string from 1 to 31 alphanumeric characters or symbols. The password is case sensitive, allows digits, English letters (case sensitive), underlines and sixteen special characters ( !\$%()'\*,-./[]{} ).

7 —— Indicates a symmetric encrypted password with fixed length will follow.

*encrypted-password* —— A symmetric encrypted password with fixed length, which you can copy from another switch's configuration file. After the encrypted

password is configured, you should use the corresponding unencrypted password if you re-enter this mode.

## Command Mode

Global Configuration Mode

## Privilege Requirement

Only Admin level users have access to these commands.

## User Guidelines

If the password you configured here is unencrypted and the global encryption function is enabled in [service password-encryption](#), the password in the configuration file will be displayed in the symmetric encrypted form.

## Example

Add and enable a new admin user named “tplink”, of which the password is “admin” and unencrypted:

```
T1700X-16TS(config)#user name tplink privilege admin password 0 admin
```

## 9.2 user name (secret)

### Description

The **user name** command is used to add a new user or modify the existed users' information. To delete the existed users, please use **no user name** command. This command uses the MD5 encryption.

### Syntax

```
user name name [ privilege admin | operator | power_user | user ] secret { [ 0 ]  
password | 5 encrypted-password }
```

```
no user name name
```

### Parameter

*name* ——Type a name for users' login, which contains 16 characters at most, composed of digits, English letters and under dashes only.

admin | operator | power\_user | user —— Access level. “admin” means that you can edit, modify and view all the settings of different functions. “operator” means that you can edit, modify and view most of the the settings of different functions. “power-user” means that you can edit, modify and view some of the the settings of different functions. “user” means that you can only view some of

the the settings of different functions without the right to edit or modify. It is “admin” by default.

0 — Specify the encryption type. 0 indicates that an unencrypted password will follow. By default, the encryption type is 0.

*password* —Users’ login password, a string from 1 to 31 alphanumeric characters or symbols. The password is case sensitive, allows digits, English letters (case sensitive), underlines and sixteen special characters ( !\$%’()\*,-./[]{} ). The password will be saved to the configuration file using the MD5 encrypted algorithm.

5 — Indicates an MD5 encrypted password with fixed length will follow.

*encrypted-password* — An MD5 encrypted password with fixed length, which you can copy from another switch’s configuration file.

## Command Mode

Global Configuration Mode

## Privilege Requirement

Only Admin level users have access to these commands.

## User Guidelines

If both the **user name (password)** and **user name (secret)** are defined, only the latest configured password will take effect.

## Example

Add and enable a new admin user named “tplink”, of which the password is “admin”. The password will be displayed in the encrypted form.

```
T1700X-16TS(config)#user name tplink privilege admin secret 0 admin
```

## 9.3 user access-control ip-based

### Description

The **user access-control ip-based** command is used to limit the IP-range of the users for access. Only the users within the IP-range you set here are allowed to access. To cancel the user access limit, please use **no user access-control** command.

### Syntax

```
user access-control ip-based { ip-addr ip-mask } [ snmp ] [ telnet ] [ ssh ] [ http ]  
[ https ] [ ping ] [ all ]
```

**no user access-control**

### Parameter

*ip-addr* — The source IP address. Only the users within the IP-range you set here are allowed for access.

*ip-mask* — The subnet mask of the IP address.

[ snmp ] [ telnet ] [ ssh ] [ http ] [ https ] [ ping ] [ all ] — Specify the access interface. These interfaces are enabled by default.

### Command Mode

Global Configuration Mode

### Privilege Requirement

Only Admin and Operator level users have access to these commands.

### Example

Enable the access-control of the user whose IP address is 192.168.0.148:

```
T1700X-16TS(config)# user access-control ip-based 192.168.0.148
255.255.255.255
```

## 9.4 user access-control mac-based

### Description

The **user access-control mac-based** command is used to limit the MAC address of the users for access. Only the user with this MAC address you set here is allowed to access. To cancel the user access limit, please use **no user access-control** command.

### Syntax

```
user access-control mac-based { mac-addr } [ snmp ] [ telnet ] [ ssh ] [ http ]
[ https ] [ ping ] [ all ]
```

```
no user access-control
```

### Parameter

*mac-addr* — The source MAC address. Only the user with this MAC address is allowed to access.

[ snmp ] [ telnet ] [ ssh ] [ http ] [ https ] [ ping ] [ all ] — Specify the access interface. These interfaces are enabled by default.

## Command Mode

Global Configuration Mode

## Privilege Requirement

Only Admin and Operator level users have access to these commands.

## Example

Configure that only the user whose MAC address is 00:00:13:0A:00:01 is allowed to access:

```
T1700X-16TS(config)# user access-control mac-based 00:00:13:0A:00:01
```

# 9.5 user access-control port-based

## Description

The **user access-control port-based** command is used to limit the ports for access. Only the users connected to these ports you set here are allowed to access. To disable the port-based user access limit, please use **user access-control port-based interface none** command. To cancel the user access limit, please use **no user access-control** command.

## Syntax

```
user access-control port-based interface { ten-gigabitEthernet port-list }  
[ snmp ] [ telnet ] [ ssh ] [ http ] [ https ] [ ping ] [ all ]  
user access-control port-based interface none  
no user access-control
```

## Parameter

*port-list* — The list group of Ethernet ports, in the format of 1/0/1-4. You can appoint 5 ports at most.

[ **snmp** ] [ **telnet** ] [ **ssh** ] [ **http** ] [ **https** ] [ **ping** ] [ **all** ] — Specify the access interface. These interfaces are enabled by default.

## Command Mode

Global Configuration Mode

## Privilege Requirement

Only Admin and Operator level users have access to these commands.



## Example

Configure that only the users connected to ports 2-6 are allowed to access:

```
T1700X-16TS(config)# user access-control port-based interface  
ten-gigabitEthernet 1/0/2-6
```

## 9.6 telnet

### Description

The **telnet enable** command is used to enable the Telnet function. To disable the Telnet function, please use the **telnet disable** command. This function is enabled by default.

### Syntax

**telnet enable**

**telnet disable**

### Command Mode

Global Configuration Mode

### Privilege Requirement

Only Admin and Operator level users have access to these commands.

### Example

Disable the Telnet function:

```
T1700X-16TS(config)# telnet disable
```

## 9.7 show user account-list

### Description

The **show user account-list** command is used to display the information of the current users.

### Syntax

**show user account-list**

### Command Mode

Privileged EXEC Mode and Any Configuration Mode

## Privilege Requirement

Only Admin level users have access to these commands.

## Example

Display the information of the current users:

```
T1700X-16TS(config)# show user account-list
```

## 9.8 show user configuration

### Description

The **show user configuration** command is used to display the security configuration information of the user authentication information and the access interface.

### Syntax

```
show user configuration
```

### Command Mode

Privileged EXEC Mode and Any Configuration Mode

### Privilege Requirement

None.

### Example

Display the security configuration information of the users:

```
T1700X-16TS(config)# show user configuration
```

## 9.9 show telnet-status

### Description

The **show telnet-status** command is used to display the configuration information of the Telnet function.

### Syntax

```
show telnet-status
```

### Command Mode

Privileged EXEC Mode and Any Configuration Mode

### Privilege Requirement

None.

## Example

Display whether the Telnet function is enabled:

```
T1700X-16TS(config)# show telnet-status
```

## Chapter 10 HTTP and HTTPS Commands

With the help of HTTP (HyperText Transfer Protocol) or HTTPS (Hyper Text Transfer Protocol over Secure Socket Layer), you can manage the switch through a standard browser.

HTTP is the protocol to exchange or transfer hypertext.

SSL (Secure Sockets Layer), a security protocol, is to provide a secure connection for the application layer protocol (e.g. HTTP) based on TCP. Adopting asymmetrical encryption technology, SSL uses key pair to encrypt/decrypt information. A key pair refers to a public key (contained in the certificate) and its corresponding private key. By default, the switch has a certificate (self-signed certificate) and a corresponding private key. The Certificate/Key Download function enables the user to replace the default key pair.

### 10.1 ip http server

#### Description

The **ip http server** command is used to enable the HTTP server within the switch. To disable the HTTP function, please use **no ip http server** command. This function is enabled by default. The HTTP and HTTPS server function cannot be disabled at the same time.

#### Syntax

**ip http server**

**no ip http server**

#### Command Mode

Global Configuration Mode

#### Privilege Requirement

Only Admin and Operator level users have access to these commands.

#### Example

Disable the HTTP function:

```
T1700X-16TS(config)# no ip http server
```

## 10.2 ip http max-users

### Description

The **ip http max-users** command is used to configure the maximum number of users that are allowed to connect to the HTTP server. To cancel this limitation, please use **no ip http max-users** command.

### Syntax

```
ip http max-users admin-num guest-num
```

```
no ip http max-users
```

### Parameter

*admin-num* — The maximum number of the users logging on to the HTTP server as Admin, ranging from 1 to 16. The total number of Admin and Guest should be less than 16.

*guest-num* — The maximum number of the users logging on to the HTTP server as Guest, ranging from 0 to 15. The total number of Admin and Guest should be less than 16.

### Command Mode

Global Configuration Mode

### Privilege Requirement

Only Admin and Operator level users have access to these commands.

### Example

Configure the maximum number of the Admin and Guest users logging on to the HTTP server as 5 and 3:

```
T1700X-16TS(config)# ip http max-users 5 3
```

## 10.3 ip http session timeout

### Description

The **ip http session timeout** command is used to configure the connection timeout of the HTTP server. To restore to the default timeout time, please use **no ip http session timeout** command.

### Syntax

```
ip http session timeout minutes
```

```
no ip http session timeout
```

## Parameter

*minutes* —The timeout time, ranging from 5 to 30 in minutes. By default, the value is 10.

## Command Mode

Global Configuration Mode

## Privilege Requirement

Only Admin and Operator level users have access to these commands.

## Example

Configure the timeout time of the HTTP server connection as 15 minutes:

```
T1700X-16TS(config)# ip http session timeout 15
```

# 10.4 ip http secure-server

## Description

The **ip http secure-server** command is used to enable the HTTPS server within the switch. To disable the HTTPS function, please use **no ip http secure-server** command. This function is enabled by default. The HTTP and HTTPS server function cannot be disabled at the same time.

## Syntax

```
ip http secure-server
```

```
no ip http secure-server
```

## Command Mode

Global Configuration Mode

## Privilege Requirement

Only Admin, Operator and Power User level users have access to these commands.

## Example

Disable the HTTPS function:

```
T1700X-16TS(config)# no ip http secure-server
```

## 10.5 ip http secure-protocol

### Description

The **ip http secure-protocol** command is used to configure the SSL protocol version. To restore to the default SSL version, please use **no ip http secure-protocol** command. By default, the switch supports SSLv3 and TLSv1.

### Syntax

```
ip http secure-protocol { [ ssl3 ] [ tls1 ] }  
no ip http secure-protocol
```

### Parameter

ssl3 — The SSL 3.0 protocol.  
tls1 — The TLS 1.0 protocol

### Command Mode

Global Configuration Mode

### Privilege Requirement

Only Admin, Operator and Power User level users have access to these commands.

### Example

Configure the protocol of SSL connection as SSL 3.0:

```
T1700X-16TS(config)# ip http secure-protocol ssl3
```

## 10.6 ip http secure-ciphersuite

### Description

The **ip http secure-ciphersuite** command is used to configure the cipherSuites over the SSL connection supported by the switch. To restore to the default ciphersuite types, please use **no ip http secure-ciphersuite** command.

### Syntax

```
ip http secure-ciphersuite { [ 3des-ede-cbc-sha ] [ rc4-128-md5 ]  
[ rc4-128-sha ] [ des-cbc-sha ] }  
no ip http secure-ciphersuite
```

## Parameter

[ 3des-ede-cbc-sha ] [ rc4-128-md5 ] [ rc4-128-sha ] [ des-cbc-sha ] — Specify the encryption algorithm and the digest algorithm to use on an SSL connection. By default, the switch supports all these ciphersuites.

## Command Mode

Global Configuration Mode

## Privilege Requirement

Only Admin, Operator and Power User level users have access to these commands.

## Example

Configure the ciphersuite to be used for encryption over the SSL connection as 3des-ede-cbc-sha:

```
T1700X-16TS(config)# ip http secure-ciphersuite 3des-ede-cbc-sha
```

# 10.7 ip http secure-max-users

## Description

The **ip http secure-max-users** command is used to configure the maximum number of users that are allowed to connect to the HTTPS server. To cancel this limitation, please use **no ip http secure-max-users** command.

## Syntax

```
ip http secure-max-users admin-num guest-num
```

```
no ip http secure-max-users
```

## Parameter

*admin-num* — The maximum number of the users logging on to the HTTPS server as Admin, ranging from 1 to 16. The total number of Admin and Guest should be no more than 16.

*guest-num* — The maximum number of the users logging on to the HTTPS server as Guest, ranging from 0 to 15. The total number of Admin and Guest should be no more than 16.

## Command Mode

Global Configuration Mode



## Privilege Requirement

Only Admin, Operator and Power User level users have access to these commands.

## Example

Configure the maximum number of the Admin and Guest users logging on to the HTTPS server as 5 and 3:

```
T1700X-16TS(config)# ip http secure-max-users 5 3
```

# 10.8 ip http secure-session timeout

## Description

The **ip http secure-session timeout** command is used to configure the connection timeout of the HTTPS server. To restore to the default timeout time, please use **no ip http secure-session timeout** command.

## Syntax

```
ip http secure-session timeout minutes
```

```
no ip http secure-session timeout
```

## Parameter

*minutes* —The timeout time, ranging from 5 to 30 in minutes. By default, the value is 10.

## Command Mode

Global Configuration Mode

## Privilege Requirement

Only Admin, Operator and Power User level users have access to these commands.

## Example

Configure the timeout time of the HTTPS server connection as 15 minutes:

```
T1700X-16TS(config)# ip http secure-session timeout 15
```

# 10.9 ip http secure-server download certificate

## Description

The **ip http secure-server download certificate** command is used to download a certificate to the switch from TFTP server.

## Syntax

**ip http secure-server download certificate** *ssl-cert ip-address ip-addr*

## Parameter

*ssl-cert* — The name of the SSL certificate which is selected to download to the switch. The length of the name ranges from 1 to 25 characters. The Certificate must be BASE64 encoded.

*ip-addr* — The IP address of the TFTP server. Both IPv4 and IPv6 addresses are supported, for example 192.168.0.1 or fe80::1234.

## Command Mode

Global Configuration Mode

## Privilege Requirement

Only Admin, Operator and Power User level users have access to these commands.

## Example

Download an SSL Certificate named ssl.cert from TFTP server with the IP address of 192.168.0.146:

```
T1700X-16TS(config)# ip http secure-server download certificate ssl.cert
ip-address 192.168.0.146
```

Download an SSL Certificate named ssl.cert from TFTP server with the IP address of fe80::1234

```
T1700X-16TS(config)# ip http secure-server download certificate ssl.cert
ip-address fe80::1234
```

## 10.10 ip http secure-server download key

### Description

The **ip http secure-server download key** command is used to download an SSL key to the switch from TFTP server.

### Syntax

**ip http secure-server download key** *ssl-key ip-address ip-addr*

## Parameter

*ssl-key* — The name of the SSL key which is selected to download to the switch. The length of the name ranges from 1 to 25 characters. The Key must be BASE64 encoded.

*ip-addr* — The IP address of the TFTP server. Both IPv4 and IPv6 addresses are supported, for example 192.168.0.1 or fe80::1234.

## Command Mode

Global Configuration Mode

## Privilege Requirement

Only Admin, Operator and Power User level users have access to these commands.

## Example

Download an SSL key named ssl.key from TFTP server with the IP address of 192.168.0.146:

```
T1700X-16TS(config)# ip http secure-server download key ssl.key
ip-address 192.168.0.146
```

Download an SSL key named ssl.key from TFTP server with the IP address of fe80::1234

```
T1700X-16TS(config)# ip http secure-server download key ssl.key
ip-address fe80::1234
```

## 10.11 show ip http configuration

### Description

The **show ip http configuration** command is used to display the configuration information of the HTTP server, including status, session timeout, access-control, max-user number and the idle-timeout, etc.

### Syntax

```
show ip http configuration
```

### Command Mode

Privileged EXEC Mode and Any Configuration Mode

## Privilege Requirement

None.

## Example

Display the configuration information of the HTTP server:

```
T1700X-16TS(config)# show ip http configuration
```

# 10.12 show ip http secure-server

## Description

The **show ip http secure-server** command is used to display the global configuration of SSL.

## Syntax

```
show ip http secure-server
```

## Command Mode

Privileged EXEC Mode and Any Configuration Mode

## Privilege Requirement

None.

## Example

Display the global configuration of SSL:

```
T1700X-16TS(config)# show ip http secure-server
```

# Chapter 11 Binding Table Commands

You can bind the IP address, MAC address, VLAN and the connected Port number of the Host together, which can be the condition for the ARP Inspection to filter the packets.

## 11.1 ip source binding

### Description

The **ip source binding** command is used to bind the IP address, MAC address, VLAN ID and the Port number together manually. You can manually bind the IP address, MAC address, VLAN ID and the Port number together in the condition that you have got the related information of the Hosts in the LAN. To delete the IP-MAC-VID-PORT entry from the binding table, please use **no ip source binding index** command.

### Syntax

```
ip source binding hostname ip-addr mac-addr vlan vlan-id interface  
ten-gigabitEthernet port { none | arp-detection } [ forced-source {arp-scanning  
| dhcp-snooping} ]  
no ip source binding index idx
```

### Parameter

*hostname* — The Host Name, which contains 20 characters at most.

*ip-addr* — The IP address of the Host.

*mac-addr* — The MAC address of the Host.

*vlan-id* — The VLAN ID needed to be bound, ranging from 1 to 4094.

*port* — The number of port connected to the Host.

none | arp-detection — The protect type for the entry. “none” indicates applying none; “arp-detection” indicates ARP detection.

forced-source — The source of the binding entry can be specified as “arp-scanning” or “dhcp-snooping”. It is multi-optional.

*idx* — The entry number needed to be deleted. You can use the [show ip source binding](#) command to get the idx. Pay attention that the entry number is the actual number in the binding table which is not display in an arranged order.

### Command Mode

Global Configuration Mode

## Privilege Requirement

Only Admin, Operator and Power User level users have access to these commands.

## Example

Bind an ACL entry with the IP 192.168.0.1, MAC 00:00:00:00:00:01, VLAN ID 2 and the Port number 5 manually. And then enable the entry for the ARP detection:

```
T1700X-16TS(config)#ip source binding host1 192.168.0.1  
00:00:00:00:00:01 vlan 2 interface ten-gigabitEthernet 1/0/5 arp-detection
```

Delete the IP-MAC-VID-PORT entry with the index 5:

```
T1700X-16TS(config)#no ip source binding index 5
```

# 11.2 ip dhcp snooping

## Description

The **ip dhcp snooping** command is used to enable DHCP Snooping function globally. To disable DHCP Snooping function globally, please use **no ip dhcp snooping** command. DHCP Snooping functions to monitor the process of the Host obtaining the IP address from DHCP server, and record the IP address, MAC address, VLAN and the connected Port number of the Host for automatic binding. The switch can also propagate the control information and the network parameters via the Option 82 field to provide more information for the Host.

## Syntax

**ip dhcp snooping**

**no ip dhcp snooping**

## Command Mode

Global Configuration Mode

## Privilege Requirement

Only Admin, Operator and Power User level users have access to these commands.

## Example

Enable the DHCP Snooping function globally:

```
T1700X-16TS(config)#ip dhcp snooping
```

## 11.3 ip dhcp snooping vlan

### Description

The **ip dhcp snooping vlan** command is used to enable DHCP Snooping function on a specified VLAN. To disable DHCP Snooping function on this VLAN, please use **no ip dhcp snooping vlan** command.

### Syntax

```
ip dhcp snooping vlan vlan-range  
no ip dhcp snooping vlan vlan-range
```

### Parameter

*vlan-range* — Specify the VLANs to enable the DHCP snooping function, in the format of 1-3, 5.

### Command Mode

Global Configuration Mode

### Privilege Requirement

Only Admin, Operator and Power User level users have access to these commands.

### Example

Enable the DHCP Snooping function on VLAN 1,4,6-7:

```
T1700X-16TS(config)#ip dhcp snooping vlan 1,4,6-7
```

## 11.4 ip dhcp snooping information option

### Description

The **ip dhcp snooping information option** command is used to enable the Option 82 function of DHCP Snooping. To disable the Option 82 function, please use **no ip dhcp snooping information option** command.

### Syntax

```
ip dhcp snooping information option  
no ip dhcp snooping information option
```

### Command Mode

Interface Configuration Mode (interface ten-gigabitEthernet / interface range ten-gigabitEthernet / interface port-channel / interface range port-channel)

## Privilege Requirement

Only Admin, Operator and Power User level users have access to these commands.

## Example

Enable the Option 82 function of DHCP Snooping on port 1/0/1:

```
T1700X-16TS(config)# interface ten-gigabitEthernet 1/0/1
T1700X-16TS(config-if)#ip dhcp snooping information option
```

# 11.5 ip dhcp snooping information strategy

## Description

The **ip dhcp snooping information strategy** command is used to select the operation for the Option 82 field of the DHCP request packets from the Host. To restore to the default option, please use **no ip dhcp snooping information strategy** command.

## Syntax

**ip dhcp snooping information strategy** *strategy*

**no ip dhcp snooping information strategy**

## Parameter

*strategy* — The operations for Option 82 field of the DHCP request packets from the Host, including three types:

keep: Indicates to keep the Option 82 field of the packets. It is the default option;

replace: Indicates to replace the Option 82 field of the packets with the switch defined one;

drop: Indicates to discard the packets including the Option 82 field

## Command Mode

Interface Configuration Mode (interface ten-gigabitEthernet / interface range ten-gigabitEthernet / interface port-channel / interface range port-channel)

## Privilege Requirement

Only Admin, Operator and Power User level users have access to these commands.



## Example

Replace the Option 82 field of the packets with the switch defined one and then send out on port 1/0/1:

```
T1700X-16TS(config)# interface ten-gigabitEthernet 1/0/1
T1700X-16TS(config-if)#ip dhcp snooping information strategy replace
```

## 11.6 ip dhcp snooping information remote-id

### Description

The **ip dhcp snooping information remote-id** command is used to configure the customized sub-option Remote ID for the Option 82. To return to default Remote ID for the Option 82, please use **no ip dhcp snooping information remote-id** command.

### Syntax

```
ip dhcp snooping information remote-id string
no ip dhcp snooping information remote-id
```

### Parameter

*string* — Enter the sub-option Remote ID, which contains 32 characters at most.

### Command Mode

Interface Configuration Mode (interface ten-gigabitEthernet / interface range ten-gigabitEthernet / interface port-channel / interface range port-channel)

### Privilege Requirement

Only Admin, Operator and Power User level users have access to these commands.

## Example

Configure the customized sub-option Remote ID for the Option 82 as tlink on port 1/0/1:

```
T1700X-16TS(config)# interface ten-gigabitEthernet 1/0/1
T1700X-16TS(config-if)#ip dhcp snooping information remote-id tlink
```

## 11.7 ip dhcp snooping information circuit-id

### Description

The **ip dhcp snooping information circuit-id** command is used to enable and configure the customized sub-option Circuit ID for the Option 82 on a specified port/LAG. To return to the default Circuit ID for the Option 82, please use **no ip dhcp snooping information circuit-id** command.

### Syntax

```
ip dhcp snooping information circuit-id string  
no ip dhcp snooping information circuit-id
```

### Parameter

*string* — Enter the sub-option Circuit ID, which contains 32 characters at most.

### Command Mode

Interface Configuration Mode (interface ten-gigabitEthernet / interface range ten-gigabitEthernet / interface port-channel / interface range port-channel)

### Privilege Requirement

Only Admin, Operator and Power User level users have access to these commands.

### Example

Enable and configure the customized sub-option Circuit ID for the Option 82 as “tplink” on port 1/0/1:

```
T1700X-16TS(config)#interface ten-gigabitEthernet 1/0/1  
T1700X-16TS(config-if)#ip dhcp snooping information circuit-id tplink
```

## 11.8 ip dhcp snooping trust

### Description

The **ip dhcp snooping trust** command is used to configure a port to be a Trusted Port. Only the Trusted Port can receive the DHCP packets from DHCP servers. To turn the port back to a distrusted port, please use **no ip dhcp snooping trust** command.

## Syntax

```
ip dhcp snooping trust
no ip dhcp snooping trust
```

## Command Mode

Interface Configuration Mode (interface ten-gigabitEthernet / interface range ten-gigabitEthernet / interface port-channel / interface range port-channel)

## Privilege Requirement

Only Admin, Operator and Power User level users have access to these commands.

## Example

Configure the Ten-Gigabit Ethernet port 1/0/2 to be a Trusted Port:

```
T1700X-16TS(config)#interface ten-gigabitEthernet 1/0/2
T1700X-16TS(config-if)#ip dhcp snooping trust
```

# 11.9 ip dhcp snooping mac-verify

## Description

The **ip dhcp snooping mac-verify** command is used to enable the MAC Verify feature. To disable the MAC Verify feature, please use **no ip dhcp snooping mac-verify** command. There are two fields of the DHCP packet containing the MAC address of the Host. The MAC Verify feature is to compare the two fields and discard the packet if the two fields are different.

## Syntax

```
ip dhcp snooping mac-verify
no ip dhcp snooping mac-verify
```

## Command Mode

Interface Configuration Mode (interface ten-gigabitEthernet / interface range ten-gigabitEthernet / interface port-channel / interface range port-channel)

## Privilege Requirement

Only Admin, Operator and Power User level users have access to these commands.

## Example

Enable the MAC Verify feature for the Ten-Gigabit Ethernet port 1/0/2:

```
T1700X-16TS(config)#interface ten-gigabitEthernet 1/0/2
T1700X-16TS(config-if)#ip dhcp snooping mac-verify
```

## 11.10 ip dhcp snooping limit rate

### Description

The **ip dhcp snooping limit rate** command is used to enable the Flow Control feature for the DHCP packets. The excessive DHCP packets will be discarded. To restore to the default configuration, please use **no ip dhcp snooping limit rate** command.

### Syntax

```
ip dhcp snooping limit rate value
no ip dhcp snooping limit rate
```

### Parameter

*value* — The value of Flow Control. The options are 5/10/15/20/25/30 (packet/second). The default value is 0, which stands for “disable”.

### Command Mode

Interface Configuration Mode (interface ten-gigabitEthernet / interface range ten-gigabitEthernet / interface port-channel / interface range port-channel)

### Privilege Requirement

Only Admin, Operator and Power User level users have access to these commands.

## Example

Set the Flow Control of Ten-gigabitEthernet port 2 as 20 pps:

```
T1700X-16TS(config)#interface ten-gigabitEthernet 1/0/2
T1700X-16TS(config-if)#ip dhcp snooping limit rate 20
```

## 11.11 ip dhcp snooping decline rate

### Description

The **ip dhcp snooping decline rate** command is used to enable the Decline Protect feature and configure the rate limit on DHCP Decline packets. The excessive DHCP Decline packets will be discarded. To disable the Decline Protect feature, please use **no ip dhcp snooping decline rate** command.

### Syntax

**ip dhcp snooping decline rate** *value*

**no ip dhcp snooping decline rate**

### Parameter

*value* — Specify the rate limit of DHCP Decline packets, and the optional values are 0, 5, 10, 15, 20, 25 and 30 (units:packet/second). Its default value is 0, which stands for “disable”.

### Command Mode

Interface Configuration Mode (interface ten-gigabitEthernet / interface range ten-gigabitEthernet / interface port-channel / interface range port-channel)

### Privilege Requirement

Only Admin, Operator and Power User level users have access to these commands.

### Example

Configure the rate limit of DHCP Decline packets as 20 packets per second on Ten-Gigabit Ethernet port 1/0/2:

```
T1700X-16TS(config)#interface ten-gigabitEthernet 1/0/2
T1700X-16TS(config-if)#ip dhcp snooping decline rate 20
```

## 11.12 show ip source binding

### Description

The **show ip source binding** command is used to display the IP-MAC-VID-PORT binding table.

### Syntax

**show ip source binding**

## Command Mode

Privileged EXEC Mode and Any Configuration Mode

## Privilege Requirement

None.

## Example

Display the IP-MAC-VID-PORT binding table:

```
T1700X-16TS(config)#show ip source binding
```

## 11.13 show ip dhcp snooping

### Description

The **show ip dhcp snooping** command is used to display the running status of DHCP Snooping.

### Syntax

```
show ip dhcp snooping
```

### Command Mode

Privileged EXEC Mode and Any Configuration Mode

### Privilege Requirement

None.

### Example

Display the running status of DHCP Snooping:

```
T1700X-16TS#show ip dhcp snooping
```

## 11.14 show ip dhcp snooping interface

### Description

The **show ip dhcp snooping interface** command is used to display the DHCP Snooping configuration of a desired Gigabit Ethernet port/LAG or of all Ethernet ports/LAGs.

### Syntax

```
show ip dhcp snooping interface [ ten-gigabitEthernet port | port-channel lagid ]
```

## Parameters

*port* — The Ethernet port number.

*lagid* — The ID of the LAG.

## Command Mode

Privileged EXEC Mode and Any Configuration Mode

## Privilege Requirement

None.

## Example

Display the DHCP Snooping configuration of all Ethernet ports and LAGs:

```
T1700X-16TS#show ip dhcp snooping interface
```

Display the DHCP Snooping configuration of port 1/0/5:

```
T1700X-16TS#show ip dhcp snooping interface ten-gigabitEthernet 1/0/5
```

# 11.15 show ip dhcp snooping information interface

## Description

The **show ip dhcp snooping information interface** command is used to display the DHCP snooping option 82 configuration of a desired Gigabit Ethernet port/port channel or of all Ethernet ports/port channels.

## Syntax

```
show ip dhcp snooping information interface [ ten-gigabitEthernet port |  
port-channel port-channel-id ]
```

## Parameters

*port* — The Ethernet port number.

*port-channel-id* — The ID of the port channel.

## Command Mode

Privileged EXEC Mode and Any Configuration Mode

## Privilege Requirement

None.

## Example

Display the DHCP snooping option 82 configuration of all Ethernet ports and port channels:

```
T1700X-16TS #show ip dhcp snooping information interface
```



## Chapter 12 ARP Inspection Commands

ARP (Address Resolution Protocol) Detect function is to protect the switch from the ARP cheating, such as the Network Gateway Spoofing and Man-In-The-Middle Attack, etc.

### 12.1 ip arp inspection(global)

#### Description

The **ip arp inspection** command is used to enable the ARP Detection function globally. To disable the ARP Detection function, please use **no ip arp detection** command.

#### Syntax

**ip arp inspection**

**no ip arp inspection**

#### Command Mode

Global Configuration Mode

#### Privilege Requirement

Only Admin, Operator and Power User level users have access to these commands.

#### Example

Enable the ARP Detection function globally:

```
T1700X-16TS(config)#ip arp inspection
```

### 12.2 ip arp inspection(interface)

#### Description

The **ip arp inspection** command is used to enable the ARP Defend function. To disable the ARP detection function, please use **no ip arp inspection** command. ARP Attack flood produces lots of ARP Packets, which will occupy the bandwidth and slow the network speed extremely. With the ARP Defend enabled, the switch can terminate receiving the ARP packets for 300 seconds when the transmission speed of the legal ARP packet on the port exceeds the defined value so as to avoid ARP Attack flood.

## Syntax

**ip arp inspection**

**no ip arp inspection**

## Command Mode

Interface Configuration Mode (interface ten-gigabitEthernet / interface range ten-gigabitEthernet)

## Privilege Requirement

Only Admin, Operator and Power User level users have access to these commands.

## Example

Enable the arp defend function for the Ten-Gigabit Ethernet ports 1/0/2-6:

```
T1700X-16TS(config)#interface range ten-gigabitEthernet 1/0/2-6
```

```
T1700X-16TS(config-if-range)#ip arp inspection
```

## 12.3 ip arp inspection trust

### Description

The **ip arp inspection trust** command is used to configure the port for which the ARP Detect function is unnecessary as the Trusted Port. To clear the Trusted Port list, please use **no ip arp detection trust** command. The specific ports, such as up-linked port and routing port and LAG port, should be set as Trusted Port. To ensure the normal communication of the switch, please configure the ARP Trusted Port before enabling the ARP Detect function.

### Syntax

**ip arp inspection trust**

**no ip arp inspection trust**

### Command Mode

Interface Configuration Mode (interface ten-gigabitEthernet / interface range ten-gigabitEthernet)

### Privilege Requirement

Only Admin, Operator and Power User level users have access to these commands.

## Example

Configure the Ten-Gigabit Ethernet ports 1/0/2-5 as the Trusted Port:

```
T1700X-16TS(config)#interface range ten-gigabitEthernet 1/0/2-5
T1700X-16TS(config-if-range)#ip arp inspection trust
```

## 12.4 ip arp inspection limit-rate

### Description

The **ip arp inspection limit-rate** command is used to configure the ARP speed of a specified port. To restore to the default speed, please use **no ip arp inspection limit-rate** command.

### Syntax

```
ip arp inspection limit-rate value
no ip arp inspection limit-rate
```

### Parameter

*value* —The *value* to specify the maximum amount of the received ARP packets per second, ranging from 10 to 100 in pps(packet/second). By default, the value is 15.

### Command Mode

Interface Configuration Mode (interface ten-gigabitEthernet / interface range ten-gigabitEthernet)

### Privilege Requirement

Only Admin, Operator and Power User level users have access to these commands.

## Example

Configure the maximum amount of the received ARP packets per second as 50 pps for Ten-Gigabit Ethernet port 1/0/5:

```
T1700X-16TS(config)#interface ten-gigabitEthernet 1/0/5
T1700X-16TS(config-if)#ip arp inspection limit-rate 50
```

## 12.5 ip arp inspection recover

### Description

The **ip arp inspection recover** command is used to restore a port to the ARP transmit status from the ARP filter status.

### Syntax

```
ip arp inspection recover
```

### Command Mode

Interface Configuration Mode (interface ten-gigabitEthernet / interface range ten-gigabitEthernet)

### Privilege Requirement

Only Admin, Operator and Power User level users have access to these commands.

### Example

Restore Ten-Gigabit Ethernet port 1/0/5 to the ARP transmit status:

```
T1700X-16TS(config)#interface ten-gigabitEthernet 1/0/5
T1700X-16TS(config-if)#ip arp inspection recover
```

## 12.6 show ip arp inspection

### Description

The **show ip arp inspection** command is used to display the ARP detection global configuration including the enable/disable status and the Trusted Port list.

### Syntax

```
show ip arp inspection
```

### Command Mode

Privileged EXEC Mode and Any Configuration Mode

### Privilege Requirement

None.

### Example

Display the ARP detection configuration globally:

```
T1700X-16TS(config)#show ip arp inspection
```

## 12.7 show ip arp inspection interface

### Description

The **show ip arp inspection interface** command is used to display the interface configuration of ARP detection.

### Syntax

```
show ip arp inspection interface [ ten-gigabitEthernet port ]
```

### Parameter

*port* —The Ethernet port number.

### Command Mode

Privileged EXEC Mode and Any Configuration Mode

### Privilege Requirement

None.

### Example

Display the configuration of Ten-Gigabit Ethernet port 1/0/1:

```
T1700X-16TS(config)#show ip arp inspection interface ten-gigabitEthernet  
1/0/1
```

Display the configuration of all Ethernet ports:

```
T1700X-16TS(config)#show ip arp inspection interface
```

## 12.8 show ip arp inspection statistics

### Description

The **show ip arp inspection statistics** command is used to display the number of the illegal ARP packets received.

### Syntax

```
show ip arp inspection statistics
```

### Command Mode

Privileged EXEC Mode and Any Configuration Mode

### Privilege Requirement

None.

## Example

Display the number of the illegal ARP packets received:

```
T1700X-16TS(config)#show ip arp inspection statistics
```

## 12.9 clear ip arp inspection statistics

### Description

The **clear ip arp inspection statistics** command is used to clear the statistic of the illegal ARP packets received.

### Syntax

```
clear ip arp inspection statistics
```

### Command Mode

Privileged EXEC Mode and Any Configuration Mode

### Privilege Requirement

Only Admin, Operator and Power User level users have access to these commands.

## Example

Clear the statistic of the illegal ARP packets received:

```
T1700X-16TS(config)#clear ip arp inspection statistics
```

## Chapter 13 DoS Defend Commands

DoS (Denial of Service) Attack is to occupy the network bandwidth maliciously by the network attackers or the evil programs sending a lot of service requests to the Host. With the DoS Defend enabled, the switch can analyze the specific field of the received packets and provide the defend measures to ensure the normal working of the local network.

### 13.1 ip dos-prevent

#### Description

The **ip dos-prevent** command is used to enable the DoS defend function globally. To disable the DoS defend function, please use **no ip dos-prevent** command.

#### Syntax

**ip dos-prevent**  
**no ip dos-prevent**

#### Command Mode

Global Configuration Mode

#### Privilege Requirement

Only Admin, Operator and Power User level users have access to these commands

#### Example

Enable the DoS defend function globally:

```
T1700X-16TS(config)#ip dos-prevent
```

### 13.2 ip dos-prevent type

#### Description

The **ip dos-prevent type** command is used to select the DoS Defend Type. To disable the corresponding Defend Type, please use **no ip dos-prevent type** command.

## Syntax

```
ip dos-prevent type { land | scan-synfin | xma-scan | null-scan | port-less-1024  
| blat | ping-flood | syn-flood | win-nuke }
```

```
no ip dos-prevent type { land | scan-synfin | xma-scan | null-scan |  
port-less-1024 | blat | ping-flood | syn-flood | win-nuke }
```

## Parameter

land — Land attack.

scan-synfin — Scan SYNFIN attack.

xma-scan — Xma Scan attack.

null-scan — NULL Scan attack.

port-less-1024 —The SYN packets whose Source Port less than 1024.

blat — Blat attack.

ping-flood — Ping flooding attack. With the ping flood attack enabled, the switch will limit automatically the forwarding speed of ping packets to 512K when attacked by ping flood.

syn-flood — SYN/SYN-ACK flooding attack. With the syn-flood attack enabled, the switch will limit automatically the forwarding speed of ping packets to 512K when attacked by syn-flood.

win-nuke — winNuke attack.

## Command Mode

Global Configuration Mode

## Privilege Requirement

Only Admin, Operator and Power User level users have access to these commands.

## Example

Enable the DoS Defend Type named Land attack:

```
T1700X-16TS(config)#ip dos-prevent type land
```



## 13.3 show ip dos-prevent

### Description

The **show ip dos-prevent** command is used to display the DoS information of the detected DoS attack, including enable/disable status, the DoS Defend Type, the count of the attack, etc.

### Syntax

```
show ip dos-prevent
```

### Command Mode

Privileged EXEC Mode and Any Configuration Mode

### Privilege Requirement

None.

### Example

Display the DoS information of the detected DoS attack globally:

```
T1700X-16TS(config)#show ip dos-prevent
```

# Chapter 14 System Log Commands

The log information will record the settings and operation of the switch respectively for you to monitor operation status and diagnose malfunction.

## 14.1 logging buffer

### Description

The **logging buffer** command is used to store the system log messages to an internal buffer. To disable the log buffer function, please use the **no logging buffer** command. Local Log is the system log information saved in the switch. It has two output channels, that is, it can be saved to two different positions, log buffer and log flash memory. The log buffer indicates the RAM for saving system log and the information in the log buffer can be got by [show logging buffer](#) command. It will be lost when the switch is restarted.

### Syntax

**logging buffer**  
**no logging buffer**

### Command Mode

Global Configuration Mode

### Privilege Requirement

Only Admin and Operator level users have access to these commands.

### Example

Enable the system log buffer:

```
T1700X-16TS(config)#logging buffer
```

## 14.2 logging buffer level

### Description

The **logging buffer level** command is used to configure the severity level and the status of the configuration input to the log buffer. To return to the default configuration, please use **no logging buffer level** command.

### Syntax

**logging buffer level** *level*

## **no logging buffer level**

### **Parameter**

*level* — Severity level of the log information output to each channel. There are 8 severity levels marked with values 0-7. The smaller value has the higher priority. Only the log with the same or smaller severity level value will be output. By default, it is 6 indicating that the log information with level 0-6 will be saved in the log buffer.

### **Command Mode**

Global Configuration Mode

### **Privilege Requirement**

Only Admin and Operator level users have access to these commands.

### **Example**

Set the severity level as 5:

```
T1700X-16TS(config)#logging buffer level 5
```

## **14.3 logging file flash**

### **Description**

The **logging file flash** command is used to store the log messages in a file in the flash on the switch. To disable the log file flash function, please use **no logging file flash** command. This function is disabled by default. The log file flash indicates the flash sector for saving system log. The information in the log file of the flash will not be lost after the switch is restarted and can be got by the [show logging flash](#) command.

### **Syntax**

**logging file flash**

**no logging file flash**

### **Command Mode**

Global Configuration Mode

### **Privilege Requirement**

Only Admin and Operator level users have access to these commands.

### **Example**

Enable the log file flash function:

## 14.4 logging file flash frequency

### Description

The **logging file flash frequency** command is used to specify the frequency to synchronize the system log file in the log buffer to the flash. To resume the default synchronizing frequency, please use the **no logging file flash frequency** command.

### Syntax

```
logging file flash frequency { periodic periodic | immediate }  
no logging file flash frequency
```

### Parameter

*periodic* — The frequency to synchronize the system log file in the log buffer to the flash, ranging from 1 to 48 hours. By default, the synchronization process takes place every 24 hours.

**immediate** — The system log file in the buffer will be synchronized to the flash immediately. This option will reduce the life of the flash and is not recommended.

### Command Mode

Global Configuration Mode

### Privilege Requirement

Only Admin and Operator level users have access to these commands.

### Example

Specify the log file synchronization frequency as 10 hours:

```
T1700X-16TS(config)#logging file flash frequency periodic 10
```

## 14.5 logging file flash level

### Description

The **logging file flash level** command is used to specify the system log message severity level. Messages with a severity level equal to or higher than this value will be stored to the flash. To restore to the default level, please use **no logging file flash level** command.

## Syntax

**logging file flash level *level***

**no logging file flash level**

## Parameter

*level* — Severity level of the log message. There are 8 severity levels marked with values 0-7. The smaller value has the higher priority. Only the log with the same or smaller severity level value will be saved to the flash. By default, it is 3 indicating that the log message marked with 0~3 will be saved in the log flash.

## Command Mode

Global Configuration Mode

## Privilege Requirement

Only Admin and Operator level users have access to these commands.

## Example

Save the log messages with their severities equal or higher than 7 to the flash :

```
T1700X-16TS(config)#logging file flash level 7
```

# 14.6 logging host index

## Description

The **logging host index** command is used to configure the Log Host. To clear the configuration of the specified Log Host, please use **no logging host index** command. Log Host is to receive the system log from other devices. You can remotely monitor the settings and operation status of other devices through the log host.

## Syntax

**logging host index *idx host-ip level***

**no logging host index *idx***

## Parameter

*idx* — The index of the log host. The switch supports 4 log hosts at most.

*host-ip* — The IP for the log host.

*level* — The severity level of the log information sent to each log host. There are 8 severity levels marked with values 0-7. The smaller value has the higher priority. Only the log with the same or smaller severity level value will be sent to

the corresponding log host. By default, it is 6 indicating that the log information marked with 0~6 will be sent to the log host.

### Command Mode

Global Configuration Mode

### Privilege Requirement

Only Admin and Operator level users have access to these commands.

### Example

Enable log host 2 and set its IP address as 192.168.0.148, the level 5:

```
T1700X-16TS(config)# logging host index 2 192.168.0.148 5
```

## 14.7 logging monitor

### Description

The **logging monitor** command is used to display the system logs on the terminal devices. To disable logging to the terminal, please use **no logging monitor** command. This function is enabled by default.

### Syntax

**logging monitor**

**no logging monitor**

### Command Mode

Global Configuration Mode

### Privilege Requirement

Only Admin and Operator level users have access to these commands.

### Example

Disable logging to the terminal devices:

```
T1700X-16TS(config)# no logging monitor
```

## 14.8 logging monitor level

### Description

The **logging monitor level** command is used to limit messages logged to the terminal devices. System logs no higher than the set threshold level will be displayed on the terminal devices. To restore the threshold level to default value, please use **no logging monitor level** command.

## Syntax

**logging monitor level *level***

**no logging monitor level**

## Parameter

*level* — Severity level of the log information output to the terminal devices. There are 8 severity levels marked with values 0-7. The smaller value has the higher priority. Only the log with the same or smaller severity level value will be output to the terminal devices. By default, it is 5 indicating that all the log information between level 0-5 will be output to the terminal devices.

## Command Mode

Global Configuration Mode

## Privilege Requirement

Only Admin and Operator level users have access to these commands.

## Example

Set the severity level as 7:

```
T1700X-16TS(config)# logging monitor level 7
```

# 14.9 clear logging

## Description

The **clear logging** command is used to clear the information in the log buffer and log file.

## Syntax

**clear logging [ buffer | flash ]**

## Parameter

buffer | flash —The output channels: buffer and flash. Clear the information of the two channels, by default.

## Command Mode

Global Configuration Mode

## Privilege Requirement

Only Admin and Operator level users have access to these commands.

## Example

Clear the information in the log file:

```
T1700X-16TS(config)# clear logging buffer
```

## 14.10 show logging local-config

### Description

The **show logging local-config** command is used to display the configuration of the Local Log output to the terminal, the log buffer and the log file.

### Syntax

```
show logging local-config
```

### Command Mode

Privileged EXEC Mode and Any Configuration Mode

### Privilege Requirement

None.

### Example

Display the configuration of the Local Log:

```
T1700X-16TS(config)# show logging local-config
```

## 14.11 show logging loghost

### Description

The **show logging loghost** command is used to display the configuration of the log host.

### Syntax

```
show logging loghost [ index ]
```

### Parameter

*index* —The index of the log host whose configuration will be displayed, ranging from 1 to 4. Display the configuration of all the log hosts by default.

### Command Mode

Privileged EXEC Mode and Any Configuration Mode



## Privilege Requirement

None.

## Example

Display the configuration of the log host 2:

```
T1700X-16TS(config)# show logging loghost 2
```

## 14.12 show logging buffer

### Description

The **show logging buffer** command is used to display the log information in the log buffer according to the severity level.

### Syntax

```
show logging buffer [ level level ]
```

### Parameter

*level* — Severity level. There are 8 severity levels marked with values 0-7. The information of levels with priority not lower than the select level will display. Display all the log information in the log buffer by default.

### Command Mode

Privileged EXEC Mode and Any Configuration Mode

### Privilege Requirement

None.

### Example

Display the log information from level 0 to level 5 in the log buffer:

```
T1700X-16TS(config)# show logging buffer level 5
```

## 14.13 show logging flash

### Description

The **show logging flash** command is used to display the log information in the log file according to the severity level.

### Syntax

```
show logging flash [ level level ]
```

## Parameter

*level* — Severity level. There are 8 severity levels marked with values 0-7. The information of levels with priority not lower than the select level will display. Display all the log information in the log file by default.

## Command Mode

Privileged EXEC Mode and Any Configuration Mode

## Privilege Requirement

None.

## Example

Display the log information with the level marked 0~3 in the log file:

```
T1700X-16TS(config)# show logging flash level 3
```

# Chapter 15 SSH Commands

SSH (Security Shell) can provide the unsecured remote management with security and powerful authentication to ensure the security of the management information.

## 15.1 ip ssh server

### Description

The **ip ssh server** command is used to enable SSH function. To disable the SSH function, please use **no ip ssh server** command.

### Syntax

**ip ssh server**  
**no ip ssh server**

### Command Mode

Global Configuration Mode

### Privilege Requirement

Only Admin, Operator and Power User level users have access to these commands.

### Example

Enable the SSH function:

```
T1700X-16TS(config)# ip ssh server
```

## 15.2 ip ssh version

### Description

The **ip ssh version** command is used to enable the SSH protocol version. To disable the protocol version, please use **no ip ssh version** command.

### Syntax

**ip ssh version { v1 | v2 }**  
**no ip ssh version { v1 | v2 }**

### Parameter

v1 | v2 — The SSH protocol version to be enabled. They represent SSH v1 and SSH v2 respectively.

## Command Mode

Global Configuration Mode

## Privilege Requirement

Only Admin, Operator and Power User level users have access to these commands.

## Example

Enable SSH v2:

```
T1700X-16TS(config)# ip ssh version v2
```

# 15.3 ip ssh algorithm

## Description

The **ip ssh algorithm** command is used to configure the algorithm in SSH function. To disable the specified algorithm, please use **no ip ssh algorithm** command.

## Syntax

```
ip ssh algorithm { AES128-CBC | AES192-CBC | AES256-CBC |  
Blowfish-CBC | Cast128-CBC | 3DES-CBC | HMAC-SHA1 | HMAC-MD5 }
```

```
no ip ssh algorithm { AES128-CBC | AES192-CBC | AES256-CBC |  
Blowfish-CBC | Cast128-CBC | 3DES-CBC | HMAC-SHA1 | HMAC-MD5 }
```

## Parameter

AES128-CBC | AES192-CBC | AES256-CBC | Blowfish-CBC | Cast128-CBC |  
3DES-CBC | HMAC-SHA1 | HMAC-MD5 — Specify the SSH algorithm.

## Command Mode

Global Configuration Mode

## Privilege Requirement

Only Admin, Operator and Power User level users have access to these commands.

## Example

Specify the SSH algorithm as AES128-CBC:

```
T1700X-16TS(config)# ip ssh algorithm AES128-CBC
```

## 15.4 ip ssh timeout

### Description

The **ip ssh timeout** command is used to specify the idle-timeout time of SSH. To restore to the factory defaults, please use **no ip ssh timeout** command.

### Syntax

**ip ssh timeout** *value*

**no ip ssh timeout**

### Parameter

*value* — The Idle-timeout time. During this period, the system will automatically release the connection if there is no operation from the client. It ranges from 1 to 120 in seconds. By default, this value is 120 seconds.

### Command Mode

Global Configuration Mode

### Privilege Requirement

Only Admin, Operator and Power User level users have access to these commands.

### Example

Specify the idle-timeout time of SSH as 30 seconds:

```
T1700X-16TS(config)# ip ssh timeout 30
```

## 15.5 ip ssh max-client

### Description

The **ip ssh max-client** command is used to specify the maximum number of the connections to the SSH server. To return to the default configuration, please use **no ip ssh max-client** command.

### Syntax

**ip ssh max-client** *num*

**no ip ssh max-client**

### Parameter

*num* — The maximum number of the connections to the SSH server. It ranges from 1 to 5. By default, this value is 5.

### Command Mode

Global Configuration Mode

## Privilege Requirement

Only Admin, Operator and Power User level users have access to these commands.

## Example

Specify the maximum number of the connections to the SSH server as 3:

```
T1700X-16TS(config)# ip ssh max-client 3
```

# 15.6 ip ssh download

## Description

The **ip ssh download** command is used to download the SSH key file from TFTP server.

## Syntax

```
ip ssh download { v1 | v2 } key-file ip-address ip-addr
```

## Parameter

*v1 | v2* — Select the type of SSH key to download, v1 represents SSH-1, v2 represents SSH-2.

*key-file* — The name of the key-file which is selected to download. The length of the name ranges from 1 to 25 characters. The key length of the downloaded file must be in the range of 512 to 3072 bits.

*ip-addr* — The IP address of the TFTP server. Both IPv4 and IPv6 addresses are supported, for example 192.168.0.1 or fe80::1234.

## Command Mode

Global Configuration Mode

## Privilege Requirement

Only Admin, Operator and Power User level users have access to these commands.

## Example

Download an SSH-1 type key file named ssh.key from TFTP server with the IP address 192.168.0.148:

```
T1700X-16TS(config)# ip ssh download v1 ssh.key ip-address  
192.168.0.148
```

Download an SSH-1 type key file named ssh.key from TFTP server with the IP address fe80::1234:

```
T1700X-16TS(config)# ip ssh download v1 ssh.key ip-address fe80::1234
```

## 15.7 remove public-key

### Description

The **remove public-key** command is used to remove the SSH public key from the switch.

### Syntax

```
remove public-key { v1 | v2 }
```

### Parameter

v1 | v2 — Select the type of SSH public key, v1 represents SSH-1, v2 represents SSH-2.

### Command Mode

Privileged EXEC Mode

### Privilege Requirement

Only Admin level users have access to these commands.

### Example

Remove the SSH-1 type public key from the switch:

```
T1700X-16TS# remove public-key v1
```

## 15.8 show ip ssh

### Description

The **show ip ssh** command is used to display the global configuration of SSH.

### Syntax

```
show ip ssh
```

### Command Mode

Privileged EXEC Mode and Any Configuration Mode

### Privilege Requirement

None.

### Example

Display the global configuration of SSH:

```
T1700X-16TS(config)# show ip ssh
```

## Chapter 16 IEEE 802.1X Commands

IEEE 802.1X function is to provide an access control for LAN ports via the authentication. An 802.1X system include three entities: supplicant, authenticator and authentication server.

- Supplicant: the device that requests access to the LAN.
- Authentication server: performs the actual authentication of the supplicant. It validates the identity of the supplicant and notifies the authenticator whether or not the supplicant is authorized to access the LAN.
- Authenticator: controls the physical access to the network based on the authentication status of the supplicant. It is usually an 802.1X-supported network device, such as this TP-LINK switch. It acts as an intermediary (proxy) between the supplicant and the authentication server, requesting identity information from the supplicant, verifying that information with the authentication server, and relaying a response to the supplicant.

This chapter handles with the authentication process between the supplicant and the switch. To realize the authentication and accounting function, you should also enable the AAA function and configure the RADIUS server. Go to [Chapter 34 AAA Commands](#) for more details.

### 16.1 dot1x system-auth-control

#### Description

The **dot1x system-auth-control** command is used to enable the IEEE 802.1X function globally. To disable the IEEE 802.1X function, please use **no dot1x system-auth-control** command.

#### Syntax

```
dot1x system-auth-control  
no dot1x system-auth-control
```

#### Command Mode

Global Configuration Mode

#### Privilege Requirement

Only Admin, Operator and Power User level users have access to these commands.

#### Example

Enable the IEEE 802.1X function:



```
T1700X-16TS(config)#dot1x system-auth-control
```

## 16.2 dot1x handshake

### Description

The **dot1x handshake** command is used to enable the handshake feature. The handshake feature is used to detect the connection status between the TP-LINK 802.1x supplicant and the switch. Please disable the handshake feature if you are using a non-TP-LINK 802.1x-compliant client software. This feature is enabled by default.

### Syntax

```
dot1x handshake  
no dot1x handshake
```

### Command Mode

Global Configuration Mode

### Privilege Requirement

Only Admin, Operator and Power User level users have access to these commands.

### Example

Disable the 802.1X handshake function:

```
T1700X-16TS(config)# no dot1x handshake
```

## 16.3 dot1x auth-method

### Description

The **dot1x auth-method** command is used to configure the Authentication Method of IEEE 802.1X and the default 802.1x authentication method is “eap”. To restore to the default 802.1x authentication method, please use **no dot1x auth-method** command.

### Syntax

```
dot1x auth-method { pap | eap }  
no dot1x auth-method
```

## Parameter

pap | eap —Authentication Methods.

pap: EAP termination mode. IEEE 802.1X authentication system uses extensible authentication protocol (EAP) to exchange information between the switch and the client. The EAP packets are terminated at the switch and repackaged in the Password Authentication Protocol (PAP) packets, and then transferred to the RADIUS server.

eap: EAP relay mode. IEEE 802.1X authentication system uses extensible authentication protocol (EAP) to exchange information between the switch and the client. The EAP protocol packets with authentication data are encapsulated in the advanced protocol (such as RADIUS) packets and transmitted to the authentication server.

## Command Mode

Global Configuration Mode

## Privilege Requirement

Only Admin, Operator and Power User level users have access to these commands.

## Example

Configure the Authentication Method of IEEE 802.1X as “pap”:

```
T1700X-16TS(config)#dot1x auth-method pap
```

# 16.4 dot1x accounting

## Description

The **dot1x accounting** command is used to enable the IEEE 802.1X accounting function globally. To disable the enable the IEEE 802.1X accounting function, please use **no dot1x accounting** command.

## Syntax

**dot1x accounting**

**no dot1x accounting**

## Command Mode

Global Configuration Mode

## Privilege Requirement

Only Admin, Operator and Power User level users have access to these commands.

## Example

Enable the enable the IEEE 802.1X accounting function globally:

```
T1700X-16TS(config)#dot1x accounting
```

# 16.5 dot1x guest-vlan(global)

## Description

The **dot1x guest-vlan** command is used to enable the Guest VLAN function globally. To disable the Guest VLAN function, please use **no dot1x guest-vlan** command.

## Syntax

```
dot1x guest-vlan vid
```

```
no dot1x guest-vlan
```

## Parameter

*vid* — The VLAN ID needed to enable the Guest VLAN function, ranging from 2 to 4094. The supplicants in the Guest VLAN can access the specified network sources.

## Command Mode

Global Configuration Mode

## Privilege Requirement

Only Admin, Operator and Power User level users have access to these commands.

## Example

Enable the Guest VLAN function for VLAN 5:

```
T1700X-16TS(config)#dot1x guest-vlan 5
```

## 16.6 dot1x quiet-period

### Description

The **dot1x quiet-period** command is used to enable the quiet-period function. To disable the function, please use **no dot1x quiet-period** command.

### Syntax

```
dot1x quiet-period [ time ]  
no dot1x quiet-period
```

### Parameter

*time* — The length of the quiet-period time. If one user's authentication fails, its subsequent IEEE 802.1x authentication requests will not be processed during the quiet-period time. It ranges from 1 to 999 seconds and the default value is 10 seconds.

### Command Mode

Global Configuration Mode

### Privilege Requirement

Only Admin, Operator and Power User level users have access to these commands.

### Example

Enable the quiet-period function:

```
T1700X-16TS(config)#dot1x quiet-period
```

Enable the quiet-period function and set the quiet-period as 5 seconds:

```
T1700X-16TS(config)#dot1x quiet-period 5
```

## 16.7 dot1x timeout supplicant-timeout

### Description

The **dot1x timeout supplicant-timeout** command is used to configure the supplicant timeout. To restore to the default, please use **no dot1x timeout supplicant-timeout** command.

### Syntax

```
dot1x timeout supplicant-timeout time
```

## **no dot1x timeout supplicant-timeout**

### **Parameter**

*time* — The maximum time for the switch to wait for the response from supplicant before resending a request to the supplicant., ranging from 1 to 9 in second. By default, it is 3 seconds.

### **Command Mode**

Global Configuration Mode

### **Privilege Requirement**

Only Admin, Operator and Power User level users have access to these commands.

### **Example**

Configure the server's supplicant timeout value as 5 seconds:

```
T1700X-16TS(config)#dot1x timeout supplicant-timeout 5
```

## **16.8 dot1x max-reauth-req**

### **Description**

The **dot1x max-reauth-req** command is used to configure the maximum transfer times of the repeated authentication request when the server cannot be connected. To restore to the default value, please use **no dot1x max-reauth-req** command.

### **Syntax**

```
dot1x max-reauth-req times
```

```
no dot1x max-reauth-req
```

### **Parameter**

*times* — The maximum transfer times of the repeated authentication request, ranging from 1 to 9 in times. By default, the value is 3.

### **Command Mode**

Global Configuration Mode

### **Privilege Requirement**

Only Admin, Operator and Power User level users have access to these commands.

## Example

Configure the maximum transfer times of the repeated authentication request as 5:

```
T1700X-16TS(config)#dot1x max-reauth-req 5
```

## 16.9 dot1x

### Description

The **dot1x** command is used to enable the IEEE 802.1X function for a specified port. To disable the IEEE 802.1X function for a specified port, please use **no dot1x** command.

### Syntax

```
dot1x  
no dot1x
```

### Command Mode

Interface Configuration Mode (interface ten-gigabitEthernet / interface range ten-gigabitEthernet)

### Privilege Requirement

Only Admin, Operator and Power User level users have access to these commands.

### Example

Enable the IEEE 802.1X function for port 1/0/1:

```
T1700X-16TS(config)#interface ten-gigabitEthernet 1/0/1  
T1700X-16TS(config-if)#dot1x
```

## 16.10 dot1x guest-vlan(interface)

### Description

The **dot1x guest-vlan** command is used to enable the guest VLAN function for a specified port. To disable the Guest VLAN function for a specified port, please use **no dot1x guest-vlan** command. Please ensure that the Control Type of the corresponding port is port-based before enabling the guest VLAN function for it.

## Syntax

**dot1x guest-vlan**

**no dot1x guest-vlan**

## Command Mode

Interface Configuration Mode (interface ten-gigabitEthernet / interface range ten-gigabitEthernet)

## Privilege Requirement

Only Admin, Operator and Power User level users have access to these commands.

## Example

Enable the Guest VLAN function for port 1/0/2:

```
T1700X-16TS(config)#interface ten-gigabitEthernet 1/0/2
```

```
T1700X-16TS(config-if)#dot1x guest-vlan
```

# 16.11 dot1x port-control

## Description

The **dot1x port-control** command is used to configure the Control Mode of IEEE 802.1X for the specified port. By default, the control mode is "auto". To restore to the default configuration, please use **no dot1x port-control** command.

## Syntax

**dot1x port-control** {auto | authorized-force | unauthorized-force}

**no dot1x port-control**

## Parameter

auto | authorized-force | unauthorized-force — The Control Mode for the port.

auto: In this mode, the port will normally work only after passing the 802.1X Authentication.

authorized-force: In this mode, the port can work normally without passing the 802.1X Authentication.

unauthorized-force: In this mode, the port is forbidden working for its fixed unauthorized status.

## Command Mode

Interface Configuration Mode (interface ten-gigabitEthernet / interface range ten-gigabitEthernet)

## Privilege Requirement

Only Admin, Operator and Power User level users have access to these commands.

## Example

Configure the Control Mode for port 1/0/20 as “authorized-force”:

```
T1700X-16TS(config)#interface ten-gigabitEthernet 1/0/20
T1700X-16TS(config-if)#dot1x port-control authorized-force
```

## 16.12 dot1x port-method

### Description

The **dot1x port-method** command is used to configure the control type of IEEE 802.1X for the specified port. By default, the control type is “mac-based”. To restore to the default configuration, please use **no dot1x port-method** command.

### Syntax

```
dot1x port-method { mac-based | port-based }
```

```
no dot1x port-method
```

### Parameter

mac-based | port-based ——The control type for the port.

mac-based: Any client connected to the port should pass the 802.1X authentication for access.

port-based: All the clients connected to the port can access the network on the condition that any one of the clients has passed the 802.1X Authentication.

## Command Mode

Interface Configuration Mode (interface ten-gigabitEthernet / interface range ten-gigabitEthernet)



## Privilege Requirement

Only Admin, Operator and Power User level users have access to these commands.

## Example

Configure the Control Type for port 1/0/20 as “port-based”:

```
T1700X-16TS(config)#interface ten-gigabitEthernet 1/0/20
T1700X-16TS(config-if)#dot1x port-method port-based
```

## 16.13 show dot1x global

### Description

The **show dot1x global** command is used to display the global configuration of 802.1X.

### Syntax

```
show dot1x global
```

### Command Mode

Privileged EXEC Mode and Any Configuration Mode

### Privilege Requirement

None.

### Example

Display the configuration of 802.1X globally:

```
T1700X-16TS(config)#show dot1x global
```

## 16.14 show dot1x interface

### Description

The **show dot1x interface** command is used to display all ports or the specified port's configuration information of 802.1X.

### Syntax

```
show dot1x interface [ ten-gigabitEthernet port ]
```

## Parameter

*port* — The Ethernet port number. If not specified, the information of all the ports will be displayed.

## Command Mode

Privileged EXEC Mode and Any Configuration Mode

## Privilege Requirement

None.

## Example

Display the configuration information of 802.1X for port 1/0/20:

```
T1700X-16TS(config)#show dot1x interface ten-gigabitEthernet 1/0/20
```

Display the configuration information of 802.1X for all Ethernet ports:

```
T1700X-16TS(config)#show dot1x interface
```

# Chapter 17 MAC Address Commands

MAC Address configuration can improve the network security by configuring the Port Security and maintaining the address information by managing the Address Table.

## 17.1 mac address-table static

### Description

The **mac address-table static** command is used to add the static MAC address entry. To remove the corresponding entry, please use **no mac address-table static** command. The static address can be added or removed manually, independent of the aging time. In the stable networks, the static MAC address entries can facilitate the switch to reduce broadcast packets and enhance the efficiency of packets forwarding remarkably.

### Syntax

```
mac address-table static mac-addr vid vid interface ten-gigabitEthernet port  
no mac address-table static { mac-addr | vid vid | mac-addr vid vid | interface  
ten-gigabitEthernet port }
```

### Parameter

*mac-addr* — The MAC address of the entry you desire to add.

*vid* — The VLAN ID number of your desired entry. It ranges from 1 to 4094.

*port* — The Ethernet port number of your desired entry.

### Command Mode

Global Configuration Mode

### Privilege Requirement

Only Admin, Operator and Power User level users have access to these commands.

### Example

Add a static Mac address entry to bind the MAC address 00:02:58:4f:6c:23, VLAN1 and port 1 together:

```
T1700X-16TS(config)# mac address-table static 00:02:58:4f:6c:23 vid 1  
interface ten-gigabitEthernet 1/0/1
```

## 17.2 mac address-table aging-time

### Description

The **mac address-table aging-time** command is used to configure aging time for the dynamic address. To return to the default configuration, please use **no mac address-table aging-time** command.

### Syntax

```
mac address-table aging-time aging-time  
no mac address-table aging-time
```

### Parameter

*aging-time* — The aging time for the dynamic address. The value of it can be 0 or ranges from 10 to 630 seconds. When 0 is entered, the Auto Aging function is disabled. It is 300 by default.

### Command Mode

Global Configuration Mode

### Privilege Requirement

Only Admin, Operator and Power User level users have access to these commands.

### Example

Configure the aging time as 500 seconds:

```
T1700X-16TS(config)# mac address-table aging-time 500
```

## 17.3 mac address-table filtering

### Description

The **mac address-table filtering** command is used to add the filtering address entry. To delete the corresponding entry, please use **no mac address-table filtering** command. The filtering address function is to forbid the undesired package to be forwarded. The filtering address can be added or removed manually, independent of the aging time.

### Syntax

```
mac address-table filtering mac-addr vid vid
```

**no mac address-table filtering** {[ *mac-addr* ] [ **vid** *vid* ]}

### Parameter

*mac-addr* — The MAC address to be filtered.

*vid* — The corresponding VLAN ID of the MAC address. It ranges from 1 to 4094.

### Command Mode

Global Configuration Mode

### Privilege Requirement

Only Admin, Operator and Power User level users have access to these commands.

### Example

Add a filtering address entry of which VLAN ID is 1 and MAC address is 00:1e:4b:04:01:5d:

```
T1700X-16TS(config)# mac address-table filtering 00:1e:4b:04:01:5d vid 1
```

## 17.4 mac address-table notification

### Description

The **mac address-table notification** command is used to configure global settings of MAC address table notification.

### Syntax

```
mac address-table notification { [ global-status enable | disable ]  
[ table-full-status enable | disable ] [ interval time ] }
```

### Parameter

**global-status** enable | disable — Enable/Disable the notification function globally.

**table-full-status** enable | disable — Enable/Disable the MAC threshold notification. With this feature enabled, a SNMP notification is generated and sent to the network management system (NMS) when the threshold of the switch's MAC address table is reached or exceeded.

**interval** *time* — Specify the notification trap interval between each set of traps that are generated to the NMS. The interval ranges from 1 to 1000 seconds and it's 1 second by default.

## Command Mode

Global Configuration Mode

## Privilege Requirement

Only Admin, Operator and Power User level users have access to these commands.

## Example

Enable the global MAC address notification and table full notification, specify the notification sending interval as 2 seconds:

```
T1700X-16TS(config)# mac address-table notification global-status enable
table-full-status enable interval 2
```

# 17.5 mac address-table notification (interface)

## Description

The **mac address-table notification** command is used to configure the MAC change notification on port.

## Syntax

```
mac address-table notification { [ learn-mode-change enable | disable ]
[ exceed-max-learned enable | disable ] [ new-mac-learned enable | disable ] }
```

## Parameter

**learn-mode-change** enable | disable — Enable/Disable the learn-mode-change notification. With this feature enabled, a SNMP notification is generated and sent to the network management system (NMS) when the learning mode of this port changes. To configure the learning mode configuration, please refer to [mac address-table max-mac-count](#).

**exceed-max-learned** enable | disable — Enable/Disable the MAC address threshold notification on this port. With this feature enabled, a SNMP notification is generated and sent to the network management system (NMS) when the MAC address threshold limit on this port is reached or exceeded. To configure the port's MAC address threshold, please refer to [mac address-table max-mac-count](#).

**new-mac-learned** enable | disable — Enable/Disable the new-mac-learned notification on this port. With this feature enabled, a SNMP notification is generated and sent to the network management system (NMS) when the port learns a new MAC address.

## Command Mode

Interface Configuration Mode (interface ten-gigabitEthernet / interface range ten-gigabitEthernet)

## Privilege Requirement

Only Admin, Operator and Power User level users have access to these commands.

## Example

Enable the learn-mode-change notification on port 1/0/2:

```
T1700X-16TS(config)# mac address-table notification global-status enable
T1700X-16TS(config)# interface ten-gigabitEthernet 1/0/2
T1700X-16TS(config-if)# mac address-table notification
learn-mode-change enable
```

# 17.6 mac address-table max-mac-count

## Description

The **mac address-table max-mac-count** command is used to configure the Port Security. To return to the default configurations, please use **no mac address-table max-mac-count** command. Port Security is to protect the switch from the malicious MAC address attack by limiting the maximum number of the MAC addresses that can be learned on the port. The port with Port Security feature enabled will learn the MAC address dynamically. When the learned MAC address number reaches the maximum, the port will stop learning. Therefore, the other devices with the MAC address unlearned can not access to the network via this port.

## Syntax

```
mac address-table max-mac-count { [ max-number num ] [ mode { dynamic | static | permanent } ] [ status { forward | drop | disable } ] }
```

```
no mac address-table max-mac-count [ max-number | mode | status ]
```

## Parameter

*num* — The maximum number of MAC addresses that can be learned on the port. It ranges from 0 to 64. By default this value is 64.

dynamic | static | permanent — Learn mode for MAC addresses. There are three modes, including Dynamic mode, Static mode and Permanent mode.

When Dynamic mode is selected, the learned MAC address will be deleted automatically after the aging time. When Static mode is selected, the learned MAC address will be out of the influence of the aging time and can only be deleted manually. The learned entries will be cleared after the switch is rebooted. When permanent mode is selected, the learned MAC address will be out of the influence of the aging time and can only be deleted manually too. However, the learned entries will be saved even the switch is rebooted.

status — Select the action to be taken when the number of the MAC addresses reaches the maximum learning number on the port. By default this function is disabled.

- forward: The packets will be forward but not be learned when learned MAC number exceeds the the maximum MAC address number on this port.
- drop: The packets will be dropped when learned MAC number exceeds the the maximum MAC address number on this port.
- disable: The MAC address threshold on this port is disabled.

### Command Mode

Interface Configuration Mode (interface ten-gigabitEthernet / interface range ten-gigabitEthernet)

### Privilege Requirement

Only Admin, Operator and Power User level users have access to these commands.

### Example

Enable Port Security function for port 1/0/1, select Static mode as the learn mode, and specify the maximum number of MAC addresses that can be learned on this port as 30. When the number of MAC address entries reaches 30 on this port, new entry will be dropped :

```
T1700X-16TS(config)# interface ten-gigabitEthernet 1/0/1
T1700X-16TS(config-if)# mac address-table max-mac-count max-number
30 mode static status drop
```

## 17.7 mac address-table security

### Description

The **mac address-table security** command is used to configure security of the MAC address table in a specified VLAN.



## Syntax

```
mac address-table security vid vid max-learn number { forward | drop | disable }
```

## Parameter

*vid* — Specify the VLAN ID to configure its MAC address table.

*number* — Configure the threshold of the MAC address table in this VLAN. It ranges from 0 to 16383.

forward | drop | disable — Choose the mode when learned MAC number exceeds the threshold of the MAC address table in this VLAN.

- Drop: The packets will be dropped when learned MAC number exceeds the threshold of the MAC address table in this VLAN..
- Forward: The packets will be forward but not be learned when learned MAC number exceeds the threshold of the MAC address table in this VLAN..
- Disable: The threshold of the MAC address table is disabled.

## Command Mode

Global Configuration Mode

## Privilege Requirement

Only Admin, Operator and Power User level users have access to these commands.

## Example

Configure the max learned MAC address number is VLAN 2 as 1000, and drop the packets that have no match in the MAC address table:

```
T1700X-16TS(config)# mac address-table security vid 2 max-learn 1000
drop
```

# 17.8 show mac address-table

## Description

The **show mac address-table** command is used to display the information of all address entries.

## Syntax

```
show mac address-table [ dynamic | static | filtering ]
```

### Parameter

dynamic | static | filtering — The type of your desired entry. By default all the entries are displayed.

### Command Mode

Privileged EXEC Mode and Any Configuration Mode

### Privilege Requirement

None.

### Example

Display the information of all address entries:

```
T1700X-16TS(config)# show mac address-table
```

## 17.9 clear mac address-table

### Description

The **show mac address-table** command is used to clear the specified address entries.

### Syntax

```
clear mac address-table { dynamic | static | filtering }
```

### Parameter

dynamic | static | filtering — The type of your desired entry.

### Command Mode

Privileged EXEC Mode and Any Configuration Mode

### Privilege Requirement

Only Admin, Operator and Power User level users have access to these commands.

### Example

Clear the information of all static address entries:

```
T1700X-16TS(config)# clear mac address-table static
```

## 17.10 show mac address-table aging-time

### Description

The **show mac address-table aging-time** command is used to display the Aging Time of the MAC address.

## Syntax

```
show mac address-table aging-time
```

## Command Mode

Privileged EXEC Mode and Any Configuration Mode

## Privilege Requirement

None.

## Example

Display the Aging Time of the MAC address:

```
T1700X-16TS(config)# show mac address-table aging-time
```

# 17.11 show mac address-table max-mac-count

## Description

The **show mac address-table max-mac-count interface ten-gigabitEthernet** command is used to display the security configuration of all ports or the specified port.

## Syntax

```
show mac address-table max-mac-count { all | interface ten-gigabitEthernet  
port }
```

## Parameter

*all* — Displays the security information of all the Ethernet ports.

*port* — The Ethernet port number.

## Command Mode

Privileged EXEC Mode and Any Configuration Mode

## Privilege Requirement

None.

## Example

Display the security configuration of all ports:

```
T1700X-16TS(config)# show mac address-table max-mac-count
```

Display the security configuration of port 1/0/1:

```
T1700X-16TS(config)# show mac address-table max-mac-count interface  
ten-gigabitEthernet 1/0/1
```

## 17.12 show mac address-table interface

### Description

The **show mac address-table interface** command is used to display the address configuration of the specified port/LAG.

### Syntax

```
show mac address-table interface { ten-gigabitEthernet port | port-channel lagid }
```

### Parameter

*port* — The Ethernet port number.

*lagid* — The ID of the LAG.

### Command Mode

Privileged EXEC Mode and Any Configuration Mode

### Privilege Requirement

None.

### Example

Display the address configuration of port 1/0/1:

```
T1700X-16TS(config)# show mac address-table interface
ten-gigabitEthernet 1/0/1
```

## 17.13 show mac address-table count

### Description

The **show mac address-table count** command is used to display the total amount of MAC address table.

### Syntax

```
show mac address-table count [ vlan vlan-id ]
```

### Parameter

*vlan-id* — Specify the VLAN which the MAC entries belong to.

### Command Mode

Privileged EXEC Mode and Any Configuration Mode

### Privilege Requirement

None.

## Example

Display the total MAC entry information in different VLANs:

```
T1700X-16TS(config)# show mac address-table count
```

## 17.14 show mac address-table address

### Description

The **show mac address-table address** command is used to display the information of the specified MAC address.

### Syntax

```
show mac address-table address mac-addr [ interface { ten-gigabitEthernet  
port | port-channel lagid } | vid vlan-id ]
```

### Parameter

*mac-addr* —— The specified MAC address.

*port* —— The Ethernet port number.

*lagid* —— The ID of the LAG.

*vlan-id* —— Specify the VLAN which the entry belongs to.

### Command Mode

Privileged EXEC Mode and Any Configuration Mode

### Privilege Requirement

None.

### Example

Display the information of the MAC address 00:00:00:00:23:00 in VLAN 1:

```
T1700X-16TS(config)#show mac address-table address 00:00:00:00:23:00  
vid 1
```

## 17.15 show mac address-table vlan

### Description

The **show mac address-table vlan** command is used to display the MAC address configuration of the specified vlan.

### Syntax

```
show mac address-table vlan vid
```

### Parameter

*vid* —The specified VLAN id.

### Command Mode

Privileged EXEC Mode and Any Configuration Mode

### Privilege Requirement

None.

### Example

Display the MAC address configuration of vlan 1:

```
T1700X-16TS(config)# show mac address-table vlan 1
```

## 17.16 show mac address-table notification

### Description

The **show mac address-table notification** command is used to display the MAC notification configuration globally or on the specified port.

### Syntax

```
show mac address-table notification { all | interface ten-gigabitEthernet  
port }
```

### Parameter

*all* — Displays the notification information globally and of all the Ethernet ports.

*port* — Displays the notification information on the specified port.

### Command Mode

Privileged EXEC Mode and Any Configuration Mode

### Privilege Requirement

None.

### Example

Display the notification configuration of all the ports:

```
T1700X-16TS(config)# show mac address-table notification all
```

## 17.17 show mac address-table security

### Description

The **show mac address-table vlan** command is used to display the MAC address security configuration of the specified vlan.

## Syntax

**show mac address-table security [ vid *vid* ]**

## Parameter

*vid* —The specified VLAN id.

## Command Mode

Privileged EXEC Mode and Any Configuration Mode

## Privilege Requirement

None.

## Example

Display the MAC address security configuration of vlan 1:

```
T1700X-16TS(config)# show mac address-table security vid 1
```

# Chapter 18 System Configuration Commands

System Commands can be used to configure the System information and System IP, reboot and reset the switch, upgrade the switch system and other operations.

## 18.1 system-time manual

### Description

The **system-time manual** command is used to configure the system time manually.

### Syntax

**system-time manual** *time*

### Parameter

*time* — Set the date and time manually, MM/DD/YYYY-HH:MM:SS

### Command Mode

Global Configuration Mode

### Privilege Requirement

Only Admin and Operator level users have access to these commands.

### Example

Configure the system mode as manual, and the time is 12/20/2010 17:30:35

```
T1700X-16TS(config)# system-time manual 12/20/2010-17:30:35
```

## 18.2 system-time ntp

### Description

The **system-time ntp** command is used to configure the time zone and the IP address for the NTP Server. The switch will get UTC automatically if it has connected to an NTP Server.

### Syntax

**system-time ntp** { *timezone* } { *ntp-server* } { *backup-ntp-server* }  
{ *fetching-rate* }

### Parameter

*timezone* — Your local time-zone, and it ranges from UTC-12:00 to UTC+13:00.

The detailed information that each time-zone means are displayed as follow:

UTC-12:00 — TimeZone for International Date Line West.



UTC-11:00 — TimeZone for Coordinated Universal Time-11.  
 UTC-10:00 — TimeZone for Hawaii.  
 UTC-09:00 — TimeZone for Alaska.  
 UTC-08:00 — TimeZone for Pacific Time(US Canada).  
 UTC-07:00 — TimeZone for Mountain Time(US Canada).  
 UTC-06:00 — TimeZone for Central Time(US Canada).  
 UTC-05:00 — TimeZone for Eastern Time(US Canada).  
 UTC-04:30 — TimeZone for Caracas.  
 UTC-04:00 — TimeZone for Atlantic Time(Canada).  
 UTC-03:30 — TimeZone for Newfoundland.  
 UTC-03:00 — TimeZone for Buenos Aires, Salvador, Brasilia.  
 UTC-02:00 — TimeZone for Mid-Atlantic.  
 UTC-01:00 — TimeZone for Azores, Cape Verde Is.  
 UTC — TimeZone for Dublin, Edinburgh, Lisbon, London.  
 UTC+01:00 — TimeZone for Amsterdam, Berlin, Bern, Rome, Stockholm, Vienna.  
 UTC+02:00 — TimeZone for Cairo, Athens, Bucharest, Amman, Beirut, Jerusalem.  
 UTC+03:00 — TimeZone for Kuwait, Riyadh, Baghdad.  
 UTC+03:30 — TimeZone for Tehran.  
 UTC+04:00 — TimeZone for Moscow, St.Petersburg, Volgograd, Tbilisi, Port Louis.  
 UTC+04:30 — TimeZone for Kabul.  
 UTC+05:00 — TimeZone for Islamabad, Karachi, Tashkent.  
 UTC+05:30 — TimeZone for Chennai, Kolkata, Mumbai, New Delhi.  
 UTC+05:45 — TimeZone for Kathmandu.  
 UTC+06:00 — TimeZone for Dhaka, Astana, Ekaterinburg.  
 UTC+06:30 — TimeZone for Yangon (Rangoon).  
 UTC+07:00 — TimeZone for Novosibirsk, Bangkok, Hanoi, Jakarta.  
 UTC+08:00 — TimeZone for Beijing, Chongqing, Hong Kong, Urumqi, Singapore.  
 UTC+09:00 — TimeZone for Seoul, Irkutsk, Osaka, Sapporo, Tokyo.  
 UTC+09:30 — TimeZone for Darwin, Adelaide.  
 UTC+10:00 — TimeZone for Canberra, Melbourne, Sydney, Brisbane.  
 UTC+11:00 — TimeZone for Solomon Is., New Caledonia, Vladivostok.  
 UTC+12:00 — TimeZone for Fiji, Magadan, Auckland, Wellington.  
 UTC+13:00 — TimeZone for Nuku'alofa, Samoa.  
*ntp-server* — The IP address for the Primary NTP Server.  
*backup-ntp-server* — The IP address for the Secondary NTP Server.  
*fetching-rate* — Specify the rate fetching time from NTP server.

## Command Mode

Global Configuration Mode

## Privilege Requirement

Only Admin and Operator level users have access to these commands.

## Example

Configure the system time mode as NTP, the time zone is UTC-12:00, the primary NTP server is 133.100.9.2 and the secondary NTP server is 139.78.100.163, the fetching-rate is 11 hours:

```
T1700X-16TS(config)# system-time ntp UTC-12:00 133.100.9.2
139.79.100.163 11
```

## 18.3 system-time dst predefined

### Description

The **system-time dst predefined** command is used to select a daylight saving time configuration from the predefined mode. The configuration can be used recurrently. To disable DST function, please use **no system-time dst** command.

### Syntax

**system-time dst predefined** {USA | Australia | Europe | New-Zealand}

**no system-time dst**

### Parameter

USA | Australia | Europe | New-Zealand — The mode of daylight saving time. There are 4 options which are USA, Australia, Europe and New-Zealand respectively. The default value is Europe.

Following are the time ranges of each option:

USA: Second Sunday in March, 02:00 ~ First Sunday in November, 02:00.

Australia: First Sunday in October, 02:00 ~ First Sunday in April, 03:00.

Europe: Last Sunday in March, 01:00 ~ Last Sunday in October, 01:00.

New Zealand: Last Sunday in September, 02:00 ~ First Sunday in April, 03:00.

### Command Mode

Global Configuration Mode

### Privilege Requirement

Only Admin and Operator level users have access to these commands.

## Example

Configure the daylight saving time as USA standard:

```
T1700X-16TS(config)#system-time dst predefined USA
```

# 18.4 system-time dst date

## Description

The **system-time dst date** command is used to configure the one-off daylight saving time. The start date is in the current year by default. The time range of the daylight saving time must shorter than one year, but you can configure it spanning years. To disable DST function, please use **no system-time dst** command.

## Syntax

```
system-time dst date {smonth} {sday} {stime} {syear} {emonth} {eday} {etime}  
{eyear}[offset]
```

```
no system-time dst
```

## Parameter

*smonth* — The start month of the daylight saving time. There are 12 values showing as follows: Jan, Feb, Mar, Apr, May, Jun, Jul, Aug, Sep, Oct, Nov, Dec.

*sday* — The start day of the daylight saving time, ranging from 1 to 31. Here you should show special attention to February and the differences between a solar month and a lunar month.

*stime* — The start moment of the daylight saving time, HH:MM.

*syear* — The start year of the daylight saving time.

*emonth* — The end month of the daylight saving time. There are 12 values showing as follows: Jan, Feb, Mar, Apr, May, Jun, Jul, Aug, Sep, Oct, Nov, Dec.

*eday* — The end day of the daylight saving time, ranging from q to 31. Here you should show special attention to February and the differences between a solar month and a lunar month.

*etime* — The end moment of the daylight saving time, HH:MM.

*eyear* — The end year of the daylight saving time.

*offset* — The number of minutes to add during the daylight saving time. It is 60 minutes by default.

## Command Mode

Global Configuration Mode

## Privilege Requirement

Only Admin and Operator level users have access to these commands.

## Example

Configure the daylight saving time from zero clock, Apr 1st to zero clock Oct 1st and the offset is 30 minutes in 2015:

```
T1700X-16TS(config)# system-time dst date Apr 1 00:00 2015 Oct 1 00:00
2015 30
```

# 18.5 system-time dst recurring

## Description

The **system-time dst recurring** command is used to configure the recurring daylight saving time. It can be configured spanning years. To disable DST function, please use **no system-time dst** command.

## Syntax

```
system-time dst recurring {sweek} {sday} {smonth} {stime} {eweek} {eday}
{emonth} {etime} [offset]
```

```
no system-time dst
```

## Parameter

*sweek* — The start week of the daylight saving time. There are 5 values showing as follows: first, second, third, fourth, last.

*sday* — The start day of the daylight saving time. There are 7 values showing as follows: Sun, Mon, Tue, Wed, Thu, Fri, Sat.

*smonth* — The start month of the daylight saving time. There are 12 values showing as follows: Jan, Feb, Mar, Apr, May, Jun, Jul, Aug, Sep, Oct, Nov, Dec.

*stime* — The start moment of the daylight saving time, HH:MM.

*ewee*k — The end week of the daylight saving time. There are 5 values showing as follows: first, second, third, fourth, last.

*eday* — The end day of the daylight saving time. There are 5 values showing as follows: Sun, Mon, Tue, Wed, Thu, Fri, Sat.

*emonth* — The end month of the daylight saving time. There are 12 values showing as following: Jan, Feb, Mar, Apr, May, Jun, Jul, Aug, Sep, Oct, Nov, Dec.

*etime* — The end moment of the daylight saving time, HH:MM.

*offset* — The number of minutes to add during the daylight saving time. It is 60 minutes by default.

### Command Mode

Global Configuration Mode

### Privilege Requirement

Only Admin and Operator level users have access to these commands.

### Example

Configure the daylight saving time from 2:00am, the first Sunday of May to 2:00am, the last Sunday of Oct and the offset is 45 minutes:

```
T1700X-16TS(config)# system-time dst recurring first Sun May 02:00 last  
Sun Oct 02:00 45
```

## 18.6 hostname

### Description

The **hostname** command is used to configure the system name. To clear the system name information, please use **no hostname** command.

### Syntax

```
hostname [ hostname ]
```

```
no hostname
```

### Parameter

*hostname* — System Name. The length of the name ranges from 1 to 32 characters. By default, it is the device name, for example “T1700X-16TS”.

### Command Mode

Global Configuration Mode

### Privilege Requirement

Only Admin and Operator level users have access to these commands.

### Example

Configure the system name as TPLINK:

```
T1700X-16TS(config)# hostname TPLINK
```

## 18.7 location

### Description

The **location** command is used to configure the system location. To clear the system location information, please use **no location** command.

### Syntax

```
location [ location ]
```

```
no location
```

### Parameter

*location* — Device Location. It consists of 32 characters at most. It is “SHENZHEN” by default.

### Command Mode

Global Configuration Mode

### Privilege Requirement

Only Admin and Operator level users have access to these commands.

### Example

Configure the system location as SHENZHEN:

```
T1700X-16TS(config)# location SHENSHEN
```

## 18.8 contact-info

### Description

The **contact-info** command is used to configure the system contact information. To clear the system contact information, please use **no contact-info** command.

### Syntax

```
contact-info [ contact_info ]
```

```
no contact-info
```

### Parameter

*contact\_info* — Contact Information. It consists of 32 characters at most. It is “www.tp-link.com” by default.

### Command Mode

Global Configuration Mode

## Privilege Requirement

Only Admin and Operator level users have access to these commands.

## Example

Configure the system contact information as www.tp-link.com:

```
T1700X-16TS(config)# contact-info www.tp-link.com
```

# 18.9 ip address

## Description

This **ip address** command is used to configure the IP address and IP subnet mask for the specified interface manually. The interface type includes: routed port, port-channel interface, loopback interface and VLAN interface.

## Syntax

```
ip address { ip-addr } { mask } [ secondary ]
```

```
no ip address [ ip-addr ] [ mask ]
```

## Parameter

*ip-addr* — The IP address of the Layer 3 interface.

*mask* — The subnet mask of the Layer 3 interface.

**secondary** — Specify the interface's secondary IP address. If this parameter is omitted here, the configured IP address is the interface's primary address.

## Command Mode

Interface Configuration Mode

## Privilege Requirement

Only Admin, Operator and Power User level users have access to these commands.

## Example

Create the VLAN interface 2 with the primary IP address as 192.168.1.1/24 and secondary IP address as 192.168.2.1/24:

```
T1700X-16TS(config)# interface vlan 2  
T1700X-16TS(config-if)# ip address 192.168.1.1 255.255.255.0  
T1700X-16TS(config-if)# ip address 192.168.2.1 255.255.255.0 secondary
```

## 18.10 ip address-alloc

### Description

The **IP address-alloc** command is used to enable the DHCP Client function or the BOOTP Protocol. When this function is enabled, the specified interface will obtain IP from DHCP Server or BOOTP server. To disable the IP obtaining function on the specified interface, please use the **no ip address** command. This command applies to the routed port, the LAG and the VLAN interface.

### Syntax

```
ip address-alloc { dhcp | bootp }
```

```
no ip address
```

### Parameter

**dhcp** — Specify the Layer 3 interface to obtain IP address from the DHCP Server.

**bootp** — Specify the Layer 3 interface to obtain IP address from the BOOTP Server.

### Command Mode

Interface Configuration Mode

### Privilege Requirement

Only Admin, Operator and Power User level users have access to these commands.

### Example

Enable the DHCP Client function on the Lay 3 routed port 1/0/1:

```
T1700X-16TS(config)# interface ten-gigabitEthernet 1/0/1
```

```
T1700X-16TS(config-if)# no switchport
```

```
T1700X-16TS(config-if)# ip address-alloc dhcp
```

Disable the IP address obtaining function on the VLAN interface 2:

```
T1700X-16TS(config)# interface vlan 2
```

```
T1700X-16TS(config-if)# no ip address
```



## 18.11 reset

### Description

The **reset** command is used to reset the switch's software. After resetting, all configuration of the switch will restore to the factory defaults and your current settings will be lost.

### Syntax

**reset**

### Command Mode

Privileged EXEC Mode

### Privilege Requirement

Only Admin level users have access to these commands.

### Example

Reset the software of the switch:

```
T1700X-16TS# reset
```

## 18.12 reboot

### Description

The **reboot** command is used to reboot the Switch. To avoid damage, please don't turn off the device while rebooting.

### Syntax

**reboot**

### Command Mode

Privileged EXEC Mode

### Privilege Requirement

Only Admin level users have access to these commands.

### Example

Reboot the Switch:

```
T1700X-16TS# reboot
```

## 18.13 reboot-schedule

### Description

This **reboot-schedule** command is used to configure the switch to reboot at a certain time point. To delete the reboot schedule settings, please use the **reboot-schedule cancel** command.

### Syntax

```
reboot-schedule at time [ date ] [ save_before_reboot ]
```

```
reboot-schedule in interval [ save_before_reboot ]
```

```
reboot-schedule cancel
```

### Parameter

*time* — Specify the time point for the switch to reboot, in the format of hh:mm.

*date* — Specify the date for the switch to reboot, in the format of DD:MM:YYYY. The date should be within 30 days.

**save\_before\_reboot** — Save the configuration file before the switch reboots.

*interval* — Specify a time period after which the switch reboots. It ranges from 1 to 43200 minutes.

**cancel** — Delete the reboot schedule settings.

### Command Mode

Global Configuration Mode

### Privilege Requirement

Only Admin level users have access to these commands.

### User Guidelines

In the command **reboot-schedule at *time* [ *date* ] [ **save\_before\_reboot** ]**, if no date is specified and the time you set here is later than the time that this command is executed, the switch will reboot later that day; otherwise the switch will reboot at the time point the next day.

### Example

Specify the switch to save the configuration files and reboot in 200 minutes,:

```
T1700X-16TS(config)# reboot-schedule in 200 save_before_reboot
```

## 18.14 copy running-config startup-config

### Description

The **copy running-config startup-config** command is used to save the current settings.

### Syntax

```
copy running-config startup-config
```

### Command Mode

Privileged EXEC Mode

### Privilege Requirement

Only Admin and Operator level users have access to these commands.

### Example

Save current settings:

```
T1700X-16TS# copy running-config startup-config
```

## 18.15 copy startup-config tftp

### Description

The **copy startup-config tftp** command is used to backup the configuration file to TFTP server.

### Syntax

```
copy startup-config tftp ip-address ip-addr filename name
```

### Parameter

*ip-addr* — IP Address of the TFTP server. Both IPv4 and IPv6 addresses are supported, for example 192.168.0.1 or fe80::1234.

*name* — Specify the name for the configuration file which would be backup.

### Command Mode

Privileged EXEC Mode

### Privilege Requirement

Only Admin and Operator level users have access to these commands.

### Example

Backup the configuration files to TFTP server with the IP 192.168.0.148 and name this file config.cfg:

```
T1700X-16TS# copy startup-config tftp ip-address 192.168.0.148 filename
config
```

Backup the configuration files to TFTP server with the IP fe80::1234 and name this file config.cfg:

```
T1700X-16TS# copy startup-config tftp ip-address fe80::1234 filename
config
```

## 18.16 copy tftp startup-config

### Description

The **copy tftp startup-config** command is used to download the configuration file to the switch from TFTP server.

### Syntax

```
copy tftp startup-config ip-address ip-addr filename name
```

### Parameter

*ip-addr* — IP Address of the TFTP server. Both IPv4 and IPv6 addresses are supported, for example 192.168.0.1 or fe80::1234.

*name* — Specify the name for the configuration file which would be downloaded.

### Command Mode

Privileged EXEC Mode

### Privilege Requirement

Only Admin level users have access to these commands.

### Example

Download the configuration file named as config.cfg to the switch from TFTP server with the IP 192.168.0.148:

```
T1700X-16TS# copy tftp startup-config ip-address 192.168.0.148 filename
config
```

Download the configuration file named as config.cfg to the switch from TFTP server with the IP fe80::1234

```
T1700X-16TS# copy tftp startup-config ip-address fe80::1234 filename
config
```

## 18.17 boot application

### Description

The **boot application** command is used to configure the image file as startup image or backup image.

### Syntax

```
boot application filename { image1 | image 2 } { startup | backup }  
no boot application
```

### Parameter

image1 | image2 — Specify the image file to be configured. By default, the image1.bin is the startup image and the image2.bin is the backup image.

startup | backup — Specify the property of the image, either startup image or backup image.

### Command Mode

Global Configuration Mode

### Privilege Requirement

Only Admin level users have access to these commands.

### Example

Configure the image2.bin as the startup image:

```
T1700X-16TS(config)# boot application filename image2 startup
```

## 18.18 remove backup-image

### Description

The **remove backup-image** command is used to delete the backup-image.

### Syntax

```
remove backup-image
```

### Command Mode

Privileged EXEC Mode

### Privilege Requirement

Only Admin level users have access to these commands.

## Example

Delete the backup image file:

```
T1700X-16TS# remove backup-image
```

## 18.19 firmware upgrade

### Description

The **firmware upgrade** command is used to upgrade the switch's backup image file via the TFTP server. The uploaded firmware file will take place of the Backup Image, and user can chose whether to reboot the switch will the Backup Image.

### Syntax

```
firmware upgrade ip-address ip-addr filename name
```

### Parameter

*ip-addr* — IP Address of the TFTP server. Both IPv4 and IPv6 addresses are supported, for example 192.168.0.1 or fe80::1234.

*name* — Specify the name for the firmware file.

### Command Mode

Privileged EXEC Mode

### Privilege Requirement

Only Admin level users have access to these commands.

### Example

Upgrade the switch's backup image file with the file firmware.bin in the TFTP server with the IP address 192.168.0.148, and reboot the switch with this firmware:

```
T1700X-16TS# firmware upgrade ip-address 192.168.0.148 filename  
firmware.bin  
It will only upgrade the backup image. Continue? (Y/N):y  
Operation OK!  
Reboot with the backup image? (Y/N): y
```

Upgrade the switch's backup image file with the file firmware.bin in the TFTP server with the IP address fe80::1234, but do not reboot the switch:

```
T1700X-16TS# firmware upgrade ip-address fe80::1234 filename  
firmware.bin
```

```
It will only upgrade the backup image. Continue? (Y/N):y
```

```
Operation OK!
```

```
Reboot with the backup image? (Y/N): n
```

## 18.20 ping

### Description

The **ping** command is used to test the connectivity between the switch and one node of the network.

### Syntax

```
ping [ ip | ipv6 ] { ip_addr } [ -n count ] [ -l count ] [ -i count ]
```

### Parameter

**ip** — The type of the IP address for ping test should be IPv4.

**ipv6** — The type of the IP address for ping test should be IPv6.

**ip\_addr** — The IP address of the destination node for ping test. If the parameter ip/ipv6 is not selected, both IPv4 and IPv6 addresses are supported, for example 192.168.0.100 or fe80::1234.

**-n count** — The amount of times to send test data during Ping testing. It ranges from 1 to 10. By default, this value is 4.

**-l count** — The size of the sending data during ping testing. It ranges from 1 to 1024 bytes. By default, this value is 64.

**-i count** — The interval to send ICMP request packets. It ranges from 100 to 1000 milliseconds. By default, this value is 1000.

### Command Mode

User EXEC Mode and Privileged EXEC Mode

### Privilege Requirement

None.

### Example

To test the connectivity between the switch and the network device with the IP 192.168.0.131, please specify the *count* (-l) as 512 bytes and *count* (-i) as 1000 milliseconds. If there is not any response after 8 times' Ping test, the connection between the switch and the network device is failed to establish:

```
T1700X-16TS# ping 192.168.0.131 -n 8 -l 512
```

To test the connectivity between the switch and the network device with the IP fe80::1234, please specify the *count* (-l) as 512 bytes and *count* (-i) as 1000 milliseconds. If there is not any response after 8 times' Ping test, the connection between the switch and the network device is failed to establish:

```
T1700X-16TS# ping fe80::1234 -n 8 -l 512
```

## 18.21 **tracert**

### Description

The **tracert** command is used to test the connectivity of the gateways during its journey from the source to destination of the test data.

### Syntax

```
tracert [ ip | ipv6 ] ip_addr [ maxHops ]
```

### Parameter

*ip* — The type of the IP address for tracert test should be IPv4.

*ipv6* — The type of the IP address for tracert test should be IPv6.

*ip\_addr* — The IP address of the destination device. If the parameter ip/ipv6 is not selected, both IPv4 and IPv6 addresses are supported, for example 192.168.0.100 or fe80::1234.

*maxHops* — The maximum number of the route hops the test data can pass through. It ranges from 1 to 30. By default, this value is 4.

### Command Mode

User EXEC Mode and Privileged EXEC Mode

### Privilege Requirement

Only Admin, Operator and Power User level users have access to these commands.

### Example

Test the connectivity between the switch and the network device with the IP 192.168.0.131. If the destination device has not been found after 20 *maxHops*, the connection between the switch and the destination device is failed to establish:

```
T1700X-16TS# tracert 192.168.0.131 20
```



Test the connectivity between the switch and the network device with the IP fe80::1234. If the destination device has not been found after 20 *maxHops*, the connection between the switch and the destination device is failed to establish:

```
T1700X-16TS# tracert fe80::1234 20
```

## 18.22 show system-info

### Description

The **show system-info** command is used to display System Description, Device Name, Device Location, System Contact, Hardware Version, Firmware Version, System Time, Run Time and so on.

### Syntax

```
show system-info
```

### Command Mode

Privileged EXEC Mode and Any Configuration Mode

### Privilege Requirement

None.

### Example

Display the system information:

```
T1700X-16TS# show system-info
```

## 18.23 show image-info

### Description

The **show image-info** command is used to display the information of image files in the system.

### Syntax

```
show image-info
```

### Command Mode

Privileged EXEC Mode and Any Configuration Mode

### Privilege Requirement

Only Admin level users have access to these commands.

## Example

Display the system image files' information:

```
T1700X-16TS# show image-info
```

## 18.24 show boot

### Description

The **show boot** command is used to display the boot configuration of the system.

### Syntax

```
show boot
```

### Command Mode

Privileged EXEC Mode and Any Configuration Mode

### Privilege Requirement

Only Admin level users have access to these commands.

### Example

Display the system boot configuration information:

```
T1700X-16TS# show boot
```

## 18.25 show running-config

### Description

The **show running-config** command is used to display the current operating configuration of the system or of a specified port.

### Syntax

```
show running-config
```

### Command Mode

Privileged EXEC Mode and Any Configuration Mode

### Privilege Requirement

Only Admin level users have access to these commands.

### Example

Display the system current operating configuration:

```
T1700X-16TS# show running-config
```

## 18.26 show startup-config

### Description

The **show startup-config** command is used to display the current configuration saved in the switch. These configuration settings will not be lost the next time you reboot the switch.

### Syntax

```
show startup-config
```

### Command Mode

Privileged EXEC Mode and Any Configuration Mode

### Privilege Requirement

Only Admin level users have access to these commands.

### Example

Display the saved configuration:

```
T1700X-16TS# show startup-config
```

## 18.27 show system-time

### Description

The **show system-time** command is used to display the time information of the switch.

### Syntax

```
show system-time
```

### Command Mode

Privileged EXEC Mode and Any Configuration Mode

### Privilege Requirement

None.

### Example

Display the time information of the switch

```
T1700X-16TS# show system-time
```

## 18.28 show system-time dst

### Description

The **show system-time dst** command is used to display the DST information of the switch.

### Syntax

```
show system-time dst
```

### Command Mode

Privileged EXEC Mode and Any Configuration Mode

### Privilege Requirement

None.

### Example

Display the DST information of the switch

```
T1700X-16TS# show system-time dst
```

## 18.29 show system-time ntp

### Description

The **show system-time ntp** command is used to display the NTP mode configuration information.

### Syntax

```
show system-time ntp
```

### Command Mode

Privileged EXEC Mode and Any Configuration Mode

### Privilege Requirement

None.

### Example

Display the NTP mode configuration information of the switch:

```
T1700X-16TS# show system-time ntp
```

## 18.30 show cable-diagnostics interface ten-gigabitEthernet

### Description

The **show cable-diagnostics interface ten-gigabitEthernet** command is used to display the cable diagnostics of the connected Ethernet Port., which facilitates you to check the connection status of the cable connected to the switch, locate and diagnose the trouble spot of the network.

### Syntax

```
show cable-diagnostics interface ten-gigabitEthernet port
```

### Parameter

*port* — The number of the port which is selected for Cable test.

### Command Mode

Privileged EXEC Mode and Any Configuration Mode

### Privilege Requirement

None.

### Example

Show the cable-diagnostics of port 3:

```
T1700X-16TS# show cable-diagnostics interface ten-gigabitEthernet 1/0/3
```

## 18.31 show cpu-utilization

### Description

The **show cpu-utilization** command is used to display the system's CPU utilization in the last 5 seconds/1minute/5minutes.

### Syntax

```
show cpu-utilization
```

### Command Mode

Privileged EXEC Mode and Any Configuration Mode

### Privilege Requirement

None.

## Example

Display the CPU utilization information of the switch:

```
T1700X-16TS# show cpu-utilization
```

## 18.32 show memory-utilization

### Description

The **show memory-utilization** command is used to display the system's current memory utilization.

### Syntax

```
show memory-utilization
```

### Command Mode

Privileged EXEC Mode and Any Configuration Mode

### Privilege Requirement

None.

## Example

Display the memory utilization information of the switch:

```
T1700X-16TS# show memory-utilization
```

# Chapter 19 IPv6 Address Configuration Commands

The IPv6 address configuration commands are provided in the Interface Configuration Mode, which includes the routed port, the LAG and the VLAN interface. Enter the configuration mode of these Layer 3 interfaces and configure their IPv6 parameters.

## 19.1 ipv6 enable

### Description

This command is used to enable the IPv6 function on the specified Layer 3 interface. IPv6 function should be enabled before the IPv6 address configuration management. By default it is enabled on VLAN interface 1. IPv6 function can only be enabled on one Layer 3 interface at a time.

If the IPv6 function is disabled, the corresponding IPv6 netstack and IPv6-based modules will be invalid, for example SSHv6, SSLv6, TFTPv6 etc. To disable the IPv6 function, please use **no ipv6 enable** command.

### Syntax

**ipv6 enable**  
**no ipv6 enable**

### Command Mode

Interface Configuration Mode

### Privilege Requirement

Only Admin, Operator and Power User level users have access to these commands.

### Example

Enable the IPv6 function on the VLAN interface 1:

```
T1700X-16TS(config)# interface vlan 1
T1700X-16TS(config-if)# ipv6 enable
```

## 19.2 ipv6 address autoconfig

### Description

This command is used to enable the automatic configuration of the ipv6 link-local address. The switch has only one ipv6 link-local address, which can be configured automatically or manually. The general ipv6 link-local address has the prefix as fe80::/10. IPv6 routers cannot forward packets that have link-local source or destination addresses to other links. The autoconfigured ipv6

link-local address is in EUI-64 format. To verify the uniqueness of the link-local address, the manually configured ipv6 link-local address will be deleted when the autoconfigured ipv6 link-local address takes effect.

### Syntax

**ipv6 address autoconfig**

### Command Mode

Interface Configuration Mode

### Privilege Requirement

Only Admin, Operator and Power User level users have access to these commands.

### Example

Enable the automatic configuration of the ipv6 link-local address on VLAN interface 1:

```
T1700X-16TS(config)# interface vlan 1
T1700X-16TS(config-if)# ipv6 address autoconfig
```

## 19.3 ipv6 address link-local

### Description

The **ipv6 address link-local** command is used to configure the ipv6 link-local address manually on a specified interface. To delete the configured link-local address, please use **no ipv6 address link-local** command.

### Syntax

**ipv6 address *ipv6-addr* link-local**  
**no ipv6 address *ipv6-addr* link-local**

### Parameter

*ipv6-addr* — The link-local address of the interface. It should be a standardized IPv6 address with the prefix fe80::/10, otherwise this command will be invalid.

### Command Mode

Interface Configuration Mode

### Privilege Requirement

Only Admin, Operator and Power User level users have access to these commands.

### Example

Configure the link-local address as fe80::1234 on the VLAN interface 1:



```
T1700X-16TS(config)# interface vlan 1
T1700X-16TS(config-if)# ipv6 address fe80::1234 link-local
```

## 19.4 ipv6 address dhcp

### Description

The **ipv6 address dhcp** command is used to enable the DHCPv6 Client function. When this function is enabled, the Layer 3 interface will try to obtain IP from DHCPv6 server. To delete the allocated IP from DHCPv6 server and disable the DHCPv6 Client function, please use **no ipv6 address dhcp** command.

### Syntax

```
ipv6 address dhcp
no ipv6 address dhcp
```

### Command Mode

Interface Configuration Mode

### Privilege Requirement

Only Admin, Operator and Power User level users have access to these commands.

### Example

Enable the DHCP Client function on VLAN interface 1:

```
T1700X-16TS(config)# interface vlan 1
T1700X-16TS(config-if)# ipv6 address dhcp
```

## 19.5 ipv6 address ra

### Description

This command is used to configure the interface's global IPv6 address according to the address prefix and other configuration parameters from its received RA(Router Advertisement) message. To disable this function, please use **no ipv6 address ra** command.

### Syntax

```
ipv6 address ra
no ipv6 address ra
```

## Command Mode

Interface Configuration Mode

## Privilege Requirement

Only Admin, Operator and Power User level users have access to these commands.

## Example

Enable the automatic ipv6 address configuration function to obtain IPv6 address through the RA message on VLAN interface 1:

```
T1700X-16TS(config)# interface vlan 1
T1700X-16TS(config-if)# ipv6 address ra
```

# 19.6 ipv6 address

## Description

This command is used to manually configure a global IPv6 address on the interface. To remove a global IPv6 address from the interface, please use **no ipv6 address** command.

## Syntax

```
ipv6 address ipv6-addr
no ipv6 address ipv6-addr
```

## Parameter

*ipv6-addr* — Global IPv6 address with network prefix, for example 3ffe::1/64.

## Command Mode

Interface Configuration Mode

## Privilege Requirement

Only Admin, Operator and Power User level users have access to these commands.

## Example

Configure the global address 3001::1/64 on VLAN interface 1:

```
T1700X-16TS(config)# interface vlan 1
T1700X-16TS(config-if)# ipv6 address 3001::1/64
```

## 19.7 ipv6 address eui-64

### Description

This command is used to manually configure a global IPv6 address with an extended unique identifier (EUI) in the low-order 64 bits on the interface. Specify only the network prefix. The last 64 bits are automatically computed from the switch MAC address. To remove an EUI-64 IPv6 address from the interface, please use the **no ipv6 address eui-64** command.

### Syntax

```
ipv6 address ipv6-addr eui-64
```

```
no ipv6 address ipv6-addr eui-64
```

### Parameter

*ipv6-addr* — Global IPv6 address with 64 bits network prefix, for example 3ffe::/64.

### Command Mode

Interface Configuration Mode

### Privilege Requirement

Only Admin, Operator and Power User level users have access to these commands.

### Example

Configure an EUI-64 global address on the interface with the network prefix 3ffe::/64:

```
T1700X-16TS(config)# interface vlan 1
T1700X-16TS(config-if)# ipv6 address 3ffe::/64 eui-64
```

## 19.8 show ipv6 interface

### Description

This command is used to display the configured ipv6 information of the management interface, including ipv6 function status, link-local address and global address, ipv6 multicast groups etc.

### Syntax

```
show ipv6 interface
```

### Command Mode

Privileged EXEC Mode and Any Configuration Mode

## Privilege Requirement

None.

## Example

Display the ipv6 information of the management interface:

```
T1700X-16TS(config)# show ipv6 interface
```

## Chapter 20 Ethernet Configuration Commands

Ethernet Configuration Commands can be used to configure the Bandwidth Control, Negotiation Mode and Storm Control for Ethernet ports.

### 20.1 interface ten-gigabitEthernet

#### Description

The **interface ten-gigabitEthernet** command is used to enter the Interface ten-gigabitEthernet Configuration Mode and configure the corresponding Ten-Gigabit Ethernet port.

#### Syntax

```
interface ten-gigabitEthernet port
```

#### Parameter

*port* — The Ethernet port number.

#### Command Mode

Global Configuration Mode

#### Privilege Requirement

Only Admin, Operator and Power User level users have access to these commands.

#### Example

To enter the Interface ten-gigabitEthernet Configuration Mode and configure port 2:

```
T1700X-16TS(config)# interface ten-gigabitEthernet 1/0/2
```

### 20.2 interface range ten-gigabitEthernet

#### Description

The **interface range ten-gigabitEthernet** command is used to enter the interface range ten-gigabitEthernet Configuration Mode and configure multiple Ten-Gigabit Ethernet ports at the same time.

#### Syntax

```
interface range ten-gigabitEthernet port-list
```

## Parameter

*port-list* — The list of Ethernet ports.

## Command Mode

Global Configuration Mode

## Privilege Requirement

Only Admin, Operator and Power User level users have access to these commands.

## User Guidelines

Command in the **interface range ten-gigabitEthernet** Mode is executed independently on all ports in the range. It does not affect the execution on the other ports at all if the command results in an error on one port.

## Example

To enter the Interface range ten-gigabitEthernet Configuration Mode, and configure ports 1, 2, 3, 6, 7 and 9 at the same time by adding them to one port-list:

```
T1700X-16TS(config)# interface range ten-gigabitEthernet
1/0/1-3,1/0/6-7,1/0/9
```

## 20.3 description

### Description

The **description** command is used to add a description to the Ethernet port. To clear the description of the corresponding port, please use **no description** command.

### Syntax

```
description string
no description
```

### Parameter

*string* — Content of a port description, ranging from 1 to 16 characters.

### Command Mode

Interface Configuration Mode (interface ten-gigabitEthernet / interface range ten-gigabitEthernet / interface port-channel / interface range port-channel)

## Privilege Requirement

Only Admin, Operator and Power User level users have access to these commands.

## Example

Add a description Port \_5 to port 1/0/5:

```
T1700X-16TS(config)# interface ten-gigabitEthernet 1/0/5
T1700X-16TS(config-if)# description Port_5
```

## 20.4 shutdown

### Description

The **shutdown** command is used to disable an Ethernet port. To enable this port again, please use **no shutdown** command.

### Syntax

**shutdown**

**no shutdown**

### Command Mode

Interface Configuration Mode (interface ten-gigabitEthernet / interface range ten-gigabitEthernet / interface port-channel / interface range port-channel)

## Privilege Requirement

Only Admin, Operator and Power User level users have access to these commands.

## Example

Disable port 1/0/3:

```
T1700X-16TS(config)# interface ten-gigabitEthernet 1/0/3
T1700X-16TS(config-if)# shutdown
```

## 20.5 flow-control

### Description

The **flow-control** command is used to enable the flow-control function for a port. To disable the flow-control function for this corresponding port, please use **no flow-control** command. With the flow-control function enabled, the Ingress Rate and Egress Rate can be synchronized to avoid packet loss in the network.

## Syntax

**flow-control**

**no flow-control**

## Command Mode

Interface Configuration Mode (interface ten-gigabitEthernet / interface range ten-gigabitEthernet / interface port-channel / interface range port-channel)

## Privilege Requirement

Only Admin and Operator level users have access to these commands.

## Example

Enable the flow-control function for port 1/0/3:

```
T1700X-16TS(config)# interface ten-gigabitEthernet 1/0/3
T1700X-16TS(config-if)# flow-control
```

# 20.6 duplex

## Description

The **duplex** command is used to configure the Duplex Mode for an Ethernet port. To return to the default configuration, please use **no duplex** command.

## Syntax

**duplex** { auto | full | half }

**no duplex**

## Parameter

auto | full | half — The duplex mode of the Ethernet port. There are three options: auto-negotiation mode, full-duplex mode and half-duplex mode. By default the Ten-Gigabit Ethernet port is auto-negotiation mode.

## Command Mode

Interface Configuration Mode (interface ten-gigabitEthernet / interface range ten-gigabitEthernet / interface port-channel / interface range port-channel)

## Privilege Requirement

Only Admin and Operator level users have access to these commands.

## Example

Configure the Duplex Mode as full-duplex for port 1/0/3:



```
T1700X-16TS(config)# interface ten-gigabitEthernet 1/0/3
T1700X-16TS(config-if)# duplex full
```

## 20.7 jumbo

### Description

The **jumbo** command is used to allow the jumbo frame to pass through this port. To disable this feature, please use **no jumbo** command. This feature is disabled by default.

### Syntax

```
jumbo
no jumbo
```

### Command Mode

Interface Configuration Mode (interface ten-gigabitEthernet / interface range ten-gigabitEthernet / interface port-channel / interface range port-channel)

### Privilege Requirement

Only Admin, Operator and Power User level users have access to these commands.

### Example

Allow jumbo frame on port 1/0/3:

```
T1700X-16TS(config)# interface ten-gigabitEthernet 1/0/3
T1700X-16TS(config-if)# jumbo
```

## 20.8 speed

### Description

The **speed** command is used to configure the Speed Mode for an Ethernet port. To return to the default configuration, please use **no speed** command.

### Syntax

```
speed { 100 | 1000 | 10000 | auto }
no speed
```

### Parameter

100 | 1000 | 10000 | auto — The speed mode of the Ethernet port. There are four options: 100Mbps, 1000Mbps, 10Gbps and Auto negotiation mode (default).

## Command Mode

Interface Configuration Mode (interface ten-gigabitEthernet / interface range ten-gigabitEthernet / interface port-channel / interface range port-channel)

## Privilege Requirement

Only Admin and Operator level users have access to these commands.

## Example

Configure the Speed Mode as 1000Mbps for port 1/0/3:

```
T1700X-16TS(config)# interface ten-gigabitEthernet 1/0/3
T1700X-16TS(config-if)# speed 1000
```

# 20.9 storm-control pps

## Description

The **storm-control pps** command is used to configure the storm control mode as pps(packets per second) on an interface. To disable the pps mode, please use **no storm-control pps** command.

## Syntax

```
storm-control pps
no storm-control pps
```

## Command Mode

Interface Configuration Mode (interface ten-gigabitEthernet / interface range ten-gigabitEthernet / interface port-channel / interface range port-channel)

## Privilege Requirement

Only Admin, Operator and Power User level users have access to these commands.

## User Guidelines

This command should be used along with the [storm-control](#) command to enable the storm control function and specify the detailed parameters in pps mode.

## Example

Set the storm control mode as pps on port 1/0/5:

```
T1700X-16TS(config)# interface ten-gigabitEthernet 1/0/5
T1700X-16TS(config-if)# storm-control pps
```

## 20.10 storm-control

### Description

The **storm-control** command is used to enable the broadcast, multicast, or unicast storm control function and to set threshold levels on an interface. To disable the storm control function, please use **no storm-control** command.

### Syntax

```
storm-control { broadcast | multicast | unicast } { kbps | ratio | pps } { rate }  
no storm-control { broadcast | multicast | unicast }
```

### Parameter

broadcast | multicast | unicast — Enable broadcast/multicast/unicast storm control on the interface.

kbps | ratio | pps — Specify the storm control type.

kbps: Specify the threshold in kbits per second.

ratio: Specify the threshold as a percentage of the bandwidth.

pps: Specify the threshold in packets per second.

*rate* — Specify the bandwidth for receiving packets on the port. The specified type of packet traffic exceeding the bandwidth will be discarded. For kbps, the rate ranges from 1 to 10000000Kbps. For ratio, the rate ranges from 1 to 100 percent. For pps, the rate ranges from 1 to 14880000 packets per second.

### Command Mode

Interface Configuration Mode (interface ten-gigabitEthernet / interface range ten-gigabitEthernet / interface port-channel / interface range port-channel)

### Privilege Requirement

Only Admin, Operator and Power User level users have access to these commands.

### User Guidelines

Before you configure the storm-control type as kbps or ratio, please ensure that the port is not in pps mode.

### Example

Configure the broadcast storm control rate as 1000 kbps on port 1/0/5:

```
T1700X-16TS(config)# interface ten-gigabitEthernet 1/0/5  
T1700X-16TS(config-if)# storm-control broadcast kbps 1000
```

## 20.11 bandwidth

### Description

The **bandwidth** command is used to configure the bandwidth limit for an Ethernet port. To disable the bandwidth limit, please use **no bandwidth** command.

### Syntax

```
bandwidth {[ ingress ingress-rate ] [ egress egress-rate ]}  
no bandwidth { all | ingress | egress }
```

### Parameter

*ingress-rate* — Specify the bandwidth for receiving packets. Range: 1-10000000Kbps for the gigaport.

*egress-rate* — Specify the bandwidth for sending packets. Range: 1-10000000Kbps for the gigaport.

### Command Mode

Interface Configuration Mode (interface ten-gigabitEthernet / interface range ten-gigabitEthernet / interface port-channel / interface range port-channel)

### Privilege Requirement

Only Admin, Operator and Power User level users have access to these commands.

### Example

Configure the ingress-rate as 5120Kbps and egress-rate as 1024Kbps for port 1/0/5:

```
T1700X-16TS(config)# interface ten-gigabitEthernet 1/0/5  
T1700X-16TS(config-if)# bandwidth ingress 5120 egress 1024
```

## 20.12 clear counters

### Description

The **clear counters** command is used to clear the statistics information of all the Ethernet ports and LAGs.

### Syntax

```
clear counters  
clear counters interface [ ten-gigabitEthernet port ] [ port-channel lagid ]
```

## Parameter

*port* — The Ethernet port number.

*lagid* — The ID of the LAG.

## Command Mode

Privileged EXEC Mode and Any Configuration Mode

## Privilege Requirement

Only Admin and Operator level users have access to these commands.

## Example

Clear the statistic information of all ports and LAGs:

```
T1700X-16TS(config)# clear counters
```

## 20.13 show interface status

### Description

The **show interface status** command is used to display the connection status of the Ethernet port/LAG.

### Syntax

```
show interface status [ ten-gigabitEthernet port ] [ port-channel lagid ]
```

### Parameter

*port* — The Ethernet port number.

*lagid* — The ID of the LAG.

### Command Mode

Privileged EXEC Mode and Any Configuration Mode

### Privilege Requirement

None.

### Example

Display the connection status of all ports and LAGs:

```
T1700X-16TS(config)# show interface status
```

Display the connection status of port 1/0/1:

```
T1700X-16TS(config)# show interface status ten-gigabitEthernet 1/0/1
```

## 20.14 show interface counters

### Description

The **show interface counters** command is used to display the statistics information of all ports/LAGs.

### Syntax

```
show interface counters [ ten-gigabitEthernet port ] [ port-channel lagid ]
```

### Parameter

*port* — The Ethernet port number.

*lagid* — The ID of the LAG.

### Command Mode

Privileged EXEC Mode and Any Configuration Mode

### Privilege Requirement

None.

### Example

Display the statistics information of all Ethernet ports and LAGs:

```
T1700X-16TS(config)# show interface counters
```

Display the statistics information of port 1/0/2:

```
T1700X-16TS(config)# show interface counters ten-gigabitEthernet 1/0/2
```

## 20.15 show interface configuration

### Description

The **show interface configuration** command is used to display the configurations of all ports and LAGs, including Port-status, Flow Control, Negotiation Mode and Port-description.

### Syntax

```
show interface configuration [ ten-gigabitEthernet port ] [ port-channel lagid ]
```

### Parameter

*port* — The Ethernet port number.

*lagid* — The ID of the LAG.

### Command Mode

Privileged EXEC Mode and Any Configuration Mode

## Privilege Requirement

None.

## Example

Display the configurations of all Ethernet ports and LAGs:

```
T1700X-16TS(config)# show interface configuration
```

Display the configurations of port 1/0/2:

```
T1700X-16TS(config)# show interface configuration ten-gigabitEthernet  
1/0/2
```

## 20.16 show storm-control

### Description

The **show storm-control** command is used to display the storm-control information of Ethernet ports.

### Syntax

```
show storm-control interface [ ten-gigabitEthernet port-list ] [ port-channel  
lagid-list ]
```

### Parameter

*port-list* — The list of Ethernet ports.

*lagid-list* — The list of LAGs.

### Command Mode

Privileged EXEC Mode and Any Configuration Mode

## Privilege Requirement

None.

## Example

Display the storm-control information of port 4, 5, 6, and 7:

```
T1700X-16TS(config)# show storm-control interface ten-gigabitEthernet  
1/0/4-7
```

## 20.17 show bandwidth

### Description

The **show bandwidth** command is used to display the bandwidth-limit information of Ethernet ports.

## Syntax

```
show bandwidth interface [ ten-gigabitEthernet port-list ] [ port-channel  
lagid-list ]
```

## Parameter

*port-list* —— The list of Ethernet ports.

*lagid-list* —— The list of LAGs.

## Command Mode

Privileged EXEC Mode and Any Configuration Mode

## Privilege Requirement

None.

## Example

Display the bandwidth-limit information of port 1/0/4:

```
T1700X-16TS(config)# show bandwidth interface ten-gigabitEthernet 1/0/4
```



# Chapter 21 QoS Commands

QoS (Quality of Service) function is used to optimize the network performance. It provides you with network service experience of a better quality.

## 21.1 qos

### Description

The **qos** command is used to configure CoS (Class of Service) based on port. To return to the default configuration, please use **no qos** command.

### Syntax

**qos** *cos-id*

**no qos**

### Parameter

*cos-id* — The priority of port. It ranges from 0 to 7, which represent CoS0-CoS7 respectively. By default, the priority is 0.

### Command Mode

Interface Configuration Mode (interface ten-gigabitEthernet / interface range ten-gigabitEthernet / interface port-channel / interface range port-channel)

### Privilege Requirement

Only Admin, Operator and Power User level users have access to these commands.

### User Guidelines

Port priority is one property of the port. When the port priority is specified, the data will be classified into the egress queue based on the CoS value of the ingress port and the mapping relation between the CoS and TC in IEEE 802.1P.

### Example

Configure the priority of port 5 as 3:

```
T1700X-16TS(config)# interface ten-gigabitEthernet 1/0/5
T1700X-16TS(config-if)# qos 3
```

## 21.2 qos dscp

### Description

The **qos dscp** command is used to enable the mapping relation between DSCP Priority and CoS value. To disable the mapping relation, please use **no qos dscp** command.

### Syntax

```
qos dscp  
no qos dscp
```

### Command Mode

Global Configuration Mode

### Privilege Requirement

Only Admin, Operator and Power User level users have access to these commands.

### User Guidelines

DSCP (DiffServ Code Point) is a new definition to IP ToS field given by IEEE. DSCP priorities are mapped to the corresponding 802.1p priorities. IP datagram will be classified into the egress queue based on the mapping relation between DSCP priority and CoS value.

### Example

Enable the mapping relation between DSCP Priority and CoS value:

```
T1700X-16TS(config)# qos dscp
```

## 21.3 qos queue cos-map

### Description

The **qos queue cos-map** command is used to configure the mapping relation between IEEE 802.1P priority tag/IEEE 802.1Q tag, CoS value and the TC egress queue. To return to the default configuration, please use **no qos queue cos-map** command. When 802.1P Priority is enabled, the packets with 802.1Q tag are mapped to different priority levels based on 802.1P priority mode. The untagged packets are mapped based on port priority mode.

### Syntax

```
qos queue cos-map { tag/cos-id } { tc-id }  
no qos queue cos-map
```

## Parameter

*tag/cos-id* — The 8 priority levels defined by IEEE 802.1P or the priority level the packets with tag are mapped to, which ranges from CoS 0 to CoS 7.

*tc-id* — The egress queue the packets with tag are mapped to. It ranges from 0 to 7, which represents TC0 to TC7 respectively.

## Command Mode

Global Configuration Mode

## Privilege Requirement

Only Admin, Operator and Power User level users have access to these commands.

## User Guidelines

1. By default, the mapping relation between tag/cos and the egress queue is: 0/CoS 0-TC1, 1/CoS 1-TC0, 2/CoS 2-TC2, 3/CoS 3-TC3, 4/CoS 4-TC4, 5/CoS 5-TC5, 6/CoS 6-TC6, 7/CoS 7-TC7.
2. Among the priority levels TC0-TC7, the bigger value, the higher priority.

## Example

Map CoS 5 to TC 2:

```
T1700X-16TS(config)# qos queue cos-map 5 2
```

# 21.4 qos queue dscp-map

## Description

The **qos queue dscp-map** command is used to configure the mapping relation between DSCP Priority and the CoS value. To return to the default configuration, please use **no qos queue dscp-map** command. DSCP (DiffServ Code Point) is a new definition to IP ToS field given by IEEE. This field is used to divide IP datagram into 64 priorities. When DSCP Priority is enabled, IP datagram are mapped to different priority levels based on DSCP priority mode; non-IP datagram with IEEE 802.1Q tag are mapped to different priority levels based on IEEE 802.1P priority mode if IEEE 802.1P Priority is enabled; the untagged non-IP datagram are mapped based on port priority mode.

## Syntax

```
qos queue dscp-map { dscp-list } { cos-id }  
no qos queue dscp-map
```

## Parameter

*dscp-list* — List of DSCP value. One or several DSCP values can be typed using comma to separate. Use a hyphen to designate a range of values, for instance, 1,4-7,11 indicates choosing 1,4,5,6,7,11. The DSCP value ranges from 0 to 63.

*cos-id* — The priority level the packets with tag are mapped to, which ranges from CoS 0 to CoS 7.

## Command Mode

Global Configuration Mode

## Privilege Requirement

Only Admin, Operator and Power User level users have access to these commands.

## User Guidelines

By default, the mapping relation between tag and the egress queue is: (0-7)-CoS 0, (8-15)-CoS 1, (16-23)-CoS 2, (24-31)-CoS 3, (32-39)-CoS 4, (40-47)-CoS 5, (48-55)-CoS 6, (56-63)-CoS 7.

## Example

Map DSCP values 10-12 to CoS 2:

```
T1700X-16TS(config)# qos queue dscp-map 10-12 2
```

# 21.5 qos queue mode

## Description

The **qos queue mode** command is used to configure the Schedule Mode. To return to the default Equal-Mode, please use **no qos queue mode** command. When the network is congested, the program that many packets complete for resources must be solved, usually in the way of queue scheduling. The switch will control the forwarding sequence of the packets according to the priority queues and scheduling algorithms you set. On this switch, the priority levels are labeled as TC0, TC1, TC2 ... TC7.

## Syntax

```
qos queue mode { sp | wrr | spwrr | equ }
```

```
no qos queue mode
```

## Parameter

sp — Strict-Priority Mode. In this mode, the queue with higher priority will occupy the whole bandwidth. Packets in the queue with lower priority are sent only when the queue with higher priority is empty.

wrr — Weight Round Robin Mode. In this mode, packets in all the queues are sent in order based on the weight value for each queue. The weight values of TC0, TC1, TC2, TC3, TC4, TC5, TC6 and TC7 are customized in [qos queue weight](#) command and their default values are 1, 2, 4, 8, 16, 32, 64 and 127 respectively.

spwrr — Strict-Priority + Weight Round Robin Mode. In this mode, the switch provides two scheduling groups, SP group and WRR group. SP group is processed prior to WRR group. Queues in SP group are scheduled strictly based on Strict-Priority mode while the queues inside WRR group follow the WRR mode. In SP+WRR mode, TC7 and the queue with its weight value set as 0 are in the SP group; other queues, with non-zero weight value, belong to the WRR group and the weight value can be customized in [qos queue weight](#) command. The weight values of TC0, TC1, TC2, TC3, TC4, TC5 and TC6 are 1, 2, 4, 8, 16, 32 and 64 respectively, while the value of TC7 is 0 and non-configurable.

equ — Equal-Mode. In this mode, all the queues occupy the bandwidth equally. The weight value ratio of all the queues is 1:1:1:1:1:1:1

## Command Mode

Global Configuration Mode

## Privilege Requirement

Only Admin, Operator and Power User level users have access to these commands.

## Example

Specify the Schedule Mode as Weight Round Robin Mode:

```
T1700X-16TS(config)# qos queue mode wrr
```

# 21.6 qos queue weight

## Description

The **qos queue weight** command is used to configure weight value of each queue after the Schedule Mode is specified as WRR or SP+WRR. The switch will control the forwarding sequence of the packets according to the priority

queues and scheduling algorithms you set. On this switch, the priority levels are labeled as TC0, TC1, TC2, TC3, TC4, TC5, TC6 and TC7.

## Syntax

```
qos queue weight { tc-id } { weight-value }
```

## Parameter

*tc-id* — The ID of the TC queue, ranging from 0 to 7.

*weight-value* — Configure the weight value of the specified TC queue.

When the schedule mode is specified as WRR, the weight value ranges from 1 to 127. The 8 queues will take up the bandwidth according to their ratio. The default values of TC0, TC1, TC2, TC3, TC4, TC5, TC6 and TC7 are 1, 2, 4, 8, 16, 32, 64 and 127 respectively.

When the schedule mode is specified as SP+WRR, the weight value ranges from 0 to 127. TC7 and the queue with its weight value set as 0 are in the SP group; other queues, with non-zero weight value, belong to the WRR group. In this SP+WRR scheduling mode, the queues in the SP group is scheduled preferentially (TC6>TC5>TC4>TC3>TC2>TC1>TC0 in strict priority). When there is no packets to be sent in the SP group, the queues in the WRR group will be scheduled according to the weight value of each queue. The default weight values of TC0, TC1, TC2, TC3, TC4, TC5 and TC6 are 1, 2, 4, 8, 16, 32 and 64 respectively, while the value of TC7 is 0 and non-configurable.

## Command Mode

Global Configuration Mode

## Privilege Requirement

Only Admin, Operator and Power User level users have access to these commands.

## Example

Specify the Schedule Mode as Weight Round Robin Mode, with the weight values of TC0, TC1, TC2 and TC3 as 4, 7, 15 and 24:

```
T1700X-16TS(config)# qos queue mode wrr
T1700X-16TS(config)# qos queue weight 0 4
T1700X-16TS(config)# qos queue weight 1 7
T1700X-16TS(config)# qos queue weight 2 15
T1700X-16TS(config)# qos queue weight 3 24
```

## 21.7 show qos interface

### Description

The **show qos interface** command is used to display the configuration of QoS based on port priority.

### Syntax

```
show qos interface [ ten-gigabitEthernet port-list ] [ port-channel lagid-list ]
```

### Parameter

*port-list* —— The list of Ethernet ports.

*lagid-list* —— The list of LAGs.

### Command Mode

Privileged EXEC Mode and Any Configuration Mode

### Privilege Requirement

None.

### Example

Display the configuration of QoS for all ports and LAGs:

```
T1700X-16TS# show qos interface
```

Display the configuration of QoS for ports 1/0/1-4:

```
T1700X-16TS# show qos interface ten-gigabitEthernet 1/0/1-4
```

## 21.8 show qos cos-map

### Description

The **show qos cos-map** command is used to display the configuration of IEEE 802.1P Priority and the mapping relation between cos-id and tc-id.

### Syntax

```
show qos cos-map
```

### Command Mode

Privileged EXEC Mode and Any Configuration Mode

### Privilege Requirement

None.

### Example

Display the configuration of IEEE 802.1P Priority and the mapping relation between cos-id and tc-id:

```
T1700X-16TS# show qos cos-map
```

## 21.9 show qos dscp-map

### Description

The **show qos dscp-map** command is used to display the configuration of DSCP Priority.

### Syntax

```
show qos dscp-map
```

### Command Mode

Privileged EXEC Mode and Any Configuration Mode

### Privilege Requirement

None.

### Example

Display the configuration of DSCP Priority:

```
T1700X-16TS# show qos dscp-map
```

## 21.10 show qos queue mode

### Description

The **show qos queue mode** command is used to display the schedule rule of the egress queues.

### Syntax

```
show qos queue mode
```

### Command Mode

Privileged EXEC Mode and Any Configuration Mode

### Privilege Requirement

None.

### Example

Display the schedule rule of the egress queues:

```
T1700X-16TS# show qos queue mode
```



## 21.11 show qos status

### Description

The **show qos status** command is used to display the status of IEEE 802.1P priority and DSCP priority.

### Syntax

```
show qos status
```

### Command Mode

Privileged EXEC Mode and Any Configuration Mode

### Privilege Requirement

None.

### Example

Display the status of IEEE 802.1P priority and DSCP priority:

```
T1700X-16TS# show qos status
```

## Chapter 22 Port Mirror Commands

Port Mirror refers to the process of forwarding copies of packets from one port/multiple ports to a monitoring port. Usually, the monitoring port is connected to data diagnose device, which is used to analyze the monitored packets for monitoring and troubleshooting the network.

### 22.1 monitor session destination interface

#### Description

The **monitor session destination interface** command is used to configure the monitoring port. Each monitor session has only one monitoring port. To change the monitoring port, please use the **monitor session destination interface** command by changing the port value. The **no monitor session** command is used to delete the corresponding monitoring port or monitor session.

#### Syntax

```
monitor session session_num destination interface ten-gigabitEthernet  
port
```

```
no monitor session session_num destination interface ten-gigabitEthernet  
port
```

```
no monitor session session_num
```

#### Parameter

*session\_num* — The monitor session number, can only be specified as 1.

*port* — The monitoring port number.

#### Command Mode

Global Configuration Mode

#### Privilege Requirement

Only Admin and Operator level users have access to these commands.

#### Example

Create monitor session 1 and configure port 1/0/1 as the monitoring port:

```
T1700X-16TS(config)# monitor session 1 destination interface  
ten-gigabitEthernet 1/0/1
```

Delete the monitoring port 1/0/2 from monitor session 1:

```
T1700X-16TS(config)# no monitor session 1 destination interface
ten-gigabitEthernet 1/0/2
```

Delete the monitor session 1:

```
T1700X-16TS(config)# no monitor session 1
```

## 22.2 monitor session source interface

### Description

The **monitor session source interface** command is used to configure the monitored port/LAG. To delete the corresponding monitored port/LAG, please use **no monitor session source interface** command.

### Syntax

```
monitor session session_num source interface { ten-gigabitEthernet
port-list | port-channel lagid-list } mode
```

```
no monitor session session_num source interface { ten-gigabitEthernet
port-list | port-channel lagid-list } mode
```

### Parameter

*session\_num* — The monitor session number, can only be specified as 1.

*port-list* — List of monitored port. It is multi-optional.

*lagid-list* — List of monitored LAGs. It is multi-optional.

*mode* — The monitor mode. There are three options: rx, tx and both. Rx (ingress monitoring mode), means the incoming packets received by the monitored port will be copied to the monitoring port. Tx (egress monitoring mode), indicates the outgoing packets sent by the monitored port will be copied to the monitoring port. Both (ingress and egress monitoring), presents the incoming packets received and the outgoing packets sent by the monitored port will both be copied to the monitoring port.

### Command Mode

Global Configuration Mode

### Privilege Requirement

Only Admin and Operator level users have access to these commands.

### User Guidelines

1. The monitoring port is corresponding to current interface configuration mode.

2. Monitored ports number is not limited, but it can't be the monitoring port at the same time.
3. Whether the monitoring port and monitored ports are in the same VLAN or not is not demanded strictly.
4. The monitoring port cannot be link-aggregation member.

### Example

Create monitor session 1, then configure port 4, 5, 7 as monitored port and enable ingress monitoring:

```
T1700X-16TS(config)# monitor session 1 source interface
ten-gigabitEthernet 1/0/4-5,1/0/7 rx
```

Delete port 4 in monitor session 1 and its configuration:

```
T1700X-16TS(config)# no monitor session 1 source interface
ten-gigabitEthernet 1/0/4 rx
```

## 22.3 show monitor session

### Description

The **show monitor session** command is used to display the configuration of port monitoring.

### Syntax

```
show monitor session [session_num]
```

### Parameter

*session\_num* — The monitor session number, can only be specified as 1. It is optional.

### Command Mode

Privileged EXEC Mode and Any Configuration Mode

### Privilege Requirement

None.

### Example

Display the monitoring configuration of monitor session 1:

```
T1700X-16TS(config)# show monitor session 1
```

## Chapter 23 Port Isolation Commands

Port Isolation provides a method of restricting traffic flow to improve the network security by forbidding the port to forward packets to the ports that are not on its forwarding port list.

### 23.1 port isolation

#### Description

The **port isolation** command is used to configure the forward port/LAG list of a port/LAG, so that this port/LAG can only communicate with the ports/LAGs on its list. To delete the corresponding configuration, please use **no port isolation** command.

#### Syntax

```
port isolation { [ te-forward-list te-forward-list ] [ po-forward-list  
po-forward-list ] }
```

```
no port isolation
```

#### Parameter

*te-forward-list* — The list of Ethernet ports.

*po-forward-list* — The list of LAGs.

#### Command Mode

Interface Configuration Mode (interface ten-gigabitEthernet / interface range ten-gigabitEthernet / interface port-channel / interface range port-channel)

#### Privilege Requirement

Only Admin and Operator level users have access to these commands.

#### Example

Set port 1, 2, 4 and LAG 2 to the forward list of port 1/0/5:

```
T1700X-16TS(config)# interface ten-gigabitEthernet 1/0/5  
T1700X-16TS(config-if)# port isolation te-forward-list 1/0/1-2,1/0/4  
po-forward-list 2
```

Set all Ethernet ports and LAGs to forward list of port 1/0/2, namely restore to the default setting:

```
T1700X-16TS(config)# interface ten-gigabitEthernet 1/0/2  
T1700X-16TS(config-if)# no port isolation
```

## 23.2 show port isolation interface

### Description

The **show port isolation interface** command is used to display the forward port list of a port/LAG.

### Syntax

```
show port isolation interface [ ten-gigabitEthernet port | port-channel lagid ]
```

### Parameter

*port* — The number of Ethernet port you want to show its forward port list, in the format of 1/0/2.

*lagid* — The ID of LAG you want to show its forward port list, ranging from 1 to 14.

### Command Mode

Privileged EXEC Mode and Any Configuration Mode

### Privilege Requirement

None.

### Example

Display the forward-list of port 1/0/2:

```
T1700X-16TS# show port isolation interface ten-gigabitEthernet 1/0/2
```

Display the forward-list of all Ethernet ports and LAGs:

```
T1700X-16TS# show port isolation interface
```

## Chapter 24 Loopback Detection Commands

With loopback detection feature enabled, the switch can detect loops using loopback detection packets. When a loop is detected, the switch will display an alert or further block the corresponding port according to the configuration.

### 24.1 loopback-detection(global)

#### Description

The **loopback-detection** command is used to enable the loopback detection function globally. To disable it, please use **no loopback detection** command.

#### Syntax

**loopback-detection**

**no loopback-detection**

#### Command Mode

Global Configuration Mode

#### Privilege Requirement

Only Admin, Operator and Power User level users have access to these commands.

#### Example

Enable the loopback detection function globally:

```
T1700X-16TS(config)# loopback-detection
```

### 24.2 loopback-detection interval

#### Description

The **loopback-detection interval** command is used to define the interval of sending loopback detection packets from switch ports to network, aiming at detecting network loops periodically.

#### Syntax

**loopback-detection interval** *interval-time*

#### Parameter

*interval-time* — The interval of sending loopback detection packets. It ranges from 1 to 1000 seconds. By default, this value is 30.

## Command Mode

Global Configuration Mode

## Privilege Requirement

Only Admin, Operator and Power User level users have access to these commands.

## Example

Specify the interval-time as 50 seconds:

```
T1700X-16TS(config)# loopback-detection interval 50
```

## 24.3 loopback-detection recovery-time

### Description

The **loopback-detection recovery-time** command is used to configure the time after which the blocked port would automatically recover to normal status.

### Syntax

```
loopback-detection recovery-time recovery-time
```

### Parameter

*recovery-time* — The time after which the blocked port would automatically recover to normal status, and the loopback detection would restart. It is integral times of detection interval, ranging from 1 to 100 and the default value is 3.

## Command Mode

Global Configuration Mode

## Privilege Requirement

Only Admin, Operator and Power User level users have access to these commands.

## Example

Configure the recovery-time as 3 times of detection interval:

```
T1700X-16TS(config)# loopback-detection recovery-time 3
```

## 24.4 loopback-detection(interface)

### Description

The **loopback-detection** command is used to enable the loopback detection function of the specified port. To disable it, please use **no loopback-detection** command.



## Syntax

**loopback-detection**

**no loopback-detection**

## Command Mode

Interface Configuration Mode (interface ten-gigabitEthernet / interface range ten-gigabitEthernet)

## Privilege Requirement

Only Admin, Operator and Power User level users have access to these commands.

## Example

Enable the loopback detection function of ports 1-3:

```
T1700X-16TS(config)# interface range ten-gigabitEthernet 1/0/1-3
T1700X-16TS(Config-if-range)# loopback-detection
```

# 24.5 loopback-detection config

## Description

The **loopback-detection config** command is used to configure the process-mode and recovery-mode for the ports by which the switch copes with the detected loops.

## Syntax

```
loopback-detection config [ process-mode { alert | port-based }]
[ recovery-mode { auto | manual }]
```

## Parameter

**process-mode** — The mode how the switch processes the detected loops.

**Alert:** When a loop is detected, display an alert.

**Port based:** When a loop is detected, display an alert and block the port.

**recovery-mode** — The mode how the blocked port recovers to normal status.

**Auto:** Block status can be automatically removed after recovery time.

**Manual:** Block status can only be removed manually.

## Command Mode

Interface Configuration Mode (interface ten-gigabitEthernet / interface range ten-gigabitEthernet)

## Privilege Requirement

Only Admin, Operator and Power User level users have access to these commands.

## Example

Configure the loopback detection process-mode as port-based and recovery-mode as manual for port 2:

```
T1700X-16TS(config)# interface ten-gigabitEthernet 1/0/2
T1700X-16TS(config-if)# loopback-detection config process-mode
port-based recovery-mode manual
```

## 24.6 loopback-detection recover

### Description

The **loopback-detection recover** command is used to remove the block status of selected ports, recovering the blocked ports to normal status,

### Syntax

```
loopback-detection recover
```

### Command Mode

Interface Configuration Mode (interface ten-gigabitEthernet / interface range ten-gigabitEthernet)

### Privilege Requirement

Only Admin, Operator and Power User level users have access to these commands.

### Example

Recover the blocked port 2 to normal status:

```
T1700X-16TS(config)# interface ten-gigabitEthernet 1/0/2
T1700X-16TS(config-if)# loopback-detection recover
```

## 24.7 show loopback-detection global

### Description

The **show loopback-detection global** command is used to display the global configuration of loopback detection function such as loopback detection global status, loopback detection interval and loopback detection recovery time.

## Syntax

```
show loopback-detection global
```

## Command Mode

Privileged EXEC Mode and Any Configuration Mode

## Privilege Requirement

None.

## Example

Display the global configuration of loopback detection function:

```
T1700X-16TS# show loopback-detection global
```

# 24.8 show loopback-detection interface

## Description

The **show loopback-detection interface** command is used to display the configuration of loopback detection function and the status of the specified Ethernet port.

## Syntax

```
show loopback-detection interface [ ten-gigabitEthernet port ]
```

## Parameter

*port* — The Ethernet port number.

## Command Mode

Privileged EXEC Mode and Any Configuration Mode

## Privilege Requirement

None.

## Example

Display the configuration of loopback detection function and the status of all ports:

```
T1700X-16TS# show loopback-detection interface
```

Display the configuration of loopback detection function and the status of port 5:

```
T1700X-16TS# show loopback-detection interface ten-gigabitEthernet  
1/0/5
```

# Chapter 25 ACL Commands

## 25.1 access-list create

### Description

The **access-list create** command is used to create standard-IP ACL, extend-IP ACL and the IPv6 ACL.

### Syntax

**access-list create** *access-list-num*

### Parameter

*access-list-num* — ACL ID, ranging from 500 to 2499. The ID range of Standard-IP ACL ranges is 500-1499, the Extend-IP ACL is 1500-2499 and the IPv6 ACL is 3500-4499.

### Command Mode

Global Configuration Mode

### Privilege Requirement

Only Admin, Operator and Power User level users have access to these commands.

### Example

Create a standard-IP ACL whose ID is 523:

```
T1700X-16TS(config)# access-list create 523
```

## 25.2 mac access-list

### Description

The **mac access-list** command is used to create MAC ACL. To set the detailed configurations for a specified MAC ACL, please use **mac access-list** command to access Mac Access-list Configuration Mode. To delete the MAC ACL, please use **no mac access-list**.

### Syntax

**mac access-list** *access-list-num*

**no mac access-list** *access-list-num*

## Parameter

*access-list-num* — ACL ID, ranging from 0 to 499.

## Command Mode

Global Configuration Mode

## Privilege Requirement

Only Admin, Operator and Power User level users have access to these commands.

## Example

Create a MAC ACL whose ID is 23:

```
T1700X-16TS(config)# mac access-list 23
```

## 25.3 access-list standard

### Description

The **access-list standard** command is used to add Standard-IP ACL rule. To delete the corresponding rule, please use **no access-list standard** command. Standard-IP ACLs analyze and process data packets based on a series of match conditions, which can be the source IP addresses and destination IP addresses carried in the packets.

### Syntax

```
access-list standard acl-id rule rule-id { deny | permit } [[ sip source-ip ] smask  
source-ip-mask] [[ dip destination-ip ] dmask destination-ip-mask ]
```

```
no access-list standard acl-id rule rule-id
```

### Parameter

*acl-id* — The desired Standard-IP ACL for configuration.

*rule-id* — The rule ID.

deny — The operation to discard packets.

permit — The operation to forward packets. It is the default value.

*source-ip* — The source IP address contained in the rule.

*source-ip-mask* — The source IP address mask. It is required if you typed the source IP address.

*destination-ip* — The destination IP address contained in the rule.

*destination-ip-mask* — The destination IP address mask. It is required if you typed the destination IP address.

## Command Mode

Global Configuration Mode

## Privilege Requirement

Only Admin, Operator and Power User level users have access to these commands.

## Example

Create a Standard-IP ACL whose ID is 520, and add Rule 10 for it. In the rule, the source IP address is 192.168.0.100, the source IP address mask is 255.255.255.0, and the packets match this rule will be forwarded by the switch:

```
T1700X-16TS(config)# access-list create 520
T1700X-16TS(config)# access-list standard 520 rule 10 permit sip
192.168.0.100 smask 255.255.255.0
```

## 25.4 access-list extended

### Description

The **access-list extended** command is used to add Extended-IP ACL rule. To delete the corresponding rule, please use **no access-list extended** command.

### Syntax

```
access-list extended acl-id rule rule-id { deny | permit } [[ sip source-ip ]
smask source-ip-mask ] [[ dip destination-ip] dmask destination-ip-mask ]
[ s-port s-port ] [ d-port d-port ] [ protocol protocol ]
no access-list extended acl-id rule rule-id
```

### Parameter

*acl-id*——The desired Extended-IP ACL for configuration.

*rule-id* —— The rule ID.

deny —— The operation to discard packets.

permit ——The operation to forward packets. It is the default value.

*source-ip* —— The source IP address contained in the rule.

*source-ip-mask* —— The source IP address mask. It is required if you typed the source IP address.

*destination-ip* —— The destination IP address contained in the rule.

*destination-ip-mask* —— The destination IP address mask. It is required if you typed the destination IP address.

*s-port* — The source port number.

*d-port* — The destination port number.

*protocol* — Configure the value of the matching protocol.

## Command Mode

Global Configuration Mode

## Privilege Requirement

Only Admin, Operator and Power User level users have access to these commands.

## Example

Create an Extended-IP ACL whose ID is 2220, and add Rule 10 for it. In the rule, the source IP address is 192.168.0.100, the source IP address mask is 255.255.255.0, and the packets match this rule will be forwarded by the switch:

```
T1700X-16TS(config)# access-list create 2220
T1700X-16TS(config)# access-list extended 2220 rule 10 permit sip
192.168.0.100 smask 255.255.255.0
```

## 25.5 access-list ipv6

### Description

The **access-list ipv6** command is used to add IPv6 ACL rule. To delete the corresponding rule, please use **no access-list ipv6** command. Standard-IP ACLs analyze and process data packets based on a series of match conditions, which can be the source IP addresses and destination IP addresses carried in the packets, the DSCP and flow-label value, etc.

### Syntax

```
access-list ipv6 acl-id rule rule-id { deny | permit } [dscp dscp-value]
[flow-label flow-label-value] [ [sip source-ip ] sip-mask source-ip-mask] [ [dip
destination-ip ] dip-mask destination-ip-mask] [ s-port s-port] [ d-port d-port ]
no access-list ipv6 acl-id rule rule-id
```

### Parameter

*acl-id* — The desired Standard-IP ACL for configuration.

*rule-id* — The rule ID.

deny — The operation to discard packets.

permit — The operation to forward packets. It is the default value.

*dscp-value* — Specify the dscp value, ranging from 0 to 63.

*flow-label-value* — The IPv6 flow label, which ranges from 0-0xfffff.

*source-ip* — The source IP address contained in the rule.

*source-ip-mask* — The source IP address mask. It is required if you typed the source IP address.

*destination-ip* — The destination IP address contained in the rule.

*destination-ip-mask* — The destination IP address mask. It is required if you typed the destination IP address.

*s-port* — The source port number.

*d-port* — The destination port number.

## Command Mode

Global Configuration Mode

## Privilege Requirement

Only Admin, Operator and Power User level users have access to these commands.

## User Guidelines

Before binding an IPv6 ACL to a VLAN or interface, you should configure the SDM template as “enterpriseV6” and save your configurations. For more information about SDM configuration, please refer to [sdm prefer](#).

## Example

Create an IPv6 ACL whose ID is 3600, and add Rule 10 for it. In the rule, the source IP address is 3001::1, the source IP address mask is 255.255.255.0, and the packets match this rule will be forwarded by the switch:

```
T1700X-16TS(config)# access-list create 3600
T1700X-16TS(config)# access-list ipv6 3600 rule 10 permit sip 3001::1
sip-mask ffff:ffff:ff00:00ff
```

## 25.6 rule

### Description

The **rule** command is used to configure MAC ACL rule. To delete the corresponding rule, please use **no rule** command.



## Syntax

```
rule rule-id { deny | permit } [[ smac source-mac ] smask source-mac-mask ]  
[[ dmac destination-mac ] dmask destination-mac-mask ]  
  
no rule rule-id
```

## Parameter

*rule-id* — The rule ID.

deny — The operation to discard packets.

permit — The operation to forward packets. It is the default value.

*source-mac* — The source MAC address contained in the rule.

*source-mac-mask* — The source MAC address mask. It is required if you typed the source MAC address.

*destination-mac* — The destination MAC address contained in the rule.

*destination-mac-mask* — The destination MAC address mask. It is required if you typed the destination MAC address.

## Command Mode

Mac Access-list Configuration Mode

## Privilege Requirement

Only Admin, Operator and Power User level users have access to these commands.

## Example

Create a MAC ACL whose ID is 20, and add Rule 10 for it. In the rule, the source MAC address is 00:01:3F:48:16:23, the source MAC address mask is 11:11:11:11:11:00, and the packets match this rule will be forwarded by the switch:

```
T1700X-16TS(config)# mac access-list 20  
T1700X-16TS(config-mac-acl)# rule 10 permit smac 00:01:3F:48:16:23  
smask 11:11:11:11:11:00
```

# 25.7 access-list policy name

## Description

The **access-list policy name** command is used to add Policy. To delete the corresponding Policy, please use **no access-list policy name** command. A Policy is used to control the data packets those match the corresponding ACL rules.

## Syntax

**access-list policy name** *name*

**no access-list policy name** *name*

## Parameter

*name* — The Policy Name, ranging from 1 to 16 characters.

## Command Mode

Global Configuration Mode

## Privilege Requirement

Only Admin, Operator and Power User level users have access to these commands.

## Example

Add a Policy named policy1:

```
T1700X-16TS(config)# access-list policy name policy1
```

# 25.8 access-list policy action

## Description

The **access-list policy action** command is used to add ACLs for the policy. To delete the corresponding actions, please use **no access-list policy action** command.

## Syntax

**access-list policy action** *policy-name acl-id*

**no access-list policy action** *policy-name acl-id*

## Parameter

*policy-name* — The Policy Name, ranging from 1 to 16 characters.

*acl-id* — The ID of the ACL to which the above policy is applied.

## Command Mode

Global Configuration Mode

## Privilege Requirement

Only Admin, Operator and Power User level users have access to these commands.

## Example

Add ACL whose ID is 120 for policy1:

```
T1700X-16TS(config)# access-list policy action policy1 120
```

## 25.9 access-list bind acl(interface)

### Description

The **access-list bind acl** command is used to bind an ACL to the specified port. To cancel the bind relation, please use **no access-list bind acl** command.

### Syntax

```
access-list bind acl acl-id  
no access-list bind acl acl-id
```

### Parameter

*acl-id* — The ID of the ACL desired to bind.

### Command Mode

Interface Configuration Mode (interface ten-gigabitEthernet / interface range ten-gigabitEthernet)

### Privilege Requirement

Only Admin, Operator and Power User level users have access to these commands.

### Example

Bind ACL 100 to port 1/0/2:

```
T1700X-16TS(config)# interface ten-gigabitEthernet 1/0/2  
T1700X-16TS(config-if)# access-list bind acl 100
```

## 25.10 access-list bind acl(vlan)

### Description

The **access-list bind acl** command is used to bind an ACL to the specified VLAN. To cancel the bind relation, please use **no access-list bind acl** command.

### Syntax

```
access-list bind acl acl-id  
no access-list bind acl acl-id
```

### Parameter

*acl-id* — The ID of the ACL desired to bind.

### Command Mode

Interface VLAN Mode

## Privilege Requirement

Only Admin, Operator and Power User level users have access to these commands.

## Example

Bind ACL 100 to VLAN 2:

```
T1700X-16TS(config)# interface vlan 2
T1700X-16TS(config-if)# access-list bind acl 100
```

## 25.11 access-list bind(interface)

### Description

The **access-list bind** command is used to bind a policy to a specified port. To cancel the bind relation, please use **no access-list bind** command.

### Syntax

```
access-list bind policy-name
no access-list bind policy-name
```

### Parameter

*policy-name* — The name of the policy desired to bind.

### Command Mode

Interface Configuration Mode (interface ten-gigabitEthernet / interface range ten-gigabitEthernet / interface port-channel / interface range port-channel)

## Privilege Requirement

Only Admin, Operator and Power User level users have access to these commands.

## Example

Bind policy1 to port 1/0/2:

```
T1700X-16TS(config)# interface ten-gigabitEthernet 1/0/2
T1700X-16TS(config-if)# access-list bind policy1
```

## 25.12 access-list bind(vlan)

### Description

The **access-list bind** command is used to bind a policy to a VLAN. To cancel the bind relation, please use **no access-list bind** command.

## Syntax

```
access-list bind policy-name  
no access-list bind policy-name
```

## Parameter

*policy-name* — The name of the policy desired to bind.

## Command Mode

Interface VLAN Mode

## Privilege Requirement

Only Admin, Operator and Power User level users have access to these commands.

## Example

Bind policy1 to VLAN 2:

```
T1700X-16TS(config)# interface vlan 2  
T1700X-16TS(config-if)# access-list bind policy1
```

## 25.13 show access-list

### Description

The **show access-list** command is used to display configuration of ACL.

### Syntax

```
show access-list acl-id
```

### Parameter

*acl-id* — The ID of the ACL selected to display the configuration.

### Command Mode

Privileged EXEC Mode and Any Configuration Mode

### Privilege Requirement

None.

### Example

Display the configuration of the MAC ACL whose ID is 20:

```
T1700X-16TS(config)# show access-list 20
```

## 25.14 show access-list policy

### Description

The **show access-list policy** command is used to display the information of a specified policy.

### Syntax

**show access-list policy** *name*

### Parameter

*name* — The Policy Name desired to show.

### Command Mode

Privileged EXEC Mode and Any Configuration Mode

### Privilege Requirement

None.

### Example

Display the information of a policy named policy1:

```
T1700X-16TS(config)# show access-list policy policy1
```

## 25.15 show access-list bind

### Description

The **show access-list bind** command is used to display the configuration of Policy bind.

### Syntax

**show access-list bind**

### Command Mode

Privileged EXEC Mode and Any Configuration Mode

### Privilege Requirement

None.

### Example

Display the configuration of Policy bind:

```
T1700X-16TS(config)# show access-list bind
```

## Chapter 26 MSTP Commands

MSTP (Multiple Spanning Tree Protocol), compatible with both STP and RSTP and subject to IEEE 802.1s, can disbranch a ring network. STP is to block redundant links and backup links as well as optimize paths.

### 26.1 debug spanning-tree

#### Description

The **debug spanning-tree** command is used to enable debugging of spanning-tree activities. To disable the debugging function, please use **no debug spanning-tree** command.

#### Syntax

**debug spanning-tree** { all | bpdu receive | bpdu transmit | cmpmsg | errors | flush | init | migration | proposals | roles | state | tc }

**no debug spanning-tree** { all | bpdu receive | bpdu transmit | cmpmsg | errors | flush | init | migration | proposals | roles | state | tc }

#### Parameters

all — Display all the spanning-tree debug messages.

bpdu receive — Display the debug messages of the received spanning-tree bridge protocol data unit (BPDU).

bpdu transmit — Display the debug messages of the sent spanning-tree BPDU.

cmpmsg — Display the message priority debug messages.

errors — Display the MSTP error debug messages.

flush — Display the address table flushing debug messages.

init — Display the data structure initialization debug messages.

migration — Display the version migration debug messages.

proposals — Display the MSTP handshake debug messages.

roles — Display the MSTP interface role switching debug messages.

state — Display the MSTP interface state change debug messages.

tc — Display the MSTP topology event debug messages.

#### Command Mode

Privileged EXEC Mode

## Privilege Requirement

Only Admin level users have access to these commands.

## Example

Display all the spanning-tree debug messages:

```
T1700X-16TS# debug spanning-tree all
```

## 26.2 spanning-tree(global)

### Description

The **spanning-tree** command is used to enable STP function globally. To disable the STP function, please use **no spanning-tree** command.

### Syntax

```
spanning-tree
```

```
no spanning-tree
```

### Command Mode

Global Configuration Mode

### Privilege Requirement

Only Admin, Operator and Power User level users have access to these commands.

### Example

Enable the STP function:

```
T1700X-16TS(config)# spanning-tree
```

## 26.3 spanning-tree mode

### Description

The **spanning-tree mode** command is used to configure the STP mode of the switch. To return to the default configurations, please use **no spanning-tree mode** command.

### Syntax

```
spanning-tree mode { stp | rstp | mstp }
```

```
no spanning-tree mode
```

### Parameter

stp — Spanning Tree Protocol, the default value.



rstp —Rapid Spanning Tree Protocol

mstp —Multiple Spanning Tree Protocol

### Command Mode

Global Configuration Mode

### Privilege Requirement

Only Admin, Operator and Power User level users have access to these commands.

### Example

Configure the spanning-tree mode as mstp:

```
T1700X-16TS(config)# spanning-tree mode mstp
```

## 26.4 spanning-tree mst configuration

### Description

The **spanning-tree mst configuration** command is used to access MST Configuration Mode from Global Configuration Mode, as to configure the VLAN-Instance mapping, region name and revision level. To return to the default configuration of the corresponding Instance, please use **no spanning-tree mst configuration** command.

### Syntax

**spanning-tree mst configuration**

**no spanning-tree mst configuration**

### Command Mode

Global Configuration Mode

### Privilege Requirement

Only Admin, Operator and Power User level users have access to these commands.

### Example

Enter into the MST configuration mode:

```
T1700X-16TS(config)# spanning-tree mst configuration
```

```
T1700X-16TS(config-mst)#
```

## 26.5 spanning-tree mst instance

### Description

The **spanning-tree mst instance** command is used to configure the priority of MST instance. To return to the default value of MST instance priority, please use **no spanning-tree mst instance** command.

### Syntax

```
spanning-tree mst instance instance-id priority pri  
no spanning-tree mst instance instance-id priority
```

### Parameter

*instance-id* — Instance ID, ranging from 1 to 8.

*pri* — MSTI Priority, which must be multiple of 4096 ranging from 0 to 61440. By default, it is 32768. MSTI priority is an important criterion on determining if the switch will be chosen as the root bridge in the specific instance.

### Command Mode

Global Configuration Mode

### Privilege Requirement

Only Admin, Operator and Power User level users have access to these commands.

### Example

Enable the MST Instance 1 and configure its priority as 4096:

```
T1700X-16TS(config)# spanning-tree mst instance 1 priority 4096
```

## 26.6 spanning-tree priority

### Description

The **spanning-tree priority** command is used to configure the bridge priority. To return to the default value of bridge priority, please use **no spanning-tree priority** command.

### Syntax

```
spanning-tree priority pri  
no spanning-tree priority
```

### Parameter

*pri* — Bridge priority, ranging from 0 to 61440. It is 32768 by default.

## Command Mode

Global Configuration Mode

## Privilege Requirement

Only Admin, Operator and Power User level users have access to these commands.

## Example

Configure the bridge priority as 4096:

```
T1700X-16TS(config)# spanning-tree priority 4096
```

# 26.7 spanning-tree tc-defend

## Description

The **spanning-tree tc-defend** command is used to configure the TC Protect of Spanning Tree globally. To return to the default configuration, please use **no spanning-tree tc-defend** command. A switch removes MAC address entries upon receiving TC-BPDUs. If a malicious user continuously sends TC-BPDUs to a switch, the switch will be busy with removing MAC address entries, which may decrease the performance and stability of the network.

## Syntax

```
spanning-tree tc-defend threshold threshold period period
```

```
no spanning-tree tc-defend
```

## Parameter

*threshold* — TC Threshold, ranging from 1 to 100 packets. By default, it is 20. TC Threshold is the maximum number of the TC-BPDUs received by the switch in a TC Protect Cycle.

*period* — TC Protect Cycle, ranging from 1 to 10 in seconds. By default, it is 5.

## Command Mode

Global Configuration Mode

## Privilege Requirement

Only Admin, Operator and Power User level users have access to these commands.

## Example

Configure TC Threshold as 30 packets and TC Protect Cycle as 10 seconds:

```
T1700X-16TS(config)# spanning-tree tc-defend threshold 30 period 10
```

## 26.8 spanning-tree hold-count

### Description

The **spanning-tree hold-count** command is used to configure the maximum number of BPDU packets transmitted per Hello Time interval. To return to the default configurations, please use **no spanning-tree hold-count** command.

### Syntax

```
spanning-tree hold-count value  
no spanning-tree hold-count
```

### Parameter

*value* — The maximum number of BPDU packets transmitted per Hello Time interval, ranging from 1 to 20 in pps. By default, it is 5.

### Command Mode

Global Configuration Mode

### Privilege Requirement

Only Admin, Operator and Power User level users have access to these commands.

### Example

Configure the hold-count of STP as 8pps:

```
T1700X-16TS(config)# spanning-tree hold-count 8
```

## 26.9 spanning-tree timer

### Description

The **spanning-tree timer** command is used to configure forward-time, hello-time and max-age of Spanning Tree. To return to the default configurations, please use **no spanning-tree timer** command.

### Syntax

```
spanning-tree timer {[ forward-time forward-time ] [ hello-time hello-time ]  
[ max-age max-age ]}  
no spanning-tree timer
```

### Parameter

*forward-time* — Forward Delay, which is the time for the port to transit its state after the network topology is changed. Forward Delay ranges from 4 to 30 in seconds and it is 15 by default. Otherwise,  $2 * (\text{Forward Delay} - 1) \geq \text{Max Age}$ .

*hello-time* — Hello Time, which is the interval to send BPDU packets, and used to test the links. Hello Time ranges from 1 to 10 in seconds and it is 2 by default. Otherwise,  $2 * (\text{Hello Time} + 1) \leq \text{Max Age}$ .

*max-age* — The maximum time the switch can wait without receiving a BPDU before attempting to reconfigure, ranging from 6 to 40 in seconds. By default, it is 20.

### Command Mode

Global Configuration Mode

### Privilege Requirement

Only Admin, Operator and Power User level users have access to these commands.

### Example

Configure forward-time, hello-time and max-age for Spanning Tree as 16 seconds, 3 seconds and 22 seconds respectively:

```
T1700X-16TS(config)# spanning-tree timer forward-time 16 hello-time 3
max-age 22
```

## 26.10 spanning-tree max-hops

### Description

The **spanning-tree max-hops** command is used to configure the maximum number of hops that occur in a specific region before the BPDU is discarded. To return to the default configurations, please use **no spanning-tree max-hops** command.

### Syntax

**spanning-tree max-hops** *value*

**no spanning-tree max-hops**

### Parameter

*value* — The maximum number of hops that occur in a specific region before the BPDU is discarded, ranging from 1 to 40 in hop. By default, it is 20.

### Command Mode

Global Configuration Mode

### Privilege Requirement

Only Admin, Operator and Power User level users have access to these commands.

## Example

Configure the max-hops of STP as 30:

```
T1700X-16TS(config)# spanning-tree max-hops 30
```

## 26.11 instance

### Description

The **instance** command is used to configure the VLAN-Instance mapping. To remove the VLAN-instance mapping or disable the corresponding instance, please use **no instance** command. When an instance is disabled, the related mapping VLANs will be removed.

### Syntax

```
instance instance-id vlan vlan-id  
no instance instance-id [ vlan vlan-id ]
```

### Parameters

*instance-id* — Instance ID, ranging from 1 to 8.

*vlan-id* — The VLAN ID selected to mapping with the corresponding instance.

### Command Mode

MST Configuration Mode

### Privilege Requirement

Only Admin, Operator and Power User level users have access to these commands.

## Example

Map the VLANs 1-100 to Instance 1:

```
T1700X-16TS(config)# spanning-tree mst configuration
```

```
T1700X-16TS(config-mst)# instance 1 vlan 1-100
```

Disable Instance 1, namely remove all the mapping VLANs 1-100:

```
T1700X-16TS(config)# spanning-tree mst configuration
```

```
T1700X-16TS(config-mst)# no instance 1
```

Remove VLANs 1-50 in mapping VLANs 1-100 for Instance 1:

```
T1700X-16TS(config)# spanning-tree mst configuration
```

```
T1700X-16TS(config-mst)# no instance 1 vlan 1-50
```

## 26.12 name

### Description

The **name** command is used to configure the region name of MST instance.

### Syntax

**name** *name*

### Parameters

*name* — The region name, used to identify MST region. It ranges from 1 to 32 characters.

### Command Mode

MST Configuration Mode

### Privilege Requirement

Only Admin, Operator and Power User level users have access to these commands.

### Example

Configure the region name of MST as “region1”:

```
T1700X-16TS(config)# spanning-tree mst configuration
T1700X-16TS(config-mst)# name region1
```

## 26.13 revision

### Description

The **revision** command is used to configure the revision level of MST instance.

### Syntax

**revision** *revision*

### Parameters

*revision* — The revision level for MST region identification, ranging from 0 to 65535.

### Command Mode

MST Configuration Mode

### Privilege Requirement

Only Admin, Operator and Power User level users have access to these commands.

### Example

Configure the revision level of MST as 100:

```
T1700X-16TS(config)# spanning-tree mst configuration
T1700X-16TS(config-mst)# revision 100
```

## 26.14 spanning-tree(interface)

### Description

The **spanning-tree** command is used to enable STP function for a port. To disable the STP function, please use **no spanning-tree** command.

### Syntax

```
spanning-tree
no spanning-tree
```

### Command Mode

Interface Configuration Mode (interface ten-gigabitEthernet / interface range ten-gigabitEthernet / interface port-channel / interface range port-channel)

### Privilege Requirement

Only Admin, Operator and Power User level users have access to these commands.

### Example

Enable the STP function for port 1/0/2:

```
T1700X-16TS(config)# interface ten-gigabitEthernet 1/0/2
T1700X-16TS(config-if)# spanning-tree
```

## 26.15 spanning-tree common-config

### Description

The **spanning-tree common-config** command is used to configure the parameters of the ports for comparison in the CIST and the common parameters of all instances. To return to the default configuration, please use **no spanning-tree common-config** command. CIST (Common and Internal Spanning Tree) is the spanning tree in a switched network, connecting all devices in the network.

### Syntax

```
spanning-tree common-config [ port-priority pri ] [ ext-cost ext-cost ]
[ int-cost int-cost ] [ portfast { enable | disable } ] [ point-to-point { auto | open |
close } ]
no spanning-tree common-config
```



## Parameter

*pri* — Port Priority, which must be multiple of 16 ranging from 0 to 240. By default, the port priority is 128. Port Priority is an important criterion on determining if the port connected to this port will be chosen as the root port. In the same condition, the port with the highest priority will be chosen as the root port. The lower value has the higher priority.

*ext-cost* — External Path Cost, which is used to choose the path and calculate the path costs of ports in different MST regions. It is an important criterion on determining the root port. The lower value has the higher priority. It ranges from 0 to 2000000. By default, it is 0 which is mean auto.

*int-cost* — Internal Path Cost, which is used to choose the path and calculate the path costs of ports in an MST region. It is an important criterion on determining the root port. The lower value has the higher priority. By default, it is automatic. It ranges from 0 to 2000000. By default, it is 0 which is mean auto.

*portfast* — Enable/ Disable Edge Port. By default, it is disabled. The edge port can transit its state from blocking to forwarding rapidly without waiting for forward delay.

*point-to-point* — The P2P link status, with auto, open and close options. By default, the option is auto. If the two ports in the P2P link are root port or designated port, they can transit their states to forwarding rapidly to reduce the unnecessary forward delay.

## Command Mode

Interface Configuration Mode (interface ten-gigabitEthernet / interface range ten-gigabitEthernet / interface port-channel / interface range port-channel)

## Privilege Requirement

Only Admin, Operator and Power User level users have access to these commands.

## Example

Enable the STP function of port 1, and configure the Port Priority as 64, ExtPath Cost as 100, IntPath Cost as 100, and then enable Edge Port:

```
T1700X-16TS(config)# interface ten-gigabitEthernet 1/0/1
T1700X-16TS(config-if)# spanning-tree common-config port-priority 64
ext-cost 100 int-cost 100 portfast enable point-to-point open
```

## 26.16 spanning-tree mst

### Description

The **spanning-tree mst** command is used to configure MST Instance Port. To return to the default configuration of the corresponding Instance Port, please use **no spanning-tree mst** command. A port can play different roles in different spanning tree instance. You can use this command to configure the parameters of the ports in different instance IDs as well as view status of the ports in the specified instance.

### Syntax

```
spanning-tree mst instance instance-id {[ port-priority pri ] | [ cost cost ]}
```

```
no spanning-tree mst instance instance-id
```

### Parameter

*instance-id* — Instance ID, ranging from 1 to 8.

*pri* — Port Priority, which must be multiple of 16 ranging from 0 to 240. By default, it is 128. Port Priority is an important criterion on determining if the port will be chosen as the root port by the device connected to this port.

*cost* — Path Cost, ranging from 0 to 200000. The lower value has the higher priority. Its default value is 0 meaning “auto”.

### Command Mode

Interface Configuration Mode (interface ten-gigabitEthernet / interface range ten-gigabitEthernet / interface port-channel / interface range port-channel)

### Privilege Requirement

Only Admin, Operator and Power User level users have access to these commands.

### Example

Configure the priority of port 1 in MST Instance 1 as 64, and path cost as 2000:

```
T1700X-16TS(config)# interface ten-gigabitEthernet 1/0/1
T1700X-16TS(config-if)# spanning-tree mst instance 1 port-priority 64 cost
2000
```

## 26.17 spanning-tree bpdudfilter

### Description

The **spanning-tree bpdudfilter** command is used to enable the BPDU filter function for a port. With the function enabled, the port can be prevented from

receiving and sending any BPDU packets. To disable the BPDU filter function, please use **no spanning-tree bpdudfilter** command.

### Syntax

**spanning-tree bpdudfilter**

**no spanning-tree bpdudfilter**

### Command Mode

Interface Configuration Mode (interface ten-gigabitEthernet / interface range ten-gigabitEthernet / interface port-channel / interface range port-channel)

### Privilege Requirement

Only Admin, Operator and Power User level users have access to these commands.

### Example

Enable the BPDU filter function for port 1/0/2:

```
T1700X-16TS(config)# interface ten-gigabitEthernet 1/0/2
```

```
T1700X-16TS(config-if)# spanning-tree bpdudfilter
```

## 26.18 spanning-tree bpduguard

### Description

The **spanning-tree bpduguard** command is used to enable the BPDU protect function for a port. With the BPDU protect function enabled, the port will set itself automatically as ERROR-PORT when it receives BPDU packets, and the port will disable the forwarding function for a while. To disable the BPDU protect function, please use **no spanning-tree bpduguard** command.

### Syntax

**spanning-tree bpduguard**

**no spanning-tree bpduguard**

### Command Mode

Interface Configuration Mode (interface ten-gigabitEthernet / interface range ten-gigabitEthernet / interface port-channel / interface range port-channel)

### Privilege Requirement

Only Admin, Operator and Power User level users have access to these commands.

## Example

Enable the BPDU protect function for port 1/0/2:

```
T1700X-16TS(config)# interface ten-gigabitEthernet 1/0/2
T1700X-16TS(config-if)# spanning-tree bpduguard
```

## 26.19 spanning-tree guard loop

### Description

The **spanning-tree guard loop** command is used to enable the Loop Protect function for a port. Loop Protect is to prevent the loops in the network brought by recalculating STP because of link failures and network congestions. To disable the Loop Protect function, please use **no spanning-tree guard loop** command.

### Syntax

**spanning-tree guard loop**

**no spanning-tree guard loop**

### Command Mode

Interface Configuration Mode (interface ten-gigabitEthernet / interface range ten-gigabitEthernet / interface port-channel / interface range port-channel)

### Privilege Requirement

Only Admin, Operator and Power User level users have access to these commands.

### Example

Enable the Loop Protect function for port 2:

```
T1700X-16TS(config)# interface ten-gigabitEthernet 1/0/2
T1700X-16TS(config-if)# spanning-tree guard loop
```

## 26.20 spanning-tree guard root

### Description

The **spanning-tree guard root** command is used to enable the Root Protect function for a port. With the Root Protect function enabled, the root bridge will set itself automatically as ERROR-PORT when receiving BPDU packets with higher priority, in order to maintain the role of root ridge. To disable the Root Protect function, please use **no spanning-tree guard root** command.

## Syntax

**spanning-tree guard root**

**no spanning-tree guard root**

## Command Mode

Interface Configuration Mode (interface ten-gigabitEthernet / interface range ten-gigabitEthernet / interface port-channel / interface range port-channel)

## Privilege Requirement

Only Admin, Operator and Power User level users have access to these commands.

## Example

Enable the Root Protect function for port 2:

```
T1700X-16TS(config)# interface ten-gigabitEthernet 1/0/2
```

```
T1700X-16TS(config-if)# spanning-tree guard root
```

# 26.21 spanning-tree guard tc

## Description

The **spanning-tree guard tc** command is used to enable the TC Protect of Spanning Tree function for a port. To disable the TC Protect of Spanning Tree function, please use **no spanning-tree guard tc** command. A switch removes MAC address entries upon receiving TC-BPDUs. If a malicious user continuously sends TC-BPDUs to a switch, the switch will be busy with removing MAC address entries, which may decrease the performance and stability of the network. With the Protect of Spanning Tree function enabled, you can configure the number of TC-BPDUs in a required time, so as to avoid the process of removing MAC addresses frequently.

## Syntax

**spanning-tree guard tc**

**no spanning-tree guard tc**

## Command Mode

Interface Configuration Mode (interface ten-gigabitEthernet / interface range ten-gigabitEthernet / interface port-channel / interface range port-channel)

## Privilege Requirement

Only Admin, Operator and Power User level users have access to these commands.

## Example

Enable the TC Protect of Spanning Tree for port 2:

```
T1700X-16TS(config)# interface ten-gigabitEthernet 1/0/2
T1700X-16TS(config-if)# spanning-tree guard tc
```

## 26.22 spanning-tree mcheck

### Description

The **spanning-tree mcheck** command is used to enable mcheck.

### Syntax

```
spanning-tree mcheck
```

### Command Mode

Interface Configuration Mode (interface ten-gigabitEthernet / interface range ten-gigabitEthernet / interface port-channel / interface range port-channel)

### Privilege Requirement

Only Admin, Operator and Power User level users have access to these commands.

### Example

Enable mcheck for port 2:

```
T1700X-16TS(config)# interface ten-gigabitEthernet 1/0/2
T1700X-16TS(config-if)# spanning-tree mcheck
```

## 26.23 show spanning-tree active

### Description

The **show spanning-tree active** command is used to display the active information of spanning-tree.

### Syntax

```
show spanning-tree active
```

### Command Mode

Privileged EXEC Mode and Any Configuration Mode

### Privilege Requirement

None.

## Example

Display the active information of spanning-tree:

```
T1700X-16TS(config)# show spanning-tree active
```

## 26.24 show spanning-tree bridge

### Description

The **show spanning-tree bridge** command is used to display the bridge parameters.

### Syntax

```
show spanning-tree bridge [ forward-time | hello-time | hold-count | max-age |  
max-hops | mode | priority | state ]
```

### Command Mode

Privileged EXEC Mode and Any Configuration Mode

### Privilege Requirement

None.

### Example

Display the bridge parameters:

```
T1700X-16TS(config)# show spanning-tree bridge
```

## 26.25 show spanning-tree interface

### Description

The **show spanning-tree interface** command is used to display the spanning-tree information of all ports or a specified port.

### Syntax

```
show spanning-tree interface [ ten-gigabitEthernet port | port-channel lagid ]  
[ edge | ext-cost | int-cost | mode | p2p | priority | role | state | status ]
```

### Parameter

*port* — The Ethernet port number.

*lagid* — The ID of the LAG.

### Command Mode

Privileged EXEC Mode and Any Configuration Mode

## Privilege Requirement

None.

## Example

Display the spanning-tree information of all ports:

```
T1700X-16TS(config)# show spanning-tree interface
```

Display the spanning-tree information of port 1/0/2:

```
T1700X-16TS(config)# show spanning-tree interface ten-gigabitEthernet
```

```
1/0/2
```

Display the spanning-tree mode information of port 1/0/2:

```
T1700X-16TS(config)# show spanning-tree interface ten-gigabitEthernet
```

```
1/0/2 mode
```

## 26.26 show spanning-tree interface-security

### Description

The **show spanning-tree interface-security** command is used to display the protect information of all ports or a specified port.

### Syntax

```
show spanning-tree interface-security [ ten-gigabitEthernet port | port-channel lagid ] [ bpdufilter | bpduguard | loop | root | tc | tc-defend ]
```

### Parameter

*port* — The Ethernet port number.

*lagid* — The ID of the LAG.

### Command Mode

Privileged EXEC Mode and Any Configuration Mode

## Privilege Requirement

None.

## Example

Display the protect information of all ports:

```
T1700X-16TS(config)# show spanning-tree interface-security
```

Display the protect information of port 1:



```
T1700X-16TS(config)# show spanning-tree interface-security
ten-gigabitEthernet 1/0/1
```

Display the interface security bpdudfilter information:

```
T1700X-16TS(config)# show spanning-tree interface-security bpdudfilter
```

## 26.27 show spanning-tree mst

### Description

The **show spanning-tree mst** command is used to display the related information of MST Instance.

### Syntax

```
show spanning-tree mst { configuration [ digest ] | instance instance-id
[ interface [ ten-gigabitEthernet port | port-channel lagid ] ] }
```

### Parameter

*instance-id* — Instance ID desired to show, ranging from 1 to 8.

*port* — The Ethernet port number.

*lagid* — The ID of the LAG.

### Command Mode

Privileged EXEC Mode and Any Configuration Mode

### Privilege Requirement

None.

### Example

Display the region information and mapping information of VLAN and MST Instance:

```
T1700X-16TS(config)#show spanning-tree mst configuration
```

Display the related information of MST Instance 1:

```
T1700X-16TS(config)#show spanning-tree mst instance 1
```

Display all the ports information of MST Instance 1:

```
T1700X-16TS(config)#show spanning-tree mst instance 1 interface
```

# Chapter 27 IGMP Snooping Commands

IGMP Snooping (Internet Group Management Protocol Snooping) is a multicast control mechanism running on Layer 2 switch. It can effectively prevent multicast groups being broadcasted in the network.

## 27.1 ip igmp snooping(global)

### Description

The **ip igmp snooping** command is used to configure IGMP Snooping globally. To disable the IGMP Snooping function, please use **no ip igmp snooping** command.

### Syntax

**ip igmp snooping**  
**no ip igmp snooping**

### Command Mode

Global Configuration Mode

### Privilege Requirement

Only Admin, Operator and Power User level users have access to these commands.

### Example

Enable IGMP Snooping function:

```
T1700X-16TS(config)# ip igmp snooping
```

## 27.2 ip igmp snooping(interface)

### Description

The **ip igmp snooping** command is used to enable the IGMP Snooping function for the desired port. To disable the IGMP Snooping function, please use **no ip igmp snooping** command.

### Syntax

**ip igmp snooping**  
**no ip igmp snooping**

## Command Mode

Interface Configuration Mode (interface ten-gigabitEthernet / interface range ten-gigabitEthernet / interface port-channel / interface range port-channel)

## Privilege Requirement

Only Admin, Operator and Power User level users have access to these commands.

## Example

Enable IGMP Snooping function of port 1/0/3:

```
T1700X-16TS(config)# interface ten-gigabitEthernet 1/0/3
T1700X-16TS(config-if)# ip igmp snooping
```

## 27.3 ip igmp snooping rtime

### Description

The **ip igmp snooping rtime** command is used to specify router port aging time globally. To restore the default timer, please use **no ip igmp snooping rtime** command.

### Syntax

```
ip igmp snooping rtime rtime
no ip igmp snooping rtime
```

### Parameter

*rtime* — Specify the aging time in seconds, ranging from 60 to 600. The default aging time is 300 seconds.

### Command Mode

Global Configuration Mode

### Privilege Requirement

Only Admin, Operator and Power User level users have access to these commands.

### Example

Specify IGMP Snooping router port aging time as 100 seconds globally:

```
T1700X-16TS(config)# ip igmp snooping rtime 100
```

## 27.4 ip igmp snooping mtime

### Description

The **ip igmp snooping mtime** command is used to specify member port aging time globally. The default aging time is 260 seconds. To restore the default timer, please use **no ip igmp snooping mtime** command.

### Syntax

```
ip igmp snooping mtime mtime  
no ip igmp snooping mtime
```

### Parameter

*mtime* — Specify the aging time in seconds, ranging from 60 to 600. The default aging time is 260 seconds.

### Command Mode

Global Configuration Mode

### Privilege Requirement

Only Admin, Operator and Power User level users have access to these commands.

### Example

Specify IGMP Snooping member port aging time as 100 seconds globally:

```
T1700X-16TS(config)# ip igmp snooping mtime 100
```

## 27.5 ip igmp snooping report-suppression

### Description

The **ip igmp snooping report-suppression** command is used enable the IGMP report suppression function. When it is enabled, the switch forwards only the first IGMP report message per multicast group to the Layer 3 device, and the subsequent IGMP reports from the same multicast group are discarded. To disable the IGMP report suppression function and forward all the IGMP reports to the Layer 3 device, please use **no ip igmp snooping report-suppression** command. This function is disabled by default.

### Syntax

```
ip igmp snooping report-suppression  
no ip igmp snooping report-suppression
```

### Command Mode

Global Configuration Mode

## Privilege Requirement

Only Admin, Operator and Power User level users have access to these commands.

## Example

Enable the IGMP report suppression function:

```
T1700X-16TS(config)# ip igmp snooping report-suppression
```

## 27.6 ip igmp snooping immediate-leave

### Description

The **ip igmp snooping immediate-leave** command is used to configure the Fast Leave function for port. To disable the Fast Leave function, please use **no ip igmp snooping immediate-leave** command.

### Syntax

**ip igmp snooping immediate-leave**

**no ip igmp snooping immediate-leave**

### Command Mode

Interface Configuration Mode (interface ten-gigabitEthernet / interface range ten-gigabitEthernet / interface port-channel / interface range port-channel)

## Privilege Requirement

Only Admin, Operator and Power User level users have access to these commands.

## Example

Enable the Fast Leave function for port 1/0/3:

```
T1700X-16TS(config)# interface ten-gigabitEthernet 1/0/3
```

```
T1700X-16TS(config-if)# ip igmp snooping immediate-leave
```

## 27.7 ip igmp snooping drop-unknown

### Description

The **ip igmp snooping drop-unknown** command is used to process the unknown multicast as discard. To disable the operation of processing the unknown multicast as discard, please use **no ip igmp snooping drop-unknown** command.

## Syntax

**ip igmp snooping drop-unknown**

**no ip igmp snooping drop-unknown**

## Command Mode

Global Configuration Mode

## Privilege Requirement

Only Admin, Operator and Power User level users have access to these commands.

## Example

Specify the operation to process unknown multicast as discard:

```
T1700X-16TS(config)# ip igmp snooping drop-unknown
```

# 27.8 ip igmp snooping last-listener query-inteval

## Description

The **ip igmp snooping last-listener query-inteval** command is used to specify the interval to send Specific Query Message. The default value is 1 second. To restore the default interval, please use **no ip igmp snooping last-listener query-inteval** command.

## Syntax

**ip igmp snooping last-listener query-inteval** *interval*

**no ip igmp snooping last-listener query-inteval**

## Parameter

*interval* — Specify the interval to send Specific Query Message in seconds, ranging from 1 to 5.

## Command Mode

Global Configuration Mode

## Privilege Requirement

Only Admin, Operator and Power User level users have access to these commands.

## Example

Specify the interval of Specific Query Message to 3 seconds:

```
T1700X-16TS(config)# ip igmp snooping last-listener query-inteval 3
```

## 27.9 ip igmp snooping last-listener query-count

### Description

The **ip igmp snooping last-listener query-count** command is used to specify the numbers of Specific Query Message to be sent. The default value is 2. To restore the default number, please use **no ip igmp snooping last-listener query-count** command.

### Syntax

```
ip igmp snooping last-listener query-count num  
no ip igmp snooping last-listener query-count
```

### Parameter

*num* — Specify the numbers of Specific Query Message to be sent, ranging from 1 to 5.

### Command Mode

Global Configuration Mode

### Privilege Requirement

Only Admin, Operator and Power User level users have access to these commands.

### Example

Specify the number of Specific Query Message to 3:

```
T1700X-16TS(config)# ip igmp snooping last-listener query-count 3
```

## 27.10 ip igmp snooping vlan-config

### Description

The **ip igmp snooping vlan-config** command is used to enable VLAN IGMP Snooping function or to modify IGMP Snooping parameters, and to create static multicast IP entry. To disable the VLAN IGMP Snooping function, please use **no ip igmp snooping vlan-config** command. To restore the default values, please use **no ip igmp snooping vlan-config** with specified parameters.

### Syntax

```
ip igmp snooping vlan-config vlan-id-list [ rtime router-time | mtime member-time | rport interface { ten-gigabitEthernet port-list | port-channel lagid } ]  
ip igmp snooping vlan-config vlan-id-list static ip interface { ten-gigabitEthernet port-list | port-channel lagid }
```

```
no ip igmp snooping vlan-config vlan-id-list [ rtime router-time | mtime
member-time | rport interface { ten-gigabitEthernet port-list | port-channel
lagid } ]
```

```
no ip igmp snooping vlan-config vlan-id-list static ip interface
{ ten-gigabitEthernet port-list | port-channel lagid }
```

## Parameter

*vlan-id-list* — The ID list of the VLAN desired to modify configuration, ranging from 1 to 4094, in the format of 1-3, 5.

*router-time* — Router Port Time. Within this time, if the switch does not receive IGMP query message from the router port, it will consider this port is not a router port any more. Router Port Time ranges from 60 to 600 in seconds. By default, it is 0 and the global router-time will be used.

*member-time* — Member Port Time. Within this time, if the switch does not receive IGMP report message from the member port, it will consider this port is not a member port any more. Member Port Time ranges from 60 to 600 in seconds. By default, it is 0 and the global member-time will be used.

*port-list* — The list of Ethernet ports.

*lagid* — The ID of the LAGs.

*ip* — The static multicast IP address.

## Command Mode

Global Configuration Mode

## Privilege Requirement

Only Admin, Operator and Power User level users have access to these commands.

## Example

Enable the IGMP Snooping function and modify Router Port Time as 300 seconds, Member Port Time as 200 seconds for VLAN 1-3, and set the router port as 1/0/1 for VLAN 1-2:

```
T1700X-16TS(config)# ip igmp snooping vlan-config 1-3 rtime 300
T1700X-16TS(config)# ip igmp snooping vlan-config 1-3 mtime 200
T1700X-16TS(config)# ip igmp snooping vlan-config 1-2 rport interface
ten-gigabitEthernet 1/0/1
```

Add static multicast IP address 225.0.0.1, which corresponds to VLAN 2, and configure the forward ports as ports 1/0/1-3:



```
T1700X-16TS(config)# ip igmp snooping vlan-config 2 static 225.0.0.1
interface ten-gigabitEthernet 1/0/1-3
```

## 27.11 ip igmp snooping vlan-config (router-ports-forbidden)

### Description

This command is used to forbid the specified ports as being router ports in the specified VLAN(s). To delete the forbidden router ports, please use **no ip igmp snooping vlan-config *vlan-id-list* router-ports-forbidden** command.

### Syntax

```
ip igmp snooping vlan-config vlan-id-list router-ports-forbidden interface
{ ten-gigabitEthernet port-list | port-channel port-channel-id }
no ip igmp snooping vlan-config vlan-id-list router-ports-forbidden
interface [ ten-gigabitEthernet port-list | port-channel port-channel-id ]
```

### Parameter

*vlan-id-list* — The ID list of the VLAN desired to modify configuration, ranging from 1 to 4094, in the format of 1-3, 5.

*port-list* — Forbid the specified ports as being router ports. Packets sent from multicast routers to these ports will be discarded.

*port-channel-id* — Forbid the specified port-channels as being router ports. Packets sent from multicast routers to these port-channels will be discarded.

### Command Mode

Global Configuration Mode

### Privilege Requirement

Only Admin, Operator and Power User level users have access to these commands.

### Example

Forbid the Ethernet ports 1/0/1-3 as being router ports in VLAN 1 :

```
T1700X-16TS(config)# ip igmp snooping vlan-config 1
router-ports-forbidden interface ten-gigabitEthernet 1/0/1-3
```

## 27.12 ip igmp snooping multi-vlan-config

### Description

The **ip igmp snooping multi-vlan-config** command is used to create Multicast VLAN. To delete the corresponding Multicast VLAN, please use **no ip igmp snooping multi-vlan-config** command. To restore the default values, please use **no ip igmp snooping multi-vlan-config** with specified parameters.

### Syntax

```
ip igmp snooping multi-vlan-config [ vlan-id ] [ rtime router-time | mtime member-time | rport interface { ten-gigabitEthernet port-list | port-channel lagid } ]
```

```
no ip igmp snooping multi-vlan-config [ rtime router-time | mtime member-time | rport interface { ten-gigabitEthernet port-list | port-channel lagid } ]
```

### Parameter

*vlan-id* — The ID of the multicast VLAN desired to create or modify, ranging from 2 to 4094. If not specified, the default multicast VLAN will be selected.

*router-time* — Router Port Time. Within this time, if the switch does not receive IGMP query message from the router port, it will consider this port is not a router port any more. Router Port Time ranges from 60 to 600 in seconds. By default, it is 0 and the global router-time will be used.

*member-time* — Member Port Time. Within this time, if the switch does not receive IGMP report message from the member port, it will consider this port is not a member port any more. Member Port Time ranges from 60 to 600 in seconds. By default, it is 0 and the global member-time will be used.

*port-list* — The list of Ethernet ports.

*lagid* — The ID of the LAGs.

### Command Mode

Global Configuration Mode

### Privilege Requirement

Only Admin level users have access to these commands.

### Example

Enable Multicast VLAN 3, and configure Router Port Time as 100 seconds, Member Port Time 100 seconds, and Static Router Port port 1/0/3:

```
T1700X-16TS(config)# ip igmp snooping multi-vlan-config 3 rtime 100
```

```
T1700X-16TS(config)# ip igmp snooping multi-vlan-config 3 mtime 100
T1700X-16TS(config)# ip igmp snooping multi-vlan-config 3 rport interface
ten-gigabitEthernet 1/0/3
```

## 27.13 ip igmp snooping multi-vlan-config (router-ports-forbidden)

### Description

This command is used to forbid the specified ports as being router ports in the specified multicast VLAN. To delete the forbidden router ports, please use **no ip igmp snooping multi-vlan-config router-ports-forbidden** command.

### Syntax

```
ip igmp snooping multi-vlan-config [ vlan-id ] router-ports-forbidden
interface { ten-gigabitEthernet port-list | port-channel port-channel-id }
no ip igmp snooping multi-vlan-config router-ports-forbidden [ interface
{ ten-gigabitEthernet port-list | port-channel port-channel-id } ]
```

### Parameter

*vlan-id*—— The ID of the multicast VLAN, ranging from 2 to 4094.

*port-list* —— Forbid the specified ports as being router ports. Packets sent from multicast routers to these ports will be discarded.

*port-channel-id* —— Forbid the specified port-channels as being router ports. Packets sent from multicast routers to these port-channels will be discarded.

### Command Mode

Global Configuration Mode

### Privilege Requirement

Only Admin level users have access to these commands.

### Example

Forbid the Ethernet ports 1/0/1-3 as being router ports in multicast VLAN 2 :

```
T1700X-16TS(config)# ip igmp snooping multi-vlan-config 2
router-ports-forbidden interface ten-gigabitEthernet 1/0/1-3
```

## 27.14 ip igmp snooping multi-vlan-config (source-ip-replace)

### Description

This command is used to replace the multicast source IP address of the IGMP packets in the specified multicast VLAN. To delete the forbidden router ports, please use **no ip igmp snooping multi-vlan-config replace-sourceip** command.

### Syntax

```
ip igmp snooping multi-vlan-config [ vlan-id ] replace-sourceip ip  
no ip igmp snooping multi-vlan-config replace-sourceip
```

### Parameter

*vlan-id*——The ID of the multicast VLAN, ranging from 2 to 4094.

*ip* —— Specify the IP address. The switch will use this IP address to replace the source IP address of the IGMP packets.

### Command Mode

Global Configuration Mode

### Privilege Requirement

Only Admin level users have access to these commands.

### Example

Replace the source IP address of the IGMP packets in multicast VLAN 2 as 192.168.0.112:

```
T1700X-16TS(config)# ip igmp snooping multi-vlan-config 2  
replace-sourceip 192.168.0.112
```

## 27.15 ip igmp snooping querier vlan

### Description

The **ip igmp snooping querier vlan** command is used to enable the IGMP Snooping Querier function of the VLAN(s). To disable the IGMP Snooping Querier function of certain VLANs, please use **no ip igmp snooping querier vlan** command.

### Syntax

```
ip igmp snooping querier vlan vlan-id
```

**no ip igmp snooping querier vlan *vlan-id***

### Parameter

*vlan-id* — VLAN ID, ranging from 1 to 4094.

### Command Mode

Global Configuration Mode

### Privilege Requirement

Only Admin, Operator and Power User level users have access to these commands.

### Example

Enable the IGMP Snooping Querier function of VLAN 1:

```
T1700X-16TS(config)#ip igmp snooping querier vlan 1
```

## 27.16 ip igmp snooping querier vlan (general query)

### Description

The **ip igmp snooping querier vlan** command is used to configure the parameters for IGMP Snooping Querier to send a general query frame. To return to the default configuration, please use **no ip igmp snooping querier vlan** command.

### Syntax

```
ip igmp snooping querier vlan vlan-id { query-interval interval |  
max-response-time response-time | general-query source-ip ip-addr }
```

```
no ip igmp snooping querier vlan vlan-id { query-interval |  
max-response-time | general-query source-ip }
```

### Parameter

*vlan-id* — VLAN ID, ranging from 1 to 4094.

*interval* — The time interval to send a general query frame by IGMP Snooping Querier, ranging from 10 to 300 (Seconds). By default, it is 60 seconds.

*response-time* — The maximal time for the host to respond to a general query frame, ranging from 1 to 25 (Seconds). By default, it is 10 Seconds.

*ip-addr* — The source IP of the general query frame sent by IGMP Snooping Querier. It should not be a multicast IP or a broadcast IP. By default, it is 192.168.0.1.

## Command Mode

Global Configuration Mode

## Privilege Requirement

Only Admin, Operator and Power User level users have access to these commands.

## Example

For VLAN 2, specify its query-interval as 200 seconds, and the response-time as 20 seconds:

```
T1700X-16TS(config)#ip igmp snooping querier vlan 2 query-interval 200
T1700X-16TS(config)#ip igmp snooping querier vlan 2 max-response-time
20
```

## 27.17 ip igmp snooping max-groups

### Description

The **ip igmp snooping max-groups** command is used to configure the maximum number of groups that a port can join in. The **ip igmp snooping max-groups action** is used to configure the action that the port takes when it receives an IGMP report message and the maximum number of entries is in the forwarding table. To remove the maximum group limitation and return to the default of no limitation on the specified port, please use the **no ip igmp snooping max-groups** command. To return to the default action of dropping the report, please use the **no ip igmp snooping max-groups action** command. These commands only apply to the dynamic multicast groups.

### Syntax

```
ip igmp snooping max-groups [ maxgroup ]
ip igmp snooping max-groups action { drop | replace }
no ip igmp snooping max-groups
no ip igmp snooping max-groups action
```

### Parameter

*maxgroup* — Specify the maximum numbers of groups that the port can join. It ranges from 0 to 1000 and the default value is 1000.

drop — When the number of the dynamic multicast groups that a port joins has exceeded the max-group, the port will not join any new multicast group.

replace — When the number of the dynamic multicast groups that a port joins has exceeded the max-group, the newly joined multicast group will replace an existing multicast group with the lowest multicast group address.

### Command Mode

Interface Configuration Mode (interface ten-gigabitEthernet / interface range ten-gigabitEthernet / interface port-channel / interface range port-channel)

### Privilege Requirement

Only Admin, Operator and Power User level users have access to these commands.

### Example

Specify the maximum numbers of groups that ports 1/0/2-5 can join as 10, and configure the throttling action as replace:

```
T1700X-16TS(config)#interface range gigabitEthernet 1/0/2-5
T1700X-16TS(config-if-range)#ip igmp snooping max-groups 10
T1700X-16TS(config-if-range)#ip igmp snooping max-groups action
replace
```

## 27.18 ip igmp snooping authentication

### Description

The **ip igmp snooping authenticaiton** command is used to authenticate the users who want to join the limited multicast source. To disable the multicast authentication, please use **no ip igmp snooping authentication** command.

### Syntax

```
ip igmp snooping authentication
no ip igmp snooping authentication
```

### Command Mode

Interface Configuration Mode (interface ten-gigabitEthernet / interface range ten-gigabitEthernet / interface port-channel / interface range port-channel)

### Privilege Requirement

Only Admin, Operator and Power User level users have access to these commands.

## User Guidelines

The IGMP Authentication feature will take effect only when AAA function is enabled and the RADIUS server is configured. For how to enable AAA function and configure RADIUS server, please refer to [aaa enable](#) and [radius-server host](#).

## Example

Enable IGMP authentication on port 1/0/3:

```
T1700X-16TS(config)# interface ten-gigabitEthernet 1/0/3
T1700X-16TS(config-if)# ip igmp snooping authentication
```

## 27.19 ip igmp snooping accounting

### Description

The **ip igmp snooping accounting** command is used to enable IGMP accounting globally. To disable the IGMP accounting, please use **no ip igmp snooping accounting** command.

### Syntax

```
ip igmp snooping accounting
no ip igmp snooping accounting
```

### Command Mode

Global Configuration Mode

### Privilege Requirement

Only Admin, Operator and Power User level users have access to these commands.

### Example

Enable IGMP accounting globally:

```
T1700X-16TS(config)# ip igmp snooping accounting
```

## 27.20 ip igmp profile

### Description

The **ip igmp profile** command is used to create the configuration profile. To delete the corresponding profile, please use **no ip igmp profile** command.



## Syntax

**ip igmp profile *id***

**no ip igmp profile *id***

## Parameter

*id* — Specify the id of the configuration profile, ranging from 1 to 999.

## Command Mode

Global Configuration Mode

## Privilege Requirement

Only Admin, Operator and Power User level users have access to these commands.

## Example

Create the profile 1:

```
T1700X-16TS(config)# ip igmp profile 1
```

## 27.21 deny

### Description

The **deny** command is used to configure the filtering mode of profile as deny.

### Syntax

**deny**

### Command Mode

Profile Configuration Mode

### Privilege Requirement

Only Admin, Operator and Power User level users have access to these commands.

### Example

Configure the filtering mode of profile 1 as deny:

```
T1700X-16TS(config)# ip igmp profile 1  
T1700X-16TS(config-igmp-profile)#deny
```

## 27.22 permit

### Description

The **permit** command is used to configure the filtering mode of profile as permit.

### Syntax

**permit**

### Command Mode

Profile Configuration Mode

### Privilege Requirement

Only Admin, Operator and Power User level users have access to these commands.

### Example

Configure the filtering mode of profile 1 as permit:

```
T1700X-16TS(config)# ip igmp profile 1
T1700X-16TS(config-igmp-profile)#permit
```

## 27.23 range

### Description

The **range** command is used to configure the range of the profile's filtering multicast address. To delete the corresponding filtering multicast address, please use **no range** command. A profile contains 16 filtering IP-range entries at most.

### Syntax

**range** *start-ip end-ip*

**no range** *start-ip end-ip*

### Parameter

*start-ip* — The start filtering multicast IP address.

*end-ip* — The end filtering multicast IP address.

### Command Mode

Profile Configuration Mode

## Privilege Requirement

Only Admin, Operator and Power User level users have access to these commands.

## Example

Configure one of the filter multicast address entry as range 225.1.1.1 to 226.3.2.1 in profile 1:

```
T1700X-16TS(config)# ip igmp profile 1
T1700X-16TS(config-igmp-profile)#range 225.1.1.1 226.3.2.1
```

## 27.24 ip igmp filter

### Description

The **ip igmp filter** command is used to bind the specified profile to the interface. To delete the binding, please use **no ip igmp filter** command.

### Syntax

```
ip igmp filter profile-id
no ip igmp filter
```

### Parameter

*profile-id* — Specify the profile ID, ranging from 1 to 999.

### Command Mode

Interface Configuration Mode (interface ten-gigabitEthernet / interface range ten-gigabitEthernet / interface port-channel / interface range port-channel)

## Privilege Requirement

Only Admin, Operator and Power User level users have access to these commands.

## Example

Bind profile 1 to interface ten-gigabitEthernet 1/0/2:

```
T1700X-16TS(config)# interface ten-gigabitEthernet 1/0/2
T1700X-16TS(config-if)# ip igmp filter 1
```

## 27.25 clear ip igmp snooping statistics

### Description

The **clear ip igmp snooping statistics** command is used to clear the statistics of the IGMP packets.

### Syntax

**clear ip igmp snooping statistics**

### Command Mode

Privileged EXEC Mode and Any Configuration Mode

### Privilege Requirement

Only Admin, Operator and Power User level users have access to these commands.

### Example

Clear the statistics of the IGMP packets:

```
T1700X-16TS(config)# clear ip igmp snooping statistics
```

## 27.26 show ip igmp snooping

### Description

The **show ip igmp snooping** command is used to display the global configuration of IGMP snooping.

### Syntax

**show ip igmp snooping**

### Command Mode

Privileged EXEC Mode and Any Configuration Mode

### Privilege Requirement

None.

### Example

Display the global configuration of IGMP:

```
T1700X-16TS# show ip igmp snooping
```

## 27.27 show ip igmp snooping interface

### Description

The **show ip igmp snooping interface** command is used to display the port configuration of IGMP snooping.

### Syntax

```
show ip igmp snooping interface [ ten-gigabitEthernet [ port | port-list ] ]  
{ basic-config | max-groups | packet-stat }
```

```
show ip igmp snooping interface [ port-channel [ lagid ] ] { basic-config |
max-groups }
```

### Parameter

*port* — The Ethernet port number.

*port-list* — The list of Ethernet ports.

*basic-config* | *max-groups* | *packet-stat* — The related configuration information selected to display.

### Command Mode

Privileged EXEC Mode and Any Configuration Mode

### Privilege Requirement

None.

### Example

Display the IGMP basic configuration configuration of all ports and LAGs:

```
T1700X-16TS# show ip igmp snooping interface basic-config
```

Display the IGMP basic configuration of port 1/0/2:

```
T1700X-16TS# show ip igmp snooping interface ten-gigabitEthernet 1/0/2
basic-config
```

Display the IGMP packet statistics of ports 1/0/1-4:

```
T1700X-16TS# show ip igmp snooping interface ten-gigabitEthernet
1/0/1-4 packet-stat
```

## 27.28 show ip igmp snooping vlan

### Description

The **show ip igmp snooping vlan** command is used to display the VLAN configuration of IGMP snooping.

### Syntax

```
show ip igmp snooping vlan [ vlan-id ]
```

### Parameter

*vlan-id* — The VLAN ID selected to display.

### Command Mode

Privileged EXEC Mode and Any Configuration Mode

## Privilege Requirement

None.

## Example

Display the IGMP snooping configuration information of VLAN 2:

```
T1700X-16TS# show ip igmp snooping vlan 2
```

## 27.29 show ip igmp snooping multi-vlan

### Description

The **show ip igmp snooping multi-vlan** command is used to display the Multicast VLAN configuration.

### Syntax

```
show ip igmp snooping multi-vlan
```

### Command Mode

Privileged EXEC Mode and Any Configuration Mode

### Privilege Requirement

None.

### Example

Display the Multicast VLAN configuration:

```
T1700X-16TS# show ip igmp snooping multi-vlan
```

## 27.30 show ip igmp snooping groups vlan

### Description

The **show ip igmp snooping groups vlan** command is used to display the information of the multicast groups of a selected VLAN.

### Syntax

```
show ip igmp snooping groups vlan vlan-id [ multicast_addr ]
```

### Parameter

*vlan-id* — The VLAN ID selected to display.

*multicast\_addr* — IP address of the multicast group.

### Command Mode

Privileged EXEC Mode and Any Configuration Mode

## Privilege Requirement

None.

## Example

Display all the multicast entries in VLAN 5:

```
T1700X-16TS#show ip igmp snooping groups vlan 5
```

Display information of the multicast group with the IP address 225.1.1.1 in VLAN 5:

```
T1700X-16TS#show ip igmp snooping groups vlan 5 225.1.1.1
```

## 27.31 show ip igmp snooping groups

### Description

The **show ip igmp snooping groups** command is used to display the information of all IGMP snooping groups. It can be extended to some other commands to display the dynamic and static multicast information of a selected VLAN.

### Syntax

```
show ip igmp snooping groups [ vlan vlan-id ] [ count | dynamic | dynamic count | static | static count ]
```

### Parameter

*vlan-id* —The VLAN ID selected to display the information of all multicast items.

**count**— The numbers of all multicast groups.

**dynamic**— Display dynamic multicast groups.

**dynamic count**— The numbers of all dynamic multicast groups.

**static**— Display static multicast groups.

**static count**— The numbers of all static multicast groups.

### Command Mode

Privileged EXEC Mode and Any Configuration Mode

## Privilege Requirement

None.

## Example

Display the information of all IGMP snooping groups:

```
T1700X-16TS#show ip igmp snooping groups
```

Display all the multicast entries in VLAN 5:

```
T1700X-16TS(config)#show ip igmp snooping groups vlan 5
```

Display the count of multicast entries in VLAN 5:

```
T1700X-16TS(config)#show ip igmp snooping groups vlan 5 count
```

Display the dynamic multicast groups of VLAN 5:

```
T1700X-16TS(config)#show ip igmp snooping groups vlan 5 dynamic
```

Display the static multicast groups of VLAN 5:

```
T1700X-16TS(config)#show ip igmp snooping groups vlan 5 static
```

Display the count of dynamic multicast entries of VLAN 5:

```
T1700X-16TS(config)#show ip igmp snooping groups vlan 5 dynamic count
```

Display the count of static multicast entries of VLAN 5:

```
T1700X-16TS(config)#show ip igmp snooping groups vlan 5 static count
```

## 27.32 show ip igmp snooping querier

### Description

The **show ip igmp snooping querier** command is used to display the Querier configuration of VLAN.

### Syntax

```
show ip igmp snooping querier [ vlan vlan-id ]
```

### Parameter

*vlan-id* —The VLAN ID selected to display, ranging from 1 to 4094.

### Command Mode

Privileged EXEC Mode and Any Configuration Mode

### Privilege Requirement

None.

### Example

Display all Querier information:

```
T1700X-16TS(config)# show ip igmp snooping querier
```



## 27.33 show ip igmp profile

### Description

The **show ip igmp profile** command is used to display the configuration information of all the profiles or a specific profile.

### Syntax

```
show ip igmp profile [ id ]
```

### Parameter

*id* — Specify the ID of the profile, ranging from 1 to 999.

### Command Mode

Privileged EXEC Mode and Any Configuration Mode

### Privilege Requirement

None.

### Example

Display the configuration information of all profiles:

```
T1700X-16TS(config)# show ip igmp profile
```

## Chapter 28 MLD Snooping Commands

MLD Snooping (Multicast Listener Discovery Snooping) is a multicast control mechanism running on Layer 2 switch. It can effectively prevent multicast groups being broadcasted in the IPv6 network.

### 28.1 ipv6 mld snooping(global)

#### Description

The **ipv6 mld snooping** command is used to enable MLD Snooping function globally. If this function is disabled, all related MLD Snooping function would not work. To disable this function, please use **no ipv6 mld snooping** command.

#### Syntax

```
ipv6 mld snooping
no ipv6 mld snooping
```

#### Command Mode

Global Configuration Mode

#### Privilege Requirement

Only Admin and Operator level users have access to these commands.

#### Example

Enable MLD Snooping:

```
T1700X-16TS(config)# ipv6 mld snooping
```

### 28.2 ipv6 mld snooping(interface)

#### Description

The **ipv6 mld snooping** command is used to enable MLD Snooping function on the desired port. To disable this function, please use **no ipv6 mld snooping** command.

#### Syntax

```
ipv6 mld snooping
no ipv6 mld snooping
```

#### Command Mode

Interface Configuration Mode (interface ten-gigabitEthernet / interface range ten-gigabitEthernet / interface port-channel / interface range port-channel)

## Privilege Requirement

Only Admin and Operator level users have access to these commands.

## Example

Enable MLD Snooping on port 1/0/3:

```
T1700X-16TS(config)# interface ten-gigabitEthernet 1/0/3
T1700X-16TS(config-if)# ipv6 mld snooping
```

## 28.3 ipv6 mld snooping rtime

### Description

The **ipv6 mld snooping rtime** command is used to specify router port aging time globally. To restore the default timer, please use **no ipv6 mld snooping rtime** command.

### Syntax

```
ipv6 mld snooping rtime rtime
no ipv6 mld snooping rtime
```

### Parameter

*rtime* — Specify the aging time in seconds, ranging from 60 to 600. The default aging time is 300 seconds.

### Command Mode

Global Configuration Mode

## Privilege Requirement

Only Admin and Operator level users have access to these commands.

## Example

Specify MLD Snooping router port aging time as 100 seconds globally:

```
T1700X-16TS(config)# ipv6 mld snooping rtime 100
```

## 28.4 ipv6 mld snooping mtime

### Description

The **ipv6 mld snooping mtime** command is used to specify member port aging time globally. The default aging time is 260 seconds. To restore the default timer, please use **no ipv6 mld snooping mtime** command.

### Syntax

```
ipv6 mld snooping mtime mtime
no ipv6 mld snooping mtime
```

### Parameter

*mtime* — Specify the aging time in seconds, ranging from 60 to 600. The default aging time is 260 seconds.

### Command Mode

Global Configuration Mode

### Privilege Requirement

Only Admin and Operator level users have access to these commands.

### Example

Specify MLD Snooping member port aging time as 100 seconds globally:

```
T1700X-16TS(config)# ipv6 mld snooping mtime 100
```

## 28.5 ipv6 mld snooping report-suppression

### Description

The **ipv6 mld snooping report-suppression** command is used enable the MLD report suppression function. When it is enabled, the switch forwards only the first MLD report message per mulicast group to the Layer 3 device, and the subsequent MLD reports from the same multicast group are discarded. To disable the MLD report suppression function and forward all the MLD reports to the Layer 3 device, please use **no ipv6 mld snooping report-suppression** command. This function is disabled by default.

### Syntax

```
ipv6 mld snooping report-suppression  
no ipv6 mld snooping report-suppression
```

### Command Mode

Global Configuration Mode

### Privilege Requirement

Only Admin and Operator level users have access to these commands.

### Example

Enable MLD Report message suppression function:

```
T1700X-16TS(config)# ipv6 mld snooping report-suppression
```

## 28.6 ipv6 mld snooping immediate-leave

### Description

The **ipv6 mld snooping immediate-leave** command is used to configure the Fast Leave function for port. To disable the Fast Leave function, please use **no ipv6 mld snooping immediate-leave** command.

### Syntax

```
ipv6 mld snooping immediate-leave  
no ipv6 mld snooping immediate-leave
```

### Command Mode

Interface Configuration Mode (interface ten-gigabitEthernet / interface range ten-gigabitEthernet / interface port-channel / interface range port-channel)

### Privilege Requirement

Only Admin and Operator level users have access to these commands.

### Example

Enable the Fast Leave function for port 1/0/3:

```
T1700X-16TS(config)# interface ten-gigabitEthernet 1/0/3  
T1700X-16TS(config-if)# ipv6 mld snooping immediate-leave
```

## 28.7 ipv6 mld snooping drop-unknown

### Description

The **ipv6 mld snooping drop-unknown** command is used to enable the unknown multicast packets filter function. To disable this function, please use **no ipv6 mld snooping drop-unknown** command. By default, it is disabled.

### Syntax

```
ipv6 mld snooping drop-unknown  
no ipv6 mld snooping drop-unknown
```

### Command Mode

Global Configuration Mode

### Privilege Requirement

Only Admin and Operator level users have access to these commands.

### Example

Enable unknown multicast filter function:

```
T1700X-16TS(config)# ipv6 mld snooping drop-unknown
```

## 28.8 ipv6 mld snooping last-listener query-inteval

### Description

The **ipv6 mld snooping last-listener query-inteval** command is used to specify the interval to send Specific Query Message. The default value is 1 second. To restore the default interval, please use **no ipv6 mld snooping last-listener query-inteval** command.

### Syntax

```
ipv6 mld snooping last-listener query-inteval interval  
no ipv6 mld snooping last-listener query-inteval
```

### Parameter

*interval* — Specify the interval to send Specific Query Message in seconds, ranging from 1 to 5.

### Command Mode

Global Configuration Mode

### Privilege Requirement

Only Admin and Operator level users have access to these commands.

### Example

Specify the interval of Specific Query Message to 3 seconds:

```
T1700X-16TS(config)# ipv6 mld snooping last-listener query-inteval 3
```

## 28.9 ipv6 mld snooping last-listener query-count

### Description

The **ipv6 mld snooping last-listener query-count** command is used to specify the numbers of Specific Query Message to be sent. The default value is 2. To restore the default number, please use **no ipv6 mld snooping last-listener query-count** command.

### Syntax

```
ipv6 mld snooping last-listener query-count num  
no ipv6 mld snooping last-listener query-count
```

### Parameter

*num* — Specify the numbers of Specific Query Message to be sent, ranging from 1 to 5.

### Command Mode

Global Configuration Mode

### Privilege Requirement

Only Admin and Operator level users have access to these commands.

## Example

Specify the number of Specific Query Message to 3:

```
T1700X-16TS(config)# ipv6 mld snooping last-listener query-count 3
```

## 28.10 ipv6 mld snooping vlan-config

### Description

The **ipv6 mld snooping vlan-config** command is used to enable VLAN MLD Snooping function or to modify MLD Snooping parameters, and to create static multicast IP entry. To disable the VLAN MLD Snooping function, please use **no ipv6 mld snooping vlan-config** command.

### Syntax

```
ipv6 mld snooping vlan-config vlan-id-list [ rtime router-time | mtime member-time | rport interface { ten-gigabitEthernet port-list | port-channel lagid } ]
```

```
ipv6 mld snooping vlan-config vlan-id-list static ip interface { ten-gigabitEthernet port-list | port-channel lagid }
```

```
no ipv6 mld snooping vlan-config vlan-id-list [ rtime router-time | mtime member-time | rport interface { ten-gigabitEthernet port-list | port-channel lagid } ]
```

```
no ipv6 mld snooping vlan-config vlan-id-list static ip interface { ten-gigabitEthernet port-list | port-channel lagid }
```

### Parameter

*vlan-id-list* — The ID list of the VLAN desired to modify configuration, ranging from 1 to 4094, in the format of 1-3, 5.

*router-time* — Router Port Time. Within this time, if the switch does not receive MLD query message from the router port, it will consider this port is not a router port any more. Router Port Time ranges from 60 to 600 in seconds. By default, it is 0 and the global router-time will be used.

*member-time* — Member Port Time. Within this time, if the switch does not receive MLD report message from the member port, it will consider this port is not a member port any more. Member Port Time ranges from 60 to 600 in seconds. By default, it is 0 and the global member-time will be used.

*port-list* — The list of Ethernet ports.

*lagid* — The ID of the LAGs.

*ip* — The static multicast IP address.

## Command Mode

Global Configuration Mode

## Privilege Requirement

Only Admin and Operator level users have access to these commands.

## Example

Enable the MLD Snooping function and modify Router Port Time as 300 seconds, Member Port Time as 200 seconds for VLAN 1-3, and set the router port as 1/0/1 for VLAN 1-2:

```
T1700X-16TS(config)# ipv6 mld snooping vlan-config 1-3 rtime 300
T1700X-16TS(config)# ipv6 mld snooping vlan-config 1-3 mtime 200
T1700X-16TS(config)# ipv6 mld snooping vlan-config 1-2 rport interface
ten-gigabitEthernet 1/0/1
```

Add static multicast IP address ff01::1234:01, which corresponds to VLAN 2, and configure the forward ports as ports 1/0/1-3:

```
T1700X-16TS(config)# ipv6 mld snooping vlan-config 2 static ff01::1234:01
interface ten-gigabitEthernet 1/0/1-3
```

## 28.11 ipv6 mld snooping vlan-config (router-ports-forbidden)

### Description

This command is used to forbid the specified ports as being router ports in the specified VLAN(s). To delete the forbidden router ports, please use **no ipv6 mld snooping vlan-config *vlan-id-list* router-ports-forbidden** command.

### Syntax

```
ipv6 mld snooping vlan-config vlan-id-list router-ports-forbidden interface
{ ten-gigabitEthernet port-list | port-channel port-channel-id }
no ipv6 mld snooping vlan-config vlan-id-list router-ports-forbidden
interface [ ten-gigabitEthernet port-list | port-channel port-channel-id ]
```

### Parameter

*vlan-id-list* — The ID list of the VLAN desired to modify configuration, ranging from 1 to 4094, in the format of 1-3, 5.



*port-list* — Forbid the specified ports as being router ports. Packets sent from multicast routers to these ports will be discarded.

*port-channel-id* — Forbid the specified port-channels as being router ports. Packets sent from multicast routers to these port-channels will be discarded.

### Command Mode

Global Configuration Mode

### Privilege Requirement

Only Admin and Operator level users have access to these commands.

### Example

Forbid the Ethernet ports 1/0/1-3 as being router ports in VLAN 1 :

```
T1700X-16TS(config)# ipv6 mld snooping multi-vlan-config 1
router-ports-forbidden interface ten-gigabitEthernet 1/0/1-3
```

## 28.12 ipv6 mld snooping multi-vlan-config

### Description

The **ipv6 mld snooping multi-vlan-config** command is used to create Multicast VLAN. To delete the corresponding Multicast VLAN, please use **no ipv6 mld snooping multi-vlan-config** command. To restore the default values, please use **no ipv6 mld snooping multi-vlan-config** with specified parameters.

### Syntax

```
ipv6 mld snooping multi-vlan-config [ vlan-id ] [ rtime router-time | mtime member-time | rport interface { ten-gigabitEthernet port-list | port-channel lagid } ]
```

```
no ipv6 mld snooping multi-vlan-config [ rtime router-time | mtime member-time | rport interface { ten-gigabitEthernet port-list | port-channel lagid } ]
```

### Parameter

*vlan-id* — The ID of the multicast VLAN desired to create or modify, ranging from 2 to 4094. If not specified, the default multicast VLAN will be selected.

*router-time* — Router Port Time. Within this time, if the switch does not receive MLD query message from the router port, it will consider this port is not a router port any more. Router Port Time ranges from 60 to 600 in seconds. By default, it is 0 and the global router-time will be used.

*member-time* — Member Port Time. Within this time, if the switch does not receive MLD report message from the member port, it will consider this port is not a member port any more. Member Port Time ranges from 60 to 600 in seconds. By default, it is 0 and the global member-time will be used.

*port-list* — The list of Ethernet ports.

*lagid* — The ID of the LAGs.

### Command Mode

Global Configuration Mode

### Privilege Requirement

Only Admin level users have access to these commands.

### Example

Enable Multicast VLAN 3, and configure Router Port Time as 100 seconds, Member Port Time 100 seconds, and Static Router Port port 1/0/3:

```
T1700X-16TS(config)# ipv6 mld snooping multi-vlan-config 3 rtime 100
T1700X-16TS(config)# ipv6 mld snooping multi-vlan-config 3 mtime 100
T1700X-16TS(config)# ipv6 mld snooping multi-vlan-config 3 rport
interface ten-gigabitEthernet 1/0/3
```

## 28.13 ipv6 mld snooping multi-vlan-config (router-ports-forbidden)

### Description

This command is used to forbid the specified ports as being router ports in the specified multicast VLAN. To delete the forbidden router ports, please use **no ipv6 mld snooping multi-vlan-config router-ports-forbidden** command.

### Syntax

```
ipv6 mld snooping multi-vlan-config [ vlan-id ] router-ports-forbidden
interface { ten-gigabitEthernet port-list | port-channel port-channel-id }
no ipv6 mld snooping multi-vlan-config router-ports-forbidden [ interface
{ ten-gigabitEthernet port-list | port-channel port-channel-id } ]
```

### Parameter

*vlan-id*—The ID of the multicast VLAN, ranging from 2 to 4094.

*port-list* — Forbid the specified ports as being router ports. Packets sent from multicast routers to these ports will be discarded.

*port-channel-id* — Forbid the specified port-channels as being router ports. Packets sent from multicast routers to these port-channels will be discarded.

### Command Mode

Global Configuration Mode

### Privilege Requirement

Only Admin level users have access to these commands.

### Example

Forbid the Ethernet ports 1/0/1-3 as being router ports in multicast VLAN 2 :

```
T1700X-16TS(config)# ipv6 mld snooping multi-vlan-config 2
router-ports-forbidden interface ten-gigabitEthernet 1/0/1-3
```

## 28.14 ipv6 mld snooping multi-vlan-config (source-ip-replace)

### Description

This command is used to replace the multicast source IP address of the MLD packets in the specified multicast VLAN. To delete the forbidden router ports, please use **no ipv6 mld snooping multi-vlan-config replace-sourceip** command.

### Syntax

```
ipv6 mld snooping multi-vlan-config [ vlan-id ] replace-sourceip ip
no ipv6 mld snooping multi-vlan-config replace-sourceip
```

### Parameter

*vlan-id* — The ID of the multicast VLAN, ranging from 2 to 4094.

*ip* — Specify the IP address. The switch will use this IP address to replace the source IP address of the MLD packets.

### Command Mode

Global Configuration Mode

### Privilege Requirement

Only Admin level users have access to these commands.

## Example

Replace the source IP address of the MLD packets in multicast VLAN 2 as fe80::02ff:fff:fe00:0001:

```
T1700X-16TS(config)# ipv6 mld snooping multi-vlan-config 2
replace-sourceip fe80::02ff:fff:fe00:0001
```

## 28.15 ipv6 mld snooping querier vlan

### Description

The **ipv6 mld snooping querier vlan** command is used to enable the MLD Querier function. To disable this function, please use **no ipv6 mld snooping querier vlan** command.

### Syntax

```
ipv6 mld snooping querier vlan vlan-id
no ipv6 mld snooping querier vlan vlan-id
```

### Parameter

*vlan-id* — The VLAN that enables the MLD querier function, ranging from 1 to 4094.

### Command Mode

Global Configuration Mode

### Privilege Requirement

Only Admin and Operator level users have access to these commands.

### Example

Enable MLD Querier function on VLAN 2:

```
T1700X-16TS(config)# ipv6 mld snooping querier vlan 2
```

## 28.16 ipv6 mld snooping querier vlan (general query)

### Description

The **ipv6 mld snooping querier vlan** command is used to configure the parameters for MLD Snooping Querier to send a general query frame. To return to the default configuration, please use **no ipv6 mld snooping querier vlan** command.

## Syntax

```
ipv6 mld snooping querier vlan vlan-id { query-interval interval |  
max-response-time response-time | general-query source-ip ip-addr }  
no ipv6 mld snooping querier vlan vlan-id { query-interval |  
max-response-time | general-query source-ip }
```

## Parameter

*vlan-id* — VLAN ID, ranging from 1 to 4094.

*interval* — The time interval to send a general query frame by MLD Snooping Querier, ranging from 10 to 300 (Seconds). By default, it is 60 seconds.

*response-time* — The maximal time for the host to respond to a general query frame, ranging from 1 to 25 (Seconds). By default, it is 10 seconds.

*ip-addr* — The source IP of the general query frame sent by MLD Snooping Querier. It should not be a multicast IP or a broadcast IP. By default, it is fe80::02ff:fff:fe00:0001.

## Command Mode

Global Configuration Mode

## Privilege Requirement

Only Admin and Operator level users have access to these commands.

## Example

For VLAN 2, specify its query-interval as 200 seconds, and the response-time as 20 seconds:

```
T1700X-16TS(config)#ipv6 mld snooping querier vlan 2 query-interval 200  
T1700X-16TS(config)#ipv6 mld snooping querier vlan 2  
max-response-time 20
```

## 28.17 ipv6 mld snooping max-groups

### Description

The **ipv6 mld snooping max-groups** command is used to configure the maximum number of groups that a port can join in. The **ipv6 mld snooping max-groups action** is used to configure the action that the port takes when it receives an MLD report message and the maximum number of entries is in the forwarding table. To remove the maximum group limitation and return to the default of no limitation on the specified port, please use the **no ipv6 mld**

**snooping max-groups** command. To return to the default action of dropping the report, please use the **no ipv6 mld snooping max-groups action** command. These commands only apply to the dynamic multicast groups.

## Syntax

```
ipv6 mld snooping max-groups [ maxgroup ]  
ipv6 mld snooping max-groups action { drop | replace }  
no ipv6 mld snooping max-groups  
no ipv6 mld snooping max-groups action
```

## Parameter

*maxgroup* — Specify the maximum numbers of groups that the port can join. It ranges from 0 to 1000 and the default value is 1000.

drop — When the number of the dynamic multicast groups that a port joins has exceeded the max-group, the port will not join any new multicast group.

replace — When the number of the dynamic multicast groups that a port joins has exceeded the max-group, the newly joined multicast group will replace an existing multicast group with the lowest multicast group address.

## Command Mode

Interface Configuration Mode (interface ten-gigabitEthernet / interface range ten-gigabitEthernet / interface port-channel / interface range port-channel)

## Privilege Requirement

Only Admin and Operator level users have access to these commands.

## Example

Specify the maximum numbers of groups that ports 1/0/2-5 can join as 10, and configure the throttling action as replace:

```
T1700X-16TS(config)#interface range gigabitEthernet 1/0/2-5  
T1700X-16TS(config-if-range)#ipv6 mld snooping max-groups 10  
T1700X-16TS(config-if-range)#ipv6 mld snooping max-groups action  
replace
```

## 28.18 ipv6 mld profile

### Description

The **ipv6 mld profile** command is used to create the configuration profile. To delete the corresponding profile, please use **no ipv6 mld profile** command.

## Syntax

```
ipv6 mld profile id  
no ipv6 mld profile id
```

## Parameter

*id* — Specify the id of the configuration profile, ranging from 1 to 999.

## Command Mode

Global Configuration Mode

## Privilege Requirement

Only Admin and Operator level users have access to these commands.

## Example

Create the profile 1:

```
T1700X-16TS(config)# ipv6 mld profile 1
```

## 28.19 deny

### Description

The **deny** command is used to configure the filtering mode of profile as deny.

### Syntax

```
deny
```

### Command Mode

Profile Configuration Mode

### Privilege Requirement

Only Admin and Operator level users have access to these commands.

### Example

Configure the filtering mode of profile 1 as deny:

```
T1700X-16TS(config)# ipv6 mld profile 1  
T1700X-16TS(config-mld-profile)#deny
```

## 28.20 permit

### Description

The **permit** command is used to configure the filtering mode of profile as permit.

### Syntax

**permit**

### Command Mode

Profile Configuration Mode

### Privilege Requirement

Only Admin and Operator level users have access to these commands.

### Example

Configure the filtering mode of profile 1 as permit:

```
T1700X-16TS(config)# ipv6 mld profile 1
T1700X-16TS(config-mld-profile)#permit
```

## 28.21 range

### Description

The **range** command is used to configure the range of the profile's filtering multicast address. To delete the corresponding filtering multicast address, please use **no range** command. A profile contains 16 filtering IP-range entries at most.

### Syntax

**range** *start-ip end-ip*

**no range** *start-ip end-ip*

### Parameter

*start-ip* — Start IPv6 multicast address of the filter entry.

*end-ip* — End IPv6 multicast address of the filter entry.

### Command Mode

Profile Configuration Mode



## Privilege Requirement

Only Admin and Operator level users have access to these commands.

## Example

Configure one of the filter multicast address entry as range ff80::1234 to ff80::1235 in profile 1:

```
T1700X-16TS(config)# ipv6 mld profile 1
T1700X-16TS(config-mld-profile)#range ff80::1234 ff80::1235
```

## 28.22 ipv6 mld filter

### Description

The **ipv6 mld filter** command is used to bind the specified profile to the interface. To delete the binding, please use **no ipv6 mld filter** command.

### Syntax

```
ipv6 mld filter profile-id
no ipv6 mld filter
```

### Parameter

*profile-id* — Specify the profile ID, ranging from 1 to 999.

### Command Mode

Interface Configuration Mode (interface ten-gigabitEthernet / interface range ten-gigabitEthernet / interface port-channel / interface range port-channel)

## Privilege Requirement

Only Admin and Operator level users have access to these commands.

## Example

Bind profile 1 to interface ten-gigabitEthernet 1/0/2:

```
T1700X-16TS(config)# interface ten-gigabitEthernet 1/0/2
T1700X-16TS(config-if)# ipv6 mld filter 1
```

## 28.23 clear ipv6 mld snooping statistics

### Description

The **clear ipv6 mld snooping statistics** command is used to clear the statistics of the MLD packets.

### Syntax

```
clear ipv6 mld snooping statistics
```

## Command Mode

Privileged EXEC Mode and Any Configuration Mode

## Privilege Requirement

Only Admin, Operator and Power User level users have access to these commands.

## Example

Clear the statistics of the MLD packets:

```
T1700X-16TS(config)# clear ipv6 mld snooping statistics
```

## 28.24 show ipv6 mld snooping

### Description

The **show ipv6 mld snooping** command is used to display the global configuration of MLD Snooping.

### Syntax

```
show ipv6 mld snooping
```

### Command Mode

Privileged EXEC Mode and Any Configuration Mode

### Privilege Requirement

None.

### Example

Display the global configuration of MLD Snooping:

```
T1700X-16TS(config)# show ipv6 mld snooping
```

## 28.25 show ipv6 mld snooping interface

### Description

The **show ipv6 mld snooping interface** command is used to display the port configuration of MLD snooping.

### Syntax

```
show ipv6 mld snooping interface [ ten-gigabitEthernet [ port | port-list ] ]  
{ basic-config | max-groups | packet-stat }
```

```
show ipv6 mld snooping interface [ port-channel [ lagid ] ] { basic-config |  
max-groups }
```

## Parameter

*port* — The Ethernet port number.

*port-list* — The list of Ethernet ports.

basic-config | max-groups | packet-stat — The related configuration information selected to display.

## Command Mode

Privileged EXEC Mode and Any Configuration Mode

## Privilege Requirement

None.

## Example

Display the MLD basic configuration configuration of all ports and LAGs:

```
T1700X-16TS# show ipv6 mld snooping interface basic-config
```

Display the MLD basic configuration of port 1/0/2:

```
T1700X-16TS# show ipv6 mld snooping interface ten-gigabitEthernet 1/0/2
basic-config
```

Display the MLD packet statistics of ports 1/0/1-4:

```
T1700X-16TS# show ipv6 mld snooping interface ten-gigabitEthernet
1/0/1-4 packet-stat
```

## 28.26 show ipv6 mld snooping vlan

### Description

The **show ipv6 mld snooping vlan** command is used to display VLAN information of MLD Snooping.

### Syntax

```
show ipv6 mld snooping vlan [ vlan-id ]
```

### Parameter

*vlan-id* — The VLAN ID selected to display, ranging from 1 to 4094.

### Command Mode

Privileged EXEC Mode and Any Configuration Mode

### Privilege Requirement

None.

## Example

Display all of the VLAN information:

```
T1700X-16TS(config)# show ipv6 mld snooping vlan
```

## 28.27 show ipv6 mld snooping multi-vlan

### Description

The **show ipv6 mld snooping multi-vlan** command is used to display the Multicast VLAN configuration.

### Syntax

```
show ipv6 mld snooping multi-vlan
```

### Command Mode

Privileged EXEC Mode and Any Configuration Mode

### Privilege Requirement

None.

### Example

Display the Multicast VLAN configuration:

```
T1700X-16TS# show ipv6 mld snooping multi-vlan
```

## 28.28 show ipv6 mld snooping groups vlan

### Description

The **show ipv6 mld snooping groups vlan** command is used to display the information of the multicast groups of a selected VLAN.

### Syntax

```
show ipv6 mld snooping groups vlan vlan-id [ ipv6_multicast_addr ]
```

### Parameter

*vlan-id* — The VLAN ID selected to display.

*ipv6\_multicast\_addr* — IPv6 address of the multicast group.

### Command Mode

Privileged EXEC Mode and Any Configuration Mode

### Privilege Requirement

None.

## Example

Display all the multicast entries in VLAN 5:

```
T1700X-16TS#show ipv6 mld snooping groups vlan 5
```

Display information of the multicast group with the IPv6 address ff80::1234 in VLAN 5:

```
T1700X-16TS#show ipv6 mld snooping groups vlan 5 ff80::1234
```

## 28.29 show ipv6 mld snooping groups

### Description

The **show ipv6 mld snooping groups** command is used to display the information of all MLD snooping groups. It can be extended to some other commands to display the dynamic and static multicast information of a selected VLAN.

### Syntax

```
show ipv6 mld snooping groups [ vlan vlan-id ] [ count | dynamic | dynamic count | static | static count ]
```

### Parameter

*vlan-id* —The VLAN ID selected to display the information of all multicast items.

*count* — The numbers of all multicast groups.

*dynamic* — Display dynamic multicast groups.

*dynamic count* — The numbers of all dynamic multicast groups.

*static* — Display static multicast groups.

*static count* — The numbers of all static multicast groups.

### Command Mode

Privileged EXEC Mode and Any Configuration Mode

### Privilege Requirement

None.

### Example

Display the information of all MLD snooping groups:

```
T1700X-16TS#show ipv6 mld snooping groups
```

Display all the multicast entries in VLAN 5:

```
T1700X-16TS(config)#show ipv6 mld snooping groups vlan 5
```

Display the count of multicast entries in VLAN 5:

```
T1700X-16TS(config)#show ipv6 mld snooping groups vlan 5 count
```

Display the dynamic multicast groups of VLAN 5:

```
T1700X-16TS(config)#show ipv6 mld snooping groups vlan 5 dynamic
```

Display the static multicast groups of VLAN 5:

```
T1700X-16TS(config)#show ipv6 mld snooping groups vlan 5 static
```

Display the count of dynamic multicast entries of VLAN 5:

```
T1700X-16TS(config)#show ipv6 mld snooping groups vlan 5 dynamic  
count
```

Display the count of static multicast entries of VLAN 5:

```
T1700X-16TS(config)#show ipv6 mld snooping groups vlan 5 static count
```

## 28.30 show ipv6 mld snooping querier

### Description

The **show ipv6 mld snooping querier** command is used to display the Querier configuration of VLAN.

### Syntax

```
show ipv6 mld snooping querier [ vlan vlan-id ]
```

### Parameter

*vlan-id* —The VLAN ID selected to display, ranging from 1 to 4094.

### Command Mode

Privileged EXEC Mode and Any Configuration Mode

### Privilege Requirement

None.

### Example

Display all Querier information:

```
T1700X-16TS(config)# show ipv6 mld snooping querier
```

## 28.31 show ipv6 mld profile

### Description

The **show ipv6 mld profile** command is used to display the configuration information of all the profiles or a specific profile.

### Syntax

```
show ipv6 mld profile [ id ]
```

### Parameter

*id* — Specify the ID of the profile, ranging from 1 to 999.

### Command Mode

Privileged EXEC Mode and Any Configuration Mode

### Privilege Requirement

None.

### Example

Display the configuration information of all profiles:

```
T1700X-16TS(config)# show ipv6 mld profile
```

## Chapter 29 SNMP Commands

SNMP (Simple Network Management Protocol) functions are used to manage the network devices for a smooth communication, which can facilitate the network administrators to monitor the network nodes and implement the proper operation.

### 29.1 snmp-server

#### Description

The **snmp-server** command is used to enable the SNMP function. By default, it is disabled. To return to the default configuration, please use **no snmp-server** command.

#### Syntax

```
snmp-server  
no snmp-server
```

#### Command Mode

Global Configuration Mode

#### Privilege Requirement

Only Admin level users have access to these commands.

#### Example

Enable the SNMP function:

```
T1700X-16TS(config)# snmp-server
```

### 29.2 snmp-server view

#### Description

The **snmp-server view** command is used to add View. To delete the corresponding View, please use **no snmp-server view** command. The OID (Object Identifier) of the SNMP packets is used to describe the managed objects of the switch, and the MIB (Management Information Base) is the set of the OIDs. The SNMP View is created for the SNMP management station to manage MIB objects.

#### Syntax

```
snmp-server view name mib-oid { include | exclude }  
no snmp-server view name mib-oid
```



## Parameter

*name* — The entry name of View, ranging from 1 to 16 characters. Each View includes several entries with the same name.

*mib-oid* — MIB Object ID. It is the Object Identifier (OID) for the entry of View, ranging from 1 to 61 characters.

include | exclude — View Type, with include and exclude options. They represent the view entry can/cannot be managed by the SNMP management station individually.

## Command Mode

Global Configuration Mode

## Privilege Requirement

Only Admin level users have access to these commands.

## Example

Add a View named view1, configuring the OID as 1.3.6.1.6.3.20, and this OID can be managed by the SNMP management station:

```
T1700X-16TS(config)# snmp-server view view1 1.3.6.1.6.3.20 include
```

## 29.3 snmp-server group

### Description

The **snmp-server group** command is used to manage and configure the SNMP group. To delete the corresponding SNMP group, please use **no snmp-server group** command. SNMP v3 provides the VACM (View-based Access Control Model) and USM (User-Based Security Model) mechanisms for authentication. The users in the SNMP Group can manage the device via the Read View, Write View and Notify View. And the authentication mode and the privacy mode guarantee the high security for the communication between the management station and the managed device.

### Syntax

```
snmp-server group name [ smode { v1 | v2c | v3 } ] [ slev { noAuthNoPriv | authNoPriv | authPriv } ] [ read read-view ] [ write write-view ] [ notify notify-view ]
```

```
no snmp-server group name smode { v1 | v2c | v3 } slev { noAuthNoPriv | authNoPriv | authPriv }
```

## Parameter

*name* — The SNMP Group name, ranging from 1 to 16 characters. The Group Name, Security Model and Security Level compose the identifier of the SNMP Group. These three items of the Users in one group should be the same.

*smode* — Security Model, with v1、v2c and v3 options. They represent SNMP v1, SNMP v2c and SNMP v3.

*slev* — The Security Level of SNMP v3 Group. There are three options, including noAuthNoPriv (no authorization and no encryption)、authNoPriv (authorization and no encryption) and authPriv (authorization and encryption). By default, the Security Level is noAuthNoPriv. There is no need to configure this in SNMP v1 Mode and SNMP v2c Mode.

*read-view* — Select the View to be the Read View. The management access is restricted to read-only, and changes cannot be made to the assigned SNMP View.

*write-view* — Select the View to be the Write View. The management access is writing only and changes can be made to the assigned SNMP View. The View defined both as the Read View and the Write View can be read and modified.

*notify-view* — Select the View to be the Notify View. The management station can receive notification messages of the assigned SNMP view generated by the switch's SNMP agent.

## Command Mode

Global Configuration Mode

## Privilege Requirement

Only Admin level users have access to these commands.

## Example

Add a group, and configure the name as group 1, the Security Model as SNMP v3, the security level as authNoPriv, the management access to the assigned View viewDefault as read-write, besides the notification messages sent by View viewDefault can be received by Management station:

```
T1700X-16TS(config)# snmp-server group group1 smode v3 slev  
authNoPriv read viewDefault write viewDefault notify viewDefault
```

Delete group 1:

```
T1700X-16TS(config)# no snmp-server group group1 smode v3 slev  
authNoPriv
```

## 29.4 snmp-server user

### Description

The **snmp-server user** command is used to add User. To delete the corresponding User, please use **no snmp-server user** command. The User in an SNMP Group can manage the switch via the management station software. The User and its Group have the same security level and access right.

### Syntax

```
snmp-server user name { local | remote } group-name [ smode { v1 | v2c | v3 } ]  
[ slev { noAuthNoPriv | authNoPriv | authPriv } ] [ cmode { none | MD5 | SHA } ]  
[ cpwd confirm-pwd ] [ emode { none | DES } ] [ epwd encrypt-pwd ]  
no snmp-server user name
```

### Parameter

*name* — User Name, ranging from 1 to 16 characters.

local | remote — User Type, with local and remote options. Local indicates that the user is connected to a local SNMP engine, while remote means that the user is connected to a remote SNMP engine.

*group-name* — The Group Name of the User. The User is classified to the corresponding Group according to its Group Name, Security Model and Security Level.

smode — The Security Model of the User, with v1, v2c and v3 options. By default, the option is v1. The Security Model of the User must be the same with that of the Group which the User belongs to.

slev — The Security Level of SNMP v3 Group. There are three options, including noAuthNoPriv (no authorization and no encryption), authNoPriv (authorization and no encryption) and authPriv (authorization and encryption). By default, the option is “noAuthNoPriv”. The Security Level of the User must be the same with that of the Group which the User belongs to.

cmode — The Authentication Mode of the SNMP v3 User, with none, MD5 and SHA options. None indicates no authentication method is used, MD5 indicates the port authentication is performed via HMAC-MD5 algorithm and SHA indicates the port authentication is performed via SHA (Secure Hash Algorithm). SHA authentication mode has a higher security than MD5 mode. By default, the Authentication Mode is “none”.

*confirm-pwd* — Authentication Password, ranging from 1 to 16 characters. The question marks and spaces are not allowed. This password in the configuration file will be displayed in the symmetric encrypted form.

*emode* — The Privacy Mode of the SNMP v3 User, with none and DES options. None indicates no privacy method is used, and DES indicates DES encryption method is used. By default, the Privacy Mode is “none”.

*encrypt-pwd* — Privacy Password, ranging from 1 to 16 characters. The question marks and spaces are not allowed. This password in the configuration file will be displayed in the symmetric encrypted form.

## Command Mode

Global Configuration Mode

## Privilege Requirement

Only Admin level users have access to these commands.

## Example

Add Local User admin to Group group2, and configure the Security Model of the user as v3, the Security Level of the group as authPriv, the Authentication Mode of the user as MD5, the Authentication Password as 11111, the Privacy Mode as DES, and the Privacy Password as 22222:

```
T1700X-16TS(config)# snmp-server user admin local group2 smode v3 slev  
authPriv cmode MD5 cpwd 11111 emode DES epwd 22222
```

# 29.5 snmp-server community

## Description

The **snmp-server community** command is used to add Community. To delete the corresponding Community, please use **no snmp-server community** command. SNMP v1 and SNMP v2c adopt community name authentication. The community name can limit access to the SNMP agent from SNMP network management station, functioning as a password.

## Syntax

```
snmp-server community name { read-only | read-write } mib-view  
no snmp-server community name
```

## Parameter

*name* — Community Name, ranging from 1 to 16 characters.

read-only | read-write — The access rights of the community, with read-only and read-write options.

*mib-view* — The MIB View for the community to access.

## Command Mode

Global Configuration Mode

## Privilege Requirement

Only Admin level users have access to these commands.

## Example

Add community public, and the community has read-write management right to View viewDefault:

```
T1700X-16TS(config)# snmp-server community public read-write
viewDefault
```

# 29.6 snmp-server host

## Description

The **snmp-server host** command is used to add Notification. To delete the corresponding Notification, please use **no snmp-server host** command.

## Syntax

```
snmp-server host ip udp-port user-name [ smode { v1 | v2c | v3 } ] [ slev { noAuthNoPriv | authNoPriv | authPriv } ] [ type { trap | inform } ] [ retries retries ] [ timeout timeout ]
```

```
no snmp-server host ip user-name
```

## Parameter

*ip* — The IP Address of the management Host. Both IPv4 and IPv6 addresses are supported, for example 192.168.0.100 or fe80::1234.

*udp-port* — UDP port, which is used to send notifications. The UDP port functions with the IP address for the notification sending. It ranges from 1 to 65535.

*user-name* — The User name of the management station.

**smode** — The Security Model of the management station, with v1, v2c and v3 options. By default, the option is v1.

**slev** — The Security Level of SNMP v3 Group. There are three options, including noAuthNoPriv (no authorization and no encryption), authNoPriv

(authorization and no encryption) and authPriv (authorization and encryption). By default, the option is “noAuthNoPriv”.

*type* — The type of the notifications, with trap and inform options. Trap indicates traps are sent, while inform indicates informs are sent. The inform type has a higher security than the trap type and resend and timeout need to be configured if you select this option. You can only select the trap type in Security Model v1. By default, the type of the notifications is “trap”.

*retries* — The amount of times the switch retries an inform request, ranging from 1 to 255. The switch will resend the inform request if it doesn't get the response from the management station during the Timeout interval, and it will terminate resending the inform request if the resending times reach the specified Retry times.

*timeout* — The maximum time for the switch to wait for the response from the management station before resending a request, ranging from 1 to 3600 in seconds.

## Command Mode

Global Configuration Mode

## Privilege Requirement

Only Admin level users have access to these commands.

## Example

Add a Notification entry, and configure the IP address of the management Host as 192.168.0.146, the UDP port as 162, the User name of the management station as admin, the Security Model of the management station as v2c, the type of the notifications as inform, the maximum time for the switch to wait as 1000 seconds, and the retries time as 100:

```
T1700X-16TS(config)# snmp-server host 192.168.0.146 162 admin smode  
v2c type inform retries 100 timeout 1000
```

Add a Notification entry, and configure the IP Address of the management Host as fe80::1234, the UDP port as 162, the User name of the management station as admin, the Security Model of the management station as v2c, the type of the notifications as inform, the maximum time for the switch to wait as 1000 seconds, and the retries time as 100:

```
T1700X-16TS(config)# snmp-server host fe80::1234 162 admin smode v2c  
type inform retries 100 timeout 1000
```

## 29.7 snmp-server engineID

### Description

The **snmp-server engineID** command is used to configure the local and remote engineID of the switch. To restore to the default setting, please use **no snmp-server engineID** command.

### Syntax

```
snmp-server engineID { [ local local-engineID ] [ remote remote-engineID ] }  
no snmp-server engineID
```

### Parameter

*local-engineID* — Local Engine ID for local clients. The Engine ID is a unique alphanumeric string used to identify the SNMP engine on the switch. Its length ranges from 10 to 64 hexadecimal characters, which must be even number meanwhile.

*remote-engineID* — Remote Engine ID for the switch. The Engine ID is a unique alphanumeric string used to identify the SNMP engine on the remote device which receives informs from the switch. Its length ranges from 10 to 64 hexadecimal characters, which must be even number meanwhile. The **snmp-server engineID** will be disabled if the **local** and **remote** are both not configured.

### Command Mode

Global Configuration Mode

### Privilege Requirement

Only Admin level users have access to these commands.

### Example

Specify the local engineID as 1234567890, and the remote engineID as abcdef123456:

```
T1700X-16TS(config)# snmp-server engineID local 1234567890 remote  
abcdef123456
```

## 29.8 snmp-server traps snmp

### Description

The **snmp-server traps snmp** command is used to enable SNMP standard traps which include four types: linkup, linkdown, warmstart and coldstart. To

disable the sending of SNMP standard traps, please use **no snmp-server traps snmp** command.

### Syntax

**snmp-server traps snmp** [ linkup | linkdown | warmstart | coldstart | auth-failure ]

**no snmp-server traps snmp** [ linkup | linkdown | warmstart | coldstart | auth-failure ]

### Parameter

linkup — Enable linkup trap. It is sent when port status changes from linkdown to linkup. By default, it is enabled.

linkdown — Enable linkdown trap. It is sent when port status changes from linkup to linkdown. By default, it is enabled.

warmstart — Enable warmstart trap. It is sent upon SNMP function reboot. By default, it is enabled.

coldstart — Enable coldstart trap. It is sent upon switch reboot. By default, it is enabled.

auth-failure — Enable the auth-failure trap. It is sent when a received SNMP request fails the authentication. By default, it is enabled.

### Command Mode

Global Configuration Mode

### Privilege Requirement

Only Admin level users have access to these commands.

### Example

Enable SNMP standard linkup trap for the switch:

```
T1700X-16TS(config)# snmp-server traps snmp linkup
```

## 29.9 snmp-server traps link-status

### Description

The **snmp-server traps link-status** command is used to enable SNMP link status trap for the specified port. To disable the sending of SNMP link status trap, please use **no snmp-server traps link-status** command.

### Syntax

**snmp-server traps link-status**



**no snmp-server traps link-status**

### Command Mode

Interface Configuration Mode (interface ten-gigabitEthernet / interface range ten-gigabitEthernet)

### Privilege Requirement

Only Admin level users have access to these commands.

### Example

Enable SNMP link status trap for port 3:

```
T1700X-16TS(config)# interface ten-gigabitEthernet 1/0/3
T1700X-16TS(config-if)# snmp-server traps link-status
```

## 29.10 snmp-server traps

### Description

The **snmp-server traps** command is used to enable SNMP extended traps. To disable the sending of SNMP extended traps, please use **no snmp-server traps** command.

### Syntax

**snmp-server traps** { bandwidth-control | cpu | flash | lldp | loopback-detection | storm-control | spanning-tree | memory }

**no snmp-server traps** { bandwidth-control | cpu | flash | lldp | loopback-detection | storm-control | spanning-tree | memory }

### Parameter

bandwidth-control — Enable bandwidth-control trap. It is sent when the rate limit function is enabled and the bandwidth exceeds the predefined value.

cpu — Allow CPU-related trap. It is sent when CPU usage exceeds the predefined threshold. By default, the CPU usage threshold of the switch is 80%.

flash — Enable flash trap. It is sent when flash is modified during operations such as backup, reset, firmware upgrade, configuration import, etc.

lldp — Enable lldp trap. It is sent when the port's neighbor changes.

loopback-detection — Enable loopback-detection trap. It is sent when the switch detects loopback or loopback is cleared.

storm-control — Enable storm-control trap. It is sent when the multicast or broadcast rate exceeds the predefined value.

spanning-tree — Enable spanning-tree trap. It is sent when the port forwarding status changes or the port receives TCN packet or packet with TC fport-channel-.

memory — Enable memory trap. It is sent when memory usage exceeds 80%.

### Command Mode

Global Configuration Mode

### Privilege Requirement

Only Admin level users have access to these commands.

### Example

Enable SNMP extended bandwidth-control trap for the switch:

```
T1700X-16TS(config)# snmp-server traps bandwidth-control
```

## 29.11 snmp-server traps vlan

### Description

The **snmp-server traps vlan** command is used to enable SNMP extended VLAN-related traps which include two types: create and delete. To disable this function, please use **no snmp-server traps vlan** command.

### Syntax

```
snmp-server traps vlan [ create | delete ]
```

```
no snmp-server traps vlan [create | delete ]
```

### Parameter

create — Enable VLAN-created trap. It is sent when new VLAN is created successfully.

delete — Enable VLAN-deleted traps. It is sent when VLAN is deleted successfully.

### Command Mode

Global Configuration Mode

### Privilege Requirement

Only Admin level users have access to these commands.

### Example

Enable all SNMP extended VLAN-related traps for the switch:

```
T1700X-16TS(config)# snmp-server traps vlan
```

Enable VLAN-created trap only for the switch:

```
T1700X-16TS(config)# snmp-server traps vlan create
```

## 29.12 rmon history

### Description

The **rmon history** command is used to configure the history sample entry. To return to the default configuration, please use **no rmon history** command. RMON (Remote Monitoring), basing on SNMP architecture, functions to monitor the network. History Group is one of the commonly used RMON Groups. After a history group is configured, the switch collects network statistics information periodically, based on which the management station can monitor network effectively.

### Syntax

```
rmon history index interface ten-gigabitEthernet port [ interval seconds ]  
[ owner owner-name ] [ buckets number ]  
no rmon history index
```

### Parameter

*index* — The index number of the entry, ranging from 1 to 12, in the format of 1-3,5.

*port* — The Ethernet port number.

*seconds* — The interval to take samplings from the port, ranging from 10 to 3600 in seconds. By default, it is 1800.

*owner-name* — The owner of the history sample entry, ranging from 1 to 16 characters. By default, it is "monitor".

*number* — The maximum number of buckets desired for the RMON history group of statistics, ranging from 1 to 130. The default is 50 buckets.

### Command Mode

Global Configuration Mode

### Privilege Requirement

Only Admin level users have access to these commands.

### Example

Configure the sample port as Gi1/0/2 and the sample interval as 100 seconds for the entry 1-3:

```
T1700X-16TS(config)# rmon history 1-3 interface ten-gigabitEthernet 1/0/2
interval 100 owner owner1
```

## 29.13 rmon event

### Description

The **rmon event** command is used to configure the entries of SNMP-RMON Event. To return to the default configuration, please use **no rmon event** command. Event Group, as one of the commonly used RMON Groups, is used to define RMON events. Alarms occur when an event is detected.

### Syntax

```
rmon event index [ user user-name ] [ description descript ] [ type { none | log  
| notify | log-notify } ] [ owner owner-name ]
```

```
no rmon event index
```

### Parameter

*index* — The index number of the event entry, ranging from 1 to 12. You can only select one entry for each command.

*user-name* — The name of the User to which the event belongs, ranging from 1 to 16 characters. By default, it is “public”.

*descript* — The description of the event, ranging from 1 to 16 characters. By default, it is empty.

*type* — The event type, with none, log, notify and both options. None indicates no processing, log indicates logging the event, notify indicates sending trap messages to the management station, and both indicates logging the event and sending trap messages to the management station.

*owner-name* — The owner of the event entry, ranging from 1 to 16 characters. By default, it is “monitor”.

### Command Mode

Global Configuration Mode

### Privilege Requirement

Only Admin level users have access to these commands.

### Example

Configure the user name of entry 1, 2, 3 and 4 as user1, the description of the event as description1, the type of event as log and the owner of the event as owner1:

```
T1700X-16TS(config)# rmon event 1-4 user user1 description description1
type log owner owner1
```

## 29.14 rmon alarm

### Description

The **rmon alarm** command is used to configure SNMP-RMON Alarm Management. To return to the default configuration, please use **no rmon alarm** command. Alarm Group is one of the commonly used RMON Groups. RMON alarm management allows monitoring the specific alarm variables. When the value of a monitored variable exceeds the threshold, an alarm event is generated, which triggers the switch to act in the set way.

### Syntax

```
rmon alarm index { stats-index sindex } [ alarm-variable { revbyte | revpkt |
bpkt | mpkt | crc-lign | undersize | oversize | jabber | collision | 64 | 65-127 |
128-511 | 512-1023 | 1024-10240 } ] [ s-type { absolute | delta } ]
[ rising-threshold r-hold ] [ rising-event-index r-event] [ falling-threshold
f-hold] [ falling-event-index f-event] [ a-type {rise | fall | all} ] [ owner
owner-name ] [ interval interval]
```

```
no rmon alarm index
```

### Parameter

*index* — The index number of the Alarm Management entry, ranging from 1 to 12, in the format of 1-3,5.

*sindex* — Specify the statistics index.

alarm-variable — The alarm variable. By default, the option is revbyte.

s-type — Sample Type, which is the sampling method for the selected variable and comparing the value against the thresholds. There are two options, absolute and delta. Absolute indicates comparing the values directly with the thresholds at the end of the sampling interval. Delta indicates subtracting the last sampled value from the current value, and then comparing the difference in the values with the threshold. By default, the Sample Type is absolute.

*r-hold* — The rising counter value that triggers the Rising Threshold alarm, ranging from 1 to 2147483647. By default, it is 100.

*r-event* — Rise Event, which is the index of the corresponding event which will be triggered if the sampled value is larger than the Rising Threshold. It ranges from 1 to 12.

*f-hold* — The falling counter value that triggers the Falling Threshold alarm, ranging from 1 to 2147483647. By default, it is 100.

*f-event* — Fall Event, which is the index of the corresponding event which will be triggered if the sampled value is lower than the Falling Threshold. It ranges from 1 to 12.

*a-type* — Alarm Type, with rise, fall and all options. Rise indicates that the alarm event will be triggered when the sampled value exceeds the Rising Threshold, fall indicates that the alarm event will be triggered when the sampled value is under the Falling Threshold, and all indicates that the alarm event will be triggered either the sampled value exceeds the Rising Threshold or is under the Falling Threshold. By default, the Alarm Type is all.

*owner-name* — The owner of the entry, ranging from 1 to 16 characters. By default, it is monitor.

*interval* — The alarm interval time, ranging from 10 to 3600 in seconds. By default, it is 1800.

## Command Mode

Global Configuration Mode

## Privilege Requirement

Only Admin level users have access to these commands.

## Example

Configure rmon alarm entries 1-3 binding with statistics entry 2, the owners as owner1 and the alarm intervals as 100 seconds:

```
T1700X-16TS(config)#rmon alarm 1-3 stats-index 2 owner owner1 interval
100
```

## 29.15 rmon statistics

### Description

The **rmon statistics** command is used to configure the entries of SNMP-RMON statistics. To delete the corresponding entry, please use **no rmon statistics** command. The maximum supported entries are 1000.

### Syntax

```
rmon statistics index interface ten-gigabitEthernet port [ owner owner-name ]
[ status { underCreation | valid } ]
no rmon statistics index
```

## Parameter

*index* — The index number of the statistics entry, ranging from 1 to 65535, in the format of 1-3,5.

*port* — The statistics port number, in the format of 1/0/1.

*owner-name* — The creator of the event entry, ranging from 1 to 16 characters. By default, it is “monitor”.

*status* — The status of the statistics entry, either “underCreation” or “valid”. “underCreation” means this entry won’t take effect until it is modified to “valid”; “valid” means this entry takes effect immediately after it is created.

## Command Mode

Global Configuration Mode

## Privilege Requirement

Only Admin level users have access to these commands.

## Example

Configure the statistics entries 1-3 with the statistics port as 1/0/1, owner as owner1 and status as valid:

```
T1700X-16TS(config)#rmon statistics 1-3 interface ten-gigabitEthernet  
1/0/1 owner owner1 status valid
```

## 29.16 show snmp-server

### Description

The **show snmp-server** command is used to display SNMP configuration globally.

### Syntax

```
show snmp-server
```

### Command Mode

Privileged EXEC Mode and Any Configuration Mode

### Privilege Requirement

Only Admin level users have access to these commands.

### Example

Display SNMP configuration globally:

```
T1700X-16TS# show snmp-server
```

## 29.17 show snmp-server view

### Description

The **show snmp-server view** command is used to display the View table.

### Syntax

```
show snmp-server view
```

### Command Mode

Privileged EXEC Mode and Any Configuration Mode

### Privilege Requirement

Only Admin level users have access to these commands.

### Example

Display the View table:

```
T1700X-16TS# show snmp-server view
```

## 29.18 show snmp-server group

### Description

The **show snmp-server group** command is used to display the Group table.

### Syntax

```
show snmp-server group
```

### Command Mode

Privileged EXEC Mode and Any Configuration Mode

### Privilege Requirement

Only Admin level users have access to these commands.

### Example

Display the Group table:

```
T1700X-16TS# show snmp-server group
```

## 29.19 show snmp-server user

### Description

The **show snmp-server user** command is used to display the User table.



### Syntax

```
show snmp-server user
```

### Command Mode

Privileged EXEC Mode and Any Configuration Mode

### Privilege Requirement

Only Admin level users have access to these commands.

### Example

Display the User table:

```
T1700X-16TS# show snmp-server user
```

## 29.20 show snmp-server community

### Description

The **show snmp-server community** command is used to display the Community table.

### Syntax

```
show snmp-server community
```

### Command Mode

Privileged EXEC Mode and Any Configuration Mode

### Privilege Requirement

Only Admin level users have access to these commands.

### Example

Display the Community table:

```
T1700X-16TS# show snmp-server community
```

## 29.21 show snmp-server host

### Description

The **show snmp-server host** command is used to display the Host table.

### Syntax

```
show snmp-server host
```

### Command Mode

Privileged EXEC Mode and Any Configuration Mode

## Privilege Requirement

Only Admin level users have access to these commands.

## Example

Display the Host table:

```
T1700X-16TS# show snmp-server host
```

## 29.22 show snmp-server engineID

### Description

The **show snmp-server engineID** command is used to display the engineID of the SNMP.

### Syntax

```
show snmp-server engineID
```

### Command Mode

Privileged EXEC Mode and Any Configuration Mode

### Privilege Requirement

Only Admin level users have access to these commands.

### Example

Display the engineID:

```
T1700X-16TS# show snmp-server engineID
```

## 29.23 show rmon history

### Description

The **show rmon history** command is used to display the configuration of the history sample entry.

### Syntax

```
show rmon history [ index ]
```

### Parameter

*index* — The index number of the entry selected to display the configuration, ranging from 1 to 12, in the format of 1-3, 5. You can select more than one entry for each command. By default, the configuration of all history sample entries is displayed.

### Command Mode

Privileged EXEC Mode and Any Configuration Mode

### Privilege Requirement

Only Admin level users have access to these commands.

### Example

Display the configuration of all history sample entries:

```
T1700X-16TS# show rmon history
```

## 29.24 show rmon event

### Description

The **show rmon event** command is used to display the configuration of SNMP-RMON Event.

### Syntax

```
show rmon event [ index ]
```

### Parameter

*index* — The index number of the entry selected to display the configuration, ranging from 1 to 12, in the format of 1-3, 5. You can select more than one entry for each command. By default, the configuration of all SNMP-RMON enabled entries is displayed.

### Command Mode

Privileged EXEC Mode and Any Configuration Mode

### Privilege Requirement

Only Admin level users have access to these commands.

### Example

Display the Event configuration of entry1-4:

```
T1700X-16TS# show rmon event 1-4
```

## 29.25 show rmon alarm

### Description

The **show rmon alarm** command is used to display the configuration of the Alarm Management entry.

## Syntax

```
show rmon alarm [ index ]
```

## Parameter

*index* — The index number of the entry selected to display the configuration, ranging from 1 to 12, in the format of 1-3, 5. You can select more than one entry for each command. By default, the configuration of all Alarm Management entries is displayed.

## Command Mode

Privileged EXEC Mode and Any Configuration Mode

## Privilege Requirement

Only Admin level users have access to these commands.

## Example

Display the configuration of the Alarm Management entry 1-2:

```
T1700X-16TS# show rmon alarm 1-2
```

## 29.26 show rmon statistics

### Description

The **show rmon statistics** command is used to display the configuration of the specified statistics entry.

### Syntax

```
show rmon statistics [ index ]
```

### Parameter

*index* — The index number of the statistics entry selected to display the configuration, ranging from 1 to 65535. By default, the configuration of all statistics entries is displayed.

### Command Mode

Privileged EXEC Mode and Any Configuration Mode

### Privilege Requirement

Only Admin level users have access to these commands.

### Example

Display the configuration of the statistics entry 1:

```
T1700X-16TS#show rmon statistics 1
```

# Chapter 30 LLDP Commands

LLDP function enables network devices to advertise their own device information periodically to neighbors on the same LAN. The information of the LLDP devices in the LAN can be stored by its neighbor in a standard MIB, so it is possible for the information to be accessed by a Network Management System (NMS) such as SNMP.

## 30.1 Ildp

### Description

The **lldp** command is used to enable LLDP function. To disable the LLDP function, please use **no lldp** command.

### Syntax

**lldp**

**no lldp**

### Command Mode

Global Configuration Mode

### Privilege Requirement

Only Admin, Operator and Power User level users have access to these commands.

### Example

Enable LLDP function globally:

```
T1700X-16TS(config)#lldp
```

## 30.2 Ildp hold-multiplier

### Description

The **lldp hold-multiplier** command is used to configure the Hold Multiplier parameter. The aging time of the local information in the neighbor device is determined by the actual TTL value used in the sending LLDPDU.  $TTL = Hold\ Multiplier * Transmit\ Interval$ . To return to the default configuration, please use **no lldp hold-multiplier** command.

### Syntax

**lldp hold-multiplier** *multiplier*

**no lldp hold-multiplier**

### Parameter

*multiplier* — Configure the Hold Multiplier parameter. It ranges from 2 to 10.  
By default, it is 4.

### Command Mode

Global Configuration Mode

### Privilege Requirement

Only Admin, Operator and Power User level users have access to these commands.

### Example

Specify Hold Multiplier as 5:

```
T1700X-16TS(config)#lldp hold-multiplier 5
```

## 30.3 lldp timer

### Description

The **lldp timer** command is used to configure the parameters about transmission. To return to the default configuration, please use **no lldp timer** command.

### Syntax

```
lldp timer { tx-interval tx-interval | tx-delay tx-delay | reinit-delay reinit-delay |  
notify-interval notify-interval | fast-count fast-count }
```

```
no lldp timer { tx-interval | tx-delay | reinit-delay | notify-interval | fast-count }
```

### Parameter

*tx-interval* — Configure the interval for the local device to transmit LLDPDU to its neighbors. The value ranges from 5 to 32768 and the default value is 30 seconds.

*tx-delay* — Configure a value from 1 to 8192 in seconds to specify the time for the local device to transmit LLDPDU to its neighbors after changes occur so as to prevent LLDPDU being sent frequently. By default, it is 2 seconds.

*reinit-delay* — This parameter indicates the amount of delay from when LLDP status becomes "disable" until re-initialization will be attempted. The value ranges from 1 to 10 and the default value is 3.

*notify-interval* — Specify the interval of Trap message which will be sent from local device to network management system. The value ranges from 5 to 3600 and the default value is 5 seconds.

*fast-count* — When the port's LLDP state transforms from Disable (or Rx\_Only) to Tx&Rx (or Tx\_Only), the fast start mechanism will be enabled, that is, the transmit interval will be shorten to a second, and several LLDPDUs will be sent out (the number of LLDPDUs equals this parameter). The value ranges from 1 to 10 and the default value is 3.

### Command Mode

Global Configuration Mode

### Privilege Requirement

Only Admin, Operator and Power User level users have access to these commands.

### Example

Specify the Transmit Interval of LLDPDU as 45 seconds and Trap message to NMS as 120 seconds:

```
T1700X-16TS(config)#lldp timer tx-interval 45
```

```
T1700X-16TS(config)#lldp timer notify-interval 120
```

## 30.4 Ildp receive

### Description

The **lldp receive** command is used to enable the designated port to receive LLDPDU. To disable the function, please use **no lldp receive** command.

### Syntax

**lldp receive**

**no lldp receive**

### Command Mode

Interface Configuration Mode (interface ten-gigabitEthernet / interface range ten-gigabitEthernet)

### Privilege Requirement

Only Admin, Operator and Power User level users have access to these commands.

### Example

Enable Gigabit Ethernet port 1/0/1 to receive LLDPDU:

```
T1700X-16TS(config)#interface ten-gigabitEthernet 1/0/1
T1700X-16TS(config-if)#lldp receive
```

## 30.5 lldp transmit

### Description

The **lldp transmit** command is used to enable the designated port to transmit LLDPDU. To disable the function, please use **no lldp transmit** command.

### Syntax

```
lldp transmit
no lldp transmit
```

### Command Mode

Interface Configuration Mode (interface ten-gigabitEthernet / interface range ten-gigabitEthernet)

### Privilege Requirement

Only Admin, Operator and Power User level users have access to these commands.

### Example

Enable Gigabit Ethernet port 1/0/1 to transmit LLDPDU:

```
T1700X-16TS(config)# interface ten-gigabitEthernet 1/0/1
T1700X-16TS(config-if)#lldp transmit
```

## 30.6 lldp snmp-trap

### Description

The **lldp snmp-trap** command is used to enable the port's SNMP notification. If enabled, the port will notify the trap event to network management system. To disable the ports' SNMP notification, please use **no lldp snmp-trap** command.

### Syntax

```
lldp snmp-trap
no lldp snmp-trap
```

### Command Mode

Interface Configuration Mode (interface ten-gigabitEthernet / interface range ten-gigabitEthernet)



## Privilege Requirement

Only Admin, Operator and Power User level users have access to these commands.

## Example

Enable the SNMP notification for Gigabit Ethernet port 1/0/1:

```
T1700X-16TS(config)#interface ten-gigabitEthernet 1/0/1
T1700X-16TS(config-if)#lldp snmp-trap
```

# 30.7 lldp tlv-select

## Description

The **lldp tlv-select** command is used to configure TLVs to be included in outgoing LLDPDU. To exclude TLVs, please use **no lldp tlv-select** command. By default, All TLVs are included in outgoing LLDPDU.

## Syntax

```
lldp tlv-select { [ port-description ] [ system-capability ] [ system-description ]
[ system-name ] [ management-address ] [ port-vlan ] [ protocol-vlan ]
[ vlan-name ] [ link-aggregation ] [ mac-phy-cfg ] [ max-frame-size ] [ power ]
[ all ] }
```

```
no lldp tlv-select { [ port-description ] [ system-capability ] [ system-description ]
[ system-name ] [ management-address ] [ port-vlan ] [ protocol-vlan ]
[ vlan-name ] [ link-aggregation ] [ mac-phy-cfg ] [ max-frame-size ] [ power ]
[ all ] }
```

## Command Mode

Interface Configuration Mode (interface ten-gigabitEthernet / interface range ten-gigabitEthernet)

## Privilege Requirement

Only Admin, Operator and Power User level users have access to these commands.

## Example

Exclude “management-address” and “port-vlan-id” TLVs in LLDPDU outgoing from Gigabit Ethernet port 1/0/1:

```
T1700X-16TS(config)# interface ten-gigabitEthernet 1/0/1
T1700X-16TS(config-if)# no lldp tlv-select management-address port-vlan
```

## 30.8 Ildp med-fast-count

### Description

The **ildp med-fast-count** command is used to configure the number of the LLDP-MED frames that will be sent out. When LLDP-MED fast start mechanism is activated, multiple LLDP-MED frames will be transmitted based on this parameter. The default value is 4. To return to the default configuration, please use **no ildp med-fast-count** command.

### Syntax

**ildp med-fast-count** *count*

**no ildp med-fast-count**

### Parameter

*count* — Configure the Fast Start Count parameter. It ranges from 1 to 10. By default, it is 4.

### Command Mode

Global Configuration Mode

### Privilege Requirement

Only Admin and Operator level users have access to these commands.

### Example

Specify Fast Start Count as 5:

```
T1700X-16TS(config)# ildp med-fast-count 5
```

## 30.9 Ildp med-status

### Description

The **ildp med-status** command is used to enable the LLDP-MED feature for the corresponding port. After the LLDP-MED feature is enabled, the port's Admin Status will be changed to Tx&Rx. To disable the LLDP-MED feature for the corresponding port, please use **no ildp med-status** command.

### Syntax

**ildp med-status**

**no ildp med-status**

## Command Mode

Interface Configuration Mode (interface ten-gigabitEthernet / interface range ten-gigabitEthernet)

## Privilege Requirement

Only Admin, Operator and Power User level users have access to these commands.

## Example

Enable the LLDP-MED feature for port 1/0/2:

```
T1700X-16TS(config)# interface ten-gigabitEthernet 1/0/2
T1700X-16TS(config-if)# lldp med-status
```

## 30.10 lldp med-tlv-select

### Description

The **lldp med-tlv-select** command is used to configure LLDP-MED TLVs to be included in outgoing LLDPDU for the corresponding port. To exclude LLDP-MED TLVs, please use **no lldp med-tlv-select** command. By default, All TLVs are included in outgoing LLDPDU.

### Syntax

```
lldp med-tlv-select { [inventory-management] [location] [network-policy]
[power-management] [all] }
```

```
no lldp med-tlv-select { [inventory-management] [location] [network-policy]
[power-management] [all] }
```

## Command Mode

Interface Configuration Mode (interface ten-gigabitEthernet / interface range ten-gigabitEthernet)

## Privilege Requirement

Only Admin, Operator and Power User level users have access to these commands.

## Example

Exclude “network policy” and “inventory” TLVs in LLDPDU outgoing from port 1/0/2:

```
T1700X-16TS(config)# interface ten-gigabitEthernet 1/0/2
```

```
T1700X-16TS(config-if)# no lldp med-tlv-select network-policy inventory-  
management
```

## 30.11 lldp med-location

### Description

The lldp med-location command is used to configure the Location Identification TLV's content in outgoing LLDPDU of the port.

### Syntax

```
lldp med-location { emergency-number identifier | civic-address [ [ language  
language ] [ province-state province-state ] [ county county] [city city ] [ street  
street ] [ house-number house-number ] [name name ] [ postal-zipcode  
postal-zipcode ] [ room-number room-number ] [ post-office-box post-office-box ]  
[ additional additional ] [ country-code country-code ] [ what { dhcp-server |  
endpoint | switch } ] ] }
```

### Parameter

emergency-number — Emergency Call Service ELIN identifier, which is used during emergency call setup to a traditional CAMA or ISDN trunk-based PSAP. The length of this field ranges from 10 to 25 characters.

civic-address — The civic address is defined to reuse the relevant sub-fields of the DHCP option for civic Address based Location Configuration Information as specified by IETF.

### Command Mode

Interface Configuration Mode (interface ten-gigabitEthernet / interface range ten-gigabitEthernet)

### Privilege Requirement

Only Admin, Operator and Power User level users have access to these commands.

### Example

Configure the civic address in the Location Identification TLV's content in outgoing LLDPDU of port 1/0/2. Configure the language as English and city as London:

```
T2700-28TQ (config)# interface ten-gigabitEthernet 1/0/2
```

```
T2700-28TQ(config-if)# lldp med-location civic-address language English
city London
```

## 30.12 show lldp

### Description

The **show lldp** command is used to display the global configuration of LLDP.

### Syntax

```
show lldp
```

### Command Mode

Privileged EXEC Mode and Any Configuration Mode

### Privilege Requirement

None.

### Example

Display the global configuration of LLDP:

```
T1700X-16TS#show lldp
```

## 30.13 show lldp interface

### Description

The **show lldp interface** command is used to display LLDP configuration of the corresponding port. By default, the LLDP configuration of all the ports will be displayed.

### Syntax

```
show lldp interface [ ten-gigabitEthernet port ]
```

### Parameters

*port* — The Ethernet port number.

### Command Mode

Privileged EXEC Mode and Any Configuration Mode

### Privilege Requirement

None.

## Example

Display the LLDP configuration of port 1/0/1:

```
T1700X-16TS#show lldp interface ten-gigabitEthernet 1/0/1
```

## 30.14 show lldp local-information interface

### Description

The **show lldp local-information interface** command is used to display the LLDP information of the corresponding port. By default, the LLDP information of all the ports will be displayed.

### Syntax

```
show lldp local-information interface [ ten-gigabitEthernet port ]
```

### Parameters

*port* — The Ethernet port number.

### Command Mode

Privileged EXEC Mode and Any Configuration Mode

### Privilege Requirement

None.

### Example

Display the LLDP information of port 1/0/1:

```
T1700X-16TS#show lldp local-information interface ten-gigabitEthernet  
1/0/1
```

## 30.15 show lldp neighbor-information interface

### Description

The **show lldp neighbor-information interface** command is used to display the neighbor information of the corresponding port. By default, the neighbor information of all the ports will be displayed.

### Syntax

```
show lldp neighbor-information interface [ ten-gigabitEthernet port ]
```

## Parameters

*port* — The Ethernet port number.

## Command Mode

Privileged EXEC Mode and Any Configuration Mode

## Privilege Requirement

None.

## Example

Display the neighbor information of port 1/0/1:

```
T1700X-16TS#show lldp neighbor-information interface
ten-gigabitEthernet 1/0/1
```

# 30.16 show lldp traffic interface

## Description

The **show lldp traffic interface** command is used to display the LLDP statistic information between the local device and neighbor device of the corresponding port. By default, the LLDP statistic information of all the ports will be displayed.

## Syntax

```
show lldp traffic interface [ ten-gigabitEthernet port ]
```

## Parameters

*port* — The Ethernet port number.

## Command Mode

Privileged EXEC Mode and Any Configuration Mode

## Privilege Requirement

None.

## Example

Display the LLDP statistic information of port 1/0/1:

```
T1700X-16TS#show lldp traffic interface ten-gigabitEthernet 1/0/1
```

# Chapter 31 ARP Commands

Address Resolution Protocol (ARP) is used to resolve an IP address into an Ethernet MAC address. The switch maintains an ARP mapping table to record the IP-to-MAC mapping relations, which is used for forwarding packets. An ARP mapping table contains two types of ARP entries: dynamic and static. An ARP dynamic entry is automatically created and maintained by ARP. A static ARP entry is manually configured and maintained.

## 31.1 arp

### Description

This **arp** command is used to add a static ARP entry. To delete the specified ARP entry, please use the **no arp** command.

### Syntax

```
arp ip mac type  
no arp ip type
```

### Parameter

*ip* — The IP address of the static ARP entry.  
*mac* — The MAC address of the static ARP entry.  
*type* — The ARP type. Configure it as “arpa”.

### Command Mode

Global Configuration Mode

### Privilege Requirement

Only Admin, Operator and Power User level users have access to these commands.

### Example

Create a static ARP entry with the IP as 192.168.0.1 and the MAC as 00:11:22:33:44:55:

```
T1700X-16TS(config)# arp 192.168.0.1 00:11:22:33:44:55 arpa
```



## 31.2 clear arp-cache

### Description

This **clear arp-cache** command is used to clear all the dynamic ARP entries.

### Syntax

```
clear arp-cache
```

### Command Mode

Privileged EXEC Mode

### Privilege Requirement

Only Admin, Operator and Power User level users have access to these commands.

### Example

Clear all the dynamic ARP entries:

```
T1700X-16TS(config)# clear arp-cache
```

## 31.3 arp timeout

### Description

This **arp timeout** command is used to configure the ARP aging time of the interface.

### Syntax

```
arp timeout timeout
```

```
no arp timeout
```

### Parameter

*timeout* — Specify the aging time, ranging from 1 to 3000 seconds. The default value is 600 seconds.

### Command Mode

Interface Configuration Mode (interface ten-gigabitEthernet / interface range ten-gigabitEthernet)

### Privilege Requirement

Only Admin, Operator and Power User level users have access to these commands.

## Example

Configure the ARP aging time as 60 seconds on interface 1/0/1:

```
T1700X-16TS(config)# interface ten-gigabitEthernet 1/0/1
T1700X-16TS(config-if)# arp timeout 60
```

## 31.4 show arp

### Description

This **show arp** command is used to display the active ARP entries. If no parameter is specified, all the active ARPA entries will be displayed.

### Syntax

```
show arp [ ip ] [ mac ]
show ip arp [ ip ] [ mac ]
```

### Parameter

*ip* — Specify the IP address of your desired ARP entry.

*mac* — Specify the MAC address of your desired ARP entry.

### Command Mode

Privileged EXEC Mode and Any Configuration Mode

### Privilege Requirement

None.

### Example

Display the ARP entry with the IP as 192.168.0.2:

```
T1700X-16TS(config)# show ip arp 192.168.0.2
```

## 31.5 show ip arp (interface)

### Description

This **show ip arp** command is used to display the active ARP entries associated with a specified Layer 3 interface.

### Syntax

```
show ip arp { ten-gigabitEthernet port | port-channel lagid | vlan id }
```

### Parameter

*port* — Specify the number of the routed port.

*lagid* — Specify the ID of the LAG.

*id* — Specify the VLAN interface ID.

### Command Mode

Privileged EXEC Mode and Any Configuration Mode

### Privilege Requirement

None.

### Example

Display the ARP entry associated with VLAN interface 2 :

```
T1700X-16TS(config)# show ip arp vlan 2
```

## 31.6 show ip arp summary

### Description

This **show ip arp summary** command is used to display the number of the active ARP entries.

### Syntax

```
show ip arp summary
```

### Command Mode

Privileged EXEC Mode and Any Configuration Mode

### Privilege Requirement

None.

### Example

Display the number of the ARP entries:

```
T1700X-16TS(config)# show ip arp summary
```

# Chapter 32 Static Routes Commands

## 32.1 interface vlan

### Description

This **interface vlan** command is used to create the VLAN interface. To delete the specified VLAN interface, please use the **no interface vlan** command.

### Syntax

```
interface vlan { vid }  
no interface vlan { vid }
```

### Parameter

*vid* — The ID of the VLAN.

### Command Mode

Global Configuration Mode

### Privilege Requirement

Only Admin, Operator and Power User level users have access to these commands.

### Example

Create the VLAN interface 2:

```
T1700X-16TS(config)# interface vlan 2
```

## 32.2 interface loopback

### Description

This **interface loopback** command is used to create the loopback interface. To delete the specified loopback interface, please use the **no interface loopback** command.

### Syntax

```
interface loopback { id }  
no interface loopback { id }
```

## Parameter

*id* — The ID of the loopback interface, ranging from 1 to 64.

## Command Mode

Global Configuration Mode

## Privilege Requirement

Only Admin, Operator and Power User level users have access to these commands.

## Example

Create the loopback interface 1:

```
T1700X-16TS(config)# interface loopback 1
```

## 32.3 switchport

### Description

This **switchport** command is used to switch the Layer 3 interface into the Layer 2 port. To switch the Layer 2 port into the Layer 3 routed port, please use the **no switchport** command.

### Syntax

**switchport**

**no switchport**

### Command Mode

Interface Configuration Mode (interface ten-gigabitEthernet / interface range ten-gigabitEthernet / interface port-channel / interface range port-channel)

### Privilege Requirement

Only Admin, Operator and Power User level users have access to these commands.

### Example

Switch the gigabitEthernet port 1/0/9 into the routed port:

```
T1700X-16TS(config)# interface ten-gigabitEthernet 1/0/9  
T1700X-16TS(config-if)# no switchport
```

## 32.4 interface range port-channel

### Description

This **interface range port-channel** command is used to create multiple port-channel interfaces.

### Syntax

```
interface range port-channel port-channel-list
```

### Parameter

*port-channel-list* — The list of the port-channel interface, ranging from 1 to 14, in the format of 1-3, 5.

### Command Mode

Global Configuration Mode

### Privilege Requirement

Only Admin, Operator and Power User level users have access to these commands.

### Example

Create the port-channel interfaces 1,3,4 and 5:

```
T1700X-16TS(config)# interface port-channel 1,3-5
```

## 32.5 description

### Description

This **description** command is used to add a description to the Layer 3 interface, including routed port, port-channel interface, loopback interface and VLAN interface. To clear the description of the corresponding interface, please use the **no description** command.

### Syntax

```
description string
```

```
no description
```

### Parameter

*string* — Content of an interface description, ranging from 1 to 32 characters.

## Command Mode

Interface Configuration Mode (interface ten-gigabitEthernet / interface range ten-gigabitEthernet)

## Privilege Requirement

Only Admin, Operator and Power User level users have access to these commands.

## Example

Add a description system-if to the routed port 1/0/9 :

```
T1700X-16TS(config)# interface ten-gigabitEthernet 1/0/9
T1700X-16TS(config-if)# no switchport
T1700X-16TS(config-if)# description system-if
```

# 32.6 shutdown

## Description

This **shutdown** command is used to shut down the specified interface. The interface type include: routed port, port-channel interface, loopback interface and VLAN interface. To enable the specified interface, please use the **no shutdown** command.

## Syntax

```
shutdown
no shutdown
```

## Command Mode

Interface Configuration Mode (interface ten-gigabitEthernet / interface range ten-gigabitEthernet)

## Privilege Requirement

Only Admin, Operator and Power User level users have access to these commands.

## Example

Shut down the routed port 1/0/9 :

```
T1700X-16TS(config)# interface ten-gigabitEthernet 1/0/9
T1700X-16TS(config-if)# no switchport
T1700X-16TS(config-if)# shutdown
```

## 32.7 interface port-channel

### Description

This **interface port-channel** command is used to create the port-channel interface. To delete the specified port-channel interface, please use the **no interface port-channel** command.

### Syntax

```
interface port-channel { port-channel-id }  
no interface port-channel { port-channel-id }
```

### Parameter

*port-channel-id* — The ID of the port-channel interface, ranging from 1 to 14.

### Command Mode

Global Configuration Mode

### Privilege Requirement

Only Admin, Operator and Power User level users have access to these commands.

### Example

Create the port-channel interface 1:

```
T1700X-16TS(config)# interface port-channel 1
```

## 32.8 ip route

### Description

This **ip route** command is configure the static route. To clear the corresponding entry, please use the **no ip route** command.

### Syntax

```
ip route { dest-address } { mask } { next-hop-address } [ distance ]  
no ip route { dest-address } { mask } { next-hop-address }
```

### Parameter

*dest-address* — The destination IP address.

*mask* — The subnet mask.

*next-hop-address* — The address of the next-hop.



*distance* — The distance metric of this route, ranging from 1 to 255. The smaller the distance is, the higher the priority is.

### Command Mode

Global Configuration Mode

### Privilege Requirement

Only Admin, Operator and Power User level users have access to these commands.

### Example

Create a static route with the destination IP address as 192.168.2.0, the subnet mask as 255.255.255.0 and the next-hop address as 192.168.0.2:

```
T1700X-16TS(config)# ip route 192.168.2.0 255.255.255.0 192.168.0.2
```

## 32.9 ipv6 routing

### Description

This **ipv6 routing** command is enable the IPv6 routing feature globally. To disable IPv6 routing, please use the **no ipv6 routing** command.

### Syntax

**ipv6 routing**

**no ipv6 routing**

### Command Mode

Global Configuration Mode

### Privilege Requirement

Only Admin, Operator and Power User level users have access to these commands.

### Example

Enable IPv6 routing globally:

```
T1700X-16TS(config)# ipv6 routing
```

## 32.10 ipv6 route

### Description

This **ipv6 route** command is configure the IPv6 static route. To clear the corresponding entry, please use the **no ipv6 route** command.

### Syntax

```
ipv6 route { ipv6-dest-address } { next-hop-address } [ distance ]
```

```
no ipv6 route { ipv6-dest-address } { next-hop-address }
```

### Parameter

*ipv6-dest-address*—— The IPv6 address of the destination network.

*next-hop-address* —— The IPv6 address of the next-hop.

*distance* —— The distance metric of this route, ranging from 1 to 255. The smaller the distance is, the higher the priority is.

### Command Mode

Global Configuration Mode

### Privilege Requirement

Only Admin, Operator and Power User level users have access to these commands.

### Example

Create a static route with the destination network IP address as 3200::/64 and the next-hop address as 3100::1234:

```
T1700X-16TS(config)# ipv6 route 3200::/64 3100::1234
```

## 32.11 show interface vlan

### Description

The **show interface vlan** command is used to display the information of the specified interface VLAN.

### Syntax

```
show interface vlan vid
```

### Parameter

*vid* —— The VLAN ID.

## Command Mode

Privileged EXEC Mode and Any Configuration Mode

## Privilege Requirement

None.

## Example

Display the information of VLAN 2:

```
T1700X-16TS(config)#show interface vlan 2
```

# 32.12 show ip interface

## Description

This **show ip interface** command is used to display the detailed information of the specified Layer 3 interface.

## Syntax

```
show ip interface [ ten-gigabitEthernet port | port-channel port-channel-id |  
loopback id | vlan vlan-id ]
```

## Parameter

*port* — The port number.

*port-channel-id* — The ID of the port channel. Member ports in this port channel should all be routed ports.

*id* — The loopback interface ID.

*vlan-id* — The VLAN interface ID.

## Command Mode

Privileged EXEC Mode and Any Configuration Mode

## Privilege Requirement

None.

## Example

Display the detailed information of the VLAN interface 2:

```
T1700X-16TS(config)# show ip interface vlan 2
```

## 32.13 show ip interface brief

### Description

This **show ip interface brief** command is used to display the summary information of the Layer 3 interfaces.

### Syntax

```
show ip interface brief
```

### Command Mode

Privileged EXEC Mode and Any Configuration Mode

### Privilege Requirement

None.

### Example

Display the summary information of the Layer 3 interfaces:

```
T1700X-16TS(config)# show ip interface brief
```

## 32.14 show ip route

### Description

This **show ip route** command is used to display the route entries of the specified type.

### Syntax

```
show ip route [ static | connected ]
```

### Parameter

static | connected — Specify the route type. If not specified, all types of route entries will be displayed.

static: The static routes.

connected: The connected routes.

### Command Mode

Privileged EXEC Mode and Any Configuration Mode

### Privilege Requirement

None.

## Example

Display the static routes:

```
T1700X-16TS(config)# show ip route static
```

## 32.15 show ip route specify

### Description

This **show ip route specify** command is used to display the valid routing information to the specified IP address or network segments.

### Syntax

```
show ip route specify { ip } [ mask ] [ longer-prefixes ]
```

### Parameter

*ip* — Specify the destination IP address.

*mask* — Specify the destination IP address together with the parameter *ip*.

**longer-prefixes** — Specify the destination subnets that match the network segment determined by the *ip* and *mask* parameters.

### Command Mode

Privileged EXEC Mode and Any Configuration Mode

### Privilege Requirement

None.

### Example

Display the shortest route to 192.168.0.100:

```
T1700X-16TS(config)# show ip route specify 192.168.0.100
```

Look up the route entry with the destination as 192.168.0.0/24:

```
T1700X-16TS(config)# show ip route specify 192.168.0.0 255.255.255.0
```

Display the routes to all the subnets that belongs to 192.168.0.0/16:

```
T1700X-16TS(config)# show ip route specify 192.168.0.0 255.255.0.0  
longer-prefixes
```

## 32.16 show ip route summary

### Description

This **show ip route summary** command is used to display the summary information of the route entries classified by their sources.

### Syntax

```
show ip route summary
```

### Command Mode

Privileged EXEC Mode and Any Configuration Mode

### Privilege Requirement

None.

### Example

Display the summary information of route entries:

```
T1700X-16TS(config)# show ip route summary
```

## 32.17 show ipv6 interface

### Description

This command is used to display the configured IPv6 information of the management interface, including ipv6 function status, link-local address and global address, IPv6 multicast groups etc.

### Syntax

```
show ipv6 interface
```

### Command Mode

Privileged EXEC Mode and Any Configuration Mode

### Privilege Requirement

None.

### Example

Display the IPv6 information of the management interface:

```
T1700X-16TS(config)# show ipv6 interface
```

## 32.18 show ipv6 route

### Description

This **show ipv6 route** command is used to display the IPv6 route entries of the specified type.

### Syntax

```
show ipv6 route [ static | connected ]
```

### Parameter

static | connected — Specify the route type. If not specified, all types of route entries will be displayed.

static: The static routes.

connected: The connected routes.

### Command Mode

Privileged EXEC Mode and Any Configuration Mode

### Privilege Requirement

None.

### Example

Display the IPv6 static routes:

```
T1700X-16TS(config)# show ipv6 route static
```

## 32.19 show ipv6 route summary

### Description

This **show ipv6 route summary** command is used to display the summary information of the IPv6 route entries classified by their sources.

### Syntax

```
show ipv6 route summary
```

### Command Mode

Privileged EXEC Mode and Any Configuration Mode

### Privilege Requirement

None.

## Example

Display the summary information of IPv6 route entries:

```
T1700X-16TS(config)# show ipv6 route summary
```



## Chapter 33 SDM Template Commands

This chapter describes how to configure the Switch Database Management (SDM) templates to allocate hardware resources on the switch for different uses.

### 33.1 sdm prefer

#### Description

The **sdm prefer** command is used to configure the SDM template. The SDM template is used to allocate system resources to best support the features being used in your application. To return to use the default template, please use the **sdm prefer default** command. The template change will take effect after a reboot.

#### Syntax

```
sdm prefer { default | enterpriseV4 | enterpriseV6 }
```

#### Parameter

default — Specify the SDM template used in the switch as “default”.

enterpriseV4 — Specify the SDM template used in the switch as “enterpriseV4”.

enterpriseV6 — Specify the SDM template used in the switch as “enterpriseV6”.

#### Command Mode

Global Configuration Mode

#### Privilege Requirement

Only Admin level users have access to these commands.

#### Example

Specify the SDM template as enterpriseV4:

```
T1700X-16TS(config)# sdm prefer enterpriseV4
```

## 33.2 show sdm prefer

### Description

The **show sdm prefer** command is used to display resource allocation of the current SDM template in use, or the SDM templates that can be used.

### Syntax

```
show sdm prefer { used | default | enterpriseV4 | enterpriseV6 }
```

### Parameter

used — Display the resource allocation of the template currently in use, and the template that will become active after a reboot.

default — Display the resource allocation of the default template.

enterpriseV4 — Display the resource allocation of the enterpriseV4 template.

enterpriseV6 — Display the resource allocation of the enterpriseV6 template.

### Command Mode

Privileged EXEC Mode and Any Configuration Mode

### Privilege Requirement

Only Admin level users have access to these commands.

### Example

Display the resource allocation of the template currently in use, and the template that will become active after a reboot:

```
T1700X-16TS(config)#show sdm prefer used
```

# Chapter 34 AAA Commands

AAA stands for authentication, authorization and accounting. This feature is used to authenticate users trying to log in to the switch or trying to access the administrative level privilege.

➤ **Applicable Access Application**

The authentication can be applied on the following access applications: Telnet, SSH and HTTP.

➤ **Authentication Method List**

A method list describes the authentication methods and their sequence to authenticate a user. The switch supports Login List for users to gain access to the switch, and Enable List for normal users to gain administrative privileges.

➤ **RADIUS/TACACS+ Server**

User can configure the RADIUS/TACACS+ servers for the connection between the switch and the server.

➤ **Server Group**

User can define the authentication server group with up to several servers running the same secure protocols, either RADIUS or TACACS+. Users can set these servers in a preferable order, which is called the server group list. When a user tries to access the switch, the switch will ask the first server in the server group list for authentication. If no response is received, the second server will be queried, and so on.

## 34.1 aaa enable

### Description

The **aaa enable** command is used to enable the AAA function globally. To disable the AAA function globally, please use the **no aaa enable** command. The global AAA function is disabled by default.

### Syntax

**aaa enable**

**no aaa enable**

### Command Mode

Global Configuration Mode

### Privilege Requirement

Only Admin level users have access to these commands.

### Example

Enable the AAA function globally:

## 34.2 tacacs-server host

### Description

The **tacacs-server host** command is used to configure a new TACACS+ server. To delete the specified TACACS+ server, please use **no tacacs-server host** command.

### Syntax

```
tacacs-server host ip-address [ port port-id ] [ timeout time ] [ key { [ 0 ] string | 7 encrypted-string } ]
```

```
no tacacs-server host ip-address
```

### Parameter

*ip-address* — Specify the IP address of the TACACS+ server.

*port-id* — Specify the server's port number for AAA. By default it is 49.

*time* — Specify the time in seconds the switch waits for the server's response before it times out. The time ranges from 1 to 9 seconds. The default is 5 seconds.

[ 0 ] *string* | 7 *encrypted-string* — 0 and 7 are the encryption type. 0 indicates that an unencrypted key will follow. 7 indicates that a symmetric encrypted key with a fixed length will follow. By default, the encryption type is 0. "*string*" is the shared key for the switch and the authentication servers to exchange messages which contains 31 characters at most. The question marks and spaces are not allowed. "*encrypted-string*" is a symmetric encrypted key with a fixed length, which you can copy from another switch's configuration file. The key or encrypted-key you configured here will be displayed in the encrypted form. Always configure the key as the last item of this command.

### Command Mode

Global Configuration Mode

### Privilege Requirement

Only Admin level users have access to these commands.

### User Guidelines

The TACACS+ servers you configured are added in the server group "tacacs" by default.

## Example

Configure a TACACS+ server with the IP address as 1.1.1.1, TCP port as 1500, timeout as 6 seconds, and the unencrypted key string as 12345.

```
T1700X-16TS(config)# tacacs-server host 1.1.1.1 port 1500 timeout 6 key
12345
```

## 34.3 show tacacs-server

### Description

This **show ip tacacs-server** command is used to display the summary information of the TACACS+ servers.

### Syntax

```
show tacacs-server
```

### Command Mode

Privileged EXEC Mode and Any Configuration Mode

### Privilege Requirement

Only Admin level users have access to these commands.

### Example

Display the information of all the TACACS+ servers:

```
T1700X-16TS(config)# show tacacs-server
```

## 34.4 radius-server host

### Description

The **radius-server host** command is used to configure a new RADIUS server. To delete the specified RADIUS server, please use **no radius-server host** command.

### Syntax

```
radius-server host ip-address [ auth-port port-id ] [ acct-port port-id ]
[ timeout time ] [ retransmit number ] [ key { [ 0 ] string | 7 encrypted-string } ]
no radius-server host ip-address
```

## Parameter

*ip-address* — Specify the IP address of the RADIUS server.

**auth-port** *port-id* — Specify the UDP destination port for authentication requests. By default it is 1812.

**acct-port** *port-id* — Specify the UDP destination port for accounting requests. By default it is 1813.

*time* — Specify the time in seconds the switch waits for the server's response before it times out. The time ranges from 1 to 9 seconds. The default is 5 seconds.

*number* — Specify the number of times a RADIUS request is resent to a server if the server is not responding in time. By default it is 2 times.

[ 0 ] *string* | 7 *encrypted-string* — 0 and 7 are the encryption type. 0 indicates that an unencrypted key will follow. 7 indicates that a symmetric encrypted key with a fixed length will follow. By default, the encryption type is 0. "*string*" is the shared key for the switch and the authentication servers to exchange messages which contains 31 characters at most. The question marks and spaces are not allowed. "*encrypted-string*" is a symmetric encrypted key with a fixed length, which you can copy from another switch's configuration file. The key or encrypted-key you configured here will be displayed in the encrypted form. Always configure the key as the last item of this command.

## Command Mode

Global Configuration Mode

## Privilege Requirement

Only Admin level users have access to these commands.

## User Guidelines

The RADIUS servers you configured are added in the server group "radius" by default.

## Example

Configure a RADIUS server with the IP address as 1.1.1.1, authentication port as 1200, timeout as 6 seconds, retransmit times as 3, and the unencrypted key string as 12345.

```
T1700X-16TS(config)# radius-server host 1.1.1.1 auth-port 1200 timeout 6  
retransmit 3 key 12345
```

## 34.5 show radius-server

### Description

This **show radius-server** command is used to display the summary information of the RADIUS servers.

### Syntax

```
show radius-server
```

### Command Mode

Privileged EXEC Mode and Any Configuration Mode

### Privilege Requirement

Only Admin level users have access to these commands.

### Example

Display the information of all the RADIUS servers:

```
T1700X-16TS(config)# show radius-server
```

## 34.6 aaa group

### Description

This **aaa group** command is used to create AAA server groups to group existing TACACS+/RADIUS servers for authentication. This command puts the switch in the server group subconfiguration mode.

To delete the corresponding AAA group, please use the **no aaa group** command.

### Syntax

```
aaa group { radius | tacacs } group-name  
no aaa group { radius | tacacs } group-name
```

### Parameter

radius | tacacs — Specify the server group type as RADIUS or TACACS+.

group-name — Specify the server group name.

### Command Mode

Global Configuration Mode

## Privilege Requirement

Only Admin level users have access to these commands.

## Example

Create a RADIUS server group with the name radius1:

```
T1700X-16TS(config)# aaa group radius radius1
```

## 34.7 server

### Description

This **server** command is used to add the existing server in the defined server group. To remove the specified server from the server group, please use the **no server** command.

### Syntax

```
server ip-address  
no server ip-address
```

### Parameter

*ip-address* — Specify the server's IP address.

### Command Mode

Server Group Configuration Mode

## Privilege Requirement

Only Admin level users have access to these commands.

## Example

Create the RADIUS server 1.1.1.1 to RADIUS server group "radius1":

```
T1700X-16TS(config)# aaa group radius radius1  
T1700X-16TS(aaa-group)# server 1.1.1.1
```

## 34.8 show aaa group

### Description

This **show aaa group** command is used to display the summary information of the AAA groups. All the servers in this group will be listed if you specify the group name.



## Syntax

```
show aaa group [ group-name ]
```

## Parameter

*group-name* — Specify the server group name.

## Command Mode

Privileged EXEC Mode and Any Configuration Mode

## Privilege Requirement

Only Admin level users have access to these commands.

## Example

Display the information of all the server groups:

```
T1700X-16TS(config)# show aaa group
```

# 34.9 aaa authentication login

## Description

This **aaa authentication login** command is used to configure a login authentication method list. A method list describes the authentication methods and their sequence to authenticate a user. To delete the specified authentication method list, please use the **no aaa authentication login** command.

## Syntax

```
aaa authentication login { method-list } { method1 } [ method2 ] [ method3 ]  
[ method4 ]
```

```
no authentication login method-list
```

## Parameter

*method-list* — Specify the method list name.

*method1*, *method2*, *method3*, *method4* — Specify the authentication methods in order. The next authentication method is tried only if the previous method does not respond, not if it fails.

The preset methods include radius, tacacs, local and none. “radius” means the RADIUS server group “radius”; “tacacs” means the RACACS+ server group “tacacs”; “local” means local username database are used; “none” means no authentication is used for login.

Users can also define new method with the [aaa group](#) command.

## Command Mode

Global Configuration Mode

## Privilege Requirement

Only Admin level users have access to these commands.

## User Guidelines

By default the login authentication method list is “default” with “local” as method1.

## Example

Configure a login authentication method list “list1” with the priority1 method as radius and priority2 method as local:

```
T1700X-16TS(config)# aaa authentication login list1 radius local
```

## 34.10 aaa authentication enable

### Description

This **aaa authentication enable** command is used to configure a privilege authentication method list. A method list describes the authentication methods and their sequence to elevate a user’s privilege. To delete the specified authentication method list, please use the **no aaa authentication enable** command.

### Syntax

```
aaa authentication enable { method-list } { method1 } [ method2 ] [ method3 ]  
[ method4 ]
```

```
no authentication enable method-list
```

### Parameter

*method-list* — Specify the method list name.

*method1, method2, method3, method4* — Specify the authentication methods in order. The next authentication method is tried only if the previous method does not respond, not if it fails.

The preset methods include radius, tacacs, local and none. “radius” means the RADIUS server group “radius”; “tacacs” means the RACACS+ server group “tacacs”; “local” means local username database are used; “none” means no authentication is used for privilege elevation.

Users can also define new method with the [aaa group](#) command.

## Command Mode

Global Configuration Mode

## Privilege Requirement

Only Admin level users have access to these commands.

## User Guidelines

By default the enable authentication method is “default” with “none” as method1.

## Example

Configure a privilege authentication method list “list2” with the priority1 method as radius and priority2 method as local:

```
T1700X-16TS(config)# aaa authenticaiton enable list2 radius local
```

# 34.11 aaa authentication dot1x default

## Description

This **aaa authentication dot1x default** command is used to configure an 802.1X authentication method list. A method list describes the authentication methods for users’ login in 802.1X. To delete the default authentication method list, please use the **no aaa authentication dot1x default** command.

## Syntax

```
aaa authentication dot1x default { method }
```

```
no aaa authentication dot1x default
```

## Parameter

*method* — Specify the method name. Only RADIUS server group is supported, and the default method is server group “radius”.

## Command Mode

Global Configuration Mode

## Privilege Requirement

Only Admin level users have access to these commands.

## Example

Configure the default 802.1X authentication method as “radius1”:

```
T1700X-16TS(config)# aaa authentication dot1x default radius1
```

## 34.12 aaa accounting dot1x default

### Description

This **aaa accounting dot1x default** command is used to configure an 802.1X accounting method list. To delete the default accounting method list, please use the **no aaa accounting dot1x default** command.

### Syntax

```
aaa accounting dot1x default { method }  
no aaa accounting dot1x default
```

### Parameter

*method* — Specify the method name. Only RADIUS server group is supported, and the default method is server group “radius”.

### Command Mode

Global Configuration Mode

### Privilege Requirement

Only Admin level users have access to these commands.

### Example

Configure the default 802.1X accounting method as “radius1”:

```
T1700X-16TS(config)# aaa accounting dot1x default radius1
```

## 34.13 show aaa authentication

### Description

This **show aaa authentication** command is used to display the summary information of the authentication login, enable and dot1x method list.

### Syntax

```
show aaa authentication [ login | enable | dot1x ]
```

### Parameter

login | enable | dot1x — Specify the method list type.

### Command Mode

Privileged EXEC Mode and Any Configuration Mode

## Privilege Requirement

Only Admin level users have access to these commands.

## Example

Display the information of all the authentication method lists:

```
T1700X-16TS(config)# show aaa authentication
```

## 34.14 show aaa accounting

### Description

This **show aaa accounting** command is used to display the summary information of the accounting method list.

### Syntax

```
show aaa accounting [ dot1x ]
```

### Parameter

dot1x — Specify the method list type.

### Command Mode

Privileged EXEC Mode and Any Configuration Mode

## Privilege Requirement

Only Admin level users have access to these commands.

## Example

Display the information of the default 802.1X accounting method list:

```
T1700X-16TS(config)# show aaa accounting
```

## 34.15 line telnet

### Description

The **line telnet** command is used to enter the Line Configuration Mode to configure the telnet terminal line to which you want to apply the authentication list.

### Syntax

```
line telnet
```

## Command Mode

Global Configuration Mode

## Privilege Requirement

Only Admin level users have access to these commands.

## Example

Enter the telnet terminal line configuration mode:

```
T1700X-16TS(config)#line telnet
```

# 34.16 login authentication(telnet)

## Description

The **login authentication** command is used to apply the login authentication method list to the telnet terminal line. To restore to the default authentication method list, please use the **no login authentication** command.

## Syntax

```
login authentication { method-list }
```

```
no login authentication
```

## Parameter

*method-list* — Specify the login method list on the telnet terminal line. It is “default” by default, which contains the method “local”.

## Command Mode

Line Configuration Mode

## Privilege Requirement

Only Admin level users have access to these commands.

## Example

Configure the login authentication method list on the telnet terminal line as “list1”:

```
T1700X-16TS(config)#line telnet
```

```
T1700X-16TS(config-line)# login authentication list1
```

## 34.17 line ssh

### Description

The **line ssh** command is used to enter the Line Configuration Mode to configure the ssh terminal line to which you want to apply the authentication list.

### Syntax

```
line ssh
```

### Command Mode

Global Configuration Mode

### Privilege Requirement

Only Admin level users have access to these commands.

### Example

Enter the ssh terminal line configuration mode:

```
T1700X-16TS(config)#line ssh
```

## 34.18 login authentication(ssh)

### Description

The **login authentication** command is used to apply the login authentication method list to the ssh terminal line. To restore to the default authentication method list, please use the **no login authentication** command.

### Syntax

```
login authentication { method-list }
```

```
no login authentication
```

### Parameter

*method-list* — Specify the login method list on the ssh terminal line. It is “default” by default, which contains the method “local”.

### Command Mode

Line Configuration Mode

### Privilege Requirement

Only Admin level users have access to these commands.

## Example

Configure the login authentication method list on the ssh terminal line as “list1”:

```
T1700X-16TS(config)# line ssh
T1700X-16TS(config-line)# login authentication list1
```

## 34.19 enable authentication(telnet)

### Description

The **enable authentication** command is used to apply the privilege authentication method list to the telnet terminal line. To restore to the default authentication method list, please use the **no enable authentication** command.

### Syntax

```
enable authentication { method-list }
no enable authentication
```

### Parameter

*method-list* — Specify the enable method list on the telnet terminal line. It is “default” by default, which contains the method “none”.

### Command Mode

Line Configuration Mode

### Privilege Requirement

Only Admin level users have access to these commands.

## Example

Configure the enable authentication method list on the telnet terminal line as “list2”:

```
T1700X-16TS(config)#line telnet
T1700X-16TS(config-line)# enable authentication list2
```



## 34.20 enable authentication(ssh)

### Description

The **enable authentication** command is used to apply the privilege authentication method list to the ssh terminal line. To restore to the default authentication method list, please use the **no enable authentication** command.

### Syntax

```
enable authentication { method-list }
```

```
no enable authentication
```

### Parameter

*method-list* — Specify the enable method list on the ssh terminal line. It is “default” by default, which contains the method “none”.

### Command Mode

Line Configuration Mode

### Privilege Requirement

Only Admin level users have access to these commands.

### Example

Configure the enable authentication method list on the ssh terminal line as “list2”:

```
T1700X-16TS(config)# line ssh
T1700X-16TS(config-line)# enable authentication list2
```

## 34.21 ip http login authentication

### Description

The **ip http login authentication** command is used to apply the login authentication method list to users accessing through HTTP. To restore to the default authentication method list, please use the **no ip http login authentication** command.

### Syntax

```
ip http login authentication { method-list }
```

```
no ip http login authentication
```

## Parameter

*method-list* — Specify the login method list on the HTTP access. It is “default” by default, which contains the method “local”.

## Command Mode

Global Configuration Mode

## Privilege Requirement

Only Admin level users have access to these commands.

## Example

Configure the login authentication method list on the HTTP access as “list1”:

```
T1700X-16TS(config)# ip http login authentication list1
```

## 34.22 ip http enable authentication

### Description

The **ip http enable authentication** command is used to apply the privilege authentication method list to users accessing through HTTP. To restore to the default authentication method list, please use the **no ip http enable authentication** command.

### Syntax

```
ip http enable authentication { method-list }
```

```
no ip http enable authentication
```

### Parameter

*method-list* — Specify the enable method list on the HTTP access. It is “default” by default, which contains the method “none”.

### Command Mode

Line Configuration Mode

### Privilege Requirement

Only Admin level users have access to these commands.

### Example

Configure the enable authentication method list on the HTTP access as “list2”:

```
T1700X-16TS(config)# ip http enable authentication list2
```

## 34.23 show aaa global

### Description

This **show aaa global** command is used to display global status of AAA function and the login/enable method lists of different application modules: telnet, ssh and HTTP.

### Syntax

```
show aaa global
```

### Command Mode

Privileged EXEC Mode and Any Configuration Mode

### Privilege Requirement

Only Admin level users have access to these commands.

### Example

Display the AAA function's global status and each application's method list:

```
T1700X-16TS(config)# show aaa global
```

## Chapter 35 DHCP Relay Commands

A DHCP Relay is a Layer 3 device that forwards DHCP packets between clients and servers. DHCP Relay forward requests and replies between clients and servers when they are not on the same physical subnet.

### 35.1 service dhcp relay

#### Description

The **service dhcp relay** command is used to enable DHCP Relay function globally. To disable DHCP Relay function, please use **no service dhcp relay** command.

#### Syntax

```
service dhcp relay  
no service dhcp relay
```

#### Command Mode

Global Configuration Mode

#### Privilege Requirement

Only Admin, Operator and Power User level users have access to these commands.

#### Example

Enable DHCP Relay function globally:

```
T1700X-16TS(config)# service dhcp relay
```

### 35.2 ip helper-address

#### Description

The **ip helper-address** command is used to add DHCP Server address to the Layer 3 interface. To delete the server address, please use **no ip helper-address** command.

#### Syntax

```
ip helper-address ip-address  
no ip helper-address [ ip-address ]
```

#### Parameter

*ip-address* — DHCP Server address.

## Command Mode

Interface Configuration Mode

## Privilege Requirement

Only Admin, Operator and Power User level users have access to these commands.

## Example

Add DHCP Server address 192.168.2.1 to interface VLAN 1:

```
T1700X-16TS(config)# interface vlan 1
T1700X-16TS(config-if)# ip helper-address 192.168.2.1
```

## 35.3 ip dhcp relay information

### Description

The **ip dhcp relay information** command is used to enable option 82 support in DHCP Relay. To disable this function, please use **no ip dhcp relay information** command.

### Syntax

```
ip dhcp relay information
no ip dhcp relay information
```

## Command Mode

Global Configuration Mode

## Privilege Requirement

Only Admin, Operator and Power User level users have access to these commands.

## Example

Enable option 82 support in DHCP Relay:

```
T1700X-16TS(config)# ip dhcp relay information
```

## 35.4 ip dhcp relay information policy

### Description

The **ip dhcp relay information policy** command is used to specify the operation for the Option 82 field of the DHCP request packets from the Host. To restore to the default option, please use **no ip dhcp relay information policy** command.

## Syntax

```
ip dhcp relay information policy { drop | keep | replace }  
no ip dhcp relay information policy
```

## Parameter

drop | keep | replace —The operations for Option 82 field of the DHCP request packets from the Host. The default operation is keep.

drop: Discard the packet with the Option 82 field.

keep: Keep the Option 82 field in the packet.

replace: Replace the option 82 field with the system option defined by the switch.

## Command Mode

Global Configuration Mode

## Privilege Requirement

Only Admin, Operator and Power User level users have access to these commands.

## Example

Specify the option 82 policy as replace to replace the Option 82 field with the local parameter on receiving the DHCP request packet:

```
T1700X-16TS(config)# ip dhcp relay information policy replace
```

# 35.5 ip dhcp relay information custom

## Description

The **ip dhcp relay information custom** command is used to enable the switch to customize the option 82 field. To disable this function, please use **no ip dhcp relay information custom** command.

## Syntax

```
ip dhcp relay information custom  
no ip dhcp relay information custom
```

## Command Mode

Global Configuration Mode

## Privilege Requirement

Only Admin, Operator and Power User level users have access to these commands.

## Example

Enable the switch to customize the option 82 field:

```
T1700X-16TS(config)# ip dhcp relay information custom
```

## 35.6 ip dhcp relay information circuit-id

### Description

The **ip dhcp relay information circuit-id** command is used to specify the custom circuit ID when option 82 customization is enabled. To clear the circuit ID, please use **no ip dhcp relay information circuit-id** command.

### Syntax

```
ip dhcp relay information circuit-id circuitID  
no ip dhcp relay information circuit-id
```

### Parameter

*circuitID* — Specify the circuit ID, ranging from 1 to 64 characters.

### Command Mode

Global Configuration Mode

### Privilege Requirement

Only Admin, Operator and Power User level users have access to these commands.

### Example

Specify the circuit ID as "TP-LINK":

```
T1700X-16TS(config)# ip dhcp relay information circuit-id TP-LINK
```

## 35.7 ip dhcp relay information remote-id

### Description

The **ip dhcp relay information remote-id** command is used to specify the custom remote ID when option 82 customization is enabled. To clear the remote ID, please use **no ip dhcp relay information remote-id** command.

### Syntax

```
ip dhcp relay information remote-id remoteID  
no ip dhcp relay information remote-id
```

### Parameter

*remoteID* — Specify the remote ID, ranging from 1 to 64 characters.

### Command Mode

Global Configuration Mode

### Privilege Requirement

Only Admin, Operator and Power User level users have access to these commands.

### Example

Specify the remote ID as "TP-LINK":

```
T1700X-16TS(config)# ip dhcp relay information remote-id TP-LINK
```

## 35.8 show ip dhcp relay

### Description

The **show ip dhcp relay** command is used to display the global status and Option 82 configuration of DHCP Relay.

### Syntax

```
show ip dhcp relay
```

### Command Mode

Privileged EXEC Mode and Any Configuration Mode

### Privilege Requirement

None.

### Example

Display the configuration of DHCP Relay:

```
T1700X-16TS(config)# show ip dhcp relay
```