



# Configuration Guide

JetStream 12-Port 10GBase-T Smart Switch  
with 4 10G SFP+ Slots

T1700X-16TS

1910011973 REV2.0.0

## FCC STATEMENT

This equipment has been tested and found to comply with the limits for a Class A digital device, pursuant to part 15 of the FCC Rules. These limits are designed to provide reasonable protection against harmful interference when the equipment is operated in a commercial environment. This equipment generates, uses, and can radiate radio frequency energy and, if not installed and used in accordance with the instruction manual, may cause harmful interference to radio communications. Operation of this equipment in a residential area is likely to cause harmful interference in which case the user will be required to correct the interference at his own expense.

This device complies with part 15 of the FCC Rules. Operation is subject to the following two conditions:

- 1) This device may not cause harmful interference.
- 2) This device must accept any interference received, including interference that may cause undesired operation.

Any changes or modifications not expressly approved by the party responsible for compliance could void the user's authority to operate the equipment.

## CE Mark Warning



This is a class A product. In a domestic environment, this product may cause radio interference, in which case the user may be required to take adequate measures.

## Industry Canada Statement

CAN ICES-3 (A)/NMB-3(A)

## BSMI Notice

安全諮詢及注意事項

- 請使用原裝電源供應器或只能按照本產品注明的電源類型使用本產品。
- 清潔本產品之前請先拔掉電源線。請勿使用液體、噴霧清潔劑或濕布進行清潔。
- 注意防潮，請勿將水或其他液體潑灑到本產品上。
- 插槽與開口供通風使用，以確保本產品的操作可靠並防止過熱，請勿堵塞或覆蓋開口。

- 請勿將本產品置放於靠近熱源的地方。除非有正常的通風，否則不可放在密閉位置中。
- 請不要私自打開機殼，不要嘗試自行維修本產品，請由授權的專業人士進行此項工作。

此為甲類資訊技術設備，于居住環境中使用時，可能會造成射頻擾動，在此種情況下，使用者會被要求採取某些適當的對策。





Продукт сертифіковано згідно с правилами системи УкрСЕПРО на відповідність вимогам нормативних документів та вимогам, що передбачені чинними законодавчими актами України.



## Safety Information

- When product has power button, the power button is one of the way to shut off the product; When there is no power button, the only way to completely shut off power is to disconnect the product or the power adapter from the power source.
- Don't disassemble the product, or make repairs yourself. You run the risk of electric shock and voiding the limited warranty. If you need service, please contact us.
- Avoid water and wet locations.

## Explanation of the symbols on the product label

Symbol	Explanation
	AC voltage
	RECYCLING This product bears the selective sorting symbol for Waste electrical and electronic equipment (WEEE). This means that this product must be handled pursuant to European directive 2012/19/EU in order to be recycled or dismantled to minimize its impact on the environment.
	User has the choice to give his product to a competent recycling organization or to the retailer when he buys a new electrical or electronic equipment.

# CONTENTS

## About This Guide

Intended Readers .....	1
Conventions.....	1
More Information .....	2

## Accessing the Switch

Overview .....	4
Web Interface Access.....	5
Login .....	5
Save Config Function.....	6
Disable the Web Server .....	7
Configure the Switch's IP Address and Default Gateway .....	8
Command Line Interface Access .....	11
Console Login (only for switch with console port).....	11
Telnet Login.....	13
SSH Login.....	14
Disable Telnet login.....	18
Disable SSH login .....	19
Copy running-config startup-config.....	19
Change the Switch's IP Address and Default Gateway.....	20

## Managing System

System.....	22
Overview.....	22
Supported Features.....	22
System Info Configurations .....	24
Using the GUI .....	24
Viewing the System Summary.....	24
Specifying the Device Description.....	26
Setting the System Time .....	26
Setting the Daylight Saving Time.....	27
Using the CLI.....	29
Viewing the System Summary.....	29
Specifying the Device Description.....	30

Setting the System Time .....	31
Setting the Daylight Saving Time .....	33
<b>User Management Configurations .....</b>	<b>36</b>
Using the GUI .....	36
Creating Admin Accounts .....	36
Creating Accounts of Other Types .....	37
Using the CLI .....	39
Creating Admin Accounts .....	39
Creating Accounts of Other Types .....	40
<b>System Tools Configurations .....</b>	<b>44</b>
Using the GUI .....	44
Configuring the Boot File .....	44
Restoring the Configuration of the Switch .....	45
Backing up the Configuration File .....	46
Upgrading the Firmware .....	46
Rebooting the switch .....	47
Configuring the Reboot Schedule .....	47
Resetting the Switch .....	48
Using the CLI .....	48
Configuring the Boot File .....	48
Restoring the Configuration of the Switch .....	49
Backing up the Configuration File .....	50
Upgrading the firmware .....	50
Rebooting the switch .....	51
Configuring the Reboot Schedule .....	51
Resetting the Switch .....	52
<b>Access Security Configurations .....</b>	<b>53</b>
Using the GUI .....	53
Configuring the Access Control Feature .....	53
Configuring the HTTP Function .....	55
Configuring the HTTPS Function .....	56
Configuring the SSH Feature .....	58
Enabling the Telnet Function .....	59
Using the CLI .....	59
Configuring the Access Control .....	59
Configuring the HTTP Function .....	61
Configuring the HTTPS Function .....	62
Configuring the SSH Feature .....	64

Enabling the Telnet Function.....	67
<b>SDM Template Configuration.....</b>	<b>68</b>
Using the GUI .....	68
Using the CLI.....	69
<b>Appendix: Default Parameters.....</b>	<b>71</b>

## **Managing Physical Interfaces**

<b>Physical Interface .....</b>	<b>75</b>
Overview.....	75
Supported Features.....	75
<b>Basic Parameters Configurations.....</b>	<b>76</b>
Using the GUI .....	76
Using the CLI.....	77
<b>Port Mirror Configuration.....</b>	<b>80</b>
Using the GUI .....	80
Using the CLI.....	82
<b>Port Security Configuration .....</b>	<b>84</b>
Using the GUI .....	84
Using the CLI.....	85
<b>Port Isolation Configurations .....</b>	<b>88</b>
Using the GUI .....	88
Using the CLI.....	89
<b>Loopback Detection Configuration .....</b>	<b>91</b>
Using the GUI .....	91
Using the CLI.....	92
<b>Configuration Examples.....</b>	<b>95</b>
Example for Port Mirror .....	95
Network Requirements .....	95
Configuration Scheme.....	95
Using the GUI.....	95
Using the CLI .....	97
Example for Port Isolation.....	98
Network Requirements .....	98
Configuration Scheme.....	98
Using the GUI.....	98
Using the CLI .....	100
Example for Loopback Detection.....	100

Network Requirements .....	100
Configuration Scheme .....	101
Using the GUI .....	101
Using the CLI .....	102
<b>Appendix: Default Parameters .....</b>	<b>104</b>

## **Configuring LAG**

<b>LAG .....</b>	<b>107</b>
Overview .....	107
Supported Features .....	107
<b>LAG Configuration .....</b>	<b>108</b>
Using the GUI .....	109
Configuring Load-balancing Algorithm .....	109
Configuring Static LAG or LACP .....	110
Using the CLI .....	112
Configuring Load-balancing Algorithm .....	112
Configuring Static LAG or LACP .....	113
<b>Configuration Example .....</b>	<b>117</b>
Network Requirements .....	117
Configuration Scheme .....	117
Using the GUI .....	118
Using the CLI .....	119
<b>Appendix: Default Parameters .....</b>	<b>121</b>

## **Monitoring Traffic**

<b>Traffic Monitor .....</b>	<b>123</b>
Using the GUI .....	123
Viewing the Traffic Summary .....	123
Viewing the Traffic Statistics in Detail .....	124
Using the CLI .....	127
<b>Appendix: Default Parameters .....</b>	<b>128</b>

## **Managing MAC Address Table**

<b>MAC Address Table .....</b>	<b>130</b>
Overview .....	130
Supported Features .....	130
<b>Address Configurations .....</b>	<b>132</b>

Using the GUI .....	132
Adding Static MAC Address Entries .....	132
Modifying the Aging Time of Dynamic Address Entries.....	135
Adding MAC Filtering Address Entries.....	136
Viewing Address Table Entries.....	136
Using the CLI.....	137
Adding Static MAC Address Entries .....	137
Modifying the Aging Time of Dynamic Address Entries.....	139
Adding MAC Filtering Address Entries.....	139
<b>Security Configurations .....</b>	<b>141</b>
Using the GUI .....	141
Configuring MAC Notification Traps .....	141
Limiting the Number of MAC Addresses in VLANs .....	142
Using the CLI.....	143
Configuring MAC Notification Traps .....	143
Limiting the Number of MAC Addresses in VLANs .....	145
<b>Example for Security Configurations .....</b>	<b>147</b>
Network Requirements.....	147
Configuration Scheme .....	147
Using the GUI .....	148
Using the CLI.....	149
<b>Appendix: Default Parameters.....</b>	<b>150</b>

## **Configuring 802.1Q VLAN**

<b>Overview .....</b>	<b>152</b>
<b>802.1Q VLAN Configuration.....</b>	<b>153</b>
Using the GUI .....	153
Configuring the PVID of the Port.....	153
Configuring the VLAN.....	154
Using the CLI.....	155
Creating a VLAN .....	155
Configuring the PVID of the Port.....	156
Adding the Port to the Specified VLAN .....	157
<b>Configuration Example .....</b>	<b>159</b>
Network Requirements.....	159
Configuration Scheme .....	159
Network Topology.....	160



Using the GUI .....	160
Using the CLI .....	162
<b>Appendix: Default Parameters .....</b>	<b>164</b>

## **Configuring MAC VLAN**

<b>Overview .....</b>	<b>166</b>
<b>MAC VLAN Configuration .....</b>	<b>167</b>
Using the GUI .....	167
Configuring 802.1Q VLAN .....	167
Binding the MAC Address to the VLAN .....	168
Enabling MAC VLAN for the Port .....	168
Using the CLI .....	169
Configuring 802.1Q VLAN .....	169
Binding the MAC Address to the VLAN .....	169
Enabling MAC VLAN for the Port .....	170
<b>Configuration Example .....</b>	<b>172</b>
Network Requirements .....	172
Configuration Scheme .....	172
Using the GUI .....	173
Using the CLI .....	176
<b>Appendix: Default Parameters .....</b>	<b>180</b>

## **Configuring Protocol VLAN**

<b>Overview .....</b>	<b>182</b>
<b>Protocol VLAN Configuration .....</b>	<b>183</b>
Using the GUI .....	183
Configuring 802.1Q VLAN .....	183
Creating Protocol Template .....	184
Configuring Protocol VLAN .....	184
Using the CLI .....	185
Configuring 802.1Q VLAN .....	185
Creating a Protocol Template .....	186
Configuring Protocol VLAN .....	187
<b>Configuration Example .....</b>	<b>189</b>
Network Requirements .....	189
Configuration Scheme .....	189
Using the GUI .....	190

Using the CLI.....	195
Appendix: Default Parameters.....	199

## Configuring Private VLAN

Overview .....	201
Private VLAN Configurations .....	203
Using the GUI .....	203
Creating Private VLAN.....	203
Configuring the Up-link Port .....	204
Configuring the Down-link Port.....	205
Using the CLI.....	206
Creating Private VLAN.....	206
Configuring the Up-link Port .....	208
Configuring the Down-link Port.....	209
Configuration Example .....	211
Network Requirements.....	211
Configuration Scheme .....	211
Network Topology.....	211
Using the GUI .....	212
Using the CLI.....	214
Appendix: Default Parameters.....	217

## Configuring Spanning Tree

Spanning Tree.....	219
Overview.....	219
Basic Concepts .....	219
STP/RSTP Concepts.....	219
MSTP Concepts .....	223
STP Security.....	224
STP/RSTP Configurations .....	227
Using the GUI .....	227
Configuring STP/RSTP Parameters on Ports.....	227
Configuring STP/RSTP Globally .....	229
Verifying the STP/RSTP Configurations.....	231
Using the CLI.....	232
Configuring STP/RSTP Parameters on Ports.....	232
Configuring Global STP/RSTP Parameters .....	234

Enabling STP/RSTP Globally .....	235
<b>MSTP Configurations .....</b>	<b>237</b>
Using the GUI .....	237
Configuring Parameters on Ports in CIST .....	237
Configuring the MSTP Region .....	239
Configuring MSTP Globally.....	244
Verifying the MSTP Configurations .....	246
Using the CLI.....	247
Configuring Parameters on Ports in CIST .....	247
Configuring the MSTP Region .....	249
Configuring Global MSTP Parameters .....	252
Enabling Spanning Tree Globally.....	254
<b>STP Security Configurations .....</b>	<b>257</b>
Using the GUI .....	257
Configuring the STP Security.....	257
(Optional) Configuring the Threshold and Cycle of TC Protect .....	258
Using the CLI.....	259
Configuring the STP Security.....	259
Configuring the TC Protect .....	261
<b>Configuration Example for MSTP .....</b>	<b>263</b>
Network Requirements.....	263
Configuration Scheme .....	263
Using the GUI .....	264
Using the CLI.....	275
<b>Appendix: Default Parameters.....</b>	<b>282</b>

## **Configuring Layer 2 Multicast**

<b>Layer 2 Multicast.....</b>	<b>285</b>
Overview.....	285
Supported Layer 2 Multicast Protocols.....	286
<b>IGMP Snooping Configurations.....</b>	<b>287</b>
Using the GUI .....	287
Configuring IGMP Snooping Globally .....	287
Enabling IGMP Snooping Globally .....	287
(Optional) Configuring Unknown Multicast.....	287
(Optional) Configuring Report Message Suppression.....	288
Configuring Router Port Time and Member Port Time.....	288

Configuring IGMP Snooping Last Listener Query .....	289
Verifying IGMP Snooping Status.....	289
Configuring the Port's Basic IGMP Snooping Features.....	290
Enabling IGMP Snooping on the Port.....	290
(Optional) Configuring Fast Leave.....	290
Configuring IGMP Snooping in the VLAN.....	291
Configuring IGMP Snooping Globally in the VLAN.....	291
(Optional) Configuring the Static Router Ports in the VLAN .....	292
(Optional) Configuring the Forbidden Router Ports in the VLAN .....	292
Configuring the Multicast VLAN .....	292
Creating Multicast VLAN and Configuring Basic Settings.....	293
(Optional) Creating Replace Source IP .....	294
Viewing Dynamic Router Ports in the Multicast VLAN.....	294
(Optional) Configuring the Static Router Ports.....	294
(Optional) Configuring the Forbidden Router Ports.....	294
(Optional) Configuring the Querier.....	295
Configuring the Querier.....	295
Viewing Settings of IGMP Querier .....	296
Configuring IGMP Profile.....	296
Creating Profile .....	296
Searching Profile.....	296
Editing IP Range of the Profile .....	297
Binding Profile and Member Ports.....	297
Binding Profile and Member Ports .....	298
Configuring Max Groups a Port Can Join.....	298
Viewing IGMP Statistics on Each Port.....	299
Configuring Auto Refresh .....	299
Viewing IGMP Statistics .....	300
Enabling IGMP Accounting and Authentication.....	300
Configuring IGMP Accounting Globally.....	301
Configuring IGMP Authentication on the Port.....	301
Configuring Static Member Port.....	301
Configuring Static Member Port .....	302
Viewing IGMP Static Multicast Groups .....	302
Using the CLI.....	303
Enabling IGMP Snooping Globally .....	303
Enabling IGMP Snooping on the Port.....	303
Configuring IGMP Snooping Parameters Globally .....	304

Configuring Report Message Suppression .....	304
Configuring Unknown Multicast .....	305
Configuring IGMP Snooping Parameters on the Port .....	306
Configuring Router Port Time and Member Port Time.....	306
Configuring Fast Leave .....	307
Configuring Max Group and Overflow Action on the Port .....	308
Configuring IGMP Snooping Last Listener Query .....	310
Configuring IGMP Snooping Parameters in the VLAN.....	311
Configuring Router Port Time and Member Port Time.....	311
Configuring Static Router Port.....	312
Configuring Forbidden Router Port.....	313
Configuring Static Multicast (Multicast IP and Forward Port).....	314
Configuring IGMP Snooping Parameters in the Multicast VLAN .....	315
Configuring Router Port Time and Member Port Time.....	315
Configuring Static Router Port.....	316
Configuring Forbidden Router Port.....	317
Configuring Replace Source IP.....	318
Configuring the Querier .....	319
Enabling IGMP Querier .....	319
Configuring Query Interval, Max Response Time and General Query Source IP .....	319
Configuring Multicast Filtering.....	321
Creating Profile .....	321
Binding Profile to the Port .....	322
Enabling IGMP Accounting and Authentication.....	323
Enabling IGMP Authentication on the Port.....	323
Enabling IGMP Accounting Globally .....	324
<b>Configuring MLD Snooping.....</b>	<b>325</b>
Using the GUI .....	325
Configuring MLD Snooping Globally.....	325
Enabling MLD Snooping Globally.....	325
(Optional) Configuring Unknown Multicast.....	325
(Optional) Configuring Report Message Suppression.....	326
Configuring Router Port Time and Member Port Time.....	326
Configuring MLD Snooping Last Listener Query.....	327
Verifying MLD Snooping Status .....	327
Configuring the Port's Basic MLD Snooping Features .....	328
Enabling MLD Snooping on the Port .....	328
(Optional) Configuring Fast Leave.....	328

Configuring MLD Snooping in the VLAN .....	329
Configuring MLD Snooping Globally in the VLAN .....	329
(Optional) Configuring the Static Router Ports in the VLAN .....	330
(Optional) Configuring the Forbidden Router Ports in the VLAN .....	330
Configuring the Multicast VLAN .....	330
Creating Multicast VLAN and Configuring Basic Settings.....	331
(Optional) Creating Replace Source IP .....	332
Viewing Dynamic Router Ports in the Multicast VLAN.....	332
(Optional) Configuring the Static Router Ports.....	332
(Optional) Configuring the Forbidden Router Ports.....	332
(Optional) Configuring the Querier.....	333
Configuring the Querier.....	333
Viewing Settings of MLD Querier.....	333
Configuring MLD Profile .....	334
Creating Profile .....	334
Searching Profile.....	334
Editing IP Range of the Profile .....	335
Binding Profile and Member Ports.....	335
Binding Profile and Member Ports .....	336
Configuring Max Groups a Port Can Join.....	336
Viewing MLD Statistics on Each Port .....	337
Configuring Auto Refresh .....	338
Viewing MLD Statistics.....	338
Configuring Static Member Port.....	338
Configuring Static Member Port .....	339
Viewing MLD Static Multicast Groups.....	339
Using the CLI.....	339
Enabling MLD Snooping Globally.....	339
Enabling MLD Snooping on the Port.....	339
Configuring MLD Snooping Parameters Globally.....	341
Configuring Report Message Suppression .....	341
Configuring Unknown Multicast .....	342
Configuring MLD Snooping Parameters on the Port.....	343
Configuring Router Port Time and Member Port Time.....	343
Configuring Fast Leave .....	344
Configuring Max Group and Overflow Action on the Port .....	345
Configuring MLD Snooping Last Listener Query.....	346
Configuring MLD Snooping Parameters in the VLAN .....	347

Configuring Router Port Time and Member Port Time.....	347
Configuring Static Router Port.....	348
Configuring Forbidden Router Port.....	349
Configuring Static Multicast (Multicast IP and Forward Port).....	350
Configuring MLD Snooping Parameters in the Multicast VLAN.....	351
Configuring Router Port Time and Member Port Time.....	351
Configuring Static Router Port.....	352
Configuring Forbidden Router Port.....	353
Configuring Replace Source IP.....	354
Configuring the Querier.....	355
Enabling MLD Querier.....	355
Configuring Query Interval, Max Response Time and General Query Source IP.....	355
Configuring Multicast Filtering.....	357
Creating Profile.....	357
Binding Profile to the Port.....	358
<b>Viewing Multicast Snooping Configurations.....</b>	<b>360</b>
Using the GUI.....	360
Viewing IPv4 Multicast Snooping Configurations.....	360
Viewing IPv6 Multicast Snooping Configurations.....	360
Using the CLI.....	361
Viewing IPv4 Multicast Snooping Configurations.....	361
Viewing IPv6 Multicast Snooping Configurations.....	362
<b>Configuration Examples.....</b>	<b>364</b>
Example for Configuring Basic IGMP Snooping.....	364
Network Requirements.....	364
Configuration Scheme.....	364
Using the GUI.....	365
Using the CLI.....	369
Example for Configuring Multicast VLAN.....	371
Network Requirements.....	371
Configuration Scheme.....	371
Network Topology.....	371
Using the GUI.....	372
Using the CLI.....	375
Example for Configuring Unknown Multicast and Fast Leave.....	377
Network Requirement.....	377
Configuration Scheme.....	378
Using the GUI.....	378

Using the CLI .....	381
Example for Configuring Multicast Filtering.....	382
Network Requirements .....	382
Configuration Scheme.....	382
Network Topology.....	382
Using the GUI.....	383
Using the CLI .....	390
<b>Appendix: Default Parameters .....</b>	<b>393</b>
Default Parameters for IGMP Snooping .....	393
Default Parameters for MLD Snooping.....	394

## **Configuring Logical Interfaces**

<b>Overview .....</b>	<b>397</b>
<b>Logical Interfaces Configurations.....</b>	<b>398</b>
Using the GUI .....	398
Creating a Layer 3 Interface.....	398
Configuring IPv4 Parameters of the Interface .....	399
Configuring IPv6 Parameters of the Interface .....	400
Viewing Detail Information of the Interface .....	403
Using the CLI.....	403
Creating a Layer 3 Interface.....	403
Configuring IPv4 Parameters of the Interface .....	405
Configuring IPv6 Parameters of the Interface .....	406
<b>Appendix: Default Parameters.....</b>	<b>409</b>

## **Configuring Static Routing**

<b>Overview .....</b>	<b>411</b>
<b>IPv4 Static Routing Configuration .....</b>	<b>412</b>
Using the GUI .....	412
Using the CLI.....	413
<b>IPv6 Static Routing Configuration .....</b>	<b>414</b>
Using the GUI .....	414
Using the CLI.....	415
<b>Viewing Routing Table .....</b>	<b>417</b>
Using the GUI .....	417
Viewing IPv4 Routing Table .....	417
Viewing IPv6 Routing Table .....	418



Using the CLI.....	418
Viewing IPv4 Routing Table.....	418
Viewing IPv6 Routing Table.....	419
<b>Example for Static Routing.....</b>	<b>420</b>
Network Requirements.....	420
Configuration Scheme.....	420
Using the GUI.....	420
Using the CLI.....	421
<b>Appendix: Default Parameter.....</b>	<b>424</b>

## Configuring DHCP Relay

<b>Overview.....</b>	<b>426</b>
<b>DHCP Relay Configuration.....</b>	<b>427</b>
Using the GUI.....	427
Enabling DHCP Relay and Configuring Option 82.....	427
Specifying DHCP Server for the Interface.....	428
Using the CLI.....	429
Enabling DHCP Relay.....	429
Configuring Option 82.....	429
Specifying DHCP Server for the Interface.....	431
<b>Configuration Example.....</b>	<b>433</b>
Network Requirements.....	433
Configuration Scheme.....	433
Using the GUI.....	434
Using the CLI.....	435
<b>Appendix: Default Parameters.....</b>	<b>436</b>

## Configuring ARP

<b>Overview.....</b>	<b>438</b>
<b>ARP Configurations.....</b>	<b>439</b>
Using the GUI.....	439
Viewing the ARP Entries.....	439
Adding Static ARP Entries Manually.....	440
Using the CLI.....	440
Configuring ARP Function.....	440

## Configuring QoS

QoS .....	445
Overview .....	445
Supported Features .....	445
DiffServ Configuration .....	446
Using the GUI .....	447
Configuring Priority Mode .....	447
Configuring Schedule Mode .....	450
Using CLI .....	451
Configuring Priority Mode .....	451
Configuring Schedule Mode .....	455
Bandwidth Control Configuration .....	458
Using the GUI .....	458
Configuring Rate Limit .....	458
Configuring Storm Control .....	459
Using the CLI .....	460
Configuring Rate Limit on Port .....	460
Configuring Storm Control .....	461
Configuration Examples .....	464
Example for Configuring SP Mode .....	464
Network Requirements .....	464
Configuration Scheme .....	464
Using the GUI .....	465
Using the CLI .....	466
Example for Configuring WRR Mode .....	467
Network Requirements .....	467
Configuration Scheme .....	468
Using the GUI .....	468
Using the CLI .....	477
Appendix: Default Parameters .....	481

## Configuring Voice VLAN

Overview .....	484
Voice VLAN Configuration .....	486
Using the GUI .....	487
(Optional) Configuring OUI Addresses .....	487
Configuring Voice VLAN Globally .....	488

Configuring Voice VLAN Mode on Ports .....	489
Using the CLI .....	490
<b>Configuration Example .....</b>	<b>493</b>
Network Requirements.....	493
Configuration Scheme .....	493
Network Topology.....	493
Using the GUI .....	494
Using the CLI.....	502
<b>Appendix: Default Parameters.....</b>	<b>507</b>

## **Configuring ACL**

<b>ACL .....</b>	<b>509</b>
Overview.....	509
Supported Features.....	509
<b>ACL Configurations.....</b>	<b>510</b>
Using the GUI .....	510
Creating an ACL.....	510
Configuring ACL Rules.....	511
Configuring Policy.....	516
Configuring the ACL Binding and Policy Binding .....	517
Using the CLI.....	521
Configuring ACL .....	521
Configuring Policy.....	527
ACL Binding and Policy Binding.....	528
<b>Configuration Example for ACL.....</b>	<b>531</b>
Network Requirements.....	531
Network Topology.....	531
Configuration Scheme .....	531
Using the GUI .....	532
Using the CLI.....	536
<b>Appendix: Default Parameters.....</b>	<b>538</b>

## **Configuring Network Security**

<b>Network Security .....</b>	<b>540</b>
Overview.....	540
Supported Features.....	540
<b>IP-MAC Binding Configurations.....</b>	<b>544</b>

Using the GUI .....	544
Binding Entries Manually .....	544
Binding Entries Dynamically .....	545
Viewing the Binding Entries .....	547
Using the CLI .....	548
Binding Entries Manually .....	548
Viewing Binding Entries .....	550
<b>DHCP Snooping Configuration.....</b>	<b>551</b>
Using the GUI .....	551
Enabling DHCP Snooping on VLAN.....	551
Configuring DHCP Snooping on Ports .....	552
(Optional) Configuring Option 82 .....	553
Using the CLI .....	554
Globally Configuring DHCP Snooping.....	554
Configuring DHCP Snooping on Ports .....	555
(Optional) Configuring Option 82 .....	557
<b>ARP Inspection Configurations .....</b>	<b>559</b>
Using the GUI .....	559
Configuring ARP Detection .....	559
Configuring ARP Defend.....	560
Viewing ARP Statistics .....	561
Using the CLI .....	562
Configuring ARP Detection .....	562
Configuring ARP Defend.....	563
Viewing ARP Statistics .....	565
<b>DoS Defend Configuration.....</b>	<b>566</b>
Using the GUI .....	566
Using the CLI .....	567
<b>802.1X Configuration .....</b>	<b>570</b>
Using the GUI .....	570
Configuring the RADIUS Server .....	570
Configuring 802.1X Globally .....	574
Configuring 802.1X on Ports .....	576
Using the CLI .....	577
Configuring the RADIUS Server .....	577
Configuring 802.1X Globally .....	579
Configuring 802.1X on Ports .....	581
<b>AAA Configuration.....</b>	<b>584</b>

Using the GUI .....	585
Globally Enabling AAA .....	585
Adding Servers.....	585
Configuring Server Groups.....	587
Configuring the Method List.....	588
Configuring the AAA Application List.....	589
Configuring Login Account and Enable Password .....	590
Using the CLI.....	591
Globally Enabling AAA .....	591
Adding Servers.....	591
Configuring Server Groups.....	594
Configuring the Method List.....	595
Configuring the AAA Application List.....	596
Configuring Login Account and Enable Password .....	599
<b>Configuration Examples .....</b>	<b>601</b>
Example for DHCP Snooping and ARP Detection .....	601
Network Requirements .....	601
Configuration Scheme.....	601
Using the GUI.....	602
Using the CLI .....	605
Example for 802.1X.....	607
Network Requirements .....	607
Configuration Scheme.....	607
Network Topology.....	608
Using the GUI.....	608
Using the CLI .....	611
Example for AAA.....	613
Network Requirements .....	613
Configuration Scheme.....	614
Using the GUI.....	614
Using the CLI .....	617
<b>Appendix: Default Parameters.....</b>	<b>620</b>
<b>Configuring LLDP</b>	
<b>LLDP.....</b>	<b>625</b>
Overview.....	625
Supported Features.....	625

<b>LLDP Configurations .....</b>	<b>626</b>
Using the GUI .....	626
Global Config.....	626
Port Config.....	628
Using the CLI.....	629
Global Config.....	629
Port Config.....	631
<b>LLDP-MED Configurations .....</b>	<b>633</b>
Using the GUI .....	633
Global Config.....	633
Port Config.....	634
Using the CLI.....	636
Global Config.....	636
Port Config.....	637
<b>Viewing LLDP Settings.....</b>	<b>640</b>
Using GUI.....	640
Viewing LLDP Device Info .....	640
Viewing LLDP Statistics .....	643
Using CLI .....	644
<b>Viewing LLDP-MED Settings .....</b>	<b>645</b>
Using GUI.....	645
Using CLI .....	647
<b>Configuration Example .....</b>	<b>648</b>
Example for Configuring LLDP .....	648
Network Requirements .....	648
Network Topology.....	648
Configuration Scheme.....	648
Using the GUI.....	648
Using CLI.....	649
Example for Configuring LLDP-MED .....	655
Network Requirements .....	655
Configuration Scheme.....	655
Network Topology.....	655
Using the GUI.....	656
Using the CLI .....	660
<b>Appendix: Default Parameters.....</b>	<b>667</b>

## Configuring Maintenance

<b>Maintenance</b> .....	<b>669</b>
Overview.....	669
Supported Features.....	669
<b>Monitoring the System</b> .....	<b>670</b>
Using the GUI .....	670
Monitoring the CPU.....	670
Monitoring the Memory.....	671
Using the CLI.....	671
Monitoring the CPU.....	671
Monitoring the Memory.....	672
<b>System Log Configurations</b> .....	<b>673</b>
Using the GUI .....	674
Configuring the Local Log.....	674
Configuring the Remote Log.....	674
Backing up the Log File .....	675
Viewing the Log Table.....	675
Using the CLI.....	676
Configuring the Local Log.....	676
Configuring the Remote Log.....	678
<b>Diagnosing the Device</b> .....	<b>680</b>
Using the GUI .....	680
Using the CLI.....	681
<b>Diagnosing the Network</b> .....	<b>682</b>
Using the GUI .....	682
Configuring the Ping Test.....	682
Configuring the Tracert Test.....	683
Using the CLI.....	683
Configuring the Ping Test.....	683
Configuring the Tracert Test.....	684
<b>Configuration Example for Remote Log</b> .....	<b>686</b>
Network Requirements.....	686
Configuration Scheme .....	686
Using the GUI .....	686
Using the CLI .....	687
<b>Appendix: Default Parameters</b> .....	<b>688</b>

## Configuring SNMP & RMON

SNMP Overview .....	690
SNMP Configurations.....	691
Using the GUI .....	692
Enabling SNMP .....	692
Creating an SNMP View.....	692
Creating an SNMP Group .....	693
Creating SNMP Users .....	695
Creating SNMP Communities.....	696
Using the CLI.....	697
Enabling SNMP.....	697
Creating an SNMP View.....	699
Creating an SNMP Group .....	700
Creating SNMP Users.....	702
Creating SNMP Communities.....	703
Notification Configurations.....	705
Using the GUI .....	705
Using the CLI.....	707
Configuring the Host.....	707
Enabling SNMP Notification .....	708
RMON Overview .....	712
RMON Configurations .....	713
Using the GUI .....	713
Configuring Statistics .....	713
Configuring History .....	714
Configuring Event .....	715
Configuring Alarm.....	716
Using the CLI.....	718
Configuring Statistics .....	718
Configuring History .....	719
Configuring Event .....	720
Configuring Alarm.....	722
Configuration Example .....	724
Network Requirements.....	724
Configuration Scheme .....	724
Network Topology.....	725
Using the GUI .....	725



Using the CLI.....	730
Appendix: Default Parameters.....	736

# About This Guide

This Configuration Guide provides information for managing T1700X Series Switches. Please read this guide carefully before operation.

## Intended Readers

This Guide is intended for network managers familiar with IT concepts and network terminologies.

## Conventions

When using this guide, please notice that features of the switch may vary slightly depending on the model and software version you have. All screenshots, images, parameters and descriptions documented in this guide are used for demonstration only.

The information in this document is subject to change without notice. Every effort has been made in the preparation of this document to ensure accuracy of the contents, but all statements, information, and recommendations in this document do not constitute the warranty of any kind, express or implied. Users must take full responsibility for their application of any products.

In this Guide, the following conventions are used:

The symbol  stands for *Note*. Notes contains suggestions or references that helps you make better use of your device.

- For GUI:

**Menu Name > Submenu Name > Tab page** indicates the menu structure. **System > System Info > System Summary** means the System Summary page under the System Info menu option that is located under the System menu.

**Bold font** indicates a button, a toolbar icon, menu or menu item.

- For CLI:

<b>Bold Font</b>	An unalterable keyword. For example: <b>show logging</b>
Normal Font	A constant (several options are enumerated and only one can be selected). For example: <b>no bandwidth</b> {all   ingress   egress}
{ }	Items in braces { } are required.

[]	Items in square brackets [ ] are optional.
	Alternative items are grouped in braces and separated by vertical bars  . For example: <b>speed</b> {10   100   1000   10000}
<i>Italic Font</i>	A variable (an actual value must be assigned). For example: <b>bridge aging-time</b> <i>aging-time</i>

Common combination:

{ [ ] [ ] }	<p>A least one item in the square brackets must be selected.</p> <p>For example: <b>bandwidth</b> {[<b>ingress</b> <i>ingress-rate</i>] [<b>egress</b> <i>egress-rate</i>]}</p> <p>This command can be used on three occasions:</p> <p><b>bandwidth ingress</b> <i>ingress-rate</i> is used to restrict ingress bandwidth.</p> <p><b>bandwidth egress</b> <i>egress-rate</i> is used to restrict egress bandwidth.</p> <p><b>bandwidth ingress</b> <i>ingress-rate</i> <b>egress</b> <i>egress-rate</i> is used to restrict ingress and egress bandwidth.</p>
-------------	---

## More Information

- The latest software and documentations can be found at Download Center at <http://www.tp-link.com/support>.
- The Installation Guide (IG) can be found where you find this guide or inside the package of the switch.
- Specifications can be found on the product page at <http://www.tp-link.com>.
- A Technical Support Forum is provided for you to discuss our products at <http://forum.tp-link.com>.
- Our Technical Support contact information can be found at the Contact Technical Support page at <http://www.tp-link.com/support>.

# Part 1

## Accessing the Switch

### CHAPTERS

1. Overview
2. Web Interface Access
3. Command Line Interface Access

# 1 Overview

You can access and manage the switch using the GUI (Graphical User Interface, also called web interface in this text) or using the CLI (Command Line Interface). There are equivalent functions in the web interface and the command line interface, while web configuration is easier and more visual than the CLI configuration. You can choose the method according to their available applications and preference.

# 2 Web Interface Access

You can access the switch's web interface through the web-based authentication. The switch uses two built-in web servers, HTTP server and HTTPS server, for user authentication.

The following example shows how to login via the HTTP server.

## 2.1 Login

To manage your switch through a web browser in the host PC:

- 1) Make sure that the route between the host PC and the switch is available.
- 2) Launch a web browser. The supported web browsers include, but are not limited to, the following types:
  - IE 8.0, 9.0, 10.0, 11.0
  - Firefox 26.0, 27.0
  - Chrome 32.0, 33.0
- 3) Enter the switch's IP address in the web browser's address bar. The switch's default IP address is 192.168.0.1.

Figure 2-1 Enter the switch's IP address in the browser

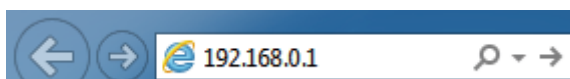

- 4) Enter the username and password in the pop-up login window. Use **admin** for both username and password in lower case letters.

Figure 2-2 Login authentication



- 5) The typical web interface displays below. You can view the switch's running status and configure the switch on this interface.

Figure 2-3 Web interface

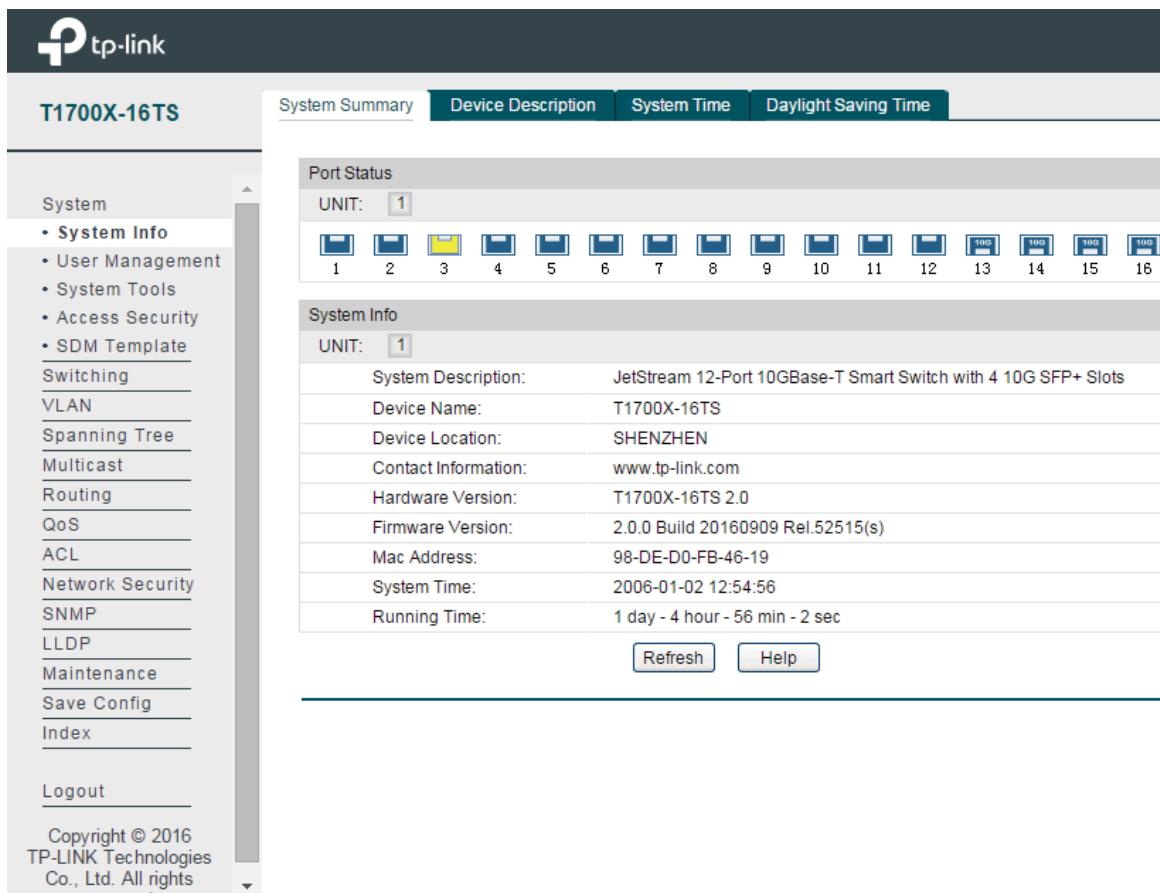

## 2.2 Save Config Function

The switch's configuration files fall into two types: the running configuration file and the start-up configuration file.

After you perform configurations on the sub-interfaces and click **Apply**, the modifications will be saved in the running configuration file. The configurations will be lost when the switch reboots.

If you need to keep the configurations after the switch reboots, please use the Save Config function on the main interface to save the configurations in the start-up configuration file.

Figure 2-4 Save Config

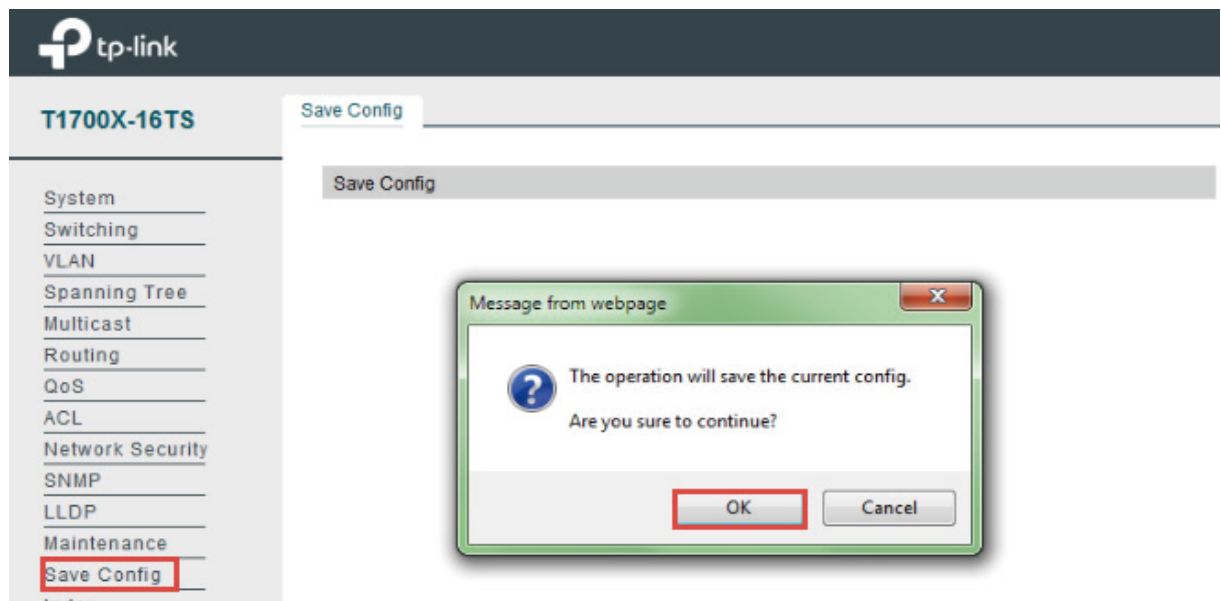

### 2.3 Disable the Web Server

You can shut down the HTTP server or HTTPS server to block any access to the web interface.

Go to **System > Access Security > HTTP Config**, disable the HTTP server and click **Apply**.

Figure 2-5 Shut down HTTP server

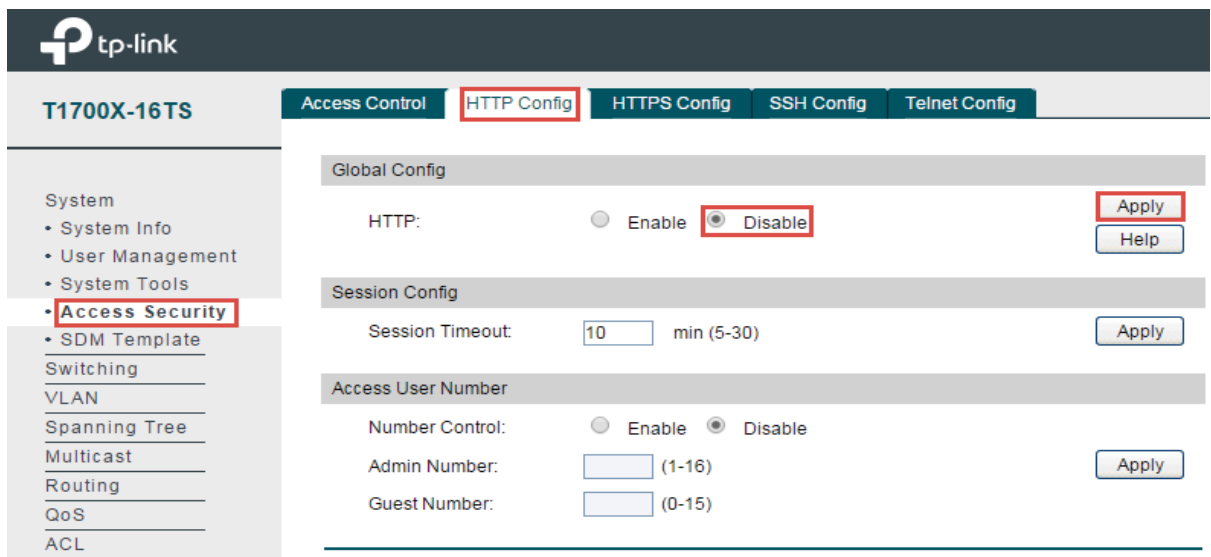



Go to **System > Access Security > HTTPS Config**, disable the HTTPS server and click **Apply**.

Figure 2-6 Disbale the HTTPS Server

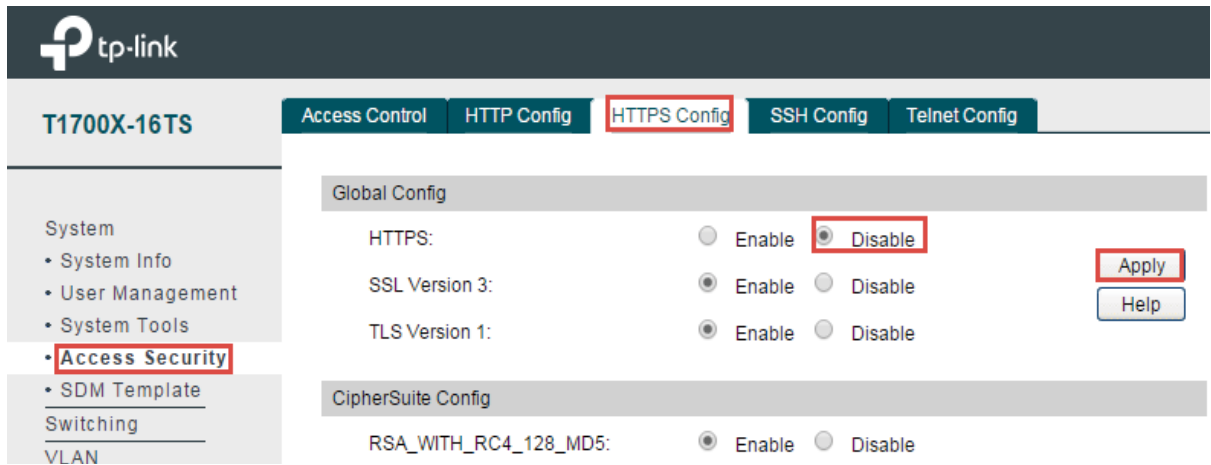

## 2.4 Configure the Switch's IP Address and Default Gateway

If you want to access the switch via a specified port (hereafter referred to as the access port), you can configure the port as a routed port and specify its IP address, or configure the IP address of the VLAN which the access port belongs to.

- Change the IP Address

By default, all the ports belong to VLAN 1 with the VLAN interface IP 192.168.0.1. The following example shows how to change the switch’s default access IP address 192.168.0.1.

- Go to **Routing > Interface > Interface Config**. The default access IP address in VLAN 1 in the Interface List. Click **Edit** to modify the VLAN1’s IP address.

Figure 2-7 Change VLAN1's IP address

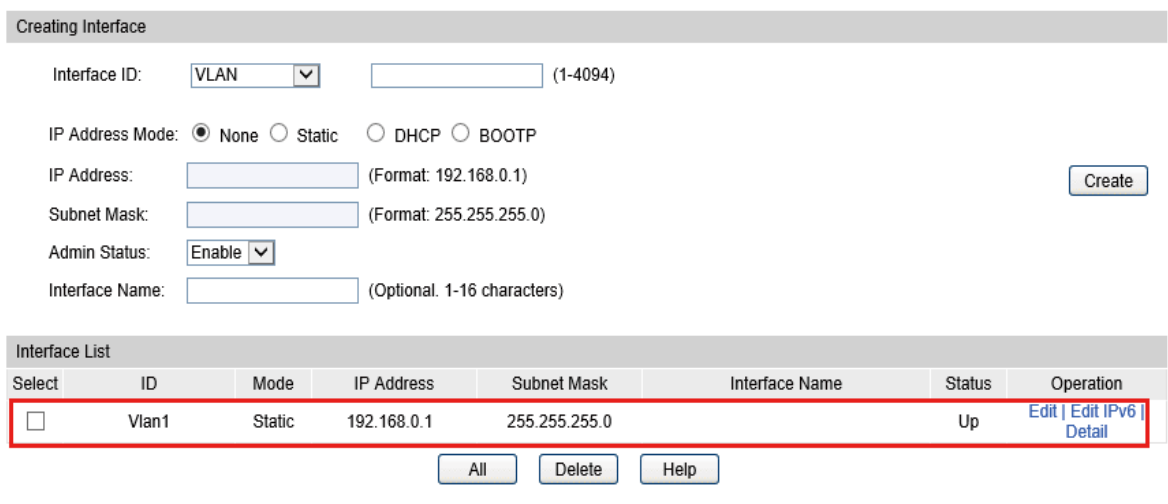

- Choose the **IP Address Mode** as **Static**. Enter the new access address in the **IP Address** field and click **Apply**. Make sure that the route between the host PC and the switch’s new IP address is available.

Figure 2-8 Specify the IP address

**Modify Interface**

Interface ID:

IP Address Mode:  None  **Static**  DHCP  BOOTP

IP Address:  (Format: 192.168.0.1)

Subnet Mask:  (Format: 255.255.255.0)

Admin Status:  ▼

Interface Name:  (Optional. 1-16 characters)

---

**Secondary IP Create**

IP Address:  (Format: 192.168.0.1)

Subnet Mask:  (Format: 255.255.255.0)

---

**Secondary IP List**

Select	IP Address	Subnet mask
No entry in the table.		

- Enter the new IP address in the web browser to access the switch.
- Click **Save Config** to save the settings.

- Configure the Default Gateway

The following example shows how to configure the switch’s gateway. By default, the switch has no default gateway.

- Go to page **Routing > Static Routing > IPv4 Static Routing Config**. Configure the parameters related to the switch’s gateway and click **Create**.

Figure 2-9 Configure the default gateway

**IPv4 Static Routing Config**

Destination:  (Format: 10.10.10.0)

Subnet Mask:  (Format: 255.255.255.0)

Next Hop:  (Format: 192.168.0.2)

Distance:  (Optional. range: 1-255)

---

**IPv4 Static Route Table**

Select	Destination	Subnet Mask	Next Hop	Distance	Metric	Interface Name
<input type="checkbox"/>			<input type="text"/>	<input type="text"/>		
No entry in the table.						

**Destination** Specify the destination as 0.0.0.0.

---

Subnet Mask	Specify the subnet mask as 255.255.255.0.
Next Hop	Configure your desired default gateway as the next hop's IP address.
Distance	Specify the distance as 1.

---

- 2) Click **Save Config** to save the settings.
- 3) Check the routing table to verify the default gateway you configured. The entry marked in red box displays the valid default gateway.

Figure 2-10 View the default gateway

IPv4 Routing Information Summary					
Protocol	Destination Network	Next Hop	Distance	Metric	Interface Name
static	0.0.0.0/24	192.168.0.100	1	0	
connected	192.168.0.0/24	192.168.0.16	0	1	

Refresh

---

# 3 Command Line Interface Access

Users can access the switch's command line interface through the console (only for switch with console port), Telnet or SSH connection, and manage the switch with the command lines.

Console connection requires the host PC connecting to the switch's console port directly, while Telnet and SSH connection support both local and remote access.

The following table shows the typical applications used in the CLI access.

Table 3-1 Method list

Method	Using Port	Typical Applications
Console	Console port (connected directly)	Hyper Terminal
Telnet	RJ-45 port	CMD
SSH	RJ-45 port	Putty

## 3.1 Console Login (only for switch with console port)

Follow these steps to log in to the switch via the Console port:

- 1) Connect the PC or terminal to the Console port on the switch with the serial cable.
- 2) Start the terminal emulation program (such as the Hyper Terminal) on the PC and configure the terminal emulation program as follows:
  - Baud Rate: 38400bps
  - Data Bits: 8
  - Parity: None
  - Stop Bits: 1
  - Flow Control: None
- 3) Press **Enter** in the main window and **Switch>** will appear, indicating that you have successfully logged in to the switch and you can use the CLI now.

Figure 3-1 CLI Main Window

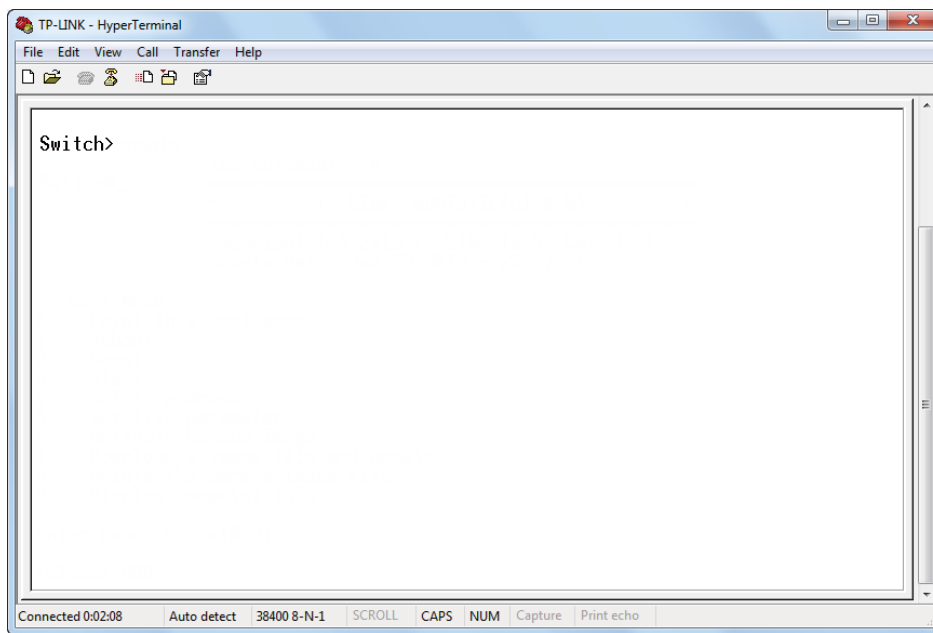

- 4) Enter **enable** to enter the User EXEC Mode to further configure the switch.

Figure 3-2 User EXEC Mode

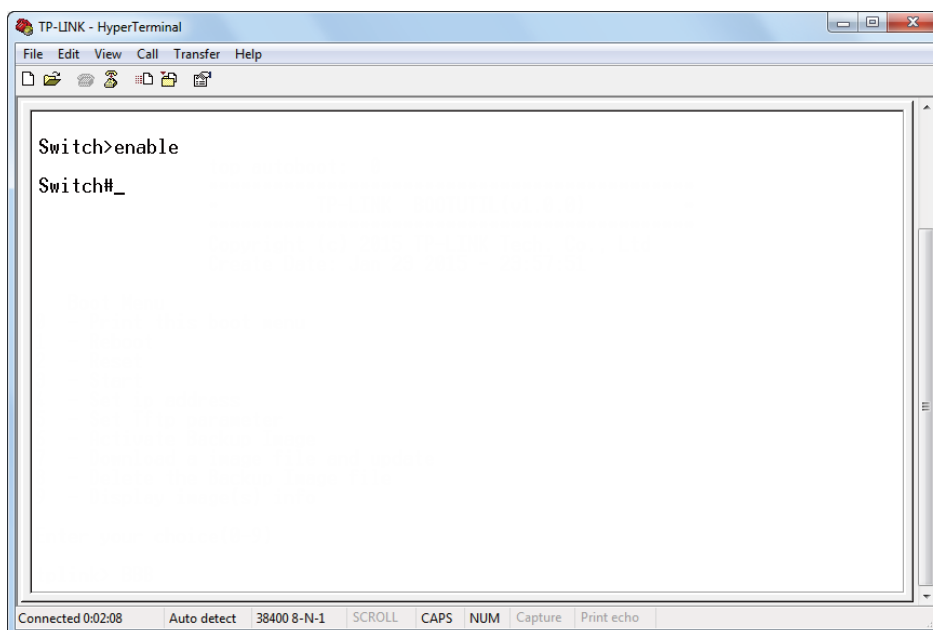

---

 **Note:**

In Windows XP, go to **Start > All Programs > Accessories > Communications > Hyper Terminal** to open the Hyper Terminal and configure the above settings to log in to the switch.

---

## 3.2 Telnet Login

The switch supports Login Local Mode for authentication by default.

Login Local Mode: Username and password are required, which are both **admin** by default.

The following steps show how to manage the switch via the Login Local Mode:

- 1) Make sure the switch and the PC are in the same LAN (Local Area Network). Click **Start** and type in **cmd** in the Search bar and press **Enter**.

Figure 3-3 Open the cmd Window

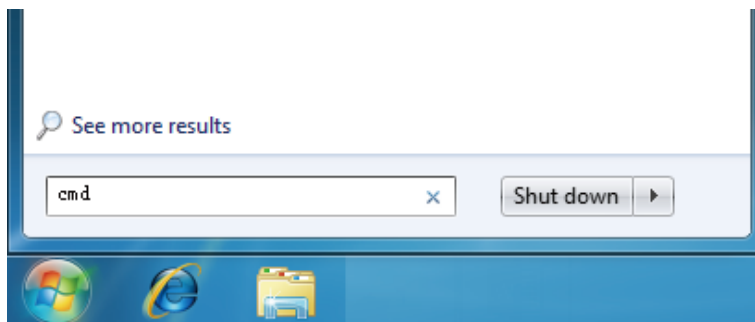

- 2) Type in **telnet 192.168.0.1** in the cmd window and press **Enter**.

Figure 3-4 Log In to the Switch

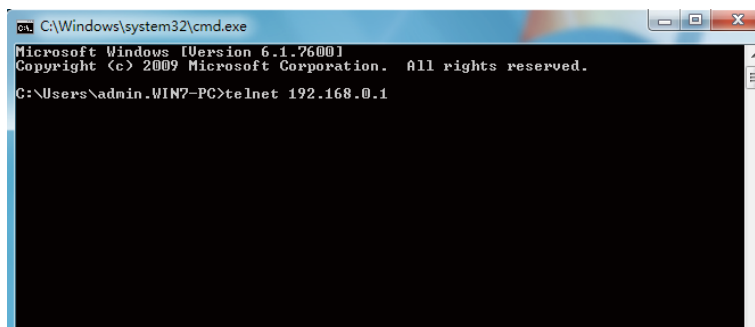

- 3) Type in the login username and password (both **admin** by default). Press **Enter** and you will enter User EXEC Mode.

Figure 3-5 Enter User EXEC Mode

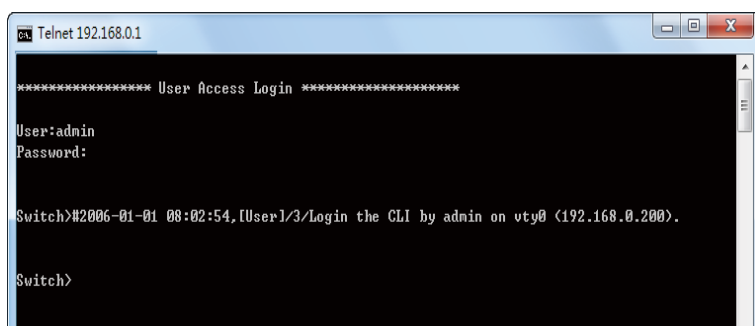

- 4) Type in **enable** command and you will enter Privileged EXEC Mode. By default no password is needed. Later you can set a password for users who want to access the Privileged EXEC Mode.

Figure 3-6 Enter Privileged EXEC Mode

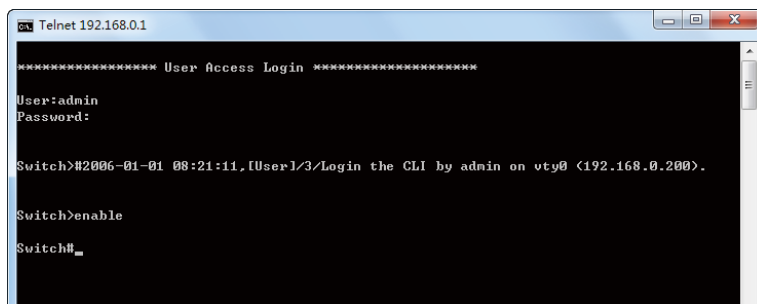

```
Telnet 192.168.0.1
***** User Access Login *****
User:admin
Password:
Switch#2006-01-01 08:21:11,[User]/3/Login the CLI by admin on vty0 (192.168.0.200).
Switch>enable
Switch#_
```

Now you can manage your switch with CLI commands through Telnet connection.

### 3.3 SSH Login

SSH login supports the following two modes: Password Authentication Mode and Key Authentication Mode. You can choose one according to your needs:

- Password Authentication Mode: Username and password are required, which are both **admin** by default.
- Key Authentication Mode (Recommended): A public key for the switch and a private key for the client software (PuTTY) are required. You can generate the public key and the private key through the PuTTY Key Generator.

Before logging in via SSH, follow the steps below to enable SSH on the terminal emulation program:

Figure 3-7 Enable SSH

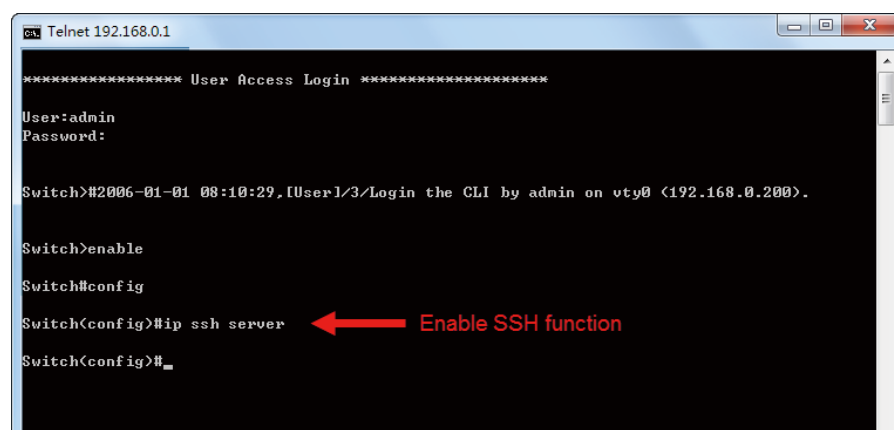

```
Telnet 192.168.0.1
***** User Access Login *****
User:admin
Password:
Switch#2006-01-01 08:10:29,[User]/3/Login the CLI by admin on vty0 (192.168.0.200).
Switch>enable
Switch#config
Switch(config)#ip ssh server ← Enable SSH function
Switch(config)#_
```

#### Password Authentication Mode

- 1) Open PuTTY and go to the Session page. Enter the IP address of the switch in the **Host Name** field and keep the default value 22 in the **Port** field; select **SSH** as the Connection type. Click **Open**.

Figure 3-8 Configurations in PuTTY

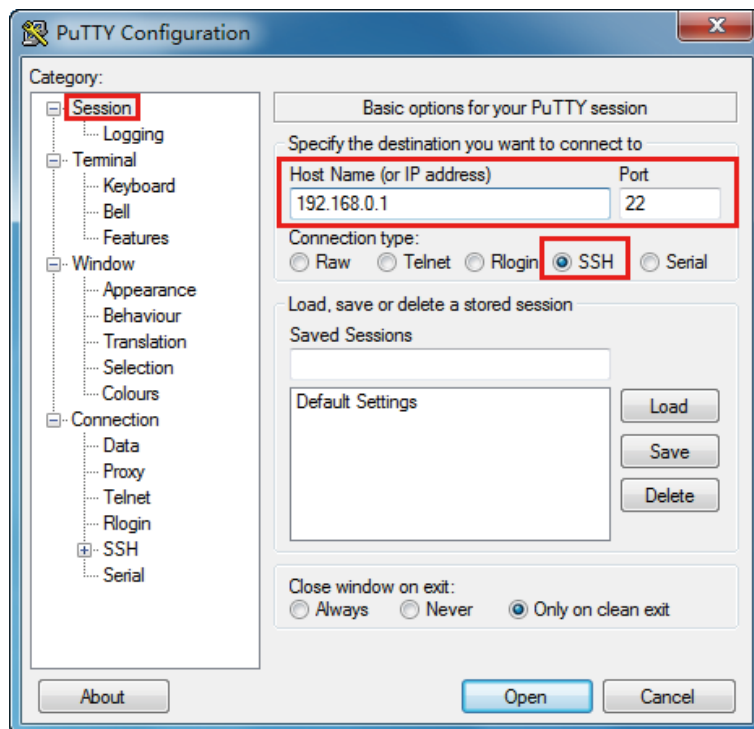

- 2) Enter the login username and password to log in to the switch, and you can continue to configure the switch.

Figure 3-9 Log In to the Switch

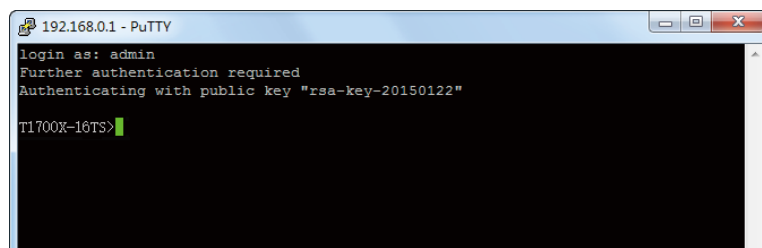

## Key Authentication Mode

- 1) Open the PuTTY Key Generator. In the Parameters section, select the key type and enter the key length. In the **Actions** section, click **Generate** to generate a public/private key pair. In the following figure, an SSH-2 RSA key pair is generated, and the length of each key is 1024 bits.



Figure 3-10 Generate a Public/Private Key Pair

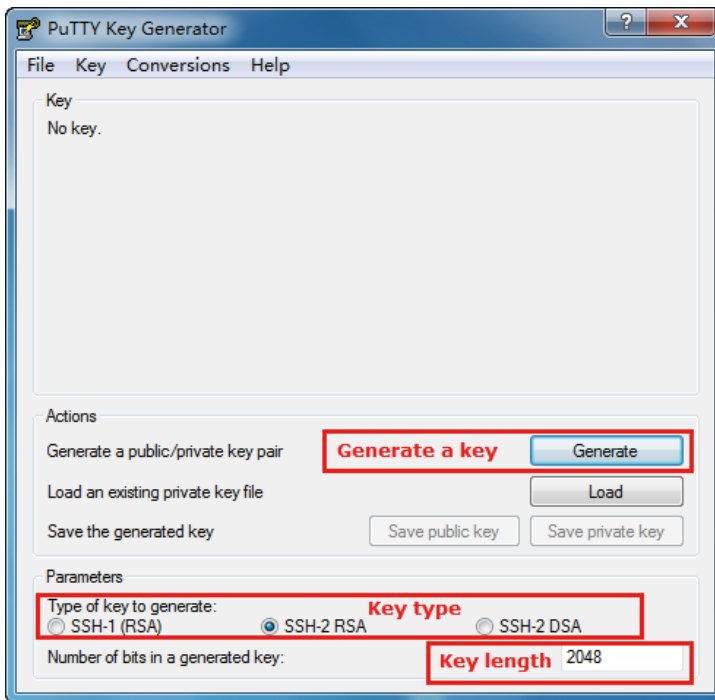

**Note:**

- The key length should be between 512 and 3072 bits.
- You can accelerate the key generation process by moving the mouse quickly and randomly in the Key section.

- 2) After the keys are successfully generated, click **Save public key** to save the public key to a TFTP server; click **Save private key** to save the private key to the host PC.

Figure 3-11 Save the Generated Keys

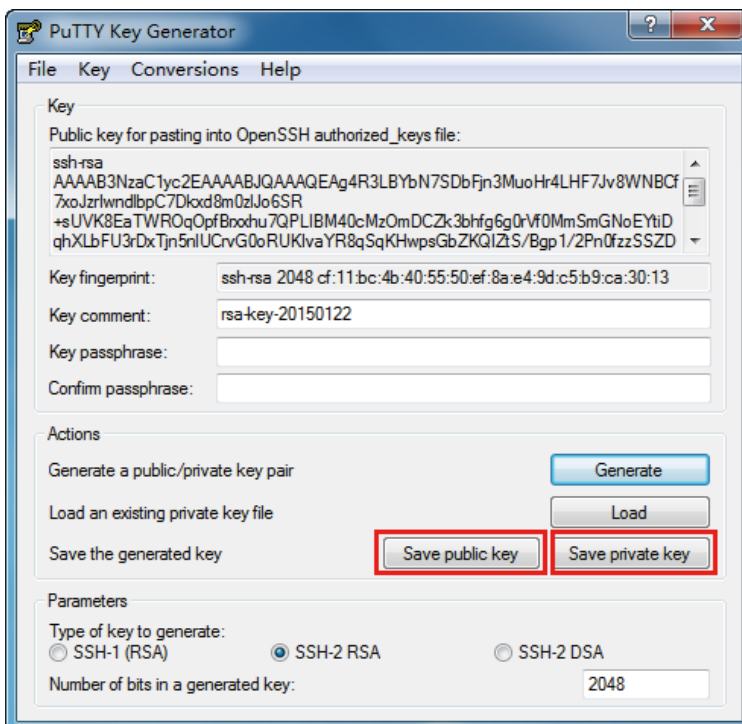

- 3) On Hyper Terminal, download the public key file from the TFTP server to the switch as shown in the following figure:

Figure 3-12 Download the Public Key to the Switch

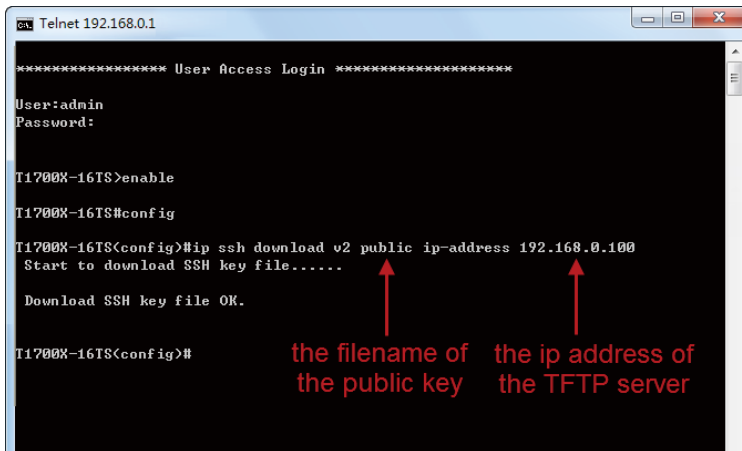

**Note:**

- The key type should accord with the type of the key file. In the above CLI, v1 corresponds to SSH-1 (RSA), and v2 corresponds to SSH-2 RSA and SSH-2 DSA.
- The key downloading process cannot be interrupted.

- 4) After the public key is downloaded, open PuTTY and go to the **Session** page. Enter the IP address of the switch and select **SSH** as the Connection type (keep the default value in the Port field).

Figure 3-13 Configure the Host Name and Connection Type

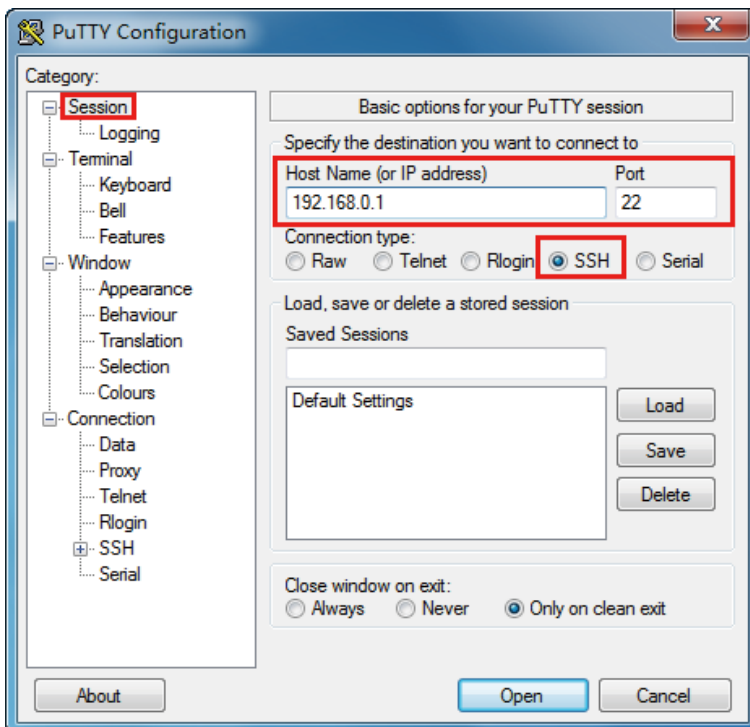

- 5) Go to **Connection > SSH > Auth**. Click **Browse** to download the private key file to PuTTY. Click **Open** to start the connection and negotiation.

Figure 3-14 Download the Private Key to PuTTY

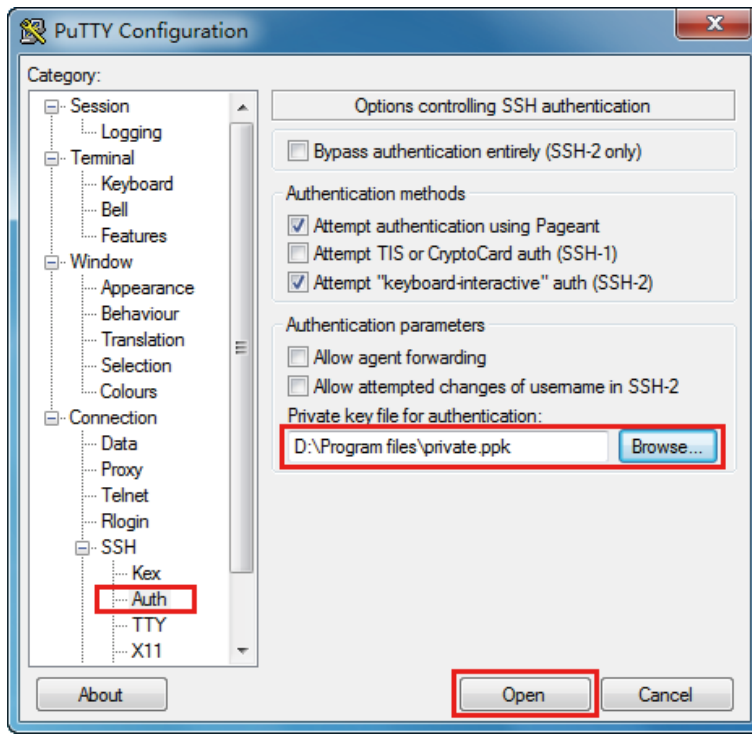

- 6) After negotiation is completed, enter the username to log in. If you can log in without entering the password, the key authentication completed successfully.

Figure 3-15 Log In to the Switch

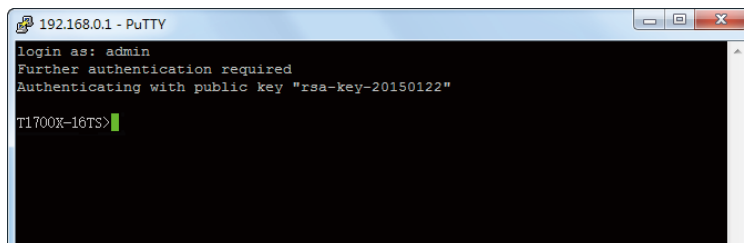

### 3.4 Disable Telnet login

You can shut down the Telnet function to block any Telnet access to the CLI interface.

- Using the GUI:

Go to **System > Access Security > Telnet Config**, disable the Telnet function and click **Apply**.

Figure 3-16 Disable Telnet login

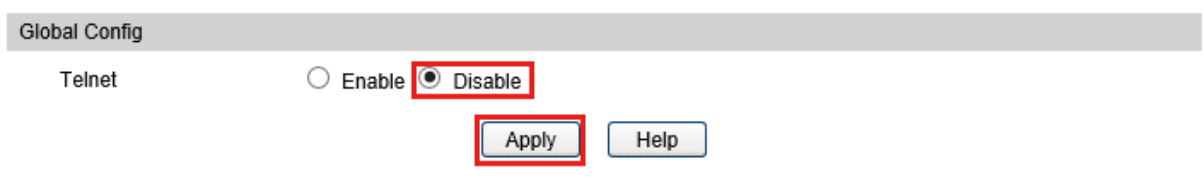

- Using the CLI:

```
Switch#configure
```

```
Switch(config)#telnet disable
```

### 3.5 Disable SSH login

You can shut down the SSH server to block any SSH access to the CLI interface.

- Using the GUI:

Go to **System > Access Security > SSH Config**, disable the SSH server and click **Apply**.

Figure 3-17 Shut down SSH server

The screenshot shows the 'Global Config' section for SSH. The 'SSH:' option has two radio buttons: 'Enable' (unselected) and 'Disable' (selected and highlighted with a red box). Below it, 'Protocol V1:' and 'Protocol V2:' both have 'Enable' selected. 'Idle Timeout:' is set to '120' seconds, and 'Max Connect:' is set to '5'. On the right side, the 'Apply' button is highlighted with a red box, and a 'Help' button is visible below it.

- Using the CLI:

```
Switch#configure
```

```
Switch(config)#no ip ssh server
```

### 3.6 Copy running-config startup-config

The switch's configuration files fall into two types: the running configuration file and the start-up configuration file.

After you enter each command line, the modifications will be saved in the running configuration file. The configurations will be lost when the switch reboots.

If you need to keep the configurations after the switch reboots, please use the command **copy running-config startup-config** to save the configurations in the start-up configuration file.

```
Switch(config)#end
```

```
Switch#copy running-config startup-config
```

## 3.7 Change the Switch's IP Address and Default Gateway

If you want to access the switch via a specified port (hereafter referred to as the access port), you can configure the port as a routed port and specify its IP address, or configure the IP address of the VLAN which the access port belongs to.

- Change the IP Address

By default, all the ports belong to VLAN 1 with the VLAN interface IP 192.168.0.1/24. In the following example, we will show how to replace the switch's default access IP address 192.168.0.1/24 with 192.168.0.10/24.

```
Switch#configure
```

```
Switch(config)#interface vlan 1
```

```
Switch(config-if)#ip address 192.168.0.10 255.255.255.0
```

The connection will be interrupted and you should telnet to the switch's new IP address 192.168.0.10.

```
C:\Users\Administrator>telnet 192.168.0.10
```

```
User:admin
```

```
Password:admin
```

```
Switch>enable
```

```
Switch#copy running-config startup-config
```

- Configure the Default Gateway

In the following example, we will show how to configure the switch's gateway as 192.168.0.100. By default, the switch has no default gateway.

```
Switch#configure
```

```
Switch(config)#ip route 0.0.0.0 255.255.255.0 192.168.0.100 1
```

```
Switch(config)#end
```

```
Switch#copy running-config startup-config
```

# Part 2

## Managing System

### CHAPTERS

1. System
2. System Info Configurations
3. User Management Configurations
4. System Tools Configurations
5. Access Security Configurations
6. SDM Template Configuration
7. Appendix: Default Parameters

# 1 System

## 1.1 Overview

The System module is mainly used to configure and view the system information of the switch. It provides controls over the type of the access users and the access security.

## 1.2 Supported Features

### System Info

The System Info is mainly used for the basic properties configuration. You can view the switch's port status and system information, and configure the device description, system time, and daylight saving time.

### User management

User Management function is used to configure the user name and password for users to log into the switch with a certain access level so as to protect the settings of the switch from being randomly changed.

### System Tools

The System Tools are used to manage the configuration file of the switch. With these tools, you can configure the boot file of the switch, backup and restore the configurations of the switch, update the firmware, reset the switch, and reboot the switch.

**Boot Config** function is used to configure the boot file of the switch uploaded before, and the switch will boot up according to your configuration file.

**Reboot Schedule** function is used to set a schedule for the switch to reboot.

### Access Security

Access Security provides different security measures for accessing the switch remotely so as to enhance the configuration management security.

**Access Control** function is used to control the users' access to the switch by filtering IP address, MAC address or port.

**HTTP Config** function is based on the HTTP protocol. It can allow or deny users to access the switch via a web browser.

**HTTPS Config** function is based on the SSL or TLS protocol working in transport layer. It supports a security access via a web browser.

**SSH Config** function is based on the SSH protocol, a security protocol established on application and transport layers. The function with SSH is similar to a telnet connection, but SSH can provide information security and powerful authentication.

### **SDM Template**

The switch SDM (Switch Database Management) templates prioritize system resources to optimize support for certain features. **SDM Template** function provides three templates for users to allocate hardware resources for different usage.



# 2 System Info Configurations

With system information configurations, you can:

- View the system summary
- Specify the device description
- Set the system time
- Set the daylight saving time

## 2.1 Using the GUI

### 2.1.1 Viewing the System Summary

Choose the menu **System > System Info > System Summary** to load the following page.





Figure 2-1 Viewing the System Summary

The screenshot displays the 'System Summary' page. At the top, there is a 'Port Status' section with a 'UNIT: 1' dropdown and 16 port indicators. Port 3 is highlighted in yellow, while others are blue. Below this is the 'System Info' section, also with 'UNIT: 1' dropdown, containing a table of system details. At the bottom of the system info section are 'Refresh' and 'Help' buttons. A legend at the bottom explains the port status icons.

System Info	
UNIT:	1
System Description:	JetStream 12-Port 10GBase-T Smart Switch with 4 10G SFP+
Device Name:	T1700X-16TS
Device Location:	SHENZHEN
Contact Information:	www.tp-link.com
Hardware Version:	T1700X-16TS 2.0
Firmware Version:	2.0.0 Build 20160909 Rel.52515(s)
Mac Address:	98-DE-D0-FB-46-19
System Time:	2006-01-02 13:46:52
Running Time:	1 day - 5 hour - 47 min - 58

  

Port Status	Indication
	Indicates that the corresponding 10Gbps port is not connected to a device.
	Indicates that the corresponding 10G port is at the speed of 10Gbps.

	Indicates that the corresponding 10Gbps port is at the speed of 100Mbps or 1000Mbps.
	Indicates that the corresponding SFP+ port is not connected to a device.
	Indicates the SFP+ port is at the speed of 10Gbps.
	Indicates the SFP+ port is at the speed of 1000Mbps.

Move the cursor to the port to view the detailed information of the port.

Figure 2-2 Port Information

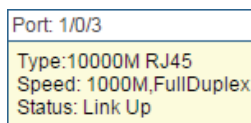

Port Information	Indication
Port	Displays the port number of the switch.
Type	Displays the type of the port.
Speed	Displays the maximum transmission rate of the port.
Status	Displays the connection status of the port.

Click a port to view the bandwidth utilization on this port.

Figure 2-3 Bnadwidth Utilization

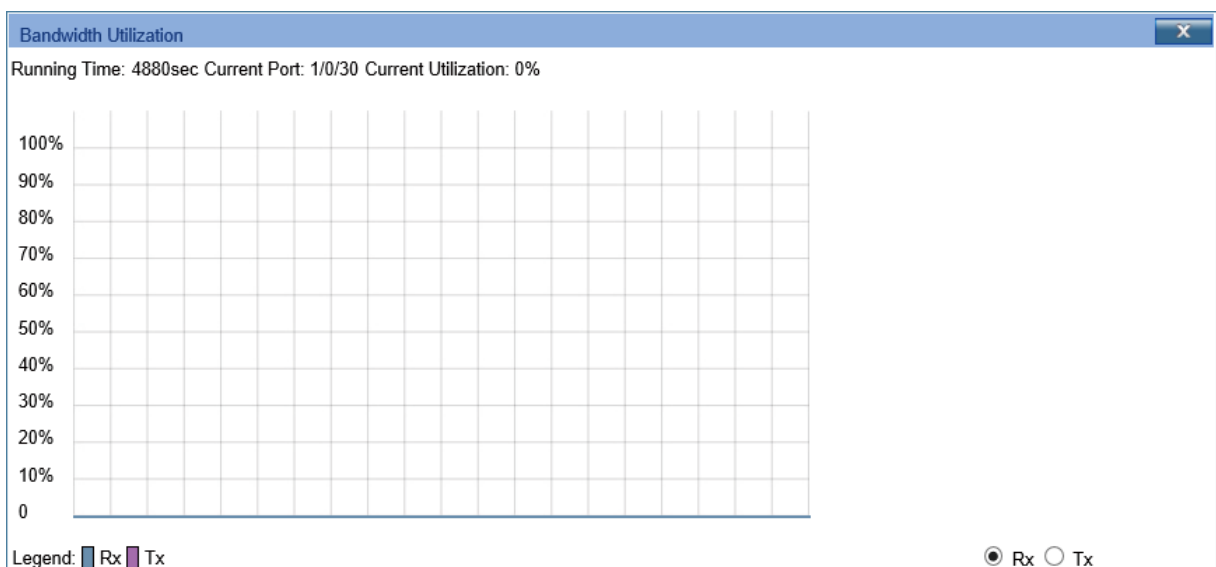

Rx	Select <b>Rx</b> to view the bandwidth utilization of receiving packets on this port.
Tx	Select <b>Tx</b> to view the bandwidth utilization of sending packets on this port.

## 2.1.2 Specifying the Device Description

Choose the menu **System > System Info > Device Description** to load the following page.

Figure 2-4 Specifying the Device Description

**Device Description**

Device Name:	T1700X-16TS	<input type="button" value="Apply"/>
Device Location:	SHENZHEN	
System Contact:	www.tp-link.com	

1) In the **Device Description** section, specify the following information.

Device Name	Enter the name of the switch.
Device Location	Enter the location of the switch.
System Contact	Enter the contact information.

2) Click **Apply**.

## 2.1.3 Setting the System Time

Choose the menu **System > System Info > System Time** to load the following page.

Figure 2-5 Setting the System Time

**Time Info**

Current System Time: 2006-01-14 06:02:45 Saturday

Current Time Source: Manual

**Time Config**

Manual

Date:

Time:

Get Time from NTP Server

Time Zone:

Primary Sever:

Secondary Sever:

Update Rate:  hour(s)

Synchronize with PC's Clock

In the **Time Info** section, view the current time information of the switch.

---

Current System Time	Displays the current date and time of the switch.
---------------------	---

---

Current Time Source	Displays the current time source of the switch.
---------------------	---

---

In the **Time Config** section, follow these steps to configure the system time:

1) Choose one method to set the system time and specify the information.

---

Manual	Set the system time manually.
--------	-------------------------------

**Date:** Specify the date of the system.

**Time:** Specify the time of the system.

---

Get Time from NTP Server	Set the system time by getting time from NTP server. Make sure the NTP server is accessible on your network. If the NTP server is on the Internet, connect the switch to the Internet first.
--------------------------	--

**Time Zone:** Select your local time zone.

**Primary Server:** Enter the IP Address of the primary NTP server.

**Secondary Server:** Enter the IP Address of the secondary NTP server.

**Update Rate:** Specify the interval the switch fetching time from NTP server, which ranges from 1 to 24 hours. The default value is 12 hours.

---

Synchronize with PC's Clock	Synchronize the system time of the switch with PC's clock.
-----------------------------	--

---

2) Click **Apply**.

## 2.1.4 Setting the Daylight Saving Time

Choose the menu **System > System Info > Daylight Saving Time** to load the following page.

Figure 2-6 Setting the Daylight Saving Time

**DST Config**

DST Status: Disable ▾

**Predefined Mode**

USA                     
  Australia                     
  Europe                     
  New Zealand

**Recurring Mode**

Offset: 60 (minutes)

Start Time: Week Last ▾ Day Sun. ▾ Month Mar. ▾ 01:00

End Time: Week Last ▾ Day Sun. ▾ Month Oct. ▾ 01:00

**Date Mode**

Offset: 60 (minutes)

Start Time: 2000 ▾ Apr. ▾ 01 ▾ 00:00 (YY/MM/DD HH:MM)

End Time: 2000 ▾ Oct. ▾ 01 ▾ 00:00 (YY/MM/DD HH:MM)

Apply
Help

Follow these steps to configure Daylight Saving Time:

- 1) In the **DST Config** section, select **Enable** to enable the Daylight Saving Time function.
- 2) Choose one method to set the Daylight Saving Time of the switch and specify the information.

<p><b>Predefined Mode</b></p>	<p>If you select <b>Predefined Mode</b>, choose a predefined DST schedule for the switch.</p> <p><b>USA:</b> Select the Daylight Saving Time of the USA. It is from 2: 00 a.m. on the Second Sunday in March to 2:00 a.m. on the First Sunday in November.</p> <p><b>Australia:</b> Select the Daylight Saving Time of Australia. It is from 2:00 a.m. on the First Sunday in October to 3:00 a.m. on the First Sunday in April.</p> <p><b>Europe:</b> Select the Daylight Saving Time of Europe. It is from 1: 00 a.m. on the Last Sunday in March to 1:00 a.m. on the Last Sunday in October.</p> <p><b>New Zealand:</b> Select the Daylight Saving Time of New Zealand. It is from 2: 00 a.m. on the Last Sunday in September to 3:00 a.m. on the First Sunday in April.</p>
<p><b>Recurring Mode</b></p>	<p>If you select <b>Recurring Mode</b>, specify a cycle time range for the Daylight Saving Time of the switch. This configuration will be used every year.</p> <p><b>Offset:</b> Specify the time to set the clock forward by.</p> <p><b>Start Time:</b> Specify the start time of Daylight Saving Time. The interval between start time and end time should be more than 1 day and less than 1 year(365 days).</p> <p><b>End Time:</b> Specify the end time of Daylight Saving Time. The interval between start time and end time should be more than 1 day and less than 1 year (365 days).</p>

---

<b>Date Mode</b>	<p>If you select <b>Date Mode</b>, specify an absolute time range for the Daylight Saving Time of the switch. This configuration will be used only one time.</p> <p><b>Offset:</b> Specify the time to set the clock forward by.</p> <p><b>Start Time:</b> Specify the start time of Daylight Saving Time. The interval between start time and end time should be more than 1 day and less than 1 year(365 days).</p> <p><b>End Time:</b> Specify the end time of Daylight Saving Time. The interval between start time and end time should be more than 1 day and less than 1 year (365 days).</p>
------------------	---

---

3) Click **Apply**.

## 2.2 Using the CLI

### 2.2.1 Viewing the System Summary

On privileged EXEC mode or any other configuration mode, you can use the following command to view the system information of the switch:

---

**show interface status [ fastEthernet *port* | gigabitEthernet *port* | ten-gigabitEthernet *port* ]**

View status of the interface.

*port*: Enter the number of the Ethernet port.

---

**show system-info**

View the system information including system Description, Device Name, Device Location, System Contact, Hardware Version, Firmware Version, System Time, Run Time and so on.

---

The following example shows how to view the interface status and the system information of the switch.

**Switch#show interface status**

Port	Status	Speed	Duplex	FlowCtrl	Jumbo	Active-Medium
-----	-----	-----	-----	-----	-----	-----
Te1/0/1	LinkDown	N/A	N/A	N/A	Disable	Copper
Te1/0/2	LinkDown	N/A	N/A	N/A	Disable	Copper
Te1/0/3	LinkUp	1000M	Full	Disable	Disable	Copper
...						
Te1/0/14	LinkDown	N/A	N/A	N/A	Disable	Fiber
Te1/0/15	LinkDown	N/A	N/A	N/A	Disable	Fiber
Te1/0/16	LinkDown	N/A	N/A	N/A	Disable	Fiber

**Switch#show system-info**

System Description - JetStream 12-Port 10GBase-T Smart Switch with 4 10G SFP+ Slots

System Name - T1700X-16TS

System Location - SHENZHEN

Contact Information - www.tp-link.com

Hardware Version - T1700X-16TS 2.0

Software Version - 2.0.0 Build 20160909 Rel.52515(s)

System Time - 2016-01-04 10:07:38

Running Time - 3 day - 2 hour - 8 min - 26 sec

## 2.2.2 Specifying the Device Description

Follow these steps to specify the device description:

Step 1	<b>configure</b> Enter global configuration mode.
Step 2	<b>hostname [ <i>hostname</i> ]</b> Specify the system name of the switch.  <i>hostname</i> : Enter the system name. The length of the name ranges from 1 to 32 characters. By default, it is the model name of the switch.
Step 3	<b>location [ <i>location</i> ]</b> Specify the system location of the switch.  <i>location</i> : Enter the device location. It should consist of no more than 32 characters. By default, it is "SHENZHEN".
Step 4	<b>contact-info [ <i>contact-info</i> ]</b> Specify the system contact Information.  <i>contact-info</i> : Enter the contact information. It should consist of no more than 32 characters. By default, it is "www.tp-link.com".
Step 5	<b>show system-info</b> Verify the system information including system Description, Device Name, Device Location, System Contact, Hardware Version, Firmware Version, System Time, Run Time and so on.
Step 6	<b>end</b> Return to privileged EXEC mode.
Step 7	<b>copy running-config startup-config</b> Save the settings in the configuration file.

The following example shows how to set the device name as Switch\_A, set the location as BEIJING and set the contact information as http://www.tp-link.com.

**Switch#configure**

**Switch(config)#hostname** Switch\_A

**Switch(config)#location** BEIJING

**Switch(config)#contact-info** http://www.tp-link.com

**Switch(config)#show system-info**

System Description - JetStream 12-Port 10GBase-T Smart Switch with 4 10G SFP+

Slots

System Name - Switch\_A

System Location - BEIJING

Contact Information - http://www.tp-link.com

...

**Switch(config)#end**

**Switch#copy running-config startup-config**

## 2.2.3 Setting the System Time

Follow these steps and choose one method to set the system time:

Step 1 **configure**

Enter global configuration mode.

Step 2 Use the following command to set the system time manually:

**system-time manual *time***

Configure the system time manually.

*time*: Specify the date and time manually in the format of MM/DD/YYYY-HH:MM:SS. The valid value of the year ranges from 2000 to 2037.

Use the following command to set the system time by getting time from the NTP server:

**system-time ntp { *timezone* } { *ntp-server* } { *backup-ntp-server* } { *fetching-rate* }**

Configure the time zone and the NTP server to get time from the NTP server. Ensure the NTP server is accessible. If the NTP server is on the Internet, connect the switch to the Internet first.

*timezone*: Enter your local time-zone, which ranges from UTC-12:00 to UTC+13:00.



---

The detailed information of each time-zone are displayed as follows:

UTC-12:00 — TimeZone for International Date Line West.  
UTC-11:00 — TimeZone for Coordinated Universal Time-11.  
UTC-10:00 — TimeZone for Hawaii.  
UTC-09:00 — TimeZone for Alaska.  
UTC-08:00 — TimeZone for Pacific Time (US Canada).  
UTC-07:00 — TimeZone for Mountain Time (US Canada).  
UTC-06:00 — TimeZone for Central Time (US Canada).  
UTC-05:00 — TimeZone for Eastern Time (US Canada).  
UTC-04:30 — TimeZone for Caracas.  
UTC-04:00 — TimeZone for Atlantic Time (Canada).  
UTC-03:30 — TimeZone for Newfoundland.  
UTC-03:00 — TimeZone for Buenos Aires, Salvador, Brasilia.  
UTC-02:00 — TimeZone for Mid-Atlantic.  
UTC-01:00 — TimeZone for Azores, Cape Verde Is.  
UTC — TimeZone for Dublin, Edinburgh, Lisbon, London.  
UTC+01:00 — TimeZone for Amsterdam, Berlin, Bern, Rome, Stockholm, Vienna.  
UTC+02:00 — TimeZone for Cairo, Athens, Bucharest, Amman, Beirut, Jerusalem.  
UTC+03:00 — TimeZone for Kuwait, Riyadh, Baghdad.  
UTC+03:30 — TimeZone for Tehran.  
UTC+04:00 — TimeZone for Moscow, St.Petersburg, Volgograd, Tbilisi, Port Louis.  
UTC+04:30 — TimeZone for Kabul.  
UTC+05:00 — TimeZone for Islamabad, Karachi, Tashkent.  
UTC+05:30 — TimeZone for Chennai, Kolkata, Mumbai, New Delhi.  
UTC+05:45 — TimeZone for Kathmandu.  
UTC+06:00 — TimeZone for Dhaka, Astana, Ekaterinburg.  
UTC+06:30 — TimeZone for Yangon (Rangoon).  
UTC+07:00 — TimeZone for Novosibirsk, Bangkok, Hanoi, Jakarta.  
UTC+08:00 — TimeZone for Beijing, Chongqing, Hong Kong, Urumqi, Singapore.  
UTC+09:00 — TimeZone for Seoul, Irkutsk, Osaka, Sapporo, Tokyo.  
UTC+09:30 — TimeZone for Darwin, Adelaide.  
UTC+10:00 — TimeZone for Canberra, Melbourne, Sydney, Brisbane.  
UTC+11:00 — TimeZone for Solomon Is., New Caledonia, Vladivostok.  
UTC+12:00 — TimeZone for Fiji, Magadan, Auckland, Wellington.  
UTC+13:00 — TimeZone for Nuku'alofa, Samoa.

*ntp-server*: Specify the IP address of the primary NTP server.

*backup-ntp-server*: Specify the IP address of the backup NTP server.

*fetching-rate*: Specify the interval fetching time from the NTP server.

---

---

Step 3 Use the following command to verify the system time information.

**show system-time**

Verify the system time information.

Use the following command to verify the NTP mode configuration information.

**show system-time ntp**

Verify the system time information of NTP mode.

---

Step 4 **end**  
Return to privileged EXEC mode.

---

Step 5 **copy running-config startup-config**  
Save the settings in the configuration file.

---

The following example shows how to set the system time by Get Time from NTP Server and set the time zone as UTC+08:00, set the NTP server as 133.100.9.2, set the backup NTP server as 139.78.100.163 and set the update rate as 11.

**Switch#configure**

**Switch(config)#system-time ntp UTC+08:00 133.100.9.2 139.78.100.163 11**

**Switch(config)#show system-time ntp**

Time zone : UTC+08:00

Prefered NTP server: 133.100.9.2

Backup NTP server: 139.78.100.163

Last successful NTP server: 133.100.9.2

Update Rate: 11 hour(s)

**Switch(config)#end**

**Switch#copy running-config startup-config**

## 2.2.4 Setting the Daylight Saving Time

Follow these steps and choose one method to set the Daylight Saving Time:

---

Step 1 **configure**  
Enter global configuration mode.

---

Step 2 Use the following command to select a predefined Daylight Saving Time configuration:

**system-time dst predefined [ USA | Australia | Europe | New-Zealand ]**

Specify the Daylight Saving Time using a predefined schedule.

**USA | Australia | Europe | New-Zealand:** Select one mode of Daylight Saving Time.

**USA:** 02:00 a.m. on the Second Sunday in March ~ 02:00 a.m. on the First Sunday in November.

**Australia:** 02:00 a.m. on the First Sunday in October ~ 03:00 a.m. on the First Sunday in April.

**Europe:** 01:00 a.m. on the Last Sunday in March ~ 01:00 a.m. on the Last Sunday in October.

**New Zealand:** 02:00 a.m. on the Last Sunday in September ~ 03:00 a.m. on the First Sunday in April.

Use the following command to set the Daylight Saving Time in recurring mode:

**system-time dst recurring { *sweek* } { *sday* } { *smonth* } { *stime* } { *eweeek* } { *eday* } { *emonth* } { *etime* } [ *offset* ]**

Specify the Daylight Saving Time in Recuring mode.

***sweek:*** Enter the start week of Daylight Saving Time. There are 5 values showing as follows: first, second, third, fourth, last.

***sday:*** Enter the start day of Daylight Saving Time. There are 7 values showing as follows: Sun, Mon, Tue, Wed, Thu, Fri, Sat.

***smonth:*** Enter the start month of Daylight Saving Time. There are 12 values showing as follows: Jan, Feb, Mar, Apr, May, Jun, Jul, Aug, Sep, Oct, Nov, Dec.

***stime:*** Enter the start time of Daylight Saving Time, in the format of HH:MM.

***eweeek:*** Enter the end week of Daylight Saving Time. There are 5 values showing as follows: first, second, third, fourth, last.

***eday:*** Enter the end day of Daylight Saving Time. There are 7 values showing as follows: Sun, Mon, Tue, Wed, Thu, Fri, Sat.

***emonth:*** Enter the end month of Daylight Saving Time. There are 12 values showing as follows: Jan, Feb, Mar, Apr, May, Jun, Jul, Aug, Sep, Oct, Nov, Dec.

***etime:*** Enter the end time of Daylight Saving Time, in the format of HH:MM.

***offset:*** Enter the offset of Daylight Saving Time. The default value is 60.

Use the following command to set the Daylight Saving Time in date mode:

**system-time dst date { *smonth* } { *sday* } { *stime* } { *syear* } { *emonth* } { *eday* } { *etime* } { *eyear* } [ *offset* ]**

Specify the Daylight Saving Time in Date mode.

*smonth*: Enter the start month of Daylight Saving Time. There are 12 values showing as follows: Jan, Feb, Mar, Apr, May, Jun, Jul, Aug, Sep, Oct, Nov, Dec.

*sday*: Enter the start day of Daylight Saving Time, which ranges from 1 to 31.

*stime*: Enter the start time of Daylight Saving Time, in the format of HH:MM.

*year*: Enter the start year of Daylight Saving Time.

*emonth*: Enter the end month of Daylight Saving Time. There are 12 values showing as follows: Jan, Feb, Mar, Apr, May, Jun, Jul, Aug, Sep, Oct, Nov, Dec.

*eday*: Enter the end day of Daylight Saving Time, which ranges from 1 to 31.

*etime*: Enter the end time of Daylight Saving Time, in the format of HH:MM.

*eyear*: Enter the end year of Daylight Saving Time.

*offset*: Enter the offset of Daylight Saving Time. The default value is 60.

---

Step 3    **show system-time dst**  
Verify the DST information of the switch.

---

Step 4    **end**  
Return to privileged EXEC mode.

---

Step 5    **copy running-config startup-config**  
Save the settings in the configuration file.

---

The following example shows how to set the Daylight Saving Time by Date Mode. Set the start time as 01:00 August 1st, 2016, set the end time as 01:00 September 1st, 2016 and set the offset as 50.

### Switch#configure

```
Switch(config)#system-time dst date Aug 1 01:00 2016 Sep 1 01:00 2016 50
```

### Switch(config)#show system-time dst

```
DST starts at 01:00:00 on Aug 1 2016
```

```
DST ends at 01:00:00 on Sep 1 2016
```

```
DST offset is 50 minutes
```

```
DST configuration is one-off
```

### Switch(config)#end

### Switch#copy running-config startup-config

# 3 User Management Configurations

With user management configurations, you can:

- Create Admin accounts
- Create accounts of other types

## 3.1 Using the GUI

### 3.1.1 Creating Admin Accounts

Choose the menu **System > User Management > User Config** to load the following page.

Figure 3-1 Create Admin Accounts

**User Info**

User Name:

Access Level:  ▼

Password:

Confirm Password:

**User Table**

Select	User ID	User Name	Access Level	Operation
<input type="checkbox"/>	1	admin	Admin	<a href="#">Edit</a>

Follow these steps to create an Admin account:

- 1) In the **User Info** section, select Admin from the drop-down list and specify the user name and password.

<b>User Name</b>	Create a user name for users' login. It contains 16 characters at most, composed of digits, English letters and underscore only.
------------------	--

<b>Access Level</b>	<p>Select the access level as <b>Admin</b>.</p> <p><b>Admin:</b> Admin can edit, modify and view all the settings of different functions.</p> <p><b>Operator:</b> Operator can edit, modify and view most of the settings of different functions.</p> <p><b>Power User:</b> Power User can edit, modify and view some of the settings of different functions.</p> <p><b>User:</b> User can only view the settings without the right to edit or modify.</p>
<b>Password</b>	Type a password for users' login. It is a string from 1 to 31 alphanumeric characters or symbols. You can use digits, English letters (case sensitive), underscore and sixteen special characters.
<b>Confirm Password</b>	Retype the password.

2) Click **Create**.

### 3.1.2 Creating Accounts of Other Types

You can create accounts with the access level of Operator, Power User and User here. You also need to go to the **AAA** section to create an Enable Password for these accounts. The Enable Password is used to change the users' access level to Admin.

- **Creating an Account**

Choose the menu **System > User Management > User Config** to load the following page.

Figure 3-2 Create Accounts of Other Types

**User Info**

User Name:

Access Level: User ▼

Password:

Confirm Password:

Create
Clear

**User Table**

Select	User ID	User Name	Access Level	Operation
<input type="checkbox"/>	1	admin	Admin	<a href="#">Edit</a>

All
Delete
Help

Follow these steps to create an account of other types:

- 1) In the **User Info** section, select the access level from the drop-down list and specify the user name and password.

User Name	Create a user name for users' login. It contains 16 characters at most, composed of digits, English letters and under dashes only.
Access Level	Select the access level as <b>Operator</b> , <b>Power User</b> or <b>User</b> .  <b>Admin:</b> Admin can edit, modify and view all the settings of different functions.  <b>Operator:</b> Operator can edit, modify and view most of the settings of different functions.  <b>Power User:</b> Power User can edit, modify and view some of the settings of different functions.  <b>User:</b> User can only view the settings without the right to edit or modify.
Password	Type a password for users' login. It is a string from 1 to 31 alphanumeric characters or symbols. You can use digits, English letters (case sensitive), underscore and sixteen special characters.
Confirm Password	Retype the password.

2) Click **Create**.

#### ■ Configuring Enable Password

Choose the menu **Network Security > AAA > Global Config** to load the following page.

Figure 3-3 Configure the AAA Function

The screenshot shows a web interface for configuring the AAA function. It consists of two main sections. The first section, titled 'Global Config', contains the 'AAA:' label, two radio buttons labeled 'Enable' and 'Disable' (with 'Disable' selected), and an 'Apply' button. The second section, titled 'Enable Admin', contains a text input field labeled 'Enable Password:' and another 'Apply' button.

1) Select **Enable** and Click **Apply** to enable the **AAA** function.

2) Specify the Enable Password and Click **Apply**.

#### *Tips:*

- The **AAA** function applies another method to manage the access users' name and password. For details, refer to [AAA Configuration](#) in [Configuring Network Security](#).
- The logged-in users can enter the Enable Password on this page to get the administrative privileges.

## 3.2 Using the CLI

### 3.2.1 Creating Admin Accounts

Follow these steps to create an Admin account:

---

Step 1     **configure**

Enter global configuration mode.

---

Step 2     Use the following command to create an account unencrypted or symmetric encrypted.

**user name** *name* { **privilege** admin } **password** { [ 0 ] *password* | 7 *encrypted-password* }

Create an account whose access level is Admin.

*name*: Enter a user name for users' login. It contains 16 characters at most, composed of digits, English letters and underscore only.

*admin*: Select the access level for the user. Admin can edit, modify and view all the settings of different functions.

0: Specify the encryption type. 0 indicates that the password you entered is unencrypted, and the password is saved to the configuration file unencrypted. By default, the encryption type is 0.

*password*: Enter a password for users' login. It is a string from 1 to 31 alphanumeric characters or symbols. The password is case sensitive, allows digits, English letters (case sensitive), underlines and sixteen special characters.

7: Specify the encryption type. 7 indicates that the password you entered is symmetric encrypted, and the password is saved to the configuration file symmetric encrypted.

*encrypted-password*: Enter a symmetric encrypted password with fixed length, which you can copy from another switch's configuration file. After the encrypted password is configured, you should use the corresponding unencrypted password to reenter this mode.

Use the following command to create an account MD5 encrypted.

**user name** *name* { **privilege** admin } **secret** { [ 0 ] *password* | 5 *encrypted-password* }

Create an account whose access level is Admin.

*name*: Enter a user name for users' login. It contains 16 characters at most, composed of digits, English letters and underscore only.

*admin*: Select the access level for the user. Admin can edit, modify and view all the settings of different functions.

0: Specify the encryption type. 0 indicates that the password you entered is unencrypted, but the password is saved to the configuration file MD5 encrypted. By default, the encryption type is 0.

*password*: Enter a password for users' login. It is a string from 1 to 31 alphanumeric characters or symbols. The password is case sensitive, allows digits, English letters (case sensitive), underlines and sixteen special characters.

5: Specify the encryption type. 5 indicates that the password you entered is MD5 encrypted, and the password is saved to the configuration file MD5 encrypted.

*encrypted-password*: Enter a MD5 encrypted password with fixed length, which you can copy from another switch's configuration file.

---



- 
- Step 3     **show user account-list**  
Verify the information of the current users.
- 
- Step 4     **end**  
Return to privileged EXEC mode.
- 
- Step 5     **copy running-config startup-config**  
Save the settings in the configuration file.
- 

### 3.2.2 Creating Accounts of Other Types

You can create accounts with the access level of Operator, Power user and User here. You also need to go to the **AAA** section to create an Enable Password for these accounts. The Enable Password is used to change the users' access level to Admin.

Follow these steps to create an account of other type:

- 
- Step 1     **configure**  
Enter global configuration mode.
-

---

Step 2 Use the following command to create an account unencrypted or symmetric encrypted.

**user name** *name* { **privilege** operator | power\_user | user } **password** { [ 0 ] *password* | 7 *encrypted-password* }

Create an account whose access level is Operator, Power User or User.

*name*: Enter a user name for users' login. It contains 16 characters at most, composed of digits, English letters and underscore only.

**operator** | **power\_user** | **user**: Select the access level for the user. Operator can edit, modify and view mostly the settings of different functions. Power User can edit, modify and view some the settings of different functions. User only can view the settings without the right to edit and modify.

**0**: Specify the encryption type. 0 indicates that the password you entered is unencrypted, and the password is saved to the configuration file unencrypted. By default, the encryption type is 0.

*password*: Enter a password for users' login. It is a string from 1 to 31 alphanumeric characters or symbols. The password is case sensitive, allows digits, English letters (case sensitive), underlines and sixteen special characters.

**7**: Specify the encryption type. 7 indicates that the password you entered is symmetric encrypted, and the password is saved to the configuration file symmetric encrypted.

*encrypted-password*: Enter a symmetric encrypted password with fixed length, which you can copy from another switch's configuration file. After the encrypted password is configured, you should use the corresponding unencrypted password to reenter this mode.

Use the following command to create an account MD5 encrypted.

**user name** *name* { **privilege** operator | power\_user | user } **secret** { [ 0 ] *password* | 5 *encrypted-password* }

Create an account whose access level is Operator, Power User or User.

*name*: Enter a user name for users' login. It contains 16 characters at most, composed of digits, English letters and underscore only.

**operator** | **power\_user** | **user**: Select the access level for the user. Operator can edit, modify and view mostly the settings of different functions. Power User can edit, modify and view some the settings of different functions. User only can view the settings without the right to edit and modify.

**0**: Specify the encryption type. 0 indicates that the password you entered is unencrypted, but the password is saved to the configuration file MD5 encrypted. By default, the encryption type is 0.

*password*: Enter a password for users' login. It is a string from 1 to 31 alphanumeric characters or symbols. The password is case sensitive, allows digits, English letters (case sensitive), underlines and sixteen special characters.

**5**: Specify the encryption type. 5 indicates that the password you entered is MD5 encrypted, and the password is saved to the configuration file MD5 encrypted.

*encrypted-password*: Enter a MD5 encrypted password with fixed length, which you can copy from another switch's configuration file. After the encrypted password is configured, you should use the corresponding unencrypted password to reenter this mode.

---

Step 3 **aaa enable**

Globally enable the AAA function.

---

- 
- Step 4 Use the following command to create an enable password unencrypted or symmetric encrypted.
- enable admin password** {[ 0 ] *password* | 7 *encrypted-password* }
- Create an Enable Password. It can change the users' access level to Admin. By default, it is empty.
- 0: Specify the encryption type. 0 indicates that the password you entered is unencrypted, and the password is saved to the configuration file unencrypted. By default, the encryption type is 0.
- password*: Enter an enable password. It is a string from 1 to 31 alphanumeric characters or symbols. The password is case sensitive, allows digits, English letters (case sensitive), underlines and sixteen special characters.
- 7: Specify the encryption type. 7 indicates that the password you entered is symmetric encrypted, and the password is saved to the configuration file symmetric encrypted.
- encrypted-password*: Enter a symmetric encrypted password with fixed length, which you can copy from another switch's configuration file. After the encrypted password is configured, you should use the corresponding unencrypted password to reenter this mode.
- Use the following command to create an enable password unencrypted or MD5 encrypted.
- enable admin secret** {[ 0 ] *password* | 5 *encrypted-password* }
- Create an Enable Password. It can change the users' access level to Admin. By default, it is empty.
- 0: Specify the encryption type. 0 indicates that the password you entered is unencrypted, but the password is saved to the configuration file MD5 encrypted. By default, the encryption type is 0.
- password*: Enter an enable password. It is a string from 1 to 31 alphanumeric characters or symbols. The password is case sensitive, allows digits, English letters (case sensitive), underlines and sixteen special characters.
- 5: Specify the encryption type. 5 indicates that the password you entered is MD5 encrypted, and the password is saved to the configuration file MD5 encrypted.
- encrypted-password*: Enter a MD5 encrypted password with fixed length, which you can copy from another switch's configuration file. After the encrypted password is configured, you should use the corresponding unencrypted password to reenter this mode.
- 
- Step 5 **show user account-list**  
Verify the information of the current users.
- 
- Step 6 **end**  
Return to privileged EXEC mode.
- 
- Step 7 **copy running-config startup-config**  
Save the settings in the configuration file.
- 

*Tips:*

- The **AAA** function applies another method to manage the access users' name and password. For details, refer to [AAA Configuration in Configuring Network Security](#) .
- The logged-in users can enter the Enable Password on this page to get the administrative privileges.

The following example shows how to create a user with the access level of Operator, set the user name as user1 and set the password as 123. Enable AAA function and set the enable password as abc123.

**Switch#configure**

**Switch(config)#user name user1 privilege operator password 123**

**Switch(config)#aaa enable**

**Switch(config)#enable admin password abc123**

**Switch(config)#show user account-list**

Index	User-Name	User-Type
-----	-----	-----
1	user1	Operator
2	admin	Admin

**Switch(config)#end**

**Switch#copy running-config startup-config**

# 4 System Tools Configurations

With system tools configurations, you can:

- Configure the boot file
- Restore the configuration of the switch
- Back up the configuration file
- Upgrade the firmware
- Reboot the switch
- Configure the reboot schedule
- Reset the switch

## 4.1 Using the GUI

### 4.1.1 Configuring the Boot File

Choose the menu **System > System Tools > Boot Config** to load the following page.

Figure 4-1 Configuring the Boot File

Boot Table				
Select	Unit	Current Startup Image	Next Startup Image	Backup Image
<input type="checkbox"/>			image1.bin ▼	image2.bin ▼
<input type="checkbox"/>	1	image2.bin	image2.bin	image1.bin

Image Table	
UNIT:	1
+ Current Startup Image	Exist & OK
+ Next Startup Image	Exist & OK
+ Backup Image	Exist & OK

Follow these steps to configure the boot file:

- 1) In the **Boot Table** section, select one or more units and configure the relevant parameters.

Select	Select one or more units to be configured.
Unit	Displays the number of the unit.
Current Startup Image	Displays the current startup image.
Next Startup Image	Select the next startup image. When the switch is powered on, it will try to start up with the next startup image. The next startup and backup image should not be the same.
Backup Image	Select the backup image. When the switch fails to start up with the next startup image, it will try to start up with the backup image. The next startup and backup image should not be the same.

2) Click **Apply**.

### 4.1.2 Restoring the Configuration of the Switch

Choose the menu **System > System Tools > Config Restore** to load the following page.

Figure 4-2 Restoring the Configuration of the Switch

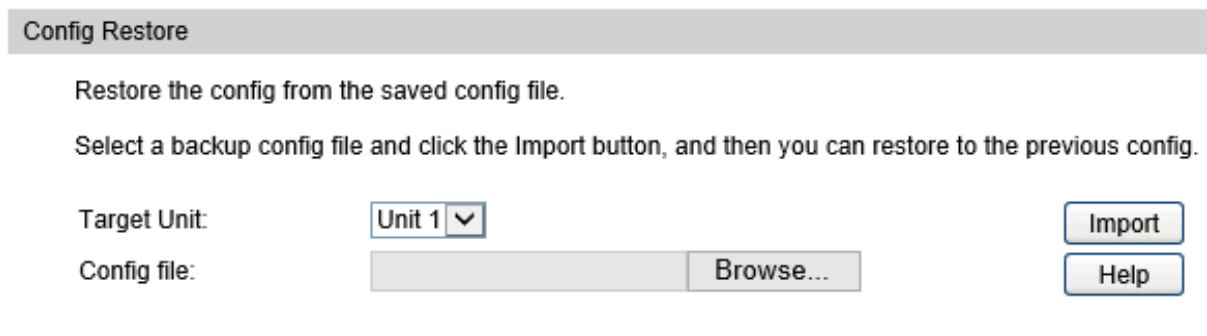

Follow these steps to restore the configuration of the switch:

1) In the **Config Restore** section, select one unit and one configuration file.

Target Unit	Select a member switch to import configuration file. .
Config file	Select the desired configuration file to import.

2) Click **Import** to import the configuration file.

 **Note:**

- It will take a long time to restore the configuration. Please wait without any operation.
- After the configuration is restored successfully, the device will reboot to make the configuration change effective.

### 4.1.3 Backing up the Configuration File

Choose the menu **System > System Tools > Config Backup** to load the following page.

Figure 4-3 Backing up the Configuration File

**Config Backup**

Export current startup configuration file.

Click the button **Export**, you can save the config to your computer.

Target Unit: Unit 1 ▼

Export  
Help

In the **Config Backup** section, select one unit and click **Export** to export the configuration file.

### 4.1.4 Upgrading the Firmware

Choose the menu **System > System Tools > Firmware Upgrade** to load the following page.

Figure 4-4 Upgrading the Firmware

**Firmware Upgrade**

You will get the new function after upgrading the firmware.

Firmware File:  Browse...

Image Name: Backup Image

Firmware Version: 2.0.0 Build 20160909 Rel.52515(s)

Hardware Version: T1700X-16TS 2.0

Upgrade  
Help

After upgrading, the device will reboot automatically with the backup image

In the **Firmware Upgrade** section, select one file and click **Upgrade** to upgrade the system.

Firmware File	Select the desired firmware file to upgrade the system.
Image Name	Displays the image to upgrade. It means that the operation will only effect the backup image.
Firmware Version	Displays the current firmware version of the system.
Hardware Version	Displays the current hardware version of the system.

After upgrading, the device will reboot automatically with the backup image

Select this option to reboot automatically with the backup image after upgrading.

### 4.1.5 Rebooting the switch

Choose the menu **System > System Tools > System Reboot** to load the following page.

Figure 4-5 Rebooting the switch

**System Reboot**

Target Unit: All Unit ▼

Save Config:

Reboot: Reboot

In the **System Reboot** section, select the desired unit and click **Reboot**.

Target Unit	Select the desired unit to reboot. By default, it is ALL Unit.
Save Config	Select this option to save the configuration before the reboot.

### 4.1.6 Configuring the Reboot Schedule

Choose the menu **System > System Tools > Reboot Schedule** to load the following page.

Figure 4-6 Configuring the Reboot Schedule

**Reboot Schedule Setting**

Time Interval(1-43200):  min

Time (HH:MM):

Date (DD/MM/YY):

Save Before Reboot :

Delete
Apply

Follow these steps to restore the configuration of the switch:

- 1) In the **Reboot Schedule Setting** section, select one method and specify the parameters.

Time Interval	Specify a period of time. The switch will reboot after this period. The valid values are from 1 to 43200 minutes. This reboot schedule recurs if users check the <b>Save Before Reboot</b> .
---------------	--



Time (HH:MM)/ Date (DD/MM/ YY)	Specify the date and time for the switch to reboot.  <b>Time (HH:MM):</b> Specify the time for the switch to reboot, in the format of HH:MM  <b>Date (DD/MM/YY):</b> Specify the date for the switch to reboot, in the format of DD/MM/YYYY. The date should be within 30 days.
Save Before Reboot	Select to save the switch's configurations before it reboots.

### 4.1.7 Resetting the Switch

Choose the menu **System > System Tools > System Reset** to load the following page.

Figure 4-7 Resetting the Switch



In the **System Reset** section, select the desired unit and click **Reset**.

Target Unit	Select the desired unit to reset. By default, it is ALL Unit.
-------------	---

 **Note:**

After the system is reset, configurations of the switch will be reset to the default.

## 4.2 Using the CLI

### 4.2.1 Configuring the Boot File

Follow these steps to configure the boot file:

Step 1	<b>configure</b> Enter global configuration mode.
Step 2	<b>boot application filename { image1   image2 } { startup   backup }</b> Specify the configuration of the boot file. By default, the image1.bin is the startup image and the image2.bin is the backup image.  image1   image2: Select the image file to be configured. startup   backup: Select the property of the image file.
Step 3	<b>show boot</b> Verify the boot configuration of the system.

---

Step 4     **end**  
Return to privileged EXEC mode.

---

Step 5     **copy running-config startup-config**  
Save the settings in the configuration file.

---

The following example shows how to set the next startup image as image 1 and set the backup image as image 2.

**Switch#configure**

**Switch(config)#boot application filename image1 startup**

**Switch(config)#boot application filename image2 backup**

**Switch(config)#show boot**

Boot config:

Current Startup Image     - image1.bin

Next Startup Image       - image1.bin

Backup Image              - image2.bin

**Switch(config)#end**

**Switch#copy running-config startup-config**

## 4.2.2 Restoring the Configuration of the Switch

Follow these steps to restore the configuration of the switch:

---

Step 1     **enable**  
Enter privileged mode.

---

Step 2     **copy tftp startup-config ip-address *ip-addr* filename *name***  
Download the configuration file to the switch from TFTP server.

*ip-addr*: Specify the IP address of the TFTP server. Both IPv4 and IPv6 addresses are supported.

*name*: Specify the name of the configuration file to be downloaded.

---

### Note:

- It will take a long time to restore the configuration. Please wait without any operation.
  - After the configuration is restored successfully, the device will reboot to make the configuration change effective.
- 

The following example shows how to restore the configuration file named file1 from the TFTP server with IP address 192.168.0.100.

**Switch>enable**

**Switch#copy tftp startup-config ip-address 192.168.0.100 filename file1**

Start to load user config file.....

Operation OK! Now rebooting system.....

### 4.2.3 Backing up the Configuration File

Follow these steps to back up the current configuration of the switch in a file:

---

Step 1     **enable**

Enter privileged mode.

---

Step 2     **copy startup-config tftp ip-address *ip-addr* filename *name***

Back up the configuration file to TFTP server.

*ip-addr*: Specify the IP address of the TFTP server. Both IPv4 and IPv6 addresses are supported.

*name*: Specify the name of the configuration file to be saved.

---

The following example shows how to backup the configuration file named file2 from TFTP server with IP address 192.168.0.100.

**Switch>enable**

**Switch#copy startup-config tftp ip-address 192.168.0.100 filename file2**

Start to backup user config file.....

Backup user config file OK.

### 4.2.4 Upgrading the firmware

Follow these steps to upgrade the firmware:

---

Step 1     **enable**

Enter privileged mode.

---

Step 2     **firmware upgrade ip-address *ip-addr* filename *name***

Upgrade the switch's backup image via TFTP server. To boot up with the new firmware, you need to choose to reboot the switch with the backup image.

*ip-addr*: Specify the IP address of the TFTP server. Both IPv4 and IPv6 addresses are supported.

*name*: Specify the name of the desired firmware file.

---

Step 3     Enter Y to continue then enter Y to reboot.

---

The following example shows how to upgrade the firmware using the configuration file named file3.bin. The TFTP server is 190.168.0.100.

**Switch>enable**

**Switch#firmware upgrade ip-address** 192.168.0.100 **filename** file3.bin

It will only upgrade the backup image. Continue? (Y/N):Y

Operation OK!

Reboot with the backup image? (Y/N): Y

## 4.2.5 Rebooting the switch

Follow these steps to reboot the switch:

---

Step 1     **enable**  
Enter privileged mode.

---

Step 2     **reboot**  
Reboot the switch.

---

## 4.2.6 Configuring the Reboot Schedule

Follow these steps and choose one type to configure the reboot schedule:

---

Step 1     **configure**  
Enter global configuration mode.

---

Step 2     Use the following command to set the interval to reboot:

**reboot-schedule in *interval* [ *save\_before\_reboot* ]**

(Optional) Specify the reboot schedule.

*interval*: Specify a period of time. The switch will reboot after this period. The valid values are from 1 to 43200 minutes.

**save\_before\_reboot**: Save the configuration file before the switch reboots.

Use the following command to set the time and date to reboot:

**reboot-schedule at *time* [ *date* ] [ *save\_before\_reboot* ]**

(Optional) Specify the reboot schedule.

*time*: Specify the time for the switch to reboot, in the format of HH:MM.

*date*: Specify the date for the switch to reboot, in the format of DD/MM/YYYY. The date should be within 30 days.

**save\_before\_reboot**: Save the configuration file before the switch reboots.

If no date is specified, the switch reboots according to the time you have set. If the time you set is later than the time that this command is executed, the switch will reboot later the same day; otherwise the switch will reboot the next day.

---

---

Step 3     **end**  
Return to privileged EXEC mode.

---

Step 4     **copy running-config startup-config**  
Save the settings in the configuration file.

---

The following example shows how to set the switch to reboot at 12:00 on 15/01/2016.

**Switch#configure**

**Switch(config)#reboot-schedule at 12:00 15/01/2016 save\_before\_reboot**

Reboot system at 15/01/2016 12:00. Continue? (Y/N): Y

Reboot Schedule Settings

-----

Reboot schedule at 2016-01-15 12:00 (in 17007 minutes)

Save before reboot: Yes

**Switch(config)#end**

**Switch#copy running-config startup-config**

## 4.2.7 Resetting the Switch

Follow these steps to reset the switch:

---

Step 1     **enable**  
Enter privileged mode.

---

Step 2     **reset**  
Reset the switch.

---

---

 **Note:**

After the system is reset, configurations of the switch will be reset to the default.

---

# 5 Access Security Configurations

With access security configurations, you can:

- Configure the Access Control feature
- Configure the HTTP feature
- Configure the HTTPS feature
- Configure the SSH feature
- Enable the telnet function

## 5.1 Using the GUI

### 5.1.1 Configuring the Access Control Feature

Choose the menu **System > Access Security > Access Control** to load the following page.

Figure 5-1 Configuring the Access Control

**Access Control Config**

Control Mode:  ▼

Access Interface:  SNMP  Telnet  SSH  HTTP  HTTPS  Ping  All

IP Address:  Mask:

MAC Address:  (Format: 00-00-00-00-00-01)

- 1) In the **Access Control** section, select one control mode and specify the parameters.

<b>Control Mode</b>	<p>Select the control mode for users to log in to the web management page.</p> <p><b>Disable:</b> The Access Control function is disabled.</p> <p><b>IP-based:</b> Only the users within the IP-range you set here are allowed to access the switch.</p> <p><b>MAC-based:</b> Only the users with the MAC address you set here are allowed to access the switch.</p> <p><b>Port-based:</b> Only the users connecting to the ports you set here are allowed to access the switch.</p>
---------------------	--

<b>Access Interface</b>	<p>Select the interface to control the methods for users' accessing. The selected access interfaces will only affect the users you set before.</p> <p><b>SNMP:</b> A function to manage the network devices via NMS.</p> <p><b>Telnet:</b> A connection type for users to remote login.</p> <p><b>SSH:</b> A connection type based on SSH protocol.</p> <p><b>HTTP:</b> A connection type based on HTTP protocol.</p> <p><b>HTTPS:</b> A connection type based on SSL protocol.</p> <p><b>Ping:</b> A communication protocol to test the connection of the network.</p>
<b>IP Address/Mask</b>	<p>If you select <b>IP-based</b> mode, enter the IP address and mask to specify an IP range. Only the users within this IP range can access the switch.</p>
<b>MAC Address</b>	<p>If you select <b>MAC-based</b> mode, specify the MAC address. Only the users with the correct MAC address can access the switch.</p>

When the **IP-based** mode is selected, the following section will display.

IP Entry Table				
Select	Index ID	IP Address	Access Interface	Operation
<input type="checkbox"/>	1	192.168.0.0/16	SNMP Telnet SSH HTTP HTTPS Ping	<a href="#">Edit</a>

<b>IP Address</b>	Displays the IP range of the entry.
<b>Access Interface</b>	Displays the access interface you set of the entry.
<b>Operation</b>	Click <b>Edit</b> to modify the parameters of the desired entry.

When the **Port-based** mode is selected, the following section will display.

**Port:**

UNIT:

<input type="checkbox"/> 2	<input type="checkbox"/> 4	<input type="checkbox"/> 6	<input type="checkbox"/> 8	<input type="checkbox"/> 10	<input type="checkbox"/> 12	<input type="checkbox"/> 14	<input type="checkbox"/> 16
<input type="checkbox"/> 1	<input type="checkbox"/> 3	<input type="checkbox"/> 5	<input type="checkbox"/> 7	<input type="checkbox"/> 9	<input type="checkbox"/> 11	<input type="checkbox"/> 13	<input type="checkbox"/> 15

Unselected Port(s)   
  Selected Port(s)   
  Not Available for Selection

<b>Port</b>	<p>Select one or more ports to configure. Only the users connected to these ports are allowed to access the switch.</p>
-------------	---

2) Click **Apply**.

## 5.1.2 Configuring the HTTP Function

Choose the menu **System > Access Security > HTTP Config** to load the following page.

Figure 5-2 Configuring the HTTP Function

Global Config	
HTTP:	<input checked="" type="radio"/> Enable <input type="radio"/> Disable <span style="float: right;"> <input type="button" value="Apply"/>  <input type="button" value="Help"/> </span>
Session Config	
Session Timeout:	<input type="text" value="30"/> min (5-30) <span style="float: right;"><input type="button" value="Apply"/></span>
Access User Number	
Number Control:	<input type="radio"/> Enable <input checked="" type="radio"/> Disable <span style="float: right;"><input type="button" value="Apply"/></span>
Admin Number:	<input type="text"/> (1-16)
Guest Number:	<input type="text"/> (0-15)

- 1) In the **Global Control** section, Select **Enable** and click **Apply** to enable the HTTP function.

<b>HTTP</b>	HTTP function is based on the HTTP protocol. It allows users to manage the switch through a web browser.
-------------	--

- 2) In the **Session Config** section, specify the Session Timeout and click **Apply**.

<b>Session Timeout</b>	The system will log out automatically if users do nothing within the Session Timeout time.
------------------------	--

- 3) In the **Access User Number** section, select **Enable** and specify the parameters.

<b>Number Control</b>	Select <b>Enable</b> to control the number of the users logging on to the web management page at the same time. The total number of users should be no more than 16.
-----------------------	--

<b>Admin Number</b>	Specify the maximum number of users whose access level is Admin.
---------------------	--

<b>Guest Number</b>	Specify the maximum number of users whose access level is Operator, Power User or User.
---------------------	---

- 4) Click **Apply**.



### 5.1.3 Configuring the HTTPS Function

Choose the menu **System > Access Security > HTTPS Config** to load the following page.

Table 5-1 Configuring the HTTPS Function

Global Config		
HTTPS:	<input checked="" type="radio"/> Enable <input type="radio"/> Disable	<input type="button" value="Apply"/> <input type="button" value="Help"/>
SSL Version 3:	<input checked="" type="radio"/> Enable <input type="radio"/> Disable	
TLS Version 1:	<input checked="" type="radio"/> Enable <input type="radio"/> Disable	
CipherSuite Config		
RSA_WITH_RC4_128_MD5:	<input checked="" type="radio"/> Enable <input type="radio"/> Disable	<input type="button" value="Apply"/>
RSA_WITH_RC4_128_SHA:	<input checked="" type="radio"/> Enable <input type="radio"/> Disable	
RSA_WITH_DES_CBC_SHA:	<input checked="" type="radio"/> Enable <input type="radio"/> Disable	
RSA_WITH_3DES_EDE_CBC_SHA:	<input checked="" type="radio"/> Enable <input type="radio"/> Disable	
Session Config		
Session Timeout:	<input type="text" value="10"/> min (5-30)	<input type="button" value="Apply"/>
Access User Number		
Number Control:	<input type="radio"/> Enable <input checked="" type="radio"/> Disable	<input type="button" value="Apply"/>
Admin Number:	<input type="text"/> (1-16)	
Guest Number:	<input type="text"/> (0-15)	
Certificate Download		
Certificate File:	<input type="text"/> <input type="button" value="Browse..."/>	<input type="button" value="Download"/>
Key Download		
Key File:	<input type="text"/> <input type="button" value="Browse..."/>	<input type="button" value="Download"/>

- 1) In the **Global Config** section, select **Enable** to enable HTTPS function and select the protocol the switch supports. Click **Apply**.

**HTTPS**

Select **Enable** to enable the HTTPS function.

HTTPS function is based on the SSL or TLS protocol. It provides a secure connection between the client and the switch.

SSL Version 3	Select <b>Enable</b> to make the switch support SSL Version 3 protocol.  SSL is a transport protocol. It can provide server authentication, encryption and message integrity to allow secure HTTP connection.
TLS Version 1	Select <b>Enable</b> to make the switch support TLS Version 1 protocol.  TLS is a transport protocol upgraded from SSL. It supports a different encryption algorithm from SSL, so TLS and SSL are not compatible. TLS can support a more secure connection.

- 2) In the **CipherSuite Config** section, select the algorithm to be enabled and click **Apply**.

RSA_WITH_RC4_128_MD5	Key exchange with RC4 128-bit encryption and MD5 for message digest.
RSA_WITH_RC4_128_SHA	Key exchange with RC4 128-bit encryption and SHA for message digest.
RSA_WITH_DES_CBC_SHA	Key exchange with DES-CBC for message encryption and SHA for message digest.
RSA_WITH_3DES_EDE_CBC_SHA	Key exchange with 3DES and DES-EDE3-CBC for message encryption and SHA for message digest.

- 3) In the **Session Config** section, specify the Session Timeout and click **Apply**.

Session Timeout	The system will log out automatically if users do nothing within the Session Timeout time.
-----------------	--

- 4) In the **Access User Number** section, select **Enable** and specify the parameters. Click **Apply**.

Number Control	Select <b>Enable</b> to control the number of the users logging in to the web management page at the same time.
Admin Number	Specify the maximum number of users whose access level is Admin.
Guest Number	Specify the maximum number of users whose access level is Operator, Power User or User.

- 5) In the **Certificate Download** and **Key Download** section, download the certificate and key.

Certificate File	Select the desired certificate to download to the switch. The certificate must be BASE64 encoded. The SSL certificate and key downloaded must match each other, otherwise the HTTPS connection will not work.
Key File	Select the desired Key to download to the switch. The key must be BASE64 encoded. The SSL certificate and key downloaded must match each other, otherwise the HTTPS connection will not work.

### 5.1.4 Configuring the SSH Feature

Choose the menu **System > Access Security > SSH Config** to load the following page.

Figure 5-3 Configuring the SSH Feature

**Global Config**

SSH:  Enable  Disable

Protocol V1:  Enable  Disable

Protocol V2:  Enable  Disable

Idle Timeout:  sec (1-120)

Max Connect:  (1-5)

---

**Encryption Algorithm**

AES128-CBC  AES192-CBC  AES256-CBC

Blowfish-CBC  Cast128-CBC  3DES-CBC

---

**Data Integrity Algorithm**

HMAC-SHA1  HMAC-MD5

---

**Key Download**

Choose the SSH public key file to download into switch.

Key Type:

Key File:

- 1) In the **Global Config** section, select **Enable** to enable SSH function and specify other parameters.

<b>SSH</b>	<p>Select <b>Enable</b> to enable the SSH function.</p> <p>SSH is a protocol working in application layer and transport layer. It can provide a secure, remote connection to a device. It is more secure than Telnet protocol as it provides strong encryption.</p>
<b>Protocol V1</b>	<p>Select <b>Enable</b> to enable SSH version 1.</p>
<b>Protocol V2</b>	<p>Select <b>Enable</b> to enable SSH version 2.</p>
<b>Idle Timeout</b>	<p>Specify the idle timeout time. The system will automatically release the connection when the time is up.</p>
<b>Max Connect</b>	<p>Specify the maximum number of the connections to the SSH server. New connection will not be established when the number of the connections reaches the maximum number you set.</p>

- 2) In the **Encryption Algorithm** section, select the encryption algorithm you want the switch to support and click **Apply**.
- 3) In **Data Integrity Algorithm** section, select the integrity algorithm you want the switch to support and click **Apply**.
- 4) In **Key Download** section, select key type from the drop-down list and select the desired key file to download.

Key Type	Select the key type. The algorithm of the corresponding type is used for both key generation and authentication.
Key File	Select the desired public key to download to the switch. The key length of the downloaded file ranges of 512 to 3072 bits.

#### Note:

It will take a long time to download the key file. Please wait without any operation.

## 5.1.5 Enabling the Telnet Function

Choose the menu **System > Access Security > Telnet Config** to load the following page.

Figure 5-4 Configuring the Telnet Function



Global Config

Telnet  Enable  Disable

In **Global Config** section, select **Enable** and click **Apply**.

Telnet	Select <b>Enable</b> to make the Telnet function effective. Telnet function is based on the Telnet protocol subjected to TCP/IP protocol. It allows users to log on to the switch remotely.
--------	---

## 5.2 Using the CLI

### 5.2.1 Configuring the Access Control

Follow these steps to configure the access control:

- |        |  |
|--------|--|
| Step 1 | <b>configure</b><br>Enter global configuration mode. |
|--------|--|

- 
- Step 2 Use the following command to control the users' access by limiting the IP address:
- ```
user access-control ip-based { ip-addr ip-mask } [ snmp ] [ telnet ] [ ssh ] [ http ] [ https ] [ ping ] [ all ]
```
- Only the users within the IP-range you set here are allowed to access the switch.
- ip-addr*: Specify the IP address of the user.
- ip-mask*: Specify the subnet mask of the user.
- [ snmp ] [ telnet ] [ ssh ] [ http ] [ https ] [ ping ] [ all ]: Select to control the types for users' accessing. By default, these types are all enabled.
- Use the following command to control the users' access by limiting the MAC address:
- ```
user access-control mac-based { mac-addr } [ snmp ] [ telnet ] [ ssh ] [ http ] [ https ] [ ping ] [ all ]
```
- Only the users with the MAC address you set here are allowed to access the switch.
- mac-addr*: Specify the MAC address of the user.
- [ snmp ] [ telnet ] [ ssh ] [ http ] [ https ] [ ping ] [ all ]: Select to control the types for users' accessing. By default, these types are all enabled.
- Use the following command to control the users' access by limiting the ports connected to the users:
- ```
user access-control port-based interface { fastEthernet port-list | gigabitEthernet port-list | ten-gigabitEthernet port-list } [ snmp ] [ telnet ] [ ssh ] [ http ] [ https ] [ ping ] [ all ]
```
- Only the users connecting to the ports you set here are allowed to access the switch.
- port-list*: Specify the list of Ethernet port, in the format of 1/0/1-4. You can appoint 5 ports at most.
- [ snmp ] [ telnet ] [ ssh ] [ http ] [ https ] [ ping ] [ all ]: Select to control the types for users' accessing. By default, these types are all enabled.
- 
- Step 3 **show user configuration**
- Verify the security configuration information of the user authentication information and the access interface.
- 
- Step 4 **end**
- Return to privileged EXEC mode.
- 
- Step 5 **copy running-config startup-config**
- Save the settings in the configuration file.
- 

The following example shows how to set the type of access control as IP-based. Set the IP address as 192.168.0.100, set the subnet mask as 255.255.255.0 and make the switch support snmp, telnet, http and https.

**Switch#configure**

```
Switch(config)#user access-control ip-based 192.168.0.100 255.255.255.0 snmp telnet http https
```

```
Switch(config)#show user configuration
```

User authentication mode: IP based

| Index | IP Address     | Access Interface       |
|-------|----------------|------------------------|
| 1     | 192.168.0.0/24 | SNMP Telnet HTTP HTTPS |

**Switch(config)#end**

**Switch#copy running-config startup-config**

## 5.2.2 Configuring the HTTP Function

Follow these steps to configure the HTTP function:

|        |                                                                                                                                                                                                                                                                                                                                                                                                                                                                                |
|--------|--------------------------------------------------------------------------------------------------------------------------------------------------------------------------------------------------------------------------------------------------------------------------------------------------------------------------------------------------------------------------------------------------------------------------------------------------------------------------------|
| Step 1 | <b>configure</b><br>Enter global configuration mode.                                                                                                                                                                                                                                                                                                                                                                                                                           |
| Step 2 | <b>ip http server</b><br>Enable the HTTP function. By default, it is enabled.                                                                                                                                                                                                                                                                                                                                                                                                  |
| Step 3 | <b>ip http session timeout <i>minutes</i></b><br>Specify the Session Timeout time. The system will log out automatically if users do nothing within the Session Timeout time.<br><br><i>minutes</i> : Specify the timeout time, which ranges from 5 to 30 minutes. The default value is 10.                                                                                                                                                                                    |
| Step 4 | <b>ip http max-users <i>admin-num guest-num</i></b><br>Specify the maximum number of users that are allowed to connect to the HTTP server. The total number of users should be no more than 16.<br><br><i>admin-num</i> : Enter the maximum number of users whose access level is Admin. The valid values are from 1 to 16.<br><br><i>guest-num</i> : Enter the maximum number of users whose access level is Operator, Power User or User. The valid values are from 0 to 15. |
| Step 5 | <b>show ip http configuration</b><br>Verify the configuration information of the HTTP server, including status, session timeout, access-control, max-user number and the idle-timeout, etc.                                                                                                                                                                                                                                                                                    |
| Step 6 | <b>end</b><br>Return to privileged EXEC mode.                                                                                                                                                                                                                                                                                                                                                                                                                                  |
| Step 7 | <b>copy running-config startup-config</b><br>Save the settings in the configuration file.                                                                                                                                                                                                                                                                                                                                                                                      |

The following example shows how to set the session timeout as 9, set the maximum admin number as 6, and set the maximum guest number as 5.

**Switch#configure**

**Switch(config)#ip http server**

```
Switch(config)#ip http session timeout 9
```

```
Switch(config)#ip http max-user 6 5
```

```
Switch(config)#show ip http configuration
```

```
HTTP Status:          Enabled
```

```
HTTP Session Timeout: 9
```

```
HTTP User Limitation: Enabled
```

```
HTTP Max Admin Users: 6
```

```
HTTP Max Guest Users: 5
```

```
Switch(config)#end
```

```
Switch#copy running-config startup-config
```

### 5.2.3 Configuring the HTTPS Function

Follow these steps to configure the HTTPS function:

---

Step 1     **configure**

Enter global configuration mode.

---

Step 2     **ip http secure-server**

Enable the HTTPS function. By default, it is enabled.

---

Step 3     **ip http secure-protocol { [ ssl3 ] [ tls1 ] }**

Configure to make the switch support the corresponding protocol. By default, the switch supports SSLv3 and TLSv1.

**ssl3**: Enable the SSL version 3 protocol. SSL is a transport protocol. It can provide server authentication, encryption and message integrity to allow secure HTTP connection.

**tls1**: Enable the TLS version 1 protocol. TLS is a transport protocol upgraded from SSL. It supports different encryption algorithm from SSL, so TLS and SSL are not compatible. TLS can support a more secure connection.

---

Step 4     **ip http secure-ciphersuite { [ 3des-ede-cbc-sha ] [ rc4-128-md5 ] [ rc4-128-sha ] [ des-cbc-sha ] }**

Enable the corresponding ciphersuite. By default, these types are all enabled.

**[ 3des-ede-cbc-sha ]**: Key exchange with 3DES and DES-EDE3-CBC for message encryption and SHA for message digest.

**[ rc4-128-md5 ]**: Key exchange with RC4 128-bit encryption and MD5 for message digest.

**[ rc4-128-sha ]**: Key exchange with RC4 128-bit encryption and SHA for message digest.

**[ des-cbc-sha ]**: Key exchange with DES-CBC for message encryption and SHA for message digest.

- 
- Step 5    **ip http secure-session timeout *minutes***  
Specify the Session Timeout time. The system will log out automatically if users do nothing within the Session Timeout time.
- minutes*: Specify the timeout time, which ranges from 5 to 30 minutes. The default value is 10.
- 
- Step 6    **ip http secure-max-users *admin-num guest-num***  
Specify the maximum number of users that are allowed to connect to the HTTPS server. The total number of users should be no more than 16.
- admin-num*: Enter the maximum number of users whose access level is Admin. The valid value are from 1 to 16.
- guest-num*: Enter the maximum number of users whose access level is Operator, Power User or User. The valid value are from 0 to 15.
- 
- Step 7    **ip http secure-server download certificate *ssl-cert ip-address ip-addr***  
Download the desired certificate to the switch from TFTP server.
- ssl-cert*: Specify the name of the SSL certificate, which ranges from 1 to 25 characters. The certificate must be BASE64 encoded. The SSL certificate and key downloaded must match each other.
- ip-addr*: Specify the IP address of the TFTP server. Both IPv4 and IPv6 addresses are supported.
- 
- Step 8    **ip http secure-server download key *ssl-key ip-address ip-addr***  
Download the desired key to the switch from TFTP server.
- ssl-key*: Specify the name of the key file saved in TFTP server. The key must be BASE64 encoded.
- ip-addr*: Specify the IP address of the TFTP server. Both IPv4 and IPv6 addresses are supported.
- 
- Step 9    **show ip http secure-server**  
Verify the global configuration of HTTPS.
- 
- Step 10    **end**  
Return to privileged EXEC mode.
- 
- Step 11    **copy running-config startup-config**  
Save the settings in the configuration file.
- 

The following example shows how to configure the HTTPS function. Enable SSL3 and TLS1 protocol. Enable the ciphersuite of 3des-ede-cbc-sha. Set the session timeout time as 15, the admin number as 1 and the guest number as 2. Download the certificate named ca.crt and the key named ca.key from the TFTP server with the IP address 192.168.0.100.

**Switch#configure**

**Switch(config)#ip http secure-server**

**Switch(config)#ip http secure-protocol ssl3 tls1**

**Switch(config)#ip http secure-ciphersuite 3des-ede-cbc-sha**



```
Switch(config)#ip http secure-session timeout 15
```

```
Switch(config)#ip http secure-max-users 1 2
```

```
Switch(config)#ip http secure-server download certificate ca.crt ip-address  
192.168.0.100
```

Start to download SSL certificate.....

Download SSL certificate OK.

```
Switch(config)#ip http secure-server download key ca.key ip-address 192.168.0.100
```

Start to download SSL key.....

Download SSL key OK.

```
Switch(config)#show ip http secure-server
```

HTTPS Status: Enabled

SSL Protocol Level(s): ssl3 tls1

SSL CipherSuite: 3des-ede-cbc-sha

HTTPS Session Timeout: 15

HTTPS User Limitation: Enabled

HTTPS Max Admin Users: 1

HTTPS Max Guest Users: 2

```
Switch(config)#end
```

```
Switch#copy running-config startup-config
```

## 5.2.4 Configuring the SSH Feature

Follow these steps to configure the SSH function:

---

Step 1 **configure**

Enter global configuration mode.

---

Step 2 **ip ssh server**

Enable the SSH function. By default, it is disabled.

---

Step 3 **ip ssh version { v1 | v2 }**

Configure to make the switch support the corresponding protocol. By default, the switch supports SSHv1 and SSHv3.

v1 | v2: Select to enable the corresponding protocol.

---

- 
- Step 4    **ip ssh timeout *value***
- Specify the idle timeout time. The system will automatically release the connection when the time is up.
- value*: Enter the value of the timeout time, which ranges from 1 to 120 seconds. The default value is 120 seconds.
- 
- Step 5    **ip ssh max-client *num***
- Specify the maximum number of the connections to the SSH server. New connection will not be established when the number of the connections reaches the maximum number you set.
- num*: Enter the number of the connections, which ranges from 1 to 5. The default value is 5.
- 
- Step 6    **ip ssh algorithm { AES128-CBC | AES192-CBC | AES256-CBC | Blowfish-CBC | Cast128-CBC | 3DES-CBC | HMAC-SHA1 | HMAC-MD5 }**
- Enable the corresponding algorithm. By default, these types are all enabled.
- AES128-CBC | AES192-CBC | AES256-CBC | Blowfish-CBC | Cast128-CBC | 3DES-CBC:  
Specify the encryption algorithm you want the switch supports.
- HMAC-SHA1 | HMAC-MD5: Specify the data integrity algorithm you want the switch supports.
- 
- Step 7    **ip ssh download { v1 | v2 } key-file ip-address ip-addr**
- Select the type of the key file and download the desired file to the switch from TFTP server.
- v1 | v2: Select the key type. The algorithm of the corresponding type is used for both key generation and authentication.
- key-file*: Specify the name of the key file saved in TFTP server. Ensure the key length of the downloaded file is in the range of 512 to 3072 bits.
- ip-addr*: Specify the IP address of the TFTP server. Both IPv4 and IPv6 addresses are supported.
- 
- Step 8    **show ip ssh**
- Verify the global configuration of SSH.
- 
- Step 9    **end**
- Return to privileged EXEC mode.
- 
- Step 10    **copy running-config startup-config**
- Save the settings in the configuration file.
- 

 **Note:**

It will take a long time to download the key file. Please wait without any operation.

---

The following example shows how to configure the SSH function. Set the version as SSH V1 and SSH V2. Enable the AES128-CBC and Cast128-CBC encryption algorithm. Enable the HMAC-MD5 data integrity algorithm. Choose the key type as SSH-2 RSA/DSA.

**Switch(config)#ip ssh server**

**Switch(config)#ip ssh version v1**

```
Switch(config)#ip ssh version v2
```

```
Switch(config)#ip ssh timeout 100
```

```
Switch(config)#ip ssh max-client 4
```

```
Switch(config)#ip ssh algorithm AES128-CBC
```

```
Switch(config)#ip ssh algorithm Cast128-CBC
```

```
Switch(config)#ip ssh algorithm HMAC-MD5
```

```
Switch(config)#ip ssh download v2 publickey ip-address 192.168.0.100
```

```
Start to download SSH key file.....
```

```
Download SSH key file OK.
```

```
Switch(config)#show ip ssh
```

```
Global Config:
```

```
SSH Server:    Enabled
```

```
Protocol V1:   Enabled
```

```
Protocol V2:   Enabled
```

```
Idle Timeout: 100
```

```
MAX Clients:   4
```

```
Encryption Algorithm:
```

```
AES128-CBC:    Enabled
```

```
AES192-CBC:    Disabled
```

```
AES256-CBC:    Disabled
```

```
Blowfish-CBC:  Disabled
```

```
Cast128-CBC:   Enabled
```

```
3DES-CBC:      Disabled
```

```
Data Integrity Algorithm:
```

```
HMAC-SHA1:     Disabled
```

```
HMAC-MD5:      Enabled
```

```
Key Type:      SSH-2 RSA/DSA
```

```
Key File:
```

```
---- BEGIN SSH2 PUBLIC KEY ----
```

```
Comment: "dsa-key-20160711"
```

```
Switch(config)#end
```

```
Switch#copy running-config startup-config
```

## 5.2.5 Enabling the Telnet Function

Follow these steps enable the Telnet function:

---

Step 1     **configure**

Enter global configuration mode.

---

Step 2     **telnet enable**

Enable the telnet function. By default, it is enabled.

---

Step 3     **end**

Return to privileged EXEC mode.

---

Step 4     **copy running-config startup-config**

Save the settings in the configuration file.

---

# 6 SDM Template Configuration

SDM Template function is used to configure system resources in the switch to optimize support for specific features. The switch provides three templates, and the hardware resources allocation is different. Users can choose one according to how the switch is used in the network.

## 6.1 Using the GUI

Choose the menu **System > SDM Template** to load the following page.

Figure 6-1 Configuring the SDM Template Function

**Select Options**

Current Template ID:

Next Template ID:

Select Next Template:  ▼

**Template Table**

| SDM Template | IP ACL Rules | MAC ACL Rules | COMBINED ACL Rules | IPV6 ACL Rules | ARP Detection Entries | IPV6 Source Guard Entries |
|--------------|--------------|---------------|--------------------|----------------|-----------------------|---------------------------|
| default      | 200          | 100           | 0                  | 0              | 200                   | 0                         |
| enterpriseV4 | 360          | 230           | 0                  | 0              | 7                     | 0                         |
| enterpriseV6 | 100          | 100           | 0                  | 50             | 7                     | 0                         |

In **Select Options** section, select one template and click **Apply**. The setting will be effective after the reboot.

|                             |                                                                                                                                                                                                                                                                                                                                                                                                                                                              |
|-----------------------------|--------------------------------------------------------------------------------------------------------------------------------------------------------------------------------------------------------------------------------------------------------------------------------------------------------------------------------------------------------------------------------------------------------------------------------------------------------------|
| <b>Current Template ID</b>  | Displays the template currently in effect.                                                                                                                                                                                                                                                                                                                                                                                                                   |
| <b>Next Template ID</b>     | Displays the template that will be effective after the reboot.                                                                                                                                                                                                                                                                                                                                                                                               |
| <b>Select Next Template</b> | <p>Select the template that will be effective after the next reboot.</p> <p><b>default:</b> Select the template of default. It gives balance to the IP ACL rules, MAC ACL rules and ARP detection entries.</p> <p><b>enterpriseV4:</b> Select the template of enterpriseV4. It maximizes system resources for IP ACL rules and MAC ACL rules.</p> <p><b>enterpriseV6:</b> Select the template of enterpriseV6. It allocates resources to IPv6 ACL rules.</p> |

The Template Table displays the resources allocation of each template.

|                           |                                                                                  |
|---------------------------|----------------------------------------------------------------------------------|
| SDM Template              | Displays the name of the templates.                                              |
| IP ACL Rules              | Displays the number of IP ACL Rules including Lay3 ACL Rules and Lay4 ACL Rules. |
| MAC ACL Rules             | Displays the number of Lay2 ACL Rules.                                           |
| COMBINED ACL Rules        | Displays the number of combined ACL rules.                                       |
| IPv6 ACL Rules            | Displays the number of IPv6 ACL rules.                                           |
| ARP Detection Entries     | Displays the number of TCAM entries for ARP defend.                              |
| IPv6 Source Guard Entries | Displays the number of IPv6 source guard entries.                                |

## 6.2 Using the CLI

Follow these steps to configure the SDM template function:

|        |                                                                                                                                                                                                                                                                                                                                                                                                                                                                                                                      |
|--------|----------------------------------------------------------------------------------------------------------------------------------------------------------------------------------------------------------------------------------------------------------------------------------------------------------------------------------------------------------------------------------------------------------------------------------------------------------------------------------------------------------------------|
| Step 1 | <b>configure</b><br>Enter global configuration mode.                                                                                                                                                                                                                                                                                                                                                                                                                                                                 |
| Step 2 | <b>show sdm prefer { used   default   enterpriseV4   enterpriseV6 }</b><br>View the template table to select the desired template.<br><br><b>used:</b> Displays the resource allocation of the current template.<br><br><b>default:</b> Displays the resource allocation of the default template.<br><br><b>enterpriseV4:</b> Displays the resource allocation of the enterpriseV4 template.<br><br><b>enterpriseV6:</b> Displays the resource allocation of the enterpriseV6 template.                              |
| Step 3 | <b>sdm prefer { default   enterpriseV4   enterpriseV6 }</b><br>Select the template that will be effective after the next reboot.<br><br><b>default:</b> Select the template of default. It gives banlance to the IP ACLrules, MAC ACL rules and ARP detection entries.<br><br><b>enterpriseV4:</b> Select the template of enterpriseV4. It maximizes system resources for IP ACL rules and MAC ACL rules.<br><br><b>enterpriseV6:</b> Select the template of enterpriseV4. It allocates resources to IPv6 ACL rules. |
| Step 4 | <b>end</b><br>Return to privileged EXEC mode.                                                                                                                                                                                                                                                                                                                                                                                                                                                                        |
| Step 5 | <b>copy running-config startup-config</b><br>Save the settings in the configuration file.                                                                                                                                                                                                                                                                                                                                                                                                                            |

The following example shows how to set the SDM template as enterpriseV4.

**Switch#config**

**Switch(config)#show sdm prefer** enterpriseV4

"enterpriseV4" template:

number of IP ACL Rules : 360

number of MAC ACL Rules : 230

number of Combined ACL Rules : 0

number of IPV6 ACL Rules : 0

number of IPV6 Source Guard Entries : 0

number of ARP Detection Entries : 7

**Switch(config)#sdm prefer** enterpriseV4

Switch to "enterpriseV4" template.

Changes to the running SDM preferences have been stored, but cannot take effect until reboot the switch.

**Switch(config)#end**

**Switch#copy running-config startup-config**

# 7 Appendix: Default Parameters

Default settings of System Info are listed in the following tables.

Table 7-1 Default Settings of Device Description Configuration

| Parameter       | Default Setting               |
|-----------------|-------------------------------|
| Device Name     | The model name of the switch. |
| Device Location | SHENZHEN                      |
| System Contact  | www.tp-link.com               |

Table 7-2 Default Settings of System Time Configuration

| Parameter   | Default Setting               |
|-------------|-------------------------------|
| Time Source | Manual                        |
| System Time | 2006-01-01<br>08:01:56 Sunday |

Table 7-3 Default Settings of Daylight Saving Time Configuration

| Parameter  | Default Setting |
|------------|-----------------|
| DST status | Disabled        |

Default settings of User Management are listed in the following table.

Table 7-4 Default Settings of User Configuration

| Parameter    | Default Setting |
|--------------|-----------------|
| User Name    | admin           |
| Password     | admin           |
| Access Level | Admin           |

Default settings of System Tools are listed in the following table.

Table 7-5 Default Settings of Boot Configuration

| Parameter             | Default Setting |
|-----------------------|-----------------|
| Current Startup Image | image1.bin      |
| Next Startup Image    | image1.bin      |
| Backup Image          | image2.bin      |



Default settings of Access Security are listed in the following tables.

Table 7-6 Default Settings of Access Control Configuration

| Parameter    | Default Setting |
|--------------|-----------------|
| Control Mode | Disabled        |

Table 7-7 Default Settings of HTTP Configuration

| Parameter       | Default Setting |
|-----------------|-----------------|
| HTTP            | Enabled         |
| Session Timeout | 10 minutes      |
| Number Control  | Disabled        |

Table 7-8 Default Settings of HTTPS Configuration

| Parameter                 | Default Setting |
|---------------------------|-----------------|
| HTTPS                     | Enabled         |
| SSL Version 3             | Enabled         |
| TLS Version 1             | Enabled         |
| RSA_WITH_RC4_128_MD5      | Enabled         |
| RSA_WITH_RC4_128_SHA      | Enabled         |
| RSA_WITH_DES_CBC_SHA      | Enabled         |
| RSA_WITH_3DES_EDE_CBC_SHA | Enabled         |
| Session Timeout           | 10 minutes      |
| Number Control            | Disabled        |

Table 7-9 Default Settings of SSH Configuration

| Parameter    | Default Setting |
|--------------|-----------------|
| SSH          | Disabled        |
| Protocol V1  | Enabled         |
| Protocol V2  | Enabled         |
| Idle Timeout | 120 seconds     |
| Max Connect  | 5               |
| AES128-CBC   | Enabled         |
| AES192-CBC   | Enabled         |
| AES256-CBC   | Enabled         |
| Blowfish-CBC | Enabled         |
| Cast128-CBC  | Enabled         |
| 3DES-CBC     | Enabled         |

| Parameter | Default Setting |
|-----------|-----------------|
| HMAC-SHA1 | Enabled         |
| HMAC-MD5  | Enabled         |
| Key Type: | SSH-2 RSA/DSA   |

Table 7-10 Default Settings of Telnet Configuration

| Parameter    | Default Setting |
|--------------|-----------------|
| Control Mode | Enabled         |

Default settings of SDM Template are listed in the following table.

Table 7-11 Default Settings of SDM Template Configuration

| Parameter           | Default Setting |
|---------------------|-----------------|
| Current Template ID | Default         |
| Next Template ID    | Default         |

# Part 3

## Managing Physical Interfaces

### CHAPTERS

1. Physical Interface
2. Basic Parameters Configurations
3. Port Mirror Configuration
4. Port Security Configuration
5. Port Isolation Configurations
6. Loopback Detection Configuration
7. Configuration Examples

# 1 Physical Interface

## 1.1 Overview

Interfaces of a device are used to exchange data and interact with other network devices. Interfaces are classified into physical interfaces and logical interfaces.

- Physical interfaces are the ports on the front panel or rear panel of the switch.
- Logical interfaces are manually configured and do not physically exist, such as loopback interfaces and routing interfaces.

This chapter introduces the configurations for physical interfaces.

## 1.2 Supported Features

The switch supports the following features about physical interfaces:

### Basic Parameters

You can configure port status, speed mode, duplex mode, flow control and other basic parameters for ports.

### Port Mirror

This function allows the switch to forward packet copies of the monitored ports to a specific monitoring port. Then you can analyze the copied packets to monitor network traffic and troubleshoot network problems.

### Port Security

You can use this feature to limit the number of MAC addresses that can be learned on each port, thus preventing the MAC address table from being exhausted by the attack packets.

### Port Isolation

You can use this feature to restrict a specific port to send packets to only the ports in the forward-port list that you configure.

### Loopback Detection

This function allows the switch to detect loops in the network. When a loop is detected on a port, the switch will display an alert on the management interface and further block the corresponding port according to your configurations.

# 2 Basic Parameters Configurations

## 2.1 Using the GUI

Choose the menu **Switching > Port > Port Config** to load the following page.

Figure 2-1 Configuring Basic Parameters

| Port Config              |        |        |                      |                      |                      |                      |                      |                      |     |
|--------------------------|--------|--------|----------------------|----------------------|----------------------|----------------------|----------------------|----------------------|-----|
| UNIT: 1 LAGS             |        |        |                      |                      |                      |                      |                      |                      |     |
| Select                   | Port   | Type   | Description          | Status               | Speed                | Duplex               | Flow Control         | Jumbo                | LAG |
| <input type="checkbox"/> |        |        | <input type="text"/> | <input type="text"/> | <input type="text"/> | <input type="text"/> | <input type="text"/> | <input type="text"/> |     |
| <input type="checkbox"/> | 1/0/1  | Copper |                      | Enable               | Auto                 | Auto                 | Disable              | Disable              | --- |
| <input type="checkbox"/> | 1/0/2  | Copper |                      | Enable               | Auto                 | Auto                 | Disable              | Disable              | --- |
| <input type="checkbox"/> | 1/0/3  | Copper |                      | Enable               | Auto                 | Auto                 | Disable              | Disable              | --- |
| <input type="checkbox"/> | 1/0/4  | Copper |                      | Enable               | Auto                 | Auto                 | Disable              | Disable              | --- |
| <input type="checkbox"/> | 1/0/5  | Copper |                      | Enable               | Auto                 | Auto                 | Disable              | Disable              | --- |
| <input type="checkbox"/> | 1/0/6  | Copper |                      | Enable               | Auto                 | Auto                 | Disable              | Disable              | --- |
| <input type="checkbox"/> | 1/0/7  | Copper |                      | Enable               | Auto                 | Auto                 | Disable              | Disable              | --- |
| <input type="checkbox"/> | 1/0/8  | Copper |                      | Enable               | Auto                 | Auto                 | Disable              | Disable              | --- |
| <input type="checkbox"/> | 1/0/9  | Copper |                      | Enable               | Auto                 | Auto                 | Disable              | Disable              | --- |
| <input type="checkbox"/> | 1/0/10 | Copper |                      | Enable               | Auto                 | Auto                 | Disable              | Disable              | --- |
| <input type="checkbox"/> | 1/0/11 | Copper |                      | Enable               | Auto                 | Auto                 | Disable              | Disable              | --- |
| <input type="checkbox"/> | 1/0/12 | Copper |                      | Enable               | Auto                 | Auto                 | Disable              | Disable              | --- |
| <input type="checkbox"/> | 1/0/13 | Sfp    |                      | Enable               | 10G                  | Full                 | Disable              | Disable              | --- |
| <input type="checkbox"/> | 1/0/14 | Sfp    |                      | Enable               | 10G                  | Full                 | Disable              | Disable              | --- |
| <input type="checkbox"/> | 1/0/15 | Sfp    |                      | Enable               | 10G                  | Full                 | Disable              | Disable              | --- |

Follow these steps to set basic parameters for ports:

Select and configure your desired ports or LAGs. Then click **Apply**.

|              |                                                                                                                                                                                                                                                               |
|--------------|---------------------------------------------------------------------------------------------------------------------------------------------------------------------------------------------------------------------------------------------------------------|
| UNIT: 1/LAGS | Click <b>1</b> to configure physical ports. Click <b>LAGS</b> to configure LAGs.                                                                                                                                                                              |
| Type         | Displays the port type. <b>Copper</b> indicates an Ethernet port, and <b>SFP</b> or <b>SFP+</b> indicates a fiber port.                                                                                                                                       |
| Description  | Give a port description for identification.                                                                                                                                                                                                                   |
| Status       | With this option enabled, the port forwards packets normally. Otherwise, the port discards all the received packets. By default, it is enabled.                                                                                                               |
| Speed        | Select the appropriate speed mode for the port. When <b>Auto</b> is selected, the port autonegotiates speed mode with the connected device. The default setting is <b>Auto</b> . This value is recommended if both ends of the line support auto-negotiation. |
| Duplex       | Select the appropriate duplex mode for the port. There are three options: <b>Half</b> , <b>Full</b> and <b>Auto</b> . When <b>Auto</b> is selected, the port autonegotiates duplex mode with the connected device. The default setting is <b>Auto</b> .       |

---

|              |                                                                                                                                                                                                                                                                                                                 |
|--------------|-----------------------------------------------------------------------------------------------------------------------------------------------------------------------------------------------------------------------------------------------------------------------------------------------------------------|
| Flow Control | With this option enabled, the switch synchronizes the data transmission speed with the peer device, thus avoiding the packet loss caused by congestion. By default, it is disabled.                                                                                                                             |
| Jumbo:       | With this option enabled, the port can send jumbo frames. The default MTU (Maximum Transmission Unit) size for frames received and sent on all ports is 1518 bytes. For the port with Jumbo enabled, the MTU size is up to 9216 bytes, thus allowing the port to send jumbo frames. By default, it is disabled. |

---

---

 **Note:**

We recommend that you set the ports on both ends of a link as the same speed and duplex mode.

---

## 2.2 Using the CLI

Follow these steps to set basic parameters for the ports.

---

|        |                                                                                                                                                                                                                                                                                                                                                                         |
|--------|-------------------------------------------------------------------------------------------------------------------------------------------------------------------------------------------------------------------------------------------------------------------------------------------------------------------------------------------------------------------------|
| Step 1 | <b>configure</b><br>Enter global configuration mode.                                                                                                                                                                                                                                                                                                                    |
| Step 2 | <b>interface { fastEthernet <i>port</i>   range fastEthernet <i>port-list</i>   gigabitEthernet <i>port</i>   range gigabitEthernet <i>port-list</i>   ten-gigabitEthernet <i>port</i>   range ten-gigabitEthernet <i>port-list</i>   port-channel <i>port-channel-id</i>   range port-channel <i>port-channel-id-list</i> }</b><br>Enter interface configuration mode. |

---

---

|        |                                                                                                                                                                                                                                                                                                                                                                                                                                                                                                                                                                                                                                                                                                                                                                                                                                                                                                                                                                                                                                                                                                                                                                                                                                                                                                                                                                                                                                                                                                                                                                                                                                                                                                                                                                                                               |
|--------|---------------------------------------------------------------------------------------------------------------------------------------------------------------------------------------------------------------------------------------------------------------------------------------------------------------------------------------------------------------------------------------------------------------------------------------------------------------------------------------------------------------------------------------------------------------------------------------------------------------------------------------------------------------------------------------------------------------------------------------------------------------------------------------------------------------------------------------------------------------------------------------------------------------------------------------------------------------------------------------------------------------------------------------------------------------------------------------------------------------------------------------------------------------------------------------------------------------------------------------------------------------------------------------------------------------------------------------------------------------------------------------------------------------------------------------------------------------------------------------------------------------------------------------------------------------------------------------------------------------------------------------------------------------------------------------------------------------------------------------------------------------------------------------------------------------|
| Step 3 | <p>Configure basic parameters for the port:</p> <p><b>description <i>string</i></b></p> <p>Give a port description for identification.</p> <p><i>string</i>: Content of a port description, ranging from 1 to 16 characters.</p> <p><b>shutdown</b><br/><b>no shutdown</b></p> <p>Use <b>shutdown</b> to disable the port, and use <b>no shutdown</b> to enable the port. When the status is enabled, the port can forward packets normally, otherwise it will discard the received packets. By default, all ports are enabled.</p> <p><b>speed { 10   100   1000   10000   auto }</b></p> <p>Set the appropriate speed mode for the port.</p> <p><b>10   100   1000   10000   auto</b>: Speed mode of the port. The options are subject to your actual product. The device connected to the port should be in the same speed and duplex mode with the port. When auto is selected, the speed mode will be determined by auto negotiation.</p> <p><b>duplex { auto   full   half }</b></p> <p>Set the appropriate duplex mode for the port.</p> <p><b>auto   full   half</b>: Duplex mode of the port. The device connected to the port should be in the same speed and duplex mode with the port. When auto is selected, the duplex mode will be determined by auto negotiation.</p> <p><b>flow-control</b></p> <p>Enable the switch to synchronize the data transmission speed with the peer device, avoiding the packet loss caused by congestion. By default, this feature is disabled.</p> <p><b>jumbo</b></p> <p>Change the MTU (Maximum Transmission Unit) size on the port to support jumbo frames. The default MTU size for frames received and sent on all ports is 1518 bytes. For the port with Jumbo enabled, the MTU size is up to 9216 bytes, thus allowing the port to send jumbo frames.</p> |
| Step 4 | <p><b>show interface configuration [ fastEthernet <i>port</i>   gigabitEthernet <i>port</i>   ten-gigabitEthernet <i>port</i>   port-channel <i>port-channel-id</i> ]</b></p> <p>Verify the configuration of the port or LAG.</p>                                                                                                                                                                                                                                                                                                                                                                                                                                                                                                                                                                                                                                                                                                                                                                                                                                                                                                                                                                                                                                                                                                                                                                                                                                                                                                                                                                                                                                                                                                                                                                             |
| Step 5 | <p><b>end</b></p> <p>Return to privileged EXEC mode.</p>                                                                                                                                                                                                                                                                                                                                                                                                                                                                                                                                                                                                                                                                                                                                                                                                                                                                                                                                                                                                                                                                                                                                                                                                                                                                                                                                                                                                                                                                                                                                                                                                                                                                                                                                                      |
| Step 6 | <p><b>copy running-config startup-config</b></p> <p>Save the settings in the configuration file.</p>                                                                                                                                                                                                                                                                                                                                                                                                                                                                                                                                                                                                                                                                                                                                                                                                                                                                                                                                                                                                                                                                                                                                                                                                                                                                                                                                                                                                                                                                                                                                                                                                                                                                                                          |

---

The following example shows how to implement the basic configurations of port1/0/1, including setting a description for the port, making the port autonegotiate speed and duplex with the neighboring port, and enabling the flow-control and jumbo feature:

### Switch#configure

```
Switch(config)#interface ten-gigabitEthernet 1/0/1
```

```
Switch(config-if)#no shutdown
```

```
Switch(config-if)#description router connection
```

```
Switch(config-if)#speed auto
```

```
Switch(config-if)#duplex auto
```

```
Switch(config-if)#flow-control
```

```
Switch(config-if)#jumbo
```

```
Switch(config-if)#show interface configuration gigabitEthernet 1/0/1
```

| Port    | State  | Speed | Duplex | FlowCtrl | Jumbo  | Description       |
|---------|--------|-------|--------|----------|--------|-------------------|
| ----    | -----  | ----- | -----  | -----    | -----  | -----             |
| Te1/0/1 | Enable | Auto  | Auto   | Enable   | Enable | router connection |

```
Switch(config-if)#end
```

```
Switch#copy running-config startup-config
```



# 3 Port Mirror Configuration

## 3.1 Using the GUI

Choose the menu **Switching > Port > Port Mirror** to load the following page.

Figure 3-1 Mirror Session List

| Mirror Session List |             |              |        |                                              |
|---------------------|-------------|--------------|--------|----------------------------------------------|
| Session             | Destination | Mode         | Source | Operation                                    |
| 1                   | 1/0/1       | Ingress Only |        | <a href="#">Edit</a>   <a href="#">Clear</a> |
|                     |             | Egress Only  |        |                                              |
|                     |             | Both         |        |                                              |

[Help](#)

The above page displays a mirror session, and no more session can be created. Click **Edit** to configure this mirror session on the following page.

Figure 3-2 Configuring Port Mirror

**Destination Port**

Destination Port:  (Format: 1/0/1)

---

UNIT:

|   |   |   |   |    |    |
|---|---|---|---|----|----|
| 2 | 4 | 6 | 8 | 10 | 12 |
| 1 | 3 | 5 | 7 | 9  | 11 |

|    |    |
|----|----|
| 14 | 16 |
| 13 | 15 |

Unselected Port(s)
 Selected Port(s)
 Not Available for Selection

---

**Source Port**

UNIT:  LAGS

| Select                              | Port   | Ingress | Egress  | LAG |
|-------------------------------------|--------|---------|---------|-----|
| <input type="checkbox"/>            |        | ▼       | ▼       |     |
| <input checked="" type="checkbox"/> | 1/0/5  | Disable | Disable | --- |
| <input checked="" type="checkbox"/> | 1/0/6  | Disable | Disable | --- |
| <input checked="" type="checkbox"/> | 1/0/7  | Disable | Disable | --- |
| <input type="checkbox"/>            | 1/0/8  | Disable | Disable | --- |
| <input type="checkbox"/>            | 1/0/9  | Disable | Disable | --- |
| <input type="checkbox"/>            | 1/0/10 | Disable | Disable | --- |
| <input type="checkbox"/>            | 1/0/11 | Disable | Disable | --- |
| <input type="checkbox"/>            | 1/0/12 | Disable | Disable | --- |
| <input type="checkbox"/>            | 1/0/13 | Disable | Disable | --- |
| <input type="checkbox"/>            | 1/0/14 | Disable | Disable | --- |
| <input type="checkbox"/>            | 1/0/15 | Disable | Disable | --- |
| <input type="checkbox"/>            | 1/0/16 | Disable | Disable | --- |

Follow these steps to configure Port Mirror:

- 1) In the **Destination Port** section, specify a monitoring port for the mirror session, and click **Apply**.
- 2) In the **Source Port** section, select one or multiple monitored ports for configuration. Then set the parameters and click **Apply**.

**UNIT:1/LAGS** Click **1** to select physical ports. Click **LAGS** to select LAGs.

**Ingress** With this option enabled, the packets received by the monitored port will be copied to the monitoring port. By default, it is disabled.

**Egress** With this option enabled, the packets sent by the monitored port will be copied to the monitoring port. By default, it is disabled.

---

 Note:

- The member port of an LAG cannot be set as a monitoring port or monitored port.
  - A port cannot be set as the monitoring port and monitored port at the same time.
- 

## 3.2 Using the CLI

Follow these steps to configure Port Mirror.

|        |                                                                                                                                                                                                                                                                                                                                                                                                                                                                                                                                                                                                                                                                                                                                                                                                                          |
|--------|--------------------------------------------------------------------------------------------------------------------------------------------------------------------------------------------------------------------------------------------------------------------------------------------------------------------------------------------------------------------------------------------------------------------------------------------------------------------------------------------------------------------------------------------------------------------------------------------------------------------------------------------------------------------------------------------------------------------------------------------------------------------------------------------------------------------------|
| Step 1 | <b>configure</b><br>Enter global configuration mode.                                                                                                                                                                                                                                                                                                                                                                                                                                                                                                                                                                                                                                                                                                                                                                     |
| Step 2 | <b>monitor session <i>session_num</i> destination interface { fastEthernet <i>port</i>   gigabitEthernet <i>port</i>   ten-gigabitEthernet <i>port</i> }</b><br>Enable the port mirror function and set the monitoring port.<br><i>session_num</i> : The monitor session number. It can only be specified as 1.<br><i>port</i> : The monitoring port number. You can specify only one monitoring port for the mirror session.                                                                                                                                                                                                                                                                                                                                                                                            |
| Step 3 | <b>monitor session <i>session_num</i> source interface { fastEthernet <i>port-list</i>   gigabitEthernet <i>port-list</i>   ten-gigabitEthernet <i>port</i>   port-channel <i>port-channel-id</i> } mode</b><br>Set the monitored ports.<br><i>session_num</i> : The monitor session number. It can only be specified as 1.<br><i>port-list</i> : List of monitored port. It is multi-optional.<br><i>mode</i> : The monitor mode. There are three options: <b>rx</b> , <b>tx</b> and <b>both</b> :<br><b>rx</b> : The incoming packets of the monitored port will be copied to the monitoring port.<br><b>tx</b> : The outgoing packets of the monitored port will be copied to the monitoring port.<br><b>both</b> : Both of the incoming and outgoing packets on monitored port can be copied to the monitoring port. |
| Step 4 | <b>show monitor session</b><br>Verify the Port Mirror configuration.                                                                                                                                                                                                                                                                                                                                                                                                                                                                                                                                                                                                                                                                                                                                                     |
| Step 5 | <b>end</b><br>Return to privileged EXEC mode.                                                                                                                                                                                                                                                                                                                                                                                                                                                                                                                                                                                                                                                                                                                                                                            |
| Step 6 | <b>copy running-config startup-config</b><br>Save the settings in the configuration file.                                                                                                                                                                                                                                                                                                                                                                                                                                                                                                                                                                                                                                                                                                                                |

The following example shows how to copy the received and transmitted packets on port 1/0/1,2,3 to port 1/0/10.

**Switch#configure**

**Switch(config)#monitor session 1 destination interface ten-gigabitEthernet 1/0/10**

**Switch(config)#monitor session 1 source interface ten-gigabitEthernet 1/0/1-3 both**

**Switch(config)#show monitor session**

Monitor Session: 1

Destination Port: Te1/0/10

Source Ports(Ingress): Te1/0/1-3

Source Ports(Egress): Te1/0/1-3

**Switch(config-if)#end**

**Switch#copy running-config startup-config**

# 4 Port Security Configuration

## 4.1 Using the GUI

Choose the menu **Switching > Port > Port Security** to load the following page.

Figure 4-1 Port Security

| Port Security                        |        |                      |             |                                      |                                      |
|--------------------------------------|--------|----------------------|-------------|--------------------------------------|--------------------------------------|
| UNIT: <input type="text" value="1"/> |        |                      |             |                                      |                                      |
| Select                               | Port   | Max Learned MAC      | Learned Num | Learn Mode                           | Status                               |
| <input type="checkbox"/>             |        | <input type="text"/> |             | <input type="text" value="Dynamic"/> | <input type="text" value="Disable"/> |
| <input type="checkbox"/>             | 1/0/1  | 64                   | 0           | Dynamic                              | Disable                              |
| <input type="checkbox"/>             | 1/0/2  | 64                   | 0           | Dynamic                              | Disable                              |
| <input type="checkbox"/>             | 1/0/3  | 64                   | 0           | Dynamic                              | Disable                              |
| <input type="checkbox"/>             | 1/0/4  | 64                   | 0           | Dynamic                              | Disable                              |
| <input type="checkbox"/>             | 1/0/5  | 64                   | 0           | Dynamic                              | Disable                              |
| <input type="checkbox"/>             | 1/0/6  | 64                   | 0           | Dynamic                              | Disable                              |
| <input type="checkbox"/>             | 1/0/7  | 64                   | 0           | Dynamic                              | Disable                              |
| <input type="checkbox"/>             | 1/0/8  | 64                   | 0           | Dynamic                              | Disable                              |
| <input type="checkbox"/>             | 1/0/9  | 64                   | 0           | Dynamic                              | Disable                              |
| <input type="checkbox"/>             | 1/0/10 | 64                   | 0           | Dynamic                              | Disable                              |
| <input type="checkbox"/>             | 1/0/11 | 64                   | 0           | Dynamic                              | Disable                              |
| <input type="checkbox"/>             | 1/0/12 | 64                   | 0           | Dynamic                              | Disable                              |
| <input type="checkbox"/>             | 1/0/13 | 64                   | 0           | Dynamic                              | Disable                              |
| <input type="checkbox"/>             | 1/0/14 | 64                   | 0           | Dynamic                              | Disable                              |
| <input type="checkbox"/>             | 1/0/15 | 64                   | 0           | Dynamic                              | Disable                              |

Follow these steps to configure Port Security:

- 1) Select one or multiple ports for security configuration.
- 2) Specify the maximum number of the MAC addresses that can be learned on the port, and then select the learn mode of the MAC addresses.

**Max Learned MAC** Specify the maximum number of MAC addresses that can be learned on the port. When the learned MAC address number reaches the limit, the port will stop learning. The default value is 64.

**Learned Num** Displays the number of MAC addresses that have been learned on the port.

|                   |                                                                                                                                                                                                                                                                                                                                                                                                                                                                                                                                                                                                                                       |
|-------------------|---------------------------------------------------------------------------------------------------------------------------------------------------------------------------------------------------------------------------------------------------------------------------------------------------------------------------------------------------------------------------------------------------------------------------------------------------------------------------------------------------------------------------------------------------------------------------------------------------------------------------------------|
| <b>Learn Mode</b> | <p>Select the learn mode of the MAC addresses on the port. Three modes are provided:</p> <p><b>Dynamic:</b> The switch will delete the MAC addresses that are not used or updated within the aging time. It is the default setting.</p> <p><b>Static:</b> The learned MAC addresses are out of the influence of the aging time and can only be deleted manually. The learned entries will be cleared after the switch is rebooted.</p> <p><b>Permanent:</b> The learned MAC addresses are out of the influence of the aging time and can only be deleted manually. The learned entries will be saved even the switch is rebooted.</p> |
|-------------------|---------------------------------------------------------------------------------------------------------------------------------------------------------------------------------------------------------------------------------------------------------------------------------------------------------------------------------------------------------------------------------------------------------------------------------------------------------------------------------------------------------------------------------------------------------------------------------------------------------------------------------------|

### 3) Select the status of the port security feature.

|               |                                                                                                                                                                                                                                                                                                                                                                                                                                                                                                                                                                                                                        |
|---------------|------------------------------------------------------------------------------------------------------------------------------------------------------------------------------------------------------------------------------------------------------------------------------------------------------------------------------------------------------------------------------------------------------------------------------------------------------------------------------------------------------------------------------------------------------------------------------------------------------------------------|
| <b>Status</b> | <p>Select the status of Port Security. Three kinds of status can be selected:</p> <p><b>Drop:</b> When the number of learned MAC addresses reaches the limit, the port will stop learning and discard the packets with the MAC addresses that have not been learned.</p> <p><b>Forward:</b> When the number of learned MAC addresses reaches the limit, the port will stop learning but send the packets with the MAC addresses that have not been learned.</p> <p><b>Disable:</b> The number limit on the port is not effective, and the switch follows the original forwarding rules. It is the default setting.</p> |
|---------------|------------------------------------------------------------------------------------------------------------------------------------------------------------------------------------------------------------------------------------------------------------------------------------------------------------------------------------------------------------------------------------------------------------------------------------------------------------------------------------------------------------------------------------------------------------------------------------------------------------------------|

### 4) Click **Apply**.

#### Note:

- Port Security cannot be enabled on the member port of a LAG, and the port with Port Security enabled cannot be added to a LAG.
- On one port, Port Security and 802.1X cannot be enabled at the same time.

## 4.2 Using the CLI

Follow these steps to configure Port Security:

|        |                                                                                                                                                                                                                                                                                            |
|--------|--------------------------------------------------------------------------------------------------------------------------------------------------------------------------------------------------------------------------------------------------------------------------------------------|
| Step 1 | <p><b>configure</b></p> <p>Enter global configuration mode.</p>                                                                                                                                                                                                                            |
| Step 2 | <p><b>interface {fastEthernet <i>port</i>   range fastEthernet <i>port-list</i>   gigabitEthernet <i>port</i>   range gigabitEthernet <i>port-list</i>   ten-gigabitEthernet <i>port</i>   range ten-gigabitEthernet <i>port-list</i> }</b></p> <p>Enter interface configuration mode.</p> |

|        |                                                                                                                                                                                                                                                                                                                                                                                                                                                                                                                                                                                                                                                                                                                                                                                                                                                                                                                                                                                                                                                                                                                                                                                                                                                                                                                                                                                                                                                                |
|--------|----------------------------------------------------------------------------------------------------------------------------------------------------------------------------------------------------------------------------------------------------------------------------------------------------------------------------------------------------------------------------------------------------------------------------------------------------------------------------------------------------------------------------------------------------------------------------------------------------------------------------------------------------------------------------------------------------------------------------------------------------------------------------------------------------------------------------------------------------------------------------------------------------------------------------------------------------------------------------------------------------------------------------------------------------------------------------------------------------------------------------------------------------------------------------------------------------------------------------------------------------------------------------------------------------------------------------------------------------------------------------------------------------------------------------------------------------------------|
| Step 3 | <b>mac address-table max-mac-count</b> { [max-number <i>num</i> ] [mode { dynamic   static   permanent } ] [ status { forward   drop   disable } ] }                                                                                                                                                                                                                                                                                                                                                                                                                                                                                                                                                                                                                                                                                                                                                                                                                                                                                                                                                                                                                                                                                                                                                                                                                                                                                                           |
|        | <p>Enable the port security feature of the port and configure the related parameters.</p> <p><i>num</i>: The maximum number of MAC addresses that can be learned on the port. The valid values are from 0 to 64. The default value is 64.</p> <p><b>mode</b>: Learn mode of the MAC address. There are three modes:</p> <p><i>dynamic</i>: The switch will delete the MAC addresses that are not used or updated within the aging time.</p> <p><i>static</i>: The learned MAC addresses are out of the influence of the aging time and can only be deleted manually. The learned entries will be cleared after the switch is rebooted.</p> <p><i>permanent</i>: The learned MAC address is out of the influence of the aging time and can only be deleted manually. The learned entries will be saved even the switch is rebooted.</p> <p><b>status</b>: Status of port security feature. By default, it is disabled.</p> <p><i>drop</i>: When the number of learned MAC addresses reaches the limit, the port will stop learning and discard the packets with the MAC addresses that have not been learned.</p> <p><i>forward</i>: When the number of learned MAC addresses reaches the limit, the port will stop learning but send the packets with the MAC addresses that have not been learned.</p> <p><i>disable</i>: The number limit on the port is not effective, and the switch follows the original forwarding rules. It is the default setting.</p> |
| Step 4 | <b>show mac address-table max-mac-count interface</b> { fastEthernet <i>port</i>   gigabitEthernet <i>port</i>   ten-gigabitEthernet <i>port</i> }                                                                                                                                                                                                                                                                                                                                                                                                                                                                                                                                                                                                                                                                                                                                                                                                                                                                                                                                                                                                                                                                                                                                                                                                                                                                                                             |
|        | Verify the Port Security configuration and the current learned MAC addresses of the port.                                                                                                                                                                                                                                                                                                                                                                                                                                                                                                                                                                                                                                                                                                                                                                                                                                                                                                                                                                                                                                                                                                                                                                                                                                                                                                                                                                      |
| Step 5 | <b>end</b><br>Return to privileged EXEC mode.                                                                                                                                                                                                                                                                                                                                                                                                                                                                                                                                                                                                                                                                                                                                                                                                                                                                                                                                                                                                                                                                                                                                                                                                                                                                                                                                                                                                                  |
| Step 6 | <b>copy running-config startup-config</b><br>Save the settings in the configuration file.                                                                                                                                                                                                                                                                                                                                                                                                                                                                                                                                                                                                                                                                                                                                                                                                                                                                                                                                                                                                                                                                                                                                                                                                                                                                                                                                                                      |

The following example shows how to set the maximum number of MAC addresses that can be learned on port 1/0/1 as 30 and configure the mode as permanent and the status as drop:

### Switch#configure

```
Switch(config)#interface ten-gigabitEthernet 1/0/1
```

```
Switch(config-if)#mac address-table max-mac-count max-number 30 mode permanent
status drop
```

```
Switch(config-if)#show mac address-table max-mac-count interface ten-
gigabitEthernet 1/0/1
```

| Port    | Max-learn | Current-learn | Mode      | Status |
|---------|-----------|---------------|-----------|--------|
| ----    | -----     | -----         | -----     | -----  |
| Te1/0/1 | 30        | 0             | permanent | drop   |

```
Switch(config-if)#end
```

```
Switch#copy running-config startup-config
```



# 5 Port Isolation Configurations

## 5.1 Using the GUI

Choose the menu **Switching > Port > Port Isolation** to load the following page.

Figure 5-1 Port Isolation List

| Port Isolation List                       |     |                  |
|-------------------------------------------|-----|------------------|
| UNIT: <input type="text" value="1"/> LAGS |     |                  |
| Port                                      | LAG | Forward Portlist |
| 1/0/1                                     | --- | 1/0/1-16,LAG1-14 |
| 1/0/2                                     | --- | 1/0/1-16,LAG1-14 |
| 1/0/3                                     | --- | 1/0/1-16,LAG1-14 |
| 1/0/4                                     | --- | 1/0/1-16,LAG1-14 |
| 1/0/5                                     | --- | 1/0/1-16,LAG1-14 |
| 1/0/6                                     | --- | 1/0/1-16,LAG1-14 |
| 1/0/7                                     | --- | 1/0/1-16,LAG1-14 |
| 1/0/8                                     | --- | 1/0/1-16,LAG1-14 |
| 1/0/9                                     | --- | 1/0/1-16,LAG1-14 |
| 1/0/10                                    | --- | 1/0/1-16,LAG1-14 |
| 1/0/11                                    | --- | 1/0/1-16,LAG1-14 |

The above page displays the port isolation list. Click **Edit** to configure Port Isolation on the following page.

Figure 5-2 Port Isolation

Port Isolation Config

Port:

UNIT: 1 LAGS

|   |   |   |   |    |    |    |    |
|---|---|---|---|----|----|----|----|
| 2 | 4 | 6 | 8 | 10 | 12 | 14 | 16 |
| 1 | 3 | 5 | 7 | 9  | 11 | 13 | 15 |

All
Clear
Help

Forward Portlist:

UNIT: 1 LAGS

|   |   |   |   |    |    |    |    |
|---|---|---|---|----|----|----|----|
| 2 | 4 | 6 | 8 | 10 | 12 | 14 | 16 |
| 1 | 3 | 5 | 7 | 9  | 11 | 13 | 15 |

All
Clear
Apply
Back

Unselected Port(s)

Selected Port(s)

Not Available for Selection

Follow these steps to configure Port Isolation:

- 1) In the **Port** section, select one or multiple ports to be isolated.
- 2) In the **Forward Portlist** section, select the forward ports or LAGs which the isolated ports can only communicate with. It is multi-optional.
- 3) Click **Apply**.

## 5.2 Using the CLI

Follow these steps to configure Port Isolation:

|        |                                                                                                                                                                                                                                                                                                                                                          |
|--------|----------------------------------------------------------------------------------------------------------------------------------------------------------------------------------------------------------------------------------------------------------------------------------------------------------------------------------------------------------|
| Step 1 | <b>configure</b><br>Enter global configuration mode.                                                                                                                                                                                                                                                                                                     |
| Step 2 | <b>interface {fastEthernet port   range fastEthernet port-list   gigabitEthernet port   range gigabitEthernet port-list   ten-gigabitEthernet port   range ten-gigabitEthernet port-list }</b><br>Enter interface configuration mode.                                                                                                                    |
| Step 3 | <b>port isolation { [gi-forward-list gi-forward-list] [ po-forward-list po-forward-list ] }</b><br>Specify ports or LAGs to the forward list of the specific port which can only communicate with the forward ports or LAGs. It is multi-optional.<br><i>gi-forward-list</i> : The list of Ethernet ports.<br><i>po-forward-list</i> : The list of LAGs. |

- 
- Step 4      **show port isolation interface { fastEthernet *port* | gigabitEthernet *port* | ten-gigabitEthernet *port* }**  
Verify the Port Isolation configuration of the specified port.
- 
- Step 5      **end**  
Return to privileged EXEC mode.
- 
- Step 6      **copy running-config startup-config**  
Save the settings in the configuration file.
- 

The following example shows how to add ports 1/0/1-3 and LAG 4 to the forward list of port 1/0/5:

**Switch#configure**

**Switch(config)#interface ten-gigabitEthernet 1/0/5**

**Switch(config-if)#port isolation gi-forward-list 1/0/1-3 po-forward-list 4**

**Switch(config-if)#show port isolation interface ten-gigabitEthernet 1/0/5**

| Port    | LAG | Forward-List  |
|---------|-----|---------------|
| ----    | --- | -----         |
| Te1/0/5 | N/A | Te1/0/1-3,Po4 |

**Switch(config-if)#end**

**Switch#copy running-config startup-config**

# 6 Loopback Detection Configuration

## 6.1 Using the GUI

To avoid broadcast storm, we recommend that you enable storm control before loopback detection is enabled. For detailed introductions about storm control, refer to [Configuring QoS](#).

Choose the menu **Switching > Port > Loopback Detection** to load the following page.

Figure 6-1 Loopback Detection

**Global config**

Loopback Detection Status:  Enable  Disable

Detection Interval:  seconds(1-1000)

Automatic Recovery Time:  detection times(1-100) Apply

Web Refresh Status:  Enable  Disable

Web Refresh Interval:  seconds(3-100)

**Port Config**

UNIT:

| Select                   | Port   | Status                               | Operation mode                     | Recovery mode                     | Loop status | Block status | LAG |
|--------------------------|--------|--------------------------------------|------------------------------------|-----------------------------------|-------------|--------------|-----|
| <input type="checkbox"/> |        | <input type="text" value="Disable"/> | <input type="text" value="Alert"/> | <input type="text" value="Auto"/> | ---         | ---          | --- |
| <input type="checkbox"/> | 1/0/1  | Disable                              | Alert                              | Auto                              | ---         | ---          | --- |
| <input type="checkbox"/> | 1/0/2  | Disable                              | Alert                              | Auto                              | ---         | ---          | --- |
| <input type="checkbox"/> | 1/0/3  | Disable                              | Alert                              | Auto                              | ---         | ---          | --- |
| <input type="checkbox"/> | 1/0/4  | Disable                              | Alert                              | Auto                              | ---         | ---          | --- |
| <input type="checkbox"/> | 1/0/5  | Disable                              | Alert                              | Auto                              | ---         | ---          | --- |
| <input type="checkbox"/> | 1/0/6  | Disable                              | Alert                              | Auto                              | ---         | ---          | --- |
| <input type="checkbox"/> | 1/0/7  | Disable                              | Alert                              | Auto                              | ---         | ---          | --- |
| <input type="checkbox"/> | 1/0/8  | Disable                              | Alert                              | Auto                              | ---         | ---          | --- |
| <input type="checkbox"/> | 1/0/9  | Disable                              | Alert                              | Auto                              | ---         | ---          | --- |
| <input type="checkbox"/> | 1/0/10 | Disable                              | Alert                              | Auto                              | ---         | ---          | --- |
| <input type="checkbox"/> | 1/0/11 | Disable                              | Alert                              | Auto                              | ---         | ---          | --- |
| <input type="checkbox"/> | 1/0/12 | Disable                              | Alert                              | Auto                              | ---         | ---          | --- |
| <input type="checkbox"/> | 1/0/13 | Disable                              | Alert                              | Auto                              | ---         | ---          | --- |
| <input type="checkbox"/> | 1/0/14 | Disable                              | Alert                              | Auto                              | ---         | ---          | --- |

All
Apply
Recover
Help

Follow these steps to configure loopback detection:

- 1) In the **Global Config** section, enable loopback detection and configure the global parameters. Then click **Apply**.

|                           |                                                                                                                                                                                                                                                          |
|---------------------------|----------------------------------------------------------------------------------------------------------------------------------------------------------------------------------------------------------------------------------------------------------|
| Loopback Detection Status | Enable loopback detection globally.                                                                                                                                                                                                                      |
| Detection Interval        | Set the interval of sending loopback detection packets.<br>The valid values are from 1 to 1000 seconds and the default value is 30 seconds.                                                                                                              |
| Automatic Recovery Time   | Set the recovery time globally, after which the blocked port in Auto Recovery mode can automatically recover to normal status.<br><br>It should be integral times of detection interval. The valid values are from 1 to 100, and the default value is 3. |
| Web Refresh Status        | With this option enabled, the switch refreshes the web timely. By default, it is disabled.                                                                                                                                                               |
| Web Refresh Interval      | If you enabled web refresh, set the refresh interval between 3 and 100 seconds. The default value is 6 seconds.                                                                                                                                          |

- 2) In the **Port Config** section, select one or multiple ports for configuration. Then set the parameters and click **Apply**.

|                |                                                                                                                                                                                                                                                                                                                                                                                                              |
|----------------|--------------------------------------------------------------------------------------------------------------------------------------------------------------------------------------------------------------------------------------------------------------------------------------------------------------------------------------------------------------------------------------------------------------|
| Status         | Enable loopback detection for the port.                                                                                                                                                                                                                                                                                                                                                                      |
| Operation Mode | Select the operation mode when a loopback is detected on the port:<br><br><b>Alert:</b> The switch will display alerts. It is the default setting.<br><br><b>Port Based:</b> In addition to displaying alerts, the switch will block the port on which the loop is detected.                                                                                                                                 |
| Recovery Mode  | If you select <b>Port Based</b> as the operation mode, you also need to configure the recovery mode for the blocked port:<br><br><b>Auto:</b> The blocked port will automatically recover to normal status after the automatic recovery time. It is the default setting.<br><br><b>Manual:</b> You need to manually release the blocked port. Click the <b>Recovery</b> button to release the selected port. |

- 3) View the loopback detection information on this page.

|              |                                                  |
|--------------|--------------------------------------------------|
| Loop Status  | Displays whether a loop is detected on the port. |
| Block Status | Displays whether the port is blocked.            |

## 6.2 Using the CLI

Follow these steps to configure Loopback Detection:

|        |                                                      |
|--------|------------------------------------------------------|
| Step 1 | <b>configure</b><br>Enter global configuration mode. |
|--------|------------------------------------------------------|

|         |                                                                                                                                                                                                                                                                                                                                                                                                                                                                                                                                                                                                                                                                                                                                                                                                                                              |
|---------|----------------------------------------------------------------------------------------------------------------------------------------------------------------------------------------------------------------------------------------------------------------------------------------------------------------------------------------------------------------------------------------------------------------------------------------------------------------------------------------------------------------------------------------------------------------------------------------------------------------------------------------------------------------------------------------------------------------------------------------------------------------------------------------------------------------------------------------------|
| Step 2  | <b>loopback-detection</b><br>Enable the loopback detection feature globally. By default, it is disabled.                                                                                                                                                                                                                                                                                                                                                                                                                                                                                                                                                                                                                                                                                                                                     |
| Step 3  | <b>loopback-detection interval <i>interval-time</i></b><br>Set the interval of sending loopback detection packets which is used to detect the loops in the network.<br><i>interval-time</i> : The interval of sending loopback detection packets. The valid values are from 1 to 1000 seconds. By default, the value is 30 seconds.                                                                                                                                                                                                                                                                                                                                                                                                                                                                                                          |
| Step 4  | <b>loopback-detection recovery-time <i>recovery-time</i></b><br>Set the recovery time, after which the blocked port in Auto Recovery mode can automatically recover to normal status.<br><i>recovery-time</i> : It is integral times of detection interval, ranging from 1 to 100. The default value is 3.                                                                                                                                                                                                                                                                                                                                                                                                                                                                                                                                   |
| Step 5  | <b>interface {fastEthernet <i>port</i>   range fastEthernet <i>port-list</i>   gigabitEthernet <i>port</i>   range gigabitEthernet <i>port-list</i>   ten-gigabitEthernet <i>port</i>   range ten-gigabitEthernet <i>port-list</i> }</b><br>Enter interface configuration mode.                                                                                                                                                                                                                                                                                                                                                                                                                                                                                                                                                              |
| Step 6  | <b>loopback-detection</b><br>Enable loopback detection of the port. By default, it is disabled.                                                                                                                                                                                                                                                                                                                                                                                                                                                                                                                                                                                                                                                                                                                                              |
| Step 7  | <b>loopback-detection config [ process-mode { alert   port-based } ] [ recovery-mode { auto   manual } ]</b><br>Set the process mode when a loopback is detected on the port. There are two modes:<br><br><b>alert</b> : The switch will only display alerts when a loopback is detected. It is the default setting.<br><b>port-based</b> : In addition to displaying alerts, the switch will block the port on which the loop is detected.<br><br>Set the recovery mode for the blocked port. There are two modes:<br><b>auto</b> : After the recovery time, the blocked port will automatically recover to normal status and restart to detect loops in the network.<br><b>manual</b> : The blocked port can only be released manually. You can use the command 'loopback-detection recover' to recover the blocked port to normal status. |
| Step 9  | <b>show loopback-detection global</b><br>Verify the global configuration of Loopback Detection.                                                                                                                                                                                                                                                                                                                                                                                                                                                                                                                                                                                                                                                                                                                                              |
| Step 10 | <b>show loopback-detection interface { fastEthernet <i>port</i>   gigabitEthernet <i>port</i>   ten-gigabitEthernet <i>port</i> }</b><br>Verify the Loopback Detection configuration of the specified port.                                                                                                                                                                                                                                                                                                                                                                                                                                                                                                                                                                                                                                  |
| Step 11 | <b>end</b><br>Return to privileged EXEC mode.                                                                                                                                                                                                                                                                                                                                                                                                                                                                                                                                                                                                                                                                                                                                                                                                |
| Step 12 | <b>copy running-config startup-config</b><br>Save the settings in the configuration file.                                                                                                                                                                                                                                                                                                                                                                                                                                                                                                                                                                                                                                                                                                                                                    |

The following example shows how to enable loopback detection globally (keeping the default parameters):

```
Switch#configure
```

```
Switch(config)#loopback-detection
```

```
Switch(config)#show loopback-detection global
```

```
Loopback detection global status : enable
```

```
Loopback detection interval : 30 s
```

```
Loopback detection recovery time : 3 intervals
```

```
Switch(config-if)#end
```

```
Switch#copy running-config startup-config
```

The following example shows how to enable loopback detection of port 1/0/3 and set the process mode as alert and recovery mode as auto:

```
Switch#configure
```

```
Switch(config)#interface ten-gigabitEthernet 1/0/3
```

```
Switch(config-if)#loopback-detection
```

```
Switch(config-if)#loopback-detection config process-mode alert recovery-mode auto
```

```
Switch(config-if)#show loopback-detection interface ten-gigabitEthernet 1/0/3
```

| Port    | Enable | Process Mode | Recovery Mode | Loopback | Block | LAG   |
|---------|--------|--------------|---------------|----------|-------|-------|
| ----    | -----  | -----        | -----         | -----    | ----- | ----- |
| Te1/0/3 | enable | alert        | auto          | N/A      | N/A   | N/A   |

```
Switch(config-if)#end
```

```
Switch#copy running-config startup-config
```

# 7 Configuration Examples

## 7.1 Example for Port Mirror

### 7.1.1 Network Requirements

As shown below, several hosts and a network analyzer are directly connected to the switch. For network security and troubleshooting, the network manager needs to use the network analyzer to monitor the data packets from the end hosts.

Figure 7-1 Network Topology

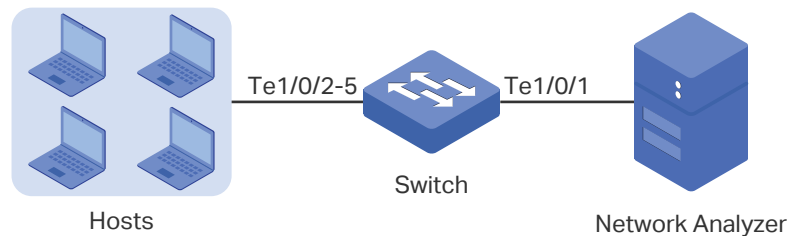

### 7.1.2 Configuration Scheme

To implement this requirement, you can configure port mirror to copy the packets from ports 1/0/2-5 to port 1/0/1. The overview of configuration is as follows:

- 1) Specify ports 1/0/2-5 as the source ports, allowing the switch to copy the packets from the hosts.
- 2) Specify port 1/0/1 as the destination port so that the network analyzer can receive mirrored packets from the hosts.

Demonstrated with T1700X-16TS, the following sections provide configuration procedure in two ways: using the GUI and using the CLI.

### 7.1.3 Using the GUI

- 1) Choose the menu **Switching > Port > Port Mirror** to load the following page. It displays the information of the mirror session.



Figure 7-2 Mirror Session List

| Mirror Session List |             |              |        |                                            |
|---------------------|-------------|--------------|--------|--------------------------------------------|
| Session             | Destination | Mode         | Source | Operation                                  |
| 1                   | ---         | Ingress Only |        | <a href="#">Edit</a> <a href="#">Clear</a> |
|                     |             | Egress Only  |        |                                            |
|                     |             | Both         |        |                                            |

[Help](#)

- 2) Click **Edit** on the above page to load the following page. In the **Destination Port** section, select port 1/0/1 as the monitoring port and click **Apply**.

Figure 7-3 Destination Port Configuration

**Destination Port**

Destination Port:  (Format: 1/0/1) [Apply](#)

UNIT:

|                                       |                            |                            |                            |                             |                             |                             |                             |
|---------------------------------------|----------------------------|----------------------------|----------------------------|-----------------------------|-----------------------------|-----------------------------|-----------------------------|
| <input type="checkbox"/> 2            | <input type="checkbox"/> 4 | <input type="checkbox"/> 6 | <input type="checkbox"/> 8 | <input type="checkbox"/> 10 | <input type="checkbox"/> 12 | <input type="checkbox"/> 14 | <input type="checkbox"/> 16 |
| <input checked="" type="checkbox"/> 1 | <input type="checkbox"/> 3 | <input type="checkbox"/> 5 | <input type="checkbox"/> 7 | <input type="checkbox"/> 9  | <input type="checkbox"/> 11 | <input type="checkbox"/> 13 | <input type="checkbox"/> 15 |

Unselected Port(s)   
  Selected Port(s)   
  Not Available for Selection

- 3) In the **Source Port** section, select ports 1/0/2-5 as the monitored ports, and enable **Ingress** and **Egress** to allow the received and sent packets to be copied to the monitoring port. Then click **Apply**.

Figure 7-4 Source Port Configuration

| Source Port                         |        |         |         |     |
|-------------------------------------|--------|---------|---------|-----|
| UNIT: 1 LAGS                        |        |         |         |     |
| Select                              | Port   | Ingress | Egress  | LAG |
| <input type="checkbox"/>            |        | Enable  | Enable  |     |
| <input type="checkbox"/>            | 1/0/1  | Disable | Disable | --- |
| <input checked="" type="checkbox"/> | 1/0/2  | Disable | Disable | --- |
| <input checked="" type="checkbox"/> | 1/0/3  | Disable | Disable | --- |
| <input checked="" type="checkbox"/> | 1/0/4  | Disable | Disable | --- |
| <input checked="" type="checkbox"/> | 1/0/5  | Disable | Disable | --- |
| <input type="checkbox"/>            | 1/0/6  | Disable | Disable | --- |
| <input type="checkbox"/>            | 1/0/7  | Disable | Disable | --- |
| <input type="checkbox"/>            | 1/0/8  | Disable | Disable | --- |
| <input type="checkbox"/>            | 1/0/9  | Disable | Disable | --- |
| <input type="checkbox"/>            | 1/0/10 | Disable | Disable | --- |
| <input type="checkbox"/>            | 1/0/11 | Disable | Disable | --- |
| <input type="checkbox"/>            | 1/0/12 | Disable | Disable | --- |

4) Click **Save Config** to save the settings.

## 7.1.4 Using the CLI

```
Switch#configure
```

```
Switch(config)#monitor session 1 destination interface ten-gigabitEthernet 1/0/1
```

```
Switch(config)#monitor session 1 source interface ten-gigabitEthernet 1/0/2-5 both
```

```
Switch(config)#end
```

```
Switch#copy running-config startup-config
```

### Verify the Configuration

```
Switch#show monitor session 1
```

```
Monitor Session:      1
```

```
Destination Port:    Te1/0/1
```

```
Source Ports(Ingress): Te1/0/2-5
```

```
Source Ports(Egress): Te1/0/2-5
```

## 7.2 Example for Port Isolation

### 7.2.1 Network Requirements

As shown below, three hosts and a server are connected to the switch and all belong to VLAN 10. With the VLAN configuration unchanged, Host A is not allowed to communicate with the other hosts except the server, even if the MAC address or IP address of Host A is changed.

Figure 7-5 Network Topology

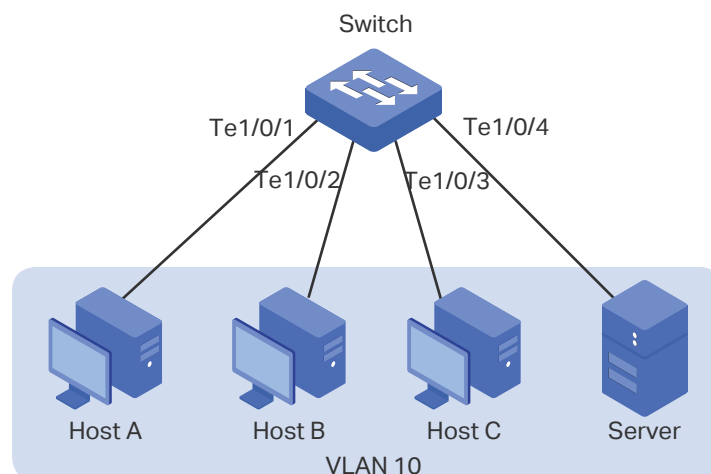

### 7.2.2 Configuration Scheme

You can configure port isolation to implement the requirement. Set 1/0/4 as the only forwarding port for port 1/0/1, thus forbidding Host A to forward packets to the other hosts.

Demonstrated with T1700X-16TS, the following sections provide configuration procedure in two ways: using the GUI and using the CLI.

### 7.2.3 Using the GUI

- 1) Choose the menu **Switching > Port > Port Isolation** to load the following page. It displays the port isolation list.

Figure 7-6 Port Isolation List

| Port Isolation List |     |                  |
|---------------------|-----|------------------|
| UNIT: 1 LAGS        |     |                  |
| Port                | LAG | Forward Portlist |
| 1/0/1               | --- | 1/0/1-16,LAG1-14 |
| 1/0/2               | --- | 1/0/1-16,LAG1-14 |
| 1/0/3               | --- | 1/0/1-16,LAG1-14 |
| 1/0/4               | --- | 1/0/1-16,LAG1-14 |
| 1/0/5               | --- | 1/0/1-16,LAG1-14 |
| 1/0/6               | --- | 1/0/1-16,LAG1-14 |
| 1/0/7               | --- | 1/0/1-16,LAG1-14 |
| 1/0/8               | --- | 1/0/1-16,LAG1-14 |
| 1/0/9               | --- | 1/0/1-16,LAG1-14 |
| 1/0/10              | --- | 1/0/1-16,LAG1-14 |
| 1/0/11              | --- | 1/0/1-16,LAG1-14 |

- 2) Click **Edit** on the above page to load the following page. Select port 1/0/1 as the isolated port, and select port 1/0/4 as the forwarding port. Click **Apply**.

Figure 7-7 Port Isolation Configuration

**Port Isolation Config**

Port:  
UNIT: 1 LAGS

|   |   |   |   |    |    |    |    |
|---|---|---|---|----|----|----|----|
| 2 | 4 | 6 | 8 | 10 | 12 | 14 | 16 |
| 1 | 3 | 5 | 7 | 9  | 11 | 13 | 15 |

---

**Forward Portlist:**  
UNIT: 1 LAGS

|   |   |   |   |    |    |    |    |
|---|---|---|---|----|----|----|----|
| 2 | 4 | 6 | 8 | 10 | 12 | 14 | 16 |
| 1 | 3 | 5 | 7 | 9  | 11 | 13 | 15 |

Unselected Port(s)
  Selected Port(s)
  Not Available for Selection

- 3) Click **Save Config** to save the settings.

## 7.2.4 Using the CLI

```
Switch#configure
Switch(config)#interface ten-gigabitEthernet 1/0/1
Switch(config-if)#port isolation gi-forward-list 1/0/4
Switch(config-if)#end
Switch#copy running-config startup-config
```

### Verify the Configuration

```
Switch#show port isolation interface
```

| Port    | LAG | Forward-List      |
|---------|-----|-------------------|
| ----    | --- | -----             |
| Te1/0/1 | N/A | Te1/0/4           |
| Te1/0/2 | N/A | Te1/0/1-28,Po1-14 |
| Te1/0/3 | N/A | Te1/0/1-28,Po1-14 |
| .....   |     |                   |

## 7.3 Example for Loopback Detection

### 7.3.1 Network Requirements

As shown below, Switch A is a convergence-layer switch connecting several access-layer switches. Loops can be easily caused in case of misoperation on the access-layer switches. If there is a loop on an access-layer switch, broadcast storms will occur on Switch A or even in the entire network, creating excessive traffic and degrading the network performance.

To reduce the impacts of broadcast storms, users need to detect loops in the network via Switch A and timely block the port on which a loop is detected.

Figure 7-8 Network Topology

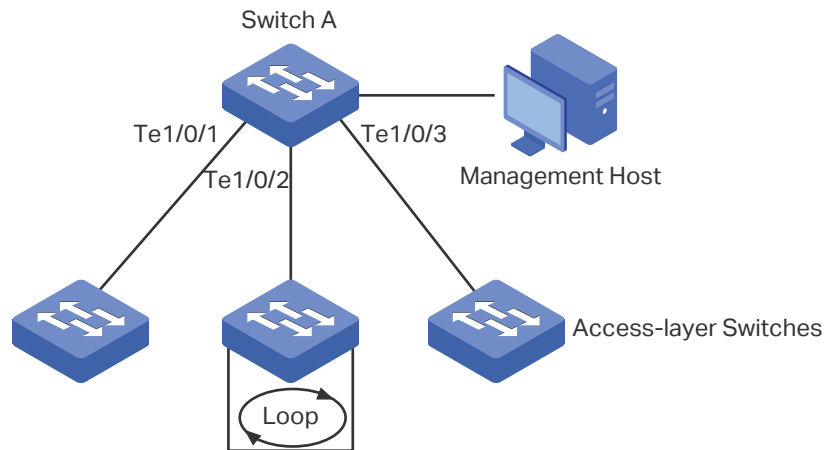

### 7.3.2 Configuration Scheme

Enable loopback detection on ports 1/0/1-3 and configure SNMP to receive the notifications. For detailed instructions about SNMP, refer to *Configuring SNMP & RMON*. Here we introduce how to configure loopback detection and monitor the detection result on the management interface of the switch.

Demonstrated with T1700X-16TS, the following sections provide configuration procedure in two ways: using the GUI and using the CLI.

### 7.3.3 Using the GUI

- 1) Choose the menu **Switching > Port > Loopback Detection** to load the configuration page.
- 2) In the **Global Config** section, enable loopback detection and web refresh globally. Keep the default parameters and click **Apply**.

Figure 7-9 Global Configuration

| Global config                        |                                                                       |
|--------------------------------------|-----------------------------------------------------------------------|
| Loopback Detection Status:           | <input checked="" type="radio"/> Enable <input type="radio"/> Disable |
| Detection Interval:                  | <input type="text" value="30"/> seconds(1-1000)                       |
| Automatic Recovery Time:             | <input type="text" value="3"/> detection times(1-100)                 |
| Web Refresh Status:                  | <input checked="" type="radio"/> Enable <input type="radio"/> Disable |
| Web Refresh Interval:                | <input type="text" value="6"/> seconds(3-100)                         |
| <input type="button" value="Apply"/> |                                                                       |

- 3) In the **Port Config** section, enable ports 1/0/1-3, select the operation mode as **Port based** so that the port will be blocked when a loop is detected, and keep the recovery mode as **Auto** so that the port will recover to normal status after the automatic recovery time. Click **Apply**.

Figure 7-10 Port Configuration

| Port Config                         |        |                      |                      |                      |             |              |     |
|-------------------------------------|--------|----------------------|----------------------|----------------------|-------------|--------------|-----|
| UNIT: 1                             |        |                      |                      |                      |             |              |     |
| Select                              | Port   | Status               | Operation mode       | Recovery mode        | Loop status | Block status | LAG |
| <input type="checkbox"/>            |        | <input type="text"/> | <input type="text"/> | <input type="text"/> |             |              |     |
| <input checked="" type="checkbox"/> | 1/0/1  | Enable               | Port based           | Auto                 | ---         | ---          | --- |
| <input checked="" type="checkbox"/> | 1/0/2  | Enable               | Port based           | Auto                 | ---         | ---          | --- |
| <input checked="" type="checkbox"/> | 1/0/3  | Enable               | Port based           | Auto                 | ---         | ---          | --- |
| <input type="checkbox"/>            | 1/0/4  | Disable              | Alert                | Auto                 | ---         | ---          | --- |
| <input type="checkbox"/>            | 1/0/5  | Disable              | Alert                | Auto                 | ---         | ---          | --- |
| <input type="checkbox"/>            | 1/0/6  | Disable              | Alert                | Auto                 | ---         | ---          | --- |
| <input type="checkbox"/>            | 1/0/7  | Disable              | Alert                | Auto                 | ---         | ---          | --- |
| <input type="checkbox"/>            | 1/0/8  | Disable              | Alert                | Auto                 | ---         | ---          | --- |
| <input type="checkbox"/>            | 1/0/9  | Disable              | Alert                | Auto                 | ---         | ---          | --- |
| <input type="checkbox"/>            | 1/0/10 | Disable              | Alert                | Auto                 | ---         | ---          | --- |
| <input type="checkbox"/>            | 1/0/11 | Disable              | Alert                | Auto                 | ---         | ---          | --- |
| <input type="checkbox"/>            | 1/0/12 | Disable              | Alert                | Auto                 | ---         | ---          | --- |
| <input type="checkbox"/>            | 1/0/13 | Disable              | Alert                | Auto                 | ---         | ---          | --- |
| <input type="checkbox"/>            | 1/0/14 | Disable              | Alert                | Auto                 | ---         | ---          | --- |

- 4) Monitor the detection result on the above page. The **Loop status** and **Block status** are displayed on the right side of ports.

### 7.3.4 Using the CLI

- 1) Enable loopback detection globally and configure the detection interval and recovery time.

```
Switch#configure
```

```
Switch(config)#loopback-detection
```

```
Switch(config)#loopback-detection interval 30
```

```
Switch(config)#loopback-detection recovery-time 3
```

- 2) Enable loopback detection on ports 1/0/1-3 and set the process mode and recovery mode.

```
Switch(config)#interface ten-gigabitEthernet 1/0/1
```

```
Switch(config-if)#loopback-detection
```

```
Switch(config-if)#loopback-detection config process-mode port-based recovery-mode auto
```

```
Switch(config-if)#exit
```

```
Switch(config)#interface ten-gigabitEthernet 1/0/2
```

```
Switch(config-if)#loopback-detection
```

```

Switch(config-if)#loopback-detection config process-mode port-based recovery-mode
auto

Switch(config-if)#exit

Switch(config)#interface ten-gigabitEthernet 1/0/3

Switch(config-if)#loopback-detection

Switch(config-if)#loopback-detection config process-mode port-based recovery-mode
auto

Switch(config-if)#end

Switch#copy running-config startup-config

```

### Verify the Configuration

Verify the global configuration:

```

Switch#show loopback-detection global

Loopback detection global status : disable

Loopback detection interval: 30 s

Loopback detection recovery time : 3 intervals

```

Verify the loopback detection configuration on ports:

```
Switch#show loopback-detection interface
```

| Port    | Enable | Process Mode | Recovery Mode | Loopback | Block | LAG |
|---------|--------|--------------|---------------|----------|-------|-----|
| Te1/0/1 | enable | port-based   | auto          | N/A      | N/A   | N/A |
| Te1/0/2 | enable | port-based   | auto          | N/A      | N/A   | N/A |
| Te1/0/3 | enable | port-based   | auto          | N/A      | N/A   | N/A |



# 8 Appendix: Default Parameters

Default settings of Switching are listed in the following tables.

Table 8-1 Configurations for Ports

| Parameter                 | Default Setting   |
|---------------------------|-------------------|
| Port Config               |                   |
| Type                      | Copper            |
| Status                    | Enable            |
| Speed                     | Auto              |
| Duplex                    | Auto              |
| Flow Control              | Disable           |
| Jumbo                     | Disable           |
| Port Mirror               |                   |
| Ingress                   | Disable           |
| Egress                    | Disable           |
| Port Security             |                   |
| Max Learned MAC           | 64                |
| Learned Num               | 0                 |
| Learned Mode              | Dynamic           |
| Status                    | Disable           |
| Loopback Detection        |                   |
| Loopback Detection Status | Disable           |
| Detection Interval        | 30 seconds        |
| Automatic Recovery Time   | 3 detection times |
| Web Refresh Status        | Disable           |
| Web Refresh Interval      | 6 seconds         |

| Parameter      | Default Setting |
|----------------|-----------------|
| Port Status    | Disable         |
| Operation mode | Alert           |
| Recovery mode  | Auto            |

# Part 4

## Configuring LAG

### CHAPTERS

1. LAG
2. LAG Configuration
3. Configuration Example
4. Appendix: Default Parameters

# 1 LAG

## 1.1 Overview

With LAG (Link Aggregation Group) function, you can aggregate multiple physical ports into a logical interface to increase link bandwidth and configure the backup ports to enhance the connection reliability.

## 1.2 Supported Features

You can configure LAG in two ways: static LAG and LACP (Link Aggregation Control Protocol).

### Static LAG

The member ports are manually added to the LAG.

### LACP

The switch uses LACP to implement dynamic link aggregation and disaggregation by exchanging LACP packets with its partner. LACP extends the flexibility of the LAG configuration.

# 2 LAG Configuration

To complete LAG configuration, follow these steps:

- 1) Configure the global load-balancing algorithm.
- 2) Configure Static LAG or LACP.

## Configuration Guidelines

- Ensure that both ends of the aggregation link work in the same LAG mode. For example, if the local end works in LACP mode, the peer end should be set as LACP mode.
- Ensure that devices on both ends of the aggregation link use the same number of physical ports with the same speed, duplex, jumbo and flow control mode.
- A port cannot be added to more than one LAG at the same time.
- LACP does not support half-duplex links.
- One static LAG supports up to eight member ports. All the member ports share the traffic evenly. If an active link fails, the other active links share the traffic evenly.
- One LACP LAG supports more than eight member ports, but at most eight of them can be active. Using LACP protocol, the switches negotiate parameters and determine the active ports. When an active link fails, the link with the highest priority among the inactive links will replace the faulty link and start to forward data.
- For the functions like IGMP Snooping, 802.1Q VLAN, MAC VLAN, Protocol VLAN, VLAN-VPN, GVRP, Voice VLAN, STP, QoS, DHCP Snooping and Flow-Control, the member port of an LAG follows the configuration of the LAG but not its own. The configurations of the port can take effect only after it leaves the LAG.
- The port which is enabled with Port Security, Port Mirror, MAC Address Filtering or 802.1X cannot be added to LAG, and the member port of an LAG cannot be enabled with these functions.

## 2.1 Using the GUI

### 2.1.1 Configuring Load-balancing Algorithm

Choose the menu **Switching > LAG > LAG Table** to load the following page.

Figure 2-1 Global Config

The screenshot shows the 'Global Config' section with a 'Hash Algorithm' dropdown menu set to 'SRC MAC+DST MAC' and an 'Apply' button. Below it is the 'LAG Table' section, which is currently empty, displaying 'No entry in the table.' and buttons for 'All', 'Delete', and 'Help'.

| Select                 | Group Number | Description | Member | Operation |
|------------------------|--------------|-------------|--------|-----------|
| No entry in the table. |              |             |        |           |

In the **Global Config** section, select the load-balancing algorithm. Click **Apply**.

#### Hash Algorithm

Select the Hash Algorithm, based on which the switch can choose the port to send the received packets. In this way, different data flows are forwarded on different physical links to implement load balancing. There are six options:

**SRC MAC:** The computation is based on the source MAC addresses of the packets.

**DST MAC:** The computation is based on the destination MAC addresses of the packets.

**SRC MAC+DST MAC:** The computation is based on the source and destination MAC addresses of the packets.

**SRC IP:** The computation is based on the source IP addresses of the packets.

**DST IP:** The computation is based on the destination IP addresses of the packets.

**SRC IP+DST IP:** The computation is based on the source and destination IP addresses of the packets.

#### Tips:

- Load-balancing algorithm is effective only for outgoing traffic. If the data stream is not well shared by each link, you can change the algorithm of the outgoing interface.
- Please properly choose the load-balancing algorithm to avoid data stream transferring only on one physical link. For example, Switch A receives packets from several hosts and forwards them to the Server with the fixed MAC address and IP address, you can set the algorithm as "SRC MAC+SRC IP" to allow Switch A to determine the forwarding port based on the source MAC addresses and source IP addresses of the received packets.

Figure 2-2 Hash Algorithm Configuration

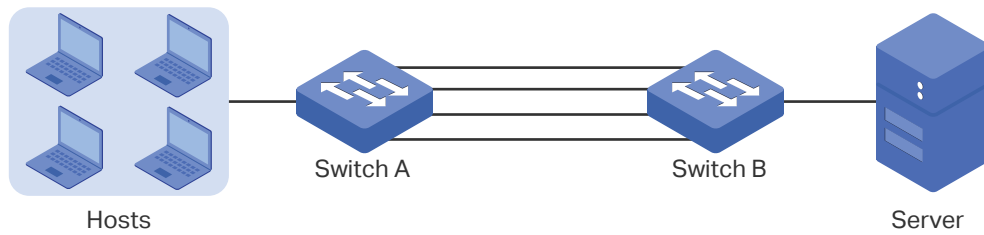

## 2.1.2 Configuring Static LAG or LACP

For one port, you can choose only one LAG mode: Static LAG or LACP. And make sure both ends of a link use the same LAG mode.

### ■ Configuring Static LAG

Choose the menu **Switching > LAG > Static LAG** to load the following page.

Figure 2-3 Static LAG

**LAG Config**

Group Number:

Description:

**Member Port**

UNIT:

|   |   |   |   |    |    |    |    |
|---|---|---|---|----|----|----|----|
| 2 | 4 | 6 | 8 | 10 | 12 | 14 | 16 |
| 1 | 3 | 5 | 7 | 9  | 11 | 13 | 15 |

Unselected Port(s)

Selected Port(s)

Not Available for Selection

Follow these steps to configure the static LAG:

- 1) In the **LAG Config** section, select an LAG for configuration.

|                     |                                             |
|---------------------|---------------------------------------------|
| <b>Group Number</b> | Select an LAG for static LAG configuration. |
| <b>Description</b>  | Displays the LAG mode.                      |

- 2) In the **Member Port** section, select the member ports for the LAG. It is multi-optional.
- 3) Click **Apply**.

**Note:**

Clearing all member ports will delete the LAG.

## ■ Configuring LACP

Choose the menu **Switching > LAG > LACP** to load the following page.

Figure 2-4 LACP Config

**Global Config**

System Priority:  (0-65535)

**LACP Config**

UNIT:

| Select                   | Port   | Admin Key                                 | Port Priority(0-65535)                    | Mode                                   | Status                                 | LAG |
|--------------------------|--------|-------------------------------------------|-------------------------------------------|----------------------------------------|----------------------------------------|-----|
| <input type="checkbox"/> |        | <input style="width: 60px;" type="text"/> | <input style="width: 60px;" type="text"/> | <input type="text" value="Passive"/> ▾ | <input type="text" value="Disable"/> ▾ |     |
| <input type="checkbox"/> | 1/0/1  | 0                                         | 32768                                     | Passive                                | Disable                                | --- |
| <input type="checkbox"/> | 1/0/2  | 0                                         | 32768                                     | Passive                                | Disable                                | --- |
| <input type="checkbox"/> | 1/0/3  | 0                                         | 32768                                     | Passive                                | Disable                                | --- |
| <input type="checkbox"/> | 1/0/4  | 0                                         | 32768                                     | Passive                                | Disable                                | --- |
| <input type="checkbox"/> | 1/0/5  | 0                                         | 32768                                     | Passive                                | Disable                                | --- |
| <input type="checkbox"/> | 1/0/6  | 0                                         | 32768                                     | Passive                                | Disable                                | --- |
| <input type="checkbox"/> | 1/0/7  | 0                                         | 32768                                     | Passive                                | Disable                                | --- |
| <input type="checkbox"/> | 1/0/8  | 0                                         | 32768                                     | Passive                                | Disable                                | --- |
| <input type="checkbox"/> | 1/0/9  | 0                                         | 32768                                     | Passive                                | Disable                                | --- |
| <input type="checkbox"/> | 1/0/10 | 0                                         | 32768                                     | Passive                                | Disable                                | --- |
| <input type="checkbox"/> | 1/0/11 | 0                                         | 32768                                     | Passive                                | Disable                                | --- |
| <input type="checkbox"/> | 1/0/12 | 0                                         | 32768                                     | Passive                                | Disable                                | --- |
| <input type="checkbox"/> | 1/0/13 | 0                                         | 32768                                     | Passive                                | Disable                                | --- |
| <input type="checkbox"/> | 1/0/14 | 0                                         | 32768                                     | Passive                                | Disable                                | --- |
| <input type="checkbox"/> | 1/0/15 | 0                                         | 32768                                     | Passive                                | Disable                                | --- |

Follow these steps to configure LACP:

- 1) Specify the system priority for the switch and click **Apply**.

### System Priority

Specify the system priority for the switch. A smaller value means a higher priority.

To keep active ports consistent at both ends, you can set the priority of one device to be higher than that of the other device. The device with higher priority will determine its active ports, and the other device can select its active ports according to the selection result of the device with higher priority. If the two ends have the same system priority value, the end with a smaller MAC address has the higher priority.

- 2) Select member ports for the LAG and configure the related parameters. Click **Apply**.

### Admin Key

Specify the Admin Key which you can regard as the group number of the LAG. Note that the group number of other static LAGs cannot be set as an Admin Key.

The valid value of the Admin Key is determined by the maximum number of LAG supported by your switch. For example, if your switch supports up to 14 LAGs, the valid value is from 1 to 14.



|                            |                                                                                                                                                                                                                                                                                                                                                                                                                                                                                                                                             |
|----------------------------|---------------------------------------------------------------------------------------------------------------------------------------------------------------------------------------------------------------------------------------------------------------------------------------------------------------------------------------------------------------------------------------------------------------------------------------------------------------------------------------------------------------------------------------------|
| Port Priority<br>(0-65535) | Specify the Port Priority. A smaller value means a higher port priority.<br><br>The port with higher priority in an LAG will be selected as the active port to forward data. If two ports have the same priority value, the port with a smaller port number has the higher priority.                                                                                                                                                                                                                                                        |
| Mode                       | Select the LACP mode for the port.<br><br>In LACP, the switch uses LACPDU (Link Aggregation Control Protocol Data Unit) to negotiate the parameters with the peer end. In this way, the two ends select active ports and form the aggregation link. The LACP mode determines whether the port will take the initiative to send the LACPDU. There are two modes:<br><br><b>Passive:</b> The port will not send LACPDU before receiving the LACPDU from the peer end.<br><br><b>Active:</b> The port will take the initiative to send LACPDU. |
| Status                     | Enable the LACP function of the port. By default, it is disabled.                                                                                                                                                                                                                                                                                                                                                                                                                                                                           |

## 2.2 Using the CLI

### 2.2.1 Configuring Load-balancing Algorithm

Follow these steps to configure the load-balancing algorithm:

|        |                                                                                                                                                                                                                                                                                                                                                                                                                                                                                                                                                                                                                                                                                                                                                                                                                                                                                                                                  |
|--------|----------------------------------------------------------------------------------------------------------------------------------------------------------------------------------------------------------------------------------------------------------------------------------------------------------------------------------------------------------------------------------------------------------------------------------------------------------------------------------------------------------------------------------------------------------------------------------------------------------------------------------------------------------------------------------------------------------------------------------------------------------------------------------------------------------------------------------------------------------------------------------------------------------------------------------|
| Step 1 | <b>configure</b><br>Enter global configuration mode.                                                                                                                                                                                                                                                                                                                                                                                                                                                                                                                                                                                                                                                                                                                                                                                                                                                                             |
| Step 2 | <b>port-channel load-balance { src-mac   dst-mac   src-dst-mac   src-ip   dst-ip   src-dst-ip }</b><br>Select the Hash Algorithm. The switch will choose the ports to transfer the packets based on the Hash Algorithm. In this way, different data flows are forwarded on different physical links to implement load balancing.<br><br><b>src-mac:</b> The computation is based on the source MAC addresses of the packets.<br><b>dst-mac:</b> The computation is based on the destination MAC addresses of the packets.<br><b>src-dst-mac:</b> The computation is based on the source and destination MAC addresses of the packets.<br><b>src-ip:</b> The computation is based on the source IP addresses of the packets.<br><b>dst-ip:</b> The computation is based on the destination IP addresses of the packets.<br><b>src-dst-ip:</b> The computation is based on the source and destination IP addresses of the packets. |
| Step 3 | <b>show etherchannel load-balance</b><br>Verify the configuration of load-balancing algorithm.                                                                                                                                                                                                                                                                                                                                                                                                                                                                                                                                                                                                                                                                                                                                                                                                                                   |
| Step 4 | <b>end</b><br>Return to privileged EXEC mode.                                                                                                                                                                                                                                                                                                                                                                                                                                                                                                                                                                                                                                                                                                                                                                                                                                                                                    |
| Step 5 | <b>copy running-config startup-config</b><br>Save the settings in the configuration file.                                                                                                                                                                                                                                                                                                                                                                                                                                                                                                                                                                                                                                                                                                                                                                                                                                        |

The following example shows how to set the global load-balancing mode as src-dst-mac:

```
Switch#configure
```

```
Switch(config)#port-channel load-balance src-dst-mac
```

```
Switch(config)#show etherchannel load-balance
```

```
EtherChannel Load-Balancing Configuration: src-dst-mac
```

```
EtherChannel Load-Balancing Addresses Used Per-Protocol:
```

```
Non-IP: Source XOR Destination MAC address
```

```
IPv4: Source XOR Destination MAC address
```

```
IPv6: Source XOR Destination MAC address
```

```
Switch(config-if)#end
```

```
Switch#copy running-config startup-config
```

## 2.2.2 Configuring Static LAG or LACP

You can choose only one LAG mode for a port: Static LAG or LACP. And make sure both ends of a link use the same LAG mode.

### ■ Configuring Static LAG

Follow these steps to configure static LAG:

|        |                                                                                                                                                                                                                                                                                  |
|--------|----------------------------------------------------------------------------------------------------------------------------------------------------------------------------------------------------------------------------------------------------------------------------------|
| Step 1 | <b>configure</b><br>Enter global configuration mode.                                                                                                                                                                                                                             |
| Step 2 | <b>interface { fastEthernet <i>port</i>   range fastEthernet <i>port-list</i>   gigabitEthernet <i>port</i>   range gigabitEthernet <i>port-list</i>   ten-gigabitEthernet <i>port</i>   range ten-gigabitEthernet <i>port-list</i> }</b><br>Enter interface configuration mode. |
| Step 3 | <b>channel-group <i>num</i> mode { on   active   passive }</b><br>Add the port to a static LAG.<br><i>num</i> : The group number of the LAG.<br><b>mode</b> :LAG mode. Select <b>on</b> to add the port to a static LAG. <b>Active</b> and <b>passive</b> are two LACP modes.    |
| Step 4 | <b>show ether-channel <i>num</i> summary</b><br>Verify the configuration of the static LAG.<br><i>num</i> : The group number of the LAG.                                                                                                                                         |
| Step 5 | <b>end</b><br>Return to privileged EXEC mode.                                                                                                                                                                                                                                    |
| Step 6 | <b>copy running-config startup-config</b><br>Save the settings in the configuration file.                                                                                                                                                                                        |

The following example shows how to add ports 1/0/5-8 to LAG 2 and set the mode as static LAG:

**Switch#configure**

**Switch(config)#interface range ten-gigabitEthernet 1/0/5-8**

**Switch(config-if-range)#channel-group 2 mode on**

**Switch(config-if-range)#show etherchannel 2 summary**

Flags: D - down            P - bundled in port-channel    U - in use  
       I - stand-alone    H - hot-standby(LACP only)    s - suspended  
       R - layer3        S - layer2        f - failed to allocate aggregator  
       u - unsuitable for bundling    w - waiting to be aggregated    d - default port

| Group | Port-channel | Protocol | Ports                                       |
|-------|--------------|----------|---------------------------------------------|
| ----- | -----        | -----    | -----                                       |
| 2     | Po2(S)       | -        | Te1/0/5(D) Te1/0/6(D) Te1/0/7(D) Te1/0/8(D) |

**Switch(config-if-range)#end**

**Switch#copy running-config startup-config**

#### ■ Configuring LACP

Follow these steps to configure LACP:

|        |                                                                                                                                                                                                                                                                                                                                                                                                                                                                                                                                                                                                                                                                                                   |
|--------|---------------------------------------------------------------------------------------------------------------------------------------------------------------------------------------------------------------------------------------------------------------------------------------------------------------------------------------------------------------------------------------------------------------------------------------------------------------------------------------------------------------------------------------------------------------------------------------------------------------------------------------------------------------------------------------------------|
| Step 1 | <b>configure</b><br>Enter global configuration mode.                                                                                                                                                                                                                                                                                                                                                                                                                                                                                                                                                                                                                                              |
| Step 2 | <b>lacp system-priority <i>pri</i></b><br>Specify the system priority for the switch.<br><br>To keep active ports consistent at both ends, you can set the priority of one device to be higher than that of the other device. The device with higher priority will determine its active ports, and the other device can select its active ports according to the selection result of the device with higher priority. If the two ends have the same system priority value, the end with a smaller MAC address has the higher priority.<br><br><i>pri</i> : System priority. The valid values are from 0 to 65535, and the default value is 32768. A smaller value means a higher device priority. |
| Step 3 | <b>interface { fastEthernet <i>port</i>   range fastEthernet <i>port-list</i>   gigabitEthernet <i>port</i>   range gigabitEthernet <i>port-list</i>   ten-gigabitEthernet <i>port</i>   range ten-gigabitEthernet <i>port-list</i> }</b><br>Enter interface configuration mode.                                                                                                                                                                                                                                                                                                                                                                                                                  |

---

|        |                                                                                                                                                                                                                                                                                                                                                                                                                                                                                                                                                                                                                                                                                                                            |
|--------|----------------------------------------------------------------------------------------------------------------------------------------------------------------------------------------------------------------------------------------------------------------------------------------------------------------------------------------------------------------------------------------------------------------------------------------------------------------------------------------------------------------------------------------------------------------------------------------------------------------------------------------------------------------------------------------------------------------------------|
| Step 4 | <b>channel-group <i>num</i> mode { on   active   passive }</b><br>Add the port to an LAG and set the mode as LACP.<br><i>num</i> : The group number of the LAG.<br><b>mode</b> : LAG mode. Here you need to select LACP mode: active or passive.<br>In LACP, the switch uses LACPDU (Link Aggregation Control Protocol Data Unit) to negotiate the parameters with the peer end. In this way, the two ends select active ports and form the aggregation link. The LACP mode determines whether the port will take the initiative to send the LACPDU.<br><i>passive</i> : The port will not send LACPDU before receiving the LACPDU from the peer end.<br><i>active</i> : The port will take the initiative to send LACPDU. |
| Step 5 | <b>lacp port-priority <i>pri</i></b><br>Specify the Port Priority. The port with higher priority in an LAG will be selected as the active port. If two ports have the same priority value, the port with a smaller port number has the higher priority.<br><i>pri</i> : Port priority. The valid values are from 0 to 65535, and the default value is 32768. A smaller value means a higher port priority.                                                                                                                                                                                                                                                                                                                 |
| Step 6 | <b>show lacp sys-id</b><br>Verify the global system priority.                                                                                                                                                                                                                                                                                                                                                                                                                                                                                                                                                                                                                                                              |
| Step 7 | <b>show lacp internal</b><br>Verify the LACP configuration of the local switch.                                                                                                                                                                                                                                                                                                                                                                                                                                                                                                                                                                                                                                            |
| Step 8 | <b>end</b><br>Return to privileged EXEC mode.                                                                                                                                                                                                                                                                                                                                                                                                                                                                                                                                                                                                                                                                              |
| Step 9 | <b>copy running-config startup-config</b><br>Save the settings in the configuration file.                                                                                                                                                                                                                                                                                                                                                                                                                                                                                                                                                                                                                                  |

---

The following example shows how to specify the system priority of the switch as 2:

```
Switch#configure
Switch(config)#lacp system-priority 2
Switch(config)#show lacp sys-id
2, 000a.eb13.2397
Switch(config)#end
Switch#copy running-config startup-config
```

The following example shows how to add ports 1/0/1-4 to LAG 6, set the mode as LACP, and select the LACPDU sending mode as active:

```
Switch#configure
Switch(config)#interface range ten-gigabitEthernet 1/0/1-4
Switch(config-if-range)#channel-group 6 mode active
```

**Switch(config-if-range)#show lacp internal**

Flags: S - Device is requesting Slow LACPDUs

F - Device is requesting Fast LACPDUs

A - Device is in active mode

P - Device is in passive mode

Channel group 6

| Port    | Flags | State | LACP Port Priority | Admin Key | Oper Key | Port Number | Port State |
|---------|-------|-------|--------------------|-----------|----------|-------------|------------|
| Te1/0/1 | SA    | Up    | 32768              | 0x6       | 0x4b1    | 0x1         | 0x7d       |
| Te1/0/2 | SA    | Down  | 32768              | 0x6       | 0        | 0x2         | 0x45       |
| Te1/0/3 | SA    | Down  | 32768              | 0x6       | 0        | 0x3         | 0x45       |
| Te1/0/4 | SA    | Down  | 32768              | 0x6       | 0        | 0x4         | 0x45       |

**Switch(config-if-range)#end****Switch#copy running-config startup-config**

# 3 Configuration Example

## 3.1 Network Requirements

As shown below, users and servers are connected to Switch A and Switch B, and heavy traffic is transmitted between the two switches. To achieve high speed and reliability of data transmission, users need to improve the bandwidth and redundancy of the link between the two switches.

## 3.2 Configuration Scheme

LAG function can bundle multiple physical ports into one logical interface to increase bandwidth and improve reliability. In this case, we take LACP as an example.

As shown below, you can bundle up to eight physical ports into one logical aggregation group to transmit data on the two switches, and respectively connect the ports of the groups. In addition, another two redundant links can be set as the backup. To avoid traffic bottleneck between the servers and Switch B, you also need to configure LAG on them to increase link bandwidth. Here we mainly introduce the LAG configuration between the two switches.

Figure 3-1 Network Topology

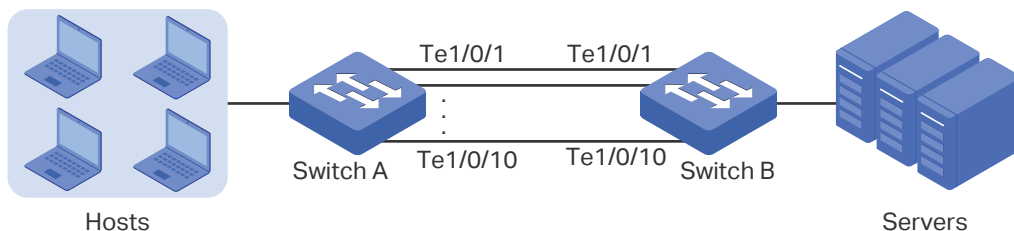

The overview of the configuration is as follows:

- 1) Considering there are multiple devices on each end, configure the load-balancing algorithm as 'SRC MAC+DST MAC'.
- 2) Specify the system priority for the switches. Here we choose Switch A as the dominate device and specify a higher system priority for it.
- 3) Add ports 1/0/1-10 to the LAG and set the mode as LACP.
- 4) Specify a high port priority for ports 1/0/1-8 to set them as the active ports, and a low port priority for ports 1/0/9-10 to set them as the backup ports. When any of the active ports is down, the backup ports will be enabled to transmit data.

Demonstrated with T1700X-16TS, the following sections provide configuration procedure in two ways: using the GUI and using the CLI.

### 3.3 Using the GUI

The configurations of Switch A and Switch B are similar. The following introductions take Switch A as an example.

- 1) Choose the menu **Switching > LAG > LAG Table** to load the following page. Select the hash algorithm as 'SRC MAC+DST MAC'.

Figure 3-2 Global Configuration

Global Config

Hash Algorithm: SRC MAC+DST MAC Apply

| Select                 | Group Number | Description | Member | Operation |
|------------------------|--------------|-------------|--------|-----------|
| No entry in the table. |              |             |        |           |

All Delete Help

- 2) Choose the menu **Switching > LAG > LACP Config** to load the following page. In the **Global Config** section, specify the system priority of Switch A as **0** and Click **Apply**. Remember to ensure that the system priority value of Switch B is bigger than 0.

Figure 3-3 System Priority Configuration

Global Config

System Priority: 0 (0-65535) Apply

- 3) In the **LACP Config** section, select ports 1/0/1-10, and respectively set the admin key, port priority, mode and status for each port as follows. Click **Apply**.

Figure 3-4 LACP Configuration

LACP Config

UNIT: 1

| Select                   | Port   | Admin Key            | Port Priority(0-65535) | Mode                 | Status               | LAG |
|--------------------------|--------|----------------------|------------------------|----------------------|----------------------|-----|
| <input type="checkbox"/> |        | <input type="text"/> | <input type="text"/>   | <input type="text"/> | <input type="text"/> |     |
| <input type="checkbox"/> | 1/0/1  | 1                    | 0                      | Active               | Enable               | --- |
| <input type="checkbox"/> | 1/0/2  | 1                    | 0                      | Active               | Enable               | --- |
| <input type="checkbox"/> | 1/0/3  | 1                    | 0                      | Active               | Enable               | --- |
| <input type="checkbox"/> | 1/0/4  | 1                    | 0                      | Active               | Enable               | --- |
| <input type="checkbox"/> | 1/0/5  | 1                    | 0                      | Active               | Enable               | --- |
| <input type="checkbox"/> | 1/0/6  | 1                    | 0                      | Active               | Enable               | --- |
| <input type="checkbox"/> | 1/0/7  | 1                    | 0                      | Active               | Enable               | --- |
| <input type="checkbox"/> | 1/0/8  | 1                    | 0                      | Active               | Enable               | --- |
| <input type="checkbox"/> | 1/0/9  | 1                    | 1                      | Active               | Enable               | --- |
| <input type="checkbox"/> | 1/0/10 | 1                    | 2                      | Active               | Enable               | --- |
| <input type="checkbox"/> | 1/0/11 | 0                    | 32768                  | Passive              | Disable              | --- |
| <input type="checkbox"/> | 1/0/12 | 0                    | 32768                  | Passive              | Disable              | --- |
| <input type="checkbox"/> | 1/0/13 | 0                    | 32768                  | Passive              | Disable              | --- |
| <input type="checkbox"/> | 1/0/14 | 0                    | 32768                  | Passive              | Disable              | --- |
| <input type="checkbox"/> | 1/0/15 | 0                    | 32768                  | Passive              | Disable              | --- |

All Apply Help

- 4) Click **Save Config** to save the settings.

### 3.4 Using the CLI

The configurations of Switch A and Switch B are similar. The following introductions take Switch A as an example.

- 1) Configure the load-balancing algorithm as "src-dst-mac".

```
Switch#configure
```

```
Switch(config)#port-channel load-balance src-dst-mac
```

- 2) Specify the system priority of Switch A as 0. Remember to ensure that the system priority value of Switch B is bigger than 0.

```
Switch(config)#lacp system-priority 0
```

- 3) Add ports 1/0/1-8 to LAG 1 and set the mode as LACP. Then specify the port priority as 0 to make them active.

```
Switch(config)#interface range ten-gigabitEthernet 1/0/1-8
```

```
Switch(config-if-range)#channel-group 1 mode active
```

```
Switch(config-if-range)#lacp port-priority 0
```

```
Switch(config-if-range)#exit
```

- 4) Add port 1/0/9 to LAG 1 and set the mode as LACP. Then specify the port priority as 1 to set it as a backup port. When any of the active ports is down, this port will be preferentially selected to work as an active port.

```
Switch(config)#interface ten-gigabitEthernet 1/0/9
```

```
Switch(config-if)#channel-group 1 mode active
```

```
Switch(config-if)#lacp port-priority 1
```

```
Switch(config-if)#exit
```

- 5) Add port 1/0/10 to LAG 1 and set the mode as LACP. Then specify the port priority as 2 to set it as a backup port. The priority of this port is lower than port 1/0/9.

```
Switch(config)#interface ten-gigabitEthernet 1/0/10
```

```
Switch(config-if)#channel-group 1 mode active
```

```
Switch(config-if)#lacp port-priority 2
```

```
Switch(config-if)#end
```

```
Switch#copy running-config startup-config
```

#### Verify the Configuration

Verify the system priority:



```
Switch#show lacp sys-id
0, 000a.eb13.2397
```

Verify the LACP configuration:

```
Switch#show lacp internal
```

Flags: S - Device is requesting Slow LACPDUs

F - Device is requesting Fast LACPDUs

A - Device is in active mode

P - Device is in passive mode

Channel group 1

| Port     | Flags | State | LACP Port Priority | Admin Key | Oper Key | Port Number | Port State |
|----------|-------|-------|--------------------|-----------|----------|-------------|------------|
| Te1/0/1  | SA    | Down  | 0                  | 0x1       | 0        | 0x1         | 0x45       |
| Te1/0/2  | SA    | Down  | 0                  | 0x1       | 0        | 0x2         | 0x45       |
| Te1/0/3  | SA    | Down  | 0                  | 0x1       | 0        | 0x3         | 0x45       |
| Te1/0/4  | SA    | Down  | 0                  | 0x1       | 0        | 0x4         | 0x45       |
| Te1/0/5  | SA    | Down  | 0                  | 0x1       | 0        | 0x5         | 0x45       |
| Te1/0/6  | SA    | Down  | 0                  | 0x1       | 0        | 0x6         | 0x45       |
| Te1/0/7  | SA    | Down  | 0                  | 0x1       | 0        | 0x7         | 0x45       |
| Te1/0/8  | SA    | Down  | 0                  | 0x1       | 0        | 0x8         | 0x45       |
| Te1/0/9  | SA    | Down  | 1                  | 0x1       | 0        | 0x9         | 0x45       |
| Te1/0/10 | SA    | Down  | 2                  | 0x1       | 0        | 0xa         | 0x45       |

# 4 Appendix: Default Parameters

Default settings of Switching are listed in the following tables.

Table 4-1 Default Settings of LAG

| Parameter       | Default Setting |
|-----------------|-----------------|
| LAG Table       |                 |
| Hash Algorithm  | SRC MAC+DST MAC |
| LACP Config     |                 |
| System Priority | 32768           |
| Admin Key       | 0               |
| Port Priority   | 32768           |
| Mode            | Passive         |
| Status          | Disable         |

# Part 5

## Monitoring Traffic

### CHAPTERS

1. Traffic Monitor
2. Appendix: Default Parameters

# 1 Traffic Monitor

With Traffic Monitor function, you can monitor the traffic on the switch, including:

- Traffic Summary
- Traffic Statistics in Detail

## 1.1 Using the GUI

### 1.1.1 Viewing the Traffic Summary

Choose the menu **Switching > Traffic Monitor > Traffic Summary** to load the following page.

Figure 1-1 Traffic Summary

| Auto Refresh                                                                                                                                       |        |                                                                       |             |                |                                      |                            |
|----------------------------------------------------------------------------------------------------------------------------------------------------|--------|-----------------------------------------------------------------------|-------------|----------------|--------------------------------------|----------------------------|
| Auto Refresh:                                                                                                                                      |        | <input type="radio"/> Enable <input checked="" type="radio"/> Disable |             |                |                                      |                            |
| Refresh Rate:                                                                                                                                      |        | <input type="text" value="10"/>                                       | sec (3-300) |                | <input type="button" value="Apply"/> |                            |
| Traffic Summary                                                                                                                                    |        |                                                                       |             |                |                                      |                            |
| UNIT: <input type="text" value="1"/>                                                                                                               |        | LAGS                                                                  |             |                |                                      |                            |
| Select                                                                                                                                             | Port   | Packets Rx                                                            | Packets Tx  | Octets Rx      | Octets Tx                            | Statistics                 |
| <input type="checkbox"/>                                                                                                                           | 1/0/1  | 0                                                                     | 0           | 0              | 0                                    | <a href="#">Statistics</a> |
| <input type="checkbox"/>                                                                                                                           | 1/0/2  | 0                                                                     | 0           | 0              | 0                                    | <a href="#">Statistics</a> |
| <input type="checkbox"/>                                                                                                                           | 1/0/3  | 0                                                                     | 0           | 0              | 0                                    | <a href="#">Statistics</a> |
| <input type="checkbox"/>                                                                                                                           | 1/0/4  | 0                                                                     | 0           | 0              | 0                                    | <a href="#">Statistics</a> |
| <input type="checkbox"/>                                                                                                                           | 1/0/5  | 0                                                                     | 0           | 0              | 0                                    | <a href="#">Statistics</a> |
| <input type="checkbox"/>                                                                                                                           | 1/0/6  | 0                                                                     | 0           | 0              | 0                                    | <a href="#">Statistics</a> |
| <input type="checkbox"/>                                                                                                                           | 1/0/7  | 0                                                                     | 0           | 0              | 0                                    | <a href="#">Statistics</a> |
| <input type="checkbox"/>                                                                                                                           | 1/0/8  | 0                                                                     | 0           | 0              | 0                                    | <a href="#">Statistics</a> |
| <input type="checkbox"/>                                                                                                                           | 1/0/9  | 0                                                                     | 0           | 0              | 0                                    | <a href="#">Statistics</a> |
| <input type="checkbox"/>                                                                                                                           | 1/0/10 | 630,639                                                               | 408,726,166 | 190,817,263    | 83,558,106,024                       | <a href="#">Statistics</a> |
| <input type="checkbox"/>                                                                                                                           | 1/0/11 | 0                                                                     | 0           | 0              | 0                                    | <a href="#">Statistics</a> |
| <input type="checkbox"/>                                                                                                                           | 1/0/12 | 0                                                                     | 0           | 0              | 0                                    | <a href="#">Statistics</a> |
| <input type="checkbox"/>                                                                                                                           | 1/0/13 | 0                                                                     | 0           | 0              | 0                                    | <a href="#">Statistics</a> |
| <input type="checkbox"/>                                                                                                                           | 1/0/14 | 813,138,408                                                           | 487,783,481 | 74,461,108,930 | 81,114,526,497                       | <a href="#">Statistics</a> |
| <input type="checkbox"/>                                                                                                                           | 1/0/15 | 0                                                                     | 0           | 0              | 0                                    | <a href="#">Statistics</a> |
| <input type="button" value="All"/> <input type="button" value="Refresh"/> <input type="button" value="Clear"/> <input type="button" value="Help"/> |        |                                                                       |             |                |                                      |                            |

Follow these steps to view the traffic summary of each port:

- 1) To get the real-time traffic summary, enable auto refresh in the **Auto Refresh** section, or click **Refresh** at the bottom of the page.

**Auto Refresh:** With this option enabled, the switch refreshes the web timely.

**Refresh Rate:** Specify the refresh interval in seconds.

- 2) In the **Traffic Summary** section, click **1** to show the information of the physical ports, and click **LAGS** to show the information of the LAGs.

|                    |                                                                                           |
|--------------------|-------------------------------------------------------------------------------------------|
| <b>Packets Rx:</b> | Displays the number of packets received on the port. Error packets are not counted in.    |
| <b>Packets Tx:</b> | Displays the number of packets transmitted on the port. Error packets are not counted in. |
| <b>Octets Rx:</b>  | Displays the number of octets received on the port. Error octets are counted in.          |
| <b>Octets Tx:</b>  | Displays the number of octets transmitted on the port. Error octets are counted in.       |
| <b>Statistics:</b> | Click this button to view the detailed traffic statistics of the port.                    |

## 1.1.2 Viewing the Traffic Statistics in Detail

Choose the menu **Switching > Traffic Monitor > Traffic Statistics** to load the following page.

Figure 1-2 Traffic Statistics

**Auto Refresh**

Auto Refresh:  Enable  Disable

Refresh Rate:  sec (3-300) Apply

---

**Port Select**

Port  Select

UNIT:  LAGS

|                          |                          |                          |                          |                          |                          |                          |                          |
|--------------------------|--------------------------|--------------------------|--------------------------|--------------------------|--------------------------|--------------------------|--------------------------|
| <input type="checkbox"/> | <input type="checkbox"/> | <input type="checkbox"/> | <input type="checkbox"/> | <input type="checkbox"/> | <input type="checkbox"/> | <input type="checkbox"/> | <input type="checkbox"/> |
| <input type="checkbox"/> | <input type="checkbox"/> | <input type="checkbox"/> | <input type="checkbox"/> | <input type="checkbox"/> | <input type="checkbox"/> | <input type="checkbox"/> | <input type="checkbox"/> |

Unselected Port(s)    Selected Port(s)    Not Available for Selection

| Statistics           |          |  |            |   |
|----------------------|----------|--|------------|---|
|                      | Received |  | Sent       |   |
| Broadcast            | 0        |  | Broadcast  | 0 |
| Multicast            | 0        |  | Multicast  | 0 |
| Unicast              | 0        |  | Unicast    | 0 |
| Jumbo                | 0        |  | Jumbo      | 0 |
| Alignment Errors     | 0        |  | Collisions | 0 |
| UndersizePkts        | 0        |  |            |   |
| Pkts64Octets         | 0        |  |            |   |
| Pkts65to127Octets    | 0        |  |            |   |
| Pkts128to255Octets   | 0        |  |            |   |
| Pkts256to511Octets   | 0        |  |            |   |
| Pkts512to1023Octets  | 0        |  |            |   |
| Pkts1024to1518Octets | 0        |  |            |   |

Refresh   Help

Follow these steps to view the traffic statistics in detail:

- 1) To get the real-time traffic statistics, enable auto refresh in the **Auto Refresh** section, or click **Refresh** at the bottom of the page.

---

**Auto Refresh:** With this option enabled, the switch refreshes the web timely.

---

**Refresh Rate:** Specify the refresh interval in seconds.

---

- 2) In **Port Select**, select a port or LAG, and click **Select**.
  - 3) In the **Statistics** section, view the detailed information of the selected port or LAG.
- 

**Received:** Displays the detailed information of received packets.

**Broadcast:** Displays the number of valid broadcast packets received on the port. Error frames are not counted in.

**Multicast:** Displays the number of valid multicast packets received on the port. Error frames are not counted in.

**Unicast:** Displays the number of valid unicast packets received on the port. Error frames are not counted in.

**Jumbo:** Displays the number of valid jumbo packets received on the port. Error frames are not counted in.

**Alignment Errors:** Displays the number of the received packets that have a Frame Check Sequence (FCS) with a non-integral octet (Alignment Error). The size of the packet is between 64 bytes and 1518 bytes.

**UndersizePkts:** Displays the number of the received packets (excluding error packets) that are less than 64 bytes long.

**Pkts64Octets:** Displays the number of the received packets (including error packets) that are 64 bytes long.

**Pkts65to127Octets:** Displays the number of the received packets (including error packets) that are between 65 and 127 bytes long.

**Pkts128to255Octets:** Displays the number of the received packets (including error packets) that are between 128 and 255 bytes long.

**Pkts256to511Octets:** Displays the number of the received packets (including error packets) that are between 256 and 511 bytes long.

**Pkts512to1023Octets:** Displays the number of the received packets (including error packets) that are between 512 and 1023 bytes long.

**PktsOver1023Octets:** Displays the number of the received packets (including error packets) that are over 1023 bytes.

---

**Sent:**

Displays the detailed information of sent packets.

**Broadcast:** Displays the number of valid broadcast packets transmitted on the port. Error frames are not counted in.

**Multicast:** Displays the number of valid multicast packets transmitted on the port. Error frames are not counted in.

**Unicast:** Displays the number of valid unicast packets transmitted on the port. Error frames are not counted in.

**Jumbo:** Displays the number of valid jumbo packets transmitted on the port. Error frames are not counted in.

**Collisions:** Displays the number of collisions experienced by a half-duplex port during packet transmissions.

---

## 1.2 Using the CLI

On privileged EXEC mode or any other configuration mode, you can use the following command to view the traffic information of each port or LAG:

---

```
show interface counters [ fastEthernet port | gigabitEthernet port | ten-gigabitEthernet port | port-channel port-channel-id ]
```

*port*: The port number.

*port-channel-id* : The group number of the LAG.

If you enter no port number or group number, the information of all ports and LAGs will be displayed.

The displaying information includes:

**Broadcast:** Displays the number of valid broadcast packets received and transmitted on the port. Error frames are not counted in.

**Multicast:** Displays the number of valid multicast packets received and transmitted on the port. Error frames are not counted in.

**Unicast:** Displays the number of valid unicast packets received and transmitted on the port. Error frames are not counted in.

**Jumbo:** Displays the number of valid jumbo packets received and transmitted on the port. Error frames are not counted in.

**Alignment Errors:** Displays the number of the received packets that have a Frame Check Sequence (FCS) with a non-integral octet (Alignment Error). The size of the packet is between 64 bytes and 1518 bytes.

**UndersizePkts:** Displays the number of the received packets (excluding error packets) that are less than 64 bytes long.

**Pkts64Octets:** Displays the number of the received packets (including error packets) that are 64 bytes long.

**Pkts65to127Octets:** Displays the number of the received packets (including error packets) that are between 65 and 127 bytes long.

**Pkts128to255Octets:** Displays the number of the received packets (including error packets) that are between 128 and 255 bytes long.

**Pkts256to511Octets:** Displays the number of the received packets (including error packets) that are between 256 and 511 bytes long.

**Pkts512to1023Octets:** Displays the number of the received packets (including error packets) that are between 512 and 1023 bytes long.

**PktsOver1023Octets:** Displays the number of the received packets (including error packets) that are over 1023 bytes.

**Collisions:** Displays the number of collisions experienced by a port during packet transmissions.

---



# 2 Appendix: Default Parameters

Table 2-1 Traffic Statistics Monitoring

| Parameter          | Default Setting |
|--------------------|-----------------|
| Traffic Summary    |                 |
| Auto Refresh       | Disable         |
| Refresh Rate       | 10 seconds      |
| Traffic Statistics |                 |
| Auto Refresh       | Disable         |
| Refresh Rate       | 10 seconds      |

# Part 6

## Managing MAC Address Table

### CHAPTERS

1. MAC Address Table
2. Address Configurations
3. Security Configurations
4. Example for Security Configurations
5. Appendix: Default Parameters

# 1 MAC Address Table

## 1.1 Overview

The MAC address table contains address information that the switch uses to forward traffic between ports. As shown below, the table lists map entries of MAC addresses, VLAN IDs and ports. These entries can be manually input or automatically learned by the switch. Based on the MAC-address-to-port mapping in the table, the switch forwards the packet only to the associated port.

Table 1-1 The MAC Address Table

| MAC Address       | VLAN ID | Port | Type          | Aging Status |
|-------------------|---------|------|---------------|--------------|
| 00:00:00:00:00:01 | 1       | 1    | Dynamic       | Aging        |
| 00:00:00:00:00:02 | 1       | 2    | Config static | no-Aging     |
| .....             |         |      |               |              |

## 1.2 Supported Features

The address table of the switch contains dynamic addresses, static addresses and filtering addresses. You can add or remove these entries to your needs. Furthermore, you can configure notification traps and limit the number of MAC addresses in a VLAN for traffic safety.

### Address Configurations

- Dynamic address

Dynamic addresses are source addresses learned by the switch automatically. Then the switch regularly ages out those that are not in use. That is, the switch removes the MAC address entries related to a network device if no packet is received from the device within the aging time. And you can configure the aging time when needed.

- Static address

Static addresses are configured manually and do not age. For some relatively fixed connection, for example, frequently visited server, you can manually set the MAC address of the server as a static entry to enhance the forwarding efficiency of the switch.

- Filtering address

Filtering addresses are manually added to configure the switch to automatically drop the packets with specific source or destination MAC addresses.

## Security Configurations

- **Configuring MAC Notification Traps**

You can configure traps and SNMP (Simple Network Management Protocol) to monitor and receive notifications of the usage of the MAC address table and the MAC address change activity. For example, you can configure the switch to send you notifications when new users access the network.

- **Limiting the Number of MAC Addresses in VLANs**

You can configure VLAN Security to limit the number of MAC addresses that can be learned in specified VLANs. The switch will not learn addresses when the number of learned addresses has reached the limit, preventing the address table from being used up by broadcast packets of MAC address attacks.

# 2 Address Configurations

With MAC address table, you can:

- Add static MAC address entries
- Change the address aging time
- Add filtering address entries
- View address table entries

## 2.1 Using the GUI

### 2.1.1 Adding Static MAC Address Entries

You can add static MAC address entries by manually specifying the desired MAC address or binding dynamic MAC address entries.

- [Adding MAC Addresses Manually](#)

Choose the menu **Switching > MAC Address > Static Address** to load the following page.

Figure 2-1 Adding MAC Addresses Manually

**Create Static Address**

MAC Address:  (Format: 00-00-00-00-00-01)

VLAN ID:  (1-4094) Create

Port:

UNIT: 

|   |   |   |   |    |    |    |    |
|---|---|---|---|----|----|----|----|
| 2 | 4 | 6 | 8 | 10 | 12 | 14 | 16 |
| 1 | 3 | 5 | 7 | 9  | 11 | 13 | 15 |

Unselected Port(s)
 Selected Port(s)
 Not Available for Selection

**Search Option**

Search Option:  Search

**Static Address Table**

UNIT:

| Select                   | MAC Address | VLAN ID | Port                 | Type | Aging Status |
|--------------------------|-------------|---------|----------------------|------|--------------|
| <input type="checkbox"/> |             |         | <input type="text"/> |      |              |

**No entry in the table.**

All
Apply
Delete
Help

Follow these steps to add a static MAC address entry:

- 1) Enter the MAC address, VLAN ID and select a port to bind them together.

|                |                                                                                                                                                                                                                                                                                |
|----------------|--------------------------------------------------------------------------------------------------------------------------------------------------------------------------------------------------------------------------------------------------------------------------------|
| <b>VLAN ID</b> | Specify an existing VLAN in which packets with the specific MAC address are received.                                                                                                                                                                                          |
| <b>Port</b>    | Specify a port to which packets with the specific MAC address are forwarded. The port must belong to the specified VLAN.                                                                                                                                                       |
|                | After you have added the static MAC address, if the corresponding port number of the MAC address is not correct, or the connected port (or the device) has been changed, the switch cannot forward the packets correctly. Please reset the static address entry appropriately. |

- 2) Click **Create**.

- **Binding Dynamic Address Entries**

Choose the menu **Switching > MAC Address > Dynamic Address** to load the following page.

Figure 2-2 Binding Dynamic MAC Address Entries

**Aging Config**

Auto Aging:  Enable  Disable

Aging Time:  secs (10-630, default: 300)

---

**Search Option**

Search Option:

---

**Dynamic Address Table**

UNIT:

| Select                   | MAC Address       | VLAN ID | Port  | Type    | Aging Status |
|--------------------------|-------------------|---------|-------|---------|--------------|
| <input type="checkbox"/> | 00-0A-EB-13-12-3E | 1       | 1/0/3 | Dynamic | Aging        |
| <input type="checkbox"/> | 00-0A-EB-13-12-47 | 1       | 1/0/3 | Dynamic | Aging        |
| <input type="checkbox"/> | 00-0A-EB-13-23-7B | 1       | 1/0/3 | Dynamic | Aging        |
| <input type="checkbox"/> | 00-0A-EB-13-23-84 | 1       | 1/0/3 | Dynamic | Aging        |
| <input type="checkbox"/> | 00-11-22-33-44-AC | 1       | 1/0/3 | Dynamic | Aging        |
| <input type="checkbox"/> | 00-19-66-35-E1-B0 | 1       | 1/0/3 | Dynamic | Aging        |
| <input type="checkbox"/> | 00-EA-11-04-01-31 | 1       | 1/0/3 | Dynamic | Aging        |

Follow these steps to bind dynamic MAC address entries:

- 1) Select your desired MAC address entries. You can select the entries from the **Dynamic Address Table**, or quickly search them out by MAC address/ VLAN ID/ port in the **Search Option** section.
- 2) Click **Bind**, and then the selected entries will not age.

 **Note:**

- In the same VLAN, once an address is configured as a static address, it cannot be set as a filtering address, and vice versa.
- Multicast or broadcast addresses cannot be set as static addresses.
- Ports in LAGs (Link Aggregation Group) are not supported for static address configuration.

## 2.1.2 Modifying the Aging Time of Dynamic Address Entries

Choose the menu **Switching > MAC Address > Dynamic Address** to load the following page.

Figure 2-3 Modifying the Aging Time of Dynamic Address Entries

**Aging Config**

Auto Aging:  Enable  Disable

Aging Time:  secs (10-630, default: 300) Apply

---

**Search Option**

Search Option:  Search

---

**Dynamic Address Table**

UNIT:

| Select                   | MAC Address       | VLAN ID | Port  | Type    | Aging Status |
|--------------------------|-------------------|---------|-------|---------|--------------|
| <input type="checkbox"/> | 00-0A-EB-13-12-3E | 1       | 1/0/3 | Dynamic | Aging        |
| <input type="checkbox"/> | 00-0A-EB-13-12-47 | 1       | 1/0/3 | Dynamic | Aging        |
| <input type="checkbox"/> | 00-0A-EB-13-23-7B | 1       | 1/0/3 | Dynamic | Aging        |
| <input type="checkbox"/> | 00-0A-EB-13-23-84 | 1       | 1/0/3 | Dynamic | Aging        |
| <input type="checkbox"/> | 00-11-22-33-44-AC | 1       | 1/0/3 | Dynamic | Aging        |
| <input type="checkbox"/> | 00-19-66-35-E1-B0 | 1       | 1/0/3 | Dynamic | Aging        |
| <input type="checkbox"/> | 00-EA-11-04-01-31 | 1       | 1/0/3 | Dynamic | Aging        |

All
Delete
Bind
Help

Follow these steps to modify the aging time of dynamic address entries:

- 1) In the **Aging Config** section, enable Auto Aging, and enter your desired length of time.

|                   |                                                                                                                                                                                                                                             |
|-------------------|---------------------------------------------------------------------------------------------------------------------------------------------------------------------------------------------------------------------------------------------|
| <b>Auto Aging</b> | Enable Auto Aging, then the switch automatically updates the dynamic address table with the aging mechanism. By default, it is enabled.                                                                                                     |
| <b>Aging Time</b> | Set the length of time that a dynamic entry remains in the MAC address table after the entry is used or updated. The valid values are from 10 to 630 seconds, and the default value is 300.                                                 |
|                   | A short aging time is applicable to networks where network topology changes frequently, and a long aging time is applicable to stable networks. We recommend that you keep the default value if you are unsure about settings in your case. |

- 2) Click **Apply**.



## 2.1.3 Adding MAC Filtering Address Entries

Choose the menu **Switching > MAC Address > Filtering Address** to load the following page.

Figure 2-4 Adding MAC Filtering Address Entries

**Create Filtering Address**

MAC Address:  (Format: 00-00-00-00-00-01)

VLAN ID:  (1-4094)

---

**Search Option**

Search Option:

---

**Filtering Address Table**

| Select                 | MAC Address | VLAN ID | Port | Type | Aging Status |
|------------------------|-------------|---------|------|------|--------------|
| No entry in the table. |             |         |      |      |              |

Follow these steps to add MAC filtering address entries:

- 1) In the **Create Filtering Address** section, enter the MAC Address and VLAN ID.

|                    |                                                                                                                                            |
|--------------------|--------------------------------------------------------------------------------------------------------------------------------------------|
| <b>MAC Address</b> | Specify a MAC address to configure the switch to drop packets which include this MAC address as the source address or destination address. |
| <b>VLAN ID</b>     | Specify an existing VLAN in which packets with the specific MAC address are dropped.                                                       |

- 2) Click **Create**.

### Note:

- In the same VLAN, once an address is configured as a filtering address, it cannot be set as a static address, and vice versa.
- Multicast or broadcast addresses cannot be set as filtering addresses .

## 2.1.4 Viewing Address Table Entries

You can view entries in MAC address table to check your former operations and address information.

Choose the menu **Switching > MAC Address > Address Table** to load the following page.

Figure 2-5 Viewing Address Table Entries

**Search Option**

MAC Address:  (Format: 00-00-00-00-00-01)  
 VLAN ID:  (1-4094) Search  
 Type:       All    Static    Dynamic    Filter Help

Port:

UNIT:  LAGS

|   |   |   |   |    |    |    |    |
|---|---|---|---|----|----|----|----|
| 2 | 4 | 6 | 8 | 10 | 12 | 14 | 16 |
| 1 | 3 | 5 | 7 | 9  | 11 | 13 | 15 |

Unselected Port(s)

Selected Port(s)

Not Available for Selection

**Address Table**  
 UNIT: 

| MAC Address       | VLAN ID | Port  | Type    | Aging Status |
|-------------------|---------|-------|---------|--------------|
| 00-0A-EB-13-12-3E | 1       | 1/0/3 | Dynamic | Aging        |
| 00-0A-EB-13-12-47 | 1       | 1/0/3 | Dynamic | Aging        |
| 00-0A-EB-13-23-7B | 1       | 1/0/3 | Dynamic | Aging        |
| 00-0A-EB-13-23-84 | 1       | 1/0/3 | Dynamic | Aging        |
| 00-11-22-33-44-AC | 1       | 1/0/3 | Dynamic | Aging        |
| 00-19-66-35-E1-B0 | 1       | 1/0/3 | Dynamic | Aging        |
| 00-EA-11-04-01-31 | 1       | 1/0/3 | Dynamic | Aging        |

## 2.2 Using the CLI

### 2.2.1 Adding Static MAC Address Entries

Follow these steps to add static MAC address entries:

- 
- Step 1      **configure**  
                  Enter global configuration mode.
-

Step 2 **mac address-table static** *mac-addr* **vid** *vid* **interface** { *gigabitEthernet port* | **ten-gigabitEthernet** *port* }

Bind the MAC address, VLAN and port together to add a static address to the VLAN.

*mac-addr*: Enter the MAC address and packets with this destination address received in the specified VLAN are forwarded to the specified port. The format is xx:xx:xx:xx:xx:xx, for example, 00:00:00:00:00:01.

*vid*: Specify an existing VLAN in which packets with the specific MAC address are received.

*port*: Specify a port to which packets with the specific MAC address are forwarded. The port must belong to the specified VLAN.

Step 3 **end**

Return to privileged EXEC mode.

Step 4 **copy running-config startup-config**

Save the settings in the configuration file.

#### Note:

- In the same VLAN, once an address is configured as a static address, it cannot be set as a filtering address, and vice versa.
- Multicast or broadcast addresses cannot be set as static addresses.
- Ports in LAGs (Link Aggregation Group) are not supported for static address configuration.

The following example shows how to add a static MAC address entry with MAC address 00:02:58:4f:6c:23, VLAN 10 and port 1. When a packet is received in VLAN 10 with this address as its destination, the packet will be forwarded only to port 1.

#### Switch#configure

```
Switch(config)# mac address-table static 00:02:58:4f:6c:23 vid 10 interface
ten-gigabitEthernet 1/0/1
```

```
Switch(config)#show mac address-table static
```

```
MAC Address Table
```

```
-----
MAC          VLAN   Port          Type          Aging
-----
00:02:58:4f:6c:23  10    Te1/0/1      config static no-aging
```

```
Total MAC Addresses for this criterion: 1
```

```
Switch(config)#end
```

```
Switch#copy running-config startup-config
```

## 2.2.2 Modifying the Aging Time of Dynamic Address Entries

Follow these steps to modify the aging time of dynamic address entries:

---

|        |                                                                                                                                                                                                                                                                                                                                                                                                                                                                                                  |
|--------|--------------------------------------------------------------------------------------------------------------------------------------------------------------------------------------------------------------------------------------------------------------------------------------------------------------------------------------------------------------------------------------------------------------------------------------------------------------------------------------------------|
| Step 1 | <b>configure</b><br>Enter global configuration mode.                                                                                                                                                                                                                                                                                                                                                                                                                                             |
| Step 2 | <b>mac address-table aging-time</b> <i>aging-time</i><br>Set your desired length of address aging time for dynamic address entries.<br><br><i>aging-time</i> : Set the length of time that a dynamic entry remains in the MAC address table after the entry is used or updated. The valid values are from 10 to 630. When 0 is entered, the Auto Aging function is disabled. The default value is 300 and we recommend you keep the default value if you are unsure about settings in your case. |
| Step 3 | <b>end</b><br>Return to privileged EXEC mode.                                                                                                                                                                                                                                                                                                                                                                                                                                                    |
| Step 4 | <b>copy running-config startup-config</b><br>Save the settings in the configuration file.                                                                                                                                                                                                                                                                                                                                                                                                        |

---

The following example shows how to modify the aging time to 500 seconds. A dynamic entry remains in the MAC address table for 500 seconds after the entry is used or updated.

**Switch#configure**

**Switch(config)# mac address-table aging-time 500**

**Switch(config)#show mac address-table aging-time**

Aging time is 500 sec.

**Switch(config)#end**

**Switch#copy running-config startup-config**

## 2.2.3 Adding MAC Filtering Address Entries

Follow these steps to add MAC filtering address entries:

---

|        |                                                                                                                                                                                                                                                                                                                                                                                                                                                    |
|--------|----------------------------------------------------------------------------------------------------------------------------------------------------------------------------------------------------------------------------------------------------------------------------------------------------------------------------------------------------------------------------------------------------------------------------------------------------|
| Step 1 | <b>configure</b><br>Enter global configuration mode.                                                                                                                                                                                                                                                                                                                                                                                               |
| Step 2 | <b>mac address-table filtering</b> <i>mac-addr vid vid</i><br>Add the filtering address to the VLAN.<br><br><i>mac-addr</i> : Specify a MAC address to configure the switch to drop packets which include this MAC address as the source address or destination address. The format is xx:xx:xx:xx:xx:xx, for example, 00:00:00:00:00:01.<br><br><i>vid</i> : Specify an existing VLAN in which packets with the specific MAC address are dropped. |

---

Step 3     **end**  
Return to privileged EXEC mode.

Step 4     **copy running-config startup-config**  
Save the settings in the configuration file.

 **Note:**

- In the same VLAN, once an address is configured as a filtering address, it cannot be set as a static address, and vice versa.
- Multicast or broadcast addresses cannot be set as filtering addresses .

The following example shows how to add the MAC filtering address 00:1e:4b:04:01:5d to VLAN 10. Then the switch will drop the packet that is received in VLAN 10 with this address as its source or destination.

**Switch#configure**

**Switch(config)# mac address-table filtering 00:1e:4b:04:01:5d vid 10**

**Switch(config)#show mac address-table filtering**

MAC Address Table

```
-----
MAC          VLAN  Port  Type    Aging
---          -
00:1e:4b:04:01:5d 10          filter  no-aging
```

Total MAC Addresses for this criterion: 1

**Switch(config)#end**

**Switch#copy running-config startup-config**

# 3 Security Configurations

With security configurations of the MAC address table, you can:

- Configure MAC notification traps
- Limit the number of MAC addresses in VLANs

## 3.1 Using the GUI

### 3.1.1 Configuring MAC Notification Traps

Choose the menu **Switching > MAC Address > MAC Notification** to load the following page.

Figure 3-1 Configuring MAC Notification Traps

**Mac Notification Global Config**

Global Status:  Enable  Disable

Table Full Notification:  Enable  Disable Apply

Notification Interval:  Seconds(1-1000)

**Mac Notification Port Config**

UNIT:

| Select                              | Port   | Learned Mode Change | Exceed Max Learned | New Mac Learned |
|-------------------------------------|--------|---------------------|--------------------|-----------------|
| <input type="checkbox"/>            |        | Enable ▾            | Enable ▾           | ▾               |
| <input checked="" type="checkbox"/> | 1/0/1  | Disable             | Disable            | Disable         |
| <input type="checkbox"/>            | 1/0/2  | Disable             | Disable            | Disable         |
| <input type="checkbox"/>            | 1/0/3  | Disable             | Disable            | Disable         |
| <input type="checkbox"/>            | 1/0/4  | Disable             | Disable            | Disable         |
| <input type="checkbox"/>            | 1/0/5  | Disable             | Disable            | Disable         |
| <input type="checkbox"/>            | 1/0/6  | Disable             | Disable            | Disable         |
| <input type="checkbox"/>            | 1/0/7  | Disable             | Disable            | Disable         |
| <input type="checkbox"/>            | 1/0/8  | Disable             | Disable            | Disable         |
| <input type="checkbox"/>            | 1/0/9  | Disable             | Disable            | Disable         |
| <input type="checkbox"/>            | 1/0/10 | Disable             | Disable            | Disable         |
| <input type="checkbox"/>            | 1/0/11 | Disable             | Disable            | Disable         |
| <input type="checkbox"/>            | 1/0/12 | Disable             | Disable            | Disable         |
| <input type="checkbox"/>            | 1/0/13 | Disable             | Disable            | Disable         |
| <input type="checkbox"/>            | 1/0/14 | Disable             | Disable            | Disable         |

All
Apply
Help

Follow these steps to configure MAC notification traps:

- 1) In the **MAC Notification Global Config** section, enable this feature, configure the relevant options, and click **Apply**.

|                                |                                                                                                                                                                                                                                                |
|--------------------------------|------------------------------------------------------------------------------------------------------------------------------------------------------------------------------------------------------------------------------------------------|
| <b>Global Status</b>           | Enable MAC notification feature globally.                                                                                                                                                                                                      |
| <b>Table Full Notification</b> | Enable Table Full Notification, and when address table is full, a notification will be generated and sent to the management host .                                                                                                             |
| <b>Notification Interval</b>   | Specify a time value in seconds between 1 to 1000 to bundle the notifications and reduce traffic. Notification Interval is the interval time between each set of New MAC Learned notifications that are generated. By default, it is 1 second. |

- 2) In the **MAC Notification Port Config** section, select your desired port and enable its notification traps. You can enable these three types: **Learned Mode Change**, **Exceed Max Learned** and **New MAC Learned**. Click **Apply**.

|                            |                                                                                                                                                                                                                                                                                                                                                                                                                                                   |
|----------------------------|---------------------------------------------------------------------------------------------------------------------------------------------------------------------------------------------------------------------------------------------------------------------------------------------------------------------------------------------------------------------------------------------------------------------------------------------------|
| <b>Learned Mode Change</b> | Enable Learned Mode Change, and when the learned mode of the specified port is changed, a notification will be generated and sent to the management host.                                                                                                                                                                                                                                                                                         |
| <b>Exceed Max Learned</b>  | <p>Enable Exceed Max Learned, and when the maximum number of learned MAC addresses on the specified port is exceeded, a notification will be generated and sent to the management host.</p> <p>For Exceed-max-learned notification, you need to enable Port Security and set the maximum number of learned MAC addresses on the specified port. For more information about Port Security, please refer to <a href="#">Physical Interface</a>.</p> |
| <b>New MAC Learned</b>     | Enable New MAC Learned, and when the specified port learns a new MAC address, a notification will be generated and sent to the management host.                                                                                                                                                                                                                                                                                                   |

- 3) Configure SNMP and set a management host. For detailed SNMP configurations, please refer to [Configuring SNMP & RMON](#).

### 3.1.2 Limiting the Number of MAC Addresses in VLANs

Choose the menu **Switching > MAC Address > MAC VLAN Security** to load the following page.

Figure 3-2 Limiting the Number of MAC Addresses in VLANs

**Vlan Security Config**

VLAN ID:  (1-4094)

Max Learned MAC:  (0-16383)

Mode:  ▼

**Vlan Security Table**

| Select                   | VLAN ID | Max Learned MAC | Learned Number | Mode    | Operation            |
|--------------------------|---------|-----------------|----------------|---------|----------------------|
| <input type="checkbox"/> | 1       | 50              | 8              | Forward | <a href="#">Edit</a> |

Follow these steps to limit the number of MAC addresses in VLANs:

- 1) Enter the VLAN ID to limit the number of MAC addresses that can be learned in the specified VLAN.

|         |                                                                                  |
|---------|----------------------------------------------------------------------------------|
| VLAN ID | Specify an existing VLAN in which you want to limit the number of MAC addresses. |
|---------|----------------------------------------------------------------------------------|

- 2) Enter your desired value in **Max Learned MAC** to set a threshold.

|                 |                                                                                                                                                                                                                                                                                                                                                                                                                                                                  |
|-----------------|------------------------------------------------------------------------------------------------------------------------------------------------------------------------------------------------------------------------------------------------------------------------------------------------------------------------------------------------------------------------------------------------------------------------------------------------------------------|
| Max Learned MAC | Set the maximum number of MAC addresses in the specific VLAN. It ranges from 0 to 16383.<br><br>You can control the available address table space by setting maximum learned MAC number for VLANs. However, an improper maximum number can cause unnecessary floods in the network or a waste of address table space. Therefore, before you set the number limit, please be sure you are familiar with the network topology and the switch system configuration. |
|-----------------|------------------------------------------------------------------------------------------------------------------------------------------------------------------------------------------------------------------------------------------------------------------------------------------------------------------------------------------------------------------------------------------------------------------------------------------------------------------|

- 3) Choose the mode that the switch adopts when the maximum number of MAC addresses in the specified VLAN is exceeded.

|         |                                                                                                                                                                         |
|---------|-------------------------------------------------------------------------------------------------------------------------------------------------------------------------|
| Drop    | Packets of new source MAC addresses in the VLAN will be dropped when the maximum number of MAC addresses in the specified VLAN is exceeded.                             |
| Forward | Packets of new source MAC addresses will be forwarded but the addresses will not be learned when the maximum number of MAC addresses in the specified VLAN is exceeded. |
| Disable | The number limit on the VLAN is not valid, and the switch follows the original forwarding rules.                                                                        |

- 4) Click **Create**.

## 3.2 Using the CLI

### 3.2.1 Configuring MAC Notification Traps

Follow these steps to configure MAC notification traps:

|        |                                                                                                                                                                                                                                                                                          |
|--------|------------------------------------------------------------------------------------------------------------------------------------------------------------------------------------------------------------------------------------------------------------------------------------------|
| Step 1 | <b>configure</b><br>Enter global configuration mode.                                                                                                                                                                                                                                     |
| Step 2 | <b>mac address-table notification global-status {enable   disable}</b><br>Enable MAC Notification globally.<br><b>enable   disable:</b> Enable or disable MAC Notification globally.                                                                                                     |
| Step 3 | <b>mac address-table notification table-full-status [enable   disable]</b><br>(Optional) Enable Table Full Notification.<br><b>enable   disable:</b> With Table Full Notification enabled, when address table is full, a notification will be generated and sent to the management host. |



- 
- Step 4     **mac address-table notification interval *time***
- Set your desired interval time between each set of New MAC Learned notifications that are generated.
- time*: Specify a time value in seconds between 1 to 1000 to bundle the notifications and reduce traffic. By default, it is 1 second.
- 
- Step 5     **interface { fastEthernet *port* | range fastEthernet *port-list* | gigabitEthernet *port* | range gigabitEthernet *port-list* | ten-gigabitEthernet *port* | range ten-gigabitEthernet *port-list* }**
- Configure notification traps on the specified port.
- port/ port-list*: The number or the list of the Ethernet port that you want to configure notification traps.
- 
- Step 6     **mac address-table notification {[learn-mode-change enable | disable] [exceed-max-learned enable | disable] [new-mac-learned enable | disable]}**
- Enable learn-mode-change, exceed-max-learned, or new-MAC-learned notification traps on the specified port.
- enable | disable**: Enable or disable learn-mode-change, exceed-max-learned, or new-MAC-learned notification traps on the specified port.
- learn-mode-change**: With learn-mode-change enabled, when the learned mode of the specified port is changed, a notification will be generated and sent to the management host.
- exceed-max-learned**: With exceed-max-learned enabled, when the maximum number of MAC addresses on the specified port is exceeded, a notification will be generated and sent to the management host.
- For Exceed Max Learned notification, you need to enable Port Security and set the maximum number of MAC addresses on the specified port. For more information about Port Security, please refer to [Physical Interface](#).
- new-mac-learned**: With new-mac-learned enabled, when the specified port learns a new MAC address, a notification will be generated and sent to the management host.
- 
- Step 7     **end**
- Return to privileged EXEC mode.
- 
- Step 8     **copy running-config startup-config**
- Save the settings in the configuration file.
- 

Now you have configured MAC notification traps. To receive notifications, you need to further enable SNMP and set a management host. For detailed SNMP configurations, please refer to [Configuring SNMP & RMON](#).

The following example shows how to enable new-MAC-learned trap on port 1, and set the interval time as 10 seconds. After you have further configured SNMP, the switch will bundle notifications of new addresses in every 10 seconds and send to the management host.

**Switch#configure**

**Switch(config)#mac address-table notification global-status enable**

**Switch(config)#mac address-table notification interval 10**

**Switch(config)#interface ten-gigabitEthernet 1/0/1**

```
Switch(config-if)#mac address-table notification new-mac-learned enable
```

```
Switch(config-if)#show mac address-table notification interface ten-gigabitEthernet
1/0/1
```

Mac Notification Global Config

Notification Global Status : enable

Table Full Notification Status: disable

Notification Interval : 10

| Port    | LrnMode Change | Exceed Max Limit | New Mac Learned |
|---------|----------------|------------------|-----------------|
| ----    | -----          | -----            | -----           |
| Te1/0/1 | disable        | disable          | enable          |

```
Switch(config-if)#end
```

```
Switch#copy running-config startup-config
```

### 3.2.2 Limiting the Number of MAC Addresses in VLANs

Follow these steps to limit the number of MAC addresses in VLANs:

|        |                                                                                                                                                                                                                                                                                                                                                                                                                                                                                                                                                                                                                                                                                                                                                                                                                                                                                                                                                                                                                                                                                                                      |
|--------|----------------------------------------------------------------------------------------------------------------------------------------------------------------------------------------------------------------------------------------------------------------------------------------------------------------------------------------------------------------------------------------------------------------------------------------------------------------------------------------------------------------------------------------------------------------------------------------------------------------------------------------------------------------------------------------------------------------------------------------------------------------------------------------------------------------------------------------------------------------------------------------------------------------------------------------------------------------------------------------------------------------------------------------------------------------------------------------------------------------------|
| Step 1 | <p><b>configure</b></p> <p>Enter global configuration mode.</p>                                                                                                                                                                                                                                                                                                                                                                                                                                                                                                                                                                                                                                                                                                                                                                                                                                                                                                                                                                                                                                                      |
| Step 2 | <p><b>mac address-table security vid <i>vid</i> max-learn <i>num</i> {drop   forward   disable}</b></p> <p>Configure the maximum number of MAC addresses in the specified VLAN and select a mode for the switch to adopt when the maximum number is exceeded.</p> <p><i>vid</i>: Specify an existing VLAN in which you want to limit the number of MAC addresses.</p> <p><i>num</i>: Set the maximum number of MAC addresses in the specific VLAN. It ranges from 0 to 16383.</p> <p><b>drop   forward   disable</b>: The mode that the switch adopts when the maximum number of MAC addresses in the specified VLAN is exceeded.</p> <p><b>drop</b>: Packets of new source MAC addresses in the VLAN will be dropped when the maximum number of MAC addresses in the specified VLAN is exceeded.</p> <p><b>forward</b>: Packets of new source MAC addresses will be forwarded but the addresses not learned when the maximum number of MAC addresses in the specified VLAN is exceeded.</p> <p><b>disable</b>: The number limit on the VLAN is not valid, and the switch follows the original forwarding rules.</p> |
| Step 3 | <p><b>end</b></p> <p>Return to privileged EXEC mode.</p>                                                                                                                                                                                                                                                                                                                                                                                                                                                                                                                                                                                                                                                                                                                                                                                                                                                                                                                                                                                                                                                             |
| Step 4 | <p><b>copy running-config startup-config</b></p> <p>Save the settings in the configuration file.</p>                                                                                                                                                                                                                                                                                                                                                                                                                                                                                                                                                                                                                                                                                                                                                                                                                                                                                                                                                                                                                 |

The following example shows how to limit the number of MAC addresses to 100 in VLAN 10, and configure the switch to drop packets of new source MAC addresses when the limit is exceeded.

**Switch#configure**

**Switch(config)#mac address-table security vid 10 max-learn 100 drop**

**Switch(config)#show mac address-table security vid 10**

| VlanId | Max-learn | Current-learn | Status |
|--------|-----------|---------------|--------|
| -----  | -----     | -----         | -----  |
| 10     | 100       | 0             | Drop   |

**Switch(config)#end**

**Switch#copy running-config startup-config**

# 4 Example for Security Configurations

## 4.1 Network Requirements

Several departments are connected to the company network as shown in Figure 4-1. Now the Marketing Department that is in VLAN 10 has network requirements as follows:

- Free the network system from illegal accesses and MAC address attacks by limiting the number of access users in this department to 100.
- Assist the network manager supervising the network with notifications of any new access users.

Figure 4-1 The Network Topology

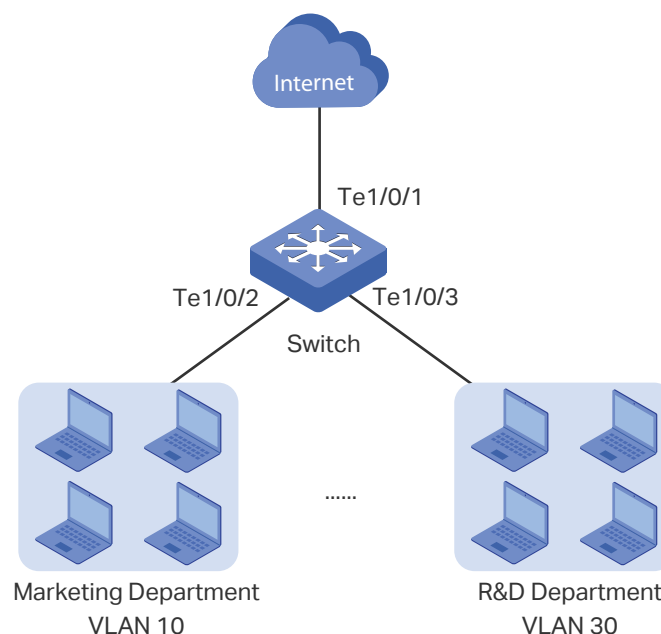

## 4.2 Configuration Scheme

VLAN Security can be configured to limit the number of access users and in this way to prevent illegal accesses and MAC address attacks.

MAC Notification and SNMP can be configured to monitor the interface which is used by the Marketing Department. Enable the new-MAC-learned notification and the SNMP, then the network manager can get notifications when new users access the network.

Demonstrated with T1700X-16TS, this chapter provides configuration procedures in two ways: using the GUI and using the CLI.

### 4.3 Using the GUI

- 1) Choose the menu **Switching > MAC Address > MAC VLAN Security** to load the following page. Set the maximum number of MAC address in VLAN 10 as 100, choose drop mode and click **Create**.

Figure 4-2 Configuring VLAN Security

Vlan Security Config

VLAN ID:  (1-4094)

Max Learned MAC:  (0-16383)

Mode:

---

Vlan Security Table

| Select                 | VLAN ID | Max Learned MAC | Learned Number | Mode | Operation |
|------------------------|---------|-----------------|----------------|------|-----------|
| No entry in the table. |         |                 |                |      |           |

- 2) Choose the menu **Switching > MAC Address > MAC Notification** to load the following page. Enable Global Status, set notification interval as 10 seconds, and click **Apply**. Then, enable new-mac-learned trap on port 1/0/2 and click **Apply**.

Figure 4-3 Configuring New-MAC-learned Traps

Mac Notification Global Config

Global Status:  Enable  Disable

Table Full Notification:  Enable  Disable

Notification Interval:  Seconds(1-1000)

---

Mac Notification Port Config

UNIT:

| Select                              | Port   | Learned Mode Change           | Exceed Max Learned            | New Mac Learned                                                    |
|-------------------------------------|--------|-------------------------------|-------------------------------|--------------------------------------------------------------------|
| <input type="checkbox"/>            |        | <input type="text" value=""/> | <input type="text" value=""/> | <input style="border: 1px solid red;" type="text" value="Enable"/> |
| <input type="checkbox"/>            | 1/0/1  | Disable                       | Disable                       | Disable                                                            |
| <input checked="" type="checkbox"/> | 1/0/2  | Disable                       | Disable                       | Disable                                                            |
| <input type="checkbox"/>            | 1/0/3  | Disable                       | Disable                       | Disable                                                            |
| <input type="checkbox"/>            | 1/0/4  | Disable                       | Disable                       | Disable                                                            |
| <input type="checkbox"/>            | 1/0/5  | Disable                       | Disable                       | Disable                                                            |
| <input type="checkbox"/>            | 1/0/6  | Disable                       | Disable                       | Disable                                                            |
| <input type="checkbox"/>            | 1/0/7  | Disable                       | Disable                       | Disable                                                            |
| <input type="checkbox"/>            | 1/0/8  | Disable                       | Disable                       | Disable                                                            |
| <input type="checkbox"/>            | 1/0/9  | Disable                       | Disable                       | Disable                                                            |
| <input type="checkbox"/>            | 1/0/10 | Disable                       | Disable                       | Disable                                                            |
| <input type="checkbox"/>            | 1/0/11 | Disable                       | Disable                       | Disable                                                            |
| <input type="checkbox"/>            | 1/0/12 | Disable                       | Disable                       | Disable                                                            |
| <input type="checkbox"/>            | 1/0/13 | Disable                       | Disable                       | Disable                                                            |
| <input type="checkbox"/>            | 1/0/14 | Disable                       | Disable                       | Disable                                                            |

- 3) Click **Save Config** to save the settings.
- 4) Enable SNMP and set a management host. For detailed SNMP configurations, please refer to [Configuring SNMP & RMON](#).

## 4.4 Using the CLI

- 1) Set the maximum number of MAC address in VLAN 10 as 100, and choose drop mode.  

```
Switch#configure
Switch(config)#mac address-table security vid 10 max-learn 100 drop
```
- 2) Configure the new-MAC-learned trap on port 2 and set notification interval as 10 seconds.  

```
Switch(config)#mac address-table notification global-status enable
Switch(config)#mac address-table notification interval 10
Switch(config)#interface ten-gigabitEthernet 1/0/2
Switch(config-if)#mac address-table notification new-mac-learned enable
Switch(config-if)#end
Switch#copy running-config startup-config
```
- 3) Configure SNMP and set a management host. For detailed SNMP configurations, please refer to [Configuring SNMP & RMON](#).

### Verify the Configurations

Verify the configuration of VLAN Security.

```
Switch#show mac address-table security vid 10
```

| VlanId | Max-learn | Current-learn | Status |
|--------|-----------|---------------|--------|
| -----  | -----     | -----         | -----  |
| 10     | 100       | 0             | Drop   |

Verify the configuration of MAC Notification on port 1/0/2.

```
Switch#show mac address-table notification interface ten-gigabitEthernet 1/0/2
```

| Port    | LrnMode Change | Exceed Max Limit | New Mac Learned |
|---------|----------------|------------------|-----------------|
| ----    | -----          | -----            | -----           |
| Te1/0/2 | disable        | disable          | enable          |

# 5 Appendix: Default Parameters

Default settings of the MAC Address Table are listed in the following tables.

Table 5-1 Entries in the MAC Address Table

| Parameter                 | Default Setting |
|---------------------------|-----------------|
| Static Address Entries    | None            |
| Dynamic Address Entries   | Auto-learning   |
| Filtering Address Entries | None            |

Table 5-2 Default Settings of Dynamic Address Table

| Parameter  | Default Setting |
|------------|-----------------|
| Auto Aging | Enable          |
| Aging Time | 300 seconds     |

Table 5-3 Default Settings of MAC Notification

| Parameter                        | Default Setting |
|----------------------------------|-----------------|
| Global Status                    | Disable         |
| Table Full Notification          | Disable         |
| Notification Interval            | 1 Second        |
| Learned Mode Change Notification | Disable         |
| Exceed Max Learned Notification  | Disable         |
| New MAC Learned Notification     | Disable         |

Table 5-4 Default Settings of MAC VLAN Security

| Parameter         | Default Setting |
|-------------------|-----------------|
| MAC VLAN Security | Disable         |

# Part 7

## Configuring 802.1Q VLAN

### CHAPTERS

1. Overview
2. 802.1Q VLAN Configuration
3. Configuration Example
4. Appendix: Default Parameters



# 1 Overview

VLAN (Virtual Local Area Network) is a network technique that solves broadcasting issues in local area networks. It is usually applied in the following occasions:

- To restrict broadcast domain: VLAN technique divides a big local area network into several VLANs, and all VLAN traffic remains within its VLAN. It reduces the influence of broadcast traffic in Layer 2 network to the whole network.
- To enhance network security: Devices from different VLANs cannot achieve Layer 2 communication, and thus users can group and isolate devices to enhance network security.
- For easier management: VLANs group devices logically instead of physically, so devices in the same VLAN need not be located in the same place. It eases the management of devices in the same work group but located in different places.

# 2 802.1Q VLAN Configuration

To complete 802.1Q VLAN configuration, follow these steps:

- 1) Configure PVID (Port VLAN ID) of the port;
- 2) Configure the VLAN, including creating a VLAN and adding the configured port to the VLAN.

## 2.1 Using the GUI

### 2.1.1 Configuring the PVID of the Port

Choose the menu **VLAN > 802.1Q VLAN > Port Config** to load the following page.

Figure 2-1 Configuring the Port

| VLAN Port Config                          |        |                                |     |                        |
|-------------------------------------------|--------|--------------------------------|-----|------------------------|
| UNIT: <input type="text" value="1"/> LAGS |        |                                |     |                        |
| Select                                    | Port   | PVID                           | LAG | VLAN                   |
| <input type="checkbox"/>                  |        | <input type="text" value="2"/> |     |                        |
| <input type="checkbox"/>                  | 1/0/1  | 1                              | --- | <a href="#">Detail</a> |
| <input type="checkbox"/>                  | 1/0/2  | 1                              | --- | <a href="#">Detail</a> |
| <input type="checkbox"/>                  | 1/0/3  | 1                              | --- | <a href="#">Detail</a> |
| <input type="checkbox"/>                  | 1/0/4  | 1                              | --- | <a href="#">Detail</a> |
| <input checked="" type="checkbox"/>       | 1/0/5  | 1                              | --- | <a href="#">Detail</a> |
| <input type="checkbox"/>                  | 1/0/6  | 1                              | --- | <a href="#">Detail</a> |
| <input type="checkbox"/>                  | 1/0/7  | 1                              | --- | <a href="#">Detail</a> |
| <input type="checkbox"/>                  | 1/0/8  | 1                              | --- | <a href="#">Detail</a> |
| <input type="checkbox"/>                  | 1/0/9  | 1                              | --- | <a href="#">Detail</a> |
| <input type="checkbox"/>                  | 1/0/10 | 1                              | --- | <a href="#">Detail</a> |
| <input type="checkbox"/>                  | 1/0/11 | 1                              | --- | <a href="#">Detail</a> |
| <input type="checkbox"/>                  | 1/0/12 | 1                              | --- | <a href="#">Detail</a> |
| <input type="checkbox"/>                  | 1/0/13 | 1                              | --- | <a href="#">Detail</a> |
| <input type="checkbox"/>                  | 1/0/14 | 1                              | --- | <a href="#">Detail</a> |
| <input type="checkbox"/>                  | 1/0/15 | 1                              | --- | <a href="#">Detail</a> |

Select a port and configure its PVID. Click **Apply**.

|      |                                                                                                                                                                                                                                                                                                                                                                                                        |
|------|--------------------------------------------------------------------------------------------------------------------------------------------------------------------------------------------------------------------------------------------------------------------------------------------------------------------------------------------------------------------------------------------------------|
| PVID | The default VLAN ID of the port with the values between 1 and 4094. It is used mainly in the following two ways: <ul style="list-style-type: none"> <li>When the port receives a tagged packet, the switch inserts a VLAN tag to the packet based on the PVID.</li> <li>When the port receives a UL packet or a broadcast packet, the switch broadcasts the packet within the default VLAN.</li> </ul> |
| LAG  | Displays the LAG (Link Aggregation Group) which the port belongs to.                                                                                                                                                                                                                                                                                                                                   |
| VLAN | Check details of the VLAN which the port is in.                                                                                                                                                                                                                                                                                                                                                        |

### 2.1.2 Configuring the VLAN

Choose the menu **VLAN > 802.1Q VLAN > VLAN Config** and click **Create** to load the following page.

Figure 2-2 Configuring VLAN

**VLAN Info**

VLAN ID:  (2 - 4094)

Name:  (16 characters maximum)

**Untagged port**

UNIT:  LAGS

|                          |                          |                          |                          |                          |                          |                          |                          |
|--------------------------|--------------------------|--------------------------|--------------------------|--------------------------|--------------------------|--------------------------|--------------------------|
| <input type="checkbox"/> | <input type="checkbox"/> | <input type="checkbox"/> | <input type="checkbox"/> | <input type="checkbox"/> | <input type="checkbox"/> | <input type="checkbox"/> | <input type="checkbox"/> |
| 2                        | 4                        | 6                        | 8                        | 10                       | 12                       | 14                       | 16                       |
| <input type="checkbox"/> | <input type="checkbox"/> | <input type="checkbox"/> | <input type="checkbox"/> | <input type="checkbox"/> | <input type="checkbox"/> | <input type="checkbox"/> | <input type="checkbox"/> |
| 1                        | 3                        | 5                        | 7                        | 9                        | 11                       | 13                       | 15                       |

**Tagged port**

UNIT:  LAGS

|                          |                          |                          |                          |                          |                          |                          |                          |
|--------------------------|--------------------------|--------------------------|--------------------------|--------------------------|--------------------------|--------------------------|--------------------------|
| <input type="checkbox"/> | <input type="checkbox"/> | <input type="checkbox"/> | <input type="checkbox"/> | <input type="checkbox"/> | <input type="checkbox"/> | <input type="checkbox"/> | <input type="checkbox"/> |
| 2                        | 4                        | 6                        | 8                        | 10                       | 12                       | 14                       | 16                       |
| <input type="checkbox"/> | <input type="checkbox"/> | <input type="checkbox"/> | <input type="checkbox"/> | <input type="checkbox"/> | <input type="checkbox"/> | <input type="checkbox"/> | <input type="checkbox"/> |
| 1                        | 3                        | 5                        | 7                        | 9                        | 11                       | 13                       | 15                       |

|                                             |                                                      |                                                      |
|---------------------------------------------|------------------------------------------------------|------------------------------------------------------|
| <input type="checkbox"/> Unselected Port(s) | <input checked="" type="checkbox"/> Selected Port(s) | <input type="checkbox"/> Not Available for Selection |
|---------------------------------------------|------------------------------------------------------|------------------------------------------------------|

Follow these steps to configure VLAN:

- 1) Enter a VLAN ID and a description for identification to create a VLAN.

|         |                                                                        |
|---------|------------------------------------------------------------------------|
| VLAN ID | Enter a VLAN ID for identification with the values between 2 and 4094. |
| Name    | Give a VLAN description for identification with up to 16 characters.   |

- 2) Select the untagged port(s) and the tagged port(s) respectively to add to the created VLAN based on the network topology.

|               |                                                                      |
|---------------|----------------------------------------------------------------------|
| Untagged port | The selected ports will forward untagged packets in the target VLAN. |
| Tagged port   | The selected ports will forward tagged packets in the target VLAN.   |

- 3) Click **Apply**.

## 2.2 Using the CLI

### 2.2.1 Creating a VLAN

Follow these steps to create a VLAN:

|        |                                                                                                                                                                                                                                                                                                                                                                            |
|--------|----------------------------------------------------------------------------------------------------------------------------------------------------------------------------------------------------------------------------------------------------------------------------------------------------------------------------------------------------------------------------|
| Step 1 | <b>configure</b><br>Enter global configuration mode.                                                                                                                                                                                                                                                                                                                       |
| Step 2 | <b>vlan <i>vlan-list</i></b><br>When you enter a new VLAN ID, the switch creates a new VLAN and enters VLAN configuration mode; when you enter an existing VLAN ID, the switch directly enters VLAN configuration mode.<br><br><i>vlan-list</i> : Specify the ID or the ID list of the VLAN(s) for configuration. The valid values are from 2 to 4094, for example, 2-3,5. |
| Step 3 | <b>name <i>descript</i></b><br>(Optional) Specify a VLAN description for identification.<br><br><i>descript</i> : The length of the description should be 1 to 16 characters.                                                                                                                                                                                              |
| Step 4 | <b>show vlan [ id <i>vlan-list</i> ]</b><br>Show the global information of the specified VLAN(s). When no VLAN is specified, this command shows global information of all 802.1Q VLANs.<br><br><i>vlan-list</i> : Specify the ID or the ID list of the VLAN(s) to show information. The valid values are from 1 to 4094.                                                   |
| Step 5 | <b>end</b><br>Return to privileged EXEC mode.                                                                                                                                                                                                                                                                                                                              |
| Step 6 | <b>copy running-config startup-config</b><br>Save the settings in the configuration file.                                                                                                                                                                                                                                                                                  |

The following example shows how to create VLAN 2 and name it as RD :

```
Switch#configure
```

```
Switch(config)#vlan 2
```

```
Switch(config-vlan)#name RD
```

```
Switch(config-vlan)#show vlan id 2
```

```
VLAN      Name      Status    Ports
-----
2         RD        active
```

```
Switch(config-vlan)#end
```

```
Switch#copy running-config startup-config
```

## 2.2.2 Configuring the PVID of the Port

Follow these steps to configure the port:

|        |                                                                                                                                                                                                                                                                                                                                                                                       |
|--------|---------------------------------------------------------------------------------------------------------------------------------------------------------------------------------------------------------------------------------------------------------------------------------------------------------------------------------------------------------------------------------------|
| Step 1 | <b>configure</b><br>Enter global configuration mode.                                                                                                                                                                                                                                                                                                                                  |
| Step 2 | <b>interface { fastEthernet <i>port</i>   range fastEthernet <i>port-list</i>   gigabitEthernet <i>port</i>   range gigabitEthernet <i>port-list</i>   ten-gigabitEthernet <i>port</i>   range ten-gigabitEthernet <i>port-list</i> }</b><br>Enter interface configuration mode.<br><i>port   port-list</i> : The number or the list of the Ethernet port that you want to configure. |
| Step 3 | <b>switchport pvid <i>vlan-id</i></b><br>Configure the PVID of the port(s). By default, it is 1.<br><i>vlan-id</i> : The default VLAN ID of the port with the values between 1 and 4094.                                                                                                                                                                                              |
| Step 4 | <b>end</b><br>Return to privileged EXEC mode.                                                                                                                                                                                                                                                                                                                                         |
| Step 5 | <b>copy running-config startup-config</b><br>Save the settings in the configuration file.                                                                                                                                                                                                                                                                                             |

The following example shows how to configure the PVID of port 1/0/5 as VLAN 2:

```
Switch#configure
```

```
Switch(config)#interface ten-gigabitEthernet 1/0/5
```

```
Switch(config-if)#switchport pvid 2
```

```
Switch(config-if)#show interface switchport ten-gigabitEthernet 1/0/5
```

```
Port Te1/0/5:
```

```
PVID: 2
```

```
Member in LAG: N/A
```

```
Link Type: General
```

```
Member in VLAN:
```

| Vlan | Name        | Egress-rule |
|------|-------------|-------------|
| 1    | System-VLAN | Untagged    |

```
Switch(config-if)#end
```

```
Switch#copy running-config startup-config
```

## 2.2.3 Adding the Port to the Specified VLAN

Follow these steps to add the port to the specified VLAN:

|        |                                                                                                                                                                                                                                                                                                                                                                                              |
|--------|----------------------------------------------------------------------------------------------------------------------------------------------------------------------------------------------------------------------------------------------------------------------------------------------------------------------------------------------------------------------------------------------|
| Step 1 | <b>configure</b><br>Enter global configuration mode.                                                                                                                                                                                                                                                                                                                                         |
| Step 2 | <b>interface { fastEthernet <i>port</i>   range fastEthernet <i>port-list</i>   gigabitEthernet <i>port</i>   range gigabitEthernet <i>port-list</i>   ten-gigabitEthernet <i>port</i>   range ten-gigabitEthernet <i>port-list</i> }</b><br>Enter interface configuration mode.<br><i>port</i>   <i>port-list</i> : The number or the list of the Ethernet port that you want to configure. |
| Step 3 | <b>switchport general allowed vlan <i>vlan-list</i> { tagged   untagged }</b><br>Add the port to the specified VLAN, and specify its egress rule in this VLAN.<br><i>vlan-id</i> : The default VLAN ID of the port with the values between 1 and 4094.<br><b>tagged   untagged</b> : Egress rule for the port.                                                                               |
| Step 4 | <b>show interface switchport [ fastEthernet <i>port</i>   gigabitEthernet <i>port</i>   ten-gigabitEthernet <i>port</i> ]</b><br>Verify the information of the port.<br><i>port</i> : Specify the ID of the port to show information.                                                                                                                                                        |
| Step 5 | <b>end</b><br>Return to privileged EXEC mode.                                                                                                                                                                                                                                                                                                                                                |
| Step 6 | <b>copy running-config startup-config</b><br>Save the settings in the configuration file.                                                                                                                                                                                                                                                                                                    |

The following example shows how to add the port 1/0/5 to VLAN 2, and specify its egress rule as tagged:

```
Switch#configure
```

```
Switch(config)#interface ten-gigabitEthernet 1/0/5
```

```
Switch(config-if)#switchport general allowed vlan 2 tagged
```

```
Switch(config-if)#show interface switchport ten-gigabitEthernet 1/0/5
```

```
Port Te1/0/5:
```

```
PVID: 2
```

Member in LAG: N/A

Link Type: General

Member in VLAN:

| Vlan  | Name        | Egress-rule |
|-------|-------------|-------------|
| ----- | -----       | -----       |
| 1     | System-VLAN | Untagged    |
| 2     | rd          | Tagged      |

**Switch(config-if)#end**

**Switch#copy running-config startup-config**

# 3 Configuration Example

## 3.1 Network Requirements

- Offices of both Department A and Department B in the company are located in different places, and computers in different offices are connected to different switches.
- It is required that computers can communicate with each other in the same department but not with computers in the other department.

## 3.2 Configuration Scheme

- Divide computers in Department A and Department B into two VLANs respectively so that computers can communicate with each other in the same department but not with computers in the other department.
- Terminal devices like computers usually do not support VLAN tags. Configure the switch ports connected to the computers as Untagged. Then add the ports to the corresponding VLANs.
- The intermediate link between two switches carries traffic from two VLANs simultaneously. Configure the ports on both ends of the intermediate link as Tagged, and add the ports to both VLANs.



### 3.3 Network Topology

The figure below shows the network topology. Host A1 and Host A2 are used in Department A, while Host B1 and Host B2 are used in Department B. Switch 1 and Switch 2 are located in two different places. Host A1 and Host B1 are connected to port 1/0/2 and port 1/0/3 on Switch 1 respectively, while Host A2 and Host B2 are connected to port 1/0/6 and port 1/0/7 on Switch 2 respectively. Port 1/0/4 on Switch 1 is connected to port 1/0/8 on Switch 2.

Figure 3-1 Network Topology

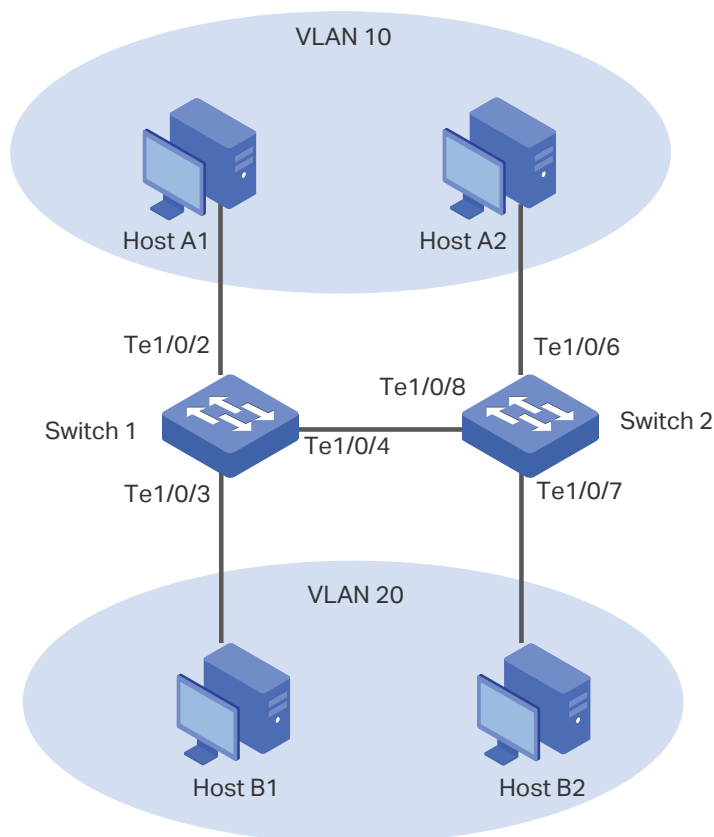

Demonstrated with T1700X-16TS, the following sections provide configuration procedure in two ways: using the GUI and using the CLI.

### 3.4 Using the GUI

The configurations of Switch 1 and Switch 2 are similar. The following introductions take Switch 1 as an example.

- 1) Choose the menu **VLAN > 802.1Q VLAN > VLAN Config** and click **Create** to load the following page. Create VLAN 10 with the description of Department-A. Add port 1/0/2 as an untagged port and port 1/0/4 as a tagged port to VLAN 10. Then click **Apply**.

Figure 3-2 Create VLAN 10 for Department A

**VLAN Info**

VLAN ID:  (2 - 4094)

Name :  (16 characters maximum)

---

**Untagged port**

UNIT:  LAGS

|                            |                            |                            |                            |                             |                             |                             |                             |
|----------------------------|----------------------------|----------------------------|----------------------------|-----------------------------|-----------------------------|-----------------------------|-----------------------------|
| <input type="checkbox"/> 2 | <input type="checkbox"/> 4 | <input type="checkbox"/> 6 | <input type="checkbox"/> 8 | <input type="checkbox"/> 10 | <input type="checkbox"/> 12 | <input type="checkbox"/> 14 | <input type="checkbox"/> 16 |
| <input type="checkbox"/> 1 | <input type="checkbox"/> 3 | <input type="checkbox"/> 5 | <input type="checkbox"/> 7 | <input type="checkbox"/> 9  | <input type="checkbox"/> 11 | <input type="checkbox"/> 13 | <input type="checkbox"/> 15 |

---

**Tagged port**

UNIT:  LAGS

|                            |                            |                            |                            |                             |                             |                             |                             |
|----------------------------|----------------------------|----------------------------|----------------------------|-----------------------------|-----------------------------|-----------------------------|-----------------------------|
| <input type="checkbox"/> 2 | <input type="checkbox"/> 4 | <input type="checkbox"/> 6 | <input type="checkbox"/> 8 | <input type="checkbox"/> 10 | <input type="checkbox"/> 12 | <input type="checkbox"/> 14 | <input type="checkbox"/> 16 |
| <input type="checkbox"/> 1 | <input type="checkbox"/> 3 | <input type="checkbox"/> 5 | <input type="checkbox"/> 7 | <input type="checkbox"/> 9  | <input type="checkbox"/> 11 | <input type="checkbox"/> 13 | <input type="checkbox"/> 15 |

Unselected Port(s)

Selected Port(s)

Not Available for Selection

- 2) Click **Create** again to load the following page. Create VLAN 20 with the description of Department-B. Add port 1/0/3 as an untagged port and port 1/0/4 as a tagged port to VLAN 20. Then click **Apply**.

Figure 3-3 Create VLAN 20 for Department B

**VLAN Info**

VLAN ID:  (2 - 4094)

Name:  (16 characters maximum)

---

**Untagged port**

UNIT:  LAGS

|                          |                                     |                          |                          |                          |                          |                          |                          |
|--------------------------|-------------------------------------|--------------------------|--------------------------|--------------------------|--------------------------|--------------------------|--------------------------|
| <input type="checkbox"/> | <input type="checkbox"/>            | <input type="checkbox"/> | <input type="checkbox"/> | <input type="checkbox"/> | <input type="checkbox"/> | <input type="checkbox"/> | <input type="checkbox"/> |
| <input type="checkbox"/> | <input checked="" type="checkbox"/> | <input type="checkbox"/> | <input type="checkbox"/> | <input type="checkbox"/> | <input type="checkbox"/> | <input type="checkbox"/> | <input type="checkbox"/> |

---

**Tagged port**

UNIT:  LAGS

|                          |                                     |                          |                          |                          |                          |                          |                          |
|--------------------------|-------------------------------------|--------------------------|--------------------------|--------------------------|--------------------------|--------------------------|--------------------------|
| <input type="checkbox"/> | <input checked="" type="checkbox"/> | <input type="checkbox"/> | <input type="checkbox"/> | <input type="checkbox"/> | <input type="checkbox"/> | <input type="checkbox"/> | <input type="checkbox"/> |
| <input type="checkbox"/> | <input type="checkbox"/>            | <input type="checkbox"/> | <input type="checkbox"/> | <input type="checkbox"/> | <input type="checkbox"/> | <input type="checkbox"/> | <input type="checkbox"/> |

Unselected Port(s)  
 Selected Port(s)  
 Not Available for Selection

- 3) Click **Save Config** to save the settings.

### 3.5 Using the CLI

The configurations of Switch 1 and Switch 2 are similar. The following introductions take Switch 1 as an example.

- 1) Create VLAN 10 for Department A, and configure the description as Department-A. Similarly, create VLAN 20 for Department B, and configure the description as Department-B.

```
Switch_1#configure
```

```
Switch_1(config)#vlan 10
```

```
Switch_1(config-vlan)#name Department-A
```

```
Switch_1(config-vlan)#exit
```

```
Switch_1(config)#vlan 20
```

```
Switch_1(config-vlan)#name Department-B
```

```
Switch_1(config-vlan)#exit
```

- 2) Set the port mode of port 1/0/2 and port 1/0/3 as Untagged, and then add port 1/0/2 to VLAN 10 and add port 1/0/3 to VLAN 20.

```
Switch_1(config)#interface ten-gigabitEthernet 1/0/2
Switch_1(config-if)#switchport general allowed vlan 10 untagged
Switch_1(config-if)#exit
Switch_1(config)#interface ten-gigabitEthernet 1/0/3
Switch_1(config-if)#switchport general allowed vlan 20 untagged
Switch_1(config-if)#exit
```

- 3) Set the port mode of port 1/0/4 as Tagged, and then add it to both VLAN 10 and VLAN 20.

```
Switch_1(config)#interface ten-gigabitEthernet 1/0/4
Switch_1(config-if)#switchport general allowed vlan 10,20 tagged
Switch_1(config-if)#end
Switch_1#copy running-config startup-config
```

### Verify the Configurations

```
Switch_1#show vlan
```

| VLAN | Name         | Status | Ports                                                                             |
|------|--------------|--------|-----------------------------------------------------------------------------------|
| 1    | Default VLAN | active | Te1/0/1, Te1/0/2, Te1/0/3, Te1/0/4,<br>Te1/0/5, Te1/0/6, Te1/0/7, Te1/0/8,<br>... |
| 10   | Department-A | active | Te1/0/2, Te1/0/4                                                                  |
| 20   | Department-B | active | Te1/0/3, Te1/0/4                                                                  |

# 4 Appendix: Default Parameters

Default settings of 802.1Q VLAN are listed in the following table.

Table 4-1 Default Settings of 802.1Q VLAN

| Parameter   | Default Setting |
|-------------|-----------------|
| VLAN ID     | 1               |
| PVID        | 1               |
| Egress rule | Untagged        |

# Part 8

## Configuring MAC VLAN

### CHAPTERS

1. Overview
2. MAC VLAN Configuration
3. Configuration Example
4. Appendix: Default Parameters

# 1 Overview

VLAN is generally divided by ports. This way of division is simple but isn't suitable for those networks that require frequent topology changes. With the popularity of mobile office, a terminal device may access the switch via different ports. For example, a terminal device that accessed the switch via port 1 last time may change to port 2 this time. If port 1 and port 2 belong to different VLANs, the user has to re-configure the switch to access the original VLAN. Using MAC VLAN can free the user from such a problem. It divides VLANs based on the MAC addresses of terminal devices. In this way, terminal devices always belong to their original VLANs even when their access ports change.

The figure below shows a common application scenario of MAC VLAN.

Figure 1-1 Common Application Scenario of MAC VLAN

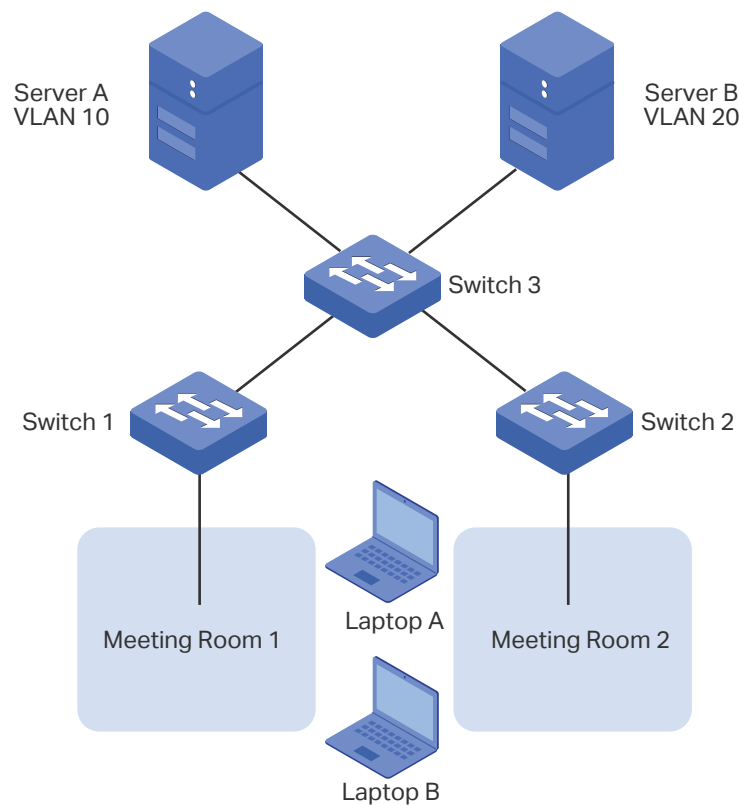

Two departments share all the meeting rooms in the company, but use different servers and laptops. Department A uses Server A and Laptop A, while Department B uses Server B and Laptop B. Server A is in VLAN 10 while Server B is in VLAN 20. It is required that Laptop A can only access Server A and Laptop B can only access Server B, no matter which meeting room the laptops are being used in. To meet this requirement, simply bind the MAC addresses of the laptops to the corresponding VLANs respectively. In this way, the MAC address rather than the access port determines the VLAN each laptop joins. Each laptop can access only the server in the VLAN it joins.

# 2 MAC VLAN Configuration

To complete MAC VLAN configuration, follow these steps:

- 1) Configure 802.1Q VLAN.
- 2) Bind the MAC address to the VLAN.
- 3) Enable MAC VLAN for the port.

## Configuration Guidelines

When a port in a MAC VLAN receives an untagged data packet, the switch will first check whether the source MAC address of the data packet has been bound to the MAC VLAN. If yes, the switch will insert the corresponding tag to the data packet and forward it within the VLAN. If no, the switch will continue to match the data packet with the matching rules of other VLANs (such as the protocol VLAN). If there is a match, the switch will forward the data packet. Otherwise, the switch will process the data packet according to the processing rule of the 802.1 Q VLAN. When the port receives a tagged data packet, the switch will directly process the data packet according to the processing rule of the 802.1 Q VLAN.

## 2.1 Using the GUI

### 2.1.1 Configuring 802.1Q VLAN

Before configuring MAC VLAN, create an 802.1Q VLAN and set the port type according to network requirements. For details, refer to [Configuring 802.1Q VLAN](#).



## 2.1.2 Binding the MAC Address to the VLAN

Choose the menu **VLAN > MAC VLAN > MAC VLAN** to load the following page.

Figure 2-1 MAC VLAN Configuration

**Create MAC VLAN**

MAC Address:  (Format: 00-00-00-00-00-01)

Description:  (8 characters maximum)

VLAN ID:  (1-4094)

---

**MAC VLAN Table**

| Select                        | MAC Address | Description | VLAN ID | Operation |
|-------------------------------|-------------|-------------|---------|-----------|
| <b>No entry in the table.</b> |             |             |         |           |

Follow these steps to bind the MAC address to the VLAN:

- 1) Enter the MAC address of the device, give it a description, and enter the VLAN ID to bind it to the VLAN.

|                    |                                                                                         |
|--------------------|-----------------------------------------------------------------------------------------|
| <b>MAC Address</b> | Enter the MAC address of the device. The address should be in 00-00-00-00-00-01 format. |
| <b>Description</b> | Give a MAC address description for identification with up to 8 characters.              |
| <b>VLAN ID</b>     | Enter the ID of the 802.1Q VLAN where the port with MAC VLAN enabled is.                |

- 2) Click **Create** to create the MAC VLAN.

 **Note:**

One MAC address can be bound to only one VLAN.

## 2.1.3 Enabling MAC VLAN for the Port

By default, MAC VLAN is disabled on all ports. You need to enable MAC VLAN for your desired ports manually.

Choose the menu **VLAN > MAC VLAN > Port Enable** to load the following page.

Figure 2-2 Enable MAC VLAN for the Port

Follow these steps to enable MAC VLAN for the port:

Select your desired ports to enable MAC VLAN, and click **Apply**.

 **Note:**

The member port of an LAG (Link Aggregation Group) follows the configuration of the LAG but not its own. The configurations of the port can take effect only after it leaves the LAG.

## 2.2 Using the CLI

### 2.2.1 Configuring 802.1Q VLAN

Before configuring MAC VLAN, create an 802.1Q VLAN and set the port type according to network requirements. For details, refer to [Configuring 802.1Q VLAN](#).

### 2.2.2 Binding the MAC Address to the VLAN

Follow these steps to bind the MAC address to the VLAN:

Step 1 **configure**

Enter global configuration mode.

Step 2 **mac-vlan mac-address mac-addr vlan vlan-id [description descrip]**

Bind the MAC address to the VLAN.

*mac-addr*: MAC address of the device. The address should be in xx:xx:xx:xx:xx:xx format.

*vlan-id*: ID of the 802.1Q VLAN where the port with MAC VLAN enabled is.

*descript*: MAC address description for identification, with up to 8 characters.

- 
- Step 3      **show mac-vlan vid**  
Verify the configuration of MAC VLAN.  
*vid*: Specify the MAC VLAN to be displayed.
- 
- Step 4      **end**  
Return to privileged EXEC mode.
- 
- Step 5      **copy running-config startup-config**  
Save the settings in the configuration file.
- 

The following example shows how to bind the MAC address 00:19:56:8A:4C:71 to VLAN 10, with the address description as Dept.A.

**Switch#configure**

**Switch(config)#mac-vlan mac-address 00:19:56:8a:4c:71 vlan 10 description Dept.A**

**Switch(config)#show mac-vlan vlan 10**

| MAC-Addr          | Name   | VLAN-ID |
|-------------------|--------|---------|
| -----             | -----  | -----   |
| 00:19:56:8A:4C:71 | Dept.A | 10      |

**Switch(config)#end**

**Switch#copy running-config startup-config**

## 2.2.3 Enabling MAC VLAN for the Port

Follow these steps to enable MAC VLAN for the port:

- 
- Step 1      **configure**  
Enter global configuration mode.
- 
- Step 2      **interface { fastEthernet port | range fastEthernet port-list | gigabitEthernet port | range gigabitEthernet port-list | ten-gigabitEthernet port | range ten-gigabitEthernet port-list }**  
Enter interface configuration mode.
- 
- Step 3      **mac-vlan**  
Enable MAC VLAN for the port.
- 
- Step 4      **show mac-vlan interface**  
Verify the configuration of MAC VLAN on each interface.
- 
- Step 5      **end**  
Return to privileged EXEC mode.
-

- 
- Step 6      **copy running-config startup-config**  
Save the settings in the configuration file.
- 

The following example shows how to enable MAC VLAN for port 1/0/1.

**Switch#configure**

**Switch(config)#interface ten-gigabitEthernet 1/0/1**

**Switch(config-if)#mac-vlan**

**Switch(config-if)#show mac-vlan interface**

Port    STATUS

-----

Te1/0/1    Enable

Te1/0/2    Disable

.....

**Switch(config-if)#end**

**Switch#copy running-config startup-config**

# 3 Configuration Example

## 3.1 Network Requirements

Two departments share all the meeting rooms in the company, but use different servers and laptops. Department A uses Server A and Laptop A, while Department B uses Server B and Laptop B. Server A is in VLAN 10 while Server B is in VLAN 20. It is required that Laptop A can only access Server A and Laptop B can only access Server B, no matter which meeting room the laptops are being used in. The figure below shows the network topology.

Figure 3-1 Network Topology

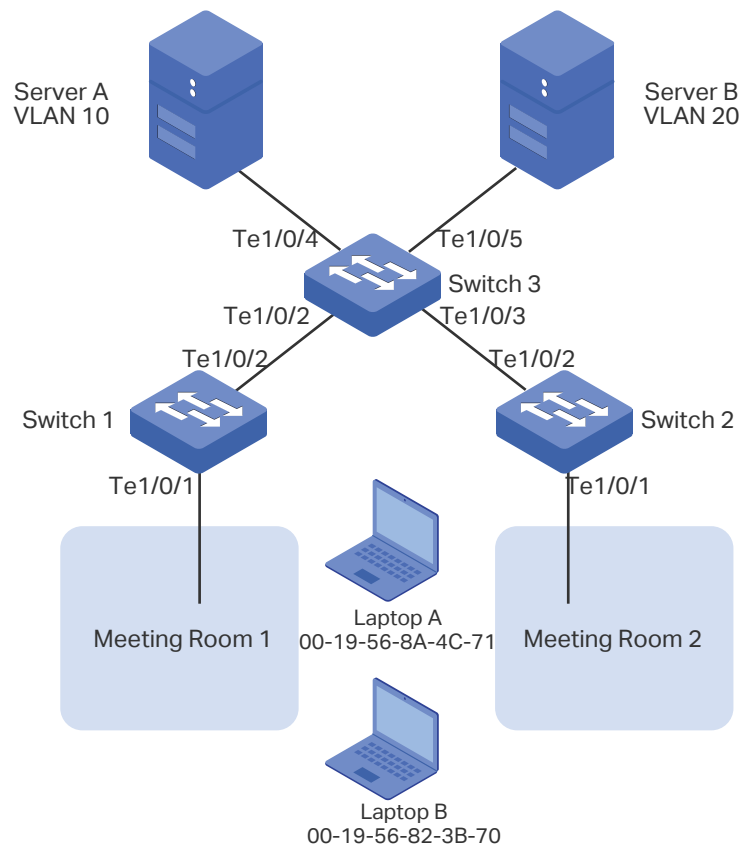

## 3.2 Configuration Scheme

You can configure MAC VLAN to meet this requirement. On Switch 1 and Switch 2, bind the MAC addresses of the laptops to the corresponding VLANs respectively. In this way, each laptop can access only the server in the VLAN it joins, no matter which meeting room the laptops are being used in. The overview of the configuration is as follows:

- 1) Create VLAN 10 and VLAN 20 on each of the three switches, set different port types, and add the ports to the VLANs based on the network topology. Note: For the ports

connecting the laptops, set the port type as Untagged; for the ports connecting to other switch, set the port type as Tagged.

- 2) On Switch 1 and Switch 2, bind the MAC addresses of the laptops to their corresponding VLANs, and enable MAC VLAN for the ports.

Demonstrated with T1700X-16TS, the following sections provide configuration procedure in two ways: using the GUI and using the CLI.

### 3.3 Using the GUI

#### ■ Configurations for Switch 1 and Switch 2

The configurations of Switch 1 and Switch 2 are similar. The following introductions take Switch 1 as an example.

- 1) Choose the menu **VLAN > 802.1Q VLAN > VLAN Config** and click **Create** to load the following page. Create VLAN 10, and add port 1/0/1 as untagged port and port 1/0/2 as tagged ports to VLAN 10. Click **Apply**.

Figure 3-2 VLAN Configuration

The screenshot displays the 'VLAN Info' configuration page. The 'VLAN ID' is set to 10 (range 2-4094) and the 'Name' is 'Department-A' (16 characters maximum). Below this, there are two sections for port configuration:

- Untagged port:** UNIT: 1 LAGS. Port 1 is selected (highlighted in red).
- Tagged port:** UNIT: 1 LAGS. Port 2 is selected (highlighted in red).

Buttons for 'All', 'Clear', 'Apply', and 'Help' are visible at the bottom of the port configuration sections. A legend at the bottom indicates that a white box represents an 'Unselected Port(s)', a blue box represents a 'Selected Port(s)', and a grey box represents a 'Not Available for Selection'.

- 2) Choose the menu **VLAN > 802.1Q VLAN > VLAN Config** and click **Create** to load the following page. Create VLAN 20, and add port 1/0/1 as untagged port and port 1/0/2 as tagged ports to VLAN 20. Click **Apply**.

Figure 3-3 VLAN Configuration

**VLAN Info**

VLAN ID:  (2 - 4094)

Name:  (16 characters maximum)

---

**Untagged port**

UNIT:  LAGS

|                          |                          |                          |                          |                          |                          |                          |                          |
|--------------------------|--------------------------|--------------------------|--------------------------|--------------------------|--------------------------|--------------------------|--------------------------|
| <input type="checkbox"/> | <input type="checkbox"/> | <input type="checkbox"/> | <input type="checkbox"/> | <input type="checkbox"/> | <input type="checkbox"/> | <input type="checkbox"/> | <input type="checkbox"/> |
| <input type="checkbox"/> | <input type="checkbox"/> | <input type="checkbox"/> | <input type="checkbox"/> | <input type="checkbox"/> | <input type="checkbox"/> | <input type="checkbox"/> | <input type="checkbox"/> |
| <input type="checkbox"/> | <input type="checkbox"/> | <input type="checkbox"/> | <input type="checkbox"/> | <input type="checkbox"/> | <input type="checkbox"/> | <input type="checkbox"/> | <input type="checkbox"/> |

---

**Tagged port**

UNIT:  LAGS

|                          |                          |                          |                          |                          |                          |                          |                          |
|--------------------------|--------------------------|--------------------------|--------------------------|--------------------------|--------------------------|--------------------------|--------------------------|
| <input type="checkbox"/> | <input type="checkbox"/> | <input type="checkbox"/> | <input type="checkbox"/> | <input type="checkbox"/> | <input type="checkbox"/> | <input type="checkbox"/> | <input type="checkbox"/> |
| <input type="checkbox"/> | <input type="checkbox"/> | <input type="checkbox"/> | <input type="checkbox"/> | <input type="checkbox"/> | <input type="checkbox"/> | <input type="checkbox"/> | <input type="checkbox"/> |
| <input type="checkbox"/> | <input type="checkbox"/> | <input type="checkbox"/> | <input type="checkbox"/> | <input type="checkbox"/> | <input type="checkbox"/> | <input type="checkbox"/> | <input type="checkbox"/> |

Unselected Port(s)   
  Selected Port(s)   
  Not Available for Selection

- Choose the menu **VLAN > MAC VLAN > MAC VLAN** to load the following page. Enter **MAC Address, Description, VLAN ID** and click **Create** to bind the MAC address of Laptop A to VLAN 10 and bind the MAC address of Laptop B to VLAN 20.

Figure 3-4 MAC VLAN Configuration

**Create MAC VLAN**

MAC Address:  (Format: 00-00-00-00-00-01)

Description:  (8 characters maximum)

VLAN ID:  (1-4094)

---

**MAC VLAN Table**

| Select                   | MAC Address                                    | Description | VLAN ID | Operation            |
|--------------------------|------------------------------------------------|-------------|---------|----------------------|
| <input type="checkbox"/> | <input type="text" value="00-19-56-82-3b-70"/> | PCB         | 20      | <a href="#">Edit</a> |

- Choose the menu **VLAN > MAC VLAN > Port Enable** to load the following page. Select port 1/0/1 and click **Apply** to enable MAC VLAN for it.

Figure 3-5 Enable MAC VLAN for the Port

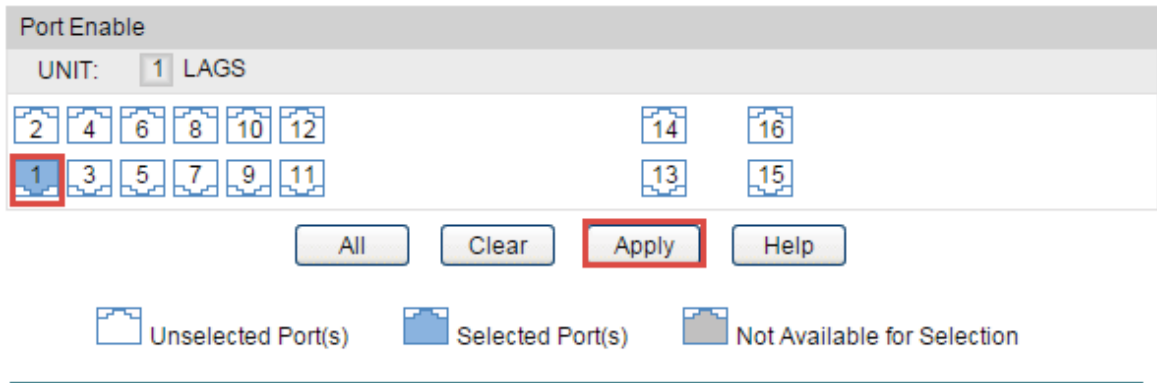

5) Click **Save Config** to save the settings.

■ Configurations for Switch 3

1) Choose the menu **VLAN > 802.1Q VLAN > VLAN Config** and click **Create** to load the following page. Create VLAN 10, and add port 1/0/4 as untagged port and ports 1/0/2-3 as tagged ports to VLAN 10. Click **Apply**.

Figure 3-6 VLAN Configuration

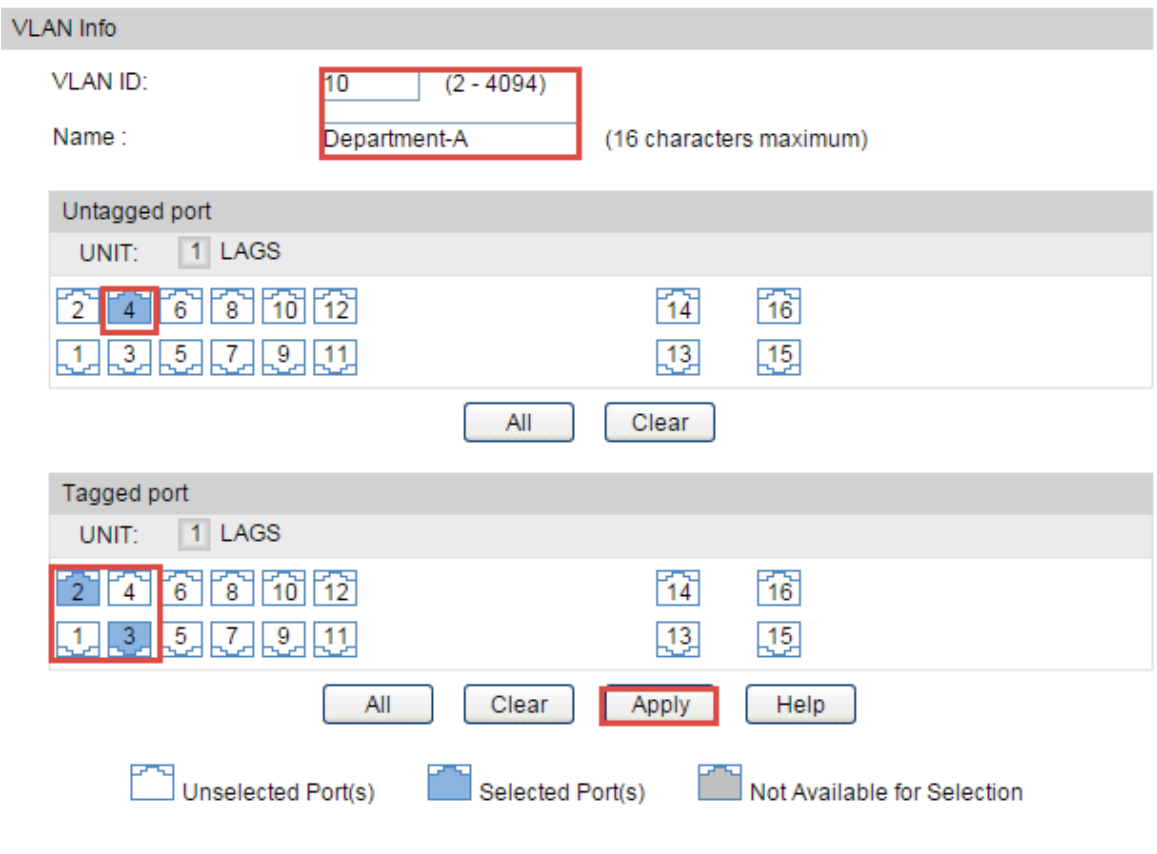

1) Click **Create** to load the following page. Create VLAN 20, and add port 1/0/5 as untagged port and ports 1/0/2-3 as tagged ports to VLAN 20. Click **Apply**.



Figure 3-7 802.1Q VLAN Configuration

**VLAN Info**

VLAN ID:  (2 - 4094)

Name:  (16 characters maximum)

**Untagged port**

UNIT:  LAGS

|                          |                          |                                                         |                          |                          |                          |                          |                          |
|--------------------------|--------------------------|---------------------------------------------------------|--------------------------|--------------------------|--------------------------|--------------------------|--------------------------|
| <input type="checkbox"/> | <input type="checkbox"/> | <input type="checkbox"/>                                | <input type="checkbox"/> | <input type="checkbox"/> | <input type="checkbox"/> | <input type="checkbox"/> | <input type="checkbox"/> |
| 2                        | 4                        | 6                                                       | 8                        | 10                       | 12                       | 14                       | 16                       |
| <input type="checkbox"/> | <input type="checkbox"/> | <input style="border: 1px solid red;" type="checkbox"/> | <input type="checkbox"/> | <input type="checkbox"/> | <input type="checkbox"/> | <input type="checkbox"/> | <input type="checkbox"/> |
| 1                        | 3                        | 5                                                       | 7                        | 9                        | 11                       | 13                       | 15                       |

**Tagged port**

UNIT:  LAGS

|                                                         |                                                         |                          |                          |                          |                          |                          |                          |
|---------------------------------------------------------|---------------------------------------------------------|--------------------------|--------------------------|--------------------------|--------------------------|--------------------------|--------------------------|
| <input style="border: 1px solid red;" type="checkbox"/> | <input style="border: 1px solid red;" type="checkbox"/> | <input type="checkbox"/> | <input type="checkbox"/> | <input type="checkbox"/> | <input type="checkbox"/> | <input type="checkbox"/> | <input type="checkbox"/> |
| 2                                                       | 4                                                       | 6                        | 8                        | 10                       | 12                       | 14                       | 16                       |
| <input style="border: 1px solid red;" type="checkbox"/> | <input style="border: 1px solid red;" type="checkbox"/> | <input type="checkbox"/> | <input type="checkbox"/> | <input type="checkbox"/> | <input type="checkbox"/> | <input type="checkbox"/> | <input type="checkbox"/> |
| 1                                                       | 3                                                       | 5                        | 7                        | 9                        | 11                       | 13                       | 15                       |

Unselected Port(s)

Selected Port(s)

Not Available for Selection

- 2) Click **Save Config** to save the settings.

## 3.4 Using the CLI

### ■ Configurations for Switch 1 and Switch 2

The configurations of Switch 1 and Switch 2 are the same. The following introductions take Switch 1 as an example.

- 1) Create VLAN 10 for Department A and create VLAN 20 for Department B.

```
Switch_1#configure
Switch_1(config)#vlan 10
Switch_1(config-vlan)#name deptA
Switch_1(config-vlan)#exit
Switch_1(config)#vlan 20
Switch_1(config-vlan)#name deptB
Switch_1(config-vlan)#exit
```

- 2) Set 1/0/2 as tagged port, and add it to both VLAN 10 and VLAN 20.

```
Switch_1(config)#interface ten-gigabitEthernet 1/0/2
```

```
Switch_1(config-if)#switchport general allowed vlan 10,20 tagged
```

```
Switch_1(config-if)#exit
```

- 3) Set port 1/0/1 as untagged port, and add it to both VLAN 10 and VLAN 20. Then enable MAC VLAN for port 1/0/1.

```
Switch_1(config)#interface ten-gigabitEthernet 1/0/1
```

```
Switch_1(config-if)#switchport general allowed vlan 10,20 untagged
```

```
Switch_1(config-if)#mac-vlan
```

```
Switch_1(config-if)#exit
```

- 4) Bind the MAC address of Laptop A to VLAN 10 and bind the MAC address of Laptop B to VLAN 20.

```
Switch_1(config)#mac-vlan mac-address 00:19:56:8A:4C:71 vlan 10 description PCA
```

```
Switch_1(config)#mac-vlan mac-address 00:19:56:82:3B:70 vlan 20 description PCB
```

```
Switch_1(config)#end
```

```
Switch_1#copy running-config startup-config
```

#### ■ Configurations for Switch 3

- 1) Create VLAN 10 for Department A and create VLAN 20 for Department B.

```
Switch_3#configure
```

```
Switch_3(config)#vlan 10
```

```
Switch_3(config-vlan)#name deptA
```

```
Switch_3(config-vlan)#exit
```

```
Switch_3(config)#vlan 20
```

```
Switch_3(config-vlan)#name deptB
```

```
Switch_3(config-vlan)#exit
```

- 2) Set port 1/0/2 and port 1/0/3 as tagged ports, and add them to both VLAN 10 and VLAN 20.

```
Switch_3(config)#interface ten-gigabitEthernet 1/0/2
```

```
Switch_3(config-if)#switchport general allowed vlan 10,20 tagged
```

```
Switch_3(config-if)#exit
```

```
Switch_3(config)#interface ten-gigabitEthernet 1/0/3
```

```
Switch_3(config-if)#switchport general allowed vlan 10,20 tagged
```

```
Switch_3(config-if)#exit
```

- 3) Set port 1/0/4 and port 1/0/5 as untagged ports, and respectively add them to VLAN 10 and VLAN 20.

```
Switch_3(config)#interface ten-gigabitEthernet 1/0/4
Switch_3(config-if)#switchport general allowed vlan 10 untagged
Switch_3(config-if)#exit
Switch_3(config)#interface ten-gigabitEthernet 1/0/5
Switch_3(config-if)#switchport general allowed vlan 20 untagged
Switch_3(config-if)#end
Switch_3#copy running-config startup-config
```

### Verify the Configurations

#### Switch 1

```
Switch_1#show mac-vlan all
```

| MAC Address       | Description | VLAN |
|-------------------|-------------|------|
| 00:19:56:8A:4C:71 | PCA         | 10   |
| 00:19:56:82:3B:70 | PCB         | 20   |

#### Switch 2

```
Switch_2#show mac-vlan all
```

| MAC Address       | Description | VLAN |
|-------------------|-------------|------|
| 00:19:56:8A:4C:71 | PCA         | 10   |
| 00:19:56:82:3B:70 | PCB         | 20   |

#### Switch 3

```
Switch_3#show vlan
```

| VLAN | Name         | Status | Ports                                                                     |
|------|--------------|--------|---------------------------------------------------------------------------|
| 1    | Default VLAN | active | Te1/0/1, Te1/0/2, Te1/0/3, Te1/0/4,<br>Te1/0/5, Te1/0/6, Te1/0/7, Te1/0/8 |

|    |       |        |                           |
|----|-------|--------|---------------------------|
|    |       |        | .....                     |
| 10 | DeptA | active | Te1/0/2, Te1/0/3, Te1/0/4 |
| 20 | DeptB | active | Te1/0/2, Te1/0/3, Te1/0/5 |

# 4 Appendix: Default Parameters

Default settings of MAC VLAN are listed in the following table.

Table 4-1 Default Settings of MAC VLAN

| Parameter   | Default Setting |
|-------------|-----------------|
| MAC Address | None            |
| Description | None            |
| VLAN ID     | None            |
| Port Enable | Disable         |

# Part 9

## Configuring Protocol VLAN

### CHAPTERS

1. Overview
2. Protocol VLAN Configuration
3. Configuration Example
4. Appendix: Default Parameters

# 1 Overview

Protocol VLAN is a technology that divides VLANs based on the network layer protocol. With the protocol VLAN rule configured on the basis of the existing 802.1Q VLAN, the switch can analyze special fields of received packets, encapsulate the packets in specific formats, and forward the packets of different protocols to the corresponding VLANs. Since different applications and services use different protocols, network administrators can use protocol VLAN to manage the network based on specific applications and services of network users.

The figure below shows a common application scenario of protocol VLAN. With protocol VLAN configured, Switch 2 can forward IPv4 and IPv6 packets from different VLANs to the IPv4 and IPv6 networks respectively.

Figure 1-1 Common Application Scenario of Protocol VLAN

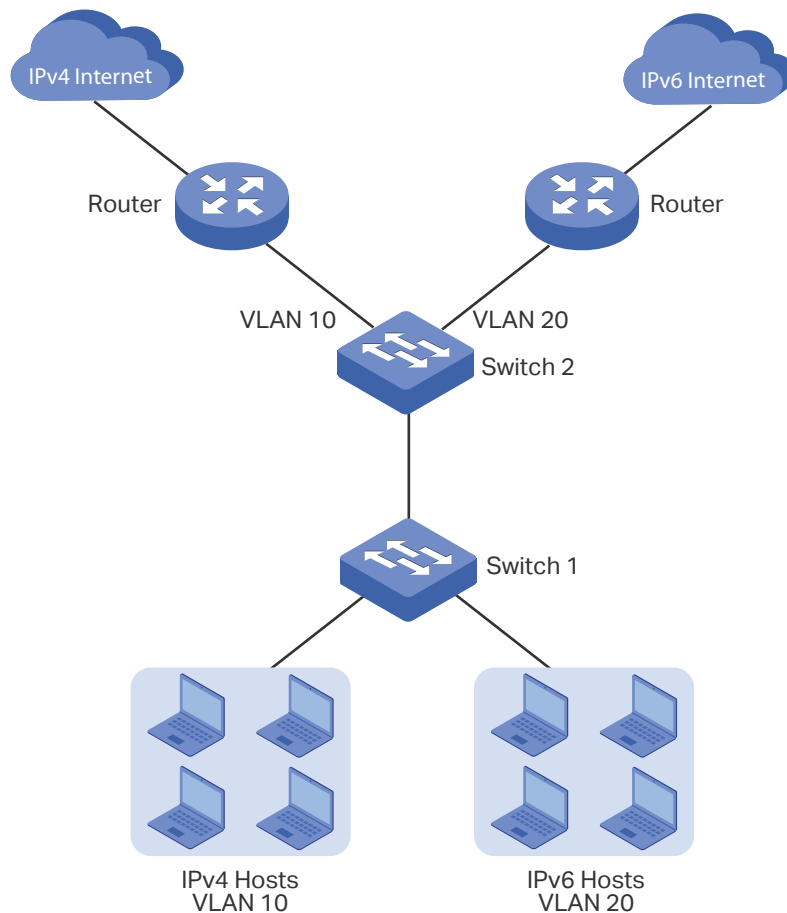

# 2 Protocol VLAN Configuration

To complete protocol VLAN configuration, follow these steps:

- 1) Configure 802.1Q VLAN, including creating a VLAN and setting the port type.
- 2) Create protocol template.
- 3) Configure Protocol VLAN.

## Configuration Guidelines

- You can use the IP, ARP, RARP, and other protocol templates provided by TP-Link switches, or create new protocol templates.
- In a protocol VLAN, when a port receives an untagged data packet, the switch will first search for the protocol VLAN matching the protocol type value of the packet. (If MAC VLAN is also configured, the switch will first process MAC VLAN.) If there is a match, the switch will insert the corresponding VLAN tag to the data packet and forward it within the VLAN. Otherwise, the switch will forward the data packet to the default VLAN based on the PVID (Port VLAN ID) of the receiving port. When the port receives a tagged data packet, the switch will directly process the data packet according to the processing rule of the 802.1 Q VLAN.

## 2.1 Using the GUI

### 2.1.1 Configuring 802.1Q VLAN

Before configuring protocol VLAN, create an 802.1Q VLAN and set the port type according to network requirements. For details, refer to [Configuring 802.1Q VLAN](#).



## 2.1.2 Creating Protocol Template

Choose the menu **VLAN > Protocol VLAN > Protocol Template** to load the following page.

Figure 2-1 Create a Protocol Template

**Create Protocol Template**

Protocol Name:  (8 characters maximum)

Frame Type:

Ether Type:  (4 Hex integers,0600-FFFF)

**Protocol Template Table**

| Select                   | ID | Protocol Name | Protocol type               |
|--------------------------|----|---------------|-----------------------------|
| <input type="checkbox"/> | 1  | IP            | Ethernet II ether-type 0800 |
| <input type="checkbox"/> | 2  | ARP           | Ethernet II ether-type 0806 |
| <input type="checkbox"/> | 3  | RARP          | Ethernet II ether-type 8035 |
| <input type="checkbox"/> | 4  | IPX           | SNAP ether-type 8137        |
| <input type="checkbox"/> | 5  | AT            | SNAP ether-type 809B        |

Follow these steps to create a protocol template:

- 1) Check whether your desired template already exists in the **Protocol Template Table** section. If not, create it in the **Create Protocol Template** section.

|                      |                                                                                                                                                                                     |
|----------------------|-------------------------------------------------------------------------------------------------------------------------------------------------------------------------------------|
| <b>Protocol Name</b> | Enter the name of the new protocol template.                                                                                                                                        |
| <b>Frame Type</b>    | Select the frame type of the new protocol template.                                                                                                                                 |
| <b>Ether Type</b>    | Enter the Ethernet protocol type value for the protocol template.<br><br>This value is the EtherType field in the Ethernet frame and is used to specify the data type of the frame. |

- 2) Click **Create** to create the protocol template.

 **Note:**

A protocol template that is bound to a VLAN cannot be deleted.

## 2.1.3 Configuring Protocol VLAN

Choose the menu **VLAN > Protocol VLAN > Protocol Group** to load the following page.

Figure 2-2 Configure the Protocol Group

**Protocol Group Config**

Protocol Name:  ▼

VLAN ID:  (1-4094)

---

**Protocol Group Member**

UNIT:  LAGS

|   |   |   |   |    |    |    |    |
|---|---|---|---|----|----|----|----|
| 2 | 4 | 6 | 8 | 10 | 12 | 14 | 16 |
| 1 | 3 | 5 | 7 | 9  | 11 | 13 | 15 |

Unselected Port(s)

Selected Port(s)

Not Available for Selection

Follow these steps to configure the protocol group:

- 1) In the **Protocol Group Config** section, select the protocol name and enter the VLAN ID to bind the protocol type to the VLAN.

|               |                           |
|---------------|---------------------------|
| Protocol Name | Select the protocol type. |
|---------------|---------------------------|

|         |                                                                   |
|---------|-------------------------------------------------------------------|
| VLAN ID | Enter the ID of the 802.1Q VLAN to be bound to the protocol type. |
|---------|-------------------------------------------------------------------|

- 2) In the **Protocol Group Member** section, select the port or LAG to add to the protocol group.
- 3) Click **Apply**.

**Note:**

The member port of an LAG (Link Aggregation Group) follows the configuration of the LAG but not its own. The configurations of the port can take effect only after it leaves the LAG.

## 2.2 Using the CLI

### 2.2.1 Configuring 802.1Q VLAN

Before configuring protocol VLAN, create an 802.1Q VLAN and set the port type according to network requirements. For details, refer to [Configuring 802.1Q VLAN](#).

## 2.2.2 Creating a Protocol Template

Follow these steps to create a protocol template:

|        |                                                                                                                                                                                                                                                                                                                                                                                                                                                                                                                                                                                      |
|--------|--------------------------------------------------------------------------------------------------------------------------------------------------------------------------------------------------------------------------------------------------------------------------------------------------------------------------------------------------------------------------------------------------------------------------------------------------------------------------------------------------------------------------------------------------------------------------------------|
| Step 1 | <b>configure</b><br>Enter global configuration mode.                                                                                                                                                                                                                                                                                                                                                                                                                                                                                                                                 |
| Step 2 | <b>protocol-vlan template name <i>protocol-name</i> frame { ether_2 ether-type <i>type</i>   snap ether-type <i>type</i>   llc dsap <i>dsap_type</i> ssap <i>ssap_type</i> }</b><br>Create a protocol template.<br><br><i>protocol-name</i> : Specify the protocol name with 1 to 8 characters.<br><br><i>type</i> : Specify the Ethernet protocol type with 4 hexadecimal numbers.<br><br><i>dsap_type</i> : Specify the destination service access point with 2 hexadecimal numbers.<br><br><i>ssap_type</i> : Specify the source service access point with 2 hexadecimal numbers. |
| Step 3 | <b>show protocol-vlan template</b><br>Verify the protocol templates.                                                                                                                                                                                                                                                                                                                                                                                                                                                                                                                 |
| Step 4 | <b>end</b><br>Return to Privileged EXEC Mode.                                                                                                                                                                                                                                                                                                                                                                                                                                                                                                                                        |
| Step 5 | <b>copy running-config startup-config</b><br>Save the settings in the configuration file.                                                                                                                                                                                                                                                                                                                                                                                                                                                                                            |

The following example shows how to create an IPv6 protocol template:

**Switch#configure**

**Switch(config)#protocol template name IPv6 frame ether\_2 ether-type 86dd**

**Switch(config)#show protocol-vlan template**

| Index | Protocol Name | Protocol Type              |
|-------|---------------|----------------------------|
| ----- | -----         | -----                      |
| 1     | IP            | EthernetII ether-type 0800 |
| 2     | ARP           | EthernetII ether-type 0806 |
| 3     | RARP          | EthernetII ether-type 8035 |
| 4     | IPX           | SNAP ether-type 8137       |
| 5     | AT            | SNAP ether-type 809B       |
| 6     | IPv6          | EthernetII ether-type 86DD |

**Switch(config)#end**

**Switch#copy running-config startup-config**

## 2.2.3 Configuring Protocol VLAN

Follow these steps to configure protocol VLAN:

|        |                                                                                                                                                                                                                                                                                  |
|--------|----------------------------------------------------------------------------------------------------------------------------------------------------------------------------------------------------------------------------------------------------------------------------------|
| Step 1 | <b>configure</b><br>Enter global configuration mode.                                                                                                                                                                                                                             |
| Step 2 | <b>show protocol-vlan template</b><br>Check the index of each protocol template.                                                                                                                                                                                                 |
| Step 3 | <b>protocol-vlan vlan <i>vid</i> template <i>index</i></b><br>Bind the protocol template to the VLAN.<br><br><i>vid</i> : ID of the 802.1Q VLAN where the port with protocol VLAN enabled is.<br><br><i>index</i> : Protocol template index.                                     |
| Step 4 | <b>interface { fastEthernet <i>port</i>   range fastEthernet <i>port-list</i>   gigabitEthernet <i>port</i>   range gigabitEthernet <i>port-list</i>   ten-gigabitEthernet <i>port</i>   range ten-gigabitEthernet <i>port-list</i> }</b><br>Enter interface configuration mode. |
| Step 5 | <b>show protocol-vlan vlan</b><br>Check the protocol VLAN index (entry-id) of each protocol group.                                                                                                                                                                               |
| Step 6 | <b>protocol-vlan group <i>entry-id</i></b><br>Add the specified port to the protocol group.<br><br><i>entry-id</i> : Protocol VLAN index.                                                                                                                                        |
| Step 7 | <b>end</b><br>Return to Privileged EXEC Mode.                                                                                                                                                                                                                                    |
| Step 8 | <b>copy running-config startup-config</b><br>Save the settings in the configuration file.                                                                                                                                                                                        |

The following example shows how to bind the IPv6 protocol template to VLAN 10:

**Switch#configure**

**Switch(config)#show protocol-vlan template**

| Index | Protocol Name | Protocol Type              |
|-------|---------------|----------------------------|
| 1     | IP            | EthernetII ether-type 0800 |
| 2     | ARP           | EthernetII ether-type 0806 |
| 3     | RARP          | EthernetII ether-type 8035 |

```

4      IPX          SNAP    ether-type 8137
5      AT           SNAP    ether-type 809B
6      IPv6        EthernetII ether-type 86DD

```

```
Switch(config)#protocol-vlan vlan 10 template 6
```

```
Switch(config)#end
```

```
Switch#copy running-config startup-config
```

The following example shows how to add port 1/0/2 to the IPv6 protocol group:

```
Switch#configure
```

```
Switch(config)#interface ten-gigabitEthernet 1/0/2
```

```
Switch(config-if)#show protocol-vlan vlan
```

| Index | Protocol-Name | VID | Member |
|-------|---------------|-----|--------|
| 1     | IPv6          | 10  |        |

```
Switch(config-if)#protocol-vlan group 1
```

```
Switch(config-if)#show protocol-vlan vlan
```

| Index | Protocol-Name | VID | Member  |
|-------|---------------|-----|---------|
| 1     | IPv6          | 10  | Te1/0/2 |

```
Switch(config-if)#end
```

```
Switch#copy running-config startup-config
```

# 3 Configuration Example

## 3.1 Network Requirements

A company uses both IPv4 and IPv6 hosts, and these hosts access the IPv4 network and IPv6 network respectively via different routers. It is required that IPv4 packets are forwarded to the IPv4 network, IPv6 packets are forwarded to the IPv6 network, and other packets are dropped.

The figure below shows the network topology. The IPv4 host belongs to VLAN 10, the IPv6 host belongs to VLAN 20, and these hosts access the network via Switch 1. Switch 2 is connected to two routers to access the IPv4 network and IPv6 network respectively. The routers belong to VLAN 10 and VLAN 20 respectively.

Figure 3-1 Network Topology

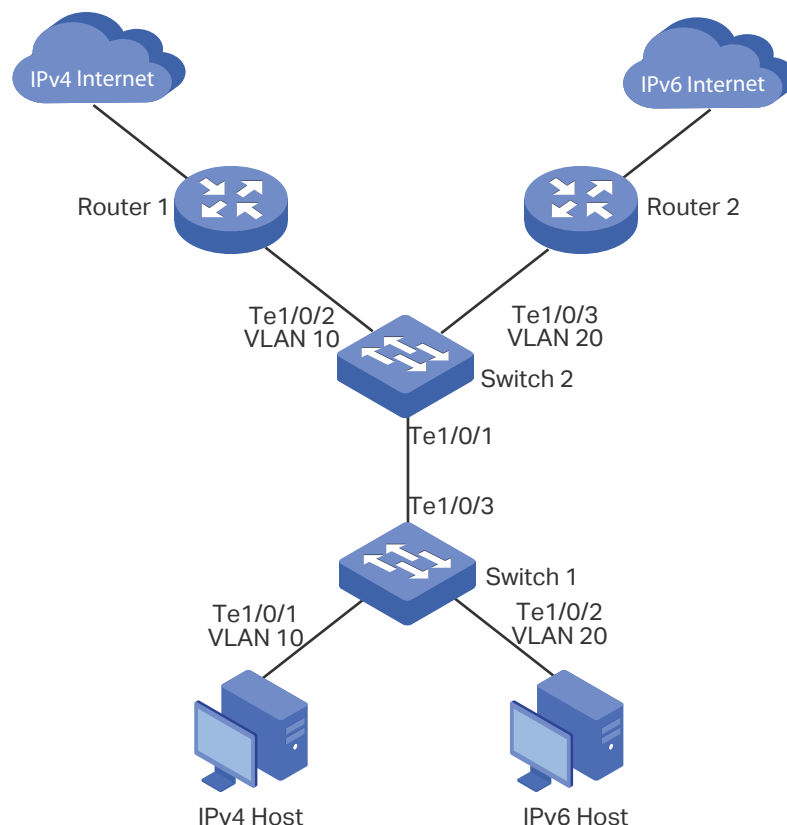

## 3.2 Configuration Scheme

You can configure protocol VLAN on port 1/0/1 of Switch 2 to meet this requirement. When this port receives packets, Switch 2 will forward them to the corresponding VLANs according to their protocol types. The overview of the configuration on Switch 2 is as follows:

- 1) Create VLAN 10 and VLAN 20, set the port type, and add each port to the corresponding VLAN.
- 2) Use the IPv4 protocol template provided by the switch, and create the IPv6 protocol template.
- 3) Bind the protocol templates to the corresponding VLANs to form protocol groups, and add port 1/0/1 to the groups.

For Switch 1, configure 802.1Q VLAN according to the network topology.

Demonstrated with T1700X-16TS, this chapter provides configuration procedures in two ways: using the GUI and using the CLI.

### 3.3 Using the GUI

#### ■ Configurations for Switch 1

- 1) Choose the menu **VLAN > 802.1Q VLAN > VLAN Config** and click **Create** to load the following page. Create VLAN 10, and add port 1/0/1 and port 1/0/3 as untagged ports to VLAN 10. Click **Apply**.

Figure 3-2 Create VLAN 10

The screenshot shows the 'VLAN Info' configuration page. The 'VLAN ID' field contains '10' and the 'Name' field contains 'IPv4'. Below this is the 'Untagged port' section, which includes a 'UNIT' dropdown set to '1' and a 'LAGS' dropdown. A grid of port selection buttons (1-16) is shown, with ports 1 and 3 highlighted in blue. Below the grid are 'All' and 'Clear' buttons. The 'Tagged port' section is also visible, with a similar grid of port selection buttons. At the bottom, there are 'All', 'Clear', 'Apply', and 'Help' buttons. A legend at the bottom indicates that a white box represents an 'Unselected Port(s)', a blue box represents a 'Selected Port(s)', and a grey box represents a 'Not Available for Selection'.

- 2) Click **Create** to load the following page. Create VLAN 20, and add ports 1/0/2-3 as untagged ports to VLAN 20. Click **Apply**.

Figure 3-3 Create VLAN 20

**VLAN Info**

VLAN ID:  (2 - 4094)

Name:  (16 characters maximum)

**Untagged port**

UNIT:  LAGS

|                                       |                                       |                            |                            |                             |                             |                             |                             |
|---------------------------------------|---------------------------------------|----------------------------|----------------------------|-----------------------------|-----------------------------|-----------------------------|-----------------------------|
| <input checked="" type="checkbox"/> 2 | <input checked="" type="checkbox"/> 4 | <input type="checkbox"/> 6 | <input type="checkbox"/> 8 | <input type="checkbox"/> 10 | <input type="checkbox"/> 12 | <input type="checkbox"/> 14 | <input type="checkbox"/> 16 |
| <input checked="" type="checkbox"/> 1 | <input checked="" type="checkbox"/> 3 | <input type="checkbox"/> 5 | <input type="checkbox"/> 7 | <input type="checkbox"/> 9  | <input type="checkbox"/> 11 | <input type="checkbox"/> 13 | <input type="checkbox"/> 15 |

**Tagged port**

UNIT:  LAGS

|                            |                            |                            |                            |                             |                             |                             |                             |
|----------------------------|----------------------------|----------------------------|----------------------------|-----------------------------|-----------------------------|-----------------------------|-----------------------------|
| <input type="checkbox"/> 2 | <input type="checkbox"/> 4 | <input type="checkbox"/> 6 | <input type="checkbox"/> 8 | <input type="checkbox"/> 10 | <input type="checkbox"/> 12 | <input type="checkbox"/> 14 | <input type="checkbox"/> 16 |
| <input type="checkbox"/> 1 | <input type="checkbox"/> 3 | <input type="checkbox"/> 5 | <input type="checkbox"/> 7 | <input type="checkbox"/> 9  | <input type="checkbox"/> 11 | <input type="checkbox"/> 13 | <input type="checkbox"/> 15 |

Unselected Port(s)     Selected Port(s)     Not Available for Selection

3) Click **Save Config** to save the settings.

▪ **Configurations for Switch 2**

1) Choose the menu **VLAN > 802.1Q VLAN > VLAN Config** and click **Create** to load the following page. Create VLAN 10, and add port 1/0/1 as tagged port and port 1/0/2 as untagged port to VLAN 10. Click **Apply**.



Figure 3-4 Create VLAN 10

**VLAN Info**

VLAN ID:  (2 - 4094)

Name:  (16 characters maximum)

**Untagged port**

UNIT:  LAGS

|                            |                            |                            |                            |                             |                             |                             |                             |
|----------------------------|----------------------------|----------------------------|----------------------------|-----------------------------|-----------------------------|-----------------------------|-----------------------------|
| <input type="checkbox"/> 2 | <input type="checkbox"/> 4 | <input type="checkbox"/> 6 | <input type="checkbox"/> 8 | <input type="checkbox"/> 10 | <input type="checkbox"/> 12 | <input type="checkbox"/> 14 | <input type="checkbox"/> 16 |
| <input type="checkbox"/> 1 | <input type="checkbox"/> 3 | <input type="checkbox"/> 5 | <input type="checkbox"/> 7 | <input type="checkbox"/> 9  | <input type="checkbox"/> 11 | <input type="checkbox"/> 13 | <input type="checkbox"/> 15 |

**Tagged port**

UNIT:  LAGS

|                            |                            |                            |                            |                             |                             |                             |                             |
|----------------------------|----------------------------|----------------------------|----------------------------|-----------------------------|-----------------------------|-----------------------------|-----------------------------|
| <input type="checkbox"/> 2 | <input type="checkbox"/> 4 | <input type="checkbox"/> 6 | <input type="checkbox"/> 8 | <input type="checkbox"/> 10 | <input type="checkbox"/> 12 | <input type="checkbox"/> 14 | <input type="checkbox"/> 16 |
| <input type="checkbox"/> 1 | <input type="checkbox"/> 3 | <input type="checkbox"/> 5 | <input type="checkbox"/> 7 | <input type="checkbox"/> 9  | <input type="checkbox"/> 11 | <input type="checkbox"/> 13 | <input type="checkbox"/> 15 |

|                                             |                                                      |                                                      |
|---------------------------------------------|------------------------------------------------------|------------------------------------------------------|
| <input type="checkbox"/> Unselected Port(s) | <input checked="" type="checkbox"/> Selected Port(s) | <input type="checkbox"/> Not Available for Selection |
|---------------------------------------------|------------------------------------------------------|------------------------------------------------------|

- 2) Click **Create** to load the following page. Create VLAN 20, and add port 1/0/1 as tagged port and port 1/0/3 as untagged port to VLAN 20. Click **Apply**.

Figure 3-5 Create VLAN 20

**VLAN Info**

VLAN ID:  (2 - 4094)

Name:  (16 characters maximum)

---

**Untagged port**

UNIT:  LAGS

|                          |                                     |                          |                          |                          |                          |                          |                          |
|--------------------------|-------------------------------------|--------------------------|--------------------------|--------------------------|--------------------------|--------------------------|--------------------------|
| <input type="checkbox"/> | <input type="checkbox"/>            | <input type="checkbox"/> | <input type="checkbox"/> | <input type="checkbox"/> | <input type="checkbox"/> | <input type="checkbox"/> | <input type="checkbox"/> |
| 2                        | 4                                   | 6                        | 8                        | 10                       | 12                       | 14                       | 16                       |
| <input type="checkbox"/> | <input checked="" type="checkbox"/> | <input type="checkbox"/> | <input type="checkbox"/> | <input type="checkbox"/> | <input type="checkbox"/> | <input type="checkbox"/> | <input type="checkbox"/> |
| 1                        | 3                                   | 5                        | 7                        | 9                        | 11                       | 13                       | 15                       |

---

**Tagged port**

UNIT:  LAGS

|                                     |                          |                          |                          |                          |                          |                          |                          |
|-------------------------------------|--------------------------|--------------------------|--------------------------|--------------------------|--------------------------|--------------------------|--------------------------|
| <input type="checkbox"/>            | <input type="checkbox"/> | <input type="checkbox"/> | <input type="checkbox"/> | <input type="checkbox"/> | <input type="checkbox"/> | <input type="checkbox"/> | <input type="checkbox"/> |
| 2                                   | 4                        | 6                        | 8                        | 10                       | 12                       | 14                       | 16                       |
| <input checked="" type="checkbox"/> | <input type="checkbox"/> | <input type="checkbox"/> | <input type="checkbox"/> | <input type="checkbox"/> | <input type="checkbox"/> | <input type="checkbox"/> | <input type="checkbox"/> |
| 1                                   | 3                        | 5                        | 7                        | 9                        | 11                       | 13                       | 15                       |

Unselected Port(s)   
  Selected Port(s)   
  Not Available for Selection

- Choose the menu **VLAN > Protocol VLAN > Protocol Template** to load the following page. Enter **IPv6** in the protocol name, select the **Ethernet II** frame type, enter **86DD** in the Ether Type field, and click **Create** to create the IPv6 protocol template.

*Tips:* The IPv4 protocol template is already provided by the switch, you only need to create the IPv6 protocol template.

Figure 3-6 Create the IPv6 Protocol Template

**Create Protocol Template**

Protocol Name:  (8 characters maximum)

Frame Type:

Ether Type:  (4 Hex integers,0600-FFFF)

---

**Protocol Template Table**

| Select                   | ID | Protocol Name | Protocol type               |
|--------------------------|----|---------------|-----------------------------|
| <input type="checkbox"/> | 1  | IP            | Ethernet II ether-type 0800 |
| <input type="checkbox"/> | 2  | ARP           | Ethernet II ether-type 0806 |
| <input type="checkbox"/> | 3  | RARP          | Ethernet II ether-type 8035 |
| <input type="checkbox"/> | 4  | IPX           | SNAP ether-type 8137        |
| <input type="checkbox"/> | 5  | AT            | SNAP ether-type 809B        |

- 4) Choose the menu **VLAN > Protocol VLAN > Protocol Group** to load the following page. Select the IP protocol name (that is the IPv4 protocol template), enter VLAN ID 10, select port 1, and click **Apply**. Select the IPv6 protocol name, enter VLAN ID 20, select port 1, and click **Apply**.

Figure 3-7 Configure the IPv4 Protocol Group

**Protocol Group Config**

Protocol Name: IP ▼

VLAN ID: 10 (1-4094)

---

**Protocol Group Member**

UNIT: 1 LAGS

|   |   |   |   |    |    |    |    |
|---|---|---|---|----|----|----|----|
| 2 | 4 | 6 | 8 | 10 | 12 | 14 | 16 |
| 1 | 3 | 5 | 7 | 9  | 11 | 13 | 15 |

All
Clear
Apply
Help

Unselected Port(s)
  Selected Port(s)
  Not Available for Selection

Figure 3-8 Configure the IPv6 Protocol Group

**Protocol Group Config**

Protocol Name: IPv6 ▼

VLAN ID: 20 (1-4094)

---

**Protocol Group Member**

UNIT: 1 LAGS

|   |   |   |   |    |    |    |    |
|---|---|---|---|----|----|----|----|
| 2 | 4 | 6 | 8 | 10 | 12 | 14 | 16 |
| 1 | 3 | 5 | 7 | 9  | 11 | 13 | 15 |

All
Clear
Apply
Help

Unselected Port(s)
  Selected Port(s)
  Not Available for Selection

- 5) Choose the menu **VLAN > Protocol VLAN > Protocol Group Table** to load the following page. Here you can view the protocol VLAN configuration.

Figure 3-9 Protocol VLAN configuration

| Protocol Group Table     |               |         |        |                      |
|--------------------------|---------------|---------|--------|----------------------|
| Select                   | Protocol Name | VLAN ID | Member | Operate              |
| <input type="checkbox"/> | IPv6          | 20      | 1/0/1  | <a href="#">Edit</a> |
| <input type="checkbox"/> | IP            | 10      | 1/0/1  | <a href="#">Edit</a> |

- 6) Click **Save Config** to save the settings.

## 3.4 Using the CLI

### ■ Configurations for Switch 1

- 1) Create VLAN 10 and VLAN 20.

```
Switch_1#configure
Switch_1(config)#vlan 10
Switch_1(config-vlan)#name IPv4
Switch_1(config-vlan)#exit
Switch_1(config)#vlan 20
Switch_1(config-vlan)#name IPv6
Switch_1(config-vlan)#exit
```

- 2) Set port 1/0/3 as untagged port, and add it to both VLAN 10 and VLAN 20.

```
Switch_1(config)#interface ten-gigabitEthernet 1/0/3
Switch_1(config-if)#switchport general allowed vlan 10,20 untagged
Switch_1(config-if)#exit
```

- 3) Set port 1/0/1 and port 1/0/2 as untagged ports, and add them to VLAN 10 and VLAN 20 respectively.

```
Switch_1(config)#interface ten-gigabitEthernet 1/0/1
Switch_1(config-if)#switchport general allowed vlan 10 untagged
Switch_1(config-if)#exit
Switch_1(config)#interface ten-gigabitEthernet 1/0/2
Switch_1(config-if)#switchport general allowed vlan 20 untagged
Switch_1(config-if)#exit
Switch_1(config)#end
```

```
Switch_1#copy running-config startup-config
```

- Configurations for Switch 2

- 1) Create VLAN 10 and VLAN 20.

```
Switch_2#configure
```

```
Switch_2(config)#vlan 10
```

```
Switch_2(config-vlan)#name IPv4
```

```
Switch_2(config-vlan)#exit
```

```
Switch_2(config)#vlan 20
```

```
Switch_2(config-vlan)#name IPv6
```

```
Switch_2(config-vlan)#exit
```

- 2) Set port 1/0/1 as tagged port, and add it to both VLAN 10 and VLAN 20.

```
Switch_2(config)#interface ten-gigabitEthernet 1/0/1
```

```
Switch_2(config-if)#switchport general allowed vlan 10,20 tagged
```

```
Switch_2(config-if)#exit
```

- 3) Set port 1/0/2 and port 1/0/3 as untagged ports, and add them to VLAN 10 and VLAN 20 respectively.

```
Switch_2(config)#interface ten-gigabitEthernet 1/0/2
```

```
Switch_2(config-if)#switchport general allowed vlan 10 untagged
```

```
Switch_2(config-if)#exit
```

```
Switch_2(config)#interface ten-gigabitEthernet 1/0/3
```

```
Switch_2(config-if)#switchport general allowed vlan 20 untagged
```

```
Switch_2(config-if)#exit
```

- 4) Create the IPv6 protocol template.

```
Switch_2(config)#protocol-vlan template name IPv6 frame ether_2 ether-type 86dd
```

```
Switch_2(config)#show protocol-vlan template
```

| Index | Protocol Name | Protocol Type              |
|-------|---------------|----------------------------|
| ----  | -----         | -----                      |
| 1     | IP            | EthernetII ether-type 0800 |
| 2     | ARP           | EthernetII ether-type 0806 |
| 3     | RARP          | EthernetII ether-type 8035 |
| 4     | IPX           | SNAP ether-type 8137       |

```

5      AT          SNAP    ether-type 809b
6      IPv6        Ethernet II ether-type 86dd

```

- 5) Configure the protocol groups.

```
Switch_2(config)#protocol-vlan vlan 10 template 1
```

```
Switch_2(config)#protocol-vlan vlan 20 template 6
```

- 6) Add port 1/0/1 to the protocol groups.

```
Switch_2(config)#show protocol-vlan vlan
```

| Index | Protocol-Name | VID | Member |
|-------|---------------|-----|--------|
| 1     | IP            | 10  |        |
| 2     | IPv6          | 20  |        |

```
Switch_2(config)#interface ten-gigabitEthernet 1/0/1
```

```
Switch_2(config-if)#protocol-vlan group 1
```

```
Switch_2(config-if)#protocol-vlan group 2
```

```
Switch_2(config-if)#exit
```

```
Switch_2(config)#end
```

```
Switch_2#copy running-config startup-config
```

## Verify the Configurations

### Switch 1

Verify 802.1Q VLAN configuration:

```
Switch_1#show vlan
```

| VLAN | Name        | Status | Ports                                                                              |
|------|-------------|--------|------------------------------------------------------------------------------------|
| 1    | System-VLAN | active | Te1/0/3, Te1/0/4, Te1/0/5, Te1/0/6<br>Te1/0/7, Te1/0/8, Te1/0/9, Te1/0/10<br>..... |
| 10   | IPv4        | active | Te1/0/1, Te1/0/3                                                                   |
| 20   | IPv6        | active | Te1/0/2, Te1/0/3                                                                   |

### Switch 2

Verify 802.1Q VLAN configuration:

```
Switch_2#show vlan
```

| VLAN | Name        | Status | Ports                                                                              |
|------|-------------|--------|------------------------------------------------------------------------------------|
| 1    | System-VLAN | active | Te1/0/1, Te1/0/4, Te1/0/5, Te1/0/6<br>Te1/0/7, Te1/0/8, Te1/0/9, Te1/0/10<br>..... |
| 10   | IPv4        | active | Te1/0/1, Te1/0/2                                                                   |
| 20   | IPv6        | active | Te1/0/1, Te1/0/3                                                                   |

Verify protocol group configuration:

```
Switch_2#show protocol-vlan vlan
```

| Index | Protocol-Name | VID | Member  |
|-------|---------------|-----|---------|
| 1     | IP            | 10  | Te1/0/1 |
| 2     | IPv6          | 20  | Te1/0/1 |

# 4 Appendix: Default Parameters

Default settings of Protocol VLAN are listed in the following table.

Table 4-1 Default Settings of Protocol VLAN

| Parameter               | Default Setting |      |                             |
|-------------------------|-----------------|------|-----------------------------|
| Protocol Template Table | 1               | IP   | Ethernet II ether-type 0800 |
|                         | 2               | ARP  | Ethernet II ether-type 0806 |
|                         | 3               | RARP | Ethernet II ether-type 8035 |
|                         | 4               | IPX  | SNAP ether-type 8137        |
|                         | 5               | AT   | SNAP ether-type 809B        |



# Part 10

## Configuring Private VLAN

### CHAPTERS

1. Overview
2. Private VLAN Configurations
3. Configuration Example
4. Appendix: Default Parameters

# 1 Overview

Common large networks such as ISP networks generally isolate users by VLAN. However, with the increasing number of users, upper-layer devices have to create large amount of VLANs to manage all the users. According to IEEE 802.1Q protocol, each upper-layer device can create no more than 4094 VLANs, which means upper-layer devices in backbone networks will face shortage of VLANs. By creating primary VLAN and secondary VLAN, private VLAN is an effective solution to this problem.

Based on 802.1Q VLAN, private VLAN pairs a secondary VLAN with a primary VLAN. A primary VLAN can pair with more than one secondary VLAN to compose several private VLANs. In a private VLAN, Layer 2 isolation can be achieved between end users with secondary VLANs, while upper-layer devices only need to recognize primary VLANs, which solves the problem of VLAN shortage. Meanwhile, private VLAN resolves the conflicts triggered when users' need of VLANs is different from what the ISP can provide.

The network models of traditional VLAN and private VLAN are shown in Figure 1-1 and Figure 1-2 respectively. In the network model of traditional VLAN, isolation between users is achieved by creating VLAN2, VLAN3 and VLAN4. In this case, the upper-layer device, Switch A, needs to recognize 3 VLANs including VLAN2, VLAN3 and VLAN4.

Figure 1-1 Topology of Traditional VLAN

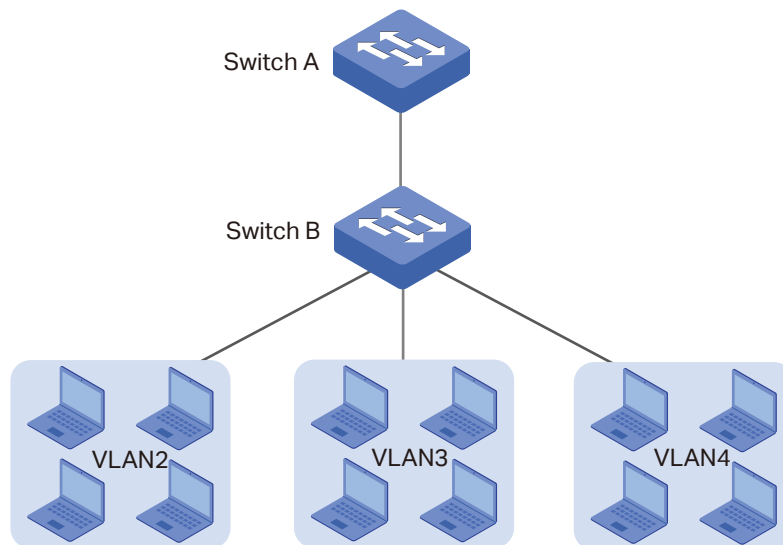

If private VLAN is configured on Switch B, Switch A only needs to recognize primary VLAN, VLAN5; and end users can be isolated by secondary VLANs, VLAN2, VLAN3 and VLAN4, saving VLAN resources for Switch A.

Figure 1-2 Topology of Private VLAN

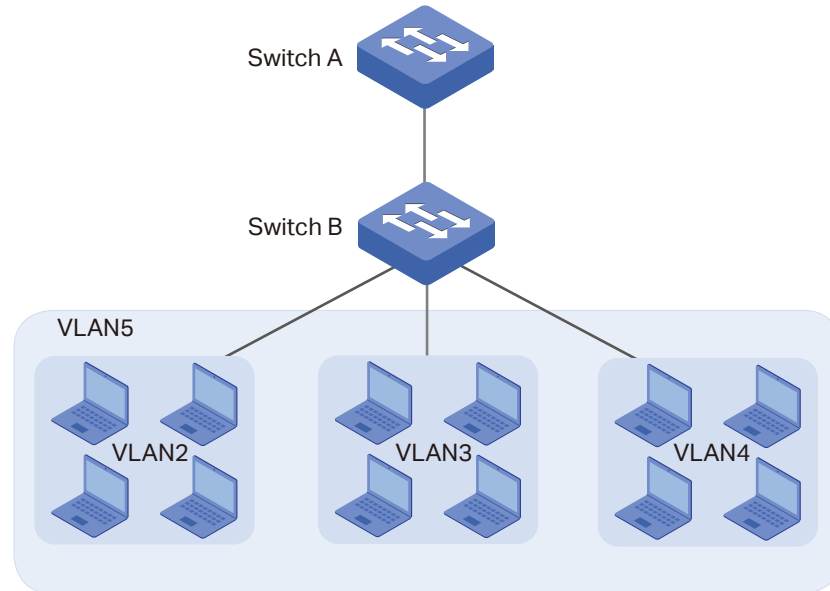

# 2 Private VLAN Configurations

With private VLAN configuration, you can:

- 1) Create Private VLAN
- 2) Configure Private VLAN on Ports

## 2.1 Using the GUI

### 2.1.1 Creating Private VLAN

Choose the menu **VLAN > Private VLAN > PVLAN Config** to load the following page.

Figure 2-1 PVLAN Config

**Create Private VLAN**

Primary VLAN:  (2-4094)

Secondary VLAN:  (Format:2,4-5,8) Create

Secondary VLAN Type: Community ▼

---

**Search Option**

Search Option: All ▼  Search

---

**Private VLAN Table**

| Select                        | Primary VLAN | Secondary VLAN | VLAN Type | Port |
|-------------------------------|--------------|----------------|-----------|------|
| <b>No entry in the table.</b> |              |                |           |      |

All
Delete
Help

- 1) In **Create Private VLAN** section, enter the IDs of Primary VLAN and Secondary VLAN, and select Secondary VLAN Type as you need.

**Primary VLAN** Enter an ID for Primary VLAN. A primary VLAN can pair with more than one secondary VLAN to compose several private VLANs.

**Secondary VLAN** Enter an ID or an ID list for Secondary VLAN. A secondary VLAN can pair with only one primary VLAN to compose one private VLAN. To avoid long response time of the switch, you are recommended to create less than 10 secondary VLANs at a time.

Secondary VLAN Type

Select the Secondary VLAN Type.

**Isolated VLAN:** Select this option and users in different isolated VLANs cannot communicate with each other.

**Community VLAN:** Select this option and users in different community VLANs can communicate with each other.

2) Click **Create**.

## 2.1.2 Configuring the Up-link Port

The switch requires that only access port can be added to a private VLAN.

Choose the menu **VLAN > Private VLAN > Port Config** to load the following page.

Figure 2-2 Port Config (Configuring the Up-link Port)

**Port Config**

Port selected:   (Format: 1/0/1)

Port Type:

Primary VLAN:  (2-4094)

Secondary VLAN:  (2-4094)

UNIT:  LAGS

Unselected Port(s)   
  Selected Port(s)   
  Not Available for Selection

**Private VLAN Port Table**

UNIT:

| Port ID                       | Port Type | Operation |
|-------------------------------|-----------|-----------|
| <b>No entry in the table.</b> |           |           |

1) In the **Port Config** section, select the port to be configured, set the Port Type as Promiscuous, and enter the IDs of Primary VLAN and Secondary VLAN.

Port selected

Specify the port to be configured.

Port Type

Configure the Port Type to be Promiscuous.

The port type of up-link port in a primary VLAN must be Promiscuous. This type of port is used to connect upper-layer devices or connect the switch with other switches. The PVID of this port is its primary VLAN ID.

Primary VLAN

Specify the ID of the primary VLAN to add the port to the primary VLAN.

**Secondary VLAN** Specify the ID of the secondary VLAN to add the port to the secondary VLAN.

2) Click **Apply**.

 **Note:**

When configuring the up-link port, you only need to add the port to one private VLAN and set the port type as Promiscuous. The switch will automatically add the port to private VLANs with the same primary VLAN.

### 2.1.3 Configuring the Down-link Port

The switch requires that only access port can be added to a private VLAN.

Choose the menu **VLAN > Private VLAN > Port Config** to load the following page.

Figure 2-3 Port Config (Configuring the Down-link Port)

**Port Config**

Port selected:   (Format: 1/0/1)

Port Type:

Primary VLAN:

Secondary VLAN:

UNIT:  LAGS

|                            |                            |                            |                            |                             |                             |                             |                             |
|----------------------------|----------------------------|----------------------------|----------------------------|-----------------------------|-----------------------------|-----------------------------|-----------------------------|
| <input type="checkbox"/> 2 | <input type="checkbox"/> 4 | <input type="checkbox"/> 6 | <input type="checkbox"/> 8 | <input type="checkbox"/> 10 | <input type="checkbox"/> 12 | <input type="checkbox"/> 14 | <input type="checkbox"/> 16 |
| <input type="checkbox"/> 1 | <input type="checkbox"/> 3 | <input type="checkbox"/> 5 | <input type="checkbox"/> 7 | <input type="checkbox"/> 9  | <input type="checkbox"/> 11 | <input type="checkbox"/> 13 | <input type="checkbox"/> 15 |

Unselected Port(s)     Selected Port(s)     Not Available for Selection

**Private VLAN Port Table**

UNIT:

| Port ID                       | Port Type | Operation |
|-------------------------------|-----------|-----------|
| <b>No entry in the table.</b> |           |           |

1) In the **Port Config** section, select the port to be configured, set the Port Type as Host, and enter the IDs of Primary VLAN and Secondary VLAN.

**Port selected** Specify the port to be configured.

**Port Type** Configure the Port Type to be Host.

The port type of down-link port in a secondary VLAN must be Host. This type of port is used to connect to end users and shield information from upper-layer devices. The PVID of this port is its secondary VLAN ID.

|                |                                                                             |
|----------------|-----------------------------------------------------------------------------|
| Primary VLAN   | Specify the ID of the primary VLAN to add the port to the primary VLAN.     |
| Secondary VLAN | Specify the ID of the secondary VLAN to add the port to the secondary VLAN. |

2) Click **Apply**.

## 2.2 Using the CLI

### 2.2.1 Creating Private VLAN

#### Note:

If you need to create a private VLAN with existing VLANs, delete all member ports of the existing VLANs before creating the private VLAN.

|        |                                                                                                                                                                                                                                                                     |
|--------|---------------------------------------------------------------------------------------------------------------------------------------------------------------------------------------------------------------------------------------------------------------------|
| Step 1 | <b>configure</b><br>Enter global configuration mode.                                                                                                                                                                                                                |
| Step 2 | <b>vlan <i>vlan-list</i></b><br>Specify Primary VLAN ID, and enter VLAN configuration mode.<br><br><i>vlan-list</i> : Specify the ID or the ID list of the VLAN(s) for configuration. The ID ranges from 2 to 4094, for example, 2-3,5.                             |
| Step 3 | <b>private-vlan primary</b><br>Specify the VLAN to be the primary VLAN.                                                                                                                                                                                             |
| Step 4 | <b>exit</b><br>Exit VLAN configuration mode.                                                                                                                                                                                                                        |
| Step 5 | <b>vlan <i>vlan-list</i></b><br>Specify Primary VLAN ID, and enter VLAN configuration mode.<br><br><i>vlan-list</i> : Specify the ID or the ID list of the VLAN(s) for configuration. The ID ranges from 2 to 4094, for example, 2-3,5.                             |
| Step 6 | <b>private-vlan { community   isolated }</b><br>Specify the VLAN to be the secondary VLAN, and configure the secondary VLAN type.<br><br><i>community</i> : Set the secondary VLAN type as Community.<br><i>isolated</i> : Set the secondary VLAN type as Isolated. |
| Step 7 | <b>exit</b><br>Exit VLAN configuration mode.                                                                                                                                                                                                                        |

|         |                                                                                                                                                                                                                                                                                                                                                                   |
|---------|-------------------------------------------------------------------------------------------------------------------------------------------------------------------------------------------------------------------------------------------------------------------------------------------------------------------------------------------------------------------|
| Step 8  | <b>vlan <i>vlan-id</i></b><br>Specify the primary VLAN ID, and enter VLAN configuration mode.                                                                                                                                                                                                                                                                     |
| Step 9  | <b>private-vlan association <i>vlan-list</i></b><br>Specify the ID or the ID list of the secondary VLAN(s) to pair with this primary VLAN. To avoid long response time of the switch, you are recommended to pair less than 10 secondary VLANs with the primary VLAN at a time.<br><br><i>vlan-list</i> : Specify the ID or the ID list of the secondary VLAN(s). |
| Step 10 | <b>show vlan private-vlan</b><br>Verify configurations of private VLAN.                                                                                                                                                                                                                                                                                           |
| Step 11 | <b>end</b><br>Return to Privileged EXEC Mode.                                                                                                                                                                                                                                                                                                                     |
| Step 12 | <b>copy running-config startup-config</b><br>Save the settings in the configuration file.                                                                                                                                                                                                                                                                         |

The following example shows how to create primary VLAN 6 and secondary VLAN 5, set the secondary VLAN type as community, and pair primary VLAN 6 with secondary VLAN 5 as a private VLAN.

**Switch#config**

**Switch(config)#vlan 6**

**Switch(config-vlan)#private-vlan primary**

**Switch(config-vlan)#exit**

**Switch(config)#vlan 5**

**Switch(config-vlan)#private-vlan community**

**Switch(config-vlan)#exit**

**Switch(config)#vlan 6**

**Switch(config-vlan)#private-vlan association 5**

**Switch(config-vlan)#exit**

**Switch(config)#show vlan private-vlan**

| Primary | Secondary | Type      | Ports |
|---------|-----------|-----------|-------|
| -----   | -----     | -----     | ----- |
| 6       | 5         | Community |       |

**Switch(config)#end**

**Switch#copy running-config startup-config**



## 2.2.2 Configuring the Up-link Port

The switch requires that only access port can be added to a private VLAN.

|        |                                                                                                                                                                                                                                                                                                                                                                                                                                |
|--------|--------------------------------------------------------------------------------------------------------------------------------------------------------------------------------------------------------------------------------------------------------------------------------------------------------------------------------------------------------------------------------------------------------------------------------|
| Step 1 | <b>configure</b><br>Enter global configuration mode.                                                                                                                                                                                                                                                                                                                                                                           |
| Step 2 | <b>interface { fastEthernet <i>port</i>   range fastEthernet <i>port-list</i>   gigabitEthernet <i>port</i>   range gigabitEthernet <i>port-list</i>   ten-gigabitEthernet <i>port</i>   range ten-gigabitEthernet <i>port-list</i> }</b><br>Enter interface configuration mode.<br><br><i>port</i> : Specify the port to be configured.<br><i>port-list</i> : Specify the ID or the ID list of the port(s) for configuration. |
| Step 3 | <b>switchport private-vlan promiscuous</b><br>Configure the port type as Promiscuous.                                                                                                                                                                                                                                                                                                                                          |
| Step 4 | <b>switchport private-vlan mapping <i>primary-vlan-id</i> <i>secondary-vlan-id</i></b><br>Add the specified port(s) to the private VLAN.<br><br><i>primary-vlan-id</i> : Specify the ID of the primary VLAN. The ID ranges from 2 to 4094.<br><i>secondary-vlan-id</i> : Specify the ID of the secondary VLAN. The ID ranges from 2 to 4094.                                                                                   |
| Step 5 | <b>show vlan private-vlan</b><br>Verify configurations of private VLAN.                                                                                                                                                                                                                                                                                                                                                        |
| Step 6 | <b>show vlan private-vlan interface [gigabitEthernet <i>port</i>   ten-gigabitEthernet <i>port</i>   port-channel <i>port-channel-id</i>]</b><br>Verify private VLAN configurations of ports.<br><br><i>port</i> : Specify the port ID.<br><i>port-channel-id</i> : Specify the port-channel ID.                                                                                                                               |
| Step 7 | <b>end</b><br>Return to Privileged EXEC Mode.                                                                                                                                                                                                                                                                                                                                                                                  |
| Step 8 | <b>copy running-config startup-config</b><br>Save the settings in the configuration file.                                                                                                                                                                                                                                                                                                                                      |

### Note:

When configuring the up-link port, you only need to add the port to one private VLAN and set the port type as Promiscuous. The switch will automatically add the port to private VLANs with the same primary VLAN.

The following example shows how to configure the port type of port 1/0/2 as Promiscuous, and add it to the private VLAN composed of primary VLAN 6 and secondary VLAN 5.

### Switch#config

```

Switch(config)#interface ten-gigabitEthernet 1/0/2
Switch(config-if)#switchport private-vlan promiscuous
Switch(config-if)#switchport private-vlan mapping 6 5
Switch(config-if)#exit
Switch(config)#show vlan private-vlan
Primary  Secondary  Type           Ports
-----  -
6        5             Community     Te1/0/2
Switch(config)#show vlan private-vlan interface ten-gigabitEthernet 1/0/2
Port      type
-----  -
Te1/0/2   Promiscuous
Switch(config)#end
Switch#copy running-config startup-config

```

### 2.2.3 Configuring the Down-link Port

The switch requires that only access port can be added to a private VLAN.

|        |                                                                                                                                                                                                                                                                                                                                                                                                                                                             |
|--------|-------------------------------------------------------------------------------------------------------------------------------------------------------------------------------------------------------------------------------------------------------------------------------------------------------------------------------------------------------------------------------------------------------------------------------------------------------------|
| Step 1 | <p><b>configure</b></p> <p>Enter global configuration mode.</p>                                                                                                                                                                                                                                                                                                                                                                                             |
| Step 2 | <p><b>interface { fastEthernet <i>port</i>   range fastEthernet <i>port-list</i>   gigabitEthernet <i>port</i>   range gigabitEthernet <i>port-list</i>   ten-gigabitEthernet <i>port</i>   range ten-gigabitEthernet <i>port-list</i> }</b></p> <p>Enter interface configuration mode.</p> <p><i>port</i>: Specify the port to be configured.</p> <p><i>port-list</i>: Specify the ID or the ID list of the port(s) for configuration.</p>                 |
| Step 3 | <p><b>switchport private-vlan host</b></p> <p>Configure the port type as host.</p>                                                                                                                                                                                                                                                                                                                                                                          |
| Step 4 | <p><b>switchport private-vlan host-association <i>primary-vlan-id secondary-vlan-id vlantype</i></b></p> <p>Add the specified port(s) to the private VLAN.</p> <p><i>primary-vlan-id</i>: Specify the ID of the primary VLAN. The ID ranges from 2 to 4094.</p> <p><i>secondary-vlan-id</i>: Specify the ID of the secondary VLAN. The ID ranges from 2 to 4094.</p> <p><i>vlantype</i>: Specify the secondary VLAN type, either community or isolated.</p> |

---

|        |                                                                                    |
|--------|------------------------------------------------------------------------------------|
| Step 5 | <p><b>show vlan private-vlan</b></p> <p>Verify configurations of private VLAN.</p> |
|--------|------------------------------------------------------------------------------------|

---

|        |                                                                                                                                                                                                                                                                                                               |
|--------|---------------------------------------------------------------------------------------------------------------------------------------------------------------------------------------------------------------------------------------------------------------------------------------------------------------|
| Step 6 | <p><b>show vlan private-vlan interface [gigabitEthernet <i>port</i>   ten-gigabitEthernet <i>port</i>   port-channel <i>port-channel-id</i>]</b></p> <p>Verify private VLAN configurations of ports.</p> <p><i>port</i>: Specify the port ID.</p> <p><i>port-channel-id</i>: Specify the port-channel ID.</p> |
|--------|---------------------------------------------------------------------------------------------------------------------------------------------------------------------------------------------------------------------------------------------------------------------------------------------------------------|

---

|        |                                                          |
|--------|----------------------------------------------------------|
| Step 7 | <p><b>end</b></p> <p>Return to Privileged EXEC Mode.</p> |
|--------|----------------------------------------------------------|

---

|        |                                                                                                      |
|--------|------------------------------------------------------------------------------------------------------|
| Step 8 | <p><b>copy running-config startup-config</b></p> <p>Save the settings in the configuration file.</p> |
|--------|------------------------------------------------------------------------------------------------------|

---

The following example shows how to configure the port type of port 1/0/3 as Host, and add it to the private VLAN composed of primary VLAN 6 and secondary VLAN 5.

**Switch#config**

**Switch(config)#interface ten-gigabitEthernet 1/0/3**

**Switch(config-if)#switchport private-vlan host**

**Switch(config-if)#switchport private-vlan host-association 6 5 community**

**Switch(config-if)#exit**

**Switch(config)#show vlan private-vlan**

| Primary | Secondary | Type      | Ports   |
|---------|-----------|-----------|---------|
| -----   | -----     | -----     | -----   |
| 6       | 5         | Community | Te1/0/3 |

**Switch(config)#show vlan private-vlan interface ten-gigabitEthernet 1/0/3**

| Port    | type  |
|---------|-------|
| -----   | ----- |
| Te1/0/3 | Host  |

**Switch(config)#end**

**Switch#copy running-config startup-config**

# 3 Configuration Example

## 3.1 Network Requirements

Usually, an ISP divides its network into subnets to differentiate different areas by using VLAN. Company A belongs to Area VI which is marked as VLAN 6 by the ISP. It is required that departments in Company A can achieve Layer 2 isolation by using VLAN and users in the same department can communicate with each other.

## 3.2 Configuration Scheme

You can create primary VLAN and secondary VLAN and pair them into private VLAN. This allows upper-layer switch to recognize only the primary VLAN instead of all the secondary VLANs. Also, Company A can achieve Layer 2 isolation by using secondary VLAN.

Since it is required that users in the same department can communicate with each other, secondary VLAN type should be configured as Community.

## 3.3 Network Topology

As shown in the following figure, Switch C is the ISP's central switch, and Switch A is in Company A. To meet the requirement, configure private VLAN on Switch A. Exemplified with T1700X-16TS, this chapter provides configuration procedures in two ways: using the GUI and using the CLI.

Figure 3-1 Network Topology

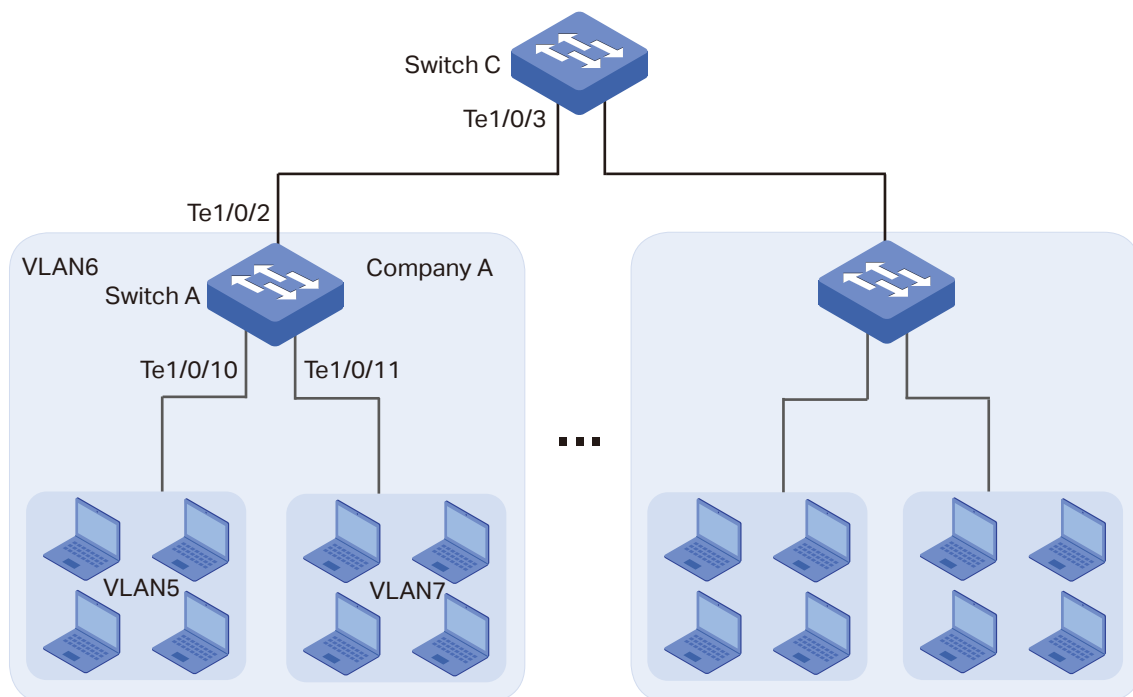

### 3.4 Using the GUI

- Configurations for Switch A

- 1) Creating private VLAN

Choose the menu **VLAN > Private VLAN > PVLAN Config** to load the following page. Create primary VLAN 6 and secondary VLAN 5, select Community as the Secondary VLAN Type, click Create and primary VLAN 6 is paired with secondary VLAN 5. Similarly, create primary VLAN 6 and secondary VLAN 7, select Community as the Secondary VLAN Type, click Create and primary VLAN 6 is paired with secondary VLAN 7.

Figure 3-2 Creating Private VLAN

**Create Private VLAN**

Primary VLAN:  (2-4094)

Secondary VLAN:  (Format:2,4-5,8)

Secondary VLAN Type: Community

---

**Search Option**

Search Option: All

---

**Private VLAN Table**

| Select                   | Primary VLAN | Secondary VLAN | VLAN Type | Port |
|--------------------------|--------------|----------------|-----------|------|
| <input type="checkbox"/> | 6            | 5              | community |      |

2) Add up-link port to the private VLAN and configure the port type

Choose the menu **VLAN > Private VLAN > Port Config** to load the following page. Add port 1/0/2 to primary VLAN 6 and secondary VLAN 5, and select Promiscuous as its port type.

Figure 3-3 Configuring the Up-link Port

**Port Config**

Port selected:  (Format:1/0/1)

Port Type: Promiscuous

Primary VLAN:  (2-4094)

Secondary VLAN:  (2-4094)

---

UNIT: 1 LAGS

2

4

6

8

10

12

1

3

5

7

9

11

14

16

13

15

Unselected Port(s)

Selected Port(s)

Not Available for Selection

---

**Private VLAN Port Table**

UNIT: 1

| Port ID                | Port Type | Operation |
|------------------------|-----------|-----------|
| No entry in the table. |           |           |

### 3) Add down-link port to the private VLAN and configure the port type

Choose the menu **VLAN > Private VLAN > Port Config** to load the following page. Add port 1/0/10 to primary VLAN 6 and secondary VLAN 5, add port 1/0/11 to primary VLAN 6 and secondary VLAN 7, and select Host as their port type.

Figure 3-4 Configuring the Down-link Port

**Port Config**

Port selected:

Port Type:

Primary VLAN:

Secondary VLAN:

(Format:1/0/1)

UNIT:  LAGS

2

4

6

8

10

12

14

16

1

3

5

7

9

11

13

15

Unselected Port(s)

Selected Port(s)

Not Available for Selection

**Private VLAN Port Table**

UNIT:

| Port ID | Port Type   | Operation              |
|---------|-------------|------------------------|
| 1/0/2   | Promiscuous | <a href="#">Remove</a> |
| 1/0/4   | Promiscuous | <a href="#">Remove</a> |
| 1/0/10  | Host        | <a href="#">Remove</a> |

## 3.5 Using the CLI

### ■ Configurations for Switch A

#### 1) Enter global configuration mode

```
Switch_A>enable
```

```
Switch_A#configure
```

#### 2) Create primary VLAN 6 and secondary VLAN 5, and pair them into a private VLAN

```
Switch_A(config)#vlan 6
```

```
Switch_A(config-vlan)#private-vlan primary
```

```
Switch_A(config-vlan)#exit
```

```
Switch_A(config)#vlan 5
```

```
Switch_A(config-vlan)#private-vlan community
```

```
Switch_A(config-vlan)#exit
```

```
Switch_A(config)#vlan 6
```

```
Switch_A(config-vlan)#private-vlan association 5
```

```
Switch_A(config-vlan)#exit
```

- 3) Create secondary VLAN 7, and pair it with primary VLAN 6 into a private VLAN

```
Switch_A(config)#vlan 7
```

```
Switch_A(config-vlan)#private-vlan community
```

```
Switch_A(config-vlan)#exit
```

```
Switch_A(config)#vlan 6
```

```
Switch_A(config-vlan)#private-vlan association 7
```

```
Switch_A(config-vlan)#exit
```

- 4) Add up-link port to the corresponding private VLAN and configure the port type as Promiscuous

```
Switch_A(config)#interface ten-gigabitEthernet 1/0/2
```

```
Switch_A(config-if)#switchport private-vlan promiscuous
```

```
Switch_A(config-if)#switchport private-vlan mapping 6 5
```

```
Switch_A(config-if)#exit
```

- 5) Add down-link port to the corresponding private VLAN and configure the port type as Host

```
Switch_A(config)#interface ten-gigabitEthernet 1/0/10
```

```
Switch_A(config-if)#switchport private-vlan host
```

```
Switch_A(config-if)#switchport private-vlan host-association 6 5 community
```

```
Switch_A(config-if)#exit
```

```
Switch_A(config)#interface ten-gigabitEthernet 1/0/11
```

```
Switch_A(config-if)#switchport private-vlan host
```

```
Switch_A(config-if)#switchport private-vlan host-association 6 7 community
```

```
Switch_A(config-if)#end
```

```
Switch_A#copy running-config startup-config
```



## Verify the Configurations

### Switch A

Verify the configuration of private VLAN:

```
Switch_A(config)#show vlan private-vlan
```

| Primary | Secondary | Type      | Ports          |
|---------|-----------|-----------|----------------|
| -----   | -----     | -----     | -----          |
| 6       | 5         | Community | Te1/0/2,1/0/10 |
| 6       | 7         | Community | Te1/0/2,1/0/11 |

Verify the configuration of ports:

```
Switch_A(config)#show vlan private-vlan interface
```

| Port     | type        |
|----------|-------------|
| -----    | -----       |
| Te1/0/1  | Normal      |
| Te1/0/2  | Promiscuous |
| Te1/0/3  | Normal      |
| Te1/0/4  | Normal      |
| Te1/0/5  | Normal      |
| Te1/0/6  | Normal      |
| Te1/0/7  | Normal      |
| Te1/0/8  | Normal      |
| Te1/0/9  | Normal      |
| Te1/0/10 | Host        |
| Te1/0/11 | Host        |
| Te1/0/12 | Normal      |
| .....    |             |

# 4 Appendix: Default Parameters

Default settings of Private VLAN are listed in the following tables.

Table 4-1 Default Settings of Private VLAN

| Parameter           | Default Setting |
|---------------------|-----------------|
| Primary VLAN        | None            |
| Secondary VLAN      | None            |
| Secondary VLAN Type | Community       |

Table 4-2 Default Settings of Port Configuration

| Parameter      | Default Setting |
|----------------|-----------------|
| Port selected  | None            |
| Port Type      | Promiscuous     |
| Primary VLAN   | None            |
| Secondary VLAN | None            |

# Part 11

## Configuring Spanning Tree

### CHAPTERS

1. Spanning Tree
2. STP/RSTP Configurations
3. MSTP Configurations
4. STP Security Configurations
5. Configuration Example for MSTP
6. Appendix: Default Parameters

# 1 Spanning Tree

## 1.1 Overview

### STP

STP (Spanning Tree Protocol) is a layer 2 Protocol that prevents loops in the network. As is shown in Figure 1-1, STP helps to:

- Block specified ports of the switches to build a loop-free topology.
- Detect topology changes and automatically generate a loop-free topology.

Figure 1-1 STP Function

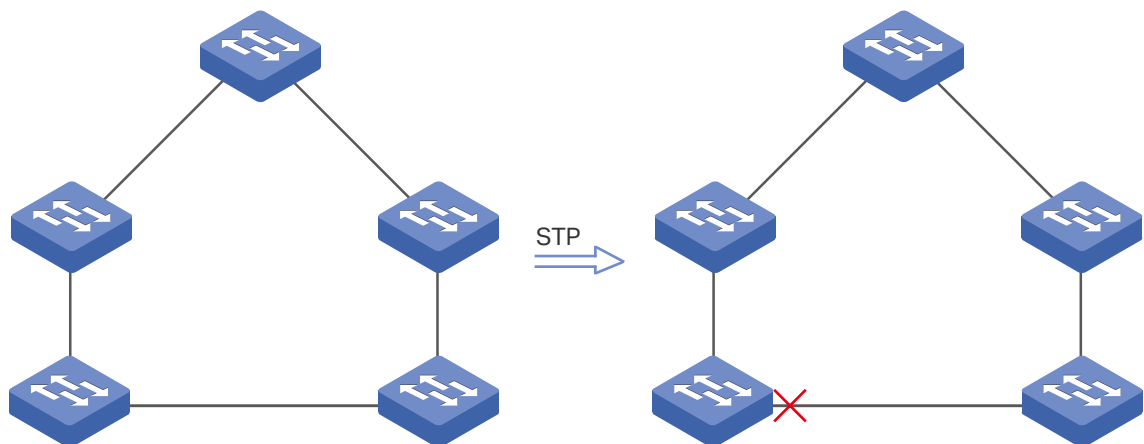

### RSTP

RSTP (Rapid Spanning Tree Protocol) provides the same features as STP. But RSTP also provides much faster spanning tree convergence.

### MSTP

MSTP (Multiple Spanning Tree Protocol) also provides the fast spanning tree convergence as RSTP. In addition, MSTP enables VLANs to be mapped to different spanning trees (MST instances), and traffic in different VLANs will be transmitted along their respective paths, implementing load balancing among VLANs.

## 1.2 Basic Concepts

### 1.2.1 STP/RSTP Concepts

Based on the networking topology, this section will introduce some basic concepts in STP/RSTP.

Figure 1-2 STP/RSTP Topology

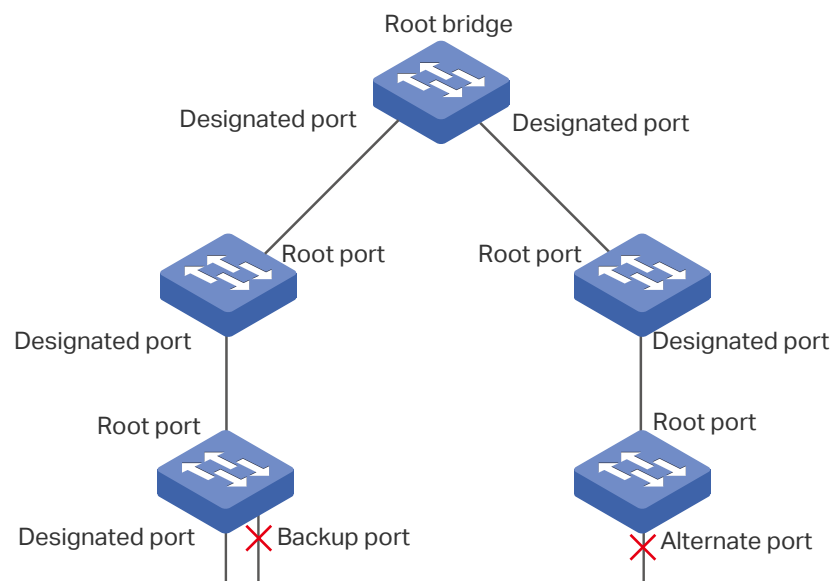

## Root Bridge

The root bridge is the root of a spanning tree. There is only one root bridge in each spanning tree, and the root bridge has the lowest bridge ID.

## Bridge ID

The value of the priority and MAC address of the switch. It is used to select the root bridge. The bridge ID is composed of a 2-byte priority and a 6-byte MAC address. The priority is allowed to be configured manually on the switch, and the switch with the lowest priority value will be elected as the root bridge. If the priority of all the switches are the same, the switch with the lowest MAC address is selected as the root bridge.

## Port Role

- Root Port

The port selected on non-root bridges to provide the lowest root path cost. There is only one root port in each non-root bridge.

- Designated Port

The port selected for each LAN segment to provide the lowest root path cost from that LAN segment to the root bridge.

- Alternate Port

If a port is not selected as the designated port for it receives better BPDUs from another switch, it will become an alternate port.

In RSTP/MSTP, the alternate port is the backup for the root port. It is blocked when the root port works normally. Once the root port fails, the alternate port will become the new root port.

In STP, the alternate port is always blocked.

- Backup Port

If a port is not selected as the designated port for it receives better BPDUs from the switch it belongs to, it will become an backup port.

In RSTP/MSTP, the backup port is the backup for the designated port. It is blocked when the designated port works normally. Once the root port fails, the backup port will become the new designated port.

In STP, the backup port is always blocked.

- Disable Port

The disconnected port with spanning tree function enabled .

## Port Status

Generally, in STP, the port status includes: Blocking, Listening, Learning, Forwarding and Disabled.

- Blocking

In this status, the port receives and sends BPDUs. The other packets are dropped.

- Listening

In this status, the port receives and sends BPDUs. The other packets are dropped.

- Learning

In this status, the port receives and sends BPDUs. It also receives the other user packets to update its MAC address table, but doesn't forward them.

- Forwarding

In this status, the port receives and sends BPDUs. It also receives the other user packets to update its MAC address table, and forwards them.

- Disabled

In this status, the port is not participating in the spanning tree, and drops all the packets it receives.

In RSTP/MSTP, the port status includes: Discarding, Learning and Forwarding. The Discarding status is the grouping of STP's Blocking, Listening and Disabled, and the

Learning and Forwarding status correspond exactly to the Learning and Forwarding status specified in STP.

In TP-Link switches, the port status includes: Blocking, Learning, Forwarding and Disconnected.

- **Blocking**

In this status, the port receives and sends BPDUs. The other packets are dropped.

- **Learning**

In this status, the port receives and sends BPDUs. It also receives the other user packets to update its MAC address table, but doesn't forward them.

- **Forwarding**

In this status, the port receives and sends BPDUs. It also receives the other user packets to update its MAC address table, and forwards them.

- **Disconnected**

In this status, the port is enabled with spanning tree function but not connected to any device.

## Path Cost

The path cost reflects the link speed of the port. The smaller the value, the higher link speed the port has.

The path cost can be manually configured on each port. If not, the path cost values are automatically calculated according to the link speed as shown below:

Table 1-1 The Default Path Cost Value

| Link Speed | Path Cost Value |
|------------|-----------------|
| 10Mb/s     | 2,000,000       |
| 100Mb/s    | 200,000         |
| 1Gb/s      | 2,000           |
| 10Gb/s     | 200             |

## Root Path Cost

The root path cost is the accumulated path costs from the root bridge to the other switches. When root bridge sends its BPDU, the root path cost value is 0. When a connected switch receives this BPDU, it increments the path cost of its local incoming port. Then it forwards this BPDU to the downstream switch, with the updated root path cost. The value of the accumulated root path cost increases as the BPDU propagates further.

## BPDU

The packets used to generate the spanning tree. The BPDUs (Bridge Protocol Data Unit) contain a lot of information, like bridge ID, root path cost, port priority and so on. Switches share these information to help determine the tree topology.

### 1.2.2 MSTP Concepts

MSTP, compatible with STP and RSTP, has the same basic elements used in STP and RSTP. Based on the networking topology, this section will introduce some concepts only exist in MSTP.

Figure 1-3 MSTP Topology

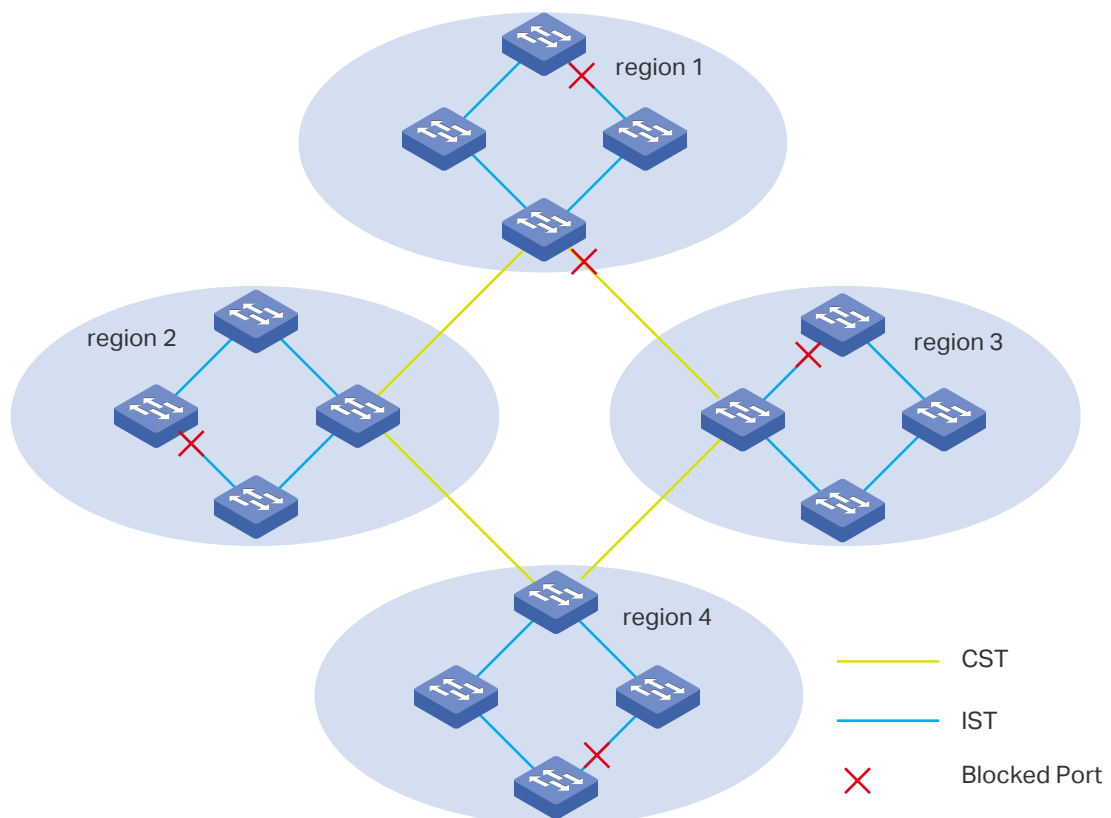

#### MST Region

An MST region consists of multiple interconnected switches. The switches that have the following characteristics are considered as in the same region:

- Same region name
- Same revision level
- Same VLAN-Instance mapping

#### MST Instance

The MST instance is a spanning tree running in the MST region. Multiple MST instances can be established in one MST region and they are independent of each other. As is shown in Figure 1-4, there are three instances in a region, and each instance has its own root bridge.



Figure 1-4 MST Region

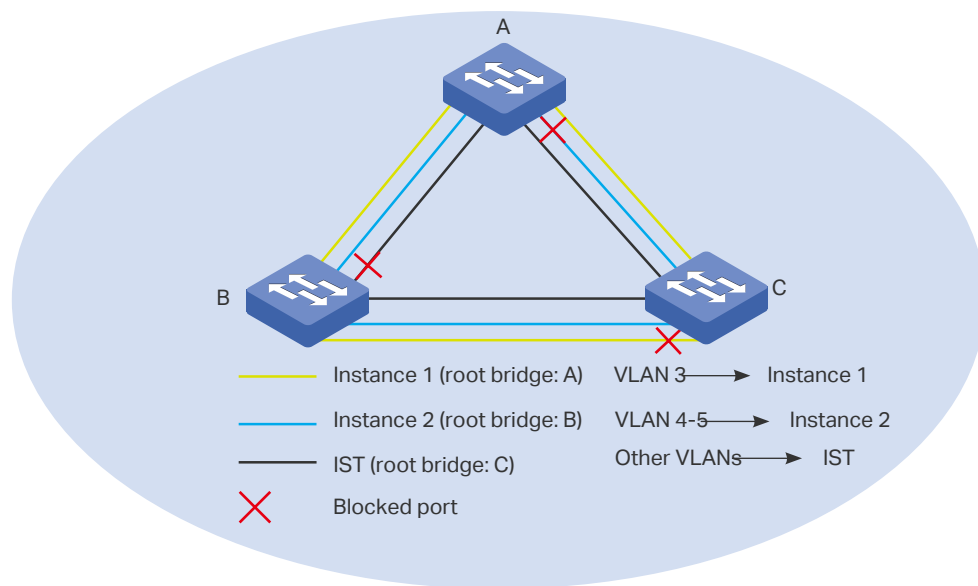

### VLAN-Instance Mapping

VLAN-Instance Mapping describes the mapping relationship between VLANs and instances. Multiple VLANs can be mapped to a same instance, but one VLAN can be mapped to only one instance. As Figure 1-4 shows, VLAN 3 is mapped to instance 1, VLAN 4 and VLAN 5 are mapped to instance 2, the other VLANs are mapped to the IST.

### IST

The Internal Spanning Tree, which is a special MST instance with an instance ID of 0. By default, all the VLANs are mapped to IST.

### CST

The Common Spanning Tree, which is the spanning tree connects all MST regions. As is shown in Figure 1-3, region1-region 4 are connected by the CST.

### CIST

The Common and Internal Spanning Tree, comprising IST and CST, is the spanning tree that connects all the switches in the network.

## 1.3 STP Security

STP Security prevents the loops caused by wrong configurations or BPDU attacks. It contains Loop Protect, Root Protect, BPDU Protect, BPDU Filter and TC Protect functions.

#### » Loop Protect

Loop Protect function is used to prevent loops caused by link congestions or link failures. It is recommended to enable this function on root ports and alternate ports.

If the switch cannot receive BPDUs because of link congestions or link failures, the root port will become a designated port and the alternate port will transit to forwarding status, so loops will occur.

With Loop Protect function enabled, the port will temporarily transit to blocking state when the port does not receive BPDUs. After the link restores to normal, the port will transit to its normal state, so loops can be prevented.

#### » Root Protect

Root Protect function is used to ensure that the desired root bridge will not lose its position. It is recommended to enable this function on the designated ports of the root bridge.

Generally, the root bridge will lose its position once receiving higher-priority BPDUs caused by wrong configurations or malicious attacks. In this case, the spanning tree will be regenerated, and traffic needed to be forwarded along high-speed links may be lead to low-speed links.

With root protect function enabled, when the port receives higher-priority BPDUs, it will temporarily transit to blocking state. After two times of forward delay, if the port does not receive any higher-priority BPDUs, it will transit to its normal state.

#### » BPDU Protect

BPDU Protect function is used to prevent the port from receiving BPUDs. It is recommended to enable this function on edge ports.

Normally edge ports do not receive BPDUs, but if a user maliciously attacks the switch by sending BPDUs, the system automatically configures these ports as non-edge ports and regenerates the spanning tree.

With BPDU protect function enabled, the edge port will be shutdown when it receives BPDUs, and reports these cases to the administrator. Only the administrator can restore it.

#### » BPDU Filter

BPDU filter function is to prevent BPDU flooding in the network. It is recommended to enable this function on edge ports.

If a switch receives malicious BPDUs, it forwards these BPDUs to the other switches in the network, and the spanning tree will be continuously regenerated. In this case, the switch occupies too much CPU or the protocol status of BPDUs is wrong.

With BPDU filter function enabled, the port does not receive or forward BPDUs, but it sends out its own BPDUs, preventing the switch from being attacked by BPDUs.

#### » TC Protect

TC Protect function is used to prevent the switch from frequently removing MAC address entries. It is recommended to enable this function on the ports of non-root switches.

A switch removes MAC address entries upon receiving TC-BPDUs (the packets used to announce changes in the network topology). If a user maliciously sends a large number of TC-BPDUs to a switch in a short period, the switch will be busy with removing MAC address entries, which may decrease the performance and stability of the network.

With TC protect function enabled, if the number of the received TC-BPDUs exceeds the maximum number you set in the TC threshold, the switch will not remove MAC address entries in the TC protect cycle.

# 2 STP/RSTP Configurations

To complete the STP/RSTP configuration, follow these steps:

- 1) Configure STP/RSTP parameters on ports.
- 2) Configure STP/RSTP globally.
- 3) Verify the STP/RSTP configurations.

## Configuration Guidelines

- Before configuring the spanning tree, it's necessary to make clear the role that each switch plays in a spanning tree.
- To avoid any possible network flapping caused by STP/RSTP parameter changes, you are suggested to enable STP/RSTP function globally after configuring the relevant parameters.

## 2.1 Using the GUI

### 2.1.1 Configuring STP/RSTP Parameters on Ports

Choose the menu **Spanning Tree > Port Config > Port Config** to load the following page.

Figure 2-1 Configuring STP/RSTP Parameters on Ports

| Port Config              |        |         |          |               |               |           |          |        |           |           |             |     |
|--------------------------|--------|---------|----------|---------------|---------------|-----------|----------|--------|-----------|-----------|-------------|-----|
| UNIT: 1 LAGS             |        |         |          |               |               |           |          |        |           |           |             |     |
| Select                   | Port   | Status  | Priority | Ext-Path Cost | Int-Path Cost | Edge Port | P2P Link | MCheck | Port Mode | Port Role | Port Status | LAG |
| <input type="checkbox"/> |        |         |          |               |               |           |          |        |           |           |             |     |
| <input type="checkbox"/> | 1/0/1  | Disable | 128      | Auto          | Auto          | Disable   | Auto     | ---    | ---       | ---       | ---         | --- |
| <input type="checkbox"/> | 1/0/2  | Disable | 128      | Auto          | Auto          | Disable   | Auto     | ---    | ---       | ---       | ---         | --- |
| <input type="checkbox"/> | 1/0/3  | Disable | 128      | Auto          | Auto          | Disable   | Auto     | ---    | ---       | ---       | ---         | --- |
| <input type="checkbox"/> | 1/0/4  | Disable | 128      | Auto          | Auto          | Disable   | Auto     | ---    | ---       | ---       | ---         | --- |
| <input type="checkbox"/> | 1/0/5  | Disable | 128      | Auto          | Auto          | Disable   | Auto     | ---    | ---       | ---       | ---         | --- |
| <input type="checkbox"/> | 1/0/6  | Disable | 128      | Auto          | Auto          | Disable   | Auto     | ---    | ---       | ---       | ---         | --- |
| <input type="checkbox"/> | 1/0/7  | Disable | 128      | Auto          | Auto          | Disable   | Auto     | ---    | ---       | ---       | ---         | --- |
| <input type="checkbox"/> | 1/0/8  | Disable | 128      | Auto          | Auto          | Disable   | Auto     | ---    | ---       | ---       | ---         | --- |
| <input type="checkbox"/> | 1/0/9  | Disable | 128      | Auto          | Auto          | Disable   | Auto     | ---    | ---       | ---       | ---         | --- |
| <input type="checkbox"/> | 1/0/10 | Disable | 128      | Auto          | Auto          | Disable   | Auto     | ---    | ---       | ---       | ---         | --- |
| <input type="checkbox"/> | 1/0/11 | Disable | 128      | Auto          | Auto          | Disable   | Auto     | ---    | ---       | ---       | ---         | --- |
| <input type="checkbox"/> | 1/0/12 | Disable | 128      | Auto          | Auto          | Disable   | Auto     | ---    | ---       | ---       | ---         | --- |
| <input type="checkbox"/> | 1/0/13 | Disable | 128      | Auto          | Auto          | Disable   | Auto     | ---    | ---       | ---       | ---         | --- |
| <input type="checkbox"/> | 1/0/14 | Disable | 128      | Auto          | Auto          | Disable   | Auto     | ---    | ---       | ---       | ---         | --- |
| <input type="checkbox"/> | 1/0/15 | Disable | 128      | Auto          | Auto          | Disable   | Auto     | ---    | ---       | ---       | ---         | --- |

Follow these steps to configure STP/RSTP parameters on ports:

- 1) In the **Port Config** section, configure STP/RSTP parameters on ports.

---

UNIT Select the desired unit or LAGs.

---

|               |                                                                                                                                                                                                                                                                                                                                                                                                                                                                                                                                                                                                               |
|---------------|---------------------------------------------------------------------------------------------------------------------------------------------------------------------------------------------------------------------------------------------------------------------------------------------------------------------------------------------------------------------------------------------------------------------------------------------------------------------------------------------------------------------------------------------------------------------------------------------------------------|
| Status        | Enable or disable spanning tree function on the desired port.                                                                                                                                                                                                                                                                                                                                                                                                                                                                                                                                                 |
| Priority      | <p>Enter the value of the port priority from 0 to 240, which is divisible by 16, and the default value is 128.</p> <p>The port with the lower value has the higher priority. In the same condition, the port with the highest priority will be elected as the root port.</p>                                                                                                                                                                                                                                                                                                                                  |
| Ext-Path Cost | <p>Enter the value of the external path cost. The default setting is Auto, which means the port calculates the external path cost automatically according to the port's link speed.</p> <p>External path cost is usually a parameter configured in MSTP, which indicates the path cost of the port in CST.</p> <p>In STP/RSTP, external path cost indicates the path cost of the port in the spanning tree. The port with the lowest external root path cost will be elected as the root port.</p>                                                                                                            |
| Int-Path Cost | <p>Enter the value of the internal path cost.</p> <p>Note: Internal path cost is a parameter configured in MSTP. You need not configure it if the spanning tree mode is STP/RSTP.</p>                                                                                                                                                                                                                                                                                                                                                                                                                         |
| Edge Port     | <p>Enable or disable Edge Port. By default, it is disabled.</p> <p>The edge port can transit its state from blocking to forwarding directly. If the port is connected to an end device, like a PC, it is recommended to set the port as an edge port.</p>                                                                                                                                                                                                                                                                                                                                                     |
| P2P Link      | <p>Select the P2P (Point-to-Point) link status. If the two ports in the P2P link are a root port and a designated port, they can transit their states to forwarding directly.</p> <p>Three options are supported: Auto, Open(Force) and Close(Force). By default, it is Auto.</p> <p><b>Auto:</b> The switch automatically checks if the port is connected to a P2P link, then determines the status is Open or Close.</p> <p><b>Open(Force):</b> The port is manually identified as connected to a P2P link.</p> <p><b>Close(Force):</b> The port is manually identified as not connected to a P2P link.</p> |
| MCheck        | <p>Select whether to do MCheck operation on the port. Unchange means no MCheck operation.</p> <p>Note: MCheck is configured in MSTP. You need not configure it if the spanning tree mode is STP/RSTP.</p>                                                                                                                                                                                                                                                                                                                                                                                                     |
| Port Mode     | <p>Displays the spanning tree mode of the port.</p> <p><b>STP:</b> The spanning tree mode of the port is STP.</p> <p><b>RSTP:</b> The spanning tree mode of the port is RSTP.</p> <p><b>MSTP:</b> The spanning tree mode of the port is MSTP.</p>                                                                                                                                                                                                                                                                                                                                                             |

|             |                                                                                                                                                                                                                                                                                                                                                                                                                                                            |
|-------------|------------------------------------------------------------------------------------------------------------------------------------------------------------------------------------------------------------------------------------------------------------------------------------------------------------------------------------------------------------------------------------------------------------------------------------------------------------|
| Port Role   | <p>Displays the role that the port plays in the spanning tree.</p> <p><b>Root Port:</b> Indicates the port is a root port.</p> <p><b>Designated Port:</b> Indicates the port is a designated port .</p> <p><b>Alternate Port:</b> Indicates the port is a backup of a root port.</p> <p><b>Backup Port:</b> Indicates the port is a backup of a designated port.</p> <p><b>Disabled:</b> Indicates the port is not participating in the spanning tree.</p> |
| Port Status | <p>Displays the port status.</p> <p><b>Forwarding:</b> The port receives and sends BPDUs, and forwards user data.</p> <p><b>Learning:</b> The port receives and sends BPDUs, and drops the other packets.</p> <p><b>Blocking:</b> The port only receives BPDUs and drops the other packets.</p> <p><b>Disconnected:</b> The port is enabled with spanning tree function but not connected to any device.</p>                                               |
| LAG         | Displays the LAG the port belongs to.                                                                                                                                                                                                                                                                                                                                                                                                                      |

2) Click **Apply**.

## 2.1.2 Configuring STP/RSTP Globally

Choose the menu **Spanning Tree > STP Config > STP Config** to load the following page.

Figure 2-2 Configuring STP/RSTP Globally

**Global Config**

Spanning-Tree :  Enable  Disable Apply

Mode : STP ▼

**Parameters Config**

CIST Priority :  (0-61440, in increments of 4096)

Hello Time :  sec (1-10)

Max Age :  sec (6-40) Apply

Forward Delay :  sec (4-30) Help

TxHoldCount :  pps (1-20)

Max Hops :  hop (1-40)

Follow these steps to configure STP/RSTP globally:

- 1) In the **Parameters Config** section, configure the global parameters of STP/RSTP and click **Apply**.

|                      |                                                                                                                                                                                                                                                                                                                                                                                                                                                                                                                                                         |
|----------------------|---------------------------------------------------------------------------------------------------------------------------------------------------------------------------------------------------------------------------------------------------------------------------------------------------------------------------------------------------------------------------------------------------------------------------------------------------------------------------------------------------------------------------------------------------------|
| <b>CIST Priority</b> | Specify the CIST priority of the switch. The valid values are from 0 to 61440, which are divisible by 4096. By default, it is 32768. The switch with the lower value has the higher priority.<br><br>CIST priority is usually a parameter configured in MSTP, which means the priority of a switch in CIST. The switch with the highest priority will be elected as the root bridge in CIST.<br><br>In STP/RSTP, CIST priority means the priority of a switch in the spanning tree. The switch with the highest priority is elected as the root bridge. |
| <b>Hello Time</b>    | Specify the interval to send BPDUs. The valid values are from 1 to 10 in seconds, and the default value is 2.                                                                                                                                                                                                                                                                                                                                                                                                                                           |
| <b>Max Age</b>       | Specify the maximum time the switch can wait without receiving a BPDU before attempting to regenerate a spanning tree. The valid values are from 6 to 40 in seconds, and the default value is 20.                                                                                                                                                                                                                                                                                                                                                       |
| <b>Forward Delay</b> | Specify the time for the port to transit its state after the network topology is changed. The valid values are from 4 to 30 in seconds, and the default value is 15.                                                                                                                                                                                                                                                                                                                                                                                    |
| <b>TxHoldCount</b>   | Specify the maximum BPDU transmission rate of a port. The valid values are from 1 to 20, and the default value is 5.                                                                                                                                                                                                                                                                                                                                                                                                                                    |
| <b>Max Hops</b>      | Specify the scale of an MST region.<br><br>Note: Max Hops is a parameter configured in MSTP. You need not configure it if the spanning tree mode is STP/RSTP.                                                                                                                                                                                                                                                                                                                                                                                           |

 **Note:**

To prevent frequent network flapping, make sure that Hello Time, Forward Delay, and Max Age conform to the following formulas:

- $2 * (\text{Hello Time} + 1) \leq \text{Max Age}$
- $2 * (\text{Forward Delay} - 1) \geq \text{Max Age}$

- 2) In the **Global Config** section, enable spanning tree function, choose the STP mode as STP/RSTP, and click **Apply**.

|                      |                                                                  |
|----------------------|------------------------------------------------------------------|
| <b>Spanning-Tree</b> | Enable or disable spanning tree function globally on the switch. |
|----------------------|------------------------------------------------------------------|

|             |                                                                                        |
|-------------|----------------------------------------------------------------------------------------|
| <b>Mode</b> | Select the desired spanning tree mode as STP/RSTP on the switch. By default, it's STP. |
|             | <b>STP:</b> Specify the spanning tree mode as STP.                                     |
|             | <b>RSTP:</b> Specify the spanning tree mode as RSTP.                                   |
|             | <b>MSTP:</b> Specify the spanning tree mode as MSTP.                                   |

### 2.1.3 Verifying the STP/RSTP Configurations

Verify the STP/RSTP information of your switch after all the configurations are finished.

Choose the menu **Spanning Tree > STP Config > STP Summary** to load the following page.

Figure 2-3 Verifying the STP/RSTP Configurations

| STP Summary            |                           |
|------------------------|---------------------------|
| Spanning-Tree :        | Enable                    |
| Spanning-Tree Mode :   | RSTP                      |
| Local Bridge :         | 32768---00-0a-eb-13-23-7b |
| Root Bridge :          | 32768---00-0a-eb-13-23-7b |
| External Path Cost :   | 0                         |
| Regional Root Bridge : | ---                       |
| Internal Path Cost :   | ---                       |
| Designated Bridge :    | 32768---00-0a-eb-13-23-7b |
| Root Port :            | ---                       |
| Latest TC Time :       | 2006-01-01 08:00:34       |
| TC Count :             | 0                         |

| MSTP Instance Summary  |                                    |
|------------------------|------------------------------------|
| Instance ID :          | 1 <input type="button" value="v"/> |
| Instance Status :      | Disable                            |
| Local Bridge :         | ---                                |
| Regional Root Bridge : | ---                                |
| Internal Path Cost :   | ---                                |
| Designated Bridge :    | ---                                |
| Root Port :            | ---                                |
| Latest TC Time :       | ---                                |
| TC Count :             | ---                                |

The **STP Summary** section shows the summary information of spanning tree :

|                      |                                                    |
|----------------------|----------------------------------------------------|
| <b>Spanning Tree</b> | Displays the status of the spanning tree function. |
|----------------------|----------------------------------------------------|



|                      |                                                                                                                                                                 |
|----------------------|-----------------------------------------------------------------------------------------------------------------------------------------------------------------|
| Spanning-Tree Mode   | Displays the spanning tree mode.                                                                                                                                |
| Local Bridge         | Displays the bridge ID of the local bridge. The local bridge is the current switch.                                                                             |
| Root Bridge          | Displays the bridge ID of the root bridge.                                                                                                                      |
| External Path Cost   | Displays the root path cost from the switch to the root bridge.                                                                                                 |
| Regional Root Bridge | It is the root bridge of IST. It is not displayed when you choose the spanning tree mode as STP/RSTP.                                                           |
| Internal Path Cost   | The internal path cost is the root path cost from the switch to the root bridge of IST. It is not displayed when you choose the spanning tree mode as STP/RSTP. |
| Designated Bridge    | Displays the bridge ID of the designated bridge. The designated bridge is the switch that has designated ports.                                                 |
| Root Port            | Displays the root port of the current switch.                                                                                                                   |
| Latest TC Time       | Displays the latest time when the topology is changed.                                                                                                          |
| TC Count             | Displays how many times the topology has changed.                                                                                                               |

## 2.2 Using the CLI

### 2.2.1 Configuring STP/RSTP Parameters on Ports

Follow these steps to configure STP/RSTP parameters on ports:

|        |                                                                                                                                                                                                                                                                                                                                                                   |
|--------|-------------------------------------------------------------------------------------------------------------------------------------------------------------------------------------------------------------------------------------------------------------------------------------------------------------------------------------------------------------------|
| Step 1 | <b>configure</b><br>Enter global configuration mode.                                                                                                                                                                                                                                                                                                              |
| Step 2 | <b>interface { fastEthernet <i>port</i>   range fastEthernet <i>port-list</i>   gigabitEthernet <i>port</i>   range gigabitEthernet <i>port-list</i>   ten-gigabitEthernet <i>port</i>   range ten-gigabitEthernet <i>port-list</i>   port-channel <i>port-channel</i>   range port-channel <i>port-channel-list</i> }</b><br>Enter interface configuration mode. |
| Step 3 | <b>spanning-tree</b><br>Enable spanning tree function for desired ports.                                                                                                                                                                                                                                                                                          |

- 
- Step 4    **spanning-tree common-config [ port-priority *pri*] [ ext-cost *ext-cost*] [ portfast { enable | disable } ] [ point-to-point { auto | open | close } ]**
- Configure STP/RSTP parameters on the desired port .
- pri*: Specify the value of port priority. The valid values are from 0 to 240, which are divisible by 16, and the default value is 128. The port with the lower value has the higher priority. In the same condition, the port with the highest priority will be elected as the root port.
- ext-cost*: Specify the value of external path cost. The valid values are from 0 to 2000000. It is 0 by default, which means the path cost is automatically calculated according to the port's link speed.
- External path cost is usually a parameter configured in MSTP, which indicates the path cost of the port in CST.
- In STP/RSTP, it indicates the path cost of the port in the spanning tree. The port with the lowest external root path cost will be elected as the root port.
- portfast { enable | disable }**: Enable or disable the edge Port. By default, it is disabled. The edge port can transit its state from blocking to forwarding directly. If the port is connected to an end device, like a PC, it is recommended to set the port as an edge port.
- point-to-point { auto | open | close }**: Specify the P2P link status, with auto, open and close options. By default, it is auto. If the two ports in the P2P link are a root port and a designated port, they can transit their states to forwarding directly.
- 
- Step 5    **show spanning-tree interface [ fastEthernet *port* | gigabitEthernet *port* | ten-gigabitEthernet *port* | port-channel *lagid*] [ edge | ext-cost | int-cost | mode | p2p | priority | role | state | status ]**
- (Optional) View the information of all ports or a specified port.
- port*: Specify the port number.
- lagid*: Specify the ID of the LAG.
- ext-cost | int-cost | mode | p2p | priority | role | state | status**: Display the specified information.
- 
- Step 6    **end**
- Return to privileged EXEC mode.
- 
- Step 7    **copy running-config startup-config**
- Save the settings in the configuration file.
- 

The following example shows how to enable spanning tree function on port 1/0/3 and configure the port priority as 32 :

**Switch#configure**

**Switch(config)#interface ten-gigabitEthernet 1/0/3**

**Switch(config-if)#spanning-tree**

**Switch(config-if)#spanning-tree common-config port-priority 32**

**Switch(config-if)#show spanning-tree interface ten-gigabitEthernet 1/0/3**

| Interface         | State  | Prio | Ext-Cost | Int-Cost | Edge | P2p      | Mode  | Role  | Status |
|-------------------|--------|------|----------|----------|------|----------|-------|-------|--------|
| -----             | -----  | ---- | -----    | -----    | ---- | -----    | ----- | ----- | -----  |
| Te1/0/3<br>LnkDwn | Enable | 32   | Auto     | Auto     | No   | No(auto) | N/A   | N/A   |        |

```
Switch(config-if)#end
```

```
Switch#copy running-config startup-config
```

## 2.2.2 Configuring Global STP/RSTP Parameters

Follow these steps to configure global STP/RSTP parameters of the switch:

|        |                                                                                                                                                                                                                                                                                                                                                                                                                                                                                                                                                                                                                                                                                                                                                                                                                                                                                                                                                |
|--------|------------------------------------------------------------------------------------------------------------------------------------------------------------------------------------------------------------------------------------------------------------------------------------------------------------------------------------------------------------------------------------------------------------------------------------------------------------------------------------------------------------------------------------------------------------------------------------------------------------------------------------------------------------------------------------------------------------------------------------------------------------------------------------------------------------------------------------------------------------------------------------------------------------------------------------------------|
| Step 1 | <b>configure</b><br>Enter global configuration mode.                                                                                                                                                                                                                                                                                                                                                                                                                                                                                                                                                                                                                                                                                                                                                                                                                                                                                           |
| Step 2 | <b>spanning-tree priority <i>pri</i></b><br>Configure the priority of the switch.<br><i>pri</i> : Specify the value of the switch priority from 0 to 61440, which are divisible by 4096. By default, it is 32768. The switch with the lower value has the higher priority, and the switch with the highest priority will be elected as the root bridge.                                                                                                                                                                                                                                                                                                                                                                                                                                                                                                                                                                                        |
| Step 3 | <b>spanning-tree timer [[ forward-time <i>forward-time</i>] [hello-time <i>hello-time</i>] [ max-age <i>max-age</i>]]</b><br>(Optional) Configure the Forward Delay, Hello Time and Max Age.<br><i>forward-time</i> : Specify the value of Forward Delay. The valid values are from 4 to 30 in seconds, and the default value is 15. Forward Delay is the time for the port to transit its state after the network topology is changed.<br><i>hello-time</i> : Specify the value of Hello Time. The valid values are from 1 to 10 in seconds, and the default value is 2. The root bridge sends configuration BPDUs at an interval of Hello Time to check whether the links are failed.<br><i>max-age</i> : Specify the value of Max Age. The valid values are from 6 to 40 in seconds, and the default value is 20. Max Age is the maximum time the switch can wait without receiving a BPDU before attempting to regenerate a spanning tree. |
| Step 4 | <b>spanning-tree hold-count <i>value</i></b><br>Configure the maximum number of BPDU packets transmitted per Hello Time interval.<br><i>value</i> : Specify the maximum number of BPDU packets transmitted per Hello Time interval. The valid values are from 1 to 20 pps, and the default value is 5.                                                                                                                                                                                                                                                                                                                                                                                                                                                                                                                                                                                                                                         |
| Step 5 | <b>show spanning-tree bridge</b><br>(Optional) View the global STP/RSTP parameters of the switch.                                                                                                                                                                                                                                                                                                                                                                                                                                                                                                                                                                                                                                                                                                                                                                                                                                              |
| Step 6 | <b>end</b><br>Return to privileged EXEC mode.                                                                                                                                                                                                                                                                                                                                                                                                                                                                                                                                                                                                                                                                                                                                                                                                                                                                                                  |
| Step 7 | <b>copy running-config startup-config</b><br>Save the settings in the configuration file.                                                                                                                                                                                                                                                                                                                                                                                                                                                                                                                                                                                                                                                                                                                                                                                                                                                      |

 **Note:**

To prevent frequent network flapping, make sure that Hello Time, Forward Delay, and Max Age conform to the following formulas:

- $2 * (\text{Hello Time} + 1) \leq \text{Max Age}$
- $2 * (\text{Forward Delay} - 1) \geq \text{Max Age}$

This example shows how to configure the priority of the switch as 36864, the Forward Delay as 12 seconds:

**Switch#configure**

```
Switch(config)#spanning-tree priority 36864
```

```
Switch(config)#spanning-tree timer forward-time 12
```

**Switch(config)#show spanning-tree bridge**

| State  | Mode  | Priority | Hello-Time | Fwd-Time | Max-Age | Hold-Count | Max-Hops |
|--------|-------|----------|------------|----------|---------|------------|----------|
| -----  | ----- | -----    | -----      | -----    | -----   | -----      | -----    |
| Enable | Rstp  | 36864    | 2          | 12       | 20      | 5          | 20       |

```
Switch(config)#end
```

```
Switch#copy running-config startup-config
```

## 2.2.3 Enabling STP/RSTP Globally

Follow these steps to configure the spanning tree mode as STP/RSTP, and enable spanning tree function globally:

|        |                                                                                                                                                                                                                     |
|--------|---------------------------------------------------------------------------------------------------------------------------------------------------------------------------------------------------------------------|
| Step 1 | <b>configure</b><br>Enter global configuration mode.                                                                                                                                                                |
| Step 2 | <b>spanning-tree mode { stp   rstp }</b><br>Configure the spanning tree mode as STP/RSTP.<br><br><i>stp</i> : Specify the spanning tree mode as STP .<br><br><i>rstp</i> : Specify the spanning tree mode as RSTP . |
| Step 3 | <b>spanning-tree</b><br>Enable spanning tree function globally.                                                                                                                                                     |
| Step 4 | <b>show spanning-tree active</b><br>(Optional) View the active information of STP/RSTP.                                                                                                                             |
| Step 5 | <b>end</b><br>Return to privileged EXEC mode.                                                                                                                                                                       |

**Step 6** **copy running-config startup-config**

Save the settings in the configuration file.

This example shows how to enable spanning tree function, configure the spanning tree mode as RSTP and verify the configurations:

**Switch#configure**

**Switch(config)#spanning tree mode rstp**

**Switch(config)#spanning-tree**

**Switch(config)#show spanning-tree active**

Spanning tree is enabled

Spanning-tree's mode: RSTP (802.1w Rapid Spanning Tree Protocol)

Latest topology change time: 2006-01-02 10:04:02

Root Bridge

Priority : 32768

Address : 00-0a-eb-13-12-ba

Local bridge is the root bridge

Designated Bridge

Priority : 32768

Address : 00-0a-eb-13-12-ba

Local Bridge

Priority : 32768

Address : 00-0a-eb-13-12-ba

| Interface | State  | Prio | Ext-Cost | Int-Cost | Edge | P2p       | Mode | Role | Status |
|-----------|--------|------|----------|----------|------|-----------|------|------|--------|
| Te1/0/16  | Enable | 128  | 200000   | 200000   | No   | Yes(auto) | Rstp | Desg | Fwd    |
| Te1/0/18  | Enable | 128  | 200000   | 200000   | No   | Yes(auto) | Rstp | Desg | Fwd    |
| Te1/0/20  | Enable | 128  | 200000   | 200000   | No   | Yes(auto) | Rstp | Desg | Fwd    |

**Switch(config)#end**

**Switch#copy running-config startup-config**

# 3 MSTP Configurations

To complete the MSTP configuration, follow these steps:

- 1) Configure parameters on ports in CIST.
- 2) Configure the MSTP region.
- 3) Configure the MSTP globally.
- 4) Verify the MSTP configurations.

## Configuration Guidelines

- Before configuring the spanning tree, it's necessary to make clear the role that each switch plays in a spanning tree.
- To avoid any possible network flapping caused by MSTP parameter changes, you are suggested to enable MSTP function globally after configuring the relevant parameter.

## 3.1 Using the GUI

### 3.1.1 Configuring Parameters on Ports in CIST

Choose the menu **Spanning Tree > Port Config > Port Config** to load the following page.

Figure 3-1 Configuring the Parameters of the Ports

| Port Config              |        |                               |                               |                               |                               |                               |                               |                               |                               |           |             |     |
|--------------------------|--------|-------------------------------|-------------------------------|-------------------------------|-------------------------------|-------------------------------|-------------------------------|-------------------------------|-------------------------------|-----------|-------------|-----|
| UNIT: 1 LAGS             |        |                               |                               |                               |                               |                               |                               |                               |                               |           |             |     |
| Select                   | Port   | Status                        | Priority                      | Ext-Path Cost                 | Int-Path Cost                 | Edge Port                     | P2P Link                      | MCheck                        | Port Mode                     | Port Role | Port Status | LAG |
| <input type="checkbox"/> |        | <input type="text" value=""/> | <input type="text" value=""/> | <input type="text" value=""/> | <input type="text" value=""/> | <input type="text" value=""/> | <input type="text" value=""/> | <input type="text" value=""/> | <input type="text" value=""/> |           |             |     |
| <input type="checkbox"/> | 1/0/1  | Disable                       | 128                           | Auto                          | Auto                          | Disable                       | Auto                          | ---                           | ---                           | ---       | ---         | --- |
| <input type="checkbox"/> | 1/0/2  | Disable                       | 128                           | Auto                          | Auto                          | Disable                       | Auto                          | ---                           | ---                           | ---       | ---         | --- |
| <input type="checkbox"/> | 1/0/3  | Disable                       | 128                           | Auto                          | Auto                          | Disable                       | Auto                          | ---                           | ---                           | ---       | ---         | --- |
| <input type="checkbox"/> | 1/0/4  | Disable                       | 128                           | Auto                          | Auto                          | Disable                       | Auto                          | ---                           | ---                           | ---       | ---         | --- |
| <input type="checkbox"/> | 1/0/5  | Disable                       | 128                           | Auto                          | Auto                          | Disable                       | Auto                          | ---                           | ---                           | ---       | ---         | --- |
| <input type="checkbox"/> | 1/0/6  | Disable                       | 128                           | Auto                          | Auto                          | Disable                       | Auto                          | ---                           | ---                           | ---       | ---         | --- |
| <input type="checkbox"/> | 1/0/7  | Disable                       | 128                           | Auto                          | Auto                          | Disable                       | Auto                          | ---                           | ---                           | ---       | ---         | --- |
| <input type="checkbox"/> | 1/0/8  | Disable                       | 128                           | Auto                          | Auto                          | Disable                       | Auto                          | ---                           | ---                           | ---       | ---         | --- |
| <input type="checkbox"/> | 1/0/9  | Disable                       | 128                           | Auto                          | Auto                          | Disable                       | Auto                          | ---                           | ---                           | ---       | ---         | --- |
| <input type="checkbox"/> | 1/0/10 | Disable                       | 128                           | Auto                          | Auto                          | Disable                       | Auto                          | ---                           | ---                           | ---       | ---         | --- |
| <input type="checkbox"/> | 1/0/11 | Disable                       | 128                           | Auto                          | Auto                          | Disable                       | Auto                          | ---                           | ---                           | ---       | ---         | --- |
| <input type="checkbox"/> | 1/0/12 | Disable                       | 128                           | Auto                          | Auto                          | Disable                       | Auto                          | ---                           | ---                           | ---       | ---         | --- |
| <input type="checkbox"/> | 1/0/13 | Disable                       | 128                           | Auto                          | Auto                          | Disable                       | Auto                          | ---                           | ---                           | ---       | ---         | --- |
| <input type="checkbox"/> | 1/0/14 | Disable                       | 128                           | Auto                          | Auto                          | Disable                       | Auto                          | ---                           | ---                           | ---       | ---         | --- |
| <input type="checkbox"/> | 1/0/15 | Disable                       | 128                           | Auto                          | Auto                          | Disable                       | Auto                          | ---                           | ---                           | ---       | ---         | --- |

Follow these steps to configure parameters on ports in CIST:

- 1) In the **Port Config** section, configure the parameters on ports.

---

UNIT Select the desired unit or LAGs.

---

|               |                                                                                                                                                                                                                                                                                                                                                                                                                                                                                                                                                                                               |
|---------------|-----------------------------------------------------------------------------------------------------------------------------------------------------------------------------------------------------------------------------------------------------------------------------------------------------------------------------------------------------------------------------------------------------------------------------------------------------------------------------------------------------------------------------------------------------------------------------------------------|
| Status        | Enable or disable spanning tree function on the desired port.                                                                                                                                                                                                                                                                                                                                                                                                                                                                                                                                 |
| Priority      | <p>Enter the value of port priority from 0 to 240 divisible by 16, and the default value is 128.</p> <p>The port with the lower value has the higher priority. In the same condition, the port with the highest priority will be elected as the root port in CIST.</p>                                                                                                                                                                                                                                                                                                                        |
| Ext-Path Cost | <p>Enter the value of the external path cost. The default setting is Auto, which means the port calculates the path cost automatically according to the port's link speed.</p> <p>External path cost is the path cost of the port in CST. The port with the lowest external root path cost will be elected as the root port in CIST</p>                                                                                                                                                                                                                                                       |
| Int-Path Cost | <p>Enter the value of the internal path cost. The default setting is Auto, which means the port calculates the path cost automatically according to the port's link speed.</p> <p>Internal path cost is the path cost of the port in IST. The port with the lowest internal root path cost will be elected as the root port in IST.</p>                                                                                                                                                                                                                                                       |
| Edge Port     | <p>Enable or disable Edge Port. By default, it is disabled.</p> <p>The edge port can transit its state from blocking to forwarding directly. If the port is connected to an end device, like a PC, it is recommended to set the port as an edge port.</p>                                                                                                                                                                                                                                                                                                                                     |
| P2P Link      | <p>Select the P2P link status. If the two ports in the P2P link are a root port and a designated port, they can transit their states to forwarding directly.</p> <p>Three options are supported: Auto, Open(Force) and Close(Force). By default, it is Auto.</p> <p><b>Auto:</b> The switch automatically detects if the port is connected to a P2P link, then determines the status is Open or Close.</p> <p><b>Open(Force):</b> The port is manually identified as connected to a P2P link.</p> <p><b>Close(Force):</b> The port is manually identified as not connected to a P2P link.</p> |
| MCheck        | <p>Select whether to do MCheck operation on the port. Unchange means no MCheck operation.</p> <p>If a port on an MSTP-enabled device is connected to a STP/RSTP-enabled device, the port switches to the STP/RSTP compatible mode. If the STP/RSTP-enabled device is powered off or disconnected from the MSTP-enabled device, the port cannot switch back to MSTP mode. In this case, you can switch the port to MSTP mode by enabling MCheck operation.</p>                                                                                                                                 |
| Port Mode     | Displays the spanning tree mode of the port.                                                                                                                                                                                                                                                                                                                                                                                                                                                                                                                                                  |

|             |                                                                                                                                                                                                                                                                                                                                                                                                                                                                                                                                                                                                                                                                                                                                        |
|-------------|----------------------------------------------------------------------------------------------------------------------------------------------------------------------------------------------------------------------------------------------------------------------------------------------------------------------------------------------------------------------------------------------------------------------------------------------------------------------------------------------------------------------------------------------------------------------------------------------------------------------------------------------------------------------------------------------------------------------------------------|
| Port Role   | <p>Displays the role that the port plays in CIST.</p> <p><b>Root Port:</b> Indicates the port is the root port in CIST.</p> <p><b>Designated Port:</b> Indicates the port is the designated port in CIST.</p> <p><b>Master Port:</b> Indicates the port provides the lowest root path cost from the region to the root bridge in CIST. In CIST, each region is regarded as a 'switch', and the master port is the root port of that 'switch'.</p> <p><b>Alternate Port:</b> Indicates the port is a backup of a root or master port in CIST.</p> <p><b>Backup Port:</b> Indicates the port is a backup of a designated port in CIST.</p> <p><b>Disabled:</b> Indicates the port is not participating in the spanning tree in CIST.</p> |
| Port Status | <p>Displays the port status.</p> <p><b>Forwarding:</b> The port receives and sends BPDUs, and forwards user data.</p> <p><b>Learning:</b> The port receives and sends BPDUs, and drops the other packets.</p> <p><b>Blocking:</b> The port only receives BPDUs and drops the other packets.</p> <p><b>Disconnected:</b> The port is enabled with spanning tree function but not connected to any device.</p>                                                                                                                                                                                                                                                                                                                           |
| LAG         | <p>Displays the LAG the port belongs to.</p>                                                                                                                                                                                                                                                                                                                                                                                                                                                                                                                                                                                                                                                                                           |

2) Click **Apply**.

### 3.1.2 Configuring the MSTP Region

Configure the region name, revision level, VLAN-Instance mapping of the switch. The switches with the same region name, the same revision level and the same VLAN-Instance mapping are considered as in the same region.

Besides, configure the priority of the switch, the priority and path cost of ports in the desired instance.

- **Configuring the Region Name and Revision Level**

Choose the menu **Spanning Tree > MSTP Instance > Region Config** to load the following page.

Figure 3-2 Configuring the Region

**Region Config**

Region Name :

Revision :  (0-65535)



Follow these steps to create an MST region:

- 1) In the **Region Config** section, set the name and revision level to specify an MSTP region.

|                    |                                                                                                                  |
|--------------------|------------------------------------------------------------------------------------------------------------------|
| <b>Region Name</b> | Configure the name for an MST region using up to 32 characters. By default, it is the MAC address of the switch. |
| <b>Revision</b>    | Enter the revision number from 0 to 65535. By default, it is 0.                                                  |

- 2) Click **Apply**.

■ **Configuring the VLAN-Instance Mapping and Switch Priority**

Choose the menu **Spanning Tree > MSTP Instance > Instance Config** to load the following page.

Figure 3-3 Configuring the VLAN-Instance Mapping

**VLAN-Instance Mapping**

Instance ID :  (0-8, 0 stand for CIST)

VLAN ID :  (1-4094, format: 1,3,4-7,11-30)

**Instance Config**

| Select                   | Instance ID | Status  | Priority             | VLAN ID              |                                                      |
|--------------------------|-------------|---------|----------------------|----------------------|------------------------------------------------------|
| <input type="checkbox"/> |             |         | <input type="text"/> | <input type="text"/> |                                                      |
| <input type="checkbox"/> | CIST        | Enable  | 32768                | 1-4094,              | <a href="#">Show All</a>   <a href="#">Clear All</a> |
| <input type="checkbox"/> | 1           | Disable | 32768                |                      | <a href="#">Show All</a>   <a href="#">Clear All</a> |
| <input type="checkbox"/> | 2           | Disable | 32768                |                      | <a href="#">Show All</a>   <a href="#">Clear All</a> |
| <input type="checkbox"/> | 3           | Disable | 32768                |                      | <a href="#">Show All</a>   <a href="#">Clear All</a> |
| <input type="checkbox"/> | 4           | Disable | 32768                |                      | <a href="#">Show All</a>   <a href="#">Clear All</a> |
| <input type="checkbox"/> | 5           | Disable | 32768                |                      | <a href="#">Show All</a>   <a href="#">Clear All</a> |
| <input type="checkbox"/> | 6           | Disable | 32768                |                      | <a href="#">Show All</a>   <a href="#">Clear All</a> |
| <input type="checkbox"/> | 7           | Disable | 32768                |                      | <a href="#">Show All</a>   <a href="#">Clear All</a> |
| <input type="checkbox"/> | 8           | Disable | 32768                |                      | <a href="#">Show All</a>   <a href="#">Clear All</a> |

Follow these steps to map VLANs to the corresponding instance, and configure the priority of the switch in the desired instance:

- 1) In the **VLAN-Instance Mapping** section, enter the instance ID and the corresponding VLAN ID, and click **Add**.

|                    |                                                                                                                                                                                                                                    |
|--------------------|------------------------------------------------------------------------------------------------------------------------------------------------------------------------------------------------------------------------------------|
| <b>Instance ID</b> | Enter the corresponding instance ID.                                                                                                                                                                                               |
| <b>VLAN ID</b>     | Enter the desired VLAN ID. Click <b>Add</b> , the VLAN(s) will be added to the corresponding instance and the previous VLAN won't be replaced. Click <b>Delete</b> , and the VLAN will be deleted from the corresponding instance. |

- 2) In the **Instance Config** section, configure the priority of the switch in the desired instance, and click **Apply**.

---

|             |                                                                                                                                                                                                                                                                                                |
|-------------|------------------------------------------------------------------------------------------------------------------------------------------------------------------------------------------------------------------------------------------------------------------------------------------------|
| Instance ID | Displays the instance ID.                                                                                                                                                                                                                                                                      |
| Status      | Displays the status of the instance.                                                                                                                                                                                                                                                           |
| Priority    | Enter a value from 0 to 61440 to specify the priority of the switch, which is divisible by 4096, and the default value is 32768. The switch with the lower value has the higher priority, and the switch with the highest priority will be elected as the root bridge in the desired instance. |
| VLAN ID     | Enter the VLAN ID mapped to the corresponding instance ID. After the modification, the previous VLAN will be cleared and mapped to the CIST.                                                                                                                                                   |
| Show All    | Click the <b>Show All</b> to show all VLANs mapped to the instance.                                                                                                                                                                                                                            |
| Clear All   | Click the <b>Clear All</b> to clear up all VLANs from the instance. The cleared VLAN will be automatically mapped to the CIST.                                                                                                                                                                 |

---

- **Configuring Parameters on Ports in the Instance**

Choose the menu **Spanning Tree > MSTP Instance > Instance Port Config** to load the following page.

Figure 3-4 Configuring Port Parameters in the Instance

**Instance ID Select**

Instance ID :

**Instance Port Config**

UNIT:  LAGS

| Select                   | Port   | Priority                                  | Path Cost                                 | Port Role | Port Status | LAG |
|--------------------------|--------|-------------------------------------------|-------------------------------------------|-----------|-------------|-----|
| <input type="checkbox"/> |        | <input style="width: 40px;" type="text"/> | <input style="width: 60px;" type="text"/> |           |             |     |
| <input type="checkbox"/> | 1/0/1  | 128                                       | Auto                                      | ---       | ---         | --- |
| <input type="checkbox"/> | 1/0/2  | 128                                       | Auto                                      | ---       | ---         | --- |
| <input type="checkbox"/> | 1/0/3  | 128                                       | Auto                                      | ---       | ---         | --- |
| <input type="checkbox"/> | 1/0/4  | 128                                       | Auto                                      | ---       | ---         | --- |
| <input type="checkbox"/> | 1/0/5  | 128                                       | Auto                                      | ---       | ---         | --- |
| <input type="checkbox"/> | 1/0/6  | 128                                       | Auto                                      | ---       | ---         | --- |
| <input type="checkbox"/> | 1/0/7  | 128                                       | Auto                                      | ---       | ---         | --- |
| <input type="checkbox"/> | 1/0/8  | 128                                       | Auto                                      | ---       | ---         | --- |
| <input type="checkbox"/> | 1/0/9  | 128                                       | Auto                                      | ---       | ---         | --- |
| <input type="checkbox"/> | 1/0/10 | 128                                       | Auto                                      | ---       | ---         | --- |
| <input type="checkbox"/> | 1/0/11 | 128                                       | Auto                                      | ---       | ---         | --- |
| <input type="checkbox"/> | 1/0/12 | 128                                       | Auto                                      | ---       | ---         | --- |
| <input type="checkbox"/> | 1/0/13 | 128                                       | Auto                                      | ---       | ---         | --- |
| <input type="checkbox"/> | 1/0/14 | 128                                       | Auto                                      | ---       | ---         | --- |
| <input type="checkbox"/> | 1/0/15 | 128                                       | Auto                                      | ---       | ---         | --- |

Follow these steps to configure port parameters in the instance:

- 1) In the **Instance ID Select** section, select the desired instance ID for its port configuration.

---

**Instance ID**                      Select the desired instance.

---

- 2) In the **Instance Port Config** section, configure port parameters in the desired instance.

---

**UNIT**                              Select the desired unit or LAGs for configuration.

---

---

|             |                                                                                                                                                                                                                                                                                                                                                                                                                                                                   |
|-------------|-------------------------------------------------------------------------------------------------------------------------------------------------------------------------------------------------------------------------------------------------------------------------------------------------------------------------------------------------------------------------------------------------------------------------------------------------------------------|
| Priority    | <p>Enter the value of port priority from 0 to 240, which is divisible by 16, and the default value is 128.</p> <p>The port with the lower value has the higher priority. In the same condition, the port with the highest priority will be elected as the root port in the desired instance.</p>                                                                                                                                                                  |
| Path Cost   | <p>Enter the value of the path cost. The default setting is Auto, which means the port calculates the path cost automatically according to the port's link speed.</p> <p>It is the path cost of the port in the desired instance. The port with the lowest path cost will be elected as the root of the desired instance.</p>                                                                                                                                     |
| Port Role   | <p>Displays the role that the port plays in the desired instance.</p> <p><b>Root Port:</b> Indicates the port is the root port.</p> <p><b>Designated Port:</b> Indicates the port is the designated port .</p> <p><b>Alternate Port:</b> Indicates the port is a backup of a root port.</p> <p><b>Backup Port:</b> Indicates the port is a backup of a designated port.</p> <p><b>Disabled:</b> Indicates the port is not participating in the spanning tree.</p> |
| Port Status | <p>Displays the port status.</p> <p><b>Forwarding:</b> The port receives and sends BPDUs, and forwards user data.</p> <p><b>Learning:</b> The port receives and sends BPDUs, and drops the other packets.</p> <p><b>Blocking:</b> The port only receives BPDUs and drops the other packets.</p> <p><b>Disconnected:</b> The port is enabled with spanning tree function but not connected to any device.</p>                                                      |
| LAG         | <p>Displays the LAG which the port belongs to.</p>                                                                                                                                                                                                                                                                                                                                                                                                                |

---

### 3.1.3 Configuring MSTP Globally

Choose the menu **Spanning Tree > STP Config > STP Config** to load the following page.

Figure 3-5 Configure MSTP Function Globally

| Global Config                        |                                                                       |
|--------------------------------------|-----------------------------------------------------------------------|
| Spanning-Tree :                      | <input checked="" type="radio"/> Enable <input type="radio"/> Disable |
| Mode :                               | MSTP <input type="button" value="v"/>                                 |
| <input type="button" value="Apply"/> |                                                                       |
| Parameters Config                    |                                                                       |
| CIST Priority :                      | <input type="text" value="32768"/> (0-61440, in increments of 4096)   |
| Hello Time :                         | <input type="text" value="2"/> sec (1-10)                             |
| Max Age :                            | <input type="text" value="20"/> sec (6-40)                            |
| Forward Delay :                      | <input type="text" value="15"/> sec (4-30)                            |
| TxHoldCount :                        | <input type="text" value="5"/> pps (1-20)                             |
| Max Hops :                           | <input type="text" value="20"/> hop (1-40)                            |
| <input type="button" value="Apply"/> |                                                                       |
| <input type="button" value="Help"/>  |                                                                       |

Follow these steps to configure MSTP globally:

- 1) In the **Parameters Config** section, Configure the global parameters of MSTP and click **Apply**.

|                      |                                                                                                                                                                                                                                                                                                                                   |
|----------------------|-----------------------------------------------------------------------------------------------------------------------------------------------------------------------------------------------------------------------------------------------------------------------------------------------------------------------------------|
| <b>CIST Priority</b> | Enter a value from 0 to 61440 to specify the CIST priority of the switch, which is divisible by 4096, and the default value is 32768. The switch with the lower value has the higher priority.<br><br>CIST priority is the priority of a switch in CIST. The switch with the highest priority will be elected as the root bridge. |
| <b>Hello Time</b>    | Specify the interval to send BPDUs. The valid values are from 1 to 10 in seconds, and the default value is 2.                                                                                                                                                                                                                     |
| <b>Max Age</b>       | Specify the maximum time the switch can wait without receiving a BPDU before attempting to regenerate a spanning tree. The valid values are from 6 to 40 in seconds, and the default value is 20.                                                                                                                                 |
| <b>Forward Delay</b> | Specify the time for the port to transit its state after the network topology is changed. The valid values are from 4 to 30 in seconds, and the default value is 15.                                                                                                                                                              |
| <b>TxHoldCount</b>   | Specify the maximum BPDU transmission rate of a port. The valid values are from 1 to 20, and the default value is 5.                                                                                                                                                                                                              |
| <b>Max Hops</b>      | Specify the maximum number of hops that occur in a specific region before the BPDU is discarded. The valid values are from 1 to 40, and the default value is 20.                                                                                                                                                                  |

---

 **Note:**

To prevent frequent network flapping, make sure that Hello Time, Forward Delay, and Max Age conform to the following formulas:

- $2 * (\text{Hello Time} + 1) \leq \text{Max Age}$
- $2 * (\text{Forward Delay} - 1) \geq \text{Max Age}$

- 
- 2) In the **Global Config** section, enable Spanning-Tree function and choose the STP mode as MSTP and click **Apply**.

---

|               |                                                                                                                                                                                                                                                             |
|---------------|-------------------------------------------------------------------------------------------------------------------------------------------------------------------------------------------------------------------------------------------------------------|
| Spanning-Tree | Enable or disable spanning tree function globally on the switch.                                                                                                                                                                                            |
| Mode          | Select the desired STP mode as MSTP on the switch. By default, it is STP.<br><br><b>STP:</b> Specify the spanning tree mode as STP.<br><br><b>RSTP:</b> Specify the spanning tree mode as RSTP.<br><br><b>MSTP:</b> Specify the spanning tree mode as MSTP. |

---

### 3.1.4 Verifying the MSTP Configurations

Choose the menu **Spanning Tree > STP Config > STP Summary** to load the following page.

Figure 3-6 Verifying the MSTP Configurations

| STP Summary            |                           |
|------------------------|---------------------------|
| Spanning-Tree :        | Enable                    |
| Spanning-Tree Mode :   | MSTP                      |
| Local Bridge :         | 32768---00-0a-eb-13-23-7b |
| Root Bridge :          | 32768---00-0a-eb-13-23-7b |
| External Path Cost :   | 0                         |
| Regional Root Bridge : | 32768---00-0a-eb-13-23-7b |
| Internal Path Cost :   | 0                         |
| Designated Bridge :    | 32768---00-0a-eb-13-23-7b |
| Root Port :            | ---                       |
| Latest TC Time :       | 2006-01-01 08:00:34       |
| TC Count :             | 0                         |

| MSTP Instance Summary  |                                    |
|------------------------|------------------------------------|
| Instance ID :          | 2 <input type="button" value="v"/> |
| Instance Status :      | Enable                             |
| Local Bridge :         | 32768---00-0a-eb-13-23-7b          |
| Regional Root Bridge : | 32768---00-0a-eb-13-23-7b          |
| Internal Path Cost :   | 0                                  |
| Designated Bridge :    | 32768---00-0a-eb-13-23-7b          |
| Root Port :            | ---                                |
| Latest TC Time :       | ---                                |
| TC Count :             | 0                                  |

The **STP Summary** section shows the summary information of CIST:

|                      |                                                                                                       |
|----------------------|-------------------------------------------------------------------------------------------------------|
| Spanning Tree        | Displays the status of the spanning tree function.                                                    |
| Spanning-Tree Mode   | Displays the spanning tree mode.                                                                      |
| Local Bridge         | Displays the bridge ID of the local switch. The local bridge is the current switch.                   |
| Root Bridge          | Displays the bridge ID of the root bridge in CIST.                                                    |
| External Path Cost   | Displays the external path cost. It is the root path cost from the switch to the root bridge in CIST. |
| Regional Root Bridge | Displays the bridge ID of the root bridge in IST.                                                     |

|                    |                                                                                                              |
|--------------------|--------------------------------------------------------------------------------------------------------------|
| Internal Path Cost | Displays the internal path cost. It is the root path cost from the current switch to the root bridge in IST. |
| Designated Bridge  | Displays the bridge ID of the designated bridge in CIST.                                                     |
| Root Port          | Displays the root port of in CIST.                                                                           |
| Latest TC Time     | Displays the latest time when the topology is changed.                                                       |
| TC Count           | Displays how many times the topology has changed.                                                            |

The **MSTP Summary** section shows the information in MST instances:

|                      |                                                                                                                |
|----------------------|----------------------------------------------------------------------------------------------------------------|
| Instance ID          | Select the desired instance.                                                                                   |
| Instance Status      | Displays the status of the desired instance.                                                                   |
| Local Bridge         | Displays the bridge ID of the local switch. The local bridge is the current switch.                            |
| Regional Root Bridge | Displays the bridge ID of the root bridge in the desired instance.                                             |
| Internal Path Cost   | Displays the internal path cost. It is the root path cost from the current switch to the regional root bridge. |
| Designated Bridge    | Displays the bridge ID of the designated bridge in the desired instance.                                       |
| Root Port            | Displays the root port of the desired instance.                                                                |
| Latest TC Time       | Displays the latest time when the topology is changed.                                                         |
| TC Count             | Displays how many times the topology has changed.                                                              |

## 3.2 Using the CLI

### 3.2.1 Configuring Parameters on Ports in CIST

Follow these steps to configure the parameters of the port in CIST:

|        |                                                                                                                                                                                                                                                                                                                                                                    |
|--------|--------------------------------------------------------------------------------------------------------------------------------------------------------------------------------------------------------------------------------------------------------------------------------------------------------------------------------------------------------------------|
| Step 1 | <b>configure</b><br>Enter global configuration mode.                                                                                                                                                                                                                                                                                                               |
| Step 2 | <b>interface { fastEthernet <i>port</i>   range fastEthernet <i>port-list</i>   gigabitEthernet <i>port</i>   range gigabitEthernet <i>port-list</i>   ten-gigabitEthernet <i>port</i>   range ten-gigabitEthernet <i>port-list</i> } [port-channel <i>port-channel</i>   range port-channel <i>port-channel-list</i> }</b><br>Enter interface configuration mode. |
| Step 3 | <b>spanning-tree</b><br>Enable spanning tree function for the desired port.                                                                                                                                                                                                                                                                                        |



- 
- Step 4 **spanning-tree common-config [ port-priority *pri* ] [ ext-cost *ext-cost* ] [ int-cost *int-cost* ] [ portfast { enable | disable } ] [ point-to-point { auto | open | close } ]**
- Configure the parameters on ports in CIST.
- pri*: Specify the value of port priority. The valid values are from 0 to 240, which are divisible by 16, and the default value is 128. The port with the lower value has the higher priority. In the same condition, the port with the highest priority will be elected as the root port in CIST.
- ext-cost*: Specify the value of external path cost. The valid values are from 0 to 2000000. It is 0 by default, which means the path cost is automatically calculated according to the port's link speed. External path cost is the path cost of the port in CST. The port with the lowest external root path cost will be elected as the root port in CIST.
- int-cost*: Specify the value of internal path cost. The valid values are from 0 to 2000000. It is 0 by default, which means the path cost is automatically calculated according to the port's link speed.
- Internal path cost is the path cost of the port in IST. The port with the lowest internal root path cost will be elected as the root port in IST.
- portfast { enable | disable }**: Enable or disable edge Port. By default, it is disabled. The edge port can transit its state from blocking to forwarding directly. If the port is connected to an end device, like a PC, it is recommended to set the port as an edge port.
- point-to-point { auto | open | close }**: Specify the P2P link status, with auto, open and close options. By default, the option is auto. If the two ports in the P2P link are a root port and a designated port, they can transit their states to forwarding directly.
- 
- Step 5 **spanning-tree mcheck**
- (Optional) Select whether to do MCheck operation on the port.
- If a port on an MSTP-enabled device is connected to an STP-enabled device, the port switches to the STP compatible mode.
- If the STP-enabled device is powered off or disconnected from the MSTP-enabled device, the port cannot switch back to MSTP mode. In this case, you can switch the port to MSTP mode by MCheck operation.
- 
- Step 6 **show spanning-tree interface [ fastEthernet *port* | gigabitEthernet *port* | ten-gigabitEthernet *port* | port-channel *lagid* ] [ edge | ext-cost | int-cost | mode | p2p | priority | role | state | status ]**
- (Optional) View the information of all ports or a specified port.
- port*: Specify the port number.
- lagid*: Specify the ID of the LAG.
- ext-cost | int-cost | mode | p2p | priority | role | state | status**: Display the specified information.
- 
- Step 7 **end**
- Return to privileged EXEC mode.
- 
- Step 8 **copy running-config startup-config**
- Save the settings in the configuration file.
- 

This example shows how to enable spanning tree function for port 1/0/3 and configure the port priority as 32 :

**Switch#configure**

```

Switch(config)#interface ten-gigabitEthernet 1/0/3

Switch(config-if)#spanning-tree

Switch(config-if)#spanning-tree common-config port-priority 32

Switch(config-if)#show spanning-tree interface ten-gigabitEthernet 1/0/3
MST-Instance 0 (CIST)
Interface  State    Prio  Ext-Cost  Int-Cost  Edge  P2p      Mode  Role  Status
-----  -
Te1/0/3   Enable  32    Auto     Auto     No    No(auto) N/A   N/A   LnkDwn

MST-Instance 5
Interface  Prio Cost  Role  Status
-----
Te1/0/3   144 200   N/A   LnkDwn

Switch(config-if)#end

Switch#copy running-config startup-config

```

### 3.2.2 Configuring the MSTP Region

- **Configuring the MST Region**

Follow these steps to configure the MST region and the priority of the switch in the instance:

|        |                                                                                                                                                                                                                                                                                                                                                                                                                                                                                                                                                               |
|--------|---------------------------------------------------------------------------------------------------------------------------------------------------------------------------------------------------------------------------------------------------------------------------------------------------------------------------------------------------------------------------------------------------------------------------------------------------------------------------------------------------------------------------------------------------------------|
| Step 1 | <p><b>configure</b></p> <p>Enter global configuration mode.</p>                                                                                                                                                                                                                                                                                                                                                                                                                                                                                               |
| Step 2 | <p><b>spanning-tree mst instance <i>instance-id</i> priority <i>pri</i></b></p> <p>Configure the priority of the switch in the instance.</p> <p><i>instance-id</i>: Specify the instance ID, the valid values ranges from 1 to 8.</p> <p><i>pri</i>: Specify the priority of the switch. The valid values are from 0 to 61440, which are divisible by 4096, and the default value is 32768. The switch with the lower value has the higher priority, and the switch with the highest priority will be elected as the root bridge in the desired instance.</p> |
| Step 3 | <p><b>spanning-tree mst configuration</b></p> <p>Enter MST configuration mode, as to configure the VLAN-Instance mapping, region name and revision level.</p>                                                                                                                                                                                                                                                                                                                                                                                                 |

- 
- Step 4     **name** *name*  
 Configure the region name of the region.  
*name*: Specify the region name, used to identify an MST region. The valid values are from 1 to 32 characters.
- 
- Step 5     **revision** *revision*  
 Configure the revision level of the region.  
*revision*: Specify the revision level of the region. The valid values are from 0 to 65535.
- 
- Step 6     **instance** *instance-id* **vlan** *vlan-id*  
 Configure the VLAN-Instance mapping.  
*instance-id*: Specify the Instance ID. The valid values are from 1 to 8.  
*vlan-id*: Specify the VLAN mapped to the corresponding instance.
- 
- Step 7     **show spanning-tree mst** { **configuration** [ *digest* ] | **instance** *instance-id* [ **interface** [ **fastEthernet** *port* | **gigabitEthernet** *port* | **ten-gigabitEthernet** *port* | **port-channel** *lagid* ] ] }  
 (Optional) View the related information of MSTP Instance.  
*digest*: Display digest calculated by instance-vlan map.  
*instance-id*: Specify the Instance ID desired to view, ranging from 1 to 8.  
*port*: Specify the port number.  
*lagid*: Specify the ID of the LAG.
- 
- Step 8     **end**  
 Return to privileged EXEC mode.
- 
- Step 9     **copy running-config startup-config**  
 Save the settings in the configuration file.
- 

This example shows how to create an MST region, of which the region name is R1, the revision level is 100 and VLAN 2-VLAN 6 are mapped to instance 5:

**Switch#configure**

**Switch(config)#spanning-tree mst configuration**

**Switch(config-mst)#name R1**

**Switch(config-mst)#revision 100**

**Switch(config-mst)#instance 5 vlan 2-6**

**Switch(config-mst)#show spanning-tree mst configuration**

Region-Name : R1

Revision : 100

| MST-Instance | Vlans-Mapped |
|--------------|--------------|
| 0            | 1,7-4094     |
| 5            | 2-6,         |

```
Switch(config-mst)#end
```

```
Switch#copy running-config startup-config
```

- **Configuring the Parameters on Ports in Instance**

Follow these steps to configure the priority and path cost of ports in the specified instance:

|        |                                                                                                                                                                                                                                                                                                                                                                                                                                                                                                                                                                                                                                                                                                                                                                                                                                                                                                                                                                                                                             |
|--------|-----------------------------------------------------------------------------------------------------------------------------------------------------------------------------------------------------------------------------------------------------------------------------------------------------------------------------------------------------------------------------------------------------------------------------------------------------------------------------------------------------------------------------------------------------------------------------------------------------------------------------------------------------------------------------------------------------------------------------------------------------------------------------------------------------------------------------------------------------------------------------------------------------------------------------------------------------------------------------------------------------------------------------|
| Step 1 | <p><b>configure</b></p> <p>Enter global configuration mode.</p>                                                                                                                                                                                                                                                                                                                                                                                                                                                                                                                                                                                                                                                                                                                                                                                                                                                                                                                                                             |
| Step 2 | <p><b>interface { fastEthernet <i>port</i>   range fastEthernet <i>port-list</i>   gigabitEthernet <i>port</i>   range gigabitEthernet <i>port-list</i>   ten-gigabitEthernet <i>port</i>   range ten-gigabitEthernet <i>port-list</i> } [port-channel <i>port-channel</i>   range port-channel <i>port-channel-list</i> }</b></p> <p>Enter interface configuration mode.</p>                                                                                                                                                                                                                                                                                                                                                                                                                                                                                                                                                                                                                                               |
| Step 3 | <p><b>spanning-tree mst instance <i>instance-id</i> [{ port-priority <i>pri</i> ] [ cost <i>cost</i> ]}</b></p> <p>Configure the priority and path cost of ports in the specified instance.</p> <p><i>instance-id</i>: Specify the instance ID, the valid values ranges from 1 to 8.</p> <p><i>pri</i>: Specify the priority of the port. The valid values are from 0 to 240, which are divisible by 16, and the default value is 128. The port with the lower value has the higher priority. In the same condition, the port with the highest priority will be elected as the root port in the desired instance.</p> <p><i>cost</i>: Specify the path cost of the port. The valid values are from 0 to 2000000. By default, it is 0, which means the port calculates the path cost automatically according to the port's link speed. It is the root path cost from the port to the root bridge in the specified instance. The port with the lowest path cost will be elected as the root port in the desired instance.</p> |
| Step 4 | <p><b>show spanning-tree mst { configuration [ digest ]   instance <i>instance-id</i> [ interface [ fastEthernet <i>port</i>   gigabitEthernet <i>port</i>   ten-gigabitEthernet <i>port</i>   port-channel <i>lagid</i> ] ]}</b></p> <p>(Optional) View the related information of MSTP Instance.</p> <p><i>digest</i>: Display digest calculated by instance-vlan map.</p> <p><i>instance-id</i>: Specify the Instance ID desired to view, ranging from 1 to 8.</p> <p><i>port</i>: Specify the port number.</p> <p><i>lagid</i>: Specify the ID of the LAG.</p>                                                                                                                                                                                                                                                                                                                                                                                                                                                          |
| Step 5 | <p><b>end</b></p> <p>Return to privileged EXEC mode.</p>                                                                                                                                                                                                                                                                                                                                                                                                                                                                                                                                                                                                                                                                                                                                                                                                                                                                                                                                                                    |

**Step 6** **copy running-config startup-config**

Save the settings in the configuration file.

This example shows how to configure the priority as 144, the path cost as 200 of port 1/0/3 in instance 5:

**Switch#configure**

**Switch(config)#interface ten-gigabitEthernet 1/0/3**

**Switch(config-if)#spanning-tree mst instance 5 port-priority 144 cost 200**

**Switch(config-if)#show spanning-tree interface ten-gigabitEthernet 1/0/3**

MST-Instance 0 (CIST)

| Interface | State  | Prio | Ext-Cost | Int-Cost | Edge | P2p      | Mode | Role | Status |
|-----------|--------|------|----------|----------|------|----------|------|------|--------|
| -----     | -----  | ---- | -----    | -----    | ---  | -----    | ---- | ---- | ----   |
| Te1/0/3   | Enable | 32   | Auto     | Auto     | No   | No(auto) | N/A  | N/A  | LnkDwn |

MST-Instance 5

| Interface | Prio  | Cost  | Role  | Status |
|-----------|-------|-------|-------|--------|
| -----     | ----- | ----- | ----- | -----  |
| Te1/0/3   | 144   | 200   | N/A   | LnkDwn |

**Switch(config-if)#end**

**Switch#copy running-config startup-config**

### 3.2.3 Configuring Global MSTP Parameters

Follow these steps to configure the global MSTP parameters of the switch:

**Step 1** **configure**

Enter global configuration mode.

**Step 2** **spanning-tree priority *pri***

Configure the priority of the switch for comparison in CIST.

*pri*: Specify the CIST priority of the switch. The valid values are from 0 to 61440, which are divisible by 4096, and the default value is 32768. The switch with the lower value has the higher priority.

CIST priority the priority of a switch in CIST. The switch with the highest priority will be elected as the root bridge in CIST.

---

Step 3 **spanning-tree timer** [[ **forward-time** *forward-time* ] [ **hello-time** *hello-time* ] [ **max-age** *max-age* ]]

(Optional) Configure the Forward Delay, Hello Time and Max Age.

*forward-time*: Specify the value of Forward Delay. The valid values are from 4 to 30 in seconds, and the default value is 15. Forward Delay is the time for the port to transit its state after the network topology is changed.

*hello-time*: Specify the value of Hello Time. The valid values are from 1 to 10 in seconds, and the default value is 2. The root bridge sends configuration BPDUs at an interval of Hello Time to check whether the links are failed.

*max-age*: Specify the value of Max Age. The valid values are from 6 to 40 in seconds, and the default value is 20. Max Age is the maximum time the switch can wait without receiving a BPDU before attempting to regenerate a spanning tree.

---

Step 4 **spanning-tree hold-count** *value*

(Optional) Configure the maximum number of BPDU packets transmitted per Hello Time interval.

*value*: Specify the maximum number of BPDU packets transmitted per Hello Time interval. The valid values are from 1 to 20 pps, and the default value is 5.

---

Step 5 **spanning-tree max-hops** *value*

(Optional) Configure the maximum number of hops that occur in a specific region before the BPDU is discarded.

*value*: Specify the maximum number of hops that occur in a specific region before the BPDU is discarded. The valid values are from 1 to 40 in hop, and the default value is 20.

---

Step 6 **show spanning-tree bridge**

(Optional) View the global parameters of the switch.

---

Step 7 **end**

Return to privileged EXEC mode.

---

Step 8 **copy running-config startup-config**

Save the settings in the configuration file.

---

 **Note:**

To prevent frequent network flapping, make sure that Hello Time, Forward Delay, and Max Age conform to the following formulas:

- $2 * (\text{Hello Time} + 1) \leq \text{Max Age}$
- $2 * (\text{Forward Delay} - 1) \geq \text{Max Age}$

---

This example shows how to configure the CIST priority as 36864, the Forward Delay as 12 seconds, the Hold Count as 8 and the Max Hop as 25:

**Switch#configure**

**Switch(config)#spanning-tree priority 36864**

```
Switch(config-if)#spanning-tree timer forward-time 12
```

```
Switch(config-if)#spanning-tree hold-count 8
```

```
Switch(config-if)#spanning-tree max-hops 25
```

```
Switch(config-if)#show spanning-tree bridge
```

| State  | Mode  | Priority | Hello-Time | Fwd-Time | Max-Age | Hold-Count | Max-Hops |
|--------|-------|----------|------------|----------|---------|------------|----------|
| -----  | ----- | -----    | -----      | -----    | -----   | -----      | -----    |
| Enable | Mstp  | 36864    | 2          | 12       | 20      | 8          | 25       |

```
Switch(config-if)#end
```

```
Switch#copy running-config startup-config
```

### 3.2.4 Enabling Spanning Tree Globally

Follow these steps to configure the spanning tree mode as MSTP and enable spanning tree function globally:

- 
- |        |                                                                 |
|--------|-----------------------------------------------------------------|
| Step 1 | <p><b>configure</b></p> <p>Enter global configuration mode.</p> |
|--------|-----------------------------------------------------------------|
- 
- |        |                                                                                                                                                    |
|--------|----------------------------------------------------------------------------------------------------------------------------------------------------|
| Step 2 | <p><b>spanning-tree mode mstp</b></p> <p>Configure the spanning tree mode as MSTP.</p> <p><i>mstp</i>: Specify the spanning tree mode as MSTP.</p> |
|--------|----------------------------------------------------------------------------------------------------------------------------------------------------|
- 
- |        |                                                                            |
|--------|----------------------------------------------------------------------------|
| Step 3 | <p><b>spanning-tree</b></p> <p>Enable spanning tree function globally.</p> |
|--------|----------------------------------------------------------------------------|
- 
- |        |                                                                                                |
|--------|------------------------------------------------------------------------------------------------|
| Step 4 | <p><b>show spanning-tree active</b></p> <p>(Optional) View the active information of MSTP.</p> |
|--------|------------------------------------------------------------------------------------------------|
- 
- |        |                                                          |
|--------|----------------------------------------------------------|
| Step 5 | <p><b>end</b></p> <p>Return to privileged EXEC mode.</p> |
|--------|----------------------------------------------------------|
- 
- |        |                                                                                                      |
|--------|------------------------------------------------------------------------------------------------------|
| Step 6 | <p><b>copy running-config startup-config</b></p> <p>Save the settings in the configuration file.</p> |
|--------|------------------------------------------------------------------------------------------------------|
- 

This example shows how to configure the spanning tree mode as MSTP and enable spanning tree function globally :

```
Switch#configure
```

```
Switch(config)#spanning-tree mode mstp
```

```
Switch(config)#spanning-tree
```

```
Switch(config)#show spanning-tree active
```

Spanning tree is enabled

Spanning-tree's mode: MSTP (802.1s Multiple Spanning Tree Protocol)

Latest topology change time: 2006-01-04 10:47:42

MST-Instance 0 (CIST)

Root Bridge

Priority : 32768

Address : 00-0a-eb-13-23-97

External Cost : 200000

Root Port : Te1/0/20

Designated Bridge

Priority : 32768

Address : 00-0a-eb-13-23-97

Regional Root Bridge

Priority : 36864

Address : 00-0a-eb-13-12-ba

Local bridge is the regional root bridge

Local Bridge

Priority : 36864

Address : 00-0a-eb-13-12-ba

| Interface | State  | Prio | Ext-Cost | Int-Cost | Edge | P2p       | Mode | Role | Status |
|-----------|--------|------|----------|----------|------|-----------|------|------|--------|
| Gi/0/16   | Enable | 128  | 200000   | 200000   | No   | Yes(auto) | Mstp | Altn | Blk    |
| Gi/0/20   | Enable | 128  | 200000   | 200000   | No   | Yes(auto) | Mstp | Root | Fwd    |

MST-Instance 1

Root Bridge

Priority : 32768

Address : 00-0a-eb-13-12-ba

Local bridge is the root bridge

Designated Bridge

Priority : 32768

Address : 00-0a-eb-13-12-ba



Local Bridge

Priority : 32768

Address : 00-0a-eb-13-12-ba

| Interface | Prio | Cost | Role | Status |
|-----------|------|------|------|--------|
|-----------|------|------|------|--------|

-----

|         |     |        |      |     |
|---------|-----|--------|------|-----|
| Gi/0/16 | 128 | 200000 | Altn | Blk |
|---------|-----|--------|------|-----|

|         |     |        |      |     |
|---------|-----|--------|------|-----|
| Gi/0/20 | 128 | 200000 | Mstr | Fwd |
|---------|-----|--------|------|-----|

**Switch(config)#end**

**Switch#copy running-config startup-config**

# 4 STP Security Configurations

With STP security, you can:

- Configure the Loop Protect function.
- Configure the Root Protect function.
- Configure the TC Protect function.
- Configure the BPDU Protect function.
- Configure the BPDU Filter function.

## 4.1 Using the GUI

### 4.1.1 Configuring the STP Security

Choose the menu **Spanning Tree > STP Security > Port Protect** to load the following page.

Figure 4-1 Configuring the Port Protect

**Port Protect**

UNIT:  LAGS

| Select                   | Port   | Loop Protect                         | Root Protect                         | TC Protect                           | BPDU Protect                         | BPDU Filter                          | LAG |
|--------------------------|--------|--------------------------------------|--------------------------------------|--------------------------------------|--------------------------------------|--------------------------------------|-----|
| <input type="checkbox"/> |        | <input type="text" value="Disable"/> | <input type="text" value="Disable"/> | <input type="text" value="Disable"/> | <input type="text" value="Disable"/> | <input type="text" value="Disable"/> |     |
| <input type="checkbox"/> | 1/0/1  | Disable                              | Disable                              | Disable                              | Disable                              | Disable                              | --- |
| <input type="checkbox"/> | 1/0/2  | Disable                              | Disable                              | Disable                              | Disable                              | Disable                              | --- |
| <input type="checkbox"/> | 1/0/3  | Disable                              | Disable                              | Disable                              | Disable                              | Disable                              | --- |
| <input type="checkbox"/> | 1/0/4  | Disable                              | Disable                              | Disable                              | Disable                              | Disable                              | --- |
| <input type="checkbox"/> | 1/0/5  | Disable                              | Disable                              | Disable                              | Disable                              | Disable                              | --- |
| <input type="checkbox"/> | 1/0/6  | Disable                              | Disable                              | Disable                              | Disable                              | Disable                              | --- |
| <input type="checkbox"/> | 1/0/7  | Disable                              | Disable                              | Disable                              | Disable                              | Disable                              | --- |
| <input type="checkbox"/> | 1/0/8  | Disable                              | Disable                              | Disable                              | Disable                              | Disable                              | --- |
| <input type="checkbox"/> | 1/0/9  | Disable                              | Disable                              | Disable                              | Disable                              | Disable                              | --- |
| <input type="checkbox"/> | 1/0/10 | Disable                              | Disable                              | Disable                              | Disable                              | Disable                              | --- |
| <input type="checkbox"/> | 1/0/11 | Disable                              | Disable                              | Disable                              | Disable                              | Disable                              | --- |
| <input type="checkbox"/> | 1/0/12 | Disable                              | Disable                              | Disable                              | Disable                              | Disable                              | --- |
| <input type="checkbox"/> | 1/0/13 | Disable                              | Disable                              | Disable                              | Disable                              | Disable                              | --- |
| <input type="checkbox"/> | 1/0/14 | Disable                              | Disable                              | Disable                              | Disable                              | Disable                              | --- |
| <input type="checkbox"/> | 1/0/15 | Disable                              | Disable                              | Disable                              | Disable                              | Disable                              | --- |

Configure the Port Protect features for the selected ports, and click **Apply**.

|              |                                                                                                                                                                                                                                                                                                                                                                                                                                                                                                                                                                                                                       |
|--------------|-----------------------------------------------------------------------------------------------------------------------------------------------------------------------------------------------------------------------------------------------------------------------------------------------------------------------------------------------------------------------------------------------------------------------------------------------------------------------------------------------------------------------------------------------------------------------------------------------------------------------|
| UNIT         | Select the desired unit or LAGs for configuration.                                                                                                                                                                                                                                                                                                                                                                                                                                                                                                                                                                    |
| Loop Protect | <p>Enable or disable the Loop Protect function. It is recommended to enable this function on root ports and alternate ports.</p> <p>Loop Protect function is used to prevent loops caused by link congestions or link failures. With Loop Protect function enabled, the port will temporarily transit to blocking state when it does not receive BPDUs. After the link restores to normal, the port will transit to its normal state, so loops can be prevented.</p>                                                                                                                                                  |
| Root Protect | <p>Enable or disable the Root Protect function. It is recommended to enable this function on the designated ports of the root bridge.</p> <p>Root Protect function is used to ensure that the desired root bridge will not lose its position. With root protect function enabled, the port will temporarily transit to blocking state when it receives higher-priority BPDUs. After two times of forward delay, if the port does not receive any higher-priority BPDUs, it will transit to its normal state.</p>                                                                                                      |
| TC Protect   | <p>Enable or disable the TC Protect function. It is recommended to enable this function on the ports of non-root switches.</p> <p>TC Protect function is used to prevent the switch from frequently removing MAC address entries. With TC protect function enabled, if the number of the received TC-BPDUs exceeds the maximum number you set in the TC threshold, the switch will not remove MAC address entries in the TC protect cycle.</p> <p>If you enable TC Protect here, you also need to configure the TC threshold and TC cycle in <i>(Optional) Configuring the Threshold and Cycle of TC Protect</i>.</p> |
| BPDU Protect | <p>Enable or disable the BPDU Protect function. It is recommended to enable this function on edge ports.</p> <p>BPDU Protect function is used to prevent the edge port from receiving BPDUs. With BPDU protect function enabled, the edge port will be shutdown when it receives BPDUs, and reports these cases to the administrator. Only the administrator can restore it.</p>                                                                                                                                                                                                                                      |
| BPDU Filter  | <p>Enable or disable the BPDU Filter function. It is recommended to enable this function on edge ports.</p> <p>BPDU filter function is to prevent BPDU flooding in the network. With BPDU filter function enabled, the port does not receive or forward BPDUs, but it sends out its own BPDUs, preventing the switch from being attacked by BPDUs.</p>                                                                                                                                                                                                                                                                |

### 4.1.2 (Optional) Configuring the Threshold and Cycle of TC Protect

When you enable TC Protect function on ports, set the TC threshold and TC Protect Cycle here. If the number of the received TC-BPDUs exceeds the maximum number you set in the TC threshold field, the switch will not remove MAC address entries in the TC protect cycle.

Choose the menu **Spanning Tree > STP Security > TC Protect** to load the following page.

Figure 4-2 Configuring the TC Protect

**TC Protect**

TC Threshold :  packet (1-100)

TC Protect Cycle :  sec (1-10)

Configure the parameters of TC Protect feature, and click **Apply**.

|                  |                                                                                                                                                   |
|------------------|---------------------------------------------------------------------------------------------------------------------------------------------------|
| TC Threshold     | Enter a number from 1 to 100, and the default value is 20. It is the maximum number of the TC-BPDUs received by the switch in a TC Protect Cycle. |
| TC Protect Cycle | Enter a value from 1 to 10 to specify the TC Protect Cycle. The default value is 5.                                                               |

## 4.2 Using the CLI

### 4.2.1 Configuring the STP Security

Follow these steps to configure the Root protect feature, BPDU protect feature and BPDU filter feature for ports:

|        |                                                                                                                                                                                                                                                                                                                                                                                                                                                                                                                        |
|--------|------------------------------------------------------------------------------------------------------------------------------------------------------------------------------------------------------------------------------------------------------------------------------------------------------------------------------------------------------------------------------------------------------------------------------------------------------------------------------------------------------------------------|
| Step 1 | <p><b>configure</b></p> <p>Enter global configuration mode.</p>                                                                                                                                                                                                                                                                                                                                                                                                                                                        |
| Step 2 | <p><b>interface { fastEthernet <i>port</i>   range fastEthernet <i>port-list</i>   gigabitEthernet <i>port</i>   range gigabitEthernet <i>port-list</i>   ten-gigabitEthernet <i>port</i>   range ten-gigabitEthernet <i>port-list</i> } [port-channel <i>port-channel</i>   range port-channel <i>port-channel-list</i> }</b></p> <p>Enter interface configuration mode.</p>                                                                                                                                          |
| Step 3 | <p><b>spanning-tree guard loop</b></p> <p>(Optional) Enable the Loop Protect feature on the port. It is recommended to enable this function on root ports and alternate ports.</p> <p>Loop Protect function is used to prevent loops caused by link congestions or link failures. With Loop Protect function enabled, the port will temporarily transit to blocking state when it does not receive BPDUs. After the link restores to normal, the port will transit to its normal state, so loops can be prevented.</p> |

**Step 4** **spanning-tree guard root**

(Optional) Enable the Root Protect function on the port. It is recommended to enable this function on the designated ports of the root bridge.

Root Protect function is used to ensure that the desired root bridge will not lose its position. With root protect function enabled, the port will temporarily transit to blocking state when it receives higher-priority BPDUs. After two times of forward delay, if the port does not receive any higher-priority BPDUs, it will transit to its normal state.

**Step 5** **spanning-tree bpdudfilter**

(Optional) Enable the BPDU Filter function on the port. It is recommended to enable this function on edge ports.

BPDU filter function is to prevent BPDU flooding in the network. With BPDU filter function enabled, the port does not receive or forward BPDUs, but it sends out its own BPDUs, preventing the switch from being attacked by BPDUs.

**Step 6** **spanning-tree bpduguard**

(Optional) Enable the BPDU Protect function on the port. It is recommended to enable this function on edge ports.

BPDU Protect function is used to prevent the edge port from receiving BPDUs. With BPDU protect function enabled, the edge port will be shutdown when it receives BPDUs, and reports these cases to the administrator. Only the administrator can restore it.

**Step 7** **show spanning-tree interface-security [ fastEthernet *port* | gigabitEthernet *port* | ten-gigabitEthernet *port* | port-channel *lagid* ] [ bpdudfilter | bpduguard | loop | root | tc | tc-defend ]**  
(Optional) View the protect information of ports.

*port*: Specify the port number.

*lagid*: Specify the ID of the LAG.

**Step 8** **end**

Return to privileged EXEC mode.

**Step 9** **copy running-config startup-config**

Save the settings in the configuration file.

This example shows how to enable Loop Protect, Root Protect, BPDU Filter and BPDU Protect functions on port 1/0/3:

```
Switch#configure
```

```
Switch(config)#interface ten-gigabitEthernet 1/0/3
```

```
Switch(config-if)#spanning-tree guard loop
```

```
Switch(config-if)#spanning-tree guard root
```

```
Switch(config-if)#spanning-tree bpdudfilter
```

```
Switch(config-if)#spanning-tree bpduguard
```

```
Switch(config-if)#show spanning-tree interface-security ten-gigabitEthernet 1/0/3
```

| Interface | BPDU-Filter | BPDU-Guard | Loop-Protect | Root-Protect | TC-Protect |
|-----------|-------------|------------|--------------|--------------|------------|
| Te1/0/3   | Enable      | Enable     | Enable       | Enable       | Disable    |

```
Switch(config-if)#end
```

```
Switch#copy running-config startup-config
```

## 4.2.1 Configuring the TC Protect

Follow these steps to configure TC protect feature for ports:

|        |                                                                                                                                                                                                                                                                                                                                                                                                                                                                                          |
|--------|------------------------------------------------------------------------------------------------------------------------------------------------------------------------------------------------------------------------------------------------------------------------------------------------------------------------------------------------------------------------------------------------------------------------------------------------------------------------------------------|
| Step 1 | <p><b>configure</b></p> <p>Enter global configuration mode.</p>                                                                                                                                                                                                                                                                                                                                                                                                                          |
| Step 2 | <p><b>spanning-tree tc-defend threshold <i>threshold</i> period <i>period</i></b></p> <p>Configure the TC Protect function globally.</p> <p><i>threshold</i>: Specify the TC threshold, the valid values ranges from 1 to 100 packets. By default, it is 20. TC Threshold is the maximum number of the TC-BPDUs received by the switch in a TC Protect cycle.</p> <p><i>pri</i>: Specify the TC Protect cycle, the valid values ranges from 1 to 10 in seconds. By default, it is 5.</p> |
| Step 3 | <p><b>interface { fastEthernet <i>port</i>   range fastEthernet <i>port-list</i>   gigabitEthernet <i>port</i>   range gigabitEthernet <i>port-list</i>   ten-gigabitEthernet <i>port</i>   range ten-gigabitEthernet <i>port-list</i> } [port-channel <i>port-channel</i>   range port-channel <i>port-channel-list</i> }</b></p> <p>Enter interface configuration mode.</p>                                                                                                            |
| Step 4 | <p><b>spanning-tree guard tc</b></p> <p>Enable the TC Protect function on the port.</p> <p>TC Protect is to prevent the decrease of the performance and stability of the switch brought by continuously removing MAC address entries upon receiving TC-BPDUs in the network.</p>                                                                                                                                                                                                         |
| Step 5 | <p><b>show spanning-tree interface-security [ fastEthernet <i>port</i>   gigabitEthernet <i>port</i>   ten-gigabitEthernet <i>port</i>   port-channel <i>lagid</i> ] [ bpdupfilter   bpduguard   loop   root   tc   tc-defend ]</b><br/>(Optional) View the protect information of ports.</p> <p><i>port</i>: Specify the port number.</p> <p><i>lagid</i>: Specify the ID of the LAG.</p>                                                                                               |
| Step 6 | <p><b>end</b></p> <p>Return to privileged EXEC mode.</p>                                                                                                                                                                                                                                                                                                                                                                                                                                 |
| Step 7 | <p><b>copy running-config startup-config</b></p> <p>Save the settings in the configuration file.</p>                                                                                                                                                                                                                                                                                                                                                                                     |

This example shows how to enable the TC Protect function on port 1/0/3 with the TC threshold is 25 and the TC Protect Cycle is 8 :

```
Switch#configure
```

```
Switch(config)#spanning-tree tc-defend threshold 25 period 8
```

```
Switch(config)#interface ten-gigabitEthernet 1/0/3
```

```
Switch(config-if)#spanning-tree guard tc
```

```
Switch(config-if)#show spanning-tree interface-security ten-gigabitEthernet 1/0/3
```

| Interface | BPDU-Filter | BPDU-Guard | Loop-Protect | Root-Protect | TC-Protect |
|-----------|-------------|------------|--------------|--------------|------------|
| -----     | -----       | -----      | -----        | -----        | -----      |
| Te1/0/3   | Enable      | Enable     | Enable       | Enable       | Enable     |

```
Switch(config-if)#end
```

```
Switch#copy running-config startup-config
```

# 5 Configuration Example for MSTP

MSTP, backwards-compatible with STP and RSTP, can map VLANs to instances to enable load-balancing, thus providing a more flexible method in network management. Here we take the MSTP configuration as an example.

## 5.1 Network Requirements

As shown in Figure 5-1, the network consists of three switches. Traffic in VLAN 101-VLAN 106 is transmitted in this network. The link speed between the switches is 100Mb/s (the default path cost of the port is 200000).

It is required that traffic in VLAN 101 - VLAN 103 and traffic in VLAN 104 - VLAN 106 should be transmitted along different paths.

Figure 5-1 Network Topology

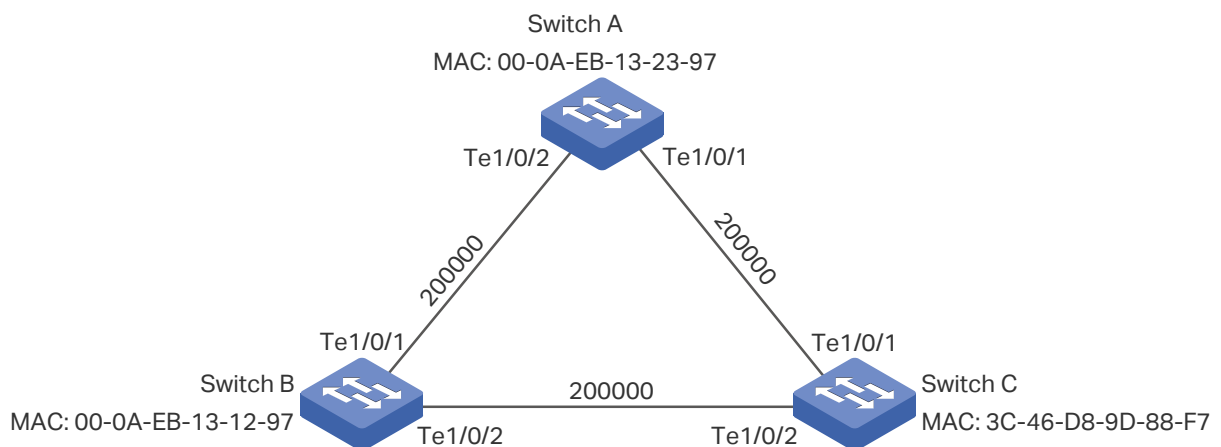

## 5.2 Configuration Scheme

To meet this requirement, you are suggested to configure MSTP function on the switches. Map the VLANs to different instances to ensure traffic can be transmitted along the respective instance.

Here we configure two instances to meet the requirement, as is shown below:



Figure 5-2 VLAN-Instance Mapping

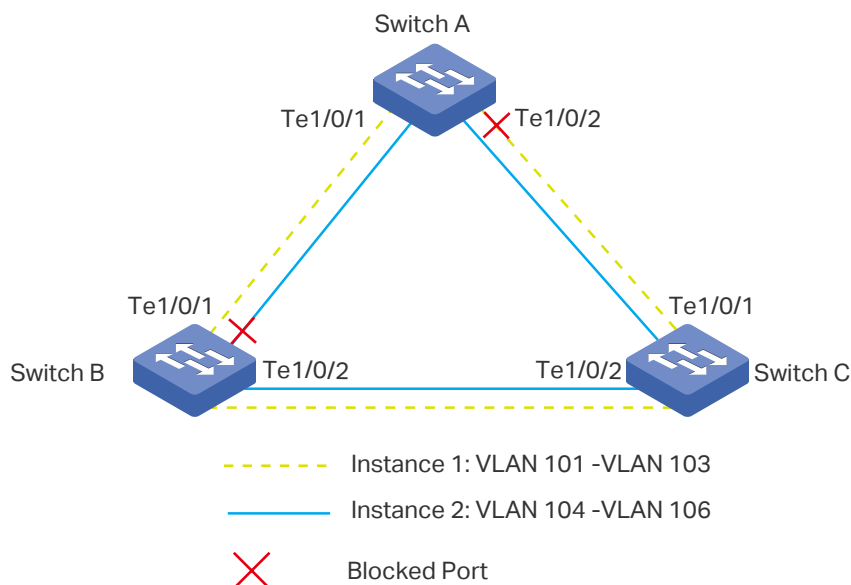

The overview of configuration is as follows:

- 1) Enable the Spanning Tree function on the ports in each switch.
- 2) Configure Switch A, Switch B and Switch C in the same region. Configure the region name as 1, and the revision level as 100. Map VLAN 101 - VLAN 103 to instance 1 and VLAN 104 - VLAN 106 to instance 2.
- 3) Configure the priority of Switch B as 0 to set it as the root bridge in instance 1; configure the priority of Switch C as 0 to set it as the root bridge in instance 2.
- 4) Configure the path cost to block the specified ports. For instance 1, set the path cost of port 1/0/1 of Switch A to be greater than the default path cost (200000). For instance 2, set the path cost of port 1/0/2 of Switch B to be greater than the default path cost (200000).
- 5) Enable MSTP function in all the switches.

Demonstrated with T1700X-16TS, this chapter provides configuration procedures in two ways: using the GUI and using the CLI.

## 5.3 Using the GUI

### ■ Configurations for Switch A

- 1) Choose the menu **Spanning Tree > STP Config > Port Config** to load the following page. Enable spanning tree function on port 1/0/1 and port 1/0/2. Here we leave the values of the other parameters as default settings.

Figure 5-3 Enable Spanning Tree Function on Ports

| Port Config                         |        |         |          |               |               |           |          |        |           |           |             |     |
|-------------------------------------|--------|---------|----------|---------------|---------------|-----------|----------|--------|-----------|-----------|-------------|-----|
| UNIT: 1 LAGS                        |        |         |          |               |               |           |          |        |           |           |             |     |
| Select                              | Port   | Status  | Priority | Ext-Path Cost | Int-Path Cost | Edge Port | P2P Link | MCheck | Port Mode | Port Role | Port Status | LAG |
| <input checked="" type="checkbox"/> | 1/0/1  | Enable  | 128      | Auto          | Auto          | Disable   | Auto     | ---    | ---       | ---       | ---         | --- |
| <input checked="" type="checkbox"/> | 1/0/2  | Enable  | 128      | Auto          | Auto          | Disable   | Auto     | ---    | ---       | ---       | ---         | --- |
| <input type="checkbox"/>            | 1/0/3  | Disable | 128      | Auto          | Auto          | Disable   | Auto     | ---    | ---       | ---       | ---         | --- |
| <input type="checkbox"/>            | 1/0/4  | Disable | 128      | Auto          | Auto          | Disable   | Auto     | ---    | ---       | ---       | ---         | --- |
| <input type="checkbox"/>            | 1/0/5  | Disable | 128      | Auto          | Auto          | Disable   | Auto     | ---    | ---       | ---       | ---         | --- |
| <input type="checkbox"/>            | 1/0/6  | Disable | 128      | Auto          | Auto          | Disable   | Auto     | ---    | ---       | ---       | ---         | --- |
| <input type="checkbox"/>            | 1/0/7  | Disable | 128      | Auto          | Auto          | Disable   | Auto     | ---    | ---       | ---       | ---         | --- |
| <input type="checkbox"/>            | 1/0/8  | Disable | 128      | Auto          | Auto          | Disable   | Auto     | ---    | ---       | ---       | ---         | --- |
| <input type="checkbox"/>            | 1/0/9  | Disable | 128      | Auto          | Auto          | Disable   | Auto     | ---    | ---       | ---       | ---         | --- |
| <input type="checkbox"/>            | 1/0/10 | Disable | 128      | Auto          | Auto          | Disable   | Auto     | ---    | ---       | ---       | ---         | --- |
| <input type="checkbox"/>            | 1/0/11 | Disable | 128      | Auto          | Auto          | Disable   | Auto     | ---    | ---       | ---       | ---         | --- |
| <input type="checkbox"/>            | 1/0/12 | Disable | 128      | Auto          | Auto          | Disable   | Auto     | ---    | ---       | ---       | ---         | --- |
| <input type="checkbox"/>            | 1/0/13 | Disable | 128      | Auto          | Auto          | Disable   | Auto     | ---    | ---       | ---       | ---         | --- |
| <input type="checkbox"/>            | 1/0/14 | Disable | 128      | Auto          | Auto          | Disable   | Auto     | ---    | ---       | ---       | ---         | --- |
| <input type="checkbox"/>            | 1/0/15 | Disable | 128      | Auto          | Auto          | Disable   | Auto     | ---    | ---       | ---       | ---         | --- |

- 2) Choose the menu **Spanning Tree > MSTP Instance > Region Config** to load the following page. Set the region name as 1 and the revision level as 100.

Figure 5-4 Configuring the MST Region

**Region Config**

Region Name :

Revision :  (0-65535)

- 3) Choose the menu **Spanning Tree > MSTP Instance > Instance Config** to load the following page. Map VLAN101-VLAN103 to instance 1; map VLAN104-VLAN106 to instance 2.

Figure 5-5 Configuring the VLAN-Instance Mapping

**VLAN-Instance Mapping**

Instance ID :  (0-8, 0 stand for CIST)

VLAN ID :  (1-4094, format: 1,3,4-7,11-30)

**Instance Config**

| Select                   | Instance ID | Status  | Priority             | VLAN ID              |                                                      |
|--------------------------|-------------|---------|----------------------|----------------------|------------------------------------------------------|
| <input type="checkbox"/> |             |         | <input type="text"/> | <input type="text"/> |                                                      |
| <input type="checkbox"/> | CIST        | Disable | 32768                | 1-100,104-4094,      | <a href="#">Show All</a>   <a href="#">Clear All</a> |
| <input type="checkbox"/> | 1           | Enable  | 32768                | 101-103,             | <a href="#">Show All</a>   <a href="#">Clear All</a> |
| <input type="checkbox"/> | 2           | Disable | 32768                |                      | <a href="#">Show All</a>   <a href="#">Clear All</a> |
| <input type="checkbox"/> | 3           | Disable | 32768                |                      | <a href="#">Show All</a>   <a href="#">Clear All</a> |
| <input type="checkbox"/> | 4           | Disable | 32768                |                      | <a href="#">Show All</a>   <a href="#">Clear All</a> |
| <input type="checkbox"/> | 5           | Disable | 32768                |                      | <a href="#">Show All</a>   <a href="#">Clear All</a> |
| <input type="checkbox"/> | 6           | Disable | 32768                |                      | <a href="#">Show All</a>   <a href="#">Clear All</a> |
| <input type="checkbox"/> | 7           | Disable | 32768                |                      | <a href="#">Show All</a>   <a href="#">Clear All</a> |
| <input type="checkbox"/> | 8           | Disable | 32768                |                      | <a href="#">Show All</a>   <a href="#">Clear All</a> |

- 4) Choose the menu **Spanning Tree > MSTP Instance > Instance Port Config** to load the following page. Set the path cost of port 1/0/1 in instance 1 as 400000.

Figure 5-6 Configure the Path Cost of Port 1/0/1 In Instance 1

**Instance ID Select**

Instance ID : 1 ▾

**Instance Port Config**

UNIT: 1 LAGS

| Select                   | Port   | Priority             | Path Cost            | Port Role | Port Status | LAG |
|--------------------------|--------|----------------------|----------------------|-----------|-------------|-----|
| <input type="checkbox"/> |        | <input type="text"/> | <input type="text"/> |           |             |     |
| <input type="checkbox"/> | 1/0/1  | 128                  | 400000               | ---       | ---         | --- |
| <input type="checkbox"/> | 1/0/2  | 128                  | Auto                 | ---       | ---         | --- |
| <input type="checkbox"/> | 1/0/3  | 128                  | Auto                 | ---       | ---         | --- |
| <input type="checkbox"/> | 1/0/4  | 128                  | Auto                 | ---       | ---         | --- |
| <input type="checkbox"/> | 1/0/5  | 128                  | Auto                 | ---       | ---         | --- |
| <input type="checkbox"/> | 1/0/6  | 128                  | Auto                 | ---       | ---         | --- |
| <input type="checkbox"/> | 1/0/7  | 128                  | Auto                 | ---       | ---         | --- |
| <input type="checkbox"/> | 1/0/8  | 128                  | Auto                 | ---       | ---         | --- |
| <input type="checkbox"/> | 1/0/9  | 128                  | Auto                 | ---       | ---         | --- |
| <input type="checkbox"/> | 1/0/10 | 128                  | Auto                 | ---       | ---         | --- |
| <input type="checkbox"/> | 1/0/11 | 128                  | Auto                 | ---       | ---         | --- |
| <input type="checkbox"/> | 1/0/12 | 128                  | Auto                 | ---       | ---         | --- |
| <input type="checkbox"/> | 1/0/13 | 128                  | Auto                 | ---       | ---         | --- |
| <input type="checkbox"/> | 1/0/14 | 128                  | Auto                 | ---       | ---         | --- |
| <input type="checkbox"/> | 1/0/15 | 128                  | Auto                 | ---       | ---         | --- |

All
Apply
Refresh
Help

- 5) Choose the menu **Spanning Tree > STP Config > STP Config** to load the following page. Enable MSTP function globally, here we leave the values of the other global parameters as default settings.

Figure 5-7 Configure the Global MSTP Parameters of the Switch

**Global Config**

Spanning-Tree :  Enable  Disable

Mode : MSTP ▼

---

**Parameters Config**

CIST Priority :  (0-61440, in increments of 4096)

Hello Time :  sec (1-10)

Max Age :  sec (6-40)

Forward Delay :  sec (4-30)

TxHoldCount :  pps (1-20)

Max Hops :  hop (1-40)

6) Click **Save Config** to save the settings.

■ **Configurations for Switch B**

1) Choose the menu **Spanning Tree > STP Config > Port Config** to load the following page. Enable the spanning tree function on port 1/0/1 and port 1/0/2. Here we leave the values of the other parameters as default settings.

Figure 5-8 Enable Spanning Tree Function on Ports

| Port Config                         |        |         |          |               |               |           |          |        |           |           |             |     |  |
|-------------------------------------|--------|---------|----------|---------------|---------------|-----------|----------|--------|-----------|-----------|-------------|-----|--|
| UNIT: 1 LAGS                        |        |         |          |               |               |           |          |        |           |           |             |     |  |
| Select                              | Port   | Status  | Priority | Ext-Path Cost | Int-Path Cost | Edge Port | P2P Link | MCheck | Port Mode | Port Role | Port Status | LAG |  |
| <input checked="" type="checkbox"/> | 1/0/1  | Enable  | 128      | Auto          | Auto          | Disable   | Auto     | ---    | ---       | ---       | ---         | --- |  |
| <input checked="" type="checkbox"/> | 1/0/2  | Enable  | 128      | Auto          | Auto          | Disable   | Auto     | ---    | ---       | ---       | ---         | --- |  |
| <input type="checkbox"/>            | 1/0/3  | Disable | 128      | Auto          | Auto          | Disable   | Auto     | ---    | ---       | ---       | ---         | --- |  |
| <input type="checkbox"/>            | 1/0/4  | Disable | 128      | Auto          | Auto          | Disable   | Auto     | ---    | ---       | ---       | ---         | --- |  |
| <input type="checkbox"/>            | 1/0/5  | Disable | 128      | Auto          | Auto          | Disable   | Auto     | ---    | ---       | ---       | ---         | --- |  |
| <input type="checkbox"/>            | 1/0/6  | Disable | 128      | Auto          | Auto          | Disable   | Auto     | ---    | ---       | ---       | ---         | --- |  |
| <input type="checkbox"/>            | 1/0/7  | Disable | 128      | Auto          | Auto          | Disable   | Auto     | ---    | ---       | ---       | ---         | --- |  |
| <input type="checkbox"/>            | 1/0/8  | Disable | 128      | Auto          | Auto          | Disable   | Auto     | ---    | ---       | ---       | ---         | --- |  |
| <input type="checkbox"/>            | 1/0/9  | Disable | 128      | Auto          | Auto          | Disable   | Auto     | ---    | ---       | ---       | ---         | --- |  |
| <input type="checkbox"/>            | 1/0/10 | Disable | 128      | Auto          | Auto          | Disable   | Auto     | ---    | ---       | ---       | ---         | --- |  |
| <input type="checkbox"/>            | 1/0/11 | Disable | 128      | Auto          | Auto          | Disable   | Auto     | ---    | ---       | ---       | ---         | --- |  |
| <input type="checkbox"/>            | 1/0/12 | Disable | 128      | Auto          | Auto          | Disable   | Auto     | ---    | ---       | ---       | ---         | --- |  |
| <input type="checkbox"/>            | 1/0/13 | Disable | 128      | Auto          | Auto          | Disable   | Auto     | ---    | ---       | ---       | ---         | --- |  |
| <input type="checkbox"/>            | 1/0/14 | Disable | 128      | Auto          | Auto          | Disable   | Auto     | ---    | ---       | ---       | ---         | --- |  |
| <input type="checkbox"/>            | 1/0/15 | Disable | 128      | Auto          | Auto          | Disable   | Auto     | ---    | ---       | ---       | ---         | --- |  |

2) Choose the menu **Spanning Tree > MSTP Instance > Region Config** to load the following page. Set the region name as 1 and the revision level as 100.

Figure 5-9 Configuring the Region

**Region Config**

Region Name :

Revision :  (0-65535)

- 3) Choose the menu **Spanning Tree > MSTP Instance > Instance Config** to load the following page. Map VLAN101-VLAN103 to instance 1; map VLAN104-VLAN106 to instance 2.

Figure 5-10 Configuring the VLAN-Instance Mapping

**VLAN-Instance Mapping**

Instance ID :  (0-8, 0 stand for CIST)

VLAN ID :  (1-4094, format: 1,3,4-7,11-30)

---

**Instance Config**

| Select                   | Instance ID | Status  | Priority             | VLAN ID              |                                                      |
|--------------------------|-------------|---------|----------------------|----------------------|------------------------------------------------------|
| <input type="checkbox"/> |             |         | <input type="text"/> | <input type="text"/> |                                                      |
| <input type="checkbox"/> | CIST        | Disable | 32768                | 1-100,104-4094,      | <a href="#">Show All</a>   <a href="#">Clear All</a> |
| <input type="checkbox"/> | 1           | Enable  | 32768                | 101-103,             | <a href="#">Show All</a>   <a href="#">Clear All</a> |
| <input type="checkbox"/> | 2           | Disable | 32768                |                      | <a href="#">Show All</a>   <a href="#">Clear All</a> |
| <input type="checkbox"/> | 3           | Disable | 32768                |                      | <a href="#">Show All</a>   <a href="#">Clear All</a> |
| <input type="checkbox"/> | 4           | Disable | 32768                |                      | <a href="#">Show All</a>   <a href="#">Clear All</a> |
| <input type="checkbox"/> | 5           | Disable | 32768                |                      | <a href="#">Show All</a>   <a href="#">Clear All</a> |
| <input type="checkbox"/> | 6           | Disable | 32768                |                      | <a href="#">Show All</a>   <a href="#">Clear All</a> |
| <input type="checkbox"/> | 7           | Disable | 32768                |                      | <a href="#">Show All</a>   <a href="#">Clear All</a> |
| <input type="checkbox"/> | 8           | Disable | 32768                |                      | <a href="#">Show All</a>   <a href="#">Clear All</a> |

- 4) Choose the menu **Spanning Tree > MSTP Instance > Instance Config** to load the following page. Configure the priority of Switch B as 0 to set it as the root bridge in instance 1.

Figure 5-11 Configuring the Priority of Switch B in Instance 1

**VLAN-Instance Mapping**

Instance ID :  (0-8, 0 stand for CIST)

VLAN ID :  (1-4094, format: 1,3,4-7,11-30)

**Instance Config**

| Select                   | Instance ID | Status  | Priority             | VLAN ID              |                                                      |
|--------------------------|-------------|---------|----------------------|----------------------|------------------------------------------------------|
| <input type="checkbox"/> |             |         | <input type="text"/> | <input type="text"/> |                                                      |
| <input type="checkbox"/> | CIST        | Disable | 32768                | 1-100,107-4094,      | <a href="#">Show All</a>   <a href="#">Clear All</a> |
| <input type="checkbox"/> | 1           | Enable  | 0                    | 101-103,             | <a href="#">Show All</a>   <a href="#">Clear All</a> |
| <input type="checkbox"/> | 2           | Enable  | 32768                | 104-106,             | <a href="#">Show All</a>   <a href="#">Clear All</a> |
| <input type="checkbox"/> | 3           | Disable | 32768                |                      | <a href="#">Show All</a>   <a href="#">Clear All</a> |
| <input type="checkbox"/> | 4           | Disable | 32768                |                      | <a href="#">Show All</a>   <a href="#">Clear All</a> |
| <input type="checkbox"/> | 5           | Disable | 32768                |                      | <a href="#">Show All</a>   <a href="#">Clear All</a> |
| <input type="checkbox"/> | 6           | Disable | 32768                |                      | <a href="#">Show All</a>   <a href="#">Clear All</a> |
| <input type="checkbox"/> | 7           | Disable | 32768                |                      | <a href="#">Show All</a>   <a href="#">Clear All</a> |
| <input type="checkbox"/> | 8           | Disable | 32768                |                      | <a href="#">Show All</a>   <a href="#">Clear All</a> |

- 5) Choose the menu **Spanning Tree > MSTP Instance > Instance Port Config** to load the following page. Set the path cost of port 1/0/2 in instance 2 as 400000.

Figure 5-12 Configure the Path Cost of Port 1/0/2 in Instance 2

**Instance ID Select**

Instance ID : 2 ▾

**Instance Port Config**

UNIT: 1 LAGS

| Select                   | Port   | Priority             | Path Cost            | Port Role | Port Status | LAG |
|--------------------------|--------|----------------------|----------------------|-----------|-------------|-----|
| <input type="checkbox"/> |        | <input type="text"/> | <input type="text"/> |           |             |     |
| <input type="checkbox"/> | 1/0/1  | 128                  | Auto                 | ---       | ---         | --- |
| <input type="checkbox"/> | 1/0/2  | 128                  | 400000               | ---       | ---         | --- |
| <input type="checkbox"/> | 1/0/3  | 128                  | Auto                 | ---       | ---         | --- |
| <input type="checkbox"/> | 1/0/4  | 128                  | Auto                 | ---       | ---         | --- |
| <input type="checkbox"/> | 1/0/5  | 128                  | Auto                 | ---       | ---         | --- |
| <input type="checkbox"/> | 1/0/6  | 128                  | Auto                 | ---       | ---         | --- |
| <input type="checkbox"/> | 1/0/7  | 128                  | Auto                 | ---       | ---         | --- |
| <input type="checkbox"/> | 1/0/8  | 128                  | Auto                 | ---       | ---         | --- |
| <input type="checkbox"/> | 1/0/9  | 128                  | Auto                 | ---       | ---         | --- |
| <input type="checkbox"/> | 1/0/10 | 128                  | Auto                 | ---       | ---         | --- |
| <input type="checkbox"/> | 1/0/11 | 128                  | Auto                 | ---       | ---         | --- |
| <input type="checkbox"/> | 1/0/12 | 128                  | Auto                 | ---       | ---         | --- |
| <input type="checkbox"/> | 1/0/13 | 128                  | Auto                 | ---       | ---         | --- |
| <input type="checkbox"/> | 1/0/14 | 128                  | Auto                 | ---       | ---         | --- |
| <input type="checkbox"/> | 1/0/15 | 128                  | Auto                 | ---       | ---         | --- |

All
Apply
Refresh
Help

- 6) Choose the menu **Spanning Tree > STP Config > STP Config** to load the following page. Enable MSTP function globally. Here we leave the values of the other global parameters as default settings.



Figure 5-13 Configuring the MSTP Globally

**Global Config**

Spanning-Tree :  Enable  Disable Apply

Mode : MSTP ▼

---

**Parameters Config**

CIST Priority :  (0-61440, in increments of 4096)

Hello Time :  sec (1-10)

Max Age :  sec (6-40) Apply

Forward Delay :  sec (4-30) Help

TxHoldCount :  pps (1-20)

Max Hops :  hop (1-40)

7) Click **Save Config** to save the settings.

■ **Configurations for Switch C**

1) Choose the menu **Spanning Tree > STP Config > Port Config** to load the following page. Enable the spanning tree function on port 1/0/1 and port 1/0/2. Here we leave the values of the other parameters as default settings.

Figure 5-14 Enable Spanning Tree Function on Ports

| Port Config                         |        |         |          |               |               |           |          |        |           |           |             |     |  |
|-------------------------------------|--------|---------|----------|---------------|---------------|-----------|----------|--------|-----------|-----------|-------------|-----|--|
| UNIT: 1 LAGS                        |        |         |          |               |               |           |          |        |           |           |             |     |  |
| Select                              | Port   | Status  | Priority | Ext-Path Cost | Int-Path Cost | Edge Port | P2P Link | MCheck | Port Mode | Port Role | Port Status | LAG |  |
| <input checked="" type="checkbox"/> | 1/0/1  | Enable  | 128      | Auto          | Auto          | Disable   | Auto     | ---    | ---       | ---       | ---         | --- |  |
| <input checked="" type="checkbox"/> | 1/0/2  | Enable  | 128      | Auto          | Auto          | Disable   | Auto     | ---    | ---       | ---       | ---         | --- |  |
| <input type="checkbox"/>            | 1/0/3  | Disable | 128      | Auto          | Auto          | Disable   | Auto     | ---    | ---       | ---       | ---         | --- |  |
| <input type="checkbox"/>            | 1/0/4  | Disable | 128      | Auto          | Auto          | Disable   | Auto     | ---    | ---       | ---       | ---         | --- |  |
| <input type="checkbox"/>            | 1/0/5  | Disable | 128      | Auto          | Auto          | Disable   | Auto     | ---    | ---       | ---       | ---         | --- |  |
| <input type="checkbox"/>            | 1/0/6  | Disable | 128      | Auto          | Auto          | Disable   | Auto     | ---    | ---       | ---       | ---         | --- |  |
| <input type="checkbox"/>            | 1/0/7  | Disable | 128      | Auto          | Auto          | Disable   | Auto     | ---    | ---       | ---       | ---         | --- |  |
| <input type="checkbox"/>            | 1/0/8  | Disable | 128      | Auto          | Auto          | Disable   | Auto     | ---    | ---       | ---       | ---         | --- |  |
| <input type="checkbox"/>            | 1/0/9  | Disable | 128      | Auto          | Auto          | Disable   | Auto     | ---    | ---       | ---       | ---         | --- |  |
| <input type="checkbox"/>            | 1/0/10 | Disable | 128      | Auto          | Auto          | Disable   | Auto     | ---    | ---       | ---       | ---         | --- |  |
| <input type="checkbox"/>            | 1/0/11 | Disable | 128      | Auto          | Auto          | Disable   | Auto     | ---    | ---       | ---       | ---         | --- |  |
| <input type="checkbox"/>            | 1/0/12 | Disable | 128      | Auto          | Auto          | Disable   | Auto     | ---    | ---       | ---       | ---         | --- |  |
| <input type="checkbox"/>            | 1/0/13 | Disable | 128      | Auto          | Auto          | Disable   | Auto     | ---    | ---       | ---       | ---         | --- |  |
| <input type="checkbox"/>            | 1/0/14 | Disable | 128      | Auto          | Auto          | Disable   | Auto     | ---    | ---       | ---       | ---         | --- |  |
| <input type="checkbox"/>            | 1/0/15 | Disable | 128      | Auto          | Auto          | Disable   | Auto     | ---    | ---       | ---       | ---         | --- |  |

All
Apply
Refresh
Help

2) Choose the menu **Spanning Tree > MSTP Instance > Region Config** to load the following page. Set the region name as 1 and the revision level as 100.

Figure 5-15 Configuring the Region

**Region Config**

Region Name :

Revision :  (0-65535)

- 3) Choose the menu **Spanning Tree > MSTP Instance > Instance Config** to load the following page. Map VLAN101-VLAN103 to instance 1; map VLAN104-VLAN106 to instance 2.

Figure 5-16 Configuring the VLAN-Instance Mapping

**VLAN-Instance Mapping**

Instance ID :  (0-8, 0 stand for CIST)

VLAN ID :  (1-4094, format: 1,3,4-7,11-30)

**Instance Config**

| Select                   | Instance ID | Status  | Priority             | VLAN ID              |                                                      |
|--------------------------|-------------|---------|----------------------|----------------------|------------------------------------------------------|
| <input type="checkbox"/> |             |         | <input type="text"/> | <input type="text"/> |                                                      |
| <input type="checkbox"/> | CIST        | Disable | 32768                | 1-100,104-4094,      | <a href="#">Show All</a>   <a href="#">Clear All</a> |
| <input type="checkbox"/> | 1           | Enable  | 32768                | 101-103,             | <a href="#">Show All</a>   <a href="#">Clear All</a> |
| <input type="checkbox"/> | 2           | Disable | 32768                |                      | <a href="#">Show All</a>   <a href="#">Clear All</a> |
| <input type="checkbox"/> | 3           | Disable | 32768                |                      | <a href="#">Show All</a>   <a href="#">Clear All</a> |
| <input type="checkbox"/> | 4           | Disable | 32768                |                      | <a href="#">Show All</a>   <a href="#">Clear All</a> |
| <input type="checkbox"/> | 5           | Disable | 32768                |                      | <a href="#">Show All</a>   <a href="#">Clear All</a> |
| <input type="checkbox"/> | 6           | Disable | 32768                |                      | <a href="#">Show All</a>   <a href="#">Clear All</a> |
| <input type="checkbox"/> | 7           | Disable | 32768                |                      | <a href="#">Show All</a>   <a href="#">Clear All</a> |
| <input type="checkbox"/> | 8           | Disable | 32768                |                      | <a href="#">Show All</a>   <a href="#">Clear All</a> |

- 4) Choose the menu **Spanning Tree > MSTP Instance > Instance Config** to load the following page. Configure the priority of Switch C as 0 to set it as the root bridge in instance 2.

Figure 5-17 Configuring the Priority of Switch C in Instance 2

**VLAN-Instance Mapping**

Instance ID :  (0-8, 0 stand for CIST)

VLAN ID :  (1-4094, format: 1,3,4-7,11-30)

**Instance Config**

| Select                              | Instance ID | Status  | Priority             | VLAN ID              |                                                      |
|-------------------------------------|-------------|---------|----------------------|----------------------|------------------------------------------------------|
| <input type="checkbox"/>            |             |         | <input type="text"/> | <input type="text"/> |                                                      |
| <input type="checkbox"/>            | CIST        | Disable | 32768                | 1-100,107-4094,      | <a href="#">Show All</a>   <a href="#">Clear All</a> |
| <input type="checkbox"/>            | 1           | Enable  | 32768                | 101-103,             | <a href="#">Show All</a>   <a href="#">Clear All</a> |
| <input checked="" type="checkbox"/> | 2           | Enable  | 0                    | 104-106,             | <a href="#">Show All</a>   <a href="#">Clear All</a> |
| <input type="checkbox"/>            | 3           | Disable | 32768                |                      | <a href="#">Show All</a>   <a href="#">Clear All</a> |
| <input type="checkbox"/>            | 4           | Disable | 32768                |                      | <a href="#">Show All</a>   <a href="#">Clear All</a> |
| <input type="checkbox"/>            | 5           | Disable | 32768                |                      | <a href="#">Show All</a>   <a href="#">Clear All</a> |
| <input type="checkbox"/>            | 6           | Disable | 32768                |                      | <a href="#">Show All</a>   <a href="#">Clear All</a> |
| <input type="checkbox"/>            | 7           | Disable | 32768                |                      | <a href="#">Show All</a>   <a href="#">Clear All</a> |
| <input type="checkbox"/>            | 8           | Disable | 32768                |                      | <a href="#">Show All</a>   <a href="#">Clear All</a> |

- Choose the menu **Spanning Tree > STP Instance > STP Config** to load the following page. Enable MSTP function globally, here we leave the values of the other global parameters as default settings.

Figure 5-18 Configuring the MSTP Globally

**Global Config**

Spanning-Tree :  Enable  Disable

Mode : MSTP ▾

**Parameters Config**

CIST Priority :  (0-61440, in increments of 4096)

Hello Time :  sec (1-10)

Max Age :  sec (6-40)

Forward Delay :  sec (4-30)

TxHoldCount :  pps (1-20)

Max Hops :  hop (1-40)

- Click **Save Config** to save the settings.

## 5.4 Using the CLI

### ■ Configurations for Switch A

- 1) Enable the spanning tree function on port 1/0/1 and port 1/0/2, and specify the path cost of port 1/0/1 in instance 1 as 400000.

```
Switch#configure
```

```
Switch(config)#interface ten-gigabitEthernet 1/0/1
```

```
Switch(config-if)#spanning-tree
```

```
Switch(config-if)#spanning-tree mst instance 1 cost 400000
```

```
Switch(config-if)#exit
```

```
Switch(config)#interface ten-gigabitEthernet 1/0/2
```

```
Switch(config-if)#spanning-tree
```

```
Switch(config-if)#exit
```

- 2) Configure the region name as 1, the revision number as 100; map VLAN101-VLAN103 to instance 1; map VLAN104-VLAN106 to instance 2:

```
Switch(config)#spanning-tree mst configuration
```

```
Switch(config-mst)#name 1
```

```
Switch(config-mst)#revision 100
```

```
Switch(config-mst)#instance 1 vlan 101-103
```

```
Switch(config-mst)#instance 2 vlan 104-106
```

```
Switch(config-mst)#exit
```

- 3) Configure the spanning tree mode as MSTP, then enable spanning tree function globally.

```
Switch(config)#spanning-tree mode mstp
```

```
Switch(config)#spanning-tree
```

```
Switch(config)#end
```

```
Switch#copy running-config startup-config
```

### ■ Configurations for Switch B

- 1) Enable the spanning tree function on port 1/0/1 and port 1/0/2, and specify the path cost of port 1/0/2 in instance 2 as 400000.

```
Switch#configure
```

```
Switch(config)#interface ten-gigabitEthernet 1/0/2
```

```
Switch(config-if)#spanning-tree
Switch(config-if)#spanning-tree mst instance 2 cost 400000
Switch(config-if)#exit
Switch(config)#interface ten-gigabitEthernet 1/0/1
Switch(config-if)#spanning-tree
Switch(config-if)#exit
```

- 2) Configure the region name as 1, the revision number as 100; map VLAN101-VLAN103 to instance 1; map VLAN104-VLAN106 to instance 2; configure the priority of Switch B in instance 1 as 0 to set it as the root bridge in instance 1:

```
Switch(config)#spanning-tree mst configuration
Switch(config-mst)#name 1
Switch(config-mst)#revision 100
Switch(config-mst)#instance 1 vlan 101-103
Switch(config-mst)#instance 2 vlan 104-106
Switch(config-mst)#exit
Switch(config)#spanning-tree mst instance 1 priority 0
```

- 3) Configure the spanning tree mode as MSTP, then enable spanning tree function globally.

```
Switch(config)#spanning-tree mode mstp
Switch(config)#spanning-tree
Switch(config)#end
Switch#copy running-config startup-config
```

#### ■ Configurations for Switch C

- 1) Enable the spanning tree function on port 1/0/1 and port 1/0/2.

```
Switch#configure
Switch(config)#interface range ten-gigabitEthernet 1/0/1-2
Switch(config-if-range)#spanning-tree
Switch(config-if-range)#exit
```

- 2) Configure the region name as 1, the revision number as 100; map VLAN101-VLAN103 to instance 1; map VLAN104-VLAN106 to instance 2; configure the priority of Switch C in instance 2 as 0 to set it as the root bridge in instance 2:

```
Switch(config)#spanning-tree mst configuration
```

```
Switch(config-mst)#name 1
Switch(config-mst)#revision 100
Switch(config-mst)#instance 1 vlan 101-103
Switch(config-mst)#instance 2 vlan 104-106
Switch(config-mst)#exit
Switch(config)#spanning-tree mst instance 2 priority 0
```

- 3) Configure the spanning tree mode as MSTP, then enable spanning tree function globally.

```
Switch(config)#spanning-tree mode mstp
Switch(config)#spanning-tree
Switch(config)#end
Switch#copy running-config startup-config
```

## Verify the Configurations

### Switch A

Verify the configurations of Switch A in instance 1:

```
Switch(config)#show spanning-tree mst instance 1
```

```
MST-Instance 1
```

```
Root Bridge
```

```
Priority    :0
```

```
Address    :00-0a-eb-13-12-ba
```

```
Internal Cost : 400000
```

```
Root Port  :1
```

```
Designated Bridge
```

```
Priority    :0
```

```
Address    :00-0a-eb-13-12-ba
```

```
Local Bridge
```

```
Priority    :32768
```

```
Address    :00-0a-eb-13-23-97
```

```
Interface Prio  Cost          Role  Status  LAG
```

```
-----
```

```

Te1/0/1 128 400000 Root Fwd N/A
Te1/0/2 128 200000 Altn Blk N/A

```

Verify the configurations of Switch A in instance 2:

```
Switch(config)#show spanning-tree mst instance 2
```

```
MST-Instance 2
```

```
Root Bridge
```

```
Priority :0
```

```
Address :3c-46-d8-9d-88-f7
```

```
Internal Cost : 200000
```

```
Root Port :2
```

```
Designated Bridge
```

```
Priority :0
```

```
Address :3c-46-d8-9d-88-f7
```

```
Local Bridge
```

```
Priority :32768
```

```
Address :00-0a-eb-13-23-97
```

```

Interface Prio Cost Role Status LAG
-----
Te1/0/1 128 200000 Desg Fwd N/A
Te1/0/2 128 200000 Root Fwd N/A

```

#### ■ Switch B

Verify the configurations of Switch B in instance 1:

```
Switch(config)#show spanning-tree mst instance 1
```

```
MST-Instance 1
```

```
Root Bridge
```

```
Priority :0
```

```
Address :00-0a-eb-13-12-ba
```

```
Local bridge is the root bridge
```

```
Designated Bridge
```

```

Priority :0
Address :00-0a-eb-13-12-ba
Local Bridge
Priority :0
Address :00-0a-eb-13-12-ba
Interface Prio Cost Role Status
-----
Te1/0/1 128 200000 Desg Fwd
Te1/0/2 128 200000 Desg Fwd

```

Verify the configurations of Switch B in instance 2:

```
Switch(config)#show spanning-tree mst instance 2
```

```

MST-Instance 2
Root Bridge
Priority :0
Address :3c-46-d8-9d-88-f7
Internal Cost : 400000
Root Port :2
Designated Bridge
Priority :0
Address :3c-46-d8-9d-88-f7
Local Bridge
Priority :32768
Address :00-0a-eb-13-12-ba
Interface Prio Cost Role Status
-----
Te1/0/1 128 200000 Altn Blk
Te1/0/2 128 200000 Root Fwd

```

#### ■ Switch C

Verify the configurations of Switch C in instance 1:



```
Switch(config)#show spanning-tree mst instance 1
MST-Instance 1
Root Bridge
Priority   :0
Address   :00-0a-eb-13-12-ba
Internal Cost : 200000
Root Port : 2
Designated Bridge
Priority   :0
Address   :00-0a-eb-13-12-ba
Local Bridge
Priority   :32768
Address   :3c-46-d8-9d-88-f7
Interface Prio Cost Role Status
-----
Te1/0/1 128 200000 Desg Fwd
Te1/0/2 128 200000 Root Fwd
```

Verify the configurations of Switch C in instance 2:

```
Switch(config)#show spanning-tree mst instance 2
MST-Instance 2
Root Bridge
Priority   :0
Address   :3c-46-d8-9d-88-f7
Local bridge is the root bridge
Designated Bridge
Priority   :0
Address   :3c-46-d8-9d-88-f7
Local Bridge
Priority   :0
```

Address : 3c-46-d8-9d-88-f7

| Interface | Prio  | Cost   | Role  | Status |
|-----------|-------|--------|-------|--------|
| -----     | ----- | -----  | ----- | -----  |
| Te1/0/1   | 128   | 200000 | Desg  | Fwd    |
| Te1/0/2   | 128   | 200000 | Desg  | Fwd    |

# 6 Appendix: Default Parameters

Default settings of the Spanning Tree feature are listed in the following table.

Table 6-1 Default Settings of the Global Parameters

| Parameter     | Default Setting |
|---------------|-----------------|
| Spanning-tree | Disable         |
| Mode          | STP             |
| CIST Priority | 32768           |
| Hello Time    | 2 seconds       |
| Max Age       | 20 seconds      |
| Forward Delay | 15 seconds      |
| TxHoldCount   | 5 pps           |
| Max Hops      | 20 hops         |

Table 6-2 Default Settings of the Port Parameters

| Parameter     | Default Setting |
|---------------|-----------------|
| Status        | Disable         |
| Priority      | 128             |
| Ext-Path Cost | Auto            |
| In-Path Cost  | Auto            |
| Edge Port     | Disable         |
| P2P Link      | Auto            |
| MCheck        | -----           |

Table 6-3 Default Settings of the MSTP Instance

| Parameter | Default Setting |
|-----------|-----------------|
| Status    | Disable         |
| Priority  | 32768           |

| Parameter     | Default Setting |
|---------------|-----------------|
| Port Priority | 128             |
| Path Cost     | Auto            |

# Part 12

## Configuring Layer 2 Multicast

### CHAPTERS

1. Layer 2 Multicast
2. IGMP Snooping Configurations
3. Configuring MLD Snooping
4. Viewing Multicast Snooping Configurations
5. Configuration Examples
6. Appendix: Default Parameters

# 1 Layer 2 Multicast

## 1.1 Overview

In a point-to-multipoint network, packets can be sent in three ways: unicast, broadcast and multicast. With unicast, many copies of the same information will be sent to all the receivers, occupying a large bandwidth.

With broadcast, information will be sent to all users in the network no matter they need it or not, wasting network resources and impacting information security.

Multicast, however, solves all the problems caused by unicast and broadcast. With multicast, the source only need to send one piece of information, and all and only the users who need the information will receive copies of the information. In a point-to-multipoint network, multicast technology not only transmits data with high efficiency, but also saves a large bandwidth and reduces network load.

In practical applications, Internet information provider can provide value-added services such as Online Live, IPTV, Distance Education, Telemedicine, Internet Radio and Real-time Video Conferences more conveniently using multicast.

Layer 2 Multicast allows Layer 2 switches to listen for IGMP packets between Layer 3 devices and user hosts to establish multicast forwarding table and to manage and control transmission of packets.

Take IGMP Snooping as an example. When IGMP Snooping is disabled on the Layer 2 device, multicast packets will be broadcast in the Layer 2 network; when IGMP Snooping is enabled on the Layer 2 device, multicast data from a known multicast group will be transmitted to the designated receivers instead of being broadcast in the Layer2 network.

Demonstrated as below:

Figure 1-1 IGMP Snooping

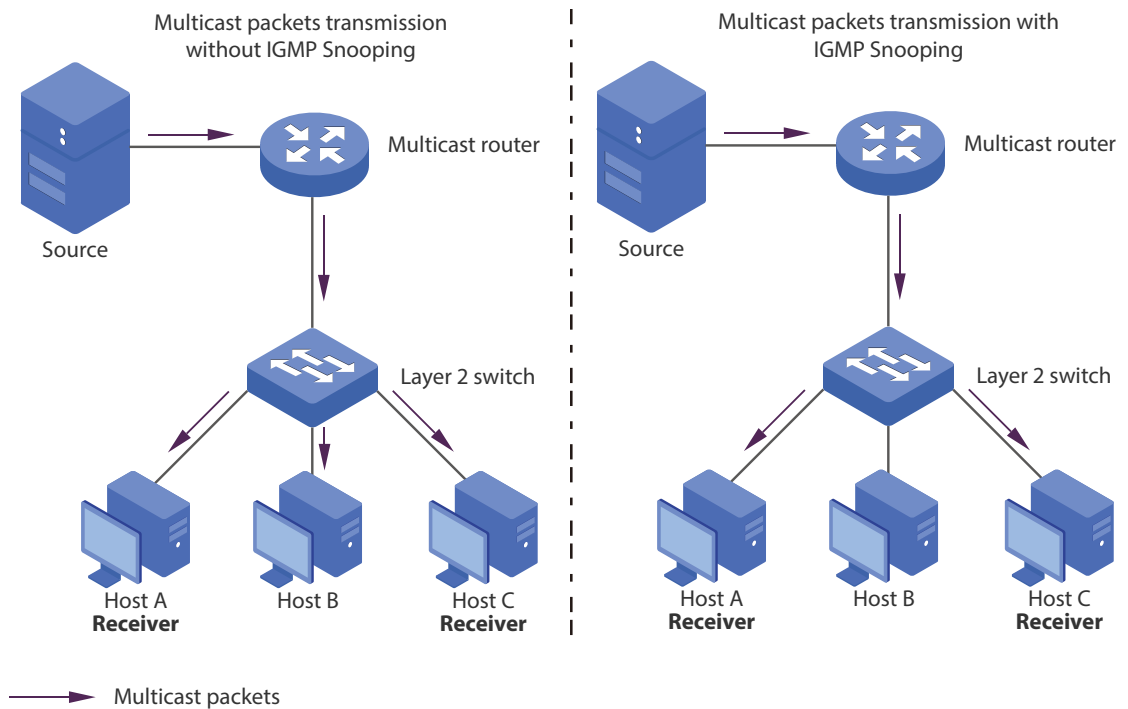

## 1.2 Supported Layer 2 Multicast Protocols

- Layer 2 Multicast protocol for IPv4: IGMP Snooping

On the Layer 2 device, IGMP Snooping transmits data on demand on data link layer by analyzing IGMP packets between Layer 3 devices and users, to build and maintain Layer 2 multicast forwarding table.

- Layer 2 Multicast protocol for IPv6: MLD Snooping

On the Layer 2 device, MLD Snooping (Multicast Listener Discovery Snooping) transmits data on demand on data link layer by analyzing IGMP packets between Layer 3 devices and users, to build and maintain Layer 2 multicast forwarding table.

# 2 IGMP Snooping Configurations

## 2.1 Using the GUI

### 2.1.1 Configuring IGMP Snooping Globally

Choose the menu **Multicast > IGMP Snooping > Snooping Config** to load the following page.

Figure 2-1 IGMP Snooping Global Config

**Global Config**

IGMP Snooping  Enable  Disable  
 Unknown Multicast  Forward  Discard  
 Report Message Suppression  Enable  Disable

Router Port Time  sec (60-600)

Member Port Time  sec (60-600)

Last Listener Query Interval:  secs(1-5)

Last Listener Query Count:  (1-5)

**IGMP Snooping Status**

| Description  | Member |
|--------------|--------|
| Enable ports |        |
| Enable VLAN  |        |

#### Enabling IGMP Snooping Globally

Before configuring functions related to IGMP Snooping, enable IGMP Snooping globally first.

- 1) Select **Enable** to enable IGMP Snooping globally.
- 2) Click **Apply**.

#### (Optional) Configuring Unknown Multicast

Unknown Multicast decides how to process the multicast data when its destination multicast address is not in the multicast forwarding table of the switch.



For switches that support MLD Snooping, IGMP Snooping and MLD Snooping share the setting of Unknown Multicast, so you have to enable MLD Snooping globally on the **Multicast > MLD Snooping > Snooping Config** page at the same time.

Follow these steps to configure unknown multicast.

- 1) Configure Unknown Multicast as Forward or Discard.

---

|                          |                                                                                                                                                                                                                                                                 |
|--------------------------|-----------------------------------------------------------------------------------------------------------------------------------------------------------------------------------------------------------------------------------------------------------------|
| <b>Unknown Multicast</b> | Configure the way how the switch processes the multicast data sent to unknown multicast groups as Forward or Discard. Unknown multicast groups are multicast groups whose destination multicast address is not in the multicast forwarding table of the switch. |
|--------------------------|-----------------------------------------------------------------------------------------------------------------------------------------------------------------------------------------------------------------------------------------------------------------|

---

- 2) Click **Apply**.

### (Optional) Configuring Report Message Suppression

Enabling Report Message Suppression can reduce the number of packets in the network.

Follow these steps to configure report message suppression.

- 1) Enable or disable Report Message Suppression globally.

---

|                                   |                                                                                                                                                                                                                                                            |
|-----------------------------------|------------------------------------------------------------------------------------------------------------------------------------------------------------------------------------------------------------------------------------------------------------|
| <b>Report Message Suppression</b> | If this function is enabled, the switch will only forward the first IGMP report message to Layer 3 devices and suppress subsequent IGMP report messages from the same multicast group during one query interval, which reduces the number of IGMP packets. |
|-----------------------------------|------------------------------------------------------------------------------------------------------------------------------------------------------------------------------------------------------------------------------------------------------------|

---

- 2) Click **Apply**.

### Configuring Router Port Time and Member Port Time

Follow these steps to configure the aging time of the router ports and the member ports:

- 1) Specify the aging time of the router ports.

---

|                         |                                                                                                                                                                                                                                                                                                                                                  |
|-------------------------|--------------------------------------------------------------------------------------------------------------------------------------------------------------------------------------------------------------------------------------------------------------------------------------------------------------------------------------------------|
| <b>Router Port Time</b> | Router ports are ports connected to Layer 3 devices on the switch. The router port ages if the switch does not receive IGMP query message from the router port within the router port time. The switch will no longer consider this port as a router port and delete it from the router port table. The valid values are from 60 to 600 seconds. |
|-------------------------|--------------------------------------------------------------------------------------------------------------------------------------------------------------------------------------------------------------------------------------------------------------------------------------------------------------------------------------------------|

---

- 2) Specify the aging time of the member ports.

---

|                         |                                                                                                                                                                                                                                                                                                                                                                                                                                                               |
|-------------------------|---------------------------------------------------------------------------------------------------------------------------------------------------------------------------------------------------------------------------------------------------------------------------------------------------------------------------------------------------------------------------------------------------------------------------------------------------------------|
| <b>Member Port Time</b> | Member ports are ports connected to multicast group members on the switch. A port is considered to be a member port when it is added to a multicast group. The member port ages if the switch does not receive IGMP membership report message from the member port within the member port time. The switch will no longer consider this port as a member port and delete it from the multicast forwarding table. The valid values are from 60 to 600 seconds. |
|-------------------------|---------------------------------------------------------------------------------------------------------------------------------------------------------------------------------------------------------------------------------------------------------------------------------------------------------------------------------------------------------------------------------------------------------------------------------------------------------------|

---

- 3) Click **Apply**.

## Configuring IGMP Snooping Last Listener Query

Configure the Last Listener Query Interval and Last Listener Query Count when the switch receives an IGMP leave message. If specified count of Multicast-Address-Specific Queries (MASQs) are sent and no report message is received, the switch will delete the multicast address from the multicast forwarding table.

Follow these steps to configure Last Listener Query Interval and Last Listener Query Count in the **Global Config** section:

- 1) Specify the interval between MASQs.

---

|                                     |                                                                                                                                                                                                                                                                                                                                                            |
|-------------------------------------|------------------------------------------------------------------------------------------------------------------------------------------------------------------------------------------------------------------------------------------------------------------------------------------------------------------------------------------------------------|
| <b>Last Listener Query Interval</b> | When the switch receives an IGMP leave message, the switch obtains the address of the multicast group that the host wants to leave from the message. Then the switch sends out MASQs to this multicast group through the port receiving the leave message. This parameter determines the interval between MASQs. The valid values are from 1 to 5 seconds. |
|-------------------------------------|------------------------------------------------------------------------------------------------------------------------------------------------------------------------------------------------------------------------------------------------------------------------------------------------------------------------------------------------------------|

---

- 2) Specify the number of MASQs to be sent.

---

|                                  |                                                                                                                                                                                                                                                                                                                                                        |
|----------------------------------|--------------------------------------------------------------------------------------------------------------------------------------------------------------------------------------------------------------------------------------------------------------------------------------------------------------------------------------------------------|
| <b>Last Listener Query Count</b> | When the switch receives an IGMP leave message, the switch obtains the address of the multicast group that the host wants to leave from the message. Then the switch sends out MASQs to this multicast group through the port receiving the leave message. This parameter determines the number of MASQs to be sent. The valid values are from 1 to 5. |
|----------------------------------|--------------------------------------------------------------------------------------------------------------------------------------------------------------------------------------------------------------------------------------------------------------------------------------------------------------------------------------------------------|

---

- 3) Click **Apply**.

## Verifying IGMP Snooping Status

IGMP Snooping Status Table displays VLANs and ports with IGMP Snooping enabled.

## 2.1.2 Configuring the Port's Basic IGMP Snooping Features

Choose the menu **Multicast > IGMP Snooping > Port Config** to load the following page.

Figure 2-2 Enable IGMP Snooping on Port

| Port Config                               |        |                                 |                                 |     |
|-------------------------------------------|--------|---------------------------------|---------------------------------|-----|
| UNIT: <input type="text" value="1"/> LAGS |        |                                 |                                 |     |
| Select                                    | Port   | IGMP Snooping                   | Fast Leave                      | LAG |
| <input type="checkbox"/>                  |        | <input type="text" value=""/> ▾ | <input type="text" value=""/> ▾ |     |
| <input type="checkbox"/>                  | 1/0/1  | Disable                         | Enable                          | --- |
| <input type="checkbox"/>                  | 1/0/2  | Disable                         | Enable                          | --- |
| <input type="checkbox"/>                  | 1/0/3  | Disable                         | Enable                          | --- |
| <input type="checkbox"/>                  | 1/0/4  | Disable                         | Disable                         | --- |
| <input type="checkbox"/>                  | 1/0/5  | Disable                         | Disable                         | --- |
| <input type="checkbox"/>                  | 1/0/6  | Disable                         | Disable                         | --- |
| <input type="checkbox"/>                  | 1/0/7  | Disable                         | Disable                         | --- |
| <input type="checkbox"/>                  | 1/0/8  | Disable                         | Disable                         | --- |
| <input type="checkbox"/>                  | 1/0/9  | Disable                         | Disable                         | --- |
| <input type="checkbox"/>                  | 1/0/10 | Disable                         | Disable                         | --- |
| <input type="checkbox"/>                  | 1/0/11 | Disable                         | Disable                         | --- |
| <input type="checkbox"/>                  | 1/0/12 | Disable                         | Disable                         | --- |
| <input type="checkbox"/>                  | 1/0/13 | Disable                         | Disable                         | --- |
| <input type="checkbox"/>                  | 1/0/14 | Disable                         | Disable                         | --- |
| <input type="checkbox"/>                  | 1/0/15 | Disable                         | Disable                         | --- |

### Enabling IGMP Snooping on the Port

Follow these steps to enable or disable IGMP Snooping on the port.

- 1) Select the port to be configured and select **Enable** under the IGMP Snooping column.
- 2) Click **Apply**.

### (Optional) Configuring Fast Leave

With Fast Leave enabled on a port, the switch will remove this port from the forwarding list of the corresponding multicast group once the port receives a leave message. Once deleted, the switch will no longer send MASQs to this port to verify if there are other members of this multicast group.

Follow these steps to configure fast leave.

- 1) Select the port to be configured and select **Enable** under the Fast Leave column.

**Fast Leave** With Fast Leave enabled on a port, the switch will remove this port from the forwarding list of the corresponding multicast group once the port receives a leave message. You should only use this function when there is a single receiver present on the port.

- 2) Click **Apply**.

### 2.1.3 Configuring IGMP Snooping in the VLAN

Choose the menu **Multicast > IGMP Snooping > VLAN Config** to load the following page.

Figure 2-3 IGMP Snooping in VLAN

VLAN Config

VLAN ID:  (1-4094)

Router Port Time:  sec (0,60-600, recommend: 300)

Member Port Time:  sec (0,60-600, recommend: 260)

Static Router Ports

UNIT:  LAGS

|                          |                          |                          |                          |                          |                          |                          |                          |
|--------------------------|--------------------------|--------------------------|--------------------------|--------------------------|--------------------------|--------------------------|--------------------------|
| <input type="checkbox"/> | <input type="checkbox"/> | <input type="checkbox"/> | <input type="checkbox"/> | <input type="checkbox"/> | <input type="checkbox"/> | <input type="checkbox"/> | <input type="checkbox"/> |
| <input type="checkbox"/> | <input type="checkbox"/> | <input type="checkbox"/> | <input type="checkbox"/> | <input type="checkbox"/> | <input type="checkbox"/> | <input type="checkbox"/> | <input type="checkbox"/> |

Forbidden Router Ports

UNIT:  LAGS

|                          |                          |                          |                          |                          |                          |                          |                          |
|--------------------------|--------------------------|--------------------------|--------------------------|--------------------------|--------------------------|--------------------------|--------------------------|
| <input type="checkbox"/> | <input type="checkbox"/> | <input type="checkbox"/> | <input type="checkbox"/> | <input type="checkbox"/> | <input type="checkbox"/> | <input type="checkbox"/> | <input type="checkbox"/> |
| <input type="checkbox"/> | <input type="checkbox"/> | <input type="checkbox"/> | <input type="checkbox"/> | <input type="checkbox"/> | <input type="checkbox"/> | <input type="checkbox"/> | <input type="checkbox"/> |

Unselected Port(s)  
  Selected Port(s)  
  Not Available for Selection

| Select                 | VLAN ID | Router Port Time | Member Port Time | Static Router Ports | Dynamic Router Ports | Forbidden Router Ports | Operation |
|------------------------|---------|------------------|------------------|---------------------|----------------------|------------------------|-----------|
| No entry in the table. |         |                  |                  |                     |                      |                        |           |

### Configuring IGMP Snooping Globally in the VLAN

In the VLAN Config section, follow these steps to configure relevant parameters for the designate VLAN.

- 1) Set up the VLAN that the router ports and the member ports are in. For details, please refer to *Configuring 802.1Q VLAN*.
- 2) Enable IGMP Snooping in the designate VLAN, and configure the aging time of the router ports and the member ports.

**VLAN ID** Specify the VLAN to enable IGMP Snooping.

|                         |                                                                                                                                                                                                                                                                                                                                                                                                                   |
|-------------------------|-------------------------------------------------------------------------------------------------------------------------------------------------------------------------------------------------------------------------------------------------------------------------------------------------------------------------------------------------------------------------------------------------------------------|
| <b>Router Port Time</b> | Specify the aging time of the router ports in the VLAN. If the router port does not receive any IGMP general query message within the router port time, the switch will no longer consider this port as a router port and delete it from the router port list. The valid values are from 60 to 600 seconds. When the router port time is 0, the VLAN uses the global time.                                        |
| <b>Member Port Time</b> | Specify the aging time of the member ports in the VLAN. If the member port does not receive any IGMP membership report message from the multicast group within the member port time, the switch will no longer consider this port as a member port and delete it from the multicast forwarding table. The valid values are from 60 to 600 seconds. When the member port time is 0, the VLAN uses the global time. |

- 3) Click **Create**.

### (Optional) Configuring the Static Router Ports in the VLAN

Follow these steps to configure static router ports in the designate VLAN:

- 1) Configure the router ports in the designate VLAN.

|                            |                                                                                                                                                        |
|----------------------------|--------------------------------------------------------------------------------------------------------------------------------------------------------|
| <b>VLAN ID</b>             | Specify the VLAN to be configured.                                                                                                                     |
| <b>Static Router Ports</b> | Select one or more ports to be the static router ports in the VLAN. All multicast data in this VLAN will be forwarded through the static router ports. |

- 2) Click **Create**.

### (Optional) Configuring the Forbidden Router Ports in the VLAN

Follow these steps to forbid the selected ports to be the router ports in the designate VLAN:

- 1) Configure the forbidden router ports in the designate VLAN.

|                               |                                                                      |
|-------------------------------|----------------------------------------------------------------------|
| <b>VLAN ID</b>                | Specify the VLAN to be configured.                                   |
| <b>Forbidden Router Ports</b> | Select the ports to forbid them from being router ports in the VLAN. |

- 2) Click **Create**.

## 2.1.4 Configuring the Multicast VLAN

In old multicast transmission mode, when users in different VLANs apply for data from the same multicast group, the Layer 3 device will duplicate this multicast data and deliver copies to the Layer 2 devices.

With Multicast VLAN configured, all multicast group members will be added to a VLAN. Layer 3 device only need to send one piece of multicast data to a Layer 2 device, and the Layer 2 device will send the data to all member ports of the VLAN. In this way, Multicast VLAN saves bandwidth and reduces network load of Layer 3 devices.

Choose the menu **Multicast > IGMP Snooping > Multicast VLAN** to load the following page.

Figure 2-4 Multicast VLAN Config

**Multicast VLAN**

Multicast VLAN:  Enable  Disable

VLAN ID:  (2-4094)

Router Port Time:  sec (0,60-600, recommend: 300)

Member Port Time:  sec (0,60-600, recommend: 260)

Replace Source IP:  (format:192.168.0.1)

**Dynamic Router Ports**

UNIT:  LAGS

|   |   |   |   |    |    |    |    |
|---|---|---|---|----|----|----|----|
| 2 | 4 | 6 | 8 | 10 | 12 | 14 | 16 |
| 1 | 3 | 5 | 7 | 9  | 11 | 13 | 15 |

**Static Router Ports**

UNIT:  LAGS

|   |   |   |   |    |    |    |    |
|---|---|---|---|----|----|----|----|
| 2 | 4 | 6 | 8 | 10 | 12 | 14 | 16 |
| 1 | 3 | 5 | 7 | 9  | 11 | 13 | 15 |

**Forbidden Router Ports**

UNIT:  LAGS

|   |   |   |   |    |    |    |    |
|---|---|---|---|----|----|----|----|
| 2 | 4 | 6 | 8 | 10 | 12 | 14 | 16 |
| 1 | 3 | 5 | 7 | 9  | 11 | 13 | 15 |

Unselected Port(s)

Selected Port(s)

Not Available for Selection

## Creating Multicast VLAN and Configuring Basic Settings

In the Multicast VLAN section, follow these steps to enable Multicast VLAN and to finish the basic settings:

- 1) Set up the VLAN that the router ports and the member ports are in. For details, please refer to [Configuring 802.1Q VLAN](#).
- 2) Enable Multicast VLAN, configure the specific VLAN to be the multicast VLAN, and configure the Router Port Time and Member Port Time.

|                       |                                                         |
|-----------------------|---------------------------------------------------------|
| <b>Multicast VLAN</b> | Select <b>Enable</b> to enable multicast VLAN function. |
| <b>VLAN ID</b>        | Specify the 802.1Q VLAN to be the multicast VLAN.       |

Configuration Guide ■ 293

|                         |                                                                                                                                                                                                                                                                                                                                                                                                                             |
|-------------------------|-----------------------------------------------------------------------------------------------------------------------------------------------------------------------------------------------------------------------------------------------------------------------------------------------------------------------------------------------------------------------------------------------------------------------------|
| <b>Router Port Time</b> | Specify the aging time of the router ports in the multicast VLAN. If the router port does not receive any IGMP general query message within the router port time, the switch will no longer consider this port as a router port and delete it from the router port table. The valid values are from 60 to 600 seconds. When the router port time is 0, the VLAN uses the global time.                                       |
| <b>Member Port Time</b> | Specify the aging time of the member ports in the multicast VLAN. If the member port does not receive any IGMP membership report message from the multicast group within the member port time, the switch will no longer consider this port as a member port and delete it from the multicast forwarding table. The valid values are from 60 to 600 seconds. When the member port time is 0, the VLAN uses the global time. |

- 3) Click **Apply**.

### (Optional) Creating Replace Source IP

This function allows you to use a new IP instead of the source IP to send data to multicast group members. In the Multicast VLAN section, follow these steps to configure Replace Source IP.

- 1) Configure the new multicast source IP.

|                          |                                                                                                                                                             |
|--------------------------|-------------------------------------------------------------------------------------------------------------------------------------------------------------|
| <b>Replace Source IP</b> | Enter the new source IP address. The switch will replace the source IP in the IGMP multicast data sent by the multicast VLAN with the IP address you enter. |
|--------------------------|-------------------------------------------------------------------------------------------------------------------------------------------------------------|

- 2) Click **Apply**.

### Viewing Dynamic Router Ports in the Multicast VLAN

This table displays all the dynamic router ports in the multicast VLAN.

### (Optional) Configuring the Static Router Ports

Follow these steps to configure static router ports in the multicast VLAN:

- 1) Configure the router ports in the multicast VLAN.

|                            |                                                                                                                                                        |
|----------------------------|--------------------------------------------------------------------------------------------------------------------------------------------------------|
| <b>VLAN ID</b>             | Specify the VLAN to be configured.                                                                                                                     |
| <b>Static Router Ports</b> | Select one or more ports to be the static router ports in the VLAN. All multicast data in this VLAN will be forwarded through the static router ports. |

- 2) Click **Apply**.

### (Optional) Configuring the Forbidden Router Ports

Follow these steps to forbid the selected ports to be the router ports in the multicast VLAN.

- 1) Configure the router ports in the designate VLAN.

|                |                                    |
|----------------|------------------------------------|
| <b>VLAN ID</b> | Specify the VLAN to be configured. |
|----------------|------------------------------------|

**Forbidden Router Ports** Select the ports to forbid them from being router ports in the VLAN.

2) Click **Apply**.

 **Note:**

When configuration is finished, all multicast data through the ports in the VLAN will be processed in this multicast VLAN.

### 2.1.5 (Optional) Configuring the Querier

IGMP Snooping Querier sends general query packets regularly to maintain the multicast forwarding table. Choose the menu **Multicast > IGMP Snooping > Querier Config** to load the following page.

Figure 2-5 Querier Config

**IGMP Snooping Querier Config**

VLAN ID:  (1-4094)

Query Interval:  secs(10-300)

Max Response Time:  secs(1-25)

General Query Source IP:  (format:192.168.0.1)

**IGMP Snooping Querier Table**

| Select                   | VLAN ID | Query Interval                | Max Response Time             | General Query Source IP       |
|--------------------------|---------|-------------------------------|-------------------------------|-------------------------------|
| <input type="checkbox"/> |         | <input type="text" value=""/> | <input type="text" value=""/> | <input type="text" value=""/> |
| <input type="checkbox"/> | 2       | 60                            | 10                            | 192.168.0.1                   |

### Configuring the Querier

Follow these steps to configure the querier.

1) Specify a VLAN and configure the querier on this VLAN.

|                                |                                                                                                                                           |
|--------------------------------|-------------------------------------------------------------------------------------------------------------------------------------------|
| <b>VLAN ID</b>                 | Specify the VLAN to be configured.                                                                                                        |
| <b>Query Interval</b>          | Enter the interval between general query messages sent by the querier. The valid values are from 10 to 300 seconds.                       |
| <b>Max Response Time</b>       | Enter the host's maximum response time to general query messages in a range of 1 to 25 seconds.                                           |
| <b>General Query Source IP</b> | Specify the source IP address of the general query messages sent by the querier. It cannot be a multicast address or a broadcast address. |

2) Click **Add**.

3) You can edit the settings in the IGMP Snooping Querier Table.



## Viewing Settings of IGMP Querier

The IGMP Snooping Querier Table displays all the related settings of the IGMP querier.

### 2.1.6 Configuring IGMP Profile

With IGMP Profile, the switch can define a blacklist or whitelist of multicast addresses so as to filter multicast sources. Choose the menu **Multicast > IGMP Snooping > Profile Config** to load the following page.

Figure 2-6 Profile Create

**Profile Creation**

Profile ID:  (1-999)

Mode:  Permit  Deny

**Search Option**

Search Option:

**IGMP Profile Info**

| Select                   | Profile ID | Mode | Bind Ports | Operation            |
|--------------------------|------------|------|------------|----------------------|
| <input type="checkbox"/> | 1          | Deny |            | <a href="#">Edit</a> |

### Creating Profile

Follow these steps to create a profile and configure its filtering mode.

- 1) Create a profile and configure its filtering mode.

|                   |                                                                                                                                                                                                                                                                                                                                           |
|-------------------|-------------------------------------------------------------------------------------------------------------------------------------------------------------------------------------------------------------------------------------------------------------------------------------------------------------------------------------------|
| <b>Profile ID</b> | Enter a profile ID between 1 and 999.                                                                                                                                                                                                                                                                                                     |
| <b>Mode</b>       | Select <b>Permit</b> or <b>Deny</b> as the filtering mode.<br><br><b>Permit:</b> similar to a whitelist, means that the switch only allows specified member ports to join specific multicast groups.<br><br><b>Deny:</b> similar to a blacklist, means that the switch disallows specific member ports to join specific multicast groups. |

- 2) Click **Create**.

### Searching Profile

Enter the search condition in the **Search Option** field to search the profile in the IGMP Profile Info table.

## Editing IP Range of the Profile

Follow these steps to edit profile mode and its IP range:

- 1) Click **Edit** in the IGMP Profile Info table. Edit its IP range and click **Add** to save the settings.

Figure 2-7 Add IP-range

**Profile mode**

Profile ID:

Mode:

---

**Add IP-range**

Start IP:  (Format:225.0.0.1)

End IP:  (Format:225.0.0.1)

---

**IP-range Table**

| Select                 | Index | Start IP | End IP |
|------------------------|-------|----------|--------|
| No entry in the table. |       |          |        |

|                   |                                                                                                                                                                                                                                                                                                                                           |
|-------------------|-------------------------------------------------------------------------------------------------------------------------------------------------------------------------------------------------------------------------------------------------------------------------------------------------------------------------------------------|
| <b>Profile ID</b> | Displays the ID of the profile to be edited.                                                                                                                                                                                                                                                                                              |
| <b>Mode</b>       | Select <b>Permit</b> or <b>Deny</b> as the filtering mode.<br><br><b>Permit:</b> similar to a whitelist, means that the switch only allows specified member ports to join specific multicast groups.<br><br><b>Deny:</b> similar to a blacklist, means that the switch disallows specific member ports to join specific multicast groups. |
| <b>Start IP</b>   | Specify the Start IP of the multicast IP range.                                                                                                                                                                                                                                                                                           |
| <b>End IP</b>     | Specify the End IP of the multicast IP range.                                                                                                                                                                                                                                                                                             |

- 2) In the IP-range Table, you can select an IP range and click **Delete** to delete an IP range.
- 3) Click **Submit** to save the settings; click **Back** to go back to the previous page.

### 2.1.7 Binding Profile and Member Ports

With this function, you can configure each port's filtering profile and the number of multicast groups a port can join. Choose the menu **Multicast > IGMP Snooping > Profile Binding** to load the following page.

Figure 2-8 Profile Binding

| Profile and Max Group Binding |        |                      |                      |                                                       |     |                              |
|-------------------------------|--------|----------------------|----------------------|-------------------------------------------------------|-----|------------------------------|
| UNIT: <b>1</b> LAGS           |        |                      |                      |                                                       |     |                              |
| Select                        | Port   | Profile ID           | Max Group            | Overflow Action                                       | LAG |                              |
| <input type="checkbox"/>      |        | <input type="text"/> | <input type="text"/> | <input type="text"/> <input type="button" value="v"/> |     |                              |
| <input type="checkbox"/>      | 1/0/1  |                      | 1000                 | Drop                                                  | --  | <a href="#">ClearBinding</a> |
| <input type="checkbox"/>      | 1/0/2  |                      | 1000                 | Drop                                                  | --  | <a href="#">ClearBinding</a> |
| <input type="checkbox"/>      | 1/0/3  |                      | 1000                 | Drop                                                  | --  | <a href="#">ClearBinding</a> |
| <input type="checkbox"/>      | 1/0/4  |                      | 1000                 | Drop                                                  | --  | <a href="#">ClearBinding</a> |
| <input type="checkbox"/>      | 1/0/5  |                      | 1000                 | Drop                                                  | --  | <a href="#">ClearBinding</a> |
| <input type="checkbox"/>      | 1/0/6  |                      | 1000                 | Drop                                                  | --  | <a href="#">ClearBinding</a> |
| <input type="checkbox"/>      | 1/0/7  |                      | 1000                 | Drop                                                  | --  | <a href="#">ClearBinding</a> |
| <input type="checkbox"/>      | 1/0/8  |                      | 1000                 | Drop                                                  | --  | <a href="#">ClearBinding</a> |
| <input type="checkbox"/>      | 1/0/9  |                      | 1000                 | Drop                                                  | --  | <a href="#">ClearBinding</a> |
| <input type="checkbox"/>      | 1/0/10 |                      | 1000                 | Drop                                                  | --  | <a href="#">ClearBinding</a> |
| <input type="checkbox"/>      | 1/0/11 |                      | 1000                 | Drop                                                  | --  | <a href="#">ClearBinding</a> |
| <input type="checkbox"/>      | 1/0/12 |                      | 1000                 | Drop                                                  | --  | <a href="#">ClearBinding</a> |
| <input type="checkbox"/>      | 1/0/13 |                      | 1000                 | Drop                                                  | --  | <a href="#">ClearBinding</a> |
| <input type="checkbox"/>      | 1/0/14 |                      | 1000                 | Drop                                                  | --  | <a href="#">ClearBinding</a> |
| <input type="checkbox"/>      | 1/0/15 |                      | 1000                 | Drop                                                  | --  | <a href="#">ClearBinding</a> |

### Binding Profile and Member Ports

Follow these steps to bind the profile to the port.

- 1) Select the port to be bound, and enter the Profile ID in the **Profile ID** column.

|              |                                                                                                             |
|--------------|-------------------------------------------------------------------------------------------------------------|
| Select       | Select the port to be bound.                                                                                |
| Port         | Displays the port number.                                                                                   |
| Profile ID   | Enter the profile ID you create to bind the profile to the port. One port can only be bound to one profile. |
| ClearBinding | Click to clear the binding between the profile and the port.                                                |

- 2) Click **Apply**.

### Configuring Max Groups a Port Can Join

Follow these steps to configure the maximum groups a port can join and overflow action.

- 1) Select a port to configure its Max Group and Overflow Action.

|        |                                   |
|--------|-----------------------------------|
| Select | Select the port to be configured. |
|--------|-----------------------------------|

|                        |                                                                                                                                                                                                                                                                                                                                                                                            |
|------------------------|--------------------------------------------------------------------------------------------------------------------------------------------------------------------------------------------------------------------------------------------------------------------------------------------------------------------------------------------------------------------------------------------|
| <b>Max Group</b>       | Enter the number of multicast groups the port can join. The valid values are from 0 to 1000.                                                                                                                                                                                                                                                                                               |
| <b>Overflow Action</b> | <p>Select the action towards the new multicast group when the number of multicast groups the port joined exceeds max group.</p> <p><b>Drop:</b> Drop all subsequent membership report messages, and the port will not join any new multicast groups.</p> <p><b>Replace:</b> Replace the existing multicast group owning the lowest multicast MAC address with the new multicast group.</p> |

2) Click **Apply**.

### 2.1.8 Viewing IGMP Statistics on Each Port

Choose the menu **Multicast > IGMP Snooping > Packet Statistic** to load the following page.

Figure 2-9 View IGMP Statistics on the Port

**Auto Refresh**

Auto Refresh:  Enable  Disable Apply

Refresh Period:  sec(3-300)

**IGMP Statistics**

UNIT:

| Port   | Query Packet | Report Packet(V1) | Report Packet(V2) | Report Packet(V3) | Leave Packet | Error Packet |
|--------|--------------|-------------------|-------------------|-------------------|--------------|--------------|
| 1/0/1  | 0            | 0                 | 0                 | 0                 | 0            | 0            |
| 1/0/2  | 0            | 0                 | 0                 | 0                 | 0            | 0            |
| 1/0/3  | 0            | 0                 | 0                 | 0                 | 0            | 0            |
| 1/0/4  | 0            | 0                 | 0                 | 0                 | 0            | 0            |
| 1/0/5  | 0            | 0                 | 0                 | 0                 | 0            | 0            |
| 1/0/6  | 0            | 0                 | 0                 | 0                 | 0            | 0            |
| 1/0/7  | 0            | 0                 | 0                 | 0                 | 0            | 0            |
| 1/0/8  | 0            | 0                 | 0                 | 0                 | 0            | 0            |
| 1/0/9  | 0            | 0                 | 0                 | 0                 | 0            | 0            |
| 1/0/10 | 0            | 0                 | 0                 | 0                 | 0            | 0            |
| 1/0/11 | 0            | 0                 | 0                 | 0                 | 0            | 0            |
| 1/0/12 | 0            | 0                 | 0                 | 0                 | 0            | 0            |
| 1/0/13 | 0            | 0                 | 0                 | 0                 | 0            | 0            |
| 1/0/14 | 0            | 0                 | 0                 | 0                 | 0            | 0            |
| 1/0/15 | 0            | 0                 | 0                 | 0                 | 0            | 0            |

Clear
Refresh
Help

### Configuring Auto Refresh

Follow these steps to configure auto refresh.

1) Enable or disable Auto Refresh.

|                       |                                                                                                                     |
|-----------------------|---------------------------------------------------------------------------------------------------------------------|
| <b>Auto Refresh</b>   | If Auto Refresh is enabled, statistics of IGMP packets on this page will refresh automatically.                     |
| <b>Refresh Period</b> | After Auto Refresh is enabled, enter the interval between each refresh. The valid values are from 3 to 300 seconds. |

2) Click **Apply**.

### Viewing IGMP Statistics

The IGMP Statistics table displays all kinds of IGMP statistics of all the ports.

## 2.1.9 Enabling IGMP Accounting and Authentication

Choose the menu **Multicast > IGMP Snooping > IGMP Authentication** to load the following page.

Figure 2-10 IGMP Accounting and Authentication

**Global Config**

Accounting  Enable  Disable Apply

**Port Config**

UNIT: 1 LAGS

| Select                   | Port   | IGMP Authentication                                            | LAG |
|--------------------------|--------|----------------------------------------------------------------|-----|
| <input type="checkbox"/> |        | <input type="text" value=""/> <input type="button" value="v"/> |     |
| <input type="checkbox"/> | 1/0/1  | Disable                                                        | --- |
| <input type="checkbox"/> | 1/0/2  | Disable                                                        | --- |
| <input type="checkbox"/> | 1/0/3  | Disable                                                        | --- |
| <input type="checkbox"/> | 1/0/4  | Disable                                                        | --- |
| <input type="checkbox"/> | 1/0/5  | Disable                                                        | --- |
| <input type="checkbox"/> | 1/0/6  | Disable                                                        | --- |
| <input type="checkbox"/> | 1/0/7  | Disable                                                        | --- |
| <input type="checkbox"/> | 1/0/8  | Disable                                                        | --- |
| <input type="checkbox"/> | 1/0/9  | Disable                                                        | --- |
| <input type="checkbox"/> | 1/0/10 | Disable                                                        | --- |
| <input type="checkbox"/> | 1/0/11 | Disable                                                        | --- |
| <input type="checkbox"/> | 1/0/12 | Disable                                                        | --- |
| <input type="checkbox"/> | 1/0/13 | Disable                                                        | --- |
| <input type="checkbox"/> | 1/0/14 | Disable                                                        | --- |
| <input type="checkbox"/> | 1/0/15 | Disable                                                        | --- |

All
Apply
Help

## Configuring IGMP Accounting Globally

To use this function, you should also enable Authentication, Authorization and Accounting (AAA) globally and configure RADIUS server on the switch.

Follow these steps to enable IGMP Accounting globally.

- 1) Enable IGMP Accounting globally.

---

Accounting

Select Enable to enable IGMP Snooping accounting.

---

- 2) Click **Apply**.

## Configuring IGMP Authentication on the Port

To use this function, you should also enable AAA globally and configure RADIUS server on the switch.

Follow these steps to enable IGMP Authentication on the port.

- 1) Specify the ports and enable IGMP Authentication.

---

IGMP  
Authentication

Select one or more ports and select **Enable** in the IGMP Authentication column.

---

- 2) Click **Apply**.

### 2.1.10 Configuring Static Member Port

This function allows you to specify a port as a static member port in the multicast group.

Choose the menu **Multicast > Multicast Table > Static IPv4 Multicast Table** to load the following page.

Figure 2-11 Static Member Port

**Create Static Multicast**

Multicast IP:  (Format: 225.0.0.1)

VLAN ID:  (1-4094)

Forward Port:

UNIT:  LAGS

|   |   |   |   |    |    |    |    |
|---|---|---|---|----|----|----|----|
| 2 | 4 | 6 | 8 | 10 | 12 | 14 | 16 |
| 1 | 3 | 5 | 7 | 9  | 11 | 13 | 15 |

Unselected Port(s)
  Selected Port(s)
  Not Available for Selection

**Search Option**

Search Option

**Static Multicast IP Table**

| Select                        | Multicast IP | VLAN ID | Forward Port |
|-------------------------------|--------------|---------|--------------|
| <b>No entry in the table.</b> |              |         |              |

### Configuring Static Member Port

Follow these steps to configure static member port.

- 1) Enter the Multicast IP and VLAN ID. Specify the Static Member Port.

|                     |                                                                                                                                                                                |
|---------------------|--------------------------------------------------------------------------------------------------------------------------------------------------------------------------------|
| <b>Multicast IP</b> | Specify the multicast group that the static member is in.                                                                                                                      |
| <b>VLAN ID</b>      | Specify the VLAN that the static member is in.                                                                                                                                 |
| <b>Forward Port</b> | Specify one or more ports to be the static member port in the multicast group. Without aging, the static member port receives all multicast data sent to this multicast group. |

- 2) Click **Create**.

### Viewing IGMP Static Multicast Groups

You can search IGMP static multicast entries by using Multicast IP, VLAN ID or Forward Port as the Search Option.

Static Multicast IP Table displays details of all IGMP static multicast groups.

## 2.2 Using the CLI

### 2.2.1 Enabling IGMP Snooping Globally

---

|        |                                                                                           |
|--------|-------------------------------------------------------------------------------------------|
| Step 1 | <b>configure</b><br>Enter global configuration mode.                                      |
| Step 2 | <b>ip igmp snooping</b><br>Enable IGMP Snooping Globally.                                 |
| Step 3 | <b>end</b><br>Return to privileged EXEC mode.                                             |
| Step 4 | <b>show ip igmp snooping</b><br>Show the basic IGMP snooping configuration.               |
| Step 5 | <b>copy running-config startup-config</b><br>Save the settings in the configuration file. |

---

### 2.2.2 Enabling IGMP Snooping on the Port

---

|        |                                                                                                                                                                                                                                                                                                                                                                   |
|--------|-------------------------------------------------------------------------------------------------------------------------------------------------------------------------------------------------------------------------------------------------------------------------------------------------------------------------------------------------------------------|
| Step 1 | <b>configure</b><br>Enter global configuration mode.                                                                                                                                                                                                                                                                                                              |
| Step 2 | <b>interface { fastEthernet <i>port</i>   range fastEthernet <i>port-list</i>   gigabitEthernet <i>port</i>   range gigabitEthernet <i>port-list</i>   ten-gigabitEthernet <i>port</i>   range ten-gigabitEthernet <i>port-list</i>   port-channel <i>port-channel</i>   range port-channel <i>port-channel-list</i> }</b><br>Enter interface configuration mode. |
| Step 3 | <b>ip igmp snooping</b><br>Enable IGMP Snooping on the specified port.                                                                                                                                                                                                                                                                                            |
| Step 4 | <b>end</b><br>Return to privileged EXEC mode.                                                                                                                                                                                                                                                                                                                     |
| Step 5 | <b>show ip igmp snooping</b><br>Show the basic IGMP snooping configuration.                                                                                                                                                                                                                                                                                       |
| Step 6 | <b>copy running-config startup-config</b><br>Save the settings in the configuration file.                                                                                                                                                                                                                                                                         |

---

The following example shows how to enable IGMP Snooping globally and enable IGMP Snooping on port 1/0/3:

```
Switch#configure
```

```
Switch(config)#ip igmp snooping
```



```
Switch(config)#interface ten-gigabitEthernet 1/0/3
```

```
Switch(config-if)#ip igmp snooping
```

```
Switch(config-if)#show ip igmp snooping
```

```
IGMP Snooping          :Enable
```

```
Unknown Multicast      :Pass
```

```
Last Query Times       :2
```

```
Last Query Interval    :1
```

```
Global Member Age Time :260
```

```
Global Router Age Time :300
```

```
Global Report Suppression :Disable
```

```
Global Authentication Accounting:Disable
```

```
Enable Port:Te1/0/3
```

```
Enable VLAN:
```

```
Switch(config-if)#end
```

```
Switch#copy running-config startup-config
```

## 2.2.3 Configuring IGMP Snooping Parameters Globally

### Configuring Report Message Suppression

---

**Step 1**     **configure**

Enter global configuration mode.

---

**Step 2**     **ip igmp snooping report-suppression**

Enable Report Message Suppression globally. If this function is enabled, the switch will only forward the first IGMP report message to Layer 3 devices and suppress subsequent IGMP report messages from the same multicast group during one query interval, which reduces the number of IGMP packets.

---

**Step 3**     **end**

Return to privileged EXEC mode.

---

**Step 4**     **show ip igmp snooping**

Show the basic IGMP snooping configuration.

---

**Step 5**     **copy running-config startup-config**

Save the settings in the configuration file.

---

The following example shows how to enable Report Message Suppression:

```
Switch#configure
```

```
Switch(config)#ip igmp snooping
```

```
Switch(config)#ip igmp snooping report-suppression
```

```
Switch(config)#show ip igmp snooping
```

```
IGMP Snooping           :Enable
Unknown Multicast       :Pass
Last Query Times        :2
Last Query Interval     :1
Global Member Age Time  :260
Global Router Age Time  :300
Global Report Suppression :Enable
Global Authentication Accounting:Disable
Enable Port:
Enable VLAN:
```

```
Switch(config-if)#end
```

```
Switch#copy running-config startup-config
```

## Configuring Unknown Multicast

- 
- |        |                                                                                                                                                                                                                                                                                           |
|--------|-------------------------------------------------------------------------------------------------------------------------------------------------------------------------------------------------------------------------------------------------------------------------------------------|
| Step 1 | <b>configure</b><br>Enter global configuration mode.                                                                                                                                                                                                                                      |
| Step 2 | <b>ip igmp snooping drop-unknown</b><br>Configure the way how the switch processes the multicast data from unknown multicast groups as Discard. Unknown multicast groups are multicast groups whose destination multicast address is not in the multicast forwarding table of the switch. |
| Step 3 | <b>end</b><br>Return to privileged EXEC mode.                                                                                                                                                                                                                                             |
| Step 4 | <b>show ip igmp snooping</b><br>Show the basic IGMP snooping configuration.                                                                                                                                                                                                               |
| Step 5 | <b>copy running-config startup-config</b><br>Save the settings in the configuration file.                                                                                                                                                                                                 |
-

For switches that support MLD Snooping, IGMP Snooping and MLD Snooping share the setting of Unknown Multicast, so you have to enable MLD Snooping globally at the same time.

The following example shows how to configure the switch to discard unknown multicast data:

**Switch#configure**

**Switch(config)#ip igmp snooping**

**Switch(config)#ipv6 mld snooping**

**Switch(config)#ip igmp snooping drop-unknown**

**Switch(config)#show ip igmp snooping**

IGMP Snooping :Enable

Unknown Multicast :Discard

Last Query Times :2

Last Query Interval :1

Global Member Age Time :260

Global Router Age Time :300

Global Report Suppression :Disable

**Global Authentication Accounting:Disable**

**Enable Port:**

**Enable VLAN:**

**Switch(config-if)#end**

**Switch#copy running-config startup-config**

## 2.2.4 Configuring IGMP Snooping Parameters on the Port

### Configuring Router Port Time and Member Port Time

Step 1 **configure**

Enter global configuration mode.

Step 2 **ip igmp snooping rtime *rtime***

**ip igmp snooping mtime *mtime***

*rtime* is the aging time of router ports, ranging from 60 to 600 seconds.

*mtime* is the aging time of member ports, ranging from 60 to 600 seconds.

- 
- Step 3     **end**  
Return to privileged EXEC mode.
- 
- Step 4     **show ip igmp snooping**  
Show the basic IGMP snooping configuration.
- 
- Step 5     **copy running-config startup-config**  
Save the settings in the configuration file.
- 

The following example shows how to configure the global router port time and member port time as 200 seconds:

### **Switch#configure**

**Switch(config)#ip igmp snooping**

**Switch(config)#ip igmp snooping rtime 200**

**Switch(config)#ip igmp snooping mtime 200**

**Switch(config)#show ip igmp snooping**

IGMP Snooping           :Enable

Unknown Multicast       :Pass

Last Query Times        :2

Last Query Interval     :1

Global Member Age Time   :200

Global Router Age Time   :200

Global Report Suppression :Disable

Global Authentication Accounting:Disable

Enable Port:

Enable VLAN:

**Switch(config-if)#end**

**Switch#copy running-config startup-config**

## **Configuring Fast Leave**

- 
- Step 1     **configure**  
Enter global configuration mode.
-

|        |                                                                                                                                                                                                                                                                                                                                                                  |
|--------|------------------------------------------------------------------------------------------------------------------------------------------------------------------------------------------------------------------------------------------------------------------------------------------------------------------------------------------------------------------|
| Step 2 | <b>interface { fastEthernet <i>port</i>   range fastEthernet <i>port-list</i>   gigabitEthernet <i>port</i>   range gigabitEthernet <i>port-list</i>   ten-gigabitEthernet <i>port</i>   range ten-gigabitEthernet <i>port-list</i>   port-channel <i>port-channel</i>   range port-channel <i>port-channel-list</i> }</b><br>Enter interface configuration mode |
| Step 3 | <b>ip igmp snooping immediate-leave</b><br>Enable Fast Leave on the specified port. With Fast Leave enabled on a port, the switch will delete the port-multicast group entry from the multicast forwarding table once the port receives a leave message. You should only use this function when there is a single receiver present on the port.                  |
| Step 4 | <b>show ip igmp snooping interface [fastEthernet [ <i>port</i>   <i>port-list</i> ]   gigabitEthernet [ <i>port</i>   <i>port-list</i> ]   ten-gigabitEthernet [ <i>port</i>   <i>port-list</i> ]] basic-config</b><br>Show the basic IGMP snooping configuration on the specified port(s) or of all the ports.                                                  |
| Step 5 | <b>end</b><br>Return to privileged EXEC mode.                                                                                                                                                                                                                                                                                                                    |
| Step 6 | <b>copy running-config startup-config</b><br>Save the settings in the configuration file.                                                                                                                                                                                                                                                                        |

The following example shows how to enable Fast Leave on port 1/0/3:

**Switch#configure**

**Switch(config)#ip igmp snooping**

**Switch(config)#interface ten-gigabitEthernet 1/0/3**

**Switch(config-if)#ip igmp snooping**

**Switch(config-if)#ip igmp snooping immediate-leave**

**Switch(config-if)#show ip igmp snooping interface ten-gigabitEthernet 1/0/3 basic-config**

| Port    | IGMP-Snooping | Fast-Leave |
|---------|---------------|------------|
| -----   | -----         | -----      |
| Te1/0/3 | enable        | enable     |

**Switch(config-if)#end**

**Switch#copy running-config startup-config**

## Configuring Max Group and Overflow Action on the Port

|        |                                                      |
|--------|------------------------------------------------------|
| Step 1 | <b>configure</b><br>Enter global configuration mode. |
|--------|------------------------------------------------------|

|        |                                                                                                                                                                                                                                                                                                                                                                                                                               |
|--------|-------------------------------------------------------------------------------------------------------------------------------------------------------------------------------------------------------------------------------------------------------------------------------------------------------------------------------------------------------------------------------------------------------------------------------|
| Step 2 | <b>interface { fastEthernet <i>port</i>   range fastEthernet <i>port-list</i>   gigabitEthernet <i>port</i>   range gigabitEthernet <i>port-list</i>   ten-gigabitEthernet <i>port</i>   range ten-gigabitEthernet <i>port-list</i>   port-channel <i>port-channel</i>   range port-channel <i>port-channel-list</i> }</b><br>Enter interface configuration mode                                                              |
| Step 3 | <b>ip igmp snooping max-groups <i>maxgroup</i></b><br>Enter the number of multicast groups the port can join. The range is 0 to 1000.                                                                                                                                                                                                                                                                                         |
| Step 4 | <b>ip igmp snooping max-groups action {drop   replace}</b><br>Specify the action towards the new multicast group when the number of multicast groups the port joined exceeds max group.<br><br>drop: Drop all subsequent membership report messages, and the port join no more new multicast groups.<br><br>replace: Replace the existing multicast group with the lowest multicast MAC address with the new multicast group. |
| Step 5 | <b>show ip igmp snooping interface [fastEthernet [ <i>port</i>   <i>port-list</i> ]   gigabitEthernet [ <i>port</i>   <i>port-list</i> ]   ten-gigabitEthernet [ <i>port</i>   <i>port-list</i> ]] max-groups</b><br>Show the IGMP group limitation on the specified port(s) or of all the ports.                                                                                                                             |
| Step 6 | <b>end</b><br>Return to privileged EXEC mode.                                                                                                                                                                                                                                                                                                                                                                                 |
| Step 7 | <b>copy running-config startup-config</b><br>Save the settings in the configuration file.                                                                                                                                                                                                                                                                                                                                     |

The following example shows how to configure the Max Group as 500 and the Overflow Action as Drop on port 1/0/3:

**Switch#configure**

**Switch(config)#ip igmp snooping**

**Switch(config)#interface ten-gigabitEthernet 1/0/3**

**Switch(config-if)#ip igmp snooping**

**Switch(config-if)#ip igmp snooping max-groups 500**

**Switch(config-if)#ip igmp snooping max-groups action drop**

**Switch(config-if)#show ip igmp snooping interface ten-gigabitEthernet 1/0/3 max-groups**

| Port    | Max-Groups | Overflow-Action |
|---------|------------|-----------------|
| -----   | -----      | -----           |
| Te1/0/3 | 500        | Drop            |

**Switch(config-if)#end**

**Switch#copy running-config startup-config**

## 2.2.5 Configuring IGMP Snooping Last Listener Query

|        |                                                                                                                                                                                             |
|--------|---------------------------------------------------------------------------------------------------------------------------------------------------------------------------------------------|
| Step 1 | <b>configure</b><br>Enter global configuration mode.                                                                                                                                        |
| Step 2 | <b>ip igmp snooping last-listener query-interval <i>interval</i></b><br><i>interval</i> determines the interval between MASQs sent by the switch. The valid values are from 1 to 5 seconds. |
| Step 3 | <b>ip igmp snooping last-listener query-count <i>num</i></b><br><i>num</i> determines the number of MASQs sent by the switch. The valid values are from 1 to 5.                             |
| Step 4 | <b>show ip igmp snooping</b><br>Show the basic IGMP snooping configuration.                                                                                                                 |
| Step 5 | <b>end</b><br>Return to privileged EXEC mode.                                                                                                                                               |
| Step 6 | <b>copy running-config startup-config</b><br>Save the settings in the configuration file.                                                                                                   |

The following example shows how to configure the last listener query count as 5 and the last listener query interval as 5 seconds:

**Switch#configure**

**Switch(config)#ip igmp snooping**

**Switch(config)#ip igmp snooping last-listener query-count 5**

**Switch(config)#ip igmp snooping last-listener query-interval 5**

**Switch(config)#show ip igmp snooping**

```
IGMP Snooping           :Enable
Unknown Multicast       :Pass
Last Query Times        :5
Last Query Interval     :5
Global Member Age Time  :260
Global Router Age Time  :300
Global Report Suppression :Disable
Global Authentication Accounting:Disable
Enable Port:
```

Enable VLAN:

```
Switch(config)#end
```

```
Switch#copy running-config startup-config
```

## 2.2.6 Configuring IGMP Snooping Parameters in the VLAN

### Configuring Router Port Time and Member Port Time

|        |                                                                                                                                                                                                                                                                                                                                                     |
|--------|-----------------------------------------------------------------------------------------------------------------------------------------------------------------------------------------------------------------------------------------------------------------------------------------------------------------------------------------------------|
| Step 1 | <b>configure</b><br>Enter global configuration mode.                                                                                                                                                                                                                                                                                                |
| Step 2 | <b>ip igmp snooping vlan-config <i>vlan-id-list</i> [<i>ptime router-time</i>   <i>mtime member-time</i>]</b><br><i>router-time</i> is the aging time of the router ports in the specified VLAN, ranging from 60 to 600 seconds.<br><i>member-time</i> is the aging time of the member ports in the specified VLAN, ranging from 60 to 600 seconds. |
| Step 3 | <b>show ip igmp snooping vlan <i>vlan-id</i></b><br>Show the basic IGMP snooping configuration in the specified VLAN.                                                                                                                                                                                                                               |
| Step 4 | <b>end</b><br>Return to privileged EXEC mode.                                                                                                                                                                                                                                                                                                       |
| Step 5 | <b>copy running-config startup-config</b><br>Save the settings in the configuration file.                                                                                                                                                                                                                                                           |

The following example shows how to enable IGMP Snooping in VLAN 2 and VLAN 3, configure the router port time as 500 seconds and the member port time as 400 seconds:

```
Switch#configure
```

```
Switch(config)#ip igmp snooping
```

```
Switch(config)#ip igmp snooping vlan-config 2-3 ptime 500
```

```
Switch(config)#ip igmp snooping vlan-config 2-3 mtime 400
```

```
Switch(config)#show ip igmp snooping vlan 2
```

```
Vlan Id: 2
```

```
Router Time:500
```

```
Member Time:400
```

```
Static Router Port:None
```

```
Dynamic Router Port:None
```

```
Forbidden Router Port:None
```



```
Switch(config)#show ip igmp snooping vlan 3
```

```
Vlan Id: 3
```

```
Router Time:500
```

```
Member Time:400
```

```
Static Router Port:None
```

```
Dynamic Router Port:None
```

```
Forbidden Router Port:None
```

```
Switch(config)#end
```

```
Switch#copy running-config startup-config
```

## Configuring Static Router Port

|        |                                                                                                                                                                                                                                                                                                                        |
|--------|------------------------------------------------------------------------------------------------------------------------------------------------------------------------------------------------------------------------------------------------------------------------------------------------------------------------|
| Step 1 | <b>configure</b><br>Enter global configuration mode.                                                                                                                                                                                                                                                                   |
| Step 2 | <b>ip igmp snooping vlan-config</b> <i>vlan-id-list</i> [ <b>rport interface</b> { <b>gigabitEthernet</b> <i>port-list</i>   <b>gigabitEthernet</b> <i>port-list</i>   <b>port-channel</b> <i>port-channel-id</i> }]<br><i>port-list</i> and <i>port-channel-id</i> are the static router ports in the specified VLAN. |
| Step 3 | <b>show ip igmp snooping vlan</b> <i>vlan-id</i><br>Show the basic IGMP snooping configuration in the specified VLAN.                                                                                                                                                                                                  |
| Step 4 | <b>end</b><br>Return to privileged EXEC mode.                                                                                                                                                                                                                                                                          |
| Step 5 | <b>copy running-config startup-config</b><br>Save the settings in the configuration file.                                                                                                                                                                                                                              |

The following example shows how to enable IGMP Snooping in VLAN 2 and configure port 1/0/2 as the static router port:

```
Switch#configure
```

```
Switch(config)#ip igmp snooping
```

```
Switch(config)#ip igmp snooping vlan-config 2 rport interface ten-gigabitEthernet 1/0/2
```

```
Switch(config)#show ip igmp snooping vlan 2
```

```
Vlan Id: 2
```

```
Router Time:0
```

```
Member Time:0
```

Static Router Port:Te1/0/2

Dynamic Router Port:None

Forbidden Router Port:None

**Switch(config)#end**

**Switch#copy running-config startup-config**

## Configuring Forbidden Router Port

|        |                                                                                                                                                                                                                                                                                                                                  |
|--------|----------------------------------------------------------------------------------------------------------------------------------------------------------------------------------------------------------------------------------------------------------------------------------------------------------------------------------|
| Step 1 | <b>configure</b><br>Enter global configuration mode.                                                                                                                                                                                                                                                                             |
| Step 2 | <b>ip igmp snooping vlan-config <i>vlan-id-list</i> router-ports-forbidden interface {gigabitEthernet <i>port-list</i>   ten-gigabitEthernet <i>port-list</i>   port-channel <i>port-channel-id</i>}</b><br><br><i>port-list</i> and <i>port-channel-id</i> are the ports that cannot become router ports in the specified VLAN. |
| Step 3 | <b>show ip igmp snooping vlan <i>vlan-id</i></b><br>Show the basic IGMP snooping configuration in the specified VLAN.                                                                                                                                                                                                            |
| Step 4 | <b>end</b><br>Return to privileged EXEC mode.                                                                                                                                                                                                                                                                                    |
| Step 5 | <b>copy running-config startup-config</b><br>Save the settings in the configuration file.                                                                                                                                                                                                                                        |

The following example shows how to enable IGMP Snooping in VLAN 2 and forbid port 1/0/4-6 from becoming router ports (port 1/0/4-6 will drop all multicast data from Layer 3 devices):

**Switch#configure**

**Switch(config)#ip igmp snooping**

**Switch(config)#ip igmp snooping vlan-config 2 router-ports-forbidden interface ten-gigabitEthernet 1/0/4-6**

**Switch(config)#show ip igmp snooping vlan 2**

Vlan Id: 2

Router Time:0

Member Time:0

Static Router Port:None

Dynamic Router Port:None

Forbidden Router Port:Te1/0/4-6

**Switch(config)#end**

**Switch#copy running-config startup-config**

## Configuring Static Multicast (Multicast IP and Forward Port)

|        |                                                                                                                                                                                                                                                                                                                                                                                                                                                                                            |
|--------|--------------------------------------------------------------------------------------------------------------------------------------------------------------------------------------------------------------------------------------------------------------------------------------------------------------------------------------------------------------------------------------------------------------------------------------------------------------------------------------------|
| Step 1 | <b>configure</b><br>Enter global configuration mode.                                                                                                                                                                                                                                                                                                                                                                                                                                       |
| Step 2 | <b>ip igmp snooping vlan-config <i>vlan-id-list</i> static <i>ip</i> interface {<i>gigabitEthernet port-list</i>   <i>ten-gigabitEthernet port-list</i>   <i>port-channel port-channel-id</i>}</b><br><br><i>vlan-id-list</i> specifies the VLAN to be configured.<br><br><i>ip</i> specifies the static multicast IP address.<br><br><i>port-list</i> and <i>port-channel-id</i> specify the forward ports (member ports) bound to the static multicast IP address in the specified VLAN. |
| Step 3 | <b>show ip igmp snooping groups static</b><br>Show the static IGMP snooping configuration.                                                                                                                                                                                                                                                                                                                                                                                                 |
| Step 4 | <b>end</b><br>Return to privileged EXEC mode.                                                                                                                                                                                                                                                                                                                                                                                                                                              |
| Step 5 | <b>copy running-config startup-config</b><br>Save the settings in the configuration file.                                                                                                                                                                                                                                                                                                                                                                                                  |

The following example shows how to configure 226.0.0.2 as the static multicast IP and specify port 1/0/9-10 as the forward ports:

**Switch#configure**

**Switch(config)#ip igmp snooping**

**Switch(config)#ip igmp snooping vlan-config 2 static 226.0.0.2 interface ten-gigabitEthernet 1/0/9-10**

**Switch(config)#show ip igmp snooping groups static**

| Multicast-ip | VLAN-id | Addr-type | Switch-port |
|--------------|---------|-----------|-------------|
| -----        | -----   | -----     | -----       |
| 226.0.0.2    | 2       | static    | Te1/0/9-10  |

**Switch(config)#end**

**Switch#copy running-config startup-config**

## 2.2.7 Configuring IGMP Snooping Parameters in the Multicast VLAN

### Configuring Router Port Time and Member Port Time

- 
- |        |                                                                                                                                                                                                                                                                                                                                                                                                           |
|--------|-----------------------------------------------------------------------------------------------------------------------------------------------------------------------------------------------------------------------------------------------------------------------------------------------------------------------------------------------------------------------------------------------------------|
| Step 1 | <b>configure</b><br>Enter global configuration mode.                                                                                                                                                                                                                                                                                                                                                      |
| Step 2 | <b>ip igmp snooping multi-vlan-config [vlan-id] [rtime router-time   mtime member-time]</b><br><i>vlan-id</i> specifies the VLAN to be created or to be configured.<br><i>router-time</i> is the aging time of the router ports in the multicast VLAN, ranging from 60 to 600 seconds.<br><i>member-time</i> is the aging time of the member ports in the multicast VLAN, ranging from 60 to 600 seconds. |
| Step 3 | <b>show ip igmp snooping multi-vlan</b><br>Show the IGMP snooping configuration in the multicast VLAN.                                                                                                                                                                                                                                                                                                    |
| Step 4 | <b>end</b><br>Return to privileged EXEC mode.                                                                                                                                                                                                                                                                                                                                                             |
| Step 4 | <b>copy running-config startup-config</b><br>Save the settings in the configuration file.                                                                                                                                                                                                                                                                                                                 |
- 

The following example shows how to configure VLAN 5 as the multicast VLAN, set the router port time as 500 seconds and the member port time as 400 seconds:

**Switch#configure**

**Switch(config)#ip igmp snooping**

**Switch(config)#ip igmp snooping multi-vlan-config 5 rtime 500**

**Switch(config)#ip igmp snooping multi-vlan-config 5 mtime 400**

**Switch(config)#show ip igmp snooping multi-vlan**

Multicast Vlan:Enable

Vlan Id: 5

Router Time:500

Member Time:400

Replace Source IP:0.0.0.0

Static Router Port:None

Dynamic Router Port:None

Forbidden Router Port:None

**Switch(config)#end**

**Switch#copy running-config startup-config****Configuring Static Router Port**

|        |                                                                                                                                                                                                                                                                                                                                            |
|--------|--------------------------------------------------------------------------------------------------------------------------------------------------------------------------------------------------------------------------------------------------------------------------------------------------------------------------------------------|
| Step 1 | <b>configure</b><br>Enter global configuration mode.                                                                                                                                                                                                                                                                                       |
| Step 2 | <b>ip igmp snooping multi-vlan-config [vlan-id] [rport interface {gigabitEthernet port-list   ten-gigabitEthernet port-list   port-channel port-channel-id}]</b><br><i>vlan-id</i> specifies the VLAN to be created or to be configured.<br><i>port-list</i> and <i>port-channel-id</i> are the static router ports in the multicast VLAN. |
| Step 3 | <b>show ip igmp snooping multi-vlan</b><br>Show the IGMP snooping configuration in the multicast VLAN.                                                                                                                                                                                                                                     |
| Step 4 | <b>end</b><br>Return to privileged EXEC mode.                                                                                                                                                                                                                                                                                              |
| Step 5 | <b>copy running-config startup-config</b><br>Save the settings in the configuration file.                                                                                                                                                                                                                                                  |

The following example shows how to configure VLAN 5 as the multicast VLAN, and set port 1/0/5 as the static router port:

**Switch#configure****Switch(config)#ip igmp snooping**

```
Switch(config)#ip igmp snooping multi-vlan-config 5 rport interface ten-gigabitEthernet 1/0/5
```

**Switch(config)#show ip igmp snooping multi-vlan**

```
Multicast Vlan:Enable
```

```
Vlan Id: 5
```

```
Router Time:300
```

```
Member Time:260
```

```
Replace Source IP:0.0.0.0
```

```
Static Router Port:Te1/0/5
```

```
Dynamic Router Port:None
```

```
Forbidden Router Port:None
```

**Switch(config)#end****Switch#copy running-config startup-config**

## Configuring Forbidden Router Port

- 
- Step 1     **configure**  
Enter global configuration mode.
- 
- Step 2     **ip igmp snooping multi-vlan-config [vlan-id] router-ports-forbidden interface {gigabitEthernet port-list | ten-gigabitEthernet port-list | port-channel port-channel-id}**  
*vlan-id* specifies the multicast VLAN to be configured.  
*port-list* and *port-channel-id* are the ports that cannot become router ports in the multicast VLAN.
- 
- Step 3     **show ip igmp snooping multi-vlan**  
Show the IGMP snooping configuration in the multicast VLAN.
- 
- Step 4     **end**  
Return to privileged EXEC mode.
- 
- Step 5     **copy running-config startup-config**  
Save the settings in the configuration file.
- 

The following example shows how to configure VLAN 5 as the multicast VLAN, and set port 1/0/6 as the forbidden router port:

```
Switch#configure
```

```
Switch(config)#ip igmp snooping
```

```
Switch(config)#ip igmp snooping multi-vlan-config 5 router-ports-forbidden interface ten-gigabitEthernet 1/0/6
```

```
Switch(config)#show ip igmp snooping multi-vlan
```

```
Multicast Vlan:Enable
```

```
Vlan Id: 5
```

```
Router Time:300
```

```
Member Time:260
```

```
Replace Source IP:0.0.0.0
```

```
Static Router Port:None
```

```
Dynamic Router Port:None
```

```
Forbidden Router Port:Te1/0/6
```

```
Switch(config)#end
```

```
Switch#copy running-config startup-config
```

## Configuring Replace Source IP

---

**Step 1**     **configure**

Enter global configuration mode.

---

**Step 2**     **ip igmp snooping multi-vlan-config [vlan-id] replace-sourceip ip**

*vlan-id* specifies the multicast VLAN to be configured.

*ip* specifies the new source IP. The switch will replace the source IP in the IGMP multicast data sent by the multicast VLAN with the IP address you enter.

---

**Step 3**     **show ip igmp snooping multi-vlan**

Show the IGMP snooping configuration in the multicast VLAN.

---

**Step 4**     **end**

Return to privileged EXEC mode.

---

**Step 5**     **copy running-config startup-config**

Save the settings in the configuration file.

---

The following example shows how to configure VLAN 5 as the multicast VLAN and replace the source IP in the IGMP packets sent by the switch with 192.168.0.1:

**Switch#configure**

**Switch(config)#ip igmp snooping**

**Switch(config)#ip igmp snooping multi-vlan-config 5 replace-sourceip 192.168.0.1**

**Switch(config)#show ip igmp snooping multi-vlan**

Multicast Vlan:Enable

Vlan Id: 5

Router Time:300

Member Time:260

Replace Source IP:192.168.0.1

Static Router Port:None

Dynamic Router Port:None

Forbidden Router Port:None

**Switch(config)#end**

**Switch#copy running-config startup-config**

## 2.2.8 Configuring the Querier

### Enabling IGMP Querier

- 
- |        |                                                                                                                  |
|--------|------------------------------------------------------------------------------------------------------------------|
| Step 1 | <b>configure</b><br>Enter global configuration mode.                                                             |
| Step 2 | <b>ip igmp snooping querier vlan <i>vlan-id</i></b><br><i>vlan-id</i> specifies the VLAN to enable IGMP Querier. |
| Step 3 | <b>show ip igmp snooping querier [vlan <i>vlan-id</i> ]</b><br>Show the IGMP querier configuration.              |
| Step 4 | <b>end</b><br>Return to privileged EXEC mode.                                                                    |
| Step 5 | <b>copy running-config startup-config</b><br>Save the settings in the configuration file.                        |
- 

The following example shows how to enable IGMP Snooping and IGMP Querier in VLAN 4:

**Switch#configure**

**Switch(config)#ip igmp snooping**

**Switch(config)#ip igmp snooping querier vlan 4**

**Switch(config)#show ip igmp snooping querier**

VLAN 4:

-----

```
Maximum Response Time:    10
Query Interval:           60
General Query Source IP:  192.168.0.1
```

**Switch(config)#end**

**Switch#copy running-config startup-config**

### Configuring Query Interval, Max Response Time and General Query Source IP

- 
- |        |                                                      |
|--------|------------------------------------------------------|
| Step 1 | <b>configure</b><br>Enter global configuration mode. |
|--------|------------------------------------------------------|
-



- 
- Step 2     **ip igmp snooping querier vlan** *vlan-id* **{query-interval** *interval* **| max-response-time** *response-time* **| general-query source-ip** *ip-addr*  
*vlan-id* specifies the VLAN where the querier is.  
*interval* is the interval between general query messages sent by the querier.  
*response-time* is the host's maximum response time to general query messages in a range of 1 to 25 seconds.  
*ip-addr* is the source IP address of the general query messages sent by the querier. It cannot be a multicast address or a broadcast address.
- 
- Step 3     **show ip igmp snooping querier** [*vlan* *vlan-id* ]  
Show the detailed IGMP querier configuration.
- 
- Step 4     **end**  
Return to privileged EXEC mode.
- 
- Step 5     **copy running-config startup-config**  
Save the settings in the configuration file.
- 

The following example shows how to enable IGMP Snooping and IGMP Querier in VLAN 4, set the query interval as 100 seconds, the max response time as 20 seconds, and the general query source IP as 192.168.0.1:

#### Switch#configure

#### Switch(config)#ip igmp snooping

```
Switch(config)#ip igmp snooping querier vlan 4 query-interval 100
```

```
Switch(config)#ip igmp snooping querier vlan 4 max-response-time 20
```

```
Switch(config)#ip igmp snooping querier vlan 4 general-query source-ip 192.168.0.1
```

#### Switch(config)#show ip igmp snooping querier

VLAN 4:

-----

Maximum Response Time:     20

Query Interval:             100

General Query Source IP:     192.168.0.1

#### Switch(config)#end

#### Switch#copy running-config startup-config

## 2.2.9 Configuring Multicast Filtering

### Creating Profile

---

|        |                                                                                                                                                                                                                                                                                                                                                                   |
|--------|-------------------------------------------------------------------------------------------------------------------------------------------------------------------------------------------------------------------------------------------------------------------------------------------------------------------------------------------------------------------|
| Step 1 | <b>configure</b><br>Enter global configuration mode.                                                                                                                                                                                                                                                                                                              |
| Step 2 | <b>ip igmp profile <i>id</i></b><br>Create a new profile and enter profile configuration mode.                                                                                                                                                                                                                                                                    |
| Step 3 | <b>permit</b><br><b>deny</b><br>Configure the profile's filtering mode.<br><br><b>permit</b> is similar to a whitelist, indicating that the switch only allow specific member ports to join specific multicast groups.<br><br><b>deny</b> is similar to a blacklist, indicating that the switch disallow specific member ports to join specific multicast groups. |
| Step 4 | <b>range <i>start-ip end-ip</i></b><br>Configure the range of multicast IP to be filtered. <i>start-ip</i> , <i>end-ip</i> are the start IP and end IP of the IP range respectively.                                                                                                                                                                              |
| Step 5 | <b>show ip igmp profile [<i>id</i>]</b><br>Show the detailed IGMP profile configuration.                                                                                                                                                                                                                                                                          |
| Step 6 | <b>end</b><br>Return to privileged EXEC mode.                                                                                                                                                                                                                                                                                                                     |
| Step 7 | <b>copy running-config startup-config</b><br>Save the settings in the configuration file.                                                                                                                                                                                                                                                                         |

---

The following example shows how to configure Profile 1 so that the switch filters multicast data sent to 226.0.0.5-226.0.0.10:

```
Switch#configure
```

```
Switch(config)#ip igmp snooping
```

```
Switch(config)#ip igmp profile 1
```

```
Switch(config-igmp-profile)#deny
```

```
Switch(config-igmp-profile)#range 226.0.0.5 226.0.0.10
```

```
Switch(config-igmp-profile)#show ip igmp profile
```

```
IGMP Profile 1
```

```
deny
```

```
range 226.0.0.5 226.0.0.10
```

```
Switch(config)#end
```

```
Switch#copy running-config startup-config
```

## Binding Profile to the Port

|        |                                                                                                                                                                                                                                                                                                                                                                   |
|--------|-------------------------------------------------------------------------------------------------------------------------------------------------------------------------------------------------------------------------------------------------------------------------------------------------------------------------------------------------------------------|
| Step 1 | <b>configure</b><br>Enter global configuration mode.                                                                                                                                                                                                                                                                                                              |
| Step 2 | <b>interface {fastEthernet <i>port</i>   range fastEthernet <i>port-list</i>   gigabitEthernet <i>port</i>   range gigabitEthernet <i>port-list</i>   ten-gigabitEthernet <i>port</i>   range ten-gigabitEthernet <i>port-list</i>   port-channel <i>port-channel-id</i>   range port-channel <i>port-channel-list</i>}</b><br>Enter interface configuration mode |
| Step 3 | <b>ip igmp filter <i>profile-id</i></b><br>Bind <i>profile-id</i> to the specified port.                                                                                                                                                                                                                                                                          |
| Step 4 | <b>show ip igmp profile [<i>id</i>]</b><br>Show the detailed IGMP profile configuration.                                                                                                                                                                                                                                                                          |
| Step 5 | <b>end</b><br>Return to privileged EXEC mode.                                                                                                                                                                                                                                                                                                                     |
| Step 6 | <b>copy running-config startup-config</b><br>Save the settings in the configuration file.                                                                                                                                                                                                                                                                         |

The following example shows how to bind Profile 1 to port 1/0/2 so that port 1/0/2 filters multicast data sent to 226.0.0.5-226.0.0.10:

```
Switch#configure
```

```
Switch(config)#ip igmp snooping
```

```
Switch(config)#ip igmp profile 1
```

```
Switch(config-igmp-profile)#deny
```

```
Switch(config-igmp-profile)#range 226.0.0.5 226.0.0.10
```

```
Switch(config-igmp-profile)#exit
```

```
Switch(config)#interface ten-gigabitEthernet 1/0/2
```

```
Switch(config-if)#ip igmp snooping
```

```
Switch(config-if)#ip igmp filter 1
```

```
Switch(config-if)#show ip igmp profile
```

```
IGMP Profile 1
```

```
deny
```

```
range 226.0.0.5 226.0.0.10
```

```
Binding Port(s)
```

```
Te1/0/2
```

```
Switch(config)#end
```

```
Switch#copy running-config startup-config
```

## 2.2.10 Enabling IGMP Accounting and Authentication

### Enabling IGMP Authentication on the Port

|        |                                                                                                                                                                                                                                                                                                                                                                   |
|--------|-------------------------------------------------------------------------------------------------------------------------------------------------------------------------------------------------------------------------------------------------------------------------------------------------------------------------------------------------------------------|
| Step 1 | <b>configure</b><br>Enter global configuration mode.                                                                                                                                                                                                                                                                                                              |
| Step 2 | <b>interface {fastEthernet <i>port</i>   range fastEthernet <i>port-list</i>   gigabitEthernet <i>port</i>   range gigabitEthernet <i>port-list</i>   ten-gigabitEthernet <i>port</i>   range ten-gigabitEthernet <i>port-list</i>   port-channel <i>port-channel-id</i>   range port-channel <i>port-channel-list</i>}</b><br>Enter interface configuration mode |
| Step 3 | <b>ip igmp snooping authentication</b><br>Enable IGMP Authentication on the specified port.                                                                                                                                                                                                                                                                       |
| Step 4 | <b>show ip igmp profile [<i>id</i>]</b><br>Show the detailed IGMP profile configuration.                                                                                                                                                                                                                                                                          |
| Step 6 | <b>end</b><br>Return to privileged EXEC mode.                                                                                                                                                                                                                                                                                                                     |
| Step 5 | <b>copy running-config startup-config</b><br>Save the settings in the configuration file.                                                                                                                                                                                                                                                                         |

The following example shows how to enable IGMP Authentication on port 1/0/2:

```
Switch#configure
```

```
Switch(config)#ip igmp snooping
```

```
Switch(config)#interface ten-gigabitEthernet 1/0/2
```

```
Switch(config-if)#ip igmp snooping
```

```
Switch(config-if)#ip igmp snooping authentication
```

```
Switch(config-if)#show ip igmp snooping interface ten-gigabitEthernet 1/0/2 authentication
```

```
Port    IGMP-Authentication
```

```
----    -
```

```
Te1/0/2 enable
```

```
Switch(config)#end
```

```
Switch#copy running-config startup-config
```

---

 **Note:**

IGMP Authentication takes effect only after AAA is enabled and RADIUS server is configured.

---

## Enabling IGMP Accounting Globally

---

- |        |                                                                                           |
|--------|-------------------------------------------------------------------------------------------|
| Step 1 | <b>configure</b><br>Enter global configuration mode.                                      |
| Step 2 | <b>ip igmp snooping accounting</b><br>Enable IGMP Accounting globally.                    |
| Step 3 | <b>show ip igmp snooping</b><br>Show the global IGMP snooping configuration.              |
| Step 4 | <b>end</b><br>Return to privileged EXEC mode.                                             |
| Step 5 | <b>copy running-config startup-config</b><br>Save the settings in the configuration file. |
-

# 3 Configuring MLD Snooping

## 3.1 Using the GUI

### 3.1.1 Configuring MLD Snooping Globally

Choose the menu **Multicast > MLD Snooping > Snooping Config**

Figure 3-1 MLD Snooping Global Config

**Global Config**

MLD Snooping  Enable  Disable

Unknown Multicast  Forward  Discard

Report Message Suppression  Enable  Disable

Router Port Time  sec (60-600)

Member Port Time  sec (60-600)

Last Listener Query Interval:  secs(1-5)

Last Listener Query Count:  (1-5)

**MLD Snooping Status**

| Description  | Member |
|--------------|--------|
| Enable ports |        |
| Enable VLAN  |        |

#### Enabling MLD Snooping Globally

Before configuring functions related to MLD Snooping, enable MLD Snooping globally first.

- 1) Select **Enable** to enable MLD Snooping globally.
- 2) Click **Apply**.

#### (Optional) Configuring Unknown Multicast

Unknown Multicast decides how to process the multicast data when its destination multicast address is not in the multicast forwarding table of the switch.

IGMP Snooping and MLD Snooping share the setting of Unknown Multicast, so you have to enable IGMP Snooping globally on the **Multicast > IGMP Snooping > Snooping Config** page at the same time.

Follow these steps to configure unknown multicast.

- 1) Configure Unknown Multicast as Forward or Discard.

---

|                          |                                                                                                                                                                                                                                                                 |
|--------------------------|-----------------------------------------------------------------------------------------------------------------------------------------------------------------------------------------------------------------------------------------------------------------|
| <b>Unknown Multicast</b> | Configure the way how the switch processes the multicast data sent to unknown multicast groups as Forward or Discard. Unknown multicast groups are multicast groups whose destination multicast address is not in the multicast forwarding table of the switch. |
|--------------------------|-----------------------------------------------------------------------------------------------------------------------------------------------------------------------------------------------------------------------------------------------------------------|

---

- 2) Click **Apply**.

### (Optional) Configuring Report Message Suppression

Enabling Report Message Suppression can reduce the number of packets in the network.

Follow these steps to configure report message suppression.

- 1) Enable or disable Report Message Suppression globally.

---

|                                   |                                                                                                                                                                                                                                                         |
|-----------------------------------|---------------------------------------------------------------------------------------------------------------------------------------------------------------------------------------------------------------------------------------------------------|
| <b>Report Message Suppression</b> | If this function is enabled, the switch will only forward the first MLD report message to Layer 3 devices and suppress subsequent MLD report messages from the same multicast group during one query interval, which reduces the number of MLD packets. |
|-----------------------------------|---------------------------------------------------------------------------------------------------------------------------------------------------------------------------------------------------------------------------------------------------------|

---

- 2) Click **Apply**.

### Configuring Router Port Time and Member Port Time

Follow these steps to configure the aging time of the router ports and the member ports:

- 1) Specify the aging time of the router ports.

---

|                         |                                                                                                                                                                                                                                                                                                                                                 |
|-------------------------|-------------------------------------------------------------------------------------------------------------------------------------------------------------------------------------------------------------------------------------------------------------------------------------------------------------------------------------------------|
| <b>Router Port Time</b> | Router ports are ports connected to Layer 3 devices on the switch. The router port ages if the switch does not receive MLD query message from the router port within the router port time. The switch will no longer consider this port as a router port and delete it from the router port table. The valid values are from 60 to 600 seconds. |
|-------------------------|-------------------------------------------------------------------------------------------------------------------------------------------------------------------------------------------------------------------------------------------------------------------------------------------------------------------------------------------------|

---

- 2) Specify the aging time of the member ports.

---

|                         |                                                                                                                                                                                                                                                                                                                                                                                                                                                              |
|-------------------------|--------------------------------------------------------------------------------------------------------------------------------------------------------------------------------------------------------------------------------------------------------------------------------------------------------------------------------------------------------------------------------------------------------------------------------------------------------------|
| <b>Member Port Time</b> | Member ports are ports connected to multicast group members on the switch. A port is considered to be a member port when it is added to a multicast group. The member port ages if the switch does not receive MLD membership report message from the member port within the member port time. The switch will no longer consider this port as a member port and delete it from the multicast forwarding table. The valid values are from 60 to 600 seconds. |
|-------------------------|--------------------------------------------------------------------------------------------------------------------------------------------------------------------------------------------------------------------------------------------------------------------------------------------------------------------------------------------------------------------------------------------------------------------------------------------------------------|

---

- 3) Click **Apply**.

## Configuring MLD Snooping Last Listener Query

Configure the Last Listener Query Interval and Last Listener Query Count when the switch receives an MLD leave message. If specified count of Multicast-Address-Specific Queries (MASQs) are sent and no report message is received, the switch will delete the multicast address from the multicast forwarding table.

Follow these steps to configure Last Listener Query Interval and Last Listener Query Count in the **Global Config** section:

- 1) Specify the interval between MASQs.

---

|                              |                                                                                                                                                                                                                                                                                                                                                           |
|------------------------------|-----------------------------------------------------------------------------------------------------------------------------------------------------------------------------------------------------------------------------------------------------------------------------------------------------------------------------------------------------------|
| Last Listener Query Interval | When the switch receives an MLD leave message, the switch obtains the address of the multicast group that the host wants to leave from the message. Then the switch sends out MASQs to this multicast group through the port receiving the leave message. This parameter determines the interval between MASQs. The valid values are from 1 to 5 seconds. |
|------------------------------|-----------------------------------------------------------------------------------------------------------------------------------------------------------------------------------------------------------------------------------------------------------------------------------------------------------------------------------------------------------|

---

- 2) Specify the number of MASQs to be sent.

---

|                           |                                                                                                                                                                                                                                                                                                                                                       |
|---------------------------|-------------------------------------------------------------------------------------------------------------------------------------------------------------------------------------------------------------------------------------------------------------------------------------------------------------------------------------------------------|
| Last Listener Query Count | When the switch receives an MLD leave message, the switch obtains the address of the multicast group that the host wants to leave from the message. Then the switch sends out MASQs to this multicast group through the port receiving the leave message. This parameter determines the number of MASQs to be sent. The valid values are from 1 to 5. |
|---------------------------|-------------------------------------------------------------------------------------------------------------------------------------------------------------------------------------------------------------------------------------------------------------------------------------------------------------------------------------------------------|

---

- 3) Click **Apply**.

## Verifying MLD Snooping Status

MLD Snooping Status Table displays VLANs and ports with MLD Snooping enabled.



### 3.1.2 Configuring the Port's Basic MLD Snooping Features

Choose the menu **Multicast > MLD Snooping > Port Config** to load the following page.

Figure 3-2 Enable MLD Snooping on Port

| Port Config              |        |                                        |                                        |     |
|--------------------------|--------|----------------------------------------|----------------------------------------|-----|
| UNIT: 1 LAGS             |        |                                        |                                        |     |
| Select                   | Port   | MLD Snooping                           | Fast Leave                             | LAG |
| <input type="checkbox"/> |        | <input type="text" value="Disable"/> ▼ | <input type="text" value="Disable"/> ▼ |     |
| <input type="checkbox"/> | 1/0/1  | Disable                                | Disable                                | --- |
| <input type="checkbox"/> | 1/0/2  | Disable                                | Disable                                | --- |
| <input type="checkbox"/> | 1/0/3  | Disable                                | Disable                                | --- |
| <input type="checkbox"/> | 1/0/4  | Disable                                | Disable                                | --- |
| <input type="checkbox"/> | 1/0/5  | Disable                                | Disable                                | --- |
| <input type="checkbox"/> | 1/0/6  | Disable                                | Disable                                | --- |
| <input type="checkbox"/> | 1/0/7  | Disable                                | Disable                                | --- |
| <input type="checkbox"/> | 1/0/8  | Disable                                | Disable                                | --- |
| <input type="checkbox"/> | 1/0/9  | Disable                                | Disable                                | --- |
| <input type="checkbox"/> | 1/0/10 | Disable                                | Disable                                | --- |
| <input type="checkbox"/> | 1/0/11 | Disable                                | Disable                                | --- |
| <input type="checkbox"/> | 1/0/12 | Disable                                | Disable                                | --- |
| <input type="checkbox"/> | 1/0/13 | Disable                                | Disable                                | --- |
| <input type="checkbox"/> | 1/0/14 | Disable                                | Disable                                | --- |
| <input type="checkbox"/> | 1/0/15 | Disable                                | Disable                                | --- |

#### Enabling MLD Snooping on the Port

Follow these steps to enable or disable MLD Snooping on the port.

- 1) Select the port to be configured and select **Enable** under the MLD Snooping column.
- 2) Click **Apply**.

#### (Optional) Configuring Fast Leave

With Fast Leave enabled on a port, the switch will remove this port from the forwarding list of the corresponding multicast group once the port receives a leave message. Once deleted, the switch will no longer send MASQs to this port to verify if there are other members of this multicast group.

Follow these steps to configure fast leave.

- 1) Select the port to be configured and select **Enable** under the Fast Leave column.

**Fast Leave**

With Fast Leave enabled on a port, the switch will remove this port from the forwarding list of the corresponding multicast group once the port receives a leave message. You should only use this function when there is a single receiver present on the port.

- 2) Click **Apply**.

### 3.1.3 Configuring MLD Snooping in the VLAN

Choose the menu **Multicast > MLD Snooping > VLAN Config** to load the following page.

Figure 3-3 MLD Snooping in VLAN

VLAN Config

VLAN ID:  (1-4094)

Router Port Time:  sec (0,60-600, recommend: 300) Create

Member Port Time:  sec (0,60-600, recommend: 260)

Static Router Ports

UNIT:  LAGS

|   |   |   |   |    |    |    |    |
|---|---|---|---|----|----|----|----|
| 2 | 4 | 6 | 8 | 10 | 12 | 14 | 16 |
| 1 | 3 | 5 | 7 | 9  | 11 | 13 | 15 |

All
Clear

Forbidden Router Ports

UNIT:  LAGS

|   |   |   |   |    |    |    |    |
|---|---|---|---|----|----|----|----|
| 2 | 4 | 6 | 8 | 10 | 12 | 14 | 16 |
| 1 | 3 | 5 | 7 | 9  | 11 | 13 | 15 |

All
Clear

Unselected Port(s)
Selected Port(s)
Not Available for Selection

| Select                 | VLAN ID | Router Port Time | Member Port Time | Static Router Ports | Dynamic Router Ports | Forbidden Router Ports | Operation |
|------------------------|---------|------------------|------------------|---------------------|----------------------|------------------------|-----------|
| No entry in the table. |         |                  |                  |                     |                      |                        |           |

All
Delete
Help

### Configuring MLD Snooping Globally in the VLAN

In the VLAN Config section, follow these steps to configure relevant parameters for the designate VLAN.

- 1) Set up the VLAN that the router ports and the member ports are in. For details, please refer to [Configuring 802.1Q VLAN](#).
- 2) Enable MLD Snooping in the designate VLAN, and configure the aging time of the router ports and the member ports.

**VLAN ID**

Specify the VLAN to enable MLD Snooping.

|                         |                                                                                                                                                                                                                                                                                                                                                                                                                  |
|-------------------------|------------------------------------------------------------------------------------------------------------------------------------------------------------------------------------------------------------------------------------------------------------------------------------------------------------------------------------------------------------------------------------------------------------------|
| <b>Router Port Time</b> | Specify the aging time of the router ports in the VLAN. If the router port does not receive any MLD general query message within the router port time, the switch will no longer consider this port as a router port and delete it from the router port list. The valid values are from 60 to 600 seconds. When the router port time is 0, the VLAN uses the global time.                                        |
| <b>Member Port Time</b> | Specify the aging time of the member ports in the VLAN. If the member port does not receive any MLD membership report message from the multicast group within the member port time, the switch will no longer consider this port as a member port and delete it from the multicast forwarding table. The valid values are from 60 to 600 seconds. When the member port time is 0, the VLAN uses the global time. |

- 3) Click **Create**.

### (Optional) Configuring the Static Router Ports in the VLAN

Follow these steps to configure static router ports in the designate VLAN:

- 1) Configure the router ports in the designate VLAN.

|                            |                                                                                                                                                        |
|----------------------------|--------------------------------------------------------------------------------------------------------------------------------------------------------|
| <b>VLAN ID</b>             | Specify the VLAN to be configured.                                                                                                                     |
| <b>Static Router Ports</b> | Select one or more ports to be the static router ports in the VLAN. All multicast data in this VLAN will be forwarded through the static router ports. |

- 2) Click **Create**.

### (Optional) Configuring the Forbidden Router Ports in the VLAN

Follow these steps to forbid the selected ports to be the router ports in the designate VLAN:

- 1) Configure the forbidden router ports in the designate VLAN.

|                               |                                                                      |
|-------------------------------|----------------------------------------------------------------------|
| <b>VLAN ID</b>                | Specify the VLAN to be configured.                                   |
| <b>Forbidden Router Ports</b> | Select the ports to forbid them from being router ports in the VLAN. |

- 2) Click **Create**.

## 3.1.4 Configuring the Multicast VLAN

In old multicast transmission mode, when users in different VLANs apply for data from the same multicast group, the Layer 3 device will duplicate this multicast data and deliver copies to the Layer 2 devices.

With Multicast VLAN configured, all multicast group members will be added to a VLAN. Layer 3 device only need to send one piece of multicast data to a Layer 2 device, and the Layer 2 device will send the data to all member ports of the VLAN. In this way, Multicast VLAN saves bandwidth and reduces network load of Layer 3 devices.

Choose the menu **Multicast > MLD Snooping > Multicast VLAN** to load the following page.

Figure 3-4 Multicast VLAN Config

Multicast VLAN

Multicast VLAN:  Enable  Disable

VLAN ID:  (2-4094)

Router Port Time:  sec (0,60-600, recommend: 300)

Member Port Time:  sec (0,60-600, recommend: 260)

Replace Source IP:  (format:FE80::ABEC:12EA)

---

Dynamic Router Ports

UNIT:  LAGS

|   |   |   |   |    |    |    |    |
|---|---|---|---|----|----|----|----|
| 2 | 4 | 6 | 8 | 10 | 12 | 14 | 16 |
| 1 | 3 | 5 | 7 | 9  | 11 | 13 | 15 |

---

Static Router Ports

UNIT:  LAGS

|   |   |   |   |    |    |    |    |
|---|---|---|---|----|----|----|----|
| 2 | 4 | 6 | 8 | 10 | 12 | 14 | 16 |
| 1 | 3 | 5 | 7 | 9  | 11 | 13 | 15 |

---

Forbidden Router Ports

UNIT:  LAGS

|   |   |   |   |    |    |    |    |
|---|---|---|---|----|----|----|----|
| 2 | 4 | 6 | 8 | 10 | 12 | 14 | 16 |
| 1 | 3 | 5 | 7 | 9  | 11 | 13 | 15 |

Unselected Port(s)
  Selected Port(s)
  Not Available for Selection

### Creating Multicast VLAN and Configuring Basic Settings

In the Multicast VLAN section, follow these steps to enable Multicast VLAN and to finish the basic settings:

- 1) Set up the VLAN that the router ports and the member ports are in. For details, please refer to [Configuring 802.1Q VLAN](#).
- 2) Enable Multicast VLAN, configure the specific VLAN to be the multicast VLAN, and configure the Router Port Time and Member Port Time.

|                  |                                                                                                                                                                                                                                                                                                                                                                                      |
|------------------|--------------------------------------------------------------------------------------------------------------------------------------------------------------------------------------------------------------------------------------------------------------------------------------------------------------------------------------------------------------------------------------|
| Multicast VLAN   | Select <b>Enable</b> to enable multicast VLAN function.                                                                                                                                                                                                                                                                                                                              |
| VLAN ID          | Specify the 802.1Q VLAN to be the multicast VLAN.                                                                                                                                                                                                                                                                                                                                    |
| Router Port Time | Specify the aging time of the router ports in the multicast VLAN. If the router port does not receive any MLD general query message within the router port time, the switch will no longer consider this port as a router port and delete it from the router port table. The valid values are from 60 to 600 seconds. When the router port time is 0, the VLAN uses the global time. |

|                         |                                                                                                                                                                                                                                                                                                                                                                                                                            |
|-------------------------|----------------------------------------------------------------------------------------------------------------------------------------------------------------------------------------------------------------------------------------------------------------------------------------------------------------------------------------------------------------------------------------------------------------------------|
| <b>Member Port Time</b> | Specify the aging time of the member ports in the multicast VLAN. If the member port does not receive any MLD membership report message from the multicast group within the member port time, the switch will no longer consider this port as a member port and delete it from the multicast forwarding table. The valid values are from 60 to 600 seconds. When the member port time is 0, the VLAN uses the global time. |
|-------------------------|----------------------------------------------------------------------------------------------------------------------------------------------------------------------------------------------------------------------------------------------------------------------------------------------------------------------------------------------------------------------------------------------------------------------------|

- 3) Click **Apply**.

### (Optional) Creating Replace Source IP

This function allows you to use a new IP instead of the source IP to send data to multicast group members. In the Multicast VLAN section, follow these steps to configure Replace Source IP.

- 1) Configure the new multicast source IP.

|                          |                                                                                                                                                            |
|--------------------------|------------------------------------------------------------------------------------------------------------------------------------------------------------|
| <b>Replace Source IP</b> | Enter the new source IP address. The switch will replace the source IP in the MLD multicast data sent by the multicast VLAN with the IP address you enter. |
|--------------------------|------------------------------------------------------------------------------------------------------------------------------------------------------------|

- 2) Click **Apply**.

### Viewing Dynamic Router Ports in the Multicast VLAN

This table displays all the dynamic router ports in the multicast VLAN.

### (Optional) Configuring the Static Router Ports

Follow these steps to configure static router ports in the multicast VLAN:

- 1) Configure the router ports in the multicast VLAN.

|                            |                                                                                                                                                        |
|----------------------------|--------------------------------------------------------------------------------------------------------------------------------------------------------|
| <b>VLAN ID</b>             | Specify the VLAN to be configured.                                                                                                                     |
| <b>Static Router Ports</b> | Select one or more ports to be the static router ports in the VLAN. All multicast data in this VLAN will be forwarded through the static router ports. |

- 2) Click **Apply**.

### (Optional) Configuring the Forbidden Router Ports

Follow these steps to forbid the selected ports to be the router ports in the multicast VLAN.

- 1) Configure the router ports in the designate VLAN.

|                               |                                                                      |
|-------------------------------|----------------------------------------------------------------------|
| <b>VLAN ID</b>                | Specify the VLAN to be configured.                                   |
| <b>Forbidden Router Ports</b> | Select the ports to forbid them from being router ports in the VLAN. |

- 2) Click **Apply**.

### Note:

When configuration is finished, all multicast data through the ports in the VLAN will be processed in this multicast VLAN.

## 3.1.5 (Optional) Configuring the Querier

MLD Snooping Querier sends general query packets regularly to maintain the multicast forwarding table. Choose the menu **Multicast > MLD Snooping > Querier Config** to load the following page.

Figure 3-5 Querier Config

| MLD Snooping Querier Config                                                                                                                       |                                                        |                      |                          |                                    |
|---------------------------------------------------------------------------------------------------------------------------------------------------|--------------------------------------------------------|----------------------|--------------------------|------------------------------------|
| VLAN ID:                                                                                                                                          | <input type="text"/>                                   |                      | (1-4094)                 |                                    |
| Query Interval:                                                                                                                                   | <input type="text" value="60"/>                        |                      | secs(10-300)             | <input type="button" value="Add"/> |
| Max Response Time:                                                                                                                                | <input type="text" value="10"/>                        |                      | secs(1-25)               |                                    |
| General Query Source IP:                                                                                                                          | <input type="text" value="FE80::02FF:FFFF:FE00:0001"/> |                      | (format:FE80::ABEC:12EA) |                                    |
| MLD Snooping Querier Table                                                                                                                        |                                                        |                      |                          |                                    |
| Select                                                                                                                                            | VLAN ID                                                | Query Interval       | Max Response Time        | General Query Source IP            |
| <input type="checkbox"/>                                                                                                                          |                                                        | <input type="text"/> | <input type="text"/>     | <input type="text"/>               |
| No entry in the table.                                                                                                                            |                                                        |                      |                          |                                    |
| <input type="button" value="All"/> <input type="button" value="Apply"/> <input type="button" value="Delete"/> <input type="button" value="Help"/> |                                                        |                      |                          |                                    |

### Configuring the Querier

Follow these steps to configure the querier.

- 1) Specify a VLAN and configure the querier on this VLAN.

|                         |                                                                                                                                           |
|-------------------------|-------------------------------------------------------------------------------------------------------------------------------------------|
| VLAN ID                 | Specify the VLAN to be configured.                                                                                                        |
| Query Interval          | Enter the interval between general query messages sent by the querier. The valid values are from 10 to 300 seconds.                       |
| Max Response Time       | Enter the host's maximum response time to general query messages in a range of 1 to 25 seconds.                                           |
| General Query Source IP | Specify the source IP address of the general query messages sent by the querier. It cannot be a multicast address or a broadcast address. |

- 2) Click **Add**.
- 3) You can edit the settings in the MLD Snooping Querier Table.

### Viewing Settings of MLD Querier

The MLD Snooping Querier Table displays all the related settings of the MLD querier.

### 3.1.6 Configuring MLD Profile

With MLD Profile, the switch can define a blacklist or whitelist of multicast addresses so as to filter multicast sources. Choose the menu **Multicast > MLD Snooping > Profile Config** to load the following page.

Figure 3-6 Profile Create

**Profile Creation**

Profile ID:  (1-999)

Mode:  Permit  Deny

---

**Search Option**

Search Option:

---

**IGMP Profile Info**

| Select                   | Profile ID | Mode | Bind Ports | Operation            |
|--------------------------|------------|------|------------|----------------------|
| <input type="checkbox"/> | 1          | Deny |            | <a href="#">Edit</a> |

#### Creating Profile

Follow these steps to create a profile and configure its filtering mode.

- 1) Create a profile and configure its filtering mode.

|                   |                                                                                                                                                                                                                                                                                                                                           |
|-------------------|-------------------------------------------------------------------------------------------------------------------------------------------------------------------------------------------------------------------------------------------------------------------------------------------------------------------------------------------|
| <b>Profile ID</b> | Enter a profile ID between 1 and 999.                                                                                                                                                                                                                                                                                                     |
| <b>Mode</b>       | Select <b>Permit</b> or <b>Deny</b> as the filtering mode.<br><br><b>Permit:</b> similar to a whitelist, means that the switch only allows specified member ports to join specific multicast groups.<br><br><b>Deny:</b> similar to a blacklist, means that the switch disallows specific member ports to join specific multicast groups. |

- 2) Click **Create**.

#### Searching Profile

Enter the search condition in the **Search Option** field to search the profile in the MLD Profile Info table.

## Editing IP Range of the Profile

Follow these steps to edit profile mode and its IP range:

- 1) Click **Edit** in the MLD Profile Info table. Edit its IP range and click **Add** to save the settings.

Figure 3-7 Add IP-range

**Profile mode**

Profile ID:

Mode:

---

**Add IP-range**

Start IP:  (Format:ff01::1234:01)

End IP:  (Format:ff01::1234:01)

---

**IP-range Table**

| Select                 | Index | Start IP | End IP |
|------------------------|-------|----------|--------|
| No entry in the table. |       |          |        |

- 2) In the IP-range Table, you can select an IP range and click **Delete** to delete an IP range.
- 3) Click **Submit** to save the settings; click **Back** to go back to the previous page.

### 3.1.7 Binding Profile and Member Ports

With this function, you can configure each port's filtering profile and the number of multicast groups a port can join. Choose the menu **Multicast > MLD Snooping > Profile Binding** to load the following page.



Figure 3-8 Profile Binding

| Profile and Max Group Binding |        |                      |                      |                                   |     |                              |
|-------------------------------|--------|----------------------|----------------------|-----------------------------------|-----|------------------------------|
| UNIT: <b>1</b> LAGS           |        |                      |                      |                                   |     |                              |
| Select                        | Port   | Profile ID           | Max Group            | Overflow Action                   | LAG |                              |
| <input type="checkbox"/>      |        | <input type="text"/> | <input type="text"/> | <input type="text" value="Drop"/> |     |                              |
| <input type="checkbox"/>      | 1/0/1  |                      | 1000                 | Drop                              | --  | <a href="#">ClearBinding</a> |
| <input type="checkbox"/>      | 1/0/2  |                      | 1000                 | Drop                              | --  | <a href="#">ClearBinding</a> |
| <input type="checkbox"/>      | 1/0/3  |                      | 1000                 | Drop                              | --  | <a href="#">ClearBinding</a> |
| <input type="checkbox"/>      | 1/0/4  |                      | 1000                 | Drop                              | --  | <a href="#">ClearBinding</a> |
| <input type="checkbox"/>      | 1/0/5  |                      | 1000                 | Drop                              | --  | <a href="#">ClearBinding</a> |
| <input type="checkbox"/>      | 1/0/6  |                      | 1000                 | Drop                              | --  | <a href="#">ClearBinding</a> |
| <input type="checkbox"/>      | 1/0/7  |                      | 1000                 | Drop                              | --  | <a href="#">ClearBinding</a> |
| <input type="checkbox"/>      | 1/0/8  |                      | 1000                 | Drop                              | --  | <a href="#">ClearBinding</a> |
| <input type="checkbox"/>      | 1/0/9  |                      | 1000                 | Drop                              | --  | <a href="#">ClearBinding</a> |
| <input type="checkbox"/>      | 1/0/10 |                      | 1000                 | Drop                              | --  | <a href="#">ClearBinding</a> |
| <input type="checkbox"/>      | 1/0/11 |                      | 1000                 | Drop                              | --  | <a href="#">ClearBinding</a> |
| <input type="checkbox"/>      | 1/0/12 |                      | 1000                 | Drop                              | --  | <a href="#">ClearBinding</a> |
| <input type="checkbox"/>      | 1/0/13 |                      | 1000                 | Drop                              | --  | <a href="#">ClearBinding</a> |
| <input type="checkbox"/>      | 1/0/14 |                      | 1000                 | Drop                              | --  | <a href="#">ClearBinding</a> |
| <input type="checkbox"/>      | 1/0/15 |                      | 1000                 | Drop                              | --  | <a href="#">ClearBinding</a> |

### Binding Profile and Member Ports

Follow these steps to bind the profile to the port.

- 1) Select the port to be bound, and enter the Profile ID in the **Profile ID** column.

|              |                                                                                                             |
|--------------|-------------------------------------------------------------------------------------------------------------|
| Select       | Select the port to be bound.                                                                                |
| Port         | Displays the port number.                                                                                   |
| Profile ID   | Enter the profile ID you create to bind the profile to the port. One port can only be bound to one profile. |
| ClearBinding | Click to clear the binding between the profile and the port.                                                |

- 2) Click **Apply**.

### Configuring Max Groups a Port Can Join

Follow these steps to configure the maximum groups a port can join and overflow action.

- 1) Select a port to configure its Max Group and Overflow Action.

|        |                                   |
|--------|-----------------------------------|
| Select | Select the port to be configured. |
|--------|-----------------------------------|

|                        |                                                                                                                                                                                                                                                                                                                                                                                     |
|------------------------|-------------------------------------------------------------------------------------------------------------------------------------------------------------------------------------------------------------------------------------------------------------------------------------------------------------------------------------------------------------------------------------|
| <b>Max Group</b>       | Enter the number of multicast groups the port can join. The valid values are from 0 to 1000.                                                                                                                                                                                                                                                                                        |
| <b>Overflow Action</b> | Select the action towards the new multicast group when the number of multicast groups the port joined exceeds max group.<br><br><b>Drop:</b> Drop all subsequent membership report messages, and the port will not join any new multicast groups.<br><br><b>Replace:</b> Replace the existing multicast group owning the lowest multicast MAC address with the new multicast group. |

2) Click **Apply**.

### 3.1.8 Viewing MLD Statistics on Each Port

Choose the menu **Multicast > MLD Snooping > Packet Statistic** to load the following page.

Figure 3-9 View MLD Statistics on the Port

**Auto Refresh**

Auto Refresh:  Enable  Disable

Refresh Period:  sec(3-300) Apply

**MLD Statistics**

UNIT:

| Port   | Query Packet | Report Packet(V1) | Report Packet(V2) | done Packet | Error Packet |
|--------|--------------|-------------------|-------------------|-------------|--------------|
| 1/0/1  | 0            | 0                 | 0                 | 0           | 0            |
| 1/0/2  | 0            | 0                 | 0                 | 0           | 0            |
| 1/0/3  | 0            | 0                 | 0                 | 0           | 0            |
| 1/0/4  | 0            | 0                 | 0                 | 0           | 0            |
| 1/0/5  | 0            | 0                 | 0                 | 0           | 0            |
| 1/0/6  | 0            | 0                 | 0                 | 0           | 0            |
| 1/0/7  | 0            | 0                 | 0                 | 0           | 0            |
| 1/0/8  | 0            | 0                 | 0                 | 0           | 0            |
| 1/0/9  | 0            | 0                 | 0                 | 0           | 0            |
| 1/0/10 | 0            | 0                 | 0                 | 0           | 0            |
| 1/0/11 | 0            | 0                 | 0                 | 0           | 0            |
| 1/0/12 | 0            | 0                 | 0                 | 0           | 0            |
| 1/0/13 | 0            | 0                 | 0                 | 0           | 0            |
| 1/0/14 | 0            | 0                 | 0                 | 0           | 0            |
| 1/0/15 | 0            | 0                 | 0                 | 0           | 0            |

Clear
Refresh
Help

### Configuring Auto Refresh

Follow these steps to configure auto refresh.

- 1) Enable or disable Auto Refresh.

|                |                                                                                                                     |
|----------------|---------------------------------------------------------------------------------------------------------------------|
| Auto Refresh   | If Auto Refresh is enabled, statistics of MLD packets on this page will refresh automatically.                      |
| Refresh Period | After Auto Refresh is enabled, enter the interval between each refresh. The valid values are from 3 to 300 seconds. |

- 2) Click **Apply**.

### Viewing MLD Statistics

The MLD Statistics table displays all kinds of MLD statistics of all the ports.

### 3.1.9 Configuring Static Member Port

This function allows you to specify a port as a static member port in the multicast group.

Choose the menu **Multicast > Multicast Table > Static IPv4 Multicast Table** to load the following page.

Figure 3-10 Static Member Port

Create Static Multicast

Multicast IP:  (Format: 225.0.0.1)

VLAN ID:  (1-4094) Create

Forward Port:

UNIT: 1 LAGS

|   |   |   |   |    |    |    |    |
|---|---|---|---|----|----|----|----|
| 2 | 4 | 6 | 8 | 10 | 12 | 14 | 16 |
| 1 | 3 | 5 | 7 | 9  | 11 | 13 | 15 |

All
Clear

Unselected Port(s)

Selected Port(s)

Not Available for Selection

Search Option

Search Option All Search

Static Multicast IP Table

| Select                 | Multicast IP | VLAN ID | Forward Port |
|------------------------|--------------|---------|--------------|
| No entry in the table. |              |         |              |

All
Delete
Help

## Configuring Static Member Port

Follow these steps to configure static member port.

- 1) Enter the Multicast IP and VLAN ID. Specify the Static Member Port.

|              |                                                                                                                                                                                |
|--------------|--------------------------------------------------------------------------------------------------------------------------------------------------------------------------------|
| Multicast IP | Specify the multicast group that the static member is in.                                                                                                                      |
| VLAN ID      | Specify the VLAN that the static member is in.                                                                                                                                 |
| Forward Port | Specify one or more ports to be the static member port in the multicast group. Without aging, the static member port receives all multicast data sent to this multicast group. |

- 2) Click **Create**.

## Viewing MLD Static Multicast Groups

You can search MLD static multicast entries by using Multicast IP, VLAN ID or Forward Port as the Search Option.

Static Multicast IP Table displays details of all MLD static multicast groups.

## 3.2 Using the CLI

### 3.2.1 Enabling MLD Snooping Globally

|        |                                                                                           |
|--------|-------------------------------------------------------------------------------------------|
| Step 1 | <b>configure</b><br>Enter global configuration mode.                                      |
| Step 2 | <b>ipv6 mld snooping</b><br>Enable MLD Snooping Globally.                                 |
| Step 3 | <b>show ipv6 mld snooping</b><br>Show the basic MLD snooping configuration.               |
| Step 4 | <b>end</b><br>Return to privileged EXEC mode.                                             |
| Step 5 | <b>copy running-config startup-config</b><br>Save the settings in the configuration file. |

### 3.2.2 Enabling MLD Snooping on the Port

|        |                                                      |
|--------|------------------------------------------------------|
| Step 1 | <b>configure</b><br>Enter global configuration mode. |
|--------|------------------------------------------------------|

- 
- Step 2     **interface {fastEthernet *port* | range fastEthernet *port-list* | gigabitEthernet *port* | range gigabitEthernet *port-list* | ten-gigabitEthernet *port* | range ten-gigabitEthernet *port-list* | port-channel *port-channel-id* | range port-channe *port-channel-list*}**  
 Enter interface configuration mode.
- 
- Step 3     **ipv6 mld snooping**  
 Enable MLD Snooping on the specified port.
- 
- Step 4     **show ipv6 mld snooping**  
 Show the basic MLD snooping configuration.
- 
- Step 5     **end**  
 Return to privileged EXEC mode.
- 
- Step 6     **copy running-config startup-config**  
 Save the settings in the configuration file.
- 

The following example shows how to enable MLD Snooping globally and enable MLD Snooping.

**Switch#configure**

**Switch(config)#ipv6 mld snooping**

**Switch(config)#interface ten-gigabitEthernet 1/0/3**

**Switch(config-if)#ipv6 mld snooping**

**Switch(config-if)#show ipv6 mld snooping**

```
MLD Snooping           :Enable
Unknown Multicast      :Pass
Last Query Times       :2
Last Query Interval    :1
Global Member Age Time :260
Global Router Age Time :300
Global Report Suppression :Disable
Enable Port:Te1/0/3
Enable VLAN:
```

**Switch(config-if)#end**

**Switch#copy running-config startup-config**

## 3.2.3 Configuring MLD Snooping Parameters Globally

### Configuring Report Message Suppression

|        |                                                                                                                                                                                                                                                                                                                                                    |
|--------|----------------------------------------------------------------------------------------------------------------------------------------------------------------------------------------------------------------------------------------------------------------------------------------------------------------------------------------------------|
| Step 1 | <b>configure</b><br>Enter global configuration mode.                                                                                                                                                                                                                                                                                               |
| Step 2 | <b>ipv6 mld snooping report-suppression</b><br>Enable Report Message Suppression globally. If this function is enabled, the switch will only forward the first MLD report message to Layer 3 devices and suppress subsequent MLD report messages from the same multicast group during one query interval, which reduces the number of MLD packets. |
| Step 3 | <b>show ipv6 mld snooping</b><br>Show the basic MLD snooping configuration.                                                                                                                                                                                                                                                                        |
| Step 4 | <b>end</b><br>Return to privileged EXEC mode.                                                                                                                                                                                                                                                                                                      |
| Step 5 | <b>copy running-config startup-config</b><br>Save the settings in the configuration file.                                                                                                                                                                                                                                                          |

The following example shows how to enable Report Message Suppression:

**Switch#configure**

**Switch(config)#ipv6 mld snooping**

**Switch(config)#ipv6 mld snooping report-suppression**

**Switch(config)#show ipv6 mld snooping**

MLD Snooping :Enable

Unknown Multicast :Pass

Last Query Times :2

Last Query Interval :1

Global Member Age Time :260

Global Router Age Time :300

Global Report Suppression :Enable

Enable Port:

Enable VLAN:

**Switch(config)#end**

**Switch#copy running-config startup-config**

## Configuring Unknown Multicast

- 
- Step 1     **configure**  
Enter global configuration mode.
- 
- Step 2     **ipv6 mld snooping drop-unknown**  
Configure the way how the switch processes the multicast data from unknown multicast groups as Discard. Unknown multicast groups are multicast groups whose destination multicast address is not in the multicast forwarding table of the switch.
- 
- Step 3     **show ipv6 mld snooping**  
Show the basic MLD snooping configuration.
- 
- Step 4     **end**  
Return to privileged EXEC mode.
- 
- Step 5     **copy running-config startup-config**  
Save the settings in the configuration file.
- 

IGMP Snooping and MLD Snooping share the setting of Unknown Multicast, so you have to enable IGMP Snooping globally at the same time.

The following example shows how to configure the switch to discard unknown multicast data:

**Switch#configure**

**Switch(config)#ipv6 mld snooping**

**Switch(config)#ip igmp snooping**

**Switch(config)#ipv6 mld snooping drop-unknown**

**Switch(config)#show ipv6 mld snooping**

```
MLD Snooping           :Enable
Unknown Multicast      :Discard
Last Query Times       :2
Last Query Interval    :1
Global Member Age Time :260
Global Router Age Time :300
Global Report Suppression :Disable
Enable Port:
Enable VLAN:
```

**Switch(config)#end**

**Switch#copy running-config startup-config**

## 3.2.4 Configuring MLD Snooping Parameters on the Port

### Configuring Router Port Time and Member Port Time

|        |                                                                                                                                                                                                                                                                  |
|--------|------------------------------------------------------------------------------------------------------------------------------------------------------------------------------------------------------------------------------------------------------------------|
| Step 1 | <b>configure</b><br>Enter global configuration mode.                                                                                                                                                                                                             |
| Step 2 | <b>ipv6 mld snooping rtime <i>rtime</i></b><br><b>ipv6 mld snooping mtime <i>mtime</i></b><br><i>rtime</i> is the aging time of router ports, ranging from 60 to 600 seconds.<br><i>mtime</i> is the aging time of member ports, ranging from 60 to 600 seconds. |
| Step 3 | <b>show ipv6 mld snooping</b><br>Show the basic MLD snooping configuration.                                                                                                                                                                                      |
| Step 4 | <b>end</b><br>Return to privileged EXEC mode.                                                                                                                                                                                                                    |
| Step 5 | <b>copy running-config startup-config</b><br>Save the settings in the configuration file.                                                                                                                                                                        |

The following example shows how to configure the global router port time and member port time as 200 seconds:

**Switch#configure**

**Switch(config)#ipv6 mld snooping**

**Switch(config)#ipv6 mld snooping rtime 200**

**Switch(config)#ipv6 mld snooping mtime 200**

**Switch(config)#show ipv6 mld snooping**

```
MLD Snooping           :Enable
Unknown Multicast      :Pass
Last Query Times       :2
Last Query Interval    :1
Global Member Age Time :200
Global Router Age Time :200
Global Report Suppression :Disable
Enable Port:
Enable VLAN:
```



```
Switch(config)#end
```

```
Switch#copy running-config startup-config
```

## Configuring Fast Leave

|        |                                                                                                                                                                                                                                                                                                                                                                   |
|--------|-------------------------------------------------------------------------------------------------------------------------------------------------------------------------------------------------------------------------------------------------------------------------------------------------------------------------------------------------------------------|
| Step 1 | <b>configure</b><br>Enter global configuration mode.                                                                                                                                                                                                                                                                                                              |
| Step 2 | <b>interface {fastEthernet <i>port</i>   range fastEthernet <i>port-list</i>   gigabitEthernet <i>port</i>   range gigabitEthernet <i>port-list</i>   ten-gigabitEthernet <i>port</i>   range ten-gigabitEthernet <i>port-list</i>   port-channel <i>port-channel-id</i>   range port-channel <i>port-channel-list</i>}</b><br>Enter interface configuration mode |
| Step 3 | <b>ipv6 mld snooping immediate-leave</b><br>Enable Fast Leave on the specified port. With Fast Leave enabled on a port, the switch will delete the port-multicast group entry from the multicast forwarding table once the port receives a leave message. You should only use this function when there is a single receiver present on the port.                  |
| Step 4 | <b>show ipv6 mld snooping interface [fastEthernet [<i>port</i>   <i>port-list</i>]   gigabitEthernet [<i>port</i>   <i>port-list</i>]   ten-gigabitEthernet [<i>port</i>   <i>port-list</i>]] basic-config</b><br>Show the basic MLD snooping configuration on the specified port(s) or of all the ports.                                                         |
| Step 5 | <b>end</b><br>Return to privileged EXEC mode.                                                                                                                                                                                                                                                                                                                     |
| Step 6 | <b>copy running-config startup-config</b><br>Save the settings in the configuration file.                                                                                                                                                                                                                                                                         |

The following example shows how to enable Fast Leave on port 1/0/3:

```
Switch#configure
```

```
Switch(config)#ipv6 mld snooping
```

```
Switch(config)#interface ten-gigabitEthernet 1/0/3
```

```
Switch(config-if)#ipv6 mld snooping
```

```
Switch(config-if)#ipv6 mld snooping immediate-leave
```

```
Switch(config-if)#show ipv6 mld snooping interface ten-gigabitEthernet 1/0/3 basic-config
```

| Port    | MLD-Snooping | Fast-Leave |
|---------|--------------|------------|
| -----   | -----        | -----      |
| Te1/0/3 | enable       | enable     |

```
Switch(config-if)#end
```

```
Switch#copy running-config startup-config
```

## Configuring Max Group and Overflow Action on the Port

|        |                                                                                                                                                                                                                                                                                                                                                                                                                                              |
|--------|----------------------------------------------------------------------------------------------------------------------------------------------------------------------------------------------------------------------------------------------------------------------------------------------------------------------------------------------------------------------------------------------------------------------------------------------|
| Step 1 | <b>configure</b><br>Enter global configuration mode.                                                                                                                                                                                                                                                                                                                                                                                         |
| Step 2 | <b>interface {fastEthernet <i>port</i>   range fastEthernet <i>port-list</i>   gigabitEthernet <i>port</i>   range gigabitEthernet <i>port-list</i>   ten-gigabitEthernet <i>port</i>   range ten-gigabitEthernet <i>port-list</i>   port-channel <i>port-channel-id</i>   range port-channel <i>port-channel-list</i>}</b><br>Enter interface configuration mode.                                                                           |
| Step 3 | <b>ipv6 mld snooping max-groups <i>maxgroup</i></b><br>Enter the number of multicast groups the port can join. The range is 0 to 1000.                                                                                                                                                                                                                                                                                                       |
| Step 4 | <b>ipv6 mld snooping max-groups action {drop   replace}</b><br>Specify the action towards the new multicast group when the number of multicast groups the port joined exceeds max group.<br><br><b>drop:</b> Drop all subsequent membership report messages, and the port join no more new multicast groups.<br><br><b>replace:</b> Replace the existing multicast group with the lowest multicast MAC address with the new multicast group. |
| Step 5 | <b>show ipv6 mld snooping interface [fastEthernet [<i>port</i>   <i>port-list</i>]   gigabitEthernet [<i>port</i>   <i>port-list</i>]   ten-gigabitEthernet [<i>port</i>   <i>port-list</i>]] max-groups</b><br>Show the IGMP group limitation on the specified port(s) or of all the ports.                                                                                                                                                 |
| Step 6 | <b>end</b><br>Return to privileged EXEC mode.                                                                                                                                                                                                                                                                                                                                                                                                |
| Step 7 | <b>copy running-config startup-config</b><br>Save the settings in the configuration file.                                                                                                                                                                                                                                                                                                                                                    |

The following example shows how to configure the Max Group as 500 and the Overflow Action as Drop on port 1/0/3:

```
Switch#configure
```

```
Switch(config)#ipv6 mld snooping
```

```
Switch(config)#interface ten-gigabitEthernet 1/0/3
```

```
Switch(config-if)#ipv6 mld snooping
```

```
Switch(config-if)#ipv6 mld snooping max-groups 500
```

```
Switch(config-if)#ipv6 mld snooping max-groups action drop
```

```
Switch(config-if)#show ipv6 mld snooping interface ten-gigabitEthernet 1/0/3 max-groups
```

| Port | Max-Groups | Overflow-Action |
|------|------------|-----------------|
| ---- | -----      | -----           |

```
Te1/0/3      500          Drop
```

```
Switch(config-if)#end
```

```
Switch#copy running-config startup-config
```

### 3.2.5 Configuring MLD Snooping Last Listener Query

|        |                                                                                                                                                                                              |
|--------|----------------------------------------------------------------------------------------------------------------------------------------------------------------------------------------------|
| Step 1 | <b>configure</b><br>Enter global configuration mode.                                                                                                                                         |
| Step 2 | <b>ipv6 mld snooping last-listener query-interval <i>interval</i></b><br><i>interval</i> determines the interval between MASQs sent by the switch. The valid values are from 1 to 5 seconds. |
| Step 3 | <b>ipv6 mld snooping last-listener query-count <i>num</i></b><br><i>num</i> determines the number of MASQs sent by the switch. The valid values are from 1 to 5.                             |
| Step 4 | <b>show ipv6 mld snooping</b><br>Show the basic MLD snooping configuration.                                                                                                                  |
| Step 5 | <b>end</b><br>Return to privileged EXEC mode.                                                                                                                                                |
| Step 6 | <b>copy running-config startup-config</b><br>Save the settings in the configuration file.                                                                                                    |

The following example shows how to configure the last listener query count as 5 and the last listener query interval as 5 seconds:

```
Switch#configure
```

```
Switch(config)#ipv6 mld snooping
```

```
Switch(config)#ipv6 mld snooping last-listener query-count 5
```

```
Switch(config)#ipv6 mld snooping last-listener query-interval 5
```

```
Switch(config)#show ipv6 mld snooping
```

```
MLD Snooping           :Enable
Unknown Multicast      :Pass
Last Query Times       :5
Last Query Interval    :5
Global Member Age Time :260
Global Router Age Time :300
Global Report Suppression :Disable
```

Enable Port:

Enable VLAN:

**Switch(config)#end**

**Switch#copy running-config startup-config**

## 3.2.6 Configuring MLD Snooping Parameters in the VLAN

### Configuring Router Port Time and Member Port Time

|        |                                                                                                                                                                                                                                                                                                                                                      |
|--------|------------------------------------------------------------------------------------------------------------------------------------------------------------------------------------------------------------------------------------------------------------------------------------------------------------------------------------------------------|
| Step 1 | <b>configure</b><br>Enter global configuration mode.                                                                                                                                                                                                                                                                                                 |
| Step 2 | <b>ipv6 mld snooping vlan-config <i>vlan-id-list</i> [<i>rtime router-time</i>   <i>mtime member-time</i>]</b><br><i>router-time</i> is the aging time of the router ports in the specified VLAN, ranging from 60 to 600 seconds.<br><i>member-time</i> is the aging time of the member ports in the specified VLAN, ranging from 60 to 600 seconds. |
| Step 3 | <b>show ipv6 mld snooping vlan <i>vlan-id</i></b><br>Show the basic MLD snooping configuration in the specified VLAN.                                                                                                                                                                                                                                |
| Step 4 | <b>end</b><br>Return to privileged EXEC mode.                                                                                                                                                                                                                                                                                                        |
| Step 5 | <b>copy running-config startup-config</b><br>Save the settings in the configuration file.                                                                                                                                                                                                                                                            |

The following example shows how to enable MLD Snooping in VLAN 2 and VLAN 3, configure the router port time as 500 seconds and the member port time as 400 seconds:

**Switch#configure**

**Switch(config)#ipv6 mld snooping**

**Switch(config)#ipv6 mld snooping vlan-config 2-3 rtime 500**

**Switch(config)#ipv6 mld snooping vlan-config 2-3 mtime 400**

**Switch(config)#show ipv6 mld snooping vlan 2**

Vlan Id: 2

Router Time:500

Member Time:400

Static Router Port:None

Dynamic Router Port:None

```

Forbidden Router Port:None
Switch(config)#show ipv6 mld snooping vlan 3
Vlan Id: 3
Router Time:500
Member Time:400
Static Router Port:None
Dynamic Router Port:None
Forbidden Router Port:None
Switch(config)#end

```

**Switch#copy running-config startup-config**

### Configuring Static Router Port

|        |                                                                                                                                                                                                                                                                                                                             |
|--------|-----------------------------------------------------------------------------------------------------------------------------------------------------------------------------------------------------------------------------------------------------------------------------------------------------------------------------|
| Step 1 | <b>configure</b><br>Enter global configuration mode.                                                                                                                                                                                                                                                                        |
| Step 2 | <b>ipv6 mld snooping vlan-config</b> <i>vlan-id-list</i> [ <b>rport interface</b> { <b>gigabitEthernet</b> <i>port-list</i>   <b>ten-gigabitEthernet</b> <i>port-list</i>   <b>port-channel</b> <i>port-channel-id</i> }]<br><i>port-list</i> and <i>port-channel-id</i> are the static router ports in the specified VLAN. |
| Step 3 | <b>show ipv6 mld snooping vlan</b> <i>vlan-id</i><br>Show the basic MLD snooping configuration in the specified VLAN.                                                                                                                                                                                                       |
| Step 4 | <b>end</b><br>Return to privileged EXEC mode.                                                                                                                                                                                                                                                                               |
| Step 5 | <b>copy running-config startup-config</b><br>Save the settings in the configuration file.                                                                                                                                                                                                                                   |

The following example shows how to enable MLD Snooping in VLAN 2 and configure port 1/0/2 as the static router port:

**Switch#configure**

**Switch(config)#ipv6 mld snooping**

**Switch(config)#ipv6 mld snooping vlan-config 2 rport interface ten-gigabitEthernet 1/0/2**

**Switch(config)#show ipv6 mld snooping vlan 2**

Vlan Id: 2

Router Time:0

Member Time:0

Static Router Port:Te1/0/2

Dynamic Router Port:None

Forbidden Router Port:None

**Switch(config)#end**

**Switch#copy running-config startup-config**

## Configuring Forbidden Router Port

|        |                                                                                                                                                                                                                                                                                                                               |
|--------|-------------------------------------------------------------------------------------------------------------------------------------------------------------------------------------------------------------------------------------------------------------------------------------------------------------------------------|
| Step 1 | <b>configure</b><br>Enter global configuration mode.                                                                                                                                                                                                                                                                          |
| Step 2 | <b>ipv6 mld snooping vlan-config <i>vlan-id-list</i> router-ports-forbidden interface {gigabitEthernet <i>port-list</i>   ten-gigabitEthernet <i>port-list</i>   port-channel <i>port-channel-id</i>}</b><br><i>port-list</i> and <i>port-channel-id</i> are the ports that cannot become router ports in the specified VLAN. |
| Step 3 | <b>show ipv6 mld snooping vlan <i>vlan-id</i></b><br>Show the basic MLD snooping configuration in the specified VLAN.                                                                                                                                                                                                         |
| Step 4 | <b>end</b><br>Return to privileged EXEC mode.                                                                                                                                                                                                                                                                                 |
| Step 5 | <b>copy running-config startup-config</b><br>Save the settings in the configuration file.                                                                                                                                                                                                                                     |

The following example shows how to enable MLD Snooping in VLAN 2 and forbid port 1/0/4-6 from becoming router ports (port 1/0/4-6 will drop all multicast data from Layer 3 devices):

**Switch#config**

**Switch(config)#ipv6 mld snooping**

**Switch(config)#ipv6 mld snooping vlan-config 2 router-ports-forbidden interface ten-gigabitEthernet 1/0/4-6**

**Switch(config)#show ipv6 mld snooping vlan 2**

Vlan Id: 2

Router Time:0

Member Time:0

Static Router Port:None

Dynamic Router Port:None

Forbidden Router Port:Te1/0/4-6

**Switch(config)#end**

**Switch#copy running-config startup-config**

## Configuring Static Multicast (Multicast IP and Forward Port)

Step 1      **configure**

Enter global configuration mode.

Step 2      **ipv6 mld snooping vlan-config *vlan-id-list* static *ip* interface {*gigabitEthernet port-list* | *ten-gigabitEthernet port-list* | *port-channel port-channel-id*}**

*vlan-id-list* specifies the VLAN to be configured.

*ip* specifies the static multicast IP address.

*port-list* and *port-channel-id* specify the forward ports (member ports) bound to the static multicast IP address in the specified VLAN.

Step 3      **show ipv6 mld snooping groups static**

Show the static MLD snooping configuration.

Step 4      **end**

Return to privileged EXEC mode.

Step 5      **copy running-config startup-config**

Save the settings in the configuration file.

The following example shows how to configure ff01::1234:02 as the static multicast IP and specify port 1/0/9-10 as the forward ports:

**Switch#configure**

**Switch(config)#ipv6 mld snooping**

**Switch(config)#ipv6 mld snooping vlan-config 2 static ff01::1234:02 interface ten-gigabitEthernet 1/0/9-10**

**Switch(config)#show ipv6 mld snooping groups static**

| Multicast-ip  | VLAN-id | Addr-type | Switch-port |
|---------------|---------|-----------|-------------|
| -----         | -----   | -----     | -----       |
| ff01::1234:02 | 2       | static    | Te1/0/9-10  |

**Switch(config)#end**

**Switch#copy running-config startup-config**

## 3.2.7 Configuring MLD Snooping Parameters in the Multicast VLAN

### Configuring Router Port Time and Member Port Time

|        |                                                                                                                                                                                                                                                                                                                                                                                                            |
|--------|------------------------------------------------------------------------------------------------------------------------------------------------------------------------------------------------------------------------------------------------------------------------------------------------------------------------------------------------------------------------------------------------------------|
| Step 1 | <b>configure</b><br>Enter global configuration mode.                                                                                                                                                                                                                                                                                                                                                       |
| Step 2 | <b>ipv6 mld snooping multi-vlan-config [vlan-id] [rtime router-time   mtime member-time]</b><br><i>vlan-id</i> specifies the VLAN to be created or to be configured.<br><i>router-time</i> is the aging time of the router ports in the multicast VLAN, ranging from 60 to 600 seconds.<br><i>member-time</i> is the aging time of the member ports in the multicast VLAN, ranging from 60 to 600 seconds. |
| Step 3 | <b>show ipv6 mld snooping multi-vlan</b><br>Show the MLD snooping configuration in the multicast VLAN.                                                                                                                                                                                                                                                                                                     |
| Step 4 | <b>end</b><br>Return to privileged EXEC mode.                                                                                                                                                                                                                                                                                                                                                              |
| Step 5 | <b>copy running-config startup-config</b><br>Save the settings in the configuration file.                                                                                                                                                                                                                                                                                                                  |

The following example shows how to configure VLAN 5 as the multicast VLAN, set the router port time as 500 seconds and the member port time as 400 seconds:

**Switch#configure**

**Switch(config)#ipv6 mld snooping**

**Switch(config)#ipv6 mld snooping multi-vlan-config 5 rtime 500**

**Switch(config)#ipv6 mld snooping multi-vlan-config 5 mtime 400**

**Switch(config)#show ipv6 mld snooping multi-vlan**

Multicast Vlan:Enable

Vlan Id: 5

Router Time:500

Member Time:400

Replace Source IP:::

Static Router Port:None

Dynamic Router Port:None

Forbidden Router Port:None

**Switch(config)#end**



**Switch#copy running-config startup-config****Configuring Static Router Port**

|        |                                                                                                                                                                                                                                                                                                                                             |
|--------|---------------------------------------------------------------------------------------------------------------------------------------------------------------------------------------------------------------------------------------------------------------------------------------------------------------------------------------------|
| Step 1 | <b>configure</b><br>Enter global configuration mode.                                                                                                                                                                                                                                                                                        |
| Step 2 | <b>ipv6 mld snooping multi-vlan-config [vlan-id] [rport interface {gigabitEthernet port-list   ten-gigabitEthernet port-list   port-channel port-channel-id}]</b><br><i>vlan-id</i> specifies the VLAN to be created or to be configured.<br><i>port-list</i> and <i>port-channel-id</i> are the static router ports in the multicast VLAN. |
| Step 3 | <b>show ipv6 mld snooping multi-vlan</b><br>Show the MLD snooping configuration in the multicast VLAN.                                                                                                                                                                                                                                      |
| Step 4 | <b>end</b><br>Return to privileged EXEC mode.                                                                                                                                                                                                                                                                                               |
| Step 5 | <b>copy running-config startup-config</b><br>Save the settings in the configuration file.                                                                                                                                                                                                                                                   |

The following example shows how to configure VLAN 5 as the multicast VLAN, and set port 1/0/5 as the static router port:

**Switch#configure****Switch(config)#ipv6 mld snooping**

```
Switch(config)#ipv6 mld snooping multi-vlan-config 5 rport interface ten-gigabitEthernet 1/0/5
```

**Switch(config)#show ipv6 mld snooping multi-vlan**

```
Multicast Vlan:Enable
```

```
Vlan Id: 5
```

```
Router Time:300
```

```
Member Time:260
```

```
Replace Source IP:::
```

```
Static Router Port:Te1/0/5
```

```
Dynamic Router Port:None
```

```
Forbidden Router Port:None
```

**Switch(config)#end****Switch#copy running-config startup-config**

## Configuring Forbidden Router Port

- 
- Step 1     **configure**  
Enter global configuration mode.
- 
- Step 2     **ipv6 mld snooping multi-vlan-config [vlan-id] router-ports-forbidden interface {gigabitEthernet port-list | ten-gigabitEthernet port-list | port-channel port-channel-id}**  
*vlan-id* specifies the multicast VLAN to be configured.  
*port-list* and *port-channel-id* are the ports that cannot become router ports in the multicast VLAN.
- 
- Step 3     **show ipv6 mld snooping multi-vlan**  
Show the MLD snooping configuration in the multicast VLAN.
- 
- Step 4     **end**  
Return to privileged EXEC mode.
- 
- Step 5     **copy running-config startup-config**  
Save the settings in the configuration file.
- 

The following example shows how to configure VLAN 5 as the multicast VLAN, and set port 1/0/6 as the forbidden router port:

**Switch#configure**

**Switch(config)#ipv6 mld snooping**

**Switch(config)#ipv6 mld snooping multi-vlan-config 5 router-ports-forbidden interface ten-gigabitEthernet 1/0/6**

**Switch(config)#show ipv6 mld snooping multi-vlan**

Multicast Vlan:Enable

Vlan Id: 5

Router Time:300

Member Time:260

Replace Source IP:::

Static Router Port:None

Dynamic Router Port:None

Forbidden Router Port:Te1/0/6

**Switch(config)#end**

**Switch#copy running-config startup-config**

## Configuring Replace Source IP

- 
- Step 1     **configure**  
Enter global configuration mode.
- 
- Step 2     **ipv6 mld snooping multi-vlan-config [vlan-id] replace-sourceip ip**  
*vlan-id* specifies the multicast VLAN to be configured.  
*ip* specifies the new source IP. The switch will replace the source IP in the MLD multicast data sent by the multicast VLAN with the IP address you enter.
- 
- Step 3     **show ipv6 mld snooping multi-vlan**  
Show the MLD snooping configuration in the multicast VLAN.
- 
- Step 4     **end**  
Return to privileged EXEC mode.
- 
- Step 5     **copy running-config startup-config**  
Save the settings in the configuration file.
- 

The following example shows how to configure VLAN 5 as the multicast VLAN and replace the source IP in the MLD packets sent by the switch with FE80::02FF:FFFF:FE00:0001:

**Switch#configure**

**Switch(config)#ipv6 mld snooping**

**Switch(config)#ipv6 mld snooping multi-vlan-config 5 replace-sourceip fe80::02ff:ffff:fe00:0001**

**Switch(config)#show ipv6 mld snooping multi-vlan**

Multicast Vlan:Enable

Vlan Id: 5

Router Time:300

Member Time:260

Replace Source IP:fe80::2ff:ffff:fe00:1

Static Router Port:None

Dynamic Router Port:None

Forbidden Router Port:None

**Switch(config)#end**

**Switch#copy running-config startup-config**

## 3.2.8 Configuring the Querier

### Enabling MLD Querier

- 
- |        |                                  |
|--------|----------------------------------|
| Step 1 | <b>configure</b>                 |
|        | Enter global configuration mode. |
- 
- |        |                                                          |
|--------|----------------------------------------------------------|
| Step 2 | <b>ipv6 mld snooping querier vlan <i>vlan-id</i></b>     |
|        | <i>vlan-id</i> specifies the VLAN to enable MLD Querier. |
- 
- |        |                                                              |
|--------|--------------------------------------------------------------|
| Step 3 | <b>show ipv6 mld snooping querier [vlan <i>vlan-id</i> ]</b> |
|        | Show the MLD querier configuration.                          |
- 
- |        |                                 |
|--------|---------------------------------|
| Step 4 | <b>end</b>                      |
|        | Return to privileged EXEC mode. |
- 
- |        |                                              |
|--------|----------------------------------------------|
| Step 5 | <b>copy running-config startup-config</b>    |
|        | Save the settings in the configuration file. |
- 

The following example shows how to enable MLD Snooping and MLD Querier in VLAN 4:

```
Switch#configure
```

```
Switch(config)#ipv6 mld snooping
```

```
Switch(config)#ipv6 mld snooping querier vlan 4
```

```
Switch(config)#show ipv6 mld snooping querier
```

```
VLAN 4:
```

```
-----
```

```
Maximum Response Time:    10
```

```
Query Interval:          60
```

```
General Query Source IP:  fe80::2ff:ffff:fe00:1
```

```
Switch(config)#end
```

```
Switch#copy running-config startup-config
```

### Configuring Query Interval, Max Response Time and General Query Source IP

- 
- |        |                                  |
|--------|----------------------------------|
| Step 1 | <b>configure</b>                 |
|        | Enter global configuration mode. |
-

- 
- Step 2     **ipv6 mld snooping querier vlan** *vlan-id* **{query-interval** *interval* **| max-response-time** *response-time* **| general-query source-ip** *ip-addr*  
*vlan-id* specifies the VLAN where the querier is.  
*interval* is the interval between general query messages sent by the querier.  
*response-time* is the host's maximum response time to general query messages in a range of 1 to 25 seconds.  
*ip-addr* is the source IP address of the general query messages sent by the querier. It cannot be a multicast address or a broadcast address.
- 
- Step 3     **show ipv6 mld snooping querier** [*vlan* *vlan-id* ]  
 Show the detailed MLD querier configuration.
- 
- Step 4     **end**  
 Return to privileged EXEC mode.
- 
- Step 5     **copy running-config startup-config**  
 Save the settings in the configuration file.
- 

The following example shows how to enable MLD Snooping and MLD Querier in VLAN 4, set the query interval as 100 seconds, the max response time as 20 seconds, and the general query source IP as fe80::2ff:ffff:fe00:1:

### Switch#configure

#### Switch(config)#ipv6 mld snooping

```
Switch(config)#ipv6 mld snooping querier vlan 4 query-interval 100
```

```
Switch(config)#ipv6 mld snooping querier vlan 4 max-response-time 20
```

```
Switch(config)#ipv6 mld snooping querier vlan 4 general-query source-ip fe80::2ff:ffff:fe00:1
```

#### Switch(config)#show ipv6 mld snooping querier

```
VLAN 4:
```

```
-----
```

```
Maximum Response Time:      20
```

```
Query Interval:             100
```

```
General Query Source IP:    fe80::2ff:ffff:fe00:1
```

#### Switch(config)#end

#### Switch#copy running-config startup-config

## 3.2.9 Configuring Multicast Filtering

### Creating Profile

---

|        |                                                                                                                                                                                                                                                                                                                                                                   |
|--------|-------------------------------------------------------------------------------------------------------------------------------------------------------------------------------------------------------------------------------------------------------------------------------------------------------------------------------------------------------------------|
| Step 1 | <b>configure</b><br>Enter global configuration mode.                                                                                                                                                                                                                                                                                                              |
| Step 2 | <b>ipv6 mld profile <i>id</i></b><br>Create a new profile and enter profile configuration mode.                                                                                                                                                                                                                                                                   |
| Step 3 | <b>deny</b><br><b>permit</b><br>Configure the profile's filtering mode.<br><br><b>permit</b> is similar to a whitelist, indicating that the switch only allow specific member ports to join specific multicast groups.<br><br><b>deny</b> is similar to a blacklist, indicating that the switch disallow specific member ports to join specific multicast groups. |
| Step 4 | <b>range <i>start-ip end-ip</i></b><br>Configure the range of multicast IP to be filtered. <i>start-ip</i> , <i>end-ip</i> are the start IP and end IP of the IP range respectively.                                                                                                                                                                              |
| Step 5 | <b>end</b><br>Return to privileged EXEC mode.                                                                                                                                                                                                                                                                                                                     |
| Step 6 | <b>show ipv6 mld profile [<i>id</i>]</b><br>Show the detailed MLD profile configuration.                                                                                                                                                                                                                                                                          |
| Step 7 | <b>copy running-config startup-config</b><br>Save the settings in the configuration file.                                                                                                                                                                                                                                                                         |

---

The following example shows how to configure Profile 1 so that the switch filters multicast data sent to ff01::1234:5-ff01::1234:8:

```
Switch#configure
```

```
Switch(config)#ipv6 mld snooping
```

```
Switch(config)#ipv6 mld profile 1
```

```
Switch(config-mld-profile)#deny
```

```
Switch(config-mld-profile)#range ff01::1234:5 ff01::1234:8
```

```
Switch(config-mld-profile)#show ipv6 mld profile
```

```
MLD Profile 1
```

```
deny
```

```
range ff01::1234:5 ff01::1234:8
```

```
Switch(config)#end
```

```
Switch#copy running-config startup-config
```

## Binding Profile to the Port

|        |                                                                                                                                                                                                                                                                                                                                                                   |
|--------|-------------------------------------------------------------------------------------------------------------------------------------------------------------------------------------------------------------------------------------------------------------------------------------------------------------------------------------------------------------------|
| Step 1 | <b>configure</b><br>Enter global configuration mode.                                                                                                                                                                                                                                                                                                              |
| Step 2 | <b>interface {fastEthernet <i>port</i>   range fastEthernet <i>port-list</i>   gigabitEthernet <i>port</i>   range gigabitEthernet <i>port-list</i>   ten-gigabitEthernet <i>port</i>   range ten-gigabitEthernet <i>port-list</i>   port-channel <i>port-channel-id</i>   range port-channel <i>port-channel-list</i>}</b><br>Enter interface configuration mode |
| Step 3 | <b>ipv6 mld filter <i>profile-id</i></b><br>Bind <i>profile-id</i> to the specified port.                                                                                                                                                                                                                                                                         |
| Step 4 | <b>show ipv6 MLD profile [<i>id</i>]</b><br>Show the detailed MLD profile configuration.                                                                                                                                                                                                                                                                          |
| Step 5 | <b>end</b><br>Return to privileged EXEC mode.                                                                                                                                                                                                                                                                                                                     |
| Step 6 | <b>copy running-config startup-config</b><br>Save the settings in the configuration file.                                                                                                                                                                                                                                                                         |

The following example shows how to bind Profile 1 to port 1/0/2 so that port 1/0/2 filters multicast data sent to ff01::1234:5-ff01::1234:8:

```
Switch#configure
```

```
Switch(config)#ipv6 mld snooping
```

```
Switch(config)#ipv6 mld profile 1
```

```
Switch(config-mld-profile)#deny
```

```
Switch(config-mld-profile)#range ff01::1234:5 ff01::1234:8
```

```
Switch(config-mld-profile)#exit
```

```
Switch(config)#interface ten-gigabitEthernet 1/0/2
```

```
Switch(config-if)#ipv6 mld snooping
```

```
Switch(config-if)#ipv6 mld filter 1
```

```
Switch(config-if)#show ipv6 mld profile
```

```
MLD Profile 1
```

```
deny
```

```
range ff01::1234:5 ff01::1234:8
```

```
Binding Port(s)
```

```
Te1/0/2
```

```
Switch(config)#end
```

```
Switch#copy running-config startup-config
```



# 4 Viewing Multicast Snooping Configurations

## 4.1 Using the GUI

### 4.1.1 Viewing IPv4 Multicast Snooping Configurations

Choose the menu **Multicast > Multicast Table > IPv4 Multicast Table** to view all valid Multicast IP-VLAN-Port entries.

Figure 4-1 IPv4 Multicast Table

Search Option

Search Option

**Multicast IP Table**

| Multicast IP           | VLAN ID | Forward Port |
|------------------------|---------|--------------|
| No entry in the table. |         |              |

#### Search Option

Search Option Search for specific multicast entries by using Multicast IP, VLAN ID and Forward Port.

#### Multicast IP Table

Multicast IP Multicast source IP.

VLAN ID ID of the VLAN that the multicast group is in.

Forward Port All ports in the multicast group, including router ports and member ports.

### 4.1.1 Viewing IPv6 Multicast Snooping Configurations

Choose the menu **Multicast > Multicast Table > IPv6 Multicast Table** to view all valid Multicast IP-VLAN-Port entries.

Figure 4-2 IPv6 Multicast Table

Search Option

Search Option

All
▼

Search

Multicast IP Table

| Multicast IP           | VLAN ID | Forward Port |
|------------------------|---------|--------------|
| No entry in the table. |         |              |

Refresh

Help

## 4.2 Using the CLI

### 4.2.1 Viewing IPv4 Multicast Snooping Configurations

#### **show ip igmp snooping**

Displays global settings of IGMP Snooping.

#### **show ip igmp snooping interface [ fastEthernet [ *port* | *port-list* ] | gigabitEthernet [ *port* | *port-list* ] | ten-gigabitEthernet [ *port* | *port-list* ] ] {basic-config | max-groups | packet-stat}**

Displays settings of IGMP Snooping on the port(s).

*port* | *port-list* specifies the port(s) to display.

*basic-config* | *max-groups* | *packet-stat* displays the related IGMP configuration information.

#### **show ip igmp snooping interface [port-channel [ *lagid* ] ] {basic-config | max-groups}**

Displays settings of IGMP Snooping on the port-channel.

*lagid* specifies the LAG(s) to display.

*basic-config* | *max-groups* displays the related IGMP configuration information.

#### **show ip igmp snooping vlan [ *vlan-id* ]**

Displays settings of IGMP Snooping in specific VLAN or all the VLANs.

#### **show ip igmp snooping multi-vlan**

Displays settings of IGMP Snooping in the multicast VLAN.

#### **show ip igmp snooping groups vlan *vlan-id* *multicast\_addr***

Displays information of specific multicast group in the specific VLAN.

---

**show ip igmp snooping groups [ vlan *vlan-id* ] [count | dynamic | dynamic count | static | static count ]**

Displays information of specific multicast group in all VLANs or in the specific VLAN.

*count*: displays the number of multicast groups.

*dynamic*: displays information of all dynamic multicast groups.

*dynamic count*: displays the number of dynamic multicast groups.

*static*: displays information of all static multicast groups.

*static count*: displays the number of static multicast groups.

---

**show ip igmp snooping querier [vlan *vlan-id* ]**

Displays information of IGMP Querier in all VLANs or in the specific VLAN.

---

**show ip igmp profile [*id*]**

Displays settings in all profiles or in the specific profile.

---

**clear ip igmp snooping statistics**

Clear all statistics of all IGMP packets.

---

## 4.2.2 Viewing IPv6 Multicast Snooping Configurations

---

**show ipv6 mld snooping**

Displays global settings of MLD Snooping.

---

**show ipv6 mld snooping interface [ fastEthernet [*port* | *port-list*] | gigabitEthernet [*port* | *port-list*] | ten-gigabitEthernet [*port* | *port-list*] ] {basic-config | max-groups | packet-stat}**

Displays settings of MLD Snooping on the port.

*port* | *port-list*: specifies the port(s) to display.

*basic-config* | *max-groups* | *packet-stat* displays the related MLD configuration information.

---

**show ipv6 mld snooping interface [port-channel [*lagid*] ] {basic-config | max-groups}**

Displays settings of MLD Snooping on the port-channel.

*lagid*: specifies the LAG(s) to display.

*basic-config* | *max-groups*: displays the related MLD configuration information.

---

**show ipv6 mld snooping vlan [*vlan-id*]**

Displays settings of MLD Snooping in specific VLAN or all the VLANs.

---

**show ipv6 mld snooping multi-vlan**

Displays settings of MLD Snooping in the multicast VLAN.

---

**show ipv6 mld snooping groups vlan *vlan-id* *multicast\_addr***

Displays information of specific multicast group in the specific VLAN.

---

---

**show ipv6 mld snooping groups [vlan *vlan-id*] [count | dynamic | dynamic count | static | static count]**

Displays information of specific multicast group in all VLANs or in the specific VLAN.

**count** displays the number of multicast groups.

**dynamic** displays information of all dynamic multicast groups.

**dynamic count** displays the number of dynamic multicast groups.

**static** displays information of all static multicast groups.

**static count** displays the number of static multicast groups.

---

**show ipv6 mld snooping querier [vlan *vlan-id*]**

Displays information of MLD Querier in all VLANs or in the specific VLAN.

---

**show ipv6 mld profile [*id*]**

Displays settings in all profiles or in the specific profile.

---

**clear ipv6 mld snooping statistics**

Clear all statistics of all MLD packets.

---

# 5 Configuration Examples

## 5.1 Example for Configuring Basic IGMP Snooping

### 5.1.1 Network Requirements

Host B, Host C and Host D are in the same VLAN of the switch. All of them want to receive multicast data sent to multicast group 225.1.1.1.

As shown in the following topology, Host B, Host C and Host D are connected to port 1/0/1, port 1/0/2 and port 1/0/3 respectively. Port 1/0/4 is the router port connected to the multicast querier.

Figure 5-1 Network Topology for Basic IGMP Snooping

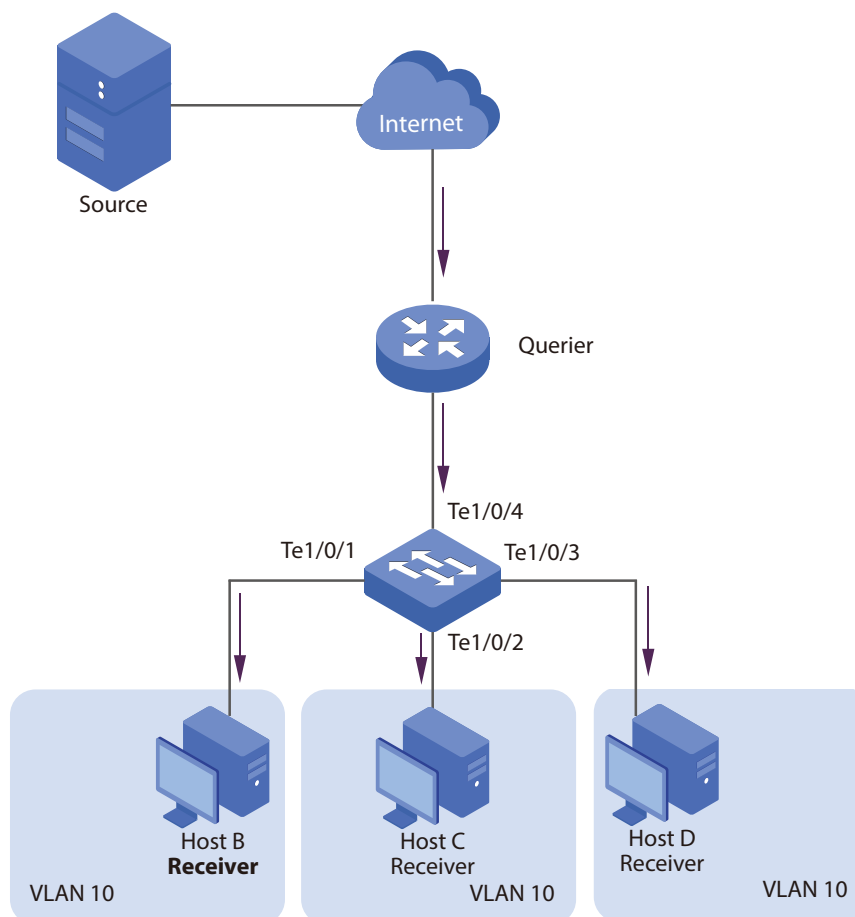

### 5.1.2 Configuration Scheme

- Enable IGMP Snooping globally and on the port.
- Add the three member ports and the router port to a VLAN and configure their PVIDs.

Enable IGMP Snooping in the VLAN. Demonstrated with T1700X-16TS, this section provides configuration procedures in two ways: using the GUI and using the CLI.

### 5.1.3 Using the GUI

- 1) Choose the menu **Multicast > IGMP Snooping > Snooping Config** to load the following page. Enable IGMP Snooping globally, and keep the default values in the Router Port Time and Member Port Time fields.

Figure 5-2 Configure IGMP Snooping Globally

**Global Config**

IGMP Snooping  Enable  Disable

Unknown Multicast  Forward  Discard

Report Message Suppression  Enable  Disable

Router Port Time  sec (60-600)

Member Port Time  sec (60-600)

Last Listener Query Interval:  secs(1-5)

Last Listener Query Count:  (1-5)

**IGMP Snooping Status**

| Description  | Member |
|--------------|--------|
| Enable ports |        |
| Enable VLAN  |        |

- 2) Choose the menu **Multicast > IGMP Snooping > Snooping Config** to load the following page. Enable IGMP Snooping on port 1/0/1-4.

Figure 5-3 Enable IGMP Snooping on the Ports

**Port Config**

UNIT: **1** LAGS

| Select                              | Port   | IGMP Snooping          | Fast Leave             | LAG |
|-------------------------------------|--------|------------------------|------------------------|-----|
| <input type="checkbox"/>            |        | <input type="text"/> ▾ | <input type="text"/> ▾ |     |
| <input checked="" type="checkbox"/> | 1/0/1  | Enable                 | Disable                | --- |
| <input checked="" type="checkbox"/> | 1/0/2  | Enable                 | Disable                | --- |
| <input checked="" type="checkbox"/> | 1/0/3  | Enable                 | Disable                | --- |
| <input checked="" type="checkbox"/> | 1/0/4  | Enable                 | Disable                | --- |
| <input type="checkbox"/>            | 1/0/5  | Disable                | Disable                | --- |
| <input type="checkbox"/>            | 1/0/6  | Disable                | Disable                | --- |
| <input type="checkbox"/>            | 1/0/7  | Disable                | Disable                | --- |
| <input type="checkbox"/>            | 1/0/8  | Disable                | Disable                | --- |
| <input type="checkbox"/>            | 1/0/9  | Disable                | Disable                | --- |
| <input type="checkbox"/>            | 1/0/10 | Disable                | Disable                | --- |
| <input type="checkbox"/>            | 1/0/11 | Disable                | Disable                | --- |
| <input type="checkbox"/>            | 1/0/12 | Disable                | Disable                | --- |
| <input type="checkbox"/>            | 1/0/13 | Disable                | Disable                | --- |
| <input type="checkbox"/>            | 1/0/14 | Disable                | Disable                | --- |
| <input type="checkbox"/>            | 1/0/15 | Disable                | Disable                | --- |

- 3) Choose the menu **VLAN > 802.1Q VLAN > VLAN Config** to load the following page. Create VLAN 10 and add Untagged port 1/0/1-3 and Tagged port 1/0/4 to VLAN 10.

Figure 5-4 Configure Link Type

**VLAN Info**

VLAN ID:  (2 - 4094)

Name:  (16 characters maximum)

**Untagged port**

UNIT:  LAGS

|   |   |   |   |    |    |    |    |
|---|---|---|---|----|----|----|----|
| 2 | 4 | 6 | 8 | 10 | 12 | 14 | 16 |
| 1 | 3 | 5 | 7 | 9  | 11 | 13 | 15 |

**Tagged port**

UNIT:  LAGS

|   |   |   |   |    |    |    |    |
|---|---|---|---|----|----|----|----|
| 2 | 4 | 6 | 8 | 10 | 12 | 14 | 16 |
| 1 | 3 | 5 | 7 | 9  | 11 | 13 | 15 |

Unselected Port(s)

Selected Port(s)

Not Available for Selection

- 4) Choose the menu **VLAN > 802.1Q VLAN > Port Config** to load the following page. Configure the PVID of port 1/0/1-4 as 10.



Figure 5-5 Create VLAN and Add Member Ports

**VLAN Port Config**

UNIT:  LAGS

| Select                              | Port   | PVID                          | LAG | VLAN                   |
|-------------------------------------|--------|-------------------------------|-----|------------------------|
| <input type="checkbox"/>            |        | <input type="text" value=""/> |     |                        |
| <input checked="" type="checkbox"/> | 1/0/1  | 10                            | --- | <a href="#">Detail</a> |
| <input checked="" type="checkbox"/> | 1/0/2  | 10                            | --- | <a href="#">Detail</a> |
| <input checked="" type="checkbox"/> | 1/0/3  | 10                            | --- | <a href="#">Detail</a> |
| <input checked="" type="checkbox"/> | 1/0/4  | 10                            | --- | <a href="#">Detail</a> |
| <input type="checkbox"/>            | 1/0/5  | 1                             | --- | <a href="#">Detail</a> |
| <input type="checkbox"/>            | 1/0/6  | 1                             | --- | <a href="#">Detail</a> |
| <input type="checkbox"/>            | 1/0/7  | 1                             | --- | <a href="#">Detail</a> |
| <input type="checkbox"/>            | 1/0/8  | 1                             | --- | <a href="#">Detail</a> |
| <input type="checkbox"/>            | 1/0/9  | 1                             | --- | <a href="#">Detail</a> |
| <input type="checkbox"/>            | 1/0/10 | 1                             | --- | <a href="#">Detail</a> |
| <input type="checkbox"/>            | 1/0/11 | 1                             | --- | <a href="#">Detail</a> |
| <input type="checkbox"/>            | 1/0/12 | 1                             | --- | <a href="#">Detail</a> |
| <input type="checkbox"/>            | 1/0/13 | 1                             | --- | <a href="#">Detail</a> |
| <input type="checkbox"/>            | 1/0/14 | 1                             | --- | <a href="#">Detail</a> |
| <input type="checkbox"/>            | 1/0/15 | 1                             | --- | <a href="#">Detail</a> |

- 5) Choose the menu **Multicast > IGMP Snooping > VLAN Config** to load the following page. Enable IGMP Snooping in VLAN 10. Keep 0 as the Router Port Time and Member Port Time, which means the global settings will be used.

Figure 5-6 Enable IGMP Snooping in the VLAN

**VLAN Config**

VLAN ID:  (1-4094)

Router Port Time:  sec (0,60-600, recommend: 300)

Member Port Time:  sec (0,60-600, recommend: 260)

**Static Router Ports**

UNIT:  LAGS

|                          |                          |                          |                          |                          |                          |                          |                          |
|--------------------------|--------------------------|--------------------------|--------------------------|--------------------------|--------------------------|--------------------------|--------------------------|
| <input type="checkbox"/> | <input type="checkbox"/> | <input type="checkbox"/> | <input type="checkbox"/> | <input type="checkbox"/> | <input type="checkbox"/> | <input type="checkbox"/> | <input type="checkbox"/> |
| <input type="checkbox"/> | <input type="checkbox"/> | <input type="checkbox"/> | <input type="checkbox"/> | <input type="checkbox"/> | <input type="checkbox"/> | <input type="checkbox"/> | <input type="checkbox"/> |

**Forbidden Router Ports**

UNIT:  LAGS

|                          |                          |                          |                          |                          |                          |                          |                          |
|--------------------------|--------------------------|--------------------------|--------------------------|--------------------------|--------------------------|--------------------------|--------------------------|
| <input type="checkbox"/> | <input type="checkbox"/> | <input type="checkbox"/> | <input type="checkbox"/> | <input type="checkbox"/> | <input type="checkbox"/> | <input type="checkbox"/> | <input type="checkbox"/> |
| <input type="checkbox"/> | <input type="checkbox"/> | <input type="checkbox"/> | <input type="checkbox"/> | <input type="checkbox"/> | <input type="checkbox"/> | <input type="checkbox"/> | <input type="checkbox"/> |

Unselected Port(s)    Selected Port(s)    Not Available for Selection

**Vlan Table**

| Select                 | VLAN ID | Router Port Time | Member Port Time | Static Router Ports | Dynamic Router Ports | Forbidden Router Ports | Operation |
|------------------------|---------|------------------|------------------|---------------------|----------------------|------------------------|-----------|
| No entry in the table. |         |                  |                  |                     |                      |                        |           |

- Click **Save Config** to save the settings.

### 5.1.4 Using the CLI

- Enable IGMP Snooping globally.

```
Switch#configure
```

```
Switch(config)#ip igmp snooping
```

- Enable IGMP Snooping on port 1/0/1-4.

```
Switch(config)#interface range ten-gigabitEthernet 1/0/1-4
```

```
Switch(config-if-range)#ip igmp snooping
```

```
Switch(config-if-range)#exit
```

- Create VLAN 10.

```
Switch(config)#vlan 10
```

```
Switch(config-vlan)#name vlan10
```

```
Switch(config-vlan)#exit
```

- Add port 1/0/1-3 to VLAN 10 and set the link type as untagged. Add port 1/0/4 to VLAN 10 and set the link type as tagged.

```
Switch(config)#interface range ten-gigabitEthernet 1/0/1-3
```

```
Switch(config-if-range)#switchport general allowed vlan 10 untagged
```

```
Switch(config-if-range)#exit
Switch(config)#interface ten-gigabitEthernet 1/0/4
Switch(config-if)#switchport general allowed vlan 10 tagged
Switch(config-if)#exit
```

- 5) Set the PVID of port 1/0/1-4 as 10.

```
Switch(config)#interface range ten-gigabitEthernet 1/0/1-4
Switch(config-if-range)#switchport pvid 10
Switch(config-if-range)#exit
```

- 6) Enable IGMP Snooping in VLAN 10.

```
Switch(config)#ip igmp snooping vlan-config 10
```

- 7) Save the settings.

```
Switch(config)#end
Switch#copy running-config startup-config
```

## Verify the Configurations

Show members in the VLAN:

```
Switch(config)#show vlan brief
```

| VLAN | Name        | Status | Ports                                                                             |
|------|-------------|--------|-----------------------------------------------------------------------------------|
| 1    | System-VLAN | active | Te1/0/1, Te1/0/2, Te1/0/3, Te1/0/4,<br>Te1/0/5, Te1/0/6, Te1/0/7, Te1/0/8,<br>... |
| 10   | vlan10      | active | Te1/0/1, Te1/0/2, Te1/0/3, Te1/0/4                                                |

Show status of IGMP Snooping globally, on the ports and in the VLAN:

```
Switch(config)#show ip igmp snooping
```

```
IGMP Snooping          :Enable
Unknown Multicast      :Pass
Last Query Times       :2
Last Query Interval    :1
Global Member Age Time :260
Global Router Age Time :300
```

Global Report Suppression :Disable

Global Authentication Accounting:Disable

Enable Port:Te1/0/1-4

Enable VLAN:10

## 5.2 Example for Configuring Multicast VLAN

### 5.2.1 Network Requirements

Host B, Host C and Host D are in three different VLANs of the switch. All of them want to receive multicast data sent to multicast group 225.1.1.1.

### 5.2.2 Configuration Scheme

Create a multicast VLAN and add the router port and ports connected to multicast members to the multicast VLAN. In this case, all multicast data will only be processed in the multicast VLAN.

### 5.2.3 Network Topology

As shown in the following network topology, Host B, Host C and Host D are connected to port 1/0/1, port 1/0/2 and port 1/0/3 respectively. Port 1/0/1, port 1/0/2 and port 1/0/3 belong to VLAN 10, VLAN 20 and VLAN 30 respectively. Port 1/0/4 is connected to the multicast network in the upper layer network. These 4 ports are all Untagged ports.

Figure 5-7 Network Topology for Multicast VLAN

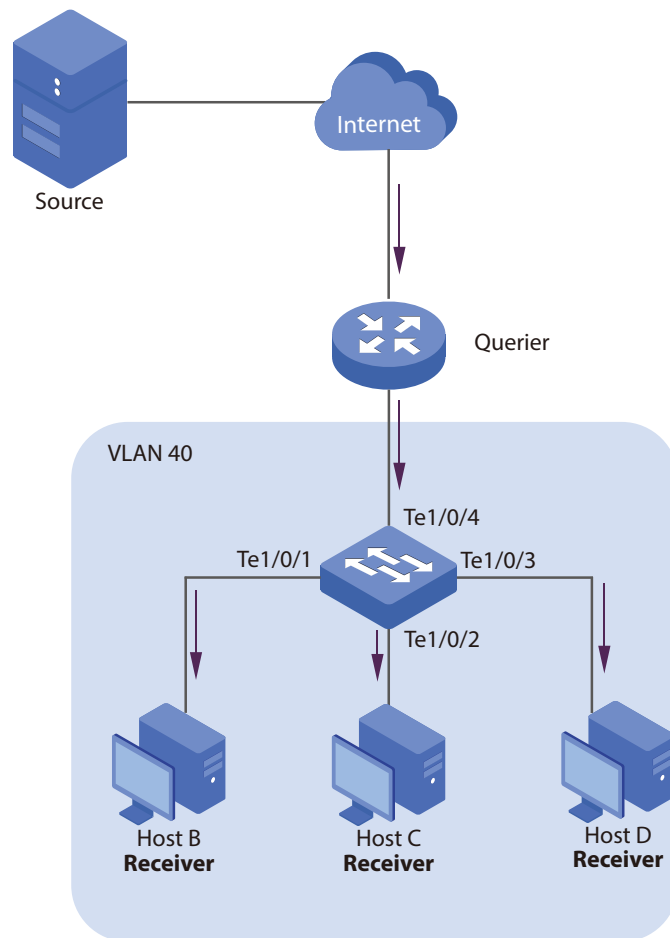

Demonstrated with T1700X-16TS, this section provides configuration procedures in two ways: using the GUI and using the CLI.

## 5.2.4 Using the GUI

- 1) Choose the menu **Multicast > IGMP Snooping > Snooping Config** to load the following page. Enable IGMP Snooping globally, and keep the default values in the Router Port Time and Member Port Time fields.

Figure 5-8 Configure IGMP Snooping Globally

**Global Config**

IGMP Snooping  Enable  Disable

Unknown Multicast  Forward  Discard

Report Message Suppression  Enable  Disable

Router Port Time  sec (60-600)

Member Port Time  sec (60-600)

Last Listener Query Interval:  secs(1-5)

Last Listener Query Count:  (1-5)

---

**IGMP Snooping Status**

| Description  | Member |
|--------------|--------|
| Enable ports |        |
| Enable VLAN  |        |

- 2) Choose the menu **Multicast > IGMP Snooping > Snooping Config** to load the following page. Enable IGMP Snooping on port 1/0/1-4.

Figure 5-9 Configure IGMP Snooping Globally

**Port Config**

UNIT:  LAGS

| Select                              | Port   | IGMP Snooping                   | Fast Leave                      | LAG |
|-------------------------------------|--------|---------------------------------|---------------------------------|-----|
| <input type="checkbox"/>            |        | <input type="text" value=""/> ▾ | <input type="text" value=""/> ▾ |     |
| <input checked="" type="checkbox"/> | 1/0/1  | Enable                          | Disable                         | --- |
| <input checked="" type="checkbox"/> | 1/0/2  | Enable                          | Disable                         | --- |
| <input checked="" type="checkbox"/> | 1/0/3  | Enable                          | Disable                         | --- |
| <input checked="" type="checkbox"/> | 1/0/4  | Enable                          | Disable                         | --- |
| <input type="checkbox"/>            | 1/0/5  | Disable                         | Disable                         | --- |
| <input type="checkbox"/>            | 1/0/6  | Disable                         | Disable                         | --- |
| <input type="checkbox"/>            | 1/0/7  | Disable                         | Disable                         | --- |
| <input type="checkbox"/>            | 1/0/8  | Disable                         | Disable                         | --- |
| <input type="checkbox"/>            | 1/0/9  | Disable                         | Disable                         | --- |
| <input type="checkbox"/>            | 1/0/10 | Disable                         | Disable                         | --- |
| <input type="checkbox"/>            | 1/0/11 | Disable                         | Disable                         | --- |
| <input type="checkbox"/>            | 1/0/12 | Disable                         | Disable                         | --- |
| <input type="checkbox"/>            | 1/0/13 | Disable                         | Disable                         | --- |
| <input type="checkbox"/>            | 1/0/14 | Disable                         | Disable                         | --- |
| <input type="checkbox"/>            | 1/0/15 | Disable                         | Disable                         | --- |

- Choose the menu **VLAN > 802.1Q VLAN > VLAN Config** to load the following page. Create VLAN 40 and add Untagged port 1/0/1-4 to VLAN 40.

Figure 5-10 Configure Link Type

**VLAN Info**

VLAN ID:  (2 - 4094)

Name :  (16 characters maximum)

**Untagged port**

UNIT:  LAGS

|                                       |                                       |                            |                            |                             |                             |                             |                             |
|---------------------------------------|---------------------------------------|----------------------------|----------------------------|-----------------------------|-----------------------------|-----------------------------|-----------------------------|
| <input checked="" type="checkbox"/> 2 | <input checked="" type="checkbox"/> 4 | <input type="checkbox"/> 6 | <input type="checkbox"/> 8 | <input type="checkbox"/> 10 | <input type="checkbox"/> 12 | <input type="checkbox"/> 14 | <input type="checkbox"/> 16 |
| <input checked="" type="checkbox"/> 1 | <input checked="" type="checkbox"/> 3 | <input type="checkbox"/> 5 | <input type="checkbox"/> 7 | <input type="checkbox"/> 9  | <input type="checkbox"/> 11 | <input type="checkbox"/> 13 | <input type="checkbox"/> 15 |

**Tagged port**

UNIT:  LAGS

|                            |                            |                            |                            |                             |                             |                             |                             |
|----------------------------|----------------------------|----------------------------|----------------------------|-----------------------------|-----------------------------|-----------------------------|-----------------------------|
| <input type="checkbox"/> 2 | <input type="checkbox"/> 4 | <input type="checkbox"/> 6 | <input type="checkbox"/> 8 | <input type="checkbox"/> 10 | <input type="checkbox"/> 12 | <input type="checkbox"/> 14 | <input type="checkbox"/> 16 |
| <input type="checkbox"/> 1 | <input type="checkbox"/> 3 | <input type="checkbox"/> 5 | <input type="checkbox"/> 7 | <input type="checkbox"/> 9  | <input type="checkbox"/> 11 | <input type="checkbox"/> 13 | <input type="checkbox"/> 15 |

Unselected Port(s)
 Selected Port(s)
 Not Available for Selection

- Choose the menu **VLAN > 802.1Q VLAN > Port Config** to load the following page. Configure the PVID of port 1/0/1 as 10, port 1/0/2 as 20, port 1/0/3 as 30 and port 1/0/4 as 40.

Figure 5-11 Create VLAN and Add Member Ports

| VLAN Port Config         |        |                      |     |                        |
|--------------------------|--------|----------------------|-----|------------------------|
| UNIT: 1 LAGS             |        |                      |     |                        |
| Select                   | Port   | PVID                 | LAG | VLAN                   |
| <input type="checkbox"/> |        | <input type="text"/> |     |                        |
| <input type="checkbox"/> | 1/0/1  | 10                   | --- | <a href="#">Detail</a> |
| <input type="checkbox"/> | 1/0/2  | 20                   | --- | <a href="#">Detail</a> |
| <input type="checkbox"/> | 1/0/3  | 30                   | --- | <a href="#">Detail</a> |
| <input type="checkbox"/> | 1/0/4  | 40                   | --- | <a href="#">Detail</a> |
| <input type="checkbox"/> | 1/0/5  | 1                    | --- | <a href="#">Detail</a> |
| <input type="checkbox"/> | 1/0/6  | 1                    | --- | <a href="#">Detail</a> |
| <input type="checkbox"/> | 1/0/7  | 1                    | --- | <a href="#">Detail</a> |
| <input type="checkbox"/> | 1/0/8  | 1                    | --- | <a href="#">Detail</a> |
| <input type="checkbox"/> | 1/0/9  | 1                    | --- | <a href="#">Detail</a> |
| <input type="checkbox"/> | 1/0/10 | 1                    | --- | <a href="#">Detail</a> |
| <input type="checkbox"/> | 1/0/11 | 1                    | --- | <a href="#">Detail</a> |
| <input type="checkbox"/> | 1/0/12 | 1                    | --- | <a href="#">Detail</a> |
| <input type="checkbox"/> | 1/0/13 | 1                    | --- | <a href="#">Detail</a> |
| <input type="checkbox"/> | 1/0/14 | 1                    | --- | <a href="#">Detail</a> |
| <input type="checkbox"/> | 1/0/15 | 1                    | --- | <a href="#">Detail</a> |

- Choose the menu **Multicast > IGMP Snooping > Multicast VLAN** to load the following page. Enable Multicast VLAN and configure VLAN 40 as the multicast VLAN. Keep Router Port Time and Member Port Time as 0.

Figure 5-12 Create Multicast VLAN

| Multicast VLAN     |                                                                       |
|--------------------|-----------------------------------------------------------------------|
| Multicast VLAN:    | <input checked="" type="radio"/> Enable <input type="radio"/> Disable |
| VLAN ID:           | <input type="text" value="40"/> × (2-4094)                            |
| Router Port Time:  | <input type="text" value="0"/> sec (0,60-600, recommend: 300)         |
| Member Port Time:  | <input type="text" value="0"/> sec (0,60-600, recommend: 260)         |
| Replace Source IP: | <input type="text" value="0.0.0.0"/> (format:192.168.0.1)             |

- Click **Save Config** to save the settings.

### 5.2.5 Using the CLI

- Enable IGMP Snooping Globally.  

```
Switch#configure
Switch(config)#ip igmp snooping
```
- Enable IGMP Snooping on port 1/0/1-4.



```
Switch(config)#interface range ten-gigabitEthernet 1/0/1-4
```

```
Switch(config-if-range)#ip igmp snooping
```

```
Switch(config-if-range)#exit
```

- 3) Create VLAN 10.

```
Switch(config)#vlan 10
```

```
Switch(config-vlan)#name vlan10
```

```
Switch(config-vlan)#exit
```

- 4) Add port 1/0/1-3 to VLAN 10 and set the link type as untagged. Add port 1/0/4 to VLAN 10 and set the link type as tagged.

```
Switch(config)#interface range ten-gigabitEthernet 1/0/1-3
```

```
Switch(config-if-range)#switchport general allowed vlan 10 untagged
```

```
Switch(config-if-range)#exit
```

```
Switch(config)#interface ten-gigabitEthernet 1/0/4
```

```
Switch(config-if)#switchport general allowed vlan 10 tagged
```

```
Switch(config-if)#exit
```

- 5) Set the PVID of port 1/0/1-4 as 10.

```
Switch(config)#interface range ten-gigabitEthernet 1/0/1-4
```

```
Switch(config-if-range)#switchport pvid 10
```

```
Switch(config-if-range)#exit
```

- 6) Enable Multicast VLAN and configure VLAN 10 as the multicast VLAN.

```
Switch(config)#ip igmp snooping multi-vlan-config 10
```

- 7) Save the settings.

```
Switch(config)#end
```

```
Switch#copy running-config startup-config
```

## Verify the Configurations

```
Switch(config)#show vlan brief
```

| VLAN | Name        | Status | Ports                                                                               |
|------|-------------|--------|-------------------------------------------------------------------------------------|
| 1    | System-VLAN | active | Te1/0/1, Te1/0/2, Te1/0/3, Te1/0/4,<br>Te1/0/5, Te1/0/6, Te1/0/7, Te1/0/8,<br>..... |

```
10      vlan10      active      Te1/0/1, Te1/0/2, Te1/0/3, Te1/0/4
```

Show status of IGMP Snooping globally, on the ports and in the multicast VLAN:

```
Switch(config)#show ip igmp snooping
```

```
IGMP Snooping      :Enable
```

```
Unknown Multicast  :Pass
```

```
Last Query Times    :2
```

```
Last Query Interval :1
```

```
Global Member Age Time :260
```

```
Global Router Age Time :300
```

```
Global Report Suppression :Disable
```

```
Global Authentication Accounting:Disable
```

```
Enable Port:Te1/0/1-4
```

```
Enable VLAN:Multicast VLAN 10
```

## 5.3 Example for Configuring Unknown Multicast and Fast Leave

### 5.3.1 Network Requirement

A user experiences lag when he is changing channel on his IPTV. He wants solutions to this problem. As shown in the following network topology, port 1/0/4 on the switch is connected to the upper layer network, and port 1/0/2 is connected to Host B.

Figure 5-13 Network Topology for Unknow Multicast and Fast Leave

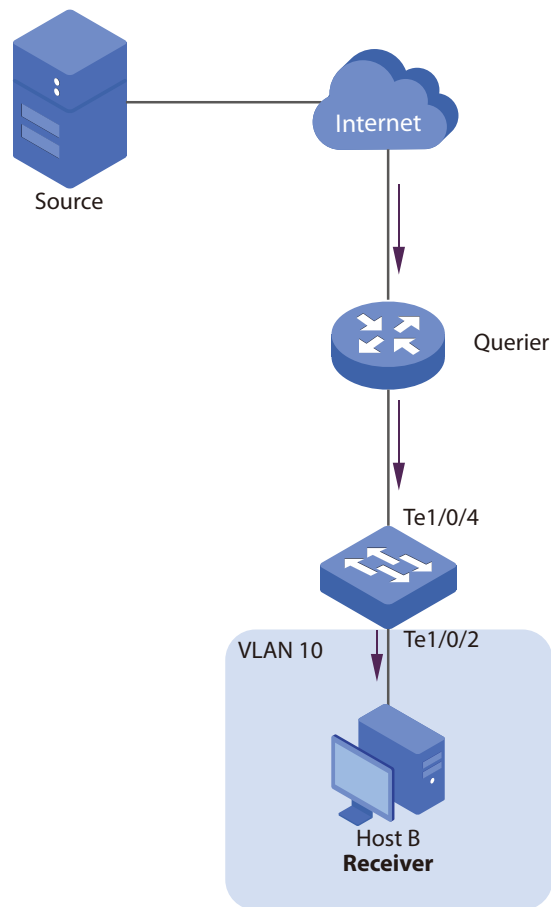

### 5.3.2 Configuration Scheme

After the channel is changed, the client (Host B) still receives irrelevant multicast data, the data from the previous channel and possibly other unknown multicast data, which increases the network load and results in network congestion. The solution to this problem is using Unknown Multicast and Fast Leave.

To avoid Host B from receiving irrelevant multicast data, the user can enable Fast Leave on port 1/0/2 and enable Unknown Multicast globally. To change channel, Host B sends a leave message about leaving the previous channel. The switch will then drop multicast data from the previous channel and all unknown multicast data, which ensures that Host B only receives multicast data from the new channel and that the multicast network is unimpeded.

Demonstrated with T1700X-16TS, this section provides configuration procedures in two ways: using the GUI and using the CLI.

### 5.3.3 Using the GUI

- 1) Choose the menu **Multicast > IGMP Snooping > Snooping Config** to load the following page. Enable IGMP Snooping globally and configure Unknown Multicast as Discard.

Figure 5-14 Configure IGMP Snooping Globally

**Global Config**

IGMP Snooping  Enable  Disable

Unknown Multicast  Forward  Discard

Report Message Suppression  Enable  Disable

Router Port Time  sec (60-600)

Member Port Time  sec (60-600)

Last Listener Query Interval:  secs(1-5)

Last Listener Query Count:  (1-5)

---

**IGMP Snooping Status**

| Description  | Member  |
|--------------|---------|
| Enable ports | 1/0/1-4 |
| Enable VLAN  |         |

**Note:**

IGMP Snooping and MLD Snooping share the setting of Unknown Multicast, so you have to enable MLD Snooping globally on the **Multicast > MLD Snooping > Snooping Config** page at the same time.

- 2) Choose the menu **Multicast > IGMP Snooping > Port Config** to load the following page. Enable IGMP Snooping on port 1/0/2 and port 1/0/4 and enable Fast Leave on port 1/0/2.

Figure 5-15 Configure IGMP Snooping Globally

**Port Config**

UNIT: 1 LAGS

| Select                   | Port   | IGMP Snooping                   | Fast Leave                      | LAG |
|--------------------------|--------|---------------------------------|---------------------------------|-----|
| <input type="checkbox"/> |        | <input type="text" value=""/> ▾ | <input type="text" value=""/> ▾ |     |
| <input type="checkbox"/> | 1/0/1  | Disable                         | Disable                         | --- |
| <input type="checkbox"/> | 1/0/2  | Enable                          | Enable                          | --- |
| <input type="checkbox"/> | 1/0/3  | Disable                         | Disable                         | --- |
| <input type="checkbox"/> | 1/0/4  | Enable                          | Disable                         | --- |
| <input type="checkbox"/> | 1/0/5  | Disable                         | Disable                         | --- |
| <input type="checkbox"/> | 1/0/6  | Disable                         | Disable                         | --- |
| <input type="checkbox"/> | 1/0/7  | Disable                         | Disable                         | --- |
| <input type="checkbox"/> | 1/0/8  | Disable                         | Disable                         | --- |
| <input type="checkbox"/> | 1/0/9  | Disable                         | Disable                         | --- |
| <input type="checkbox"/> | 1/0/10 | Disable                         | Disable                         | --- |
| <input type="checkbox"/> | 1/0/11 | Disable                         | Disable                         | --- |
| <input type="checkbox"/> | 1/0/12 | Disable                         | Disable                         | --- |
| <input type="checkbox"/> | 1/0/13 | Disable                         | Disable                         | --- |
| <input type="checkbox"/> | 1/0/14 | Disable                         | Disable                         | --- |
| <input type="checkbox"/> | 1/0/15 | Disable                         | Disable                         | --- |

- Choose the menu **Multicast > IGMP Snooping > VLAN Config** to load the following page. Enable IGMP Snooping in VLAN 10.

Figure 5-16 Enable IGMP Snooping in the VLAN

**VLAN Config**

VLAN ID:  (1-4094)

Router Port Time:  sec (0,60-600, recommend: 300)

Member Port Time:  sec (0,60-600, recommend: 260)

**Static Router Ports**

UNIT: 1 LAGS

|                            |                            |                            |                            |                             |                             |                             |                             |
|----------------------------|----------------------------|----------------------------|----------------------------|-----------------------------|-----------------------------|-----------------------------|-----------------------------|
| <input type="checkbox"/> 2 | <input type="checkbox"/> 4 | <input type="checkbox"/> 6 | <input type="checkbox"/> 8 | <input type="checkbox"/> 10 | <input type="checkbox"/> 12 | <input type="checkbox"/> 14 | <input type="checkbox"/> 16 |
| <input type="checkbox"/> 1 | <input type="checkbox"/> 3 | <input type="checkbox"/> 5 | <input type="checkbox"/> 7 | <input type="checkbox"/> 9  | <input type="checkbox"/> 11 | <input type="checkbox"/> 13 | <input type="checkbox"/> 15 |

**Forbidden Router Ports**

UNIT: 1 LAGS

|                            |                            |                            |                            |                             |                             |                             |                             |
|----------------------------|----------------------------|----------------------------|----------------------------|-----------------------------|-----------------------------|-----------------------------|-----------------------------|
| <input type="checkbox"/> 2 | <input type="checkbox"/> 4 | <input type="checkbox"/> 6 | <input type="checkbox"/> 8 | <input type="checkbox"/> 10 | <input type="checkbox"/> 12 | <input type="checkbox"/> 14 | <input type="checkbox"/> 16 |
| <input type="checkbox"/> 1 | <input type="checkbox"/> 3 | <input type="checkbox"/> 5 | <input type="checkbox"/> 7 | <input type="checkbox"/> 9  | <input type="checkbox"/> 11 | <input type="checkbox"/> 13 | <input type="checkbox"/> 15 |

Unselected Port(s)
  Selected Port(s)
  Not Available for Selection

**Vlan Table**

| Select                 | VLAN ID | Router Port Time | Member Port Time | Static Router Ports | Dynamic Router Ports | Forbidden Router Ports | Operation |
|------------------------|---------|------------------|------------------|---------------------|----------------------|------------------------|-----------|
| No entry in the table. |         |                  |                  |                     |                      |                        |           |

- 4) Click **Save Config** to save the settings.

### 5.3.4 Using the CLI

- 1) Enable IGMP Snooping Globally.

```
Switch#configure
```

```
Switch(config)#ip igmp snooping
```

- 2) Configure Unknown Multicast as Discard globally.

```
Switch(config)#ip igmp snooping drop unknown
```

- 3) Enable IGMP Snooping on port 1/0/2 and enable Fast Leave. On port 1/0/4, enable IGMP Snooping.

```
Switch(config)#interface ten-gigabitEthernet 1/0/2
```

```
Switch(config-if)#ip igmp snooping
```

```
Switch(config-if)#ip igmp snooping immediate-leave
```

```
Switch(config-if)#exit
```

```
Switch(config)#interface ten-gigabitEthernet 1/0/4
```

```
Switch(config-if)#ip igmp snooping
```

```
Switch(config-if)#exit
```

- 4) Enable IGMP Snooping in VLAN 10.

```
Switch(config)#ip igmp snooping vlan-config 10
```

- 5) Save the settings.

```
Switch(config)#end
```

```
Switch#copy running-config startup-config
```

### Verify the Configurations

Show global settings of IGMP Snooping:

```
Switch(config)#show ip igmp snooping
```

```
IGMP Snooping          :Enable
```

```
Unknown Multicast      :Discard
```

```
Last Query Times       :2
```

```
Last Query Interval    :1
```

```
Global Member Age Time :260
```

```
Global Router Age Time :300
```

```

Global Report Suppression    :Disable
Global Authentication Accounting:Disable
Enable Port:Te1/0/2,1/0/4
Enable VLAN:10
Show settings of IGMP Snooping on port 1/0/2:
Switch(config)#show ip igmp snooping interface ten-gigabitEthernet 1/0/2 basic-config
Port    IGMP-Snooping Fast-Leave
-----
Te1/0/2  enable      enable

```

## 5.4 Example for Configuring Multicast Filtering

### 5.4.1 Network Requirements

Host B, Host C and Host D are in the same subnet. Host C and Host D only receive multicast data sent to 225.0.0.1, while Host B receives all multicast data except the one sent from 225.0.0.2.

### 5.4.2 Configuration Scheme

With the functions for managing multicast groups, whitelist and blacklist mechanism (profile binding), the switch can only allow specific member ports to join specific multicast groups or disallow specific member ports to join specific multicast groups. You can achieve this filtering function by creating a profile and binding it to the corresponding member port.

### 5.4.3 Network Topology

As shown in the following network topology, Host B is connected to port 1/0/1, Host C is connected to port 1/0/2 and Host D is connected to port 1/0/3. They are all in VLAN 10.

Figure 5-17 Network Topology for Multicast Filtering

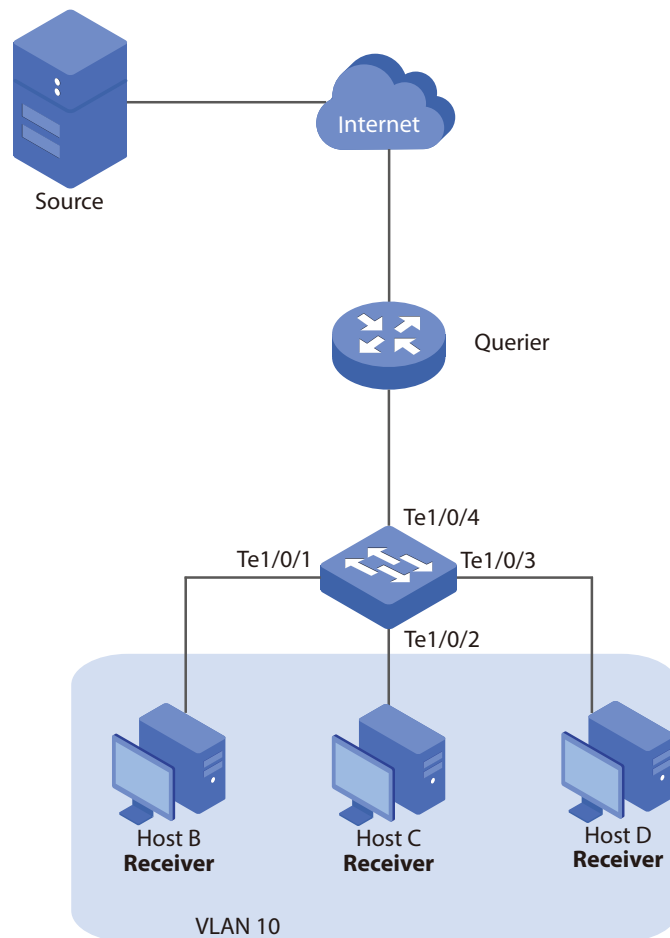

Demonstrated with T1700X-16TS, this section provides configuration procedures in two ways: using the GUI and using the CLI.

#### 5.4.4 Using the GUI

- 1) Choose the menu **Multicast > IGMP Snooping > Snooping Config** to load the following page. Enable IGMP Snooping globally, and keep the default values in the Router Port Time and Member Port Time fields.



Figure 5-18 Configure IGMP Snooping Globally

**Global Config**

IGMP Snooping  Enable  Disable

Unknown Multicast  Forward  Discard

Report Message Suppression  Enable  Disable

Router Port Time  sec (60-600)

Member Port Time  sec (60-600)

Last Listener Query Interval:  secs(1-5)

Last Listener Query Count:  (1-5)

---

**IGMP Snooping Status**

| Description  | Member |
|--------------|--------|
| Enable ports |        |
| Enable VLAN  |        |

- 2) Choose the menu **Multicast > IGMP Snooping > Snooping Config** to load the following page.

Figure 5-19 Enable IGMP Snooping on the Port

**Port Config**

UNIT:  LAGS

| Select                              | Port   | IGMP Snooping                   | Fast Leave                      | LAG |
|-------------------------------------|--------|---------------------------------|---------------------------------|-----|
| <input type="checkbox"/>            |        | <input type="text" value=""/> ▾ | <input type="text" value=""/> ▾ |     |
| <input checked="" type="checkbox"/> | 1/0/1  | Enable                          | Disable                         | --- |
| <input checked="" type="checkbox"/> | 1/0/2  | Enable                          | Disable                         | --- |
| <input checked="" type="checkbox"/> | 1/0/3  | Enable                          | Disable                         | --- |
| <input checked="" type="checkbox"/> | 1/0/4  | Enable                          | Disable                         | --- |
| <input type="checkbox"/>            | 1/0/5  | Disable                         | Disable                         | --- |
| <input type="checkbox"/>            | 1/0/6  | Disable                         | Disable                         | --- |
| <input type="checkbox"/>            | 1/0/7  | Disable                         | Disable                         | --- |
| <input type="checkbox"/>            | 1/0/8  | Disable                         | Disable                         | --- |
| <input type="checkbox"/>            | 1/0/9  | Disable                         | Disable                         | --- |
| <input type="checkbox"/>            | 1/0/10 | Disable                         | Disable                         | --- |
| <input type="checkbox"/>            | 1/0/11 | Disable                         | Disable                         | --- |
| <input type="checkbox"/>            | 1/0/12 | Disable                         | Disable                         | --- |
| <input type="checkbox"/>            | 1/0/13 | Disable                         | Disable                         | --- |
| <input type="checkbox"/>            | 1/0/14 | Disable                         | Disable                         | --- |
| <input type="checkbox"/>            | 1/0/15 | Disable                         | Disable                         | --- |

- 3) Choose the menu **VLAN > 802.1Q VLAN > VLAN Config** to load the following page. Create VLAN 10 and add Untagged port 1/0/1-3 and Tagged port 1/0/4 to VLAN 10.

Figure 5-20 Configure Link Type

**VLAN Info**

VLAN ID:  (2 - 4094)

Name :  (16 characters maximum)

**Untagged port**

UNIT:  LAGS

|   |   |   |   |    |    |    |    |
|---|---|---|---|----|----|----|----|
| 2 | 4 | 6 | 8 | 10 | 12 | 14 | 16 |
| 1 | 3 | 5 | 7 | 9  | 11 | 13 | 15 |

**Tagged port**

UNIT:  LAGS

|   |   |   |   |    |    |    |    |
|---|---|---|---|----|----|----|----|
| 2 | 4 | 6 | 8 | 10 | 12 | 14 | 16 |
| 1 | 3 | 5 | 7 | 9  | 11 | 13 | 15 |

Unselected Port(s)
  Selected Port(s)
  Not Available for Selection

- 4) Choose the menu **VLAN > 802.1Q VLAN > Port Config** to load the following page. Configure the PVID of port 1/0/1-4 as 10.

Figure 5-21 Create VLAN and Add Member Ports

**VLAN Port Config**

UNIT: **1** LAGS

| Select                              | Port   | PVID                          | LAG | VLAN                   |
|-------------------------------------|--------|-------------------------------|-----|------------------------|
| <input type="checkbox"/>            |        | <input type="text" value=""/> |     |                        |
| <input checked="" type="checkbox"/> | 1/0/1  | 10                            | --- | <a href="#">Detail</a> |
| <input checked="" type="checkbox"/> | 1/0/2  | 10                            | --- | <a href="#">Detail</a> |
| <input checked="" type="checkbox"/> | 1/0/3  | 10                            | --- | <a href="#">Detail</a> |
| <input checked="" type="checkbox"/> | 1/0/4  | 10                            | --- | <a href="#">Detail</a> |
| <input type="checkbox"/>            | 1/0/5  | 1                             | --- | <a href="#">Detail</a> |
| <input type="checkbox"/>            | 1/0/6  | 1                             | --- | <a href="#">Detail</a> |
| <input type="checkbox"/>            | 1/0/7  | 1                             | --- | <a href="#">Detail</a> |
| <input type="checkbox"/>            | 1/0/8  | 1                             | --- | <a href="#">Detail</a> |
| <input type="checkbox"/>            | 1/0/9  | 1                             | --- | <a href="#">Detail</a> |
| <input type="checkbox"/>            | 1/0/10 | 1                             | --- | <a href="#">Detail</a> |
| <input type="checkbox"/>            | 1/0/11 | 1                             | --- | <a href="#">Detail</a> |
| <input type="checkbox"/>            | 1/0/12 | 1                             | --- | <a href="#">Detail</a> |
| <input type="checkbox"/>            | 1/0/13 | 1                             | --- | <a href="#">Detail</a> |
| <input type="checkbox"/>            | 1/0/14 | 1                             | --- | <a href="#">Detail</a> |
| <input type="checkbox"/>            | 1/0/15 | 1                             | --- | <a href="#">Detail</a> |

- 5) Choose the menu **Multicast > IGMP Snooping > VLAN Config** to load the following page. Enable IGMP Snooping in VLAN 10. Keep 0 as the Router Port Time and Member Port Time, which means the global settings will be used.

Figure 5-22 Enable IGMP Snooping in the VLAN

**VLAN Config**

VLAN ID:  (1-4094)

Router Port Time:  sec (0,60-600, recommend: 300)

Member Port Time:  sec (0,60-600, recommend: 260)

---

**Static Router Ports**

UNIT:  LAGS

|   |   |   |   |    |    |    |    |
|---|---|---|---|----|----|----|----|
| 2 | 4 | 6 | 8 | 10 | 12 | 14 | 16 |
| 1 | 3 | 5 | 7 | 9  | 11 | 13 | 15 |

---

**Forbidden Router Ports**

UNIT:  LAGS

|   |   |   |   |    |    |    |    |
|---|---|---|---|----|----|----|----|
| 2 | 4 | 6 | 8 | 10 | 12 | 14 | 16 |
| 1 | 3 | 5 | 7 | 9  | 11 | 13 | 15 |

Unselected Port(s)  
  Selected Port(s)  
  Not Available for Selection

---

**Vlan Table**

| Select                 | VLAN ID | Router Port Time | Member Port Time | Static Router Ports | Dynamic Router Ports | Forbidden Router Ports | Operation |
|------------------------|---------|------------------|------------------|---------------------|----------------------|------------------------|-----------|
| No entry in the table. |         |                  |                  |                     |                      |                        |           |

- 6) Specify the multicast data that Host C and Host D can receive.
  - a. Choose the menu **Multicast > IGMP Snooping > Profile Config** to load the following page. Create Profile 1, select Permit as the Mode and click Create.

Figure 5-23 Create Profile 1

**Profile Creation**

Profile ID:  (1-999)

Mode:  Permit  Deny

- b. Choose the menu **Multicast > IGMP Snooping > Profile Config** to load the following page.

Figure 5-24 Edit Add IP-range in Profile 1

**Profile mode**

Profile ID:

Mode:

---

**Add IP-range**

Start IP:  (Format:225.0.0.1)

End IP:  (Format:225.0.0.1)

---

**IP-range Table**

| Select                 | Index | Start IP | End IP |
|------------------------|-------|----------|--------|
| No entry in the table. |       |          |        |

- c. Choose the menu **Multicast > IGMP Snooping > Profile Binding** to load the following page. Select port 1/0/2 and port 1/0/3, enter 1 in the Profile ID field and click Apply to bind Profile 1 to these ports.

Figure 5-25 Bind Profile 1 to Port 1/0/2 and Port 1/0/3

**Profile and Max Group Binding**

UNIT:  LAGS

| Select                              | Port   | Profile ID                     | Max Group            | Overflow Action      | LAG |                              |
|-------------------------------------|--------|--------------------------------|----------------------|----------------------|-----|------------------------------|
| <input type="checkbox"/>            |        | <input type="text" value="1"/> | <input type="text"/> | <input type="text"/> |     |                              |
| <input type="checkbox"/>            | 1/0/1  |                                | 1000                 | Drop                 | --  | <a href="#">ClearBinding</a> |
| <input checked="" type="checkbox"/> | 1/0/2  |                                | 1000                 | Drop                 | --  | <a href="#">ClearBinding</a> |
| <input checked="" type="checkbox"/> | 1/0/3  |                                | 1000                 | Drop                 | --  | <a href="#">ClearBinding</a> |
| <input type="checkbox"/>            | 1/0/4  |                                | 1000                 | Drop                 | --  | <a href="#">ClearBinding</a> |
| <input type="checkbox"/>            | 1/0/5  |                                | 1000                 | Drop                 | --  | <a href="#">ClearBinding</a> |
| <input type="checkbox"/>            | 1/0/6  |                                | 1000                 | Drop                 | --  | <a href="#">ClearBinding</a> |
| <input type="checkbox"/>            | 1/0/7  |                                | 1000                 | Drop                 | --  | <a href="#">ClearBinding</a> |
| <input type="checkbox"/>            | 1/0/8  |                                | 1000                 | Drop                 | --  | <a href="#">ClearBinding</a> |
| <input type="checkbox"/>            | 1/0/9  |                                | 1000                 | Drop                 | --  | <a href="#">ClearBinding</a> |
| <input type="checkbox"/>            | 1/0/10 |                                | 1000                 | Drop                 | --  | <a href="#">ClearBinding</a> |
| <input type="checkbox"/>            | 1/0/11 |                                | 1000                 | Drop                 | --  | <a href="#">ClearBinding</a> |
| <input type="checkbox"/>            | 1/0/12 |                                | 1000                 | Drop                 | --  | <a href="#">ClearBinding</a> |
| <input type="checkbox"/>            | 1/0/13 |                                | 1000                 | Drop                 | --  | <a href="#">ClearBinding</a> |
| <input type="checkbox"/>            | 1/0/14 |                                | 1000                 | Drop                 | --  | <a href="#">ClearBinding</a> |
| <input type="checkbox"/>            | 1/0/15 |                                | 1000                 | Drop                 | --  | <a href="#">ClearBinding</a> |

- 7) Specify the multicast data that Host B can receive
  - a. Choose the menu **Multicast > IGMP Snooping > Profile Config** to load the following page. Create Profile 2, select Deny as the Mode and click Create.

Figure 5-26 Profile 2

**Profile Creation**

Profile ID:  (1-999) **Create**

Mode:  Permit  Deny

- b. Choose the menu **Multicast > IGMP Snooping > Profile Config** to load the following page. In the IGMP Profile Info table, click Edit in the Profile 2 entry, enter 225.0.0.2 in both Start IP and End IP fields, and click Add.

Figure 5-27 Edit Add IP-range in Profile 2

**Profile mode**

Profile ID:  **Submit**

Mode: Deny ▼

**Add IP-range**

Start IP: 225.0.0.2 (Format:225.0.0.1) **Add**

End IP: 225.0.0.2 (Format:225.0.0.1) **Delete**

**IP-range Table**

| Select                 | Index | Start IP | End IP |
|------------------------|-------|----------|--------|
| No entry in the table. |       |          |        |

All
Delete
Back
Help

- c. Choose the menu **Multicast > IGMP Snooping > Profile Binding** to load the following page. Select port 1/0/1, enter 2 in the Profile ID field and click Apply to bind Profile 2 to this port.

Figure 5-28 Bind Profile 2 to Port 1/0/1

| Profile and Max Group Binding       |        |            |           |                 |     |                              |
|-------------------------------------|--------|------------|-----------|-----------------|-----|------------------------------|
| UNIT: 1 LAGS                        |        |            |           |                 |     |                              |
| Select                              | Port   | Profile ID | Max Group | Overflow Action | LAG |                              |
| <input type="checkbox"/>            |        | 2          |           |                 |     |                              |
| <input checked="" type="checkbox"/> | 1/0/1  |            | 1000      | Drop            | --- | <a href="#">ClearBinding</a> |
| <input type="checkbox"/>            | 1/0/2  |            | 1000      | Drop            | --- | <a href="#">ClearBinding</a> |
| <input type="checkbox"/>            | 1/0/3  |            | 1000      | Drop            | --- | <a href="#">ClearBinding</a> |
| <input type="checkbox"/>            | 1/0/4  |            | 1000      | Drop            | --- | <a href="#">ClearBinding</a> |
| <input type="checkbox"/>            | 1/0/5  |            | 1000      | Drop            | --- | <a href="#">ClearBinding</a> |
| <input type="checkbox"/>            | 1/0/6  |            | 1000      | Drop            | --- | <a href="#">ClearBinding</a> |
| <input type="checkbox"/>            | 1/0/7  |            | 1000      | Drop            | --- | <a href="#">ClearBinding</a> |
| <input type="checkbox"/>            | 1/0/8  |            | 1000      | Drop            | --- | <a href="#">ClearBinding</a> |
| <input type="checkbox"/>            | 1/0/9  |            | 1000      | Drop            | --- | <a href="#">ClearBinding</a> |
| <input type="checkbox"/>            | 1/0/10 |            | 1000      | Drop            | --- | <a href="#">ClearBinding</a> |
| <input type="checkbox"/>            | 1/0/11 |            | 1000      | Drop            | --- | <a href="#">ClearBinding</a> |
| <input type="checkbox"/>            | 1/0/12 |            | 1000      | Drop            | --- | <a href="#">ClearBinding</a> |
| <input type="checkbox"/>            | 1/0/13 |            | 1000      | Drop            | --- | <a href="#">ClearBinding</a> |
| <input type="checkbox"/>            | 1/0/14 |            | 1000      | Drop            | --- | <a href="#">ClearBinding</a> |
| <input type="checkbox"/>            | 1/0/15 |            | 1000      | Drop            | --- | <a href="#">ClearBinding</a> |

- 8) Click **Save Config** to save the settings.

### 5.4.5 Using the CLI

- 1) Enable IGMP Snooping Globally.

```
Switch#configure
```

```
Switch(config)#ip igmp snooping
```

- 2) Enable IGMP Snooping on port 1/0/1-4.

```
Switch(config)#interface range ten-gigabitEthernet 1/0/1-4
```

```
Switch(config-if-range)#ip igmp snooping
```

```
Switch(config-if-range)#exit
```

- 3) Create VLAN 10.

```
Switch(config)#vlan 10
```

```
Switch(config-vlan)#name vlan10
```

```
Switch(config-vlan)#exit
```

- 4) Add port 1/0/1-3 to VLAN 10 and set the link type as untagged. Add port 1/0/4 to VLAN 10 and set the link type as tagged.

```
Switch(config)#interface range ten-gigabitEthernet 1/0/1-3
```

```
Switch(config-if-range)#switchport general allowed vlan 10 untagged
```

```
Switch(config-if-range)#exit
```

```
Switch(config)#interface ten-gigabitEthernet 1/0/4
```

```
Switch(config-if)#switchport general allowed vlan 10 tagged
```

```
Switch(config-if)#exit
```

- 5) Set the PVID of port 1/0/1-4 as 10.

```
Switch(config)#interface range ten-gigabitEthernet 1/0/1-4
```

```
Switch(config-if-range)#switchport pvid 10
```

```
Switch(config-if-range)#exit
```

- 6) Enable IGMP Snooping in VLAN 10.

```
Switch(config)#ip igmp snooping vlan-config 10
```

```
Switch(config-if)#exit
```

- 7) Create Profile 1, configure the mode as permit, and add an IP range with both start IP and end IP being 225.0.0.1.

```
Switch(config)#ip igmp profile 1
```

```
Switch(config-igmp-profile)#permit
```

```
Switch(config-igmp-profile)#range 225.0.0.1 225.0.0.1
```

```
Switch(config-igmp-profile)#exit
```

- 8) Bind Profile 1 to Port 1/0/2 and Port 1/10/3.

```
Switch(config)#interface range ten-gigabitEthernet 1/0/2-3
```

```
Switch(config-if-range)#ip igmp filter 1
```

```
Switch(config-if-range)#exit
```

- 9) Create Profile 2, configure the mode as deny, and add an IP range with both start IP and end IP being 225.0.0.2.

```
Switch(config)#ip igmp profile 2
```

```
Switch(config-igmp-profile)#deny
```

```
Switch(config-igmp-profile)#range 225.0.0.2 225.0.0.2
```

```
Switch(config-igmp-profile)#exit
```

- 10) Bind Profile 2 to Port 1/0/1.

```
Switch(config)#interface ten-gigabitEthernet 1/0/1
```

```
Switch(config-if)#ip igmp filter 2
```

```
Switch(config-if)#exit
```



11) Save the settings.

```
Switch(config)#end
```

```
Switch#copy running-config startup-config
```

## Verify the Configurations

Show global settings of IGMP Snooping:

```
Switch(config)#show ip igmp snooping
```

```
IGMP Snooping          :Enable
```

```
Unknown Multicast      :Pass
```

```
Last Query Times       :2
```

```
Last Query Interval    :1
```

```
Global Member Age Time :260
```

```
Global Router Age Time :300
```

```
Global Report Suppression :Disable
```

```
Global Authentication Accounting:Disable
```

```
Enable Port:Te1/0/1-4
```

```
Enable VLAN:10
```

Show all profile bindings:

```
Switch(config)#show ip igmp profile
```

```
IGMP Profile 1
```

```
  permit
```

```
  range 225.0.0.1 225.0.0.1
```

```
  Binding Port(s)
```

```
    Te1/0/2-3
```

```
IGMP Profile 2
```

```
  deny
```

```
  range 225.0.0.2 225.0.0.2
```

```
  Binding Port(s)
```

```
    Te1/0/1
```

# 6 Appendix: Default Parameters

## 6.1 Default Parameters for IGMP Snooping

Table 6-1 Default Parameters of IGMP Snooping

| Function                           | Parameter                    | Default Setting                     |
|------------------------------------|------------------------------|-------------------------------------|
| Global Settings of IGMP Snooping   | IGMP Snooping                | Disabled                            |
|                                    | Unknown Multicast            | Forward                             |
|                                    | Report Message Suppression   | Disabled                            |
|                                    | Router Port Time             | 300 seconds                         |
|                                    | Member Port Time             | 260 seconds                         |
|                                    | Last Listener Query Interval | 1 second                            |
|                                    | Last Listener Query Count    | 2                                   |
| IGMP Snooping Settings on the Port | IGMP Snooping                | Disabled                            |
|                                    | Fast Leave                   | Disabled                            |
| IGMP Snooping Settings in the VLAN | Enable or Not                | Disabled                            |
|                                    | Router Port Time             | 0, use global settings.             |
|                                    | Member Port Time             | 0, use global settings.             |
| Multicast VLAN                     | Multicast VLAN               | None                                |
|                                    | Router Port Time             | 0, use global settings.             |
|                                    | Member Port Time             | 0, use global settings.             |
|                                    | Replace Source IP            | 0.0.0.0, indicating no replacement. |
| IGMP Snooping Querier              | Enable or Not                | Disabled                            |
|                                    | Query Interval               | 60 seconds                          |
|                                    | Max Response Time            | 10 seconds                          |
|                                    | General Query Source IP      | 192.168.0.1                         |

| Function                           | Parameter                          | Default Setting |
|------------------------------------|------------------------------------|-----------------|
| IGMP Accounting and Authentication | Global Settings of IGMP Accounting | Disabled        |
|                                    | IGMP Authentication                | Disabled        |

## 6.2 Default Parameters for MLD Snooping

Table 6-2 Default Parameters of MLD Snooping

| Function                         | Parameter                    | Default Setting                |
|----------------------------------|------------------------------|--------------------------------|
| Global Settings of IGMP Snooping | MLD Snooping                 | Disabled                       |
|                                  | Unknown Multicast            | Forward                        |
|                                  | Report Message Suppression   | Disabled                       |
|                                  | Router Port Time             | 300 seconds                    |
|                                  | Member Port Time             | 260 seconds                    |
|                                  | Last Listener Query Interval | 1 second                       |
|                                  | Last Listener Query Count    | 2                              |
| MLD Snooping on the Port         | MLD Snooping                 | Disabled                       |
|                                  | Fast Leave                   | Disabled                       |
| MLD Snooping in the VLAN         | Enable or Not                | Disabled                       |
|                                  | Router Port Time             | 0, use global settings.        |
|                                  | Member Port Time             | 0, use global settings.        |
| Multicast VLAN                   | Multicast VLAN               | None                           |
|                                  | Router Port Time             | 0, use global settings.        |
|                                  | Member Port Time             | 0, use global settings.        |
|                                  | Replace Source IP            | ::, indicating no replacement. |

| Function              | Parameter               | Default Setting           |
|-----------------------|-------------------------|---------------------------|
| IGMP Snooping Querier | Enable or Not           | Disabled                  |
|                       | Query Interval          | 60 seconds                |
|                       | Max Response Time       | 10 seconds                |
|                       | General Query Source IP | FE80::02FF:FFFF:FE00:0001 |

# Part 13

## Configuring Logical Interfaces

### CHAPTERS

1. Overview
2. Logical Interfaces Configurations
3. Appendix: Default Parameters

# 1 Overview

Interfaces of a device are used to exchange data and interact with interfaces of other network devices. Interfaces are classified into physical interfaces and logical interfaces.

- Physical interfaces are the ports on the front panel or rear panel of the switch.
- Logical interfaces are manually configured and do not physically exist, such as loopback interfaces and routing interfaces.

This chapter introduces the configurations for logical interfaces. The supported types of logical interfaces are shown as below:

Table 1-1 Supported Types of Logical Interfaces

| Type                   | Description                                                                     |
|------------------------|---------------------------------------------------------------------------------|
| VLAN Interface         | A Layer 3 interface with which different VLANs can communicate with each other. |
| Loopback Interface     | An interface of which the status is always up.                                  |
| Routed Port            | A physical port configured as a Layer 3 port.                                   |
| Port-channel Interface | Several Ethernet ports bound together and configured as a Layer 3 interface.    |

# 2 Logical Interfaces Configurations

To complete IPv4 interface configuration, follow these steps:

- 1) Create a Layer 3 interface
- 2) Configure IPv4 parameters of the created interface
- 3) View detailed information of the created interface

To complete IPv6 interface configuration, follow these steps:

- 1) Create a Layer 3 interface
- 2) Configure IPv6 parameters of the created interface
- 3) View detailed information of the created interface

## 2.1 Using the GUI

### 2.1.1 Creating a Layer 3 Interface

Choose the menu **Routing > Interface > Interface Config** to load the following page.

Figure 2-1 Creating a Layer 3 Interface

**Creating Interface**

Interface ID: VLAN   (1-4094)

IP Address Mode:  None  Static  DHCP  BOOTP

IP Address:   (Format: 192.168.0.1) Create

Subnet Mask:   (Format: 255.255.255.0)

Admin Status: Enable

Interface Name:   (Optional. 1-16 characters)

| Interface List           |       |        |              |               |                |        |                                                                           |
|--------------------------|-------|--------|--------------|---------------|----------------|--------|---------------------------------------------------------------------------|
| Select                   | ID    | Mode   | IP Address   | Subnet Mask   | Interface Name | Status | Operation                                                                 |
| <input type="checkbox"/> | Vlan1 | Static | 192.168.0.16 | 255.255.255.0 |                | Up     | <a href="#">Edit</a>   <a href="#">Edit IPv6</a>   <a href="#">Detail</a> |

All
Delete
Help

- 1) In the **Creating Interface** section, specify an interface ID and configure relevant parameters for the interface according to your needs. Then click **Create**.

---

**Interface ID**      Select an interface type and enter the ID of the interface.

---

|                        |                                                                                                                                                                                                                                                                                    |
|------------------------|------------------------------------------------------------------------------------------------------------------------------------------------------------------------------------------------------------------------------------------------------------------------------------|
| <b>IP Address Mode</b> | Specify the IP address assignment mode of the interface.<br><br><b>None:</b> No IP address will be assigned.<br><br><b>Static:</b> Assign an IP address manually.<br><br><b>DHCP:</b> Assign an IP address through DHCP .<br><br><b>BOOTP:</b> Assign an IP address through BOOTP. |
| <b>IP Address</b>      | Specify the IP address of the interface if you choose "Static" as the IP address assignment mode.                                                                                                                                                                                  |
| <b>Subnet Mask</b>     | Specify the subnet mask of the interface's IP address.                                                                                                                                                                                                                             |
| <b>Admin Status</b>    | Enable or disable the interface's Layer 3 capabilities.                                                                                                                                                                                                                            |
| <b>Interface Name</b>  | (Optional) Enter the name of the interface.                                                                                                                                                                                                                                        |

2) In the **Interface List** section, you can view the corresponding interface entry you create.

### 2.1.2 Configuring IPv4 Parameters of the Interface

In **Figure 2-1** you can view the corresponding interface entry you create in the **Interface List** section. On the corresponding interface entry, click **Edit** to load the following page and configure the IPv4 parameters of the interface.

Figure 2-2 Configuring the IPv4 Parameters

**Modify Interface**

Interface ID:

IP Address Mode:  None  Static  DHCP  BOOTP

IP Address:  (Format: 192.168.0.1) Apply

Subnet Mask:  (Format: 255.255.255.0) Back

Admin Status:  ▼

Interface Name:  (Optional. 1-16 characters)

**Secondary IP Create**

IP Address:  (Format: 192.168.0.1) Create

Subnet Mask:  (Format: 255.255.255.0)

**Secondary IP List**

| Select                 | IP Address | Subnet mask |
|------------------------|------------|-------------|
| No entry in the table. |            |             |

All
Delete
Back
Help

1) In the **Modify Interface** section, specify an interface ID and configure relevant parameters for the interface according to your actual needs. Then click **Apply**.

|                     |                                                             |
|---------------------|-------------------------------------------------------------|
| <b>Interface ID</b> | Select an interface type and enter the ID of the interface. |
|---------------------|-------------------------------------------------------------|



---

|                 |                                                                                                                                                                                                                                                                                    |
|-----------------|------------------------------------------------------------------------------------------------------------------------------------------------------------------------------------------------------------------------------------------------------------------------------------|
| IP Address Mode | Specify the IP address assignment mode of the interface.<br><br><b>None:</b> No IP address will be assigned.<br><br><b>Static:</b> Assign an IP address manually.<br><br><b>DHCP:</b> Assign an IP address through DHCP .<br><br><b>BOOTP:</b> Assign an IP address through BOOTP. |
| IP Address      | Specify the IP address of the interface if you choose "Static" as the IP address assignment mode.                                                                                                                                                                                  |
| Subnet Mask     | Specify the subnet mask of the interface's IP address.                                                                                                                                                                                                                             |
| Admin Status    | Enable or disable the interface's Layer 3 capabilities.                                                                                                                                                                                                                            |
| Interface Name  | (Optional) Enter the name of the interface.                                                                                                                                                                                                                                        |

---

- 2) In the **Secondary IP Create** section, configure the secondary IP for the specified interface which allows you to have two logical subnets using one physical subnet. Then click **Create**.
- 3) In the **Secondary IP List** section, you can view the corresponding secondary IP entry you create.

### 2.1.3 Configuring IPv6 Parameters of the Interface

In **Figure 2-1**, you can view the corresponding interface entry you create in the **Interface List** section. On the corresponding interface entry, click **Edit IPv6** to load the following page and configure the IPv6 parameters of the interface.

Figure 2-3 Configuring the IPv6 Parameters

**General Config**

Interface ID: Vlan1 Back

IPv6:  Enable  Disable Apply

---

**Link-local Address Config**

Config Mode:  Manual  Auto

Link-local Address: fe80::20a:ebff:fe13:237b (Format: fe80::1) Apply

Status: Normal

---

**Global Address Autoconfig via RA Message**

Enable global address auto configuration via RA message Apply

---

**Global Address Autoconfig via DHCPv6 Server**

Enable global address auto configuration via DHCPv6 Server Apply

---

**Add a Global Address Manually**

Address Format:  EUI-64  Not EUI-64

Global Address:   (Format:3001::1/64) Apply

---

**Global Address Table**

| Select                                                                                                                                                                                                                                                  | Global Address                                               | Prefix Length                                                | Type | Preferred Lifetime | Valid Lifetime | Status |
|---------------------------------------------------------------------------------------------------------------------------------------------------------------------------------------------------------------------------------------------------------|--------------------------------------------------------------|--------------------------------------------------------------|------|--------------------|----------------|--------|
| <input type="checkbox"/>                                                                                                                                                                                                                                | <span style="border: 1px solid #ccc; padding: 2px;"> </span> | <span style="border: 1px solid #ccc; padding: 2px;"> </span> |      |                    |                |        |
| <b>No entry in the table.</b>                                                                                                                                                                                                                           |                                                              |                                                              |      |                    |                |        |
| <span style="border: 1px solid #ccc; padding: 2px 5px; margin-right: 10px;">Delete</span> <span style="border: 1px solid #ccc; padding: 2px 5px; margin-right: 10px;">Modify</span> <span style="border: 1px solid #ccc; padding: 2px 5px;">Help</span> |                                                              |                                                              |      |                    |                |        |

- 1) Enable IPv6 function on the interface of switch in the **General Config** section. Then click **Apply**.

|                              |                                                             |
|------------------------------|-------------------------------------------------------------|
| <a href="#">Interface ID</a> | Displays the interface ID.                                  |
| <a href="#">IPv6</a>         | Enable or disable IPv6 function on the interface of switch. |

- 2) Configure the IPv6 link-local address of the interface manually or automatically in the **Link-local Address Config** section. Then click **Apply**.

|                                                                                                      |                                                   |
|------------------------------------------------------------------------------------------------------|---------------------------------------------------|
| <a href="#">Config Mode</a>                                                                          | Select the link-local address configuration mode. |
| <b>Manual:</b> With this option selected, you can assign a link-local address manually.              |                                                   |
| <b>Auto:</b> With this option selected, the switch will generate a link-local address automatically. |                                                   |

|                    |                                                                                                                                                                                                                                                                                                                                                                                        |
|--------------------|----------------------------------------------------------------------------------------------------------------------------------------------------------------------------------------------------------------------------------------------------------------------------------------------------------------------------------------------------------------------------------------|
| Link-local Address | Enter a link-local address if you choose "Manual" as the link-local address configuration mode.                                                                                                                                                                                                                                                                                        |
| Status             | Displays the status of the link-local address.<br><br><b>Normal:</b> Indicates that the link-local address is normal.<br><br><b>Try:</b> Indicates that the link-local address may be newly configured.<br><br><b>Repeat:</b> Indicates that the link-local address is duplicate. It is illegal to access the switch using the IPv6 address (including link-local and global address). |

### 3) Configure one or more IPv6 global addresses of the interface via following three ways:

#### Via RA Message:

|                                                         |                                                                                                                                                                                                                              |
|---------------------------------------------------------|------------------------------------------------------------------------------------------------------------------------------------------------------------------------------------------------------------------------------|
| Enable global address auto configuration via RA message | With this option enabled, the switch automatically configures a global address and other information according to the address prefix and other configuration parameters from the received RA (Router Advertisement) message. |
|---------------------------------------------------------|------------------------------------------------------------------------------------------------------------------------------------------------------------------------------------------------------------------------------|

#### Via DHCPv6 Server:

|                                                            |                                                                                                    |
|------------------------------------------------------------|----------------------------------------------------------------------------------------------------|
| Enable global address auto configuration via DHCPv6 Server | With this option enabled, the switch will try to obtain the global address from the DHCPv6 Server. |
|------------------------------------------------------------|----------------------------------------------------------------------------------------------------|

#### Manually:

|                |                                                                                                                                                                                                                                                                                               |
|----------------|-----------------------------------------------------------------------------------------------------------------------------------------------------------------------------------------------------------------------------------------------------------------------------------------------|
| Address Format | Select the global address format according to your needs.<br><br><b>EUI-64:</b> Indicates that you only need to specify an address prefix, then the system will create a global address automatically.<br><br><b>Not EUI-64:</b> Indicates that you have to specify an intact global address. |
| Global Address | When EUI-64 is selected, please input the address prefix here, otherwise, please input an intact IPv6 address here.                                                                                                                                                                           |

### 4) View the global address entry in the Global Address Table.

|                    |                                                                                                                                                                                                                                                                                              |
|--------------------|----------------------------------------------------------------------------------------------------------------------------------------------------------------------------------------------------------------------------------------------------------------------------------------------|
| Global Address     | View and modify the global address.                                                                                                                                                                                                                                                          |
| Prefix Length      | View and modify the prefix length of the global address.                                                                                                                                                                                                                                     |
| Type               | Displays the configuration mode of the global address.<br><br><b>Manual:</b> Indicates that the corresponding address is configured manually.<br><br><b>Auto:</b> Indicates that the corresponding address is created automatically using the RA message or obtained from the DHCPv6 Server. |
| Preferred Lifetime | Displays the preferred lifetime of the global address.                                                                                                                                                                                                                                       |

|                |                                                                                                                                                                                                                                                                                                                                        |
|----------------|----------------------------------------------------------------------------------------------------------------------------------------------------------------------------------------------------------------------------------------------------------------------------------------------------------------------------------------|
| Valid Lifetime | Displays the valid lifetime of the global address.                                                                                                                                                                                                                                                                                     |
| Status         | <p>Displays the status of the global address.</p> <p><b>Normal:</b> Indicates that the global address is normal.</p> <p><b>Try:</b> Indicates that the global address may be newly configured.</p> <p><b>Repeat:</b> Indicates that the global address is duplicate. It is illegal to access the switch using this global address.</p> |

## 2.1.4 Viewing Detail Information of the Interface

In **Figure 2-1** you can view the corresponding interface entry you create in the **Interface List** section. On the corresponding interface entry, click **Detail** to load the following page and view the detail information of the interface.

Figure 2-4 Viewing the detail information of the interface

| Detail Information                        |                            |
|-------------------------------------------|----------------------------|
| Interface ID:                             | VLAN1                      |
| IP Address Mode:                          | Static                     |
| IP Address:                               | 192.168.0.16/255.255.255.0 |
| Secondary IP:                             |                            |
| Interface Status:                         | Up                         |
| Line Protocol Status:                     | Up                         |
| Admin Status:                             | Enable                     |
| Interface Name:                           |                            |
| Interface Setting Detail Information      |                            |
| MTU is 1500 bytes                         |                            |
| Directed broadcast forwarding is disabled |                            |
| ICMP redirects are never sent             |                            |
| ICMP unreachable are never sent           |                            |
| ICMP mask replies are never sent          |                            |

## 2.2 Using the CLI

### 2.2.1 Creating a Layer 3 Interface

Follow these steps to create a Layer 3 interface. You can create a VLAN interface, a loopback interface, a routed port or a port-channel interface according to your needs.

- |        |                                                                 |
|--------|-----------------------------------------------------------------|
| Step 1 | <p><b>configure</b></p> <p>Enter global configuration mode.</p> |
|--------|-----------------------------------------------------------------|

---

|        |                                                                                                                                                                                                                                                                                                                                                                                                                                                                                                                                                                                                                                                                                                                                                                                                                                                                                                                                                                                                                                                                                                                                      |
|--------|--------------------------------------------------------------------------------------------------------------------------------------------------------------------------------------------------------------------------------------------------------------------------------------------------------------------------------------------------------------------------------------------------------------------------------------------------------------------------------------------------------------------------------------------------------------------------------------------------------------------------------------------------------------------------------------------------------------------------------------------------------------------------------------------------------------------------------------------------------------------------------------------------------------------------------------------------------------------------------------------------------------------------------------------------------------------------------------------------------------------------------------|
| Step 2 | <p>Create a VLAN interface:</p> <p><b>interface vlan <i>vlan-id</i></b><br/><i>vlan-id</i>: Specify an IEEE 802.1Q VLAN ID that already exists, ranging from 1 to 4094.</p> <p>Create a loopback interface:</p> <p><b>interface loopback { <i>id</i> }</b><br/><i>id</i>: Specify the ID of the loopback interface, ranging from 1 to 64.</p> <p>Create a routed port:</p> <p><b>interface { fastEthernet <i>port</i>   range fastEthernet <i>port-list</i>   gigabitEthernet <i>port</i>   range gigabitEthernet <i>port-list</i>   ten-gigabitEthernet <i>port</i>   range ten-gigabitEthernet <i>port-list</i> }</b></p> <p>Enter interface configuration mode.</p> <p><i>port</i>: Specify the Ethernet port number, for example 1/0/1.<br/><i>port-list</i>: Specify the list of Ethernet ports, for example 1/0/1-3, 1/0/5.</p> <p><b>no switchport</b></p> <p>Switch the Layer 2 port into the Layer 3 routed port.</p> <p>Create a port-channel interface:</p> <p><b>interface range port-channel <i>port-channel-list</i></b><br/><i>port-channel-list</i>: The list of the port-channel interface, for example 1-3, 5.</p> |
| Step 3 | <p><b>description <i>string</i></b></p> <p>Specify a description to the Layer 3 interface, including VLAN interface, loopback interface, routed port and port-channel interface.</p> <p><i>string</i>: The description of the Layer 3 interface, ranging from 1 to 32 characters.</p>                                                                                                                                                                                                                                                                                                                                                                                                                                                                                                                                                                                                                                                                                                                                                                                                                                                |
| Step 4 | <p><b>end</b></p> <p>Return to privileged EXEC mode.</p>                                                                                                                                                                                                                                                                                                                                                                                                                                                                                                                                                                                                                                                                                                                                                                                                                                                                                                                                                                                                                                                                             |
| Step 5 | <p><b>copy running-config startup-config</b></p> <p>Save the settings in the configuration file.</p>                                                                                                                                                                                                                                                                                                                                                                                                                                                                                                                                                                                                                                                                                                                                                                                                                                                                                                                                                                                                                                 |

---

The following example shows how to create a VLAN interface with a description of VLAN-2.

**Switch#configure**

**Switch(config)#interface vlan 2**

**Switch(config-if)#description VLAN-2**

**Switch(config-if)#end**

**Switch#copy running-config startup-config**

## 2.2.2 Configuring IPv4 Parameters of the Interface

Follow these steps to configure the IPv4 parameters of the interface.

|        |                                                                                                                                                                                                                                                                                                                                                                                                                                                                                                                                                                                                                                                                                                                                                                                                                                                                                                                                                                           |
|--------|---------------------------------------------------------------------------------------------------------------------------------------------------------------------------------------------------------------------------------------------------------------------------------------------------------------------------------------------------------------------------------------------------------------------------------------------------------------------------------------------------------------------------------------------------------------------------------------------------------------------------------------------------------------------------------------------------------------------------------------------------------------------------------------------------------------------------------------------------------------------------------------------------------------------------------------------------------------------------|
| Step 1 | <b>configure</b><br>Enter global configuration mode.                                                                                                                                                                                                                                                                                                                                                                                                                                                                                                                                                                                                                                                                                                                                                                                                                                                                                                                      |
| Step 2 | <b>interface { interface-type } { interface-number }</b><br>Enter layer 3 interface configuration mode.<br><br><i>interface-type</i> : Type of the layer 3 interface, including fastEthernet, gigabitEthernet, ten-gigabitEthernet, loopback and VLAN.<br><br><i>interface-number</i> : Number of the interface.                                                                                                                                                                                                                                                                                                                                                                                                                                                                                                                                                                                                                                                          |
| Step 3 | Automatically assign an IP Address for the interface via DHCP or BOOTP:<br><b>ip address-alloc { dhcp   bootp }</b><br>Specify the IP Address assignment mode of the interface.<br><br><i>dhcp</i> : Specify the Layer 3 interface to obtain an IPv4 address from the DHCP Server.<br><i>bootp</i> : Specify the Layer 3 interface to obtain an IPv4 address from the BOOTP Server.<br><br>Manually assign an IP Address for the interface:<br><b>ip address { ip-addr } { mask } [ secondary ]</b><br>Configure the IP address and subnet mask for the specified interface manually.<br><i>ip-addr</i> : Specify the IP address of the Layer 3 interface.<br><i>mask</i> : Specify the subnet mask of the Layer 3 interface.<br><b>secondary</b> : Specify the interface's secondary IP address which allows you to have two logical subnets using one physical subnet. If this parameter is omitted here, the configured IP address is the interface's primary address. |
| Step 4 | <b>show ip interface brief</b><br>Verify the summary information of the Layer 3 interfaces.                                                                                                                                                                                                                                                                                                                                                                                                                                                                                                                                                                                                                                                                                                                                                                                                                                                                               |
| Step 5 | <b>end</b><br>Return to privileged EXEC mode.                                                                                                                                                                                                                                                                                                                                                                                                                                                                                                                                                                                                                                                                                                                                                                                                                                                                                                                             |
| Step 6 | <b>copy running-config startup-config</b><br>Save the settings in the configuration file.                                                                                                                                                                                                                                                                                                                                                                                                                                                                                                                                                                                                                                                                                                                                                                                                                                                                                 |

The following example shows how to configure the IPv4 parameters of a routed port, including setting a static IP address for the port and enabling the Layer 3 capabilities:

```
Switch#configure
```

```
Switch(config)#interface ten-gigabitEthernet 1/0/1
```

```
Switch(config-if)#no switchport
```

```
Switch(config-if)#ip address 192.168.0.100 255.255.255.0
```

```
Switch(config-if)#show ip interface brief
```

| Interface | IP-Address       | Method | Status | Protocol | Shutdown |
|-----------|------------------|--------|--------|----------|----------|
| -----     | -----            | -----  | -----  | -----    | -----    |
| Te1/0/1   | 192.168.0.100/24 | Static | Up     | Up       | no       |

**Switch(config-if)#end**

**Switch#copy running-config startup-config**

## 2.2.3 Configuring IPv6 Parameters of the Interface

Follow these steps to configure the IPv6 parameters of the interface.

---

|        |                                                                 |
|--------|-----------------------------------------------------------------|
| Step 1 | <p><b>configure</b></p> <p>Enter global configuration mode.</p> |
|--------|-----------------------------------------------------------------|

---

|        |                                                                                                                                                                                                                                                                                                                                         |
|--------|-----------------------------------------------------------------------------------------------------------------------------------------------------------------------------------------------------------------------------------------------------------------------------------------------------------------------------------------|
| Step 2 | <p><b>interface</b> { <i>interface-type</i> } { <i>interface-number</i> }</p> <p>Enter layer 3 interface configuration mode.</p> <p><i>interface-type</i>: Type of the layer 3 interface, including fastEthernet, gigabitEthernet, ten-gigabitEthernet, loopback and VLAN.</p> <p><i>interface-number</i>: Number of the interface.</p> |
|--------|-----------------------------------------------------------------------------------------------------------------------------------------------------------------------------------------------------------------------------------------------------------------------------------------------------------------------------------------|

---

|        |                                                                                                                                                                                                                    |
|--------|--------------------------------------------------------------------------------------------------------------------------------------------------------------------------------------------------------------------|
| Step 3 | <p><b>ipv6 enable</b></p> <p>Enable the IPv6 function on the specified Layer 3 interface. By default, it is enabled on VLAN interface 1. IPv6 function can only be enabled on one Layer 3 interface at a time.</p> |
|--------|--------------------------------------------------------------------------------------------------------------------------------------------------------------------------------------------------------------------|

---

|        |                                                                                                                                                                                                                                                                                                                                                                                                                                                                                                                                   |
|--------|-----------------------------------------------------------------------------------------------------------------------------------------------------------------------------------------------------------------------------------------------------------------------------------------------------------------------------------------------------------------------------------------------------------------------------------------------------------------------------------------------------------------------------------|
| Step 4 | <p>Configure the IPv6 link-local address for the specified interface:</p> <p>Manually configure the ipv6 link-local address for the specified interface:<br/> <b>ipv6 address <i>ipv6-addr</i> link-local</b><br/> <i>ipv6-addr</i>: Specify the link-local address of the interface. It should be a standardized IPv6 address with the prefix fe80::/10, otherwise this command will be invalid.</p> <p>Automatically configure the ipv6 link-local address for the specified interface:<br/> <b>ipv6 address autoconfig</b></p> |
|--------|-----------------------------------------------------------------------------------------------------------------------------------------------------------------------------------------------------------------------------------------------------------------------------------------------------------------------------------------------------------------------------------------------------------------------------------------------------------------------------------------------------------------------------------|

---

|        |                                                                                                                                                                                                                                                                                                                                                                                                                                                                                                                                                                                                                                                                                                                                                                                                                                                                                                                                                                                                                                                                                               |
|--------|-----------------------------------------------------------------------------------------------------------------------------------------------------------------------------------------------------------------------------------------------------------------------------------------------------------------------------------------------------------------------------------------------------------------------------------------------------------------------------------------------------------------------------------------------------------------------------------------------------------------------------------------------------------------------------------------------------------------------------------------------------------------------------------------------------------------------------------------------------------------------------------------------------------------------------------------------------------------------------------------------------------------------------------------------------------------------------------------------|
| Step 5 | Configure the IPv6 global address for the specified interface:                                                                                                                                                                                                                                                                                                                                                                                                                                                                                                                                                                                                                                                                                                                                                                                                                                                                                                                                                                                                                                |
|        | <p>Automatically configure the interface's global IPv6 address via RA message:<br/> <b>ipv6 address ra</b><br/> Configure the interface's global IPv6 address according to the address prefix and other configuration parameters from its received RA (Router Advertisement) message.</p> <p>Automatically configure the interface's global IPv6 address via DHCPv6 server:<br/> <b>ipv6 address dhcp</b><br/> Enable the DHCPv6 Client function. When this function is enabled, the Layer 3 interface will try to obtain the IPv6 address from DHCPv6 server.</p> <p>Manually configure the interface's global IPv6 address:<br/> <b>ipv6 address ipv6-addr</b><br/> <i>ipv6-addr</i>: The Global IPv6 address with network prefix, for example 3ffe::1/64.<br/> <b>ipv6 address ipv6-addr eui-64</b><br/> Specify a global IPv6 address with an extended unique identifier (EUI) in the low-order 64 bits of the IPv6 address. Specify only the network prefix; the last 64 bits are automatically computed from the switch MAC address. This enables IPv6 processing on the interface.</p> |
| Step 6 | <b>show ipv6 interface</b><br>Verify the configured ipv6 information of the interface.                                                                                                                                                                                                                                                                                                                                                                                                                                                                                                                                                                                                                                                                                                                                                                                                                                                                                                                                                                                                        |
| Step 7 | <b>end</b><br>Return to privileged EXEC mode.                                                                                                                                                                                                                                                                                                                                                                                                                                                                                                                                                                                                                                                                                                                                                                                                                                                                                                                                                                                                                                                 |
| Step 8 | <b>copy running-config startup-config</b><br>Save the settings in the configuration file.                                                                                                                                                                                                                                                                                                                                                                                                                                                                                                                                                                                                                                                                                                                                                                                                                                                                                                                                                                                                     |

The following example shows how to enable the IPv6 function and configure the IPv6 parameters of a vlan interface:

**Switch#configure**

**Switch(config)#interface vlan 2**

**Switch(config-if)#ipv6 enable**

**Switch(config-if)#ipv6 address autoconfig**

**Switch(config-if)#ipv6 address dhcp**

**Switch(config-if)#show ipv6 interface**

Vlan2 is up, line protocol is up

IPv6 is enable, Link-Local Address: fe80::20a:ebff:fe13:237b[NOR]

Global Address RA: Disable

Global Address DHCPv6: Enable

Global unicast address(es): ff02::1:ff13:237b

Joined group address(es): ff02::1



ICMP error messages limited to one every 1000 milliseconds

ICMP redirects are enable

MTU is 1500 bytes

ND DAD is enable, number of DAD attempts: 1

ND retrans timer is 1000 milliseconds

ND reachable time is 30000 milliseconds

**Switch(config-if)#end**

**Switch#copy running-config startup-config**

# 3 Appendix: Default Parameters

Default settings of interface are listed in the following tables.

Table 3-1 Configuring the IPv4 Parameters of the Interface

| Parameter       | Default Setting |
|-----------------|-----------------|
| Interface ID    | VLAN            |
| IP Address Mode | None            |
| Admin Status    | Enable          |
| Recovery mode   | Auto            |

Table 3-2 Configuring the IPv6 Parameters of the Interface

| Parameter                                                  | Default Setting                                           |
|------------------------------------------------------------|-----------------------------------------------------------|
| IPv6                                                       | Disable<br>On VLAN interface 1, it is enabled by default. |
| Config Mode                                                | Auto                                                      |
| Enable global address auto configuration via RA message    | Enable                                                    |
| Enable global address auto configuration via DHCPv6 Server | Disable                                                   |

# Part 14

## Configuring Static Routing

### CHAPTERS

1. Overview
2. IPv4 Static Routing Configuration
3. IPv6 Static Routing Configuration
4. Viewing Routing Table
5. Example for Static Routing
6. Appendix: Default Parameter

# 1 Overview

Static routing is a form of routing that is configured manually by adding non-aging entries into a routing table. The manually-configured routing information guides the router in forwarding data packets to the specific destination. On a simple network with a small number of devices, you only need to configure static routes to ensure that the devices from different subnets can communicate with each other. On a complex large-scale network, static routes ensure stable connectivity for important applications because the static routes remain unchanged even when the topology changes.

The switch supports IPv4 static routing and IPv6 static routing.

# 2 IPv4 Static Routing Configuration

## 2.1 Using the GUI

Choose the menu **Routing > Static Routing > IPv4 Static Routing Config** to load the following page.

Figure 2-1 Configuring the IPv4 Static Routing

**IPv4 Static Routing Config**

Destination:  (Format: 10.10.10.0)

Subnet Mask:  (Format: 255.255.255.0)

Next Hop:  (Format: 192.168.0.2)

Distance:  (Optional. range: 1-255)

---

**IPv4 Static Route Table**

| Select                   | Destination | Subnet Mask   | Next Hop             | Distance             | Metric | Interface Name |
|--------------------------|-------------|---------------|----------------------|----------------------|--------|----------------|
| <input type="checkbox"/> |             |               | <input type="text"/> | <input type="text"/> |        |                |
| <input type="checkbox"/> | 192.168.1.0 | 255.255.255.0 | 192.168.0.1          | 1                    | 0      |                |

- 1) In the **IPv4 Static Routing Config** section, configure the corresponding parameters to add an IPv4 static route. Then click **Create**.

|                    |                                                                                                                                                                                                                                                                                                                        |
|--------------------|------------------------------------------------------------------------------------------------------------------------------------------------------------------------------------------------------------------------------------------------------------------------------------------------------------------------|
| <b>Destination</b> | Specify the destination IPv4 address of the packets.                                                                                                                                                                                                                                                                   |
| <b>Subnet Mask</b> | Specify the subnet mask of the destination IPv4 address.                                                                                                                                                                                                                                                               |
| <b>Next Hop</b>    | Specify the IPv4 gateway address to which the packet should be sent next.                                                                                                                                                                                                                                              |
| <b>Distance</b>    | Specify the administrative distance, which is a rating of the trustworthiness of the routing information. A higher value means a lower trust rating. When more than one routing protocols have routes to the same destination, only the route that has the shortest distance will be recorded in the IP routing table. |

The valid values are from 1 to 255 and the default value is 1.

- 2) In the **IPv4 Static Route Table** section, you can view and modify the IPv4 static routing entries.

## 2.2 Using the CLI

Follow these steps to create an IPv4 static route.

|        |                                                                                                                                                                                                                                                                                                                                                                                                                                                                                                                                                                                                                                                                                                                                                                                    |
|--------|------------------------------------------------------------------------------------------------------------------------------------------------------------------------------------------------------------------------------------------------------------------------------------------------------------------------------------------------------------------------------------------------------------------------------------------------------------------------------------------------------------------------------------------------------------------------------------------------------------------------------------------------------------------------------------------------------------------------------------------------------------------------------------|
| Step 1 | <b>configure</b><br>Enter global configuration mode.                                                                                                                                                                                                                                                                                                                                                                                                                                                                                                                                                                                                                                                                                                                               |
| Step 2 | <b>ip route { dest-address } { mask } { next-hop-address } [ distance ]</b><br>Add an IPv4 static route.<br><i>dest-address</i> : Specify the destination IPv4 address of the packets.<br><i>mask</i> : Specify the subnet mask of the destination IPv4 address.<br><i>next-hop-address</i> : Specify the IPv4 gateway address to which the packet should be sent next.<br><i>distance</i> : Specify the administrative distance, which is a rating of the trustworthiness of the routing information. A higher value means a lower trust rating. When more than one routing protocols have routes to the same destination, only the route that has the shortest distance will be recorded in the IP routing table. The valid values are from 1 to 255 and the default value is 1. |
| Step 3 | <b>show ip route [ static   connected ]</b><br>Verify the IPv4 route entries of the specified type.                                                                                                                                                                                                                                                                                                                                                                                                                                                                                                                                                                                                                                                                                |
| Step 4 | <b>end</b><br>Return to privileged EXEC mode.                                                                                                                                                                                                                                                                                                                                                                                                                                                                                                                                                                                                                                                                                                                                      |
| Step 5 | <b>copy running-config startup-config</b><br>Save the settings in the configuration file.                                                                                                                                                                                                                                                                                                                                                                                                                                                                                                                                                                                                                                                                                          |

The following example shows how to create an IPv4 static route with the destination IP address as 192.168.2.0, the subnet mask as 255.255.255.0 and the next-hop address as 192.168.0.2:

**Switch#configure**

**Switch(config)#ip route 192.168.2.0 255.255.255.0 192.168.0.2**

**Switch(config)#show ip route**

Codes: C - connected, S - static

\* - candidate default

C 192.168.0.0/24 is directly connected, Vlan1

S 192.168.2.0/24 [1/0] via 192.168.0.2, Vlan1

**Switch(config)#end**

**Switch#copy running-config startup-config**

# 3 IPv6 Static Routing Configuration

## 3.1 Using the GUI

Choose the menu **Routing > Static Routing > IPv6 Static Routing Config** to load the following page.

Figure 3-1 Configuring the IPv6 Static Routing

**IPv6 Routing**

IPv6 Routing  enable  disable Apply

---

**IPv6 Static Routing Config**

IPv6 Address:  (Format: 2001::)  
 Prefix Length:  (Format: 64)  
 Next Hop:  (Format: 3001::2)  
 Distance:  (Optional. range: 1-255)

Create

---

**IPv6 Static Route Table**

| Select                   | IPv6 Address/Prefix Length | Next Hop             | Distance             | Metric | Interface Name |
|--------------------------|----------------------------|----------------------|----------------------|--------|----------------|
| <input type="checkbox"/> |                            | <input type="text"/> | <input type="text"/> |        |                |
| <input type="checkbox"/> | 3000::/64                  | 3000::1234           | 1                    | 0      |                |

Apply
Delete
Help

- 1) In the **IPv6 Routing** section, enable IPv6 routing function and click **Apply**.
- 2) In the **IPv6 Static Routing Config** section, configure corresponding parameters to add an IPv6 static route. Then click **Create**.

|                      |                                                                                                                                                                                                                                                                                                                        |
|----------------------|------------------------------------------------------------------------------------------------------------------------------------------------------------------------------------------------------------------------------------------------------------------------------------------------------------------------|
| <b>IPv6 Address</b>  | Specify the destination IPv6 address of the packets.                                                                                                                                                                                                                                                                   |
| <b>Prefix Length</b> | Specify the prefix length of the IPv6 address.                                                                                                                                                                                                                                                                         |
| <b>Next Hop</b>      | Specify the IPv6 gateway address to which the packet should be sent next.                                                                                                                                                                                                                                              |
| <b>Distance</b>      | Specify the administrative distance, which is a rating of the trustworthiness of the routing information. A higher value means a lower trust rating. When more than one routing protocols have routes to the same destination, only the route that has the shortest distance will be recorded in the IP routing table. |

The valid values are from 1 to 255 and the default value is 1.

- 3) In the **IPv6 Static Route Table** section, you can view and modify the IPv6 static routing entries.

## 3.2 Using the CLI

Follow these steps to enable IPv6 routing function and create an IPv6 static route.

---

|        |                                                                                                                                                                                                                                                                                                                                                                                                                                                                                                                                                                                                                                                                                                                                                                             |
|--------|-----------------------------------------------------------------------------------------------------------------------------------------------------------------------------------------------------------------------------------------------------------------------------------------------------------------------------------------------------------------------------------------------------------------------------------------------------------------------------------------------------------------------------------------------------------------------------------------------------------------------------------------------------------------------------------------------------------------------------------------------------------------------------|
| Step 1 | <b>configure</b><br>Enter global configuration mode.                                                                                                                                                                                                                                                                                                                                                                                                                                                                                                                                                                                                                                                                                                                        |
| Step 2 | <b>interface</b> { <i>interface-type</i> } { <i>interface-number</i> }<br>Enter layer 3 interface configuration mode.<br><br><i>interface-type</i> : Type of the layer 3 interface, including fastEthernet, gigabitEthernet, ten-gigabitEthernet, loopback and VLAN.<br><i>interface-number</i> : Number of the interface.                                                                                                                                                                                                                                                                                                                                                                                                                                                  |
| Step 3 | <b>ipv6 routing</b><br>Enable the IPv6 routing function on the specified layer 3 interface.                                                                                                                                                                                                                                                                                                                                                                                                                                                                                                                                                                                                                                                                                 |
| Step 4 | <b>ipv6 route</b> { <i>ipv6-dest-address</i> } { <i>next-hop-address</i> } [ <i>distance</i> ]<br>Add an IPv6 static route.<br><br><i>ipv6-dest-address</i> : Specify the destination IPv6 address of the packets, in the format of X:X:X::X/<0-128>.<br><i>next-hop-address</i> : Specify the IPv6 gateway address to which the packet should be sent next.<br><br><i>distance</i> : Specify the administrative distance, which is a rating of the trustworthiness of the routing information. A higher value means a lower trust rating. When more than one routing protocols have routes to the same destination, only the route that has the shortest distance will be recorded in the IP routing table. The valid values are from 1 to 255 and the default value is 1. |
| Step 5 | <b>show ipv6 route</b> [ <i>static</i>   <i>connected</i> ]<br>Verify the IPv6 route entries of the specified type.                                                                                                                                                                                                                                                                                                                                                                                                                                                                                                                                                                                                                                                         |
| Step 6 | <b>end</b><br>Return to privileged EXEC mode.                                                                                                                                                                                                                                                                                                                                                                                                                                                                                                                                                                                                                                                                                                                               |
| Step 7 | <b>copy running-config startup-config</b><br>Save the settings in the configuration file.                                                                                                                                                                                                                                                                                                                                                                                                                                                                                                                                                                                                                                                                                   |

---

The following example shows how to create an IPv6 static route with the destination IP address as 3200::/64 and the next-hop address as 3100::1234:

**Switch#configure**

**Switch(config)#ipv6 route 3200::/64 3100::1234**

**Switch(config)#show ipv6 route static**

Codes: C - connected, S - static

\* - candidate default



```
C 3000::/64 is directly connected, Vlan1
```

```
S 3200::/64 [1/0] via 3100::1234, Vlan2
```

```
Switch(config)#end
```

```
Switch#copy running-config startup-config
```

# 4 Viewing Routing Table

You can view routing tables to learn about the network topology. The switch supports IPv4 routing table and IPv6 routing table.

## 4.1 Using the GUI

### 4.1.1 Viewing IPv4 Routing Table

Choose the menu **Routing > Routing Table > IPv4 Routing Table** to load the following page.

Figure 4-1 Viewing IPv4 Routing Table

| IPv4 Routing Information Summary |                     |              |          |        |                |
|----------------------------------|---------------------|--------------|----------|--------|----------------|
| Protocol                         | Destination Network | Next Hop     | Distance | Metric | Interface Name |
| connected                        | 192.168.0.0/24      | 192.168.0.16 | 0        | 1      |                |
| static                           | 192.168.1.0/24      | 192.168.0.1  | 1        | 0      |                |

View the IPv4 routes in the **IPv4 Routing Information Summary** section.

|                            |                                                                                                                                                                                                                                                                                                                       |
|----------------------------|-----------------------------------------------------------------------------------------------------------------------------------------------------------------------------------------------------------------------------------------------------------------------------------------------------------------------|
| <b>Protocol</b>            | Displays the type of the route entry.                                                                                                                                                                                                                                                                                 |
| <b>Destination Network</b> | Displays the destination IP address and subnet mask.                                                                                                                                                                                                                                                                  |
| <b>Next Hop</b>            | Displays the IPv4 gateway address to which the packet should be sent next.                                                                                                                                                                                                                                            |
| <b>Distance</b>            | Displays the administrative distance which is a rating of the trustworthiness of a routing information. A higher value means a lower trust rating. When more than one routing protocols have routes to the same destination, only the route which has the smallest distance will be recorded in the IP routing table. |
| <b>Metric</b>              | Displays the metric to reach the destination IP address.                                                                                                                                                                                                                                                              |
| <b>Interface Name</b>      | Displays the gateway interface name.                                                                                                                                                                                                                                                                                  |

## 4.1.2 Viewing IPv6 Routing Table

Choose the menu **Routing > Routing Table > IPv6 Routing Table** to load the following page.

Figure 4-2 Viewing IPv6 Routing Table

| IPv6 Routing Information Summary       |                     |          |          |        |                |
|----------------------------------------|---------------------|----------|----------|--------|----------------|
| Protocol                               | Destination Network | Next Hop | Distance | Metric | Interface Name |
| No entry in the table.                 |                     |          |          |        |                |
| <input type="button" value="Refresh"/> |                     |          |          |        |                |

View the IPv6 routes in the **IPv6 Routing Information Summary** section.

|                     |                                                                                                                                                                                                                                                                                                                       |
|---------------------|-----------------------------------------------------------------------------------------------------------------------------------------------------------------------------------------------------------------------------------------------------------------------------------------------------------------------|
| Protocol            | Displays the type of the route entry.                                                                                                                                                                                                                                                                                 |
| Destination Network | Displays the destination IP address and subnet mask.                                                                                                                                                                                                                                                                  |
| Next Hop            | Displays the IPv6 gateway address to which the packet should be sent next.                                                                                                                                                                                                                                            |
| Distance            | Displays the administrative distance which is a rating of the trustworthiness of a routing information. A higher value means a lower trust rating. When more than one routing protocols have routes to the same destination, only the route which has the smallest distance will be recorded in the IP routing table. |
| Metric              | Displays the metric to reach the destination IP address.                                                                                                                                                                                                                                                              |
| Interface Name      | Displays the gateway interface name.                                                                                                                                                                                                                                                                                  |

## 4.2 Using the CLI

### 4.2.1 Viewing IPv4 Routing Table

On privileged EXEC mode or any other configuration mode, you can use the following command to view IPv4 routing table:

```
show ip route [ static | connected ]
```

View the IPv4 route entries of the specified type. If not specified, all types of route entries will be displayed.

**static:** View the static routes.

**connected:** View the connected routes.

## 4.2.2 Viewing IPv6 Routing Table

On privileged EXEC mode or any other configuration mode, you can use the following command to view IPv6 routing table:

---

**show ipv6 route [ static | connected ]**

View the IPv6 route entries of the specified type. If not specified, all types of route entries will be displayed.

**static:** View the static IPv6 routes.

**connected:** View the connected IPv6 routes.

---

# 5 Example for Static Routing

## 5.1 Network Requirements

As shown below, Host A and Host B are on different network segments. To meet business needs, Host A and Host B need establish a connection without using dynamic routing protocols to ensure stable connectivity.

Figure 5-1 Network Topology

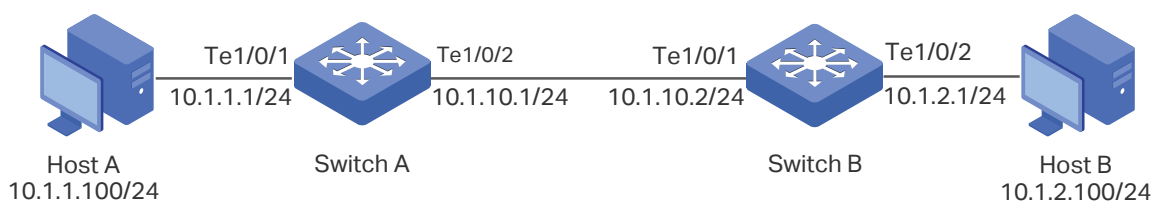

## 5.2 Configuration Scheme

To implement this requirement, you can configure the default gateway of host A as 10.1.1.1/24, the default gateway of host B as 10.1.2.1/24, and configure IPv4 static routes on Switch A and Switch B so that hosts on different network segments can communicate with each other.

Demonstrated with T1700X-16TS, the following sections provide configuration procedure in two ways: using the GUI and using the CLI.

## 5.3 Using the GUI

The configurations of Switch A and Switch B are similar. The following introductions take Switch A as an example.

- 1) Choose the menu **Routing > Interface > Interface Config** to load the following page. Create a routed port Te1/0/1 with the mode as static, the IP address as 10.1.1.1, the mask as 255.255.255.0 and the admin status as Enable. Create a routed port Te1/0/2 with the mode as static, the IP address as 10.1.10.1, the mask as 255.255.255.0 and the admin status as Enable.

Figure 5-2 Create a Routed Port Te1/0/1 for Switch A

**Creating Interface**

Interface ID: Routed Port 1/0/1

IP Address Mode:  None  **Static**  DHCP  BOOTP

IP Address: 10.1.1.1 (Format: 192.168.0.1)

Subnet Mask: 255.255.255.0 (Format: 255.255.255.0)

Admin Status: Enable

Interface Name:  (Optional. 1-16 characters)

Create

Figure 5-3 Create a Routed Port Te1/0/2 for Switch A

**Creating Interface**

Interface ID: Routed Port 1/0/2

IP Address Mode:  None  **Static**  DHCP  BOOTP

IP Address: 10.1.1.1 (Format: 192.168.0.1)

Subnet Mask: 255.255.255.0 (Format: 255.255.255.0)

Admin Status: Enable

Interface Name:  (Optional. 1-16 characters)

Create

- 2) Choose the menu **Routing > Static Routing > IPv4 Static Routing Config** to load the following page. Add a static route entry with the destination as 10.1.2.0, the subnet mask as 255.255.255.0 and the next hop as 10.1.10.2. For switch B, add a static route entry with the destination as 10.1.1.0, the subnet mask as 255.255.255.0 and the next hop as 10.1.10.1.

Figure 5-4 Add a Static Route for Switch A

**IPv4 Static Routing Config**

Destination: 10.1.2.0 (Format: 10.10.10.0)

Subnet Mask: 255.255.255.0 (Format: 255.255.255.0)

Next Hop: 10.1.10.2 (Format: 192.168.0.2)

Distance:  (Optional. range: 1-255)

Create

| IPv4 Static Route Table  |             |               |                      |                      |        |                |
|--------------------------|-------------|---------------|----------------------|----------------------|--------|----------------|
| Select                   | Destination | Subnet Mask   | Next Hop             | Distance             | Metric | Interface Name |
| <input type="checkbox"/> |             |               | <input type="text"/> | <input type="text"/> |        |                |
| <input type="checkbox"/> | 10.1.2.0    | 255.255.255.0 | 10.1.10.2            | 1                    | 0      |                |

Apply
Delete
Help

## 5.4 Using the CLI

The configurations of Switch A and Switch B are similar. The following introductions take Switch A as an example.

- 1) Create a routed port Te1/0/1 with the mode as static, the IP address as 10.1.1.1, the mask as 255.255.255.0 and the admin status as Enable. Create a routed port Te1/0/2

with the mode as static, the IP address as 10.1.10.1, the mask as 255.255.255.0 and the admin status as Enable.

```
Switch_A#configure
```

```
Switch_A(config)#interface ten-gigabitEthernet 1/0/1
```

```
Switch_A(config-if)#no switchport
```

```
Switch_A(config-if)#ip address 10.1.1.1 255.255.255.0
```

```
Switch_A(config-if)#exit
```

```
Switch_A(config)#interface ten-gigabitEthernet 1/0/2
```

```
Switch_A(config-if)#no switchport
```

```
Switch_A(config-if)#ip address 10.1.10.1 255.255.255.0
```

- 2) Add a static route entry with the destination as 10.1.2.0, the subnet mask as 255.255.255.0 and the next hop as 10.1.10.2. For switch B, add a static route entry with the destination as 10.1.1.0, the subnet mask as 255.255.255.0 and the next hop as 10.1.10.1.

```
Switch_A#configure
```

```
Switch_A(config)#ip route 10.1.2.0 255.255.255.0 10.1.10.2
```

```
Switch_A(config)#end
```

```
Switch_A#copy running-config startup-config
```

## Verify the Configurations

### ■ Switch A

Verify the static routing configuration:

```
Switch_A#show ip route
```

Codes: C - connected, S - static

\* - candidate default

```
C 10.1.1.0/24 is directly connected, Vlan10
```

```
C 10.1.10.0/24 is directly connected, Vlan20
```

```
S 10.1.2.0/24 [1/0] via 10.1.10.2, Vlan20
```

### ■ Switch B

Verify the static routing configuration:

```
Switch_B#show ip route
```

Codes: C - connected, S - static

\* - candidate default

```
C 10.1.2.0/24 is directly connected, Vlan30
C 10.1.10.0/24 is directly connected, Vlan20
S 10.1.1.0/24 [1/0] via 10.1.10.1, Vlan20
```

#### ■ Connectivity Between Switch A and Switch B

Run the ping command on switch A to verify the connectivity:

```
Switch_A#ping 10.1.2.1
```

Pinging 10.1.2.1 with 64 bytes of data :

```
Reply from 10.1.2.1 : bytes=64 time<16ms TTL=64
```

```
Reply from 10.1.2.1 : bytes=64 time<16ms TTL=64
```

```
Reply from 10.1.2.1 : bytes=64 time<16ms TTL=64
```

```
Reply from 10.1.2.1 : bytes=64 time<16ms TTL=64
```

Ping statistics for 10.1.2.1:

```
  Packets: Sent = 4 , Received = 4 , Lost = 0 (0% loss)
```

Approximate round trip times in milli-seconds:

```
Minimum = 1ms , Maximum = 3ms , Average = 1ms
```



# 6 Appendix: Default Parameter

Default setting of static routing is listed in the following table.

Table 6-1 Configuring Static Routing

| Parameter    | Default Setting |
|--------------|-----------------|
| IPv6 Routing | Enable          |

# Part 15

## Configuring DHCP Relay

### CHAPTERS

1. Overview
2. DHCP Relay Configuration
3. Configuration Example
4. Appendix: Default Parameters

# 1 Overview

DHCP Relay is used to process and forward DHCP packets between different subnets.

Since the client requests a dynamic IP address via broadcast, the basic network model of DHCP requires that the client and the server should be on the same LAN. Therefore, each LAN should be equipped with a DHCP server, thus increasing the costs of network construction.

DHCP Relay solves this problem. As the following figure shows, the DHCP Relay device acts as a relay agent and forwards DHCP packets between DHCP clients and DHCP servers on different subnets, so that DHCP clients on different subnets can share one DHCP server.

Figure 1-1 Application Scenario of DHCP Relay

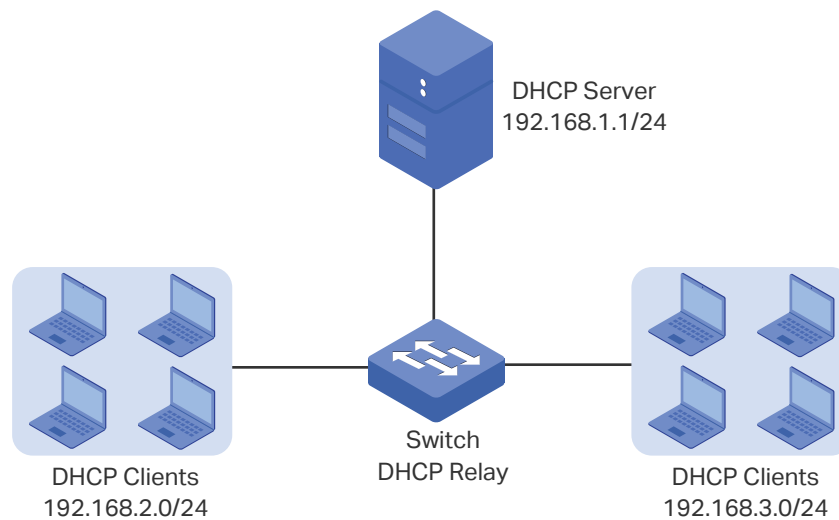

# 2 DHCP Relay Configuration

To complete DHCP Relay configuration, follow these steps:

- 1) Enable DHCP Relay and configure Option 82.
- 2) Specify DHCP server for the Interface.

## 2.1 Using the GUI

### 2.1.1 Enabling DHCP Relay and Configuring Option 82

Choose the menu **Routing > DHCP Relay > Global Config** to load the following page.

Figure 2-1 Enable DHCP Relay and Configure Option 82

The screenshot shows a configuration page with two main sections: 'Global Config' and 'Option 82 Configuration'. In the 'Global Config' section, 'DHCP Relay' is set to 'Disable' (radio button selected). In the 'Option 82 Configuration' section, 'Option 82 Support' is set to 'Disable', 'Existed Option 82 field' is set to 'Keep' (dropdown menu), and 'Customization' is set to 'Disable'. There are two empty text input fields for 'Circuit ID' and 'Remote ID'. At the bottom, there are 'Apply' and 'Help' buttons.

Follow these steps to enable DHCP Relay and configure Option 82:

- 1) In the **Global Config** section, enable DHCP Relay.
- 2) (Optional) In the **Option 82 Configuration** section, configure Option 82.

|                   |                                                                                                                                                                                                                                                                                                        |
|-------------------|--------------------------------------------------------------------------------------------------------------------------------------------------------------------------------------------------------------------------------------------------------------------------------------------------------|
| DHCP Relay        | Enable DHCP Relay.                                                                                                                                                                                                                                                                                     |
| Option 82 Support | Select whether to enable Option 82 or not. By default, it is disabled. Option 82 is used to record the locations of the DHCP client, its Ethernet port and the VLAN, etc. If you need to record the accurate location of a client, you can enable Option 82 on the relay device closest to the client. |

|                         |                                                                                                                                                                                                                                                                                                                                               |
|-------------------------|-----------------------------------------------------------------------------------------------------------------------------------------------------------------------------------------------------------------------------------------------------------------------------------------------------------------------------------------------|
| Existed Option 82 field | Select the operation for the Option 82 field of the DHCP request packets.                                                                                                                                                                                                                                                                     |
|                         | <b>Keep:</b> Indicates keeping the Option 82 field of the packets.                                                                                                                                                                                                                                                                            |
|                         | <b>Replace:</b> Indicates replacing the Option 82 field of the packets with the switch defined one. By default, the Circuit ID is defined to be the VLAN and the number of the port which receives the DHCP Request packets. The Remote ID is defined to be the MAC address of the DHCP Relay device which receives the DHCP Request packets. |
|                         | <b>Drop:</b> Indicates discarding the packets that include the Option 82 field.                                                                                                                                                                                                                                                               |
| Customization           | Select whether to enable Customization of Option 82 or not. When enabled, configure Option 82 information manually.                                                                                                                                                                                                                           |
| Circuit ID              | Enter the customized circuit ID, which contains up to 64 characters. The circuit ID configurations of the switch and the DHCP server should be compatible with each other.                                                                                                                                                                    |
| Remote ID               | Enter the customized remote ID, which contains up to 64 characters. The remote ID configurations of the switch and the DHCP server should be compatible with each other.                                                                                                                                                                      |

3) Click **Apply**.

## 2.1.2 Specifying DHCP Server for the Interface

Choose the menu **Routing > DHCP Relay > DHCP Server** to load the following page.

Figure 2-2 Specify DHCP Server

**Add DHCP Server Address**

Interface ID:  (1-4094)

Server Address:  (Format: 192.168.2.1)

**DHCP Server List**

| Select                 | Interface ID | Server Address |
|------------------------|--------------|----------------|
| No entry in the table. |              |                |

Follow these steps to specify DHCP Server for the interface:

1) In the **Add DHCP Server Address** section, select the interface type and enter the interface ID, and then enter the server address of the interface.

|                |                                                                                                                                                                               |
|----------------|-------------------------------------------------------------------------------------------------------------------------------------------------------------------------------|
| Interface ID   | There are three interface types including <b>Interface VLAN</b> , <b>Loopback</b> and <b>Routed Port</b> . Select an interface type and enter the corresponding interface ID. |
| Server Address | Enter the IP address of the DHCP server.                                                                                                                                      |

2) Click **Create** to specify the DHCP server for the interface.

## 2.2 Using the CLI

### 2.2.1 Enabling DHCP Relay

Follow these steps to enable DHCP Relay:

---

|        |                                              |
|--------|----------------------------------------------|
| Step 1 | <b>configure</b>                             |
|        | Enter global configuration mode.             |
| Step 2 | <b>service dhcp relay</b>                    |
|        | Enable DHCP Relay.                           |
| Step 3 | <b>end</b>                                   |
|        | Return to Privileged EXEC Mode.              |
| Step 4 | <b>copy running-config startup-config</b>    |
|        | Save the settings in the configuration file. |

---

The following example shows how to enable DHCP Relay:

```
Switch#configure
Switch(config)#service dhcp relay
Switch(config)#show ip dhcp relay
DHCP relay is enabled.
.....
Switch(config)#end
Switch#copy running-config startup-config
```

### 2.2.2 Configuring Option 82

Follow these steps to configure Option 82:

---

|        |                                  |
|--------|----------------------------------|
| Step 1 | <b>configure</b>                 |
|        | Enter global configuration mode. |
| Step 2 | <b>ip dhcp relay information</b> |
|        | Enable the Option 82 feature.    |

---

---

|        |                                                                                                                                                                                                                                                                                                                                                                                                           |
|--------|-----------------------------------------------------------------------------------------------------------------------------------------------------------------------------------------------------------------------------------------------------------------------------------------------------------------------------------------------------------------------------------------------------------|
| Step 3 | <b>ip dhcp relay information policy { keep   replace   drop }</b><br>Configure how to process Option 82 information.<br><b>keep:</b> The switch will keep the Option 82 information in the packet.<br><b>replace:</b> The switch will replace the Option 82 information with the customized configurations on the switch.<br><b>drop:</b> The switch will drop the packets carrying Option 82 information |
| Step 4 | <b>ip dhcp relay information custom</b><br>Enable the Customization feature of Option 82.                                                                                                                                                                                                                                                                                                                 |
| Step 5 | <b>ip dhcp relay information circuit-id <i>circuit-id</i></b><br>If the Customization feature is enabled, specify the circuit ID.<br><b><i>circuit-id:</i></b> Specify the circuit ID with 1 to 63 characters including digits, English letters and underlines.                                                                                                                                           |
| Step 6 | <b>ip dhcp relay information remote-id <i>remote-id</i></b><br>If the Customization feature is enabled, specify the remote ID.<br><b><i>remote-id:</i></b> Specify the remote ID with 1 to 32 characters including digits, English letters and underlines.                                                                                                                                                |
| Step 7 | <b>end</b><br>Return to Privileged EXEC Mode.                                                                                                                                                                                                                                                                                                                                                             |
| Step 8 | <b>show ip dhcp relay</b><br>Verify the configuration of DHCP Relay.                                                                                                                                                                                                                                                                                                                                      |
| Step 9 | <b>copy running-config startup-config</b><br>Save the settings in the configuration file.                                                                                                                                                                                                                                                                                                                 |

---

The following example shows how to enable Option 82 and configure the process of Option 82 information as keep:

**Switch#configure**

**Switch(config)#ip dhcp relay information**

**Switch(config)#ip dhcp relay information policy keep**

**Switch(config)#show ip dhcp relay**

.....

DHCP relay option 82 is enabled.

Existed option 82 field operation: keep.

.....

**Switch(config)#end**

**Switch#copy running-config startup-config**

## 2.2.3 Specifying DHCP Server for the Interface

Follow these steps to specify DHCP server for the interface:

---

|        |                                                                                                                                                                                                                                                                                                                                                                                                                                                                                                                                                                                                                                                                                                                                                                                                      |
|--------|------------------------------------------------------------------------------------------------------------------------------------------------------------------------------------------------------------------------------------------------------------------------------------------------------------------------------------------------------------------------------------------------------------------------------------------------------------------------------------------------------------------------------------------------------------------------------------------------------------------------------------------------------------------------------------------------------------------------------------------------------------------------------------------------------|
| Step 1 | <b>configure</b><br>Enter global configuration mode.                                                                                                                                                                                                                                                                                                                                                                                                                                                                                                                                                                                                                                                                                                                                                 |
| Step 2 | Enter Layer 3 interface configuration mode:<br><br><b>interface vlan <i>vid</i></b><br>Enter VLAN interface configuration mode.<br><i>vid</i> : Specify the ID of the VLAN that will be configured as a DHCP relay agent. The valid values are from 1 to 4094.<br><br><b>interface loopback <i>lid</i></b><br>Enter loopback configuration mode.<br><i>lid</i> : Specify the ID of the loopback interface that will be configured as a DHCP relay agent. The valid values are from 1 to 2147483647.<br><br><b>interface { fastEthernet <i>port</i>   gigabitEthernet <i>port</i>   ten-gigabitEthernet <i>port</i> }</b><br><b>no switchport</b><br>Enter Routed Port interface configuration mode.<br><i>port</i> : Specify the ID of the routed port that will be configured as a DHCP relay agent |
| Step 3 | <b>ip helper-address <i>ip-addr</i></b><br>Specify DHCP server for the Layer 3 interface.<br><i>ip-addr</i> : Enter the IP address of the DHCP server.                                                                                                                                                                                                                                                                                                                                                                                                                                                                                                                                                                                                                                               |
| Step 4 | <b>show ip dhcp relay</b><br>Verify the configuration of DHCP Relay.                                                                                                                                                                                                                                                                                                                                                                                                                                                                                                                                                                                                                                                                                                                                 |
| Step 5 | <b>end</b><br>Return to Privileged EXEC Mode.                                                                                                                                                                                                                                                                                                                                                                                                                                                                                                                                                                                                                                                                                                                                                        |
| Step 6 | <b>copy running-config startup-config</b><br>Save the settings in the configuration file.                                                                                                                                                                                                                                                                                                                                                                                                                                                                                                                                                                                                                                                                                                            |

---

The following example shows how to configure the DHCP server address as 192.168.1.7 on VLAN 66:

**Switch#configure**

**Switch(config)#interface vlan 66**

**Switch(config-if)#ip helper-address 192.168.1.7**



```
Switch(config-if)#show ip dhcp relay
```

```
.....
```

DHCP relay helper address is configured on the following interfaces:

| Interface | Helper address |
|-----------|----------------|
|-----------|----------------|

|       |       |
|-------|-------|
| ----- | ----- |
|-------|-------|

|         |             |
|---------|-------------|
| VLAN 66 | 192.168.1.7 |
|---------|-------------|

```
Switch(config-if)#end
```

```
Switch#copy running-config startup-config
```

# 3 Configuration Example

## 3.1 Network Requirements

A company wants to assign IP addresses to all computers in two departments, and there is only one DHCP server available. It is required that computers in the same department should be on the same subnet, while computers in different departments should be on different subnets.

## 3.2 Configuration Scheme

In the given situation, the DHCP relay feature can satisfy the requirement because DHCP relay enables DHCP clients from different subnets to share one DHCP server.

The network topology is as the following figure shows. Computers in the marketing department belong to VLAN 10 which is connected to the switch via port 1/0/8. The interface address of VLAN 10 is 192.168.2.1/24. Computers in the R&D department belong to VLAN 20 which is connected to the switch via port 1/0/16. The interface address of VLAN 20 is 192.168.3.1/24. The DHCP server is connected to the DHCP Relay switch via port 1/0/5, and its IP address is 192.168.0.59/24.

Figure 3-1 Network Topology

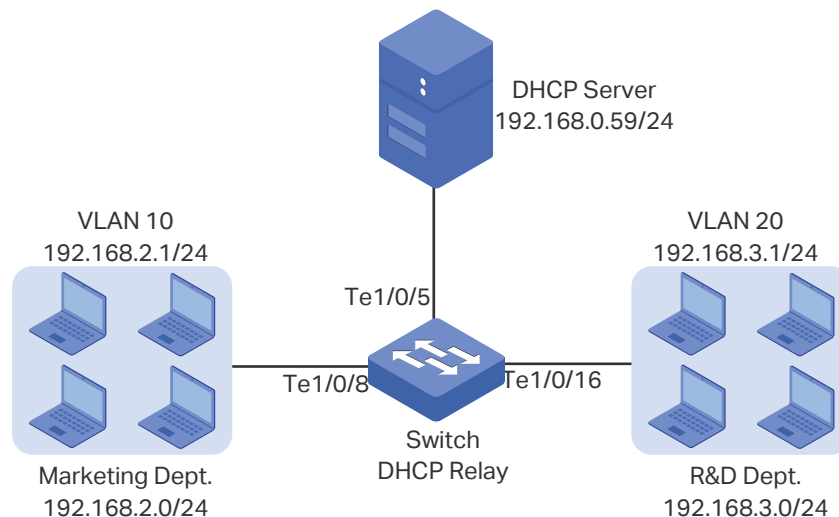

The overview of the configurations are as follows:

- 1) Before DHCP Relay configurations, create two DHCP server pools on the DHCP server, one is on 192.168.2.0/24 and the other is on 192.168.3.0/24. Make sure the DHCP server can reach all DHCP clients.
- 2) Configure 802.1Q VLAN. Add all computers in the marketing department to VLAN 10, and add all computers in the R&D department to VLAN 20. For details, refer to [Configuring 802.1Q VLAN](#).

- 3) Configure the interface address of the VLANs. For details, refer to [Configuring 802.1Q VLAN](#).
- 4) Configure DHCP Relay on the switch. Enable DHCP Relay, and add DHCP server address to each VLAN. When these configurations are finished, the DHCP server can assign IP addresses to computers in the two departments, with each department on one subnet.

Demonstrated with T1700X-16TS, this chapter provides configuration procedures in two ways: using the GUI and using the CLI.

### 3.3 Using the GUI

Follow these steps to configure DHCP Relay:

- 1) Choose the menu **Routing > DHCP Relay > Global Config** to load the following page. In the **Global Config** section, enable DHCP Relay, and click **Apply**.

Figure 3-1 Enable DHCP Relay

**Global Config**

DHCP Relay:  Enable  Disable

**Option 82 Configuration**

Option 82 Support:  Enable  Disable

Existed Option 82 field:  ▼

Customization:  Enable  Disable

Circuit ID:

Remote ID:

- 2) Choose the menu **Routing > DHCP Relay > DHCP Server** to load the following page. In the **Add DHCP Server Address** section, add the DHCP server address to VLAN 10 and VLAN 20.

Figure 3-2 Specify DHCP Server for Interface VLAN 10

**Add DHCP Server Address**

Interface ID:  ▼  (14094)

Server Address:  (Format: 192.168.2.1)

**DHCP Server List**

| Select                 | Interface ID | Server Address |
|------------------------|--------------|----------------|
| No entry in the table. |              |                |

Figure 3-3 Specify DHCP Server for Interface VLAN 20

The screenshot shows a web-based configuration interface. At the top, there is a section titled 'Add DHCP Server Address'. It contains two rows of input fields. The first row is for 'Interface ID', with a dropdown menu set to 'VLAN' and a text box containing '20'. The second row is for 'Server Address', with a text box containing '192.168.0.59'. A 'Create' button is located to the right of the 'Server Address' field. Below this section is a table titled 'DHCP Server List'. The table has three columns: 'Select', 'Interface ID', and 'Server Address'. The table is currently empty, with the text 'No entry in the table.' centered below the header. At the bottom of the table, there are three buttons: 'All', 'Delete', and 'Help'.

- 3) Click **Save Config** to save the settings.

## 3.4 Using the CLI

Follow these steps to configure DHCP Relay:

- 1) Enable DHCP Relay.

```
Switch#configure
```

```
Switch(config)#service dhcp relay
```

- 2) Specify the DHCP server for the interface VLAN 10.

```
Switch(config)#interface vlan 10
```

```
Switch(config-if)#ip helper-address 192.168.0.59
```

```
Switch(config-if)#exit
```

- 3) Specify the DHCP server for interface VLAN 20

```
Switch(config)#interface vlan 20
```

```
Switch(config-if)#ip helper-address 192.168.0.59
```

```
Switch(config-if)#end
```

```
Switch#copy running-config startup-config
```

### Verify the Configurations

```
Switch#show ip dhcp relay
```

DHCP relay helper address is configured on the following interfaces:

| Interface | Helper address |
|-----------|----------------|
| VLAN10    | 192.168.0.59   |
| VLAN20    | 192.168.0.59   |

# 4 Appendix: Default Parameters

Default settings of DHCP Relay are listed in the following table.

Table 4-1 Default Settings of DHCP Relay

| Parameter               | Default Setting |
|-------------------------|-----------------|
| DHCP Relay              |                 |
| DHCP Relay              | Disable         |
| Option 82 Support       | Disable         |
| Existed Option 82 field | Keep            |
| Customization           | Disable         |
| Circuit ID              | None            |
| Remote ID               | None            |
| DHCP Server             |                 |
| Interface ID            | None            |
| Server Address          | None            |

# Part 16

## Configuring ARP

### CHAPTERS

1. Overview
2. ARP Configurations

# 1 Overview

ARP (Address Resolution Protocol) is used to map IP addresses to MAC addresses. Taking an IP address as input, ARP learns the associated MAC address, and stores the IP-MAC address association in an ARP entry for rapid retrieval.

# 2 ARP Configurations

With ARP configurations, you can:

- View dynamic and static ARP entries.
- Add or delete static ARP entries.

## 2.1 Using the GUI

### 2.1.1 Viewing the ARP Entries

The ARP table consists of two kinds of ARP entries: dynamic and static.

- **Dynamic Entry:** Automatically learned and will be deleted after aging time.
- **Static Entry:** Added manually and will be remained unless modified or deleted manually.

Choose the menu **Routing > ARP > ARP Table** to load the following page.

Figure 2-1 Viewing the ARP Entries

| ARP Table |               |                   |         |
|-----------|---------------|-------------------|---------|
| Interface | IP Address    | MAC Address       | Type    |
| Vlan1     | 192.168.0.73  | 00-0a-eb-00-13-01 | DYNAMIC |
| Vlan1     | 192.168.0.18  | 00-0a-eb-13-12-47 | DYNAMIC |
| Vlan1     | 192.168.0.226 | 00-0a-eb-13-23-97 | DYNAMIC |
| Vlan1     | 192.168.0.61  | f4-f2-6d-c3-28-62 | DYNAMIC |
| Vlan1     | 192.168.0.117 | 00-0a-eb-13-12-3e | DYNAMIC |
| Vlan1     | 192.168.0.200 | 00-19-66-35-e1-b0 | DYNAMIC |
| Vlan1     | 192.168.0.37  | 00-0a-eb-13-12-db | DYNAMIC |

|                    |                                                                                                                                                                                             |
|--------------------|---------------------------------------------------------------------------------------------------------------------------------------------------------------------------------------------|
| <b>Interface</b>   | Displays the network interface of an ARP entry.                                                                                                                                             |
| <b>IP Address</b>  | Displays the IP address of an ARP entry.                                                                                                                                                    |
| <b>MAC Address</b> | Displays the MAC address of an ARP entry.                                                                                                                                                   |
| <b>Type</b>        | Displays the type of an ARP entry.<br><br><b>STATIC:</b> A static ARP entry that will always be remained.<br><br><b>DYNAMIC:</b> A dynamic ARP entry that will be deleted after aging time. |



## 2.1.2 Adding Static ARP Entries Manually

You can add desired static ARP entries by manually specifying the IP addresses and MAC addresses.

Choose the menu **Routing > ARP > Static ARP** to load the following page.

Figure 2-2 Adding Static ARP Entries

The screenshot shows the ARP configuration interface. At the top, there is a header 'ARP Config'. Below it, there are two input fields: 'IP address' with the value '192.168.0.5' and a format hint '(Format: 192.168.0.10)', and 'MAC address' with the value '00-0a-eb-13-12-dc' and a format hint '(Format: 00-00-00-00-00-01)'. A 'Create' button is located to the right of the MAC address field. Below this is a table titled 'ARP Table' with three columns: 'Select', 'IP address', and 'MAC address'. The table is currently empty, with a message 'No entry in the table.' centered below it. At the bottom of the table area, there are 'Delete' and 'Help' buttons.

Follow these steps to add static ARP Entries:

In the **ARP Config** section, enter the IP address and MAC address and click **Create**.

|             |                          |
|-------------|--------------------------|
| IP address  | Specify the IP address.  |
| MAC address | Specify the MAC address. |

## 2.2 Using the CLI

### 2.2.1 Configuring ARP Function

- Adding Static ARP Entries

Follow these steps to add ARP entries:

|        |                                                                                                                                                                                                                                                        |
|--------|--------------------------------------------------------------------------------------------------------------------------------------------------------------------------------------------------------------------------------------------------------|
| Step 1 | <b>configure</b><br>Enter global configuration mode.                                                                                                                                                                                                   |
| Step 2 | <b>arp ip mac type</b><br>Add a static ARP entry.<br><br><i>ip</i> : Enter the IP address of the static ARP entry.<br><br><i>mac</i> : Enter the MAC address of the static ARP entry.<br><br><i>type</i> : Enter the ARP type. Configure it as 'arpa'. |

---

Step 3     **show arp** *[ip] [mac]*  
 or  
**show ip arp** *[ip] [mac]*  
 Verify the ARP entries.

*ip*: Specify the IP address of your desired ARP entry.

*mac*: Specify the MAC address of your desired ARP entry.

---

Step 4     **end**  
 Return to privileged EXEC mode.

---

Step 5     **copy running-config startup-config**  
 Save the settings in the configuration file.

---

This example shows how to create a static ARP entry with the IP as 192.168.0.1 and the MAC as 00:11:22:33:44:55:

### Switch#configure

**Switch(config)#arp** 192.168.0.1 00:11:22:33:44:55 **arpa**

**Switch(config)#show arp** 192.168.0.1

| Interface | Address     | Hardware Addr     | Type   |
|-----------|-------------|-------------------|--------|
| Vlan1     | 192.168.0.1 | 00:11:22:33:44:55 | STATIC |

**Switch(config)#end**

**Switch#copy running-config startup-config**

### ■ Configuring the aging time of dynamic ARP entries

Follow these steps to configure the aging time of dynamic ARP entries:

---

Step 1     **configure**  
 Enter global configuration mode.

---

Step 2     **interface** { **fastEthernet** *port* | **range fastEthernet** *port-list* | **gigabitEthernet** *port* | **range gigabitEthernet** *port-list* | **ten-gigabitEthernet** *port* | **range ten-gigabitEthernet** *port-list* }

Enter interface configuration mode.

*port*| *port-list*: The number or the list of the Ethernet port that you want to configure.

**interface vlan** *vlan-id*

Enter interface VLAN mode.

*vlan-id*: Specify a vlan interface ID.

---

---

**Step 3**    **arp timeout *timeout***

Configure the ARP aging time of the VLAN interface or routed port .

*timeout*: Specify the value of aging time, which ranges from 1 to 3000 in seconds. The default value is 600 seconds.

---

**Step 4**    **end**

Return to privileged EXEC mode.

---

**Step 5**    **copy running-config startup-config**

Save the settings in the configuration file.

---

This example shows how to configure the aging time of dynamic ARP entries as 1000 seconds for VLAN interface 2 :

**Switch#configure**

**Switch(config)#interface vlan 2**

**Switch(config-if)#arp timeout 1000**

**Switch(config-if)#end**

**Switch#copy running-config startup-config**

#### ■ Clearing dynamic entries

---

**Step 1**    **end**

Return to privileged EXEC mode.

---

**Step 2**    **clear arp-cache**

Clear all the dynamic ARP entries.

---

**Step 3**    **copy running-config startup-config**

Save the settings in the configuration file.

---

#### ■ Viewing ARP Entries

On privileged EXEC mode or any other configuration mode, you can use the following command to view ARP entries:

---

**show arp [*ip*] [*mac*]**

or

**show ip arp [*ip*] [*mac*]**

Verify the active ARP entries.

*ip*: Specify the IP address of your desired ARP entry.

*mac*: Specify the MAC address of your desired ARP entry.

---

---

**show ip arp { gigabitEthernet *port* | port-channel *lagid* | vlan *id* }**

Verify the active ARP entries associated with a Layer 3 interface.

*port*: Specify the number of the routed port.

*lagid*: Specify the ID of the LAG.

*id*: Specify the VLAN interface ID.

---

# Part 17

## Configuring QoS

### CHAPTERS

1. QoS
2. DiffServ Configuration
3. Bandwidth Control Configuration
4. Configuration Examples
5. Appendix: Default Parameters

# 1 QoS

## 1.1 Overview

With network scale expanding and applications developing, Internet traffic is dramatically increased, thus resulting in network congestion, packet drops and long transmission delay. Typically, networks treat all traffic equally on FIFO (First In First Out) delivery basis, but nowadays many special applications like VoD, video conferences, etc. require more bandwidth or shorter transmission delay to guarantee the performance.

With QoS (Quality of Service) technology, you can classify and prioritize network traffic to provide DiffServ (Differentiated Services) to certain types of traffic.

## 1.2 Supported Features

You can configure the DiffServ and bandwidth control features on the switch to maximize the network performance and bandwidth utilization.

### DiffServ

The switch classifies the ingress packets, maps the packets to different priority queues and then forwards the packets according to specified scheduling algorithms to implement QoS function.

- Priority Mode: Three modes are supported, Port Priority, 802.1P Priority and DSCP Priority.
- Schedule Mode: Four schedule modes are supported, SP, WRR, SP+WRR and Equ.

### Bandwidth Control

Bandwidth Control functions to control the traffic rate and broadcast flow on each port to ensure network performance.

- Rate limit functions to limit the ingress/egress traffic rate on each port. In this way, the network bandwidth can be reasonably distributed and utilized.
- Storm Control function allows the switch to filter broadcast packets, multicast packets and UL-frames (Unknown unicast frames) in the network. If the transmission rate of the packets exceeds the set rate, the packets will be automatically discarded to avoid network broadcast storm.

# 2 DiffServ Configuration

To complete differentiated services configuration, follow these steps:

- 1) Configure the priority mode to classify packets with different priorities.
- 2) Configure the schedule mode to control the forwarding sequence of packets.

## Configuration Guidelines

- Deploy the priority mode appropriate to your network requirements.

Three modes are supported on the switch, 802.1P Priority, DSCP Priority and Port Priority.

### » 802.1P Priority

802.1P defines the first three bits in 802.1Q Tag as PRI field. The PRI values are from 0 to 7. 802.1P priority determines the priority of packets based on the PRI value.

In this mode, the switch only prioritizes packets with VLAN tag, regardless of the IP header of the packets.

### » DSCP Priority

DSCP priority determines the priority of packets based on the ToS (Type of Service) field in their IP header. RFC2474 re-defines the ToS field in the IP packet header as DS field. The first six bits (bit 0-bit 5) of the DS field is used to represent DSCP priority. The DSCP values are from 0 to 63.

In this mode, the switch only prioritizes IP packets.

### » Port Priority

In this mode, the switch prioritizes packets according to their ingress ports, regardless of the packet field or type.

- The switch implements the priority mode in the following sequence when two or more modes are enabled.

Implementing sequence: DSCP Priority > 802.1P Priority > Port Priority

If all the three priority modes are enabled, the switch will distinguish the received packets and map the packets to different priority queues. IP packets are mapped based on DSCP priority mode, non-IP packets with 802.1Q tag are mapped based on 802.1P priority mode, and the untagged non-IP packets are mapped based on port priority mode.

## 2.1 Using the GUI

### 2.1.1 Configuring Priority Mode

The instructions of the three priority modes are described respectively in this section.

- **Configuring 802.1P Priority**

Choose the menu **QoS > DiffServ > 802.1P Priority** to load the following page.

Figure 2-1 802.1P/CoS Mapping

| Priority and CoS-mapping Config |               |                        |
|---------------------------------|---------------|------------------------|
| Select                          | Tag-id/CoS-id | Queue TC-id            |
| <input type="checkbox"/>        |               | <input type="text"/> ▼ |
| <input type="checkbox"/>        | 0             | TC1                    |
| <input type="checkbox"/>        | 1             | TC0                    |
| <input type="checkbox"/>        | 2             | TC2                    |
| <input type="checkbox"/>        | 3             | TC3                    |
| <input type="checkbox"/>        | 4             | TC4                    |
| <input type="checkbox"/>        | 5             | TC5                    |
| <input type="checkbox"/>        | 6             | TC6                    |
| <input type="checkbox"/>        | 7             | TC7                    |

Follow these steps to configure the 802.1P Priority:

- 1) Configure the Tag-id/CoS-id-TC mapping relations.

**Tag-id/CoS-id** Select the desired Tag-id/CoS-id to configure.

Tag-id indicates the PRI field in 802.1Q tag. It comprises 3 bits and the valid values are from 0 to 7.

CoS-id is a value for the switch to establish mapping relations between the priorities and TC queues. The valid values are from 0 to 7 and correspond to the 802.1P priority levels.

**TC-id** Select a TC queue that you want the Tag-id or CoS-id to be mapped to.

The switch supports 8 TC queues, from TC0 for the lowest priority to TC 7 for the highest priority.

- 2) Click **Apply**.



■ **Configuring DSCP Priority**

 **Note:**

In DSCP priority mode, the packets are firstly mapped to CoS queues, then to TC queues according to the CoS-id-TC mapping relations. Go to **QoS > DiffServ > 802.12P Priority** and check the CoS-id-TC mapping relations before configuring DSCP priority.

Choose the menu **QoS > DiffServ > DSCP Priority** to load the following page.

Figure 2-2 DSCP Mapping

**DSCP Priority Config**

DSCP Priority:       Enable    Disable      Apply

| Priority level           |      |          |
|--------------------------|------|----------|
| Select                   | DSCP | Priority |
| <input type="checkbox"/> |      | [ ] ▾    |
| <input type="checkbox"/> | 0    | COS0     |
| <input type="checkbox"/> | 1    | COS0     |
| <input type="checkbox"/> | 2    | COS0     |
| <input type="checkbox"/> | 3    | COS0     |
| <input type="checkbox"/> | 4    | COS0     |
| <input type="checkbox"/> | 5    | COS0     |
| <input type="checkbox"/> | 6    | COS0     |
| <input type="checkbox"/> | 7    | COS0     |
| <input type="checkbox"/> | 8    | COS1     |
| <input type="checkbox"/> | 9    | COS1     |

All
Apply
Help

Follow these steps to configure the DSCP priority:

- 1) Enable DSCP Priority and click **Apply**. DSCP Priority is disabled by default.
- 2) Configure the DSCP-TC mapping relations.

|                 |                                                                                                                                                                                                                                                                                                                                                 |
|-----------------|-------------------------------------------------------------------------------------------------------------------------------------------------------------------------------------------------------------------------------------------------------------------------------------------------------------------------------------------------|
| <b>DSCP</b>     | Select the desired DSCP priority.<br><br>DSCP priority represents the DSCP field in the IP packet header. It comprises 6 bits and the valid values are from 0 to 63.<br><br><i>Note:</i><br>The DSCP priority displayed on this page may indicate the DSCP value included in the packets or the redefined DSCP value by the ACL Remark feature. |
| <b>Priority</b> | Select a CoS queue that the DSCP priority will be mapped to.<br><br>The packets are firstly mapped to CoS queues, then to TC queues according to the CoS-id-TC mapping relations.                                                                                                                                                               |

- 3) Click **Apply**.

■ **Configuring Port Priority**

 **Note:**

In port priority mode, the packets are firstly mapped to CoS queues, then to TC queues according to the CoS-id-TC mapping relations. Go to **QoS > DiffServ > 802.12P Priority** and check the CoS-id-TC mapping relations before configuring port priority.

Choose the menu **QoS > DiffServ > Port Priority** to load the following page.

Figure 2-3 Port Priority

| Port Priority Config     |        |                                 |     |  |
|--------------------------|--------|---------------------------------|-----|--|
| UNIT:                    |        | 1 LAGS                          |     |  |
| Select                   | Port   | Priority                        | LAG |  |
| <input type="checkbox"/> |        | <input type="text" value=""/> ▼ |     |  |
| <input type="checkbox"/> | 1/0/1  | COS 0                           | --- |  |
| <input type="checkbox"/> | 1/0/2  | COS 0                           | --- |  |
| <input type="checkbox"/> | 1/0/3  | COS 0                           | --- |  |
| <input type="checkbox"/> | 1/0/4  | COS 0                           | --- |  |
| <input type="checkbox"/> | 1/0/5  | COS 0                           | --- |  |
| <input type="checkbox"/> | 1/0/6  | COS 0                           | --- |  |
| <input type="checkbox"/> | 1/0/7  | COS 0                           | --- |  |
| <input type="checkbox"/> | 1/0/8  | COS 0                           | --- |  |
| <input type="checkbox"/> | 1/0/9  | COS 0                           | --- |  |
| <input type="checkbox"/> | 1/0/10 | COS 0                           | --- |  |
| <input type="checkbox"/> | 1/0/11 | COS 0                           | --- |  |
| <input type="checkbox"/> | 1/0/12 | COS 0                           | --- |  |
| <input type="checkbox"/> | 1/0/13 | COS 0                           | --- |  |
| <input type="checkbox"/> | 1/0/14 | COS 0                           | --- |  |
| <input type="checkbox"/> | 1/0/15 | COS 0                           | --- |  |

Follow these steps to configure the port priority:

- 1) Select the desired port or LAG to set its priority.

|                 |                                                                                                                                                                             |
|-----------------|-----------------------------------------------------------------------------------------------------------------------------------------------------------------------------|
| <b>Priority</b> | Specify the CoS queue that the port will be mapped to.<br><br>The packets are firstly mapped to CoS queues, then to TC queues according to the CoS-id-TC mapping relations. |
| <b>LAG</b>      | Displays the aggregation group which the port is in.                                                                                                                        |

- 2) Click **Apply**.

 **Note:**

All the ports in the same LAG should be assigned with the same port priority.

## 2.1.2 Configuring Schedule Mode

Configure the schedule mode to control the forwarding sequence of different TC queues when congestion occurs.

Choose the menu **QoS > DiffServ > Schedule Mode** to load the following page.

Figure 2-4 Schedule Mode

**Schedule Mode Config**

Schedule Mode:

Queue Weight:

TC0:

TC1:

TC2:

TC3:

TC4:

TC5:

TC6:

TC7:

Follow these steps to configure the schedule mode:

- 1) Select a schedule mode.

|                    |                                                                                                                                                                                                                                                                                                                                                                                                                                                                  |
|--------------------|------------------------------------------------------------------------------------------------------------------------------------------------------------------------------------------------------------------------------------------------------------------------------------------------------------------------------------------------------------------------------------------------------------------------------------------------------------------|
| <b>SP-Mode</b>     | Strict-Priority Mode. In this mode, the queue with higher priority will occupy the whole bandwidth. Packets in the queue with lower priority are sent only when the queue with higher priority is empty.                                                                                                                                                                                                                                                         |
| <b>WRR-Mode</b>    | Weight Round Robin Mode. In this mode, packets in all the queues are sent in order based on the weight value for each queue. By default, the weight value ratio of TC0 to TC7 is 1:2:4:....:2 <sup>7</sup> .                                                                                                                                                                                                                                                     |
| <b>SP+WRR-Mode</b> | Strict-Priority + Weight Round Robin Mode. In this mode, the switch provides two scheduling groups, SP group and WRR group.<br><br>When scheduling queues, the switch allows the queues in the SP group to occupy the whole bandwidth following the SP mode. When the SP group is empty, the queues in the WRR group will take up the bandwidth according to their weight value ratio. By default, queue TC7 is in SP group and TC0, TC1...TC6 are in WRR group. |
| <b>Equ-Mode</b>    | Equal-Mode. In this mode, all the queues occupy the bandwidth equally. The weight value ratio of all the queues is 1:1:1:1. Equ-Mode is selected by default.                                                                                                                                                                                                                                                                                                     |

- 2) (Optional) Configure the weight value of the each TC queue if the schedule mode is WRR or SP+WRR.

**Queue Weight**

Configure the weight value of the each TC queue.

In WRR mode, the 8 queues will take up the bandwidth according to their ratio. The default values of TC0, TC1, TC2, TC3, TC4, TC5, TC6 and TC7 are 1, 2, 4, 8, 16, 32, 64 and 127 respectively.

In SP+WRR mode, TC7 and the queue with its weight value set as 0 are in the SP group; other queues, with none-zero weight value, belong to the WRR group. In this SP+WRR scheduling mode, the queues in the SP group is scheduled preferentially (TC7>TC6>TC5>TC4>TC3>TC2>TC1>TC0 in strict priority). When there is no packets to be sent in the SP group, the queues in the WRR group will be scheduled according to the weight value of each queue. The default weight values of TC0, TC1, TC2, TC3, TC4, TC5 and TC6 are 1, 2, 4, 8, 16, 32 and 64 respectively, while the value of TC7 is 0 and non-configurable.

3) Click **Apply**. **Note:**

With ACL Redirect feature, the switch maps all the packets that meet the configured ACL rules to the new TC queue, regardless of the mapping relations configured in this section.

## 2.2 Using CLI

### 2.2.1 Configuring Priority Mode

The instructions of the three priority modes are described respectively in this section.

- **Configuring 802.1 Priority**

Step 1

**configure**

Enter global configuration mode

Step 3

**qos queue cos-map *{tag-id|cos-id}* *{tc-id}***

Configure the Tag-id-TC queues mapping relations or the CoS-id-TC mapping relations.

*tag-id*: Specify the Tag-ID. The valid values are from 0 to 7.

*cos-id*: Specify the CoS-ID. The valid values are from 0 to 7.

*tc-id*: Specify the TC-ID. The valid values are from 0 to 7.

Step 4

**show qos status**

Verify that 802.1P priority is enabled.

**show qos cos-map**

Verify the mapping relations between the Tag-id / CoS-id and TC queues.

Step 5

**end**

Return to privileged EXEC mode.

- 
- Step 6     **copy running-config startup-config**  
Save the settings in the configuration file.
- 

The following example shows how to map CoS2 to TC0, and keep other CoS-id-TC as default:

**Switch#configure**

**Switch(config)#qos queue cos-map 2 0**

**Switch(config)#show qos status**

802.1p priority is enabled.

DSCP priority is disabled.

**Switch(config)#show qos cos-map**

```

-----+-----+-----+-----+-----+-----+-----+-----+-----+-----
Tag |0   |1   |2   |3   |4   |5   |6   |7
-----+-----+-----+-----+-----+-----+-----+-----+-----
TC  |TC1 |TC0 |TC0 |TC3 |TC4 |TC5 |TC6 |TC7
-----+-----+-----+-----+-----+-----+-----+-----+-----

```

**Switch(config)#end**

**Switch#copy running-config startup-config**

#### ■ Configuring DSCP Priority

- 
- Step 1     **configure**  
Enter global configuration mode.
- 
- Step 2     **qos dscp**  
Enable DSCP Priority.
- 
- Step 3     **show qos cos-map**  
Check the CoS-id-TC mapping relations.
- 
- Step 4     **qos queue dscp-map {dscp-list} {cos-id}**  
Configure the mapping relations between the DSCP values in the IP header and the CoS values. The packets are firstly mapped to CoS queues, then to TC queues according to the CoS-id-TC mapping relations.  
*dscp-list*: Enter one or more DSCP values which range from 0 to 63. Enter the multiple values in the format of "1-3,5,7".  
*cos-id*: Specify the CoS-id. The valid values are from 0 to 7.
-

Step 5 **show qos status**  
Verify that DSCP priority is enabled.

**show qos dscp-map**

Verify the DSCP-TC mapping relations.

Step 6 **end**  
Return to privileged EXEC mode.

Step 7 **copy running-config startup-config**  
Save the settings in the configuration file.

The following example shows how to map DSCP values 10-14 to TC1, and keep other mapping relations as default:

**Switch#configure**

**Switch(config)#show qos cos-map**

```
-----+-----+-----+-----+-----+-----+-----+-----+-----+
Tag |0  |1  |2  |3  |4  |5  |6  |7
-----+-----+-----+-----+-----+-----+-----+-----+
TC  |TC1|TC0|TC0|TC3|TC4|TC5|TC6|TC7
-----+-----+-----+-----+-----+-----+-----+-----+

```

**Switch(config)#qos queue dscp-map 10-14 0**

**Switch(config)#show qos status**

802.1p priority is disabled.

DSCP priority is enabled.

**Switch(config)#show qos dscp-map**

...

```
-----+-----+-----+-----+-----+-----+-----+-----+-----+
DSCP 8    9    10   11   12   13   14   15
CoS   CoS1 CoS1 CoS0 CoS0 CoS0 CoS0 CoS0 CoS1
-----+-----+-----+-----+-----+-----+-----+-----+

```

...

**Switch(config)#end**

**Switch#copy running-config startup-config**

## ■ Configuring Port Priority

Select the desired port to set the priority. Packets from this ingress port are mapped to the TC queue based on port priority.

|        |                                                                                                                                                                                                                                                                                                                                         |
|--------|-----------------------------------------------------------------------------------------------------------------------------------------------------------------------------------------------------------------------------------------------------------------------------------------------------------------------------------------|
| Step 1 | <b>configure</b><br>Enter global configuration mode.                                                                                                                                                                                                                                                                                    |
| Step 2 | <b>interface {fastEthernet <i>port</i>   range fastEthernet <i>port-list</i>   gigabitEthernet <i>port</i>   range gigabitEthernet <i>port-list</i>}</b><br>Enter interface configuration mode.                                                                                                                                         |
| Step 3 | <b>show qos cos-map</b><br>Check the CoS-id-TC mapping relations.                                                                                                                                                                                                                                                                       |
| Step 4 | <b>qos <i>cos-id</i></b><br>Configure the CoS value of the port. The packets are firstly mapped to CoS queues, then to TC queues according to the CoS-id-TC mapping relations.<br><br><i>cos-id</i> : Configure the CoS-id value. The valid values are from 0 to 7.                                                                     |
| Step 5 | <b>show qos interface [fastEthernet <i>port-list</i>   gigabitEthernet <i>port-list</i>] [port-channel <i>lagid-list</i>]</b><br>Verify the CoS value of the port. If no port is specified, it displays the CoS values of all ports.<br><br><i>port-list</i> : The list of Ethernet ports.<br><br><i>lagid-list</i> : The list of LAGs. |
| Step 6 | <b>end</b><br>Return to privileged EXEC mode.                                                                                                                                                                                                                                                                                           |
| Step 7 | <b>copy running-config startup-config</b><br>Save the settings in the configuration file.                                                                                                                                                                                                                                               |

### Note:

All the ports in the same LAG should be assigned with the same port priority.

The following example shows how to map port 1-3 to TC1, and keep other mapping relations as default:

**Switch#configure**

```
Switch(config)#show qos cos-map
```

```
-----+-----+-----+-----+-----+-----+-----+-----+-----
Tag|0   |1   |2   |3   |4   |5   |6   |7
-----+-----+-----+-----+-----+-----+-----+-----+-----
TC |TC1 |TC0 |TC2 |TC3 |TC4 |TC5 |TC6 |TC7
-----+-----+-----+-----+-----+-----+-----+-----+-----
```

```
Switch(config)#interface range ten-gigabitEthernet 1/0/1-3
```

```
Switch(config-if-range)#qos 0
```

```
Switch(config-if-range)#show qos interface ten-gigabitEthernet 1/0/1-3
```

| Port    | CoS Value | LAG |
|---------|-----------|-----|
| Te1/0/1 | CoS 0     | N/A |
| Te1/0/2 | CoS 0     | N/A |
| Te1/0/3 | CoS 0     | N/A |

```
Switch(config-if-range)#end
```

```
Switch#copy running-config startup-config
```

## 2.2.2 Configuring Schedule Mode

Follow these steps to configure the schedule mode to control the forwarding sequence of different TC queues when congestion occurs.

- 
- Step 1     **configure**  
           Enter global configuration mode.
-



---

**Step 2** **qos queue mode {sp | wrr | sp+wrr | equ}**

Configure the schedule mode of TC queues.

**sp:** The Strick Priority mode. In SP mode, the queue with higher priority will occupy the whole bandwidth. Packets in the queue with lower priority are sent only when the queue with higher priority is empty.

**wrr:** In WRR mode, packets in all the queues are sent in order based on the weight value for each queue. By default, the weight value ratio of TC0 to TC7 is 1:2:4:....:2<sup>7</sup>.

**sp+wrr:** In SP+WRR mode, this switch provides two scheduling groups, SP group and WRR group. When scheduling queues, the switch allows the queues in the SP group to occupy the whole bandwidth following the SP mode. When the SP group is empty, the queues in the WRR group will take up the bandwidth according to their weight value ratio. By default, queue TC7 is in SP and TC0, TC1...TC6 are in WRR group.

**equ:** In Equ mode, all the queues occupy the bandwidth equally. The weight value ratio of all the queues is 1:1:1:1. It is the default schedule mode.

---

**Step 3** **qos queue weight { tc-id } { weight-value }**

(Optional) Configure the weight value of each queue after the Schedule Mode is specified as WRR or SP+WRR.

**tc-id:** Specify the TC-ID. The valid values are from 0 to 7.

**weight-value:** Configure the weight value of the specified TC queue.

When the schedule mode is specified as WRR, the valid weight value are from 1 to 127. The 8 queues will take up the bandwidth according to their ratio. The default values of TC0, TC1, TC2, TC3, TC4, TC5,TC6 and TC7 are 1, 2, 4, 8, 16, 32, 64 and 127 respectively.

When the schedule mode is specified as SP+WRR, The valid weight values are from 0 to 127. TC7 and the queue with its weight value set as 0 are in the SP group; other queues, with none-zero weight value, belong to the WRR group. In this SP+WRR scheduling mode, the queues in the SP group is scheduled preferentially (TC6>TC5>TC4>TC3>TC2>TC1>TC0 in strict priority). When there is no packets to be sent in the SP group, the queues in the WRR group will be scheduled according to the weight value of each queue. The default weight values of TC0, TC1, TC2, TC3, TC4, TC5 and TC6 are 1, 2, 4, 8, 16, 32 and 64 respectively, while the value of TC7 is 0 and non-configurable.

---

**Step 4** **show qos queue mode**

Verify the schedule mode configurations.

---

**Step 5** **end**

Return to privileged EXEC mode.

---

**Step 6** **copy running-config startup-config**

Save the settings in the configuration file.

---

 **Note:**

With ACL Redirect feature, the switch maps all the packets that meet the configured ACL rules to the new TC queue, regardless of the mapping relations configured in this section.

---

The following example shows how to configure the schedule mode as WRR, with the weight values of TC0 to TC7 as 4, 7, 10, 13,16,19,22,25:

```
Switch#configure
```

```
Switch(config)#qos queue mode wrr
```

```
Switch(config)#qos queue weight 0 4
```

```
Switch(config)#qos queue weight 1 7
```

```
Switch(config)#qos queue weight 2 10
```

```
Switch(config)#qos queue weight 3 13
```

```
Switch(config)#qos queue weight 4 16
```

```
Switch(config)#qos queue weight 5 19
```

```
Switch(config)#qos queue weight 6 22
```

```
Switch(config)#qos queue weight 7 25
```

```
Switch(config)#show qos queue mode
```

```
-----+-----  
Schedule Mode: WRR | Weight: TC0=4 TC1=7 TC2=10 TC3=13 TC4=16 TC5=19  
TC6=22 TC7=25  
-----+-----
```

```
Switch(config)#end
```

```
Switch#copy running-config startup-config
```

# 3 Bandwidth Control Configuration

To implement bandwidth control, you can:

- Limit the ingress/egress traffic rate on each port by configuring the Rate Limit function;
- Limit the broadcast, multicast and UL frame forwarding rate on each port to avoid network broadcast storm by configuring the Storm Control function.

## 3.1 Using the GUI

### 3.1.1 Configuring Rate Limit

Choose the menu **QoS > Bandwidth Control > Rate Limit** to load the following page.

Figure 3-1 Rate Limit

| Rate Limit Config        |        |                             |                            |     |
|--------------------------|--------|-----------------------------|----------------------------|-----|
| UNIT: 1 LAGS             |        |                             |                            |     |
| Select                   | Port   | Ingress Rate(1-1000000Kbps) | Egress Rate(1-1000000Kbps) | LAG |
| <input type="checkbox"/> |        | <input type="text"/>        | <input type="text"/>       |     |
| <input type="checkbox"/> | 1/0/1  | ---                         | ---                        | --- |
| <input type="checkbox"/> | 1/0/2  | ---                         | ---                        | --- |
| <input type="checkbox"/> | 1/0/3  | ---                         | ---                        | --- |
| <input type="checkbox"/> | 1/0/4  | ---                         | ---                        | --- |
| <input type="checkbox"/> | 1/0/5  | ---                         | ---                        | --- |
| <input type="checkbox"/> | 1/0/6  | ---                         | ---                        | --- |
| <input type="checkbox"/> | 1/0/7  | ---                         | ---                        | --- |
| <input type="checkbox"/> | 1/0/8  | ---                         | ---                        | --- |
| <input type="checkbox"/> | 1/0/9  | ---                         | ---                        | --- |
| <input type="checkbox"/> | 1/0/10 | ---                         | ---                        | --- |
| <input type="checkbox"/> | 1/0/11 | ---                         | ---                        | --- |
| <input type="checkbox"/> | 1/0/12 | ---                         | ---                        | --- |

Follow these steps to configure the Rate Limit function:

- 1) Configure the upper rate limit for the port to receive and send packets.

|                              |                                                                                                                |
|------------------------------|----------------------------------------------------------------------------------------------------------------|
| Ingress Rate (1-1000000Kbps) | Configure the upper rate limit for receiving packets on the port. The valid values are from 1 to 1000000 Kbps. |
|------------------------------|----------------------------------------------------------------------------------------------------------------|

|                             |                                                                                                       |
|-----------------------------|-------------------------------------------------------------------------------------------------------|
| Egress Rate (1-1000000Kbps) | Configure the bandwidth for sending packets on the port. The valid values are from 1 to 1000000 Kbps. |
|-----------------------------|-------------------------------------------------------------------------------------------------------|

**LAG** Displays the aggregation group which the port is in.

2) Click **Apply**.

### 3.1.2 Configuring Storm Control

Choose the menu **QoS > Bandwidth Control > Storm Control** to load the following page.

Figure 3-2 Storm Control

| Storm Control Config     |        |                               |                               |                               |                               |                               |                               |                               |     |
|--------------------------|--------|-------------------------------|-------------------------------|-------------------------------|-------------------------------|-------------------------------|-------------------------------|-------------------------------|-----|
| UNIT: 1 LAGS             |        |                               |                               |                               |                               |                               |                               |                               |     |
| Select                   | Port   | PPS                           | Broadcast Rate Mode           | Broadcast                     | Multicast Rate Mode           | Multicast                     | UL-Frame Rate Mode            | UL-Frame                      | LAG |
| <input type="checkbox"/> |        | <input type="text" value=""/> | <input type="text" value=""/> | <input type="text" value=""/> | <input type="text" value=""/> | <input type="text" value=""/> | <input type="text" value=""/> | <input type="text" value=""/> |     |
| <input type="checkbox"/> | 1/0/1  | Disable                       | kbps                          | ---                           | kbps                          | ---                           | kbps                          | ---                           | --- |
| <input type="checkbox"/> | 1/0/2  | Disable                       | kbps                          | ---                           | kbps                          | ---                           | kbps                          | ---                           | --- |
| <input type="checkbox"/> | 1/0/3  | Disable                       | kbps                          | ---                           | kbps                          | ---                           | kbps                          | ---                           | --- |
| <input type="checkbox"/> | 1/0/4  | Disable                       | kbps                          | ---                           | kbps                          | ---                           | kbps                          | ---                           | --- |
| <input type="checkbox"/> | 1/0/5  | Disable                       | kbps                          | ---                           | kbps                          | ---                           | kbps                          | ---                           | --- |
| <input type="checkbox"/> | 1/0/6  | Disable                       | kbps                          | ---                           | kbps                          | ---                           | kbps                          | ---                           | --- |
| <input type="checkbox"/> | 1/0/7  | Disable                       | kbps                          | ---                           | kbps                          | ---                           | kbps                          | ---                           | --- |
| <input type="checkbox"/> | 1/0/8  | Disable                       | kbps                          | ---                           | kbps                          | ---                           | kbps                          | ---                           | --- |
| <input type="checkbox"/> | 1/0/9  | Disable                       | kbps                          | ---                           | kbps                          | ---                           | kbps                          | ---                           | --- |
| <input type="checkbox"/> | 1/0/10 | Disable                       | kbps                          | ---                           | kbps                          | ---                           | kbps                          | ---                           | --- |
| <input type="checkbox"/> | 1/0/11 | Disable                       | kbps                          | ---                           | kbps                          | ---                           | kbps                          | ---                           | --- |
| <input type="checkbox"/> | 1/0/12 | Disable                       | kbps                          | ---                           | kbps                          | ---                           | kbps                          | ---                           | --- |

Follow these steps to configure the Storm Control function:

1) Select the port(s) and configure the upper rate limit for forwarding broadcast packets, multicast packets and UL frames.

**PPS** Enable or disable the PPS (Packets Per Second) mode on the port.

With PPS enabled, the upper rate limit of the broadcast, multicast and UL-frame can only be specified in packets per second. With PPS disabled, the upper rate limit of the broadcast, multicast and UL-frame cannot be specified in packets per second.

**Broadcast Rate Mode / Broadcast** To enable the broadcast rate control, select a broadcast rate mode and specify the upper rate limit for receiving broadcast packets in the **Broadcast** field. The packet traffic exceeding the rate will be discarded.

The switch supports the following three rate modes:

**kbps:** Specify the upper rate limit in kilo-bits per second, which ranges from 1 to 1000000 kbps. This mode is invalid if **PPS** is enabled.

**ratio:** Specify the upper rate limit as a percentage of the bandwidth, which ranges from 1 to 100 percent. This mode is invalid if **PPS** is enabled.

**pps:** Specify the upper rate limit in packets per second, which ranges from 1 to 1488000 packets per second. This mode is invalid if **PPS** is disabled.

To disable the broadcast rate control, select **Disable** in the **Broadcast** field.

|                                 |                                                                                                                                                                                                                                                                                                                                                                                                                                                                                                                                                                                                                                                                                                                                                                                                                                                                                                                     |
|---------------------------------|---------------------------------------------------------------------------------------------------------------------------------------------------------------------------------------------------------------------------------------------------------------------------------------------------------------------------------------------------------------------------------------------------------------------------------------------------------------------------------------------------------------------------------------------------------------------------------------------------------------------------------------------------------------------------------------------------------------------------------------------------------------------------------------------------------------------------------------------------------------------------------------------------------------------|
| Multicast Rate Mode / Multicast | <p>To enable the multicast rate control, select a multicast rate mode and specify the upper rate limit for receiving broadcast packets in the <b>Multicast</b> field. The packet traffic exceeding the rate will be discarded.</p> <p>The switch supports the following three rate modes:</p> <p><b>kbps:</b> Specify the upper rate limit in kilo-bits per second, which ranges from 1 to 1000000 kbps. This mode is invalid if <b>PPS</b> is enabled.</p> <p><b>ratio:</b> Specify the upper rate limit as a percentage of the bandwidth, which ranges from 1 to 100 percent. This mode is invalid if <b>PPS</b> is enabled.</p> <p><b>pps:</b> Specify the upper rate limit in packets per second, which ranges from 1 to 1488000 packets per second. This mode is invalid if <b>PPS</b> is disabled.</p> <p>To disable the multicast rate control, select <b>Disable</b> in the <b>Multicast</b> field.</p>     |
| UL-Frame Rate Mode / UL-Frame   | <p>To enable the UL-Frame (Unknown unicast frame) rate control, select a UL-Frame rate mode and specify the upper rate limit for receiving UL-Frames in the <b>UL-Frame</b> field. The packet traffic exceeding the rate will be discarded. The switch supports the following three rate modes:</p> <p><b>kbps:</b> Specify the upper rate limit in kilo-bits per second, which ranges from 1 to 1000000 kbps. This mode is invalid if <b>PPS</b> is enabled.</p> <p><b>ratio:</b> Specify the upper rate limit as a percentage of the bandwidth, which ranges from 1 to 100 percent. This mode is invalid if <b>PPS</b> is enabled.</p> <p><b>pps:</b> Specify the upper rate limit in packets per second, which ranges from 1 to 1488000 packets per second. This mode is invalid if <b>PPS</b> is disabled.</p> <p>To disable the UL-Frame rate control, select <b>Disable</b> in the <b>UL-Frame</b> field.</p> |
| LAG                             | Displays the aggregation group which the port is in.                                                                                                                                                                                                                                                                                                                                                                                                                                                                                                                                                                                                                                                                                                                                                                                                                                                                |

2) Click **Apply**.

#### Note:

- For ports in the same LAG, rate limit / storm control should be set to the same value to ensure a successful port aggregation.
- For one port, you cannot enable the Storm Control and the Rate limit at the same time.

## 3.2 Using the CLI

### 3.2.1 Configuring Rate Limit on Port

Configure the upper rate limit for the port to receive and send packets.

|        |                                                                 |
|--------|-----------------------------------------------------------------|
| Step 1 | <p><b>configure</b></p> <p>Enter global configuration mode.</p> |
|--------|-----------------------------------------------------------------|

- 
- Step 2    **interface {fastEthernet *port* | range fastEthernet *port-list* | gigabitEthernet *port* | range gigabitEthernet *port-list*}**  
Enter interface configuration mode.
- 
- Step 3    **bandwidth {[ingress *ingress-rate*] [egress *egress-rate*]}**  
Configure the upper rate limit for the port to receive and send packets.  
  
*ingress-rate*: Configure the upper rate limit for receiving packets on the port. The valid values are from 1 to 1000000 Kbps.  
  
*egress-rate*: Configure the upper rate limit for sending packets on the port. The valid values are from 1 to 1000000 Kbps.
- 
- Step 4    **show bandwidth {interface [fastEthernet *port* | range fastEthernet *port-list* | gigabitEthernet *port* | range gigabitEthernet *port-list*]}**  
Verify the ingress/egress rate limit for forwarding packets on the port. If no port is specified, it displays the upper ingress/egress rate limit for all ports.
- 
- Step 5    **end**  
Return to privileged EXEC mode.
- 
- Step 6    **copy running-config startup-config**  
Save the settings in the configuration file.
- 

The following example shows how to configure the ingress-rate as 5120 Kbps and egress-rate as 1024 Kbps for port 1/0/5:

**Switch#configure**

**Switch(config)#interface ten-gigabitEthernet 1/0/5**

**Switch(config-if)#bandwidth ingress 5120 egress 1024**

**Switch(config-if)#show bandwidth interface ten-gigabitEthernet 1/0/5**

| Port    | IngressRate(Kbps) | EgressRate(Kbps) | LAG   |
|---------|-------------------|------------------|-------|
| -----   | -----             | -----            | ----- |
| Te1/0/5 | 5120              | 1024             | N/A   |

**Switch(config-if)#end**

**Switch#copy running-config startup-config**

### 3.2.2 Configuring Storm Control

Configure the upper rate limit on the port for forwarding broadcast packets, multicast packets and unknown unicast frames.

- 
- Step 1    **configure**  
Enter global configuration mode
-

- 
- Step 2 **interface {fastEthernet *port* | range fastEthernet *port-list* | gigabitEthernet *port* | range gigabitEthernet *port-list*}**
- Enter interface configuration mode.
- 
- Step 3 Use the following commands to specify the upper rate limit of the broadcast packets, multicast packets and unknown unicast frames in pps:
- storm-control pps**
- Configure the storm control mode as pps (packets per second) on the port. In PPS mode, the upper rate limit of the broadcast packets, multicast packets and unknown unicast frames can only be specified in packets per second.
- storm-control {broadcast | multicast | unicast} pps *rate***
- broadcast | multicast | unicast:** Enable broadcast rate limit, multicast rate limit or unknown unicast rate limit on the port.
- rate:*** Specify the upper rate limit for receiving broadcast packets, multicast packets and unknown unicast frames on the port. The packet traffic exceeding the rate will be discarded. The valid rate values are from 1 to 1488000 packets per second.
- Use the following commands to specify the upper rate limit of the broadcast packets, multicast packets and unknown unicast frames in kbps or ratio:
- no storm-control pps**
- Ensure the pps mode is disabled on the port.
- storm-control {broadcast | multicast | unicast} {kbps | ratio} *rate***
- broadcast | multicast | unicast:** Enable broadcast packets rate limit, multicast packets rate limit or unknown unicast frames rate limit on the port.
- kbps:*** Configure the storm control mode as kbps. In this mode, the upper rate limit is specified in kilo-bits per second.
- ratio:*** Configure the storm control mode as ratio. In this mode, the upper rate limit is specified as a percentage of the bandwidth.
- rate:*** Specify the upper rate limit for receiving broadcast packets, multicast packets and unknown unicast frames on the port. The packet traffic exceeding the rate will be discarded. For kbps, the valid rate values are from 1 to 1000000 kbps; for ratio, the valid rate values are from 1 to 100 percent.
- 
- Step 4 **show storm-control {interface [fastEthernet *port* | range fastEthernet *port-list* | gigabitEthernet *port* | range gigabitEthernet *port-list*]}**
- Verify the storm control configurations of the port. If no port is specified, it displays the storm control configuration for all ports.
- 
- Step 5 **end**
- Return to privileged EXEC mode.
- 
- Step 6 **copy running-config startup-config**
- Save the settings in the configuration file.
-

The following example shows how to configure the upper rate limit of broadcast packets as 148800 pps on port 1/0/5:

**Switch#configure**

**Switch(config)#interface ten-gigabitEthernet 1/0/5**

**Switch(config-if)#storm-control pps**

**Switch(config-if)#storm-control broadcast pps 148800**

**Switch(config-if)#show storm-control interface ten-gigabitEthernet 1/0/5**

| Port    | BcRate     | Mcate | UIRate | LAG   |
|---------|------------|-------|--------|-------|
| -----   | -----      | ----- | -----  | ----- |
| Te1/0/5 | pps 148800 | pps 0 | pps 0  | N/A   |

**Switch(config-if)#end**

**Switch#copy running-config startup-config**

The following example shows how to configure the upper rate limit of broadcast packets as 10240 kbps on port 1/0/5:

**Switch#configure**

**Switch(config)#interface ten-gigabitEthernet 1/0/5**

**Switch(config-if)#no storm-control pps**

**Switch(config-if)#storm-control broadcast kbps 10240**

**Switch(config-if)#show storm-control interface ten-gigabitEthernet 1/0/5**

| Port    | BcRate     | Mcate  | UIRate | LAG   |
|---------|------------|--------|--------|-------|
| -----   | -----      | -----  | -----  | ----- |
| Te1/0/5 | kbps 10240 | kbps 0 | kbps 0 | N/A   |

**Switch(config-if)#end**

**Switch#copy running-config startup-config**



# 4 Configuration Examples

## 4.1 Example for Configuring SP Mode

### 4.1.1 Network Requirements

Two hosts, Admin and Host A, can access the local network server through the switch. Configure the switch to ensure the traffic from the Admin can be treated preferentially when congestion occurs. Only when the traffic from the Admin is completely forwarded will the traffic from Host A be forwarded.

The figure below shows the network topology.

Figure 4-1 QoS Application Topology

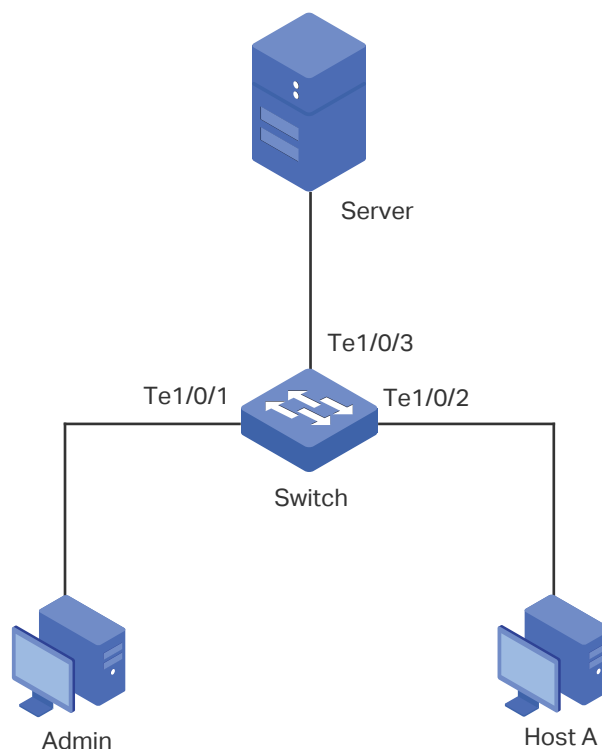

### 4.1.2 Configuration Scheme

The overview of the configuration is as follows:

- 1) Configure the Port Priority for the two ports. Set Port 1/0/1 with higher priority.
- 2) Select SP schedule mode.

Demonstrated with T1700X-16TS, this chapter provides configuration procedures in two ways: using the GUI and using the CLI.

### 4.1.3 Using the GUI

- 1) Choose **QoS > DiffServ > 802.1P Priority** to load the following page, and check the corresponding CoS-id of TC0 and TC1.

Figure 4-2 CoS-TC Mapping relations

| Priority and CoS-mapping Config |               |                               |
|---------------------------------|---------------|-------------------------------|
| Select                          | Tag-id/CoS-id | Queue TC-id                   |
| <input type="checkbox"/>        |               | <input type="text" value=""/> |
| <input type="checkbox"/>        | 0             | TC1                           |
| <input type="checkbox"/>        | 1             | TC0                           |
| <input type="checkbox"/>        | 2             | TC2                           |
| <input type="checkbox"/>        | 3             | TC3                           |
| <input type="checkbox"/>        | 4             | TC4                           |
| <input type="checkbox"/>        | 5             | TC5                           |
| <input type="checkbox"/>        | 6             | TC6                           |
| <input type="checkbox"/>        | 7             | TC7                           |

- 2) Choose **QoS > DiffServ > Port Priority** to load the following page, and set the priority for port 1/0/1 to CoS 0 (mapping to TC1) and priority for port 1/0/2 to CoS 1 (mapping to TC0).

Figure 4-3 Configure Port Priority

| Port Priority Config                      |        |                               |     |
|-------------------------------------------|--------|-------------------------------|-----|
| UNIT: <input type="text" value="1"/> LAGS |        |                               |     |
| Select                                    | Port   | Priority                      | LAG |
| <input type="checkbox"/>                  |        | <input type="text" value=""/> |     |
| <input type="checkbox"/>                  | 1/0/1  | COS 0                         | --- |
| <input type="checkbox"/>                  | 1/0/2  | COS 1                         | --- |
| <input type="checkbox"/>                  | 1/0/3  | COS 0                         | --- |
| <input type="checkbox"/>                  | 1/0/4  | COS 0                         | --- |
| <input type="checkbox"/>                  | 1/0/5  | COS 0                         | --- |
| <input type="checkbox"/>                  | 1/0/6  | COS 0                         | --- |
| <input type="checkbox"/>                  | 1/0/7  | COS 0                         | --- |
| <input type="checkbox"/>                  | 1/0/8  | COS 0                         | --- |
| <input type="checkbox"/>                  | 1/0/9  | COS 0                         | --- |
| <input type="checkbox"/>                  | 1/0/10 | COS 0                         | --- |
| <input type="checkbox"/>                  | 1/0/11 | COS 0                         | --- |
| <input type="checkbox"/>                  | 1/0/12 | COS 0                         | --- |
| <input type="checkbox"/>                  | 1/0/13 | COS 0                         | --- |
| <input type="checkbox"/>                  | 1/0/14 | COS 0                         | --- |
| <input type="checkbox"/>                  | 1/0/15 | COS 0                         | --- |

- 3) Choose **QoS > DiffServ > Schedule Mode** to load the following page, and select **SP-Mode** as the schedule mode. Click **Apply**.

Figure 4-4 Configure Schedule Mode

**Schedule Mode Config**

Schedule Mode: SP-Mode ▼

Queue Weight:

TC0:

TC1:

TC2:

TC3:

TC4:

TC5:

TC6:

TC7:

Apply  
Help

- 4) Click **Save Config** to save the settings.

#### 4.1.4 Using the CLI

- 1) Check the corresponding CoS-id of TC0 and TC1.

```
Switch#show qos cos-map
```

```
-----+-----+-----+-----+-----+-----+-----+-----+-----+-----
Tag|0   |1   |2   |3   |4   |5   |6   |7
-----+-----+-----+-----+-----+-----+-----+-----+-----+-----
TC |TC1 |TC0 |TC2 |TC3 |TC4 |TC5 |TC6 |TC7
-----+-----+-----+-----+-----+-----+-----+-----+-----+-----
```

- 2) Set the priority for port 1/0/1 to CoS 0(mapping to TC1) and priority for port 1/0/2 to CoS 1(mapping to TC0).

```
Switch#configure
```

```
Switch(config)#interface ten-gigabitEthernet 1/0/1
```

```
Switch(config-if)#qos 0
```

```
Switch(config-if)#exit
```

```
Switch(config)#interface ten-gigabitEthernet 1/0/2
```

```
Switch(config-if)#qos 1
```

```
Switch(config-if)#exit
```

- 3) Select SP-Mode as the schedule mode and save the settings.

```
Switch(config)#qos queue mode sp
Switch(config)#exit
Switch#copy running-config startup-config
```

### Verify the configuration

Verify the port-CoS mapping:

```
Switch(config)#show qos interface
```

| Port    | CoS Value | LAG   |
|---------|-----------|-------|
| -----   | -----     | ----- |
| Te1/0/1 | 0         | N/A   |
| Te1/0/2 | 1         | N/A   |
| ...     |           |       |

Verify the schedule mode.

```
Switch(config)#show qos queue mode
-----+-----
Scheduler Mode: SP   | Weight: Unusable in sp mode.
-----+-----
```

## 4.2 Example for Configuring WRR Mode

### 4.2.1 Network Requirements

Both RD department and Marketing department can access the local network server. Configure the switches to ensure the traffic from the two departments are forwarded based on the weight value ratio of 2:1 when congestion occurs.

The network topology is shown as the following figure. Switch A is an access layer switch, and Switch B is a layer 3 switch with ACL Redirect feature. RD department is connected to port 1/0/1 of Switch A. Marketing Department is connected to port 1/0/2 of Switch A, the server is connected to port 1/0/2 of Switch B and port 1/0/3 of Switch A is connected to port 1/0/1 of Switch B.

Figure 4-5 QoS Application Topology

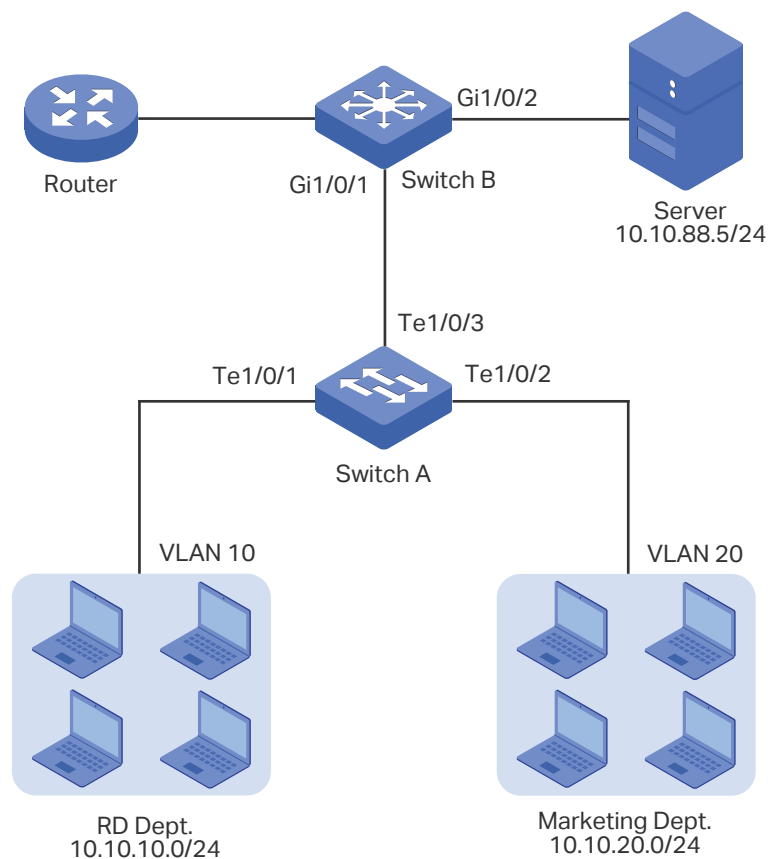

## 4.2.2 Configuration Scheme

- Configure Switch A to add different VLAN tags to the packets from the two departments respectively.
- Configure Switch B to classify the incoming packets from the two departments according to the VLAN tags, and to map them into different TC queues. Configure the schedule mode as WRR-Mode to implement the QoS feature.

This chapter provides configuration procedures in two ways: using the GUI and using the CLI.

## 4.2.3 Using the GUI

### Note:

Before configuration, ensure network segments are reachable to each other.

### Configurations for Switch A (Demonstrated with T1700X-16TS)

- 1) Choose **VLAN > 802.1Q VLAN > VLAN Config**, and click **Create** to load the following page. Create VLAN 10 with the description of RD. Add port 1/0/1 as an untagged port and port 1/0/3 as a tagged port to VLAN 10. Then click **Apply**.

Figure 4-6 Configure VLAN 10

**VLAN Info**

VLAN ID:  (2 - 4094)

Name:  (16 characters maximum)

**Untagged port**

UNIT:  LAGS

|                          |                          |                          |                          |                          |                          |                          |                          |
|--------------------------|--------------------------|--------------------------|--------------------------|--------------------------|--------------------------|--------------------------|--------------------------|
| <input type="checkbox"/> | <input type="checkbox"/> | <input type="checkbox"/> | <input type="checkbox"/> | <input type="checkbox"/> | <input type="checkbox"/> | <input type="checkbox"/> | <input type="checkbox"/> |
| <input type="checkbox"/> | <input type="checkbox"/> | <input type="checkbox"/> | <input type="checkbox"/> | <input type="checkbox"/> | <input type="checkbox"/> | <input type="checkbox"/> | <input type="checkbox"/> |

**Tagged port**

UNIT:  LAGS

|                          |                                     |                          |                          |                          |                          |                          |                          |
|--------------------------|-------------------------------------|--------------------------|--------------------------|--------------------------|--------------------------|--------------------------|--------------------------|
| <input type="checkbox"/> | <input type="checkbox"/>            | <input type="checkbox"/> | <input type="checkbox"/> | <input type="checkbox"/> | <input type="checkbox"/> | <input type="checkbox"/> | <input type="checkbox"/> |
| <input type="checkbox"/> | <input checked="" type="checkbox"/> | <input type="checkbox"/> | <input type="checkbox"/> | <input type="checkbox"/> | <input type="checkbox"/> | <input type="checkbox"/> | <input type="checkbox"/> |

Unselected Port(s)     Selected Port(s)     Not Available for Selection

- 2) Click **Create** again to load the following page. Create VLAN 20 with the description of Marketing. Add port 1/0/2 as an untagged port and port 1/0/4 as a tagged port to VLAN 20. Then click **Apply**.

Figure 4-7 Configure VLAN 20

**VLAN Info**

VLAN ID:  (2 - 4094)

Name:  (16 characters maximum)

**Untagged port**

UNIT:  LAGS

|                                       |                            |                            |                            |                             |                             |                             |                             |
|---------------------------------------|----------------------------|----------------------------|----------------------------|-----------------------------|-----------------------------|-----------------------------|-----------------------------|
| <input checked="" type="checkbox"/> 2 | <input type="checkbox"/> 4 | <input type="checkbox"/> 6 | <input type="checkbox"/> 8 | <input type="checkbox"/> 10 | <input type="checkbox"/> 12 | <input type="checkbox"/> 14 | <input type="checkbox"/> 16 |
| <input type="checkbox"/> 1            | <input type="checkbox"/> 3 | <input type="checkbox"/> 5 | <input type="checkbox"/> 7 | <input type="checkbox"/> 9  | <input type="checkbox"/> 11 | <input type="checkbox"/> 13 | <input type="checkbox"/> 15 |

**Tagged port**

UNIT:  LAGS

|                            |                                       |                            |                            |                             |                             |                             |                             |
|----------------------------|---------------------------------------|----------------------------|----------------------------|-----------------------------|-----------------------------|-----------------------------|-----------------------------|
| <input type="checkbox"/> 2 | <input type="checkbox"/> 4            | <input type="checkbox"/> 6 | <input type="checkbox"/> 8 | <input type="checkbox"/> 10 | <input type="checkbox"/> 12 | <input type="checkbox"/> 14 | <input type="checkbox"/> 16 |
| <input type="checkbox"/> 1 | <input checked="" type="checkbox"/> 3 | <input type="checkbox"/> 5 | <input type="checkbox"/> 7 | <input type="checkbox"/> 9  | <input type="checkbox"/> 11 | <input type="checkbox"/> 13 | <input type="checkbox"/> 15 |

Unselected Port(s)  
 Selected Port(s)  
 Not Available for Selection

3) Click **save config** to save the settings.

■ Configurations for Switch B (Demonstrated with T3700G-28TQ)

1) Choose **VLAN > 802.1Q VLAN > Port Config** to load the following page. For port 1/0/1, set the Link Type as **TRUNK**, and for port 1/0/2, set the Link Type as **ACCESS**. Click **Apply**.

Figure 4-8 Configure the Port

**VLAN Port Config**

UNIT:  LAGS

| Select                              | Port     | Link Type                                                      | PVID                          | LAG | VLAN                   |
|-------------------------------------|----------|----------------------------------------------------------------|-------------------------------|-----|------------------------|
| <input type="checkbox"/>            |          | <input type="text" value=""/> <input type="button" value="v"/> | <input type="text" value=""/> |     |                        |
| <input checked="" type="checkbox"/> | Gi1/0/1  | TRUNK                                                          | 1                             | --  | <a href="#">Detail</a> |
| <input type="checkbox"/>            | Gi1/0/2  | GENERAL                                                        | 1                             | --  | <a href="#">Detail</a> |
| <input type="checkbox"/>            | Gi1/0/3  | GENERAL                                                        | 1                             | --  | <a href="#">Detail</a> |
| <input type="checkbox"/>            | Gi1/0/4  | GENERAL                                                        | 1                             | --  | <a href="#">Detail</a> |
| <input type="checkbox"/>            | Gi1/0/5  | GENERAL                                                        | 1                             | --  | <a href="#">Detail</a> |
| <input type="checkbox"/>            | Gi1/0/6  | GENERAL                                                        | 1                             | --  | <a href="#">Detail</a> |
| <input type="checkbox"/>            | Gi1/0/7  | GENERAL                                                        | 1                             | --  | <a href="#">Detail</a> |
| <input type="checkbox"/>            | Gi1/0/8  | GENERAL                                                        | 1                             | --  | <a href="#">Detail</a> |
| <input type="checkbox"/>            | Gi1/0/9  | GENERAL                                                        | 1                             | --  | <a href="#">Detail</a> |
| <input type="checkbox"/>            | Gi1/0/10 | GENERAL                                                        | 1                             | --  | <a href="#">Detail</a> |
| <input type="checkbox"/>            | Gi1/0/11 | GENERAL                                                        | 1                             | --  | <a href="#">Detail</a> |
| <input type="checkbox"/>            | Gi1/0/12 | GENERAL                                                        | 1                             | --  | <a href="#">Detail</a> |
| <input type="checkbox"/>            | Gi1/0/13 | GENERAL                                                        | 1                             | --  | <a href="#">Detail</a> |
| <input type="checkbox"/>            | Gi1/0/14 | GENERAL                                                        | 1                             | --  | <a href="#">Detail</a> |
| <input type="checkbox"/>            | Gi1/0/15 | GENERAL                                                        | 1                             | --  | <a href="#">Detail</a> |

- 2) Choose **VLAN > 802.1Q VLAN > VLAN Config** and click **Create** to load the following page. Create VLAN 10 and VLAN 20, and add port 1/0/1 to the two VLANs; create VLAN 30, and add port 1/0/2 to VLAN 30.



Figure 4-9 Configure VLAN 10

**VLAN Info**

VLAN ID:  (2 - 4094)

Name:  (16 characters maximum)

---

**Untagged port**

UNIT:  LAGS

|                                       |                            |                            |                            |                             |                             |                             |                             |                             |                             |                             |                             |                             |                             |
|---------------------------------------|----------------------------|----------------------------|----------------------------|-----------------------------|-----------------------------|-----------------------------|-----------------------------|-----------------------------|-----------------------------|-----------------------------|-----------------------------|-----------------------------|-----------------------------|
| <input type="checkbox"/> 2            | <input type="checkbox"/> 4 | <input type="checkbox"/> 6 | <input type="checkbox"/> 8 | <input type="checkbox"/> 10 | <input type="checkbox"/> 12 | <input type="checkbox"/> 14 | <input type="checkbox"/> 16 | <input type="checkbox"/> 18 | <input type="checkbox"/> 20 | <input type="checkbox"/> 22 | <input type="checkbox"/> 24 | <input type="checkbox"/> 26 | <input type="checkbox"/> 28 |
| <input checked="" type="checkbox"/> 1 | <input type="checkbox"/> 3 | <input type="checkbox"/> 5 | <input type="checkbox"/> 7 | <input type="checkbox"/> 9  | <input type="checkbox"/> 11 | <input type="checkbox"/> 13 | <input type="checkbox"/> 15 | <input type="checkbox"/> 17 | <input type="checkbox"/> 19 | <input type="checkbox"/> 21 | <input type="checkbox"/> 23 | <input type="checkbox"/> 25 | <input type="checkbox"/> 27 |

---

**Tagged port**

UNIT:  LAGS

|                                       |                            |                            |                            |                             |                             |                             |                             |                             |                             |                             |                             |                             |                             |
|---------------------------------------|----------------------------|----------------------------|----------------------------|-----------------------------|-----------------------------|-----------------------------|-----------------------------|-----------------------------|-----------------------------|-----------------------------|-----------------------------|-----------------------------|-----------------------------|
| <input type="checkbox"/> 2            | <input type="checkbox"/> 4 | <input type="checkbox"/> 6 | <input type="checkbox"/> 8 | <input type="checkbox"/> 10 | <input type="checkbox"/> 12 | <input type="checkbox"/> 14 | <input type="checkbox"/> 16 | <input type="checkbox"/> 18 | <input type="checkbox"/> 20 | <input type="checkbox"/> 22 | <input type="checkbox"/> 24 | <input type="checkbox"/> 26 | <input type="checkbox"/> 28 |
| <input checked="" type="checkbox"/> 1 | <input type="checkbox"/> 3 | <input type="checkbox"/> 5 | <input type="checkbox"/> 7 | <input type="checkbox"/> 9  | <input type="checkbox"/> 11 | <input type="checkbox"/> 13 | <input type="checkbox"/> 15 | <input type="checkbox"/> 17 | <input type="checkbox"/> 19 | <input type="checkbox"/> 21 | <input type="checkbox"/> 23 | <input type="checkbox"/> 25 | <input type="checkbox"/> 27 |

Unselected Port(s)     Selected Port(s)     Not Available for Selection

Figure 4-10 Configure VLAN 20

**VLAN Info**

VLAN ID:  (2 - 4094)

Name:  (16 characters maximum)

---

**Untagged port**

UNIT:  LAGS

|                                       |                            |                            |                            |                             |                             |                             |                             |                             |                             |                             |                             |                             |                             |
|---------------------------------------|----------------------------|----------------------------|----------------------------|-----------------------------|-----------------------------|-----------------------------|-----------------------------|-----------------------------|-----------------------------|-----------------------------|-----------------------------|-----------------------------|-----------------------------|
| <input type="checkbox"/> 2            | <input type="checkbox"/> 4 | <input type="checkbox"/> 6 | <input type="checkbox"/> 8 | <input type="checkbox"/> 10 | <input type="checkbox"/> 12 | <input type="checkbox"/> 14 | <input type="checkbox"/> 16 | <input type="checkbox"/> 18 | <input type="checkbox"/> 20 | <input type="checkbox"/> 22 | <input type="checkbox"/> 24 | <input type="checkbox"/> 26 | <input type="checkbox"/> 28 |
| <input checked="" type="checkbox"/> 1 | <input type="checkbox"/> 3 | <input type="checkbox"/> 5 | <input type="checkbox"/> 7 | <input type="checkbox"/> 9  | <input type="checkbox"/> 11 | <input type="checkbox"/> 13 | <input type="checkbox"/> 15 | <input type="checkbox"/> 17 | <input type="checkbox"/> 19 | <input type="checkbox"/> 21 | <input type="checkbox"/> 23 | <input type="checkbox"/> 25 | <input type="checkbox"/> 27 |

---

**Tagged port**

UNIT:  LAGS

|                                       |                            |                            |                            |                             |                             |                             |                             |                             |                             |                             |                             |                             |                             |
|---------------------------------------|----------------------------|----------------------------|----------------------------|-----------------------------|-----------------------------|-----------------------------|-----------------------------|-----------------------------|-----------------------------|-----------------------------|-----------------------------|-----------------------------|-----------------------------|
| <input type="checkbox"/> 2            | <input type="checkbox"/> 4 | <input type="checkbox"/> 6 | <input type="checkbox"/> 8 | <input type="checkbox"/> 10 | <input type="checkbox"/> 12 | <input type="checkbox"/> 14 | <input type="checkbox"/> 16 | <input type="checkbox"/> 18 | <input type="checkbox"/> 20 | <input type="checkbox"/> 22 | <input type="checkbox"/> 24 | <input type="checkbox"/> 26 | <input type="checkbox"/> 28 |
| <input checked="" type="checkbox"/> 1 | <input type="checkbox"/> 3 | <input type="checkbox"/> 5 | <input type="checkbox"/> 7 | <input type="checkbox"/> 9  | <input type="checkbox"/> 11 | <input type="checkbox"/> 13 | <input type="checkbox"/> 15 | <input type="checkbox"/> 17 | <input type="checkbox"/> 19 | <input type="checkbox"/> 21 | <input type="checkbox"/> 23 | <input type="checkbox"/> 25 | <input type="checkbox"/> 27 |

Unselected Port(s)     Selected Port(s)     Not Available for Selection

Figure 4-11 Configure VLAN30

**VLAN Info**

VLAN ID:  (2 - 4094)  
 Name:  (16 characters maximum)

**Untagged port**

UNIT:  LAGS

2

4

6

8

10

12

14

16

18

20

22

24

26

28

1

3

5

7

9

11

13

15

17

19

21

23

25

27

**Tagged port**

UNIT:  LAGS

2

4

6

8

10

12

14

16

18

20

22

24

26

28

1

3

5

7

9

11

13

15

17

19

21

23

25

27

Unselected Port(s)

Selected Port(s)

Not Available for Selection

3) Create MAC ACL 10 with its Rule ID as **1** and Operation as **Permit**.

Choose **ACL > ACL Config > ACL Create** to load the following page. Create ACL 10, and click **Apply**.

Figure 4-12 Create MAC ACL 10

**ACL Create**

ACL ID:

0-499 MAC ACL  
 500-1499 Standard-IP ACL  
 1500-2499 Extend-IP ACL  
 2500-3499 Combined ACL  
 3500-4499 IPv6 ACL

Rule Order:

Choose **ACL > ACL Config > MAC ACL** to load the following page. Select ACL 10, specify the Rule ID as **1** and the Operation as **Permit**. Click **Apply**.

Figure 4-13 Create Rule 1

Create MAC-Rule

ACL ID:  (0-999)

Rule ID:  (0-999)

Operation:

S-MAC:  Mask:  (Format 00-00-00-00-00-01)

D-MAC:  Mask:

VLAN ID:  (1-4094)

EtherType:  (4-hex number)

User Priority:

Time-Range:

- 4) Create Policy RD and bind it to ACL 10, select **QoS Remark** and set Local Priority to **TC1**.

Choose **ACL > Policy Config > Policy Create** to load the following page. Create a policy with the Policy Name **RD** and click **Apply**.

Figure 4-14 Create Policy RD

Create Policy

Policy Name:

Choose **ACL > Policy Config > Action Create** to load the following page. Select Policy RD, and ACL 10, click **QoS Remark** and set the Local Priority to **TC 1**. Click **Apply**.

Figure 4-15 Action Create

Create Action:

Select Policy: RD

Select ACL: ACL 10

S-Mirror

Port:

S-Condition

Rate:  Kbps(1-1000000)

Out of Band: None

Redirect

Destination Port:

QoS Remark

DSCP: No Limit

Local Priority: TC 1

Apply Help

- 5) Create Policy Marketing and bind it to ACL 10, select **QoS Remark** and set Local Priority to **TC0**.

Choose **ACL > Policy Config > Policy Create** to load the following page. Create a policy with the Policy Name **Marketing** and click **Apply**.

Figure 4-16 Create Policy Marketing

Create Policy

Policy Name: Marketing

Apply

Help

Choose **ACL > Policy Config > Action Create** to load the following page. Select Policy Marketing, and ACL 10, click **QoS Remark** and set the Local Priority to **TC 0**. Click **Apply**.

Figure 4-17 Action Create

Create Action:

Select Policy: Marketing

Select ACL: ACL 10

S-Mirror

Port:

S-Condition

Rate:  Kbps(1-1000000)

Out of Band: None

Redirect

Destination Port:

QoS Remark

DSCP: No Limit

Local Priority: TC 0

Apply Help

- 6) Choose **ACL > Policy Binding > VLAN Binding**. Bind Policy RD and Policy Marketing to VLAN10 and VLAN 20 respectively.

Figure 4-18 Bind Policy RD to VLAN 10

VLAN-Bind Config

Policy Name: RD

VLAN ID: 10 (Format:1)

Apply Help

VLAN-Bind Table

| Index                  | Policy Name | VLAN ID | Direction |
|------------------------|-------------|---------|-----------|
| No entry in the table. |             |         |           |

Figure 4-19 Bind Policy Marketing to VLAN 20

VLAN-Bind Config

Policy Name: Marketing

VLAN ID: 20 (Format:1)

Apply Help

VLAN-Bind Table

| Index | Policy Name | VLAN ID | Direction |
|-------|-------------|---------|-----------|
| 1     | RD          | 10      | Ingress   |

- 7) Choose **QoS > DiffServ > Schedule Mode**. Select **WRR-Mode** as the schedule mode, and click **Apply**. No configuration is required here because queues based on ACL rules have higher priority.

Figure 4-20 Configure Schedule Mode

Schedule Mode Config

Schedule Mode: WRR-Mode

Apply

Help

- 8) Click **Save Config** to save the settings.

## 4.2.4 Using the CLI

### Note:

Before configuration, ensure network segments are reachable to each other.

#### Configurations for Switch A (Demonstrated with T1700X-16TS)

- 1) Create VLAN 10 with the name RD and VLAN 20 with the name Marketing.

```
Switch_A#configure
```

```
Switch_A(config)#vlan 10
```

```
Switch_A(config-vlan)#name RD
```

```
Switch_A(config-vlan)#exit
```

```
Switch_A(config)#vlan 20
```

```
Switch_A(config-vlan)#name Marketing
```

```
Switch_A(config-vlan)#exit
```

- 2) Set the port mode of port 1/0/1 and 1/0/2 as Untagged, and add them to VLAN 10 and VLAN 20 respectively. Set the port mode of port 1/0/3 and add it to both VLAN 10 and VLAN 20.

```
Switch_A(config)#interface ten-gigabitEthernet 1/0/1
```

```
Switch_A(config-if)#switchport general allowed vlan 10 untagged
```

```
Switch_A(config-vlan)#exit
```

```
Switch_A(config)#interface ten-gigabitEthernet 1/0/2
```

```
Switch_A(config-if)#switchport general allowed vlan 20 untagged
```

```
Switch_A(config-vlan)#exit
```

```
Switch_A(config)#interface ten-gigabitEthernet 1/0/3
```

```
Switch_A(config-if)#switchport general allowed vlan 10,20 tagged
```

```
Switch_A(config-if)#end
```

```
Switch_A#copy running-config startup-config
```

- Configurations for For Switch B (Demonstrated with T3700G-28TQ)

- 1) Create VLAN 10 and VLAN 20. Configure the Link Type of port 1/0/1 as **Trunk**, and add it to the two VLANs.

```
Switch_B#configure
```

```
Switch_B(config)#vlan 10
```

```
Switch_B(config-vlan)#name RD
```

```
Switch_B(config-vlan)exit
```

```
Switch_B(config)#vlan 20
```

```
Switch_B(config-vlan)#name Marketing
```

```
Switch_B(config-vlan)exit
```

```
Switch_B(config)#interface gigabitEthernet 1/0/1
```

```
Switch_B(config-if)#switchport mode trunk
```

```
Switch_B(config-if)#switchport trunk allowed vlan 10,20
```

```
Switch_B(config-if)#exit
```

- 2) Create VLAN 30. Configure the Link Type of port 1/0/2 as **Access**, and add it to VLAN 30.

```
Switch_B(config)#vlan 30
```

```
Switch_B(config-vlan)#name Server
```

```
Switch_B(config-vlan)exit
```

```
Switch_B(config)#interface gigabitEthernet 1/0/2
```

```
Switch_B(config-if)#switchport mode access
```

```
Switch_B(config-if)#switchport access vlan 30
```

```
Switch_B(config-if)#exit
```

- 3) Create MAC ACL 10 with its Rule ID as **1** and Operation as **Permit**.

```
Switch_B(config)#mac access-list 10
```

```
Switch_B(config-mac-acl)#rule 1 permit
```

```
Switch_B(config-mac-acl)#exit
```

- 4) Create Policy RD and bind it to ACL 10, enable **QoS Remark** and set Local Priority to **TC1**.

```
Switch_B(config)#access-list policy name RD
```

```
Switch_B(config)#access-list policy action RD 10
```

```
Switch_B(config-action)#qos-remark priority 1
```

```
Switch_B(config-action)#exit
```

- 5) Create Policy Marketing and bind it to ACL 10, enable **QoS Remark** and set Local Priority to **TC0**.

```
Switch_B(config)#access-list policy name Marketing
```

```
Switch_B(config)#access-list policy action Marketing 10
```

```
Switch_B(config-action)#qos-remark priority 0
```

```
Switch_B(config-action)#exit
```

- 6) Bind Policy RD and Policy Market to VLAN10 and VLAN 20 respectively.

```
Switch_B(config)#interface vlan 10
```

```
Switch_B(config-if)#access-list bind RD
```

```
Switch_B(config-if)#exit
```

```
Switch_B(config)#interface vlan 20
```

```
Switch_B(config-if)#access-list bind Marketing
```

```
Switch_B(config-if)#exit
```

- 7) Select **WRR-Mode** as the schedule mode and save the settings.

```
Switch_B(config)#qos queue mode wrr
```

```
Switch_B(config)#exit
```

```
Switch_B#copy running-config startup-config
```

## Verify the configuration

### Switch A:

Verify the VLAN members.

```
Switch_B#show vlan
```

| VLAN  | Name        | Status | Ports                                                                                                    |
|-------|-------------|--------|----------------------------------------------------------------------------------------------------------|
| ----- | -----       | -----  | -----                                                                                                    |
| 1     | System-VLAN | active | Te1/0/3, Te1/0/4, Te1/0/5, Te1/0/6,<br>Te1/0/7, Te1/0/8, Te1/0/9, Te1/0/10,<br>...<br>Te1/0/15, Te1/0/16 |



```

10      RD          active      Te1/0/1, Te1/0/3
20      Marketing   active      Te1/0/2, Te1/0/3

```

- **Switch B:**

Verify ACL configuration:

```
Switch_B#show access-list
```

```
Mac access list 10
```

```
    1 permit
```

Verify Policy and Action configuration:

```
Switch_B(config)#show access-list policy
```

```
Policy name : RD
```

```
access-list 10 priority 1
```

```
Policy name : Marketing
```

```
access-list 10 priority 0
```

Verify Policy binding:

```
Switch_B#show access-list bind
```

| Index | Policy Name | Interface/VID | Direction | Type |
|-------|-------------|---------------|-----------|------|
| 1     | RD          | 10            | Ingress   | Vlan |
| 2     | Marketing   | 20            | Ingress   | Vlan |

Verify the schedule mode.

```
Switch_B#show qos queue mode
```

```
-----+-----
```

```
Scheduler Mode | WRR
```

```
-----+-----
```

# 5 Appendix: Default Parameters

## ■ DiffServ

Table 5-1 DiffServ

| Parameter       | Default Setting                                                  |
|-----------------|------------------------------------------------------------------|
| Port Priority   | Enabled. Packets from all ports are mapped to the same TC queue. |
| 802.1P Priority | Enabled. See Table 5-3 for Tag-id/CoS-id-TC mapping relations.   |
| DSCP Priority   | Disabled. See Table 5-4 for DSCP-CoS-id mapping relations.       |
| Schedule Mode   | Equ-Mode.                                                        |

Table 5-2 Tag-id/CoS-id-TC Mapping

| Tag-id/CoS-id | TC Queues (8) |
|---------------|---------------|
| 0             | TC1           |
| 1             | TC0           |
| 2             | TC2           |
| 3             | TC3           |
| 4             | TC4           |
| 5             | TC5           |
| 6             | TC6           |
| 7             | TC7           |

Table 5-3 DSCP-CoS Mapping

| DSCP  | CoS-id |
|-------|--------|
| 0-7   | CoS 0  |
| 8-15  | CoS 1  |
| 16-23 | CoS 2  |
| 24-31 | CoS 3  |
| 32-39 | CoS 4  |
| 40-47 | CoS 5  |
| 48-55 | CoS 6  |
| 56-63 | CoS 7  |

- **Bandwidth Control**

Table 5-4 Bandwidth Control

| Parameter     | Default Setting |
|---------------|-----------------|
| Rate Limit    | Disabled        |
| Storm Control | Disabled        |

# Part 18

## Configuring Voice VLAN

### CHAPTERS

1. Overview
2. Voice VLAN Configuration
3. Configuration Example
4. Appendix: Default Parameters

# 1 Overview

The voice VLAN feature is used to prioritize the transmission of voice traffic. Voice traffic is typically more time-sensitive than data traffic, and the voice quality can deteriorate a lot because of packet loss and delay. To ensure the high voice quality, you can configure the voice VLAN and set priority for voice traffic.

## ■ Voice VLAN Modes on Ports

A voice VLAN can operate in two modes: manual mode and automatic mode.

**Manual mode:** This mode is applicable when the switch port forwards voice traffic only. You manually add ports connecting IP phones to the voice VLAN; then the switch will apply priority rules to ensure the high priority of voice traffic.

Figure 1-1 Only Voice Traffic on One Port

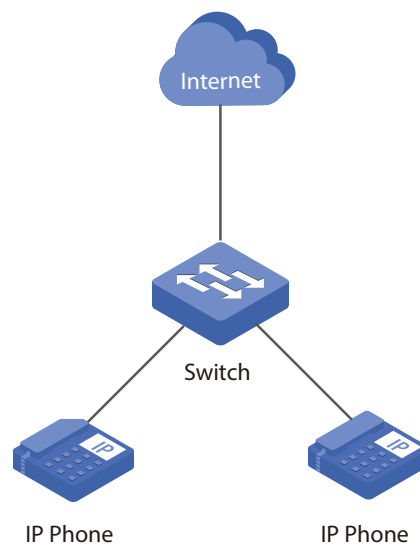

**Automatic mode:** This mode is applicable when voice traffic and data traffic are transmitted on the same switch port. When a port receives a voice packet, the switch automatically adds the port to the voice VLAN and applies priority rules. The switch forwards voice traffic in the voice VLAN and data traffic in other VLANs.

Figure 1-2 Voice Traffic and Data Traffic on the Same Port

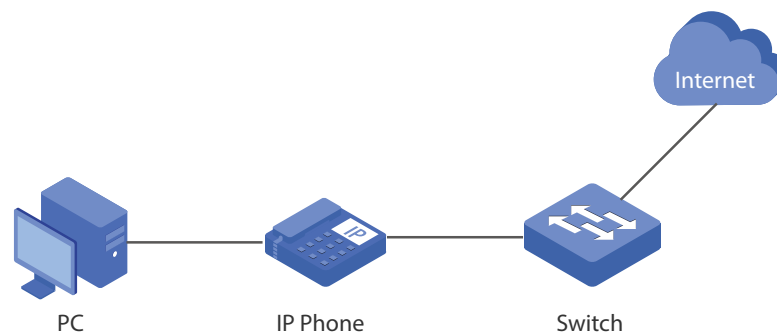

- OUI Address (Organizationally Unique Identifier Address)

The OUI address is used by the switch to determine whether a packet is a voice packet. An OUI address is the first 24 bits of a MAC address, and is assigned as a unique identifier by IEEE (Institute of Electrical and Electronics Engineers) to a device vendor. If the source MAC address of a packet complies with the OUI addresses in the switch, the switch identifies the packet as a voice packet and prioritizes it in transmission.

## 2 Voice VLAN Configuration

To complete the Voice VLAN configuration, follow these steps:

- 1) Create a VLAN.
- 2) (Optional) Configure OUI addresses.
- 3) Configure Voice VLAN globally.
- 4) Configure Voice VLAN mode on ports.

### Configuration Guidelines

- Before configuring voice VLAN, you need to create a VLAN for voice traffic. For details about VLAN Configuration, please refer to [Configuring 802.1Q VLAN](#).
- VLAN 1 is a default VLAN and cannot be configured as the voice VLAN.
- Only one VLAN can be set as the voice VLAN on the switch.
- To apply the voice VLAN configuration, you may need to further configure PVID (Port VLAN ID) and the link type of the port which is connected to voice devices. We recommend that you choose the mode according to your needs and configure the port as the following table shows.

Table 2-1 Voice VLAN mode and Link Type of the Port

| Traffic on One Port            | Voice Traffic Type     | Suggested Mode | Suggested Link Type and PVID                |
|--------------------------------|------------------------|----------------|---------------------------------------------|
| Voice traffic and data traffic | Tagged voice traffic   | Automatic      | PVID cannot be the voice VLAN ID.           |
|                                | Untagged voice traffic |                | Not supported.                              |
| Voice traffic only             | Tagged voice traffic   | Manual         | Tagged; PVID configuration is not required. |
|                                | Untagged voice traffic |                | Untagged; PVID should be the voice VLAN ID. |

Because the voice VLAN in automatic mode supports only tagged voice traffic, you need to make sure traffic from the voice device is tagged. To do so, there are mainly two ways:

- » You can configure the voice device to forward traffic with a voice VLAN tag.
- » If your switch provides the LLDP-MED feature, you can also configure it to instruct the voice device to send tagged voice traffic. For details about LLDP-MED, please refer to [Configuring LLDP](#).

## 2.1 Using the GUI

### 2.1.1 (Optional) Configuring OUI Addresses

If the OUI address of your voice device is not in the OUI table, you need to add the OUI address to the table.

Choose the menu **QoS > Voice VLAN > OUI Config** to load the following page.

Figure 2-1 Configuring OUI Addresses

**Create OUI**

OUI:  (Format: 00-00-00-00-00-01)

Mask:  (Default: FF-FF-FF-00-00-00) Create

Description:  (16 characters maximum)

**OUI Table**

| Select                   | OUI               | MASK              | Description   |
|--------------------------|-------------------|-------------------|---------------|
| <input type="checkbox"/> | 00-01-e3-00-00-00 | ff-ff-ff-00-00-00 | Siemens Phone |
| <input type="checkbox"/> | 00-03-6b-00-00-00 | ff-ff-ff-00-00-00 | Cisco Phone   |
| <input type="checkbox"/> | 00-04-0d-00-00-00 | ff-ff-ff-00-00-00 | Avaya Phone   |
| <input type="checkbox"/> | 00-60-b9-00-00-00 | ff-ff-ff-00-00-00 | Philips Phone |
| <input type="checkbox"/> | 00-d0-1e-00-00-00 | ff-ff-ff-00-00-00 | Pingtel Phone |
| <input type="checkbox"/> | 00-e0-75-00-00-00 | ff-ff-ff-00-00-00 | PolyCom Phone |
| <input type="checkbox"/> | 00-e0-bb-00-00-00 | ff-ff-ff-00-00-00 | 3Com Phone    |

All
Delete
Help

Follow these steps to add OUI addresses:

- 1) Enter an OUI address and the corresponding mask, and give a description about the OUI address.

|                    |                                                                                                                      |
|--------------------|----------------------------------------------------------------------------------------------------------------------|
| <b>OUI</b>         | Enter the OUI address of your device.                                                                                |
| <b>Mask</b>        | Specify a mask to determine the depth of the OUI that the switch uses to check source addresses of received packets. |
| <b>Description</b> | Teve an OUI address description for identification. The length is no more than 16 characters.                        |

- 2) Click **Create** to add an OUI address to the table.



## 2.1.2 Configuring Voice VLAN Globally

Choose the menu **QoS > Voice VLAN > Global Config** to load the following page.

Figure 2-2 Configuring Voice VLAN Globally

| Global Config                        |                                                                       |
|--------------------------------------|-----------------------------------------------------------------------|
| Voice VLAN:                          | <input checked="" type="radio"/> Enable <input type="radio"/> Disable |
| VLAN ID:                             | <input type="text" value="10"/> (2 - 4094)                            |
| Aging Time:                          | <input type="text" value="1440"/> min (1-43200, default: 1440)        |
| Priority:                            | <input type="text" value="6"/> <input type="button" value="v"/>       |
| <input type="button" value="Apply"/> |                                                                       |
| <input type="button" value="Help"/>  |                                                                       |

Follow these steps to configure the voice VLAN globally:

- 1) Enable the voice VLAN feature, and enter a VLAN ID.

|         |                                             |
|---------|---------------------------------------------|
| VLAN ID | Specify an existing VLAN as the voice VLAN. |
|---------|---------------------------------------------|

- 2) Set the aging time for the voice VLAN.

|            |                                                                                                                                                                                                                                      |
|------------|--------------------------------------------------------------------------------------------------------------------------------------------------------------------------------------------------------------------------------------|
| Aging Time | Specify the length of time that a port remains in the voice VLAN after the port receives a voice packet. Aging time works only for ports in automatic voice VLAN mode. The range is 1 to 43200 minutes; the default is 1440 minutes. |
|------------|--------------------------------------------------------------------------------------------------------------------------------------------------------------------------------------------------------------------------------------|

- 3) Specify a priority for the voice VLAN.

|          |                                                                                                                                                                                |
|----------|--------------------------------------------------------------------------------------------------------------------------------------------------------------------------------|
| Priority | Specify the priority that will be assigned to voice packets. A bigger value means a higher priority. The range is 0 to 7; the default is 6.                                    |
|          | This is an IEEE 802.1p priority, and you can further configure its schedule mode if needed. For details about schedule mode, please refer to <a href="#">Configuring QoS</a> . |

- 4) Click **Apply**.

## 2.1.3 Configuring Voice VLAN Mode on Ports

Choose the menu **QoS > Voice VLAN > Port Config** to load the following page.

Figure 2-3 Configuring Voice VLAN Mode on Ports

| Port Config                         |        |           |               |              |     |
|-------------------------------------|--------|-----------|---------------|--------------|-----|
| UNIT: 1 LAGS                        |        |           |               |              |     |
| Select                              | Port   | Port Mode | Security Mode | Member State | LAG |
| <input type="checkbox"/>            |        | Manual ▾  | Enable ▾      |              |     |
| <input checked="" type="checkbox"/> | 1/0/1  | Auto      | Disable       | Inactive     | --- |
| <input checked="" type="checkbox"/> | 1/0/2  | Auto      | Disable       | Inactive     | --- |
| <input type="checkbox"/>            | 1/0/3  | Auto      | Disable       | Inactive     | --- |
| <input type="checkbox"/>            | 1/0/4  | Auto      | Disable       | Inactive     | --- |
| <input type="checkbox"/>            | 1/0/5  | Auto      | Disable       | Inactive     | --- |
| <input type="checkbox"/>            | 1/0/6  | Auto      | Disable       | Inactive     | --- |
| <input type="checkbox"/>            | 1/0/7  | Auto      | Disable       | Inactive     | --- |
| <input type="checkbox"/>            | 1/0/8  | Auto      | Disable       | Inactive     | --- |
| <input type="checkbox"/>            | 1/0/9  | Auto      | Disable       | Inactive     | --- |
| <input type="checkbox"/>            | 1/0/10 | Auto      | Disable       | Inactive     | --- |
| <input type="checkbox"/>            | 1/0/11 | Auto      | Disable       | Inactive     | --- |
| <input type="checkbox"/>            | 1/0/12 | Auto      | Disable       | Inactive     | --- |
| <input type="checkbox"/>            | 1/0/13 | Auto      | Disable       | Inactive     | --- |
| <input type="checkbox"/>            | 1/0/14 | Auto      | Disable       | Inactive     | --- |
| <input type="checkbox"/>            | 1/0/15 | Auto      | Disable       | Inactive     | --- |

Follow these steps to configure voice VLAN mode on ports:

- 1) Select your desired ports and choose the port mode.

#### Port Mode

Choose the way of adding the selected ports to the voice VLAN.

**Auto:** When a port receives a voice packet whose resource MAC address matches an OUI address, the switch automatically adds the port to the voice VLAN.

If you choose the Auto mode for the selected ports, make sure traffic from your voice device is tagged.

**Manual:** You manually add the ports connecting voice devices to the voice VLAN.

#### Member State

Displays the current state of the ports that are connected to voice devices.

**Active:** The corresponding port is in the voice VLAN.

**Inactive:** The corresponding port is not in the voice VLAN.

- 2) Set the security mode for selected ports.

---

|                      |                                                                                                                                                                                                                                                                                                                                                                                                                                                                                                                                                                                                                                                                                                                                                                                                                                                                                                               |
|----------------------|---------------------------------------------------------------------------------------------------------------------------------------------------------------------------------------------------------------------------------------------------------------------------------------------------------------------------------------------------------------------------------------------------------------------------------------------------------------------------------------------------------------------------------------------------------------------------------------------------------------------------------------------------------------------------------------------------------------------------------------------------------------------------------------------------------------------------------------------------------------------------------------------------------------|
| <b>Security Mode</b> | <p>For packets that will be forwarded in the voice VLAN, you can configure the security mode to prevent malicious traffic with faked voice VLAN tag.</p> <p>For packets to other VLANs, how the switch processes the packets is determined by whether the selected ports permit the VLAN or not, independent of voice VLAN security mode.</p> <p><b>Disable:</b> For packets to the voice VLAN, the switch does not check the source MAC address and the selected ports forward all these packets in the voice VLAN. The security mode is disabled by default.</p> <p><b>Enable:</b> For packets to the voice VLAN, the selected ports forward only voice packets whose source MAC addresses match OUI addresses to the voice VLAN, and discard others.</p> <p>We recommend that you do not mix voice traffic with data traffic in the voice VLAN. If necessary, make sure the security mode is disabled.</p> |
|----------------------|---------------------------------------------------------------------------------------------------------------------------------------------------------------------------------------------------------------------------------------------------------------------------------------------------------------------------------------------------------------------------------------------------------------------------------------------------------------------------------------------------------------------------------------------------------------------------------------------------------------------------------------------------------------------------------------------------------------------------------------------------------------------------------------------------------------------------------------------------------------------------------------------------------------|

---

3) Click **Apply**.

## 2.2 Using the CLI

Follow these steps to configure the voice VLAN:

---

|        |                                                                                                                                                                                                                                                                                                                                                                                                                                                                                                                             |
|--------|-----------------------------------------------------------------------------------------------------------------------------------------------------------------------------------------------------------------------------------------------------------------------------------------------------------------------------------------------------------------------------------------------------------------------------------------------------------------------------------------------------------------------------|
| Step 1 | <p><b>configure</b></p> <p>Enter global configuration mode.</p>                                                                                                                                                                                                                                                                                                                                                                                                                                                             |
| Step 2 | <p><b>show voice vlan oui</b></p> <p>(Optional) Check whether the OUI address of your voice device is in the OUI table.</p>                                                                                                                                                                                                                                                                                                                                                                                                 |
| Step 3 | <p><b>voice vlan mac-address</b> <i>mac-addr</i> <b>mask</b> <i>mask</i> [ <b>description</b> <i>descript</i> ]</p> <p>(Optional) If the OUI address of your voice device is not in the OUI table, add the OUI address to the table.</p> <p><i>mac-addr</i>: Enter the OUI address of your device.</p> <p><i>mask</i>: Specify a mask to determine the depth of the OUI that the switch uses to check source addresses of received packets.</p> <p><i>descript</i>: Teve an OUI address description for identification.</p> |
| Step 4 | <p><b>voice vlan priority</b> <i>pri</i></p> <p>(Optional) Set the priority for voice packets.</p> <p><i>pri</i>: Specify the priority that will be tagged on voice packets. A bigger value means a higher priority. The range is 0 to 7; the default is 6. This is an IEEE 802.1p priority, and you can further configure its schedule mode if needed. For details about schedule mode, please refer to <a href="#">Configuring QoS</a>.</p>                                                                               |

---

- 
- Step 5     **voice vlan aging *time***  
(Optional) Set the aging time for ports in automatic voice VLAN mode.
- time*: Specify the length of time that a port remains in the voice VLAN after the port receives a voice packet. Aging time works only for ports in automatic voice VLAN mode. The range is 1 to 43200 minutes; the default is 1440 minutes.
- 
- Step 6     **voice vlan *vid***  
Specify an existing VLAN as the voice VLAN.
- vid* : Enter the VLAN ID that you have created for the voice VLAN.
- 
- Step 7     **interface {fastEthernet *port* | range fastEthernet *port-list* | gigabitEthernet *port* | range gigabitEthernet *port-list* | ten-gigabitEthernet *port* | range ten-gigabitEthernet *port-list* }**  
Configure voice VLAN mode on the specified ports.
- port* / *port-list*: Specify the number or the list of the Ethernet ports for voice VLAN feature configuration.
- 
- Step 8     **switchport voice vlan mode { auto | manual }**  
Choose the way of adding the specified ports to the voice VLAN.
- auto*: The switch automatically adds the specified ports to the voice VLAN when the ports receive voice packets. If you choose the auto mode for the specified ports, make sure traffic from your voice device is tagged.
- manual*: You need to manually add the specified ports to the voice VLAN.
- 
- Step 9     **switchport voice vlan security**  
Enable the security feature.
- For packets to the voice VLAN, the selected ports forward only voice packets whose source MAC addresses match OUI addresses to the voice VLAN, and discard others. For packets to other VLANs, how the switch processes the packets is determined by whether the selected ports permit the VLAN or not, independent of voice VLAN security mode.
- We recommend that you do not mix voice traffic with data traffic in the voice VLAN. If necessary, make sure the security mode is disabled.
- 
- Step 10    **switchport general allowed vlan *vid* { tagged | untagged }**  
(For ports in manual voice VLAN mode) Add the specified ports to the voice VLAN.
- vid*: Enter the voice VLAN ID to add the specified ports to the voice VLAN.
- tagged* | *untagged*: Set the egress rule as tagged or untagged for the specified ports.
- 
- Step 11    **show voice vlan**  
Verify the global configuration of voice VLAN.
- 
- Step 12    **show voice vlan switchport**  
Verify the voice VLAN configuration of the ports.
-

---

Step 13    **end**  
Return to privileged EXEC mode.

---

Step 14    **copy running-config startup-config**  
Save the settings in the configuration file.

---

The following example shows how to set port 1/0/1 in manual voice VLAN mode. Configure the switch to forward voice traffic with an IEEE 802.1p priority of 5 and to transmit only voice traffic whose resource MAC address matches an OUI address in the voice VLAN :

**Switch#configure**

**Switch(config)#vlan 10**

**Switch(config-vlan)#name VoiceVLAN**

**Switch(config-vlan)#exit**

**Switch(config)#voice vlan priority 5**

**Switch(config)#voice vlan 10**

**Switch(config)#interface ten-gigabitEthernet 1/0/1**

**Switch(config-if)#switchport voice vlan mode manual**

**Switch(config-if)#switchport voice vlan security**

**Switch(config-if)#switchport general allowed vlan 10 untagged**

**Switch(config-if)#show voice vlan**

Voice VLAN status: Enabled

VLAN ID: 10

Aging Time: 1440

Voice Priority: 5

**Switch(config-if)#show voice vlan switchport**

| Port    | Auto-mode | Security | State    | LAG   |
|---------|-----------|----------|----------|-------|
| -----   | -----     | -----    | -----    | ----- |
| Te1/0/1 | Manual    | Enabled  | Active   | N/A   |
| Te1/0/2 | Auto      | Disabled | Inactive | N/A   |
| Te1/0/3 | Auto      | Disabled | Inactive | N/A   |
| .....   |           |          |          |       |

**Switch(config-if)#end**

**Switch#copy running-config startup-config**

# 3 Configuration Example

## 3.1 Network Requirements

The company plans to install IP phones in the office area and the meeting room, and has requirements as follows:

- In the office area
  - » IP phones share switch ports used by computers, because no more ports are available for IP phones.
  - » Transmit voice traffic in an exclusive path with high quality.
  - » Avoid attacks from malicious data flows.
- In the meeting room
  - » Transmit voice traffic in an exclusive path with high quality.
  - » Avoid attacks from malicious data flows.

## 3.2 Configuration Scheme

In the office area, IP phones share the same ports of the switch with computers and therefore occupy no more ports. To separate voice traffic from data traffic, configure LLDP-MED to instruct IP Phones to send traffic with the voice VLAN tag. Voice traffic is transmitted in the voice VLAN, and data traffic is transmitted in the default VLAN. Set ports that are connected to IP phones in automatic voice VLAN mode. Meanwhile, configure the voice VLAN to work in security mode and to forward only legal voice packets.

In the meeting room, the switch provides dedicated connections to IP phones. In this situation, IP phones do not need to send traffic with the voice VLAN tag. Set ports that are connected to IP phones in manual voice VLAN mode. Meanwhile, configure the voice VLAN to work in security mode and to forward only legal voice packets.

To ensure the high quality of voice traffic, configure all devices along the path to keep the priority of voice traffic and to coordinate with the voice VLAN configuration.

## 3.3 Network Topology

In the office area, IP phones are added to ports that are connected to computers on Switch A. These ports use the voice VLAN for voice traffic, and the default VLAN for data traffic.

In the meeting room, computers and IP phones are connected to different ports of Switch B. Ports connected to IP phones use the voice VLAN for voice traffic, and ports connected to computers use the default VLAN for data traffic.

Voice traffics from Switch A and Switch B are forwarded to voice gateway and Internet through Switch C.

Figure 3-1 Network Topology

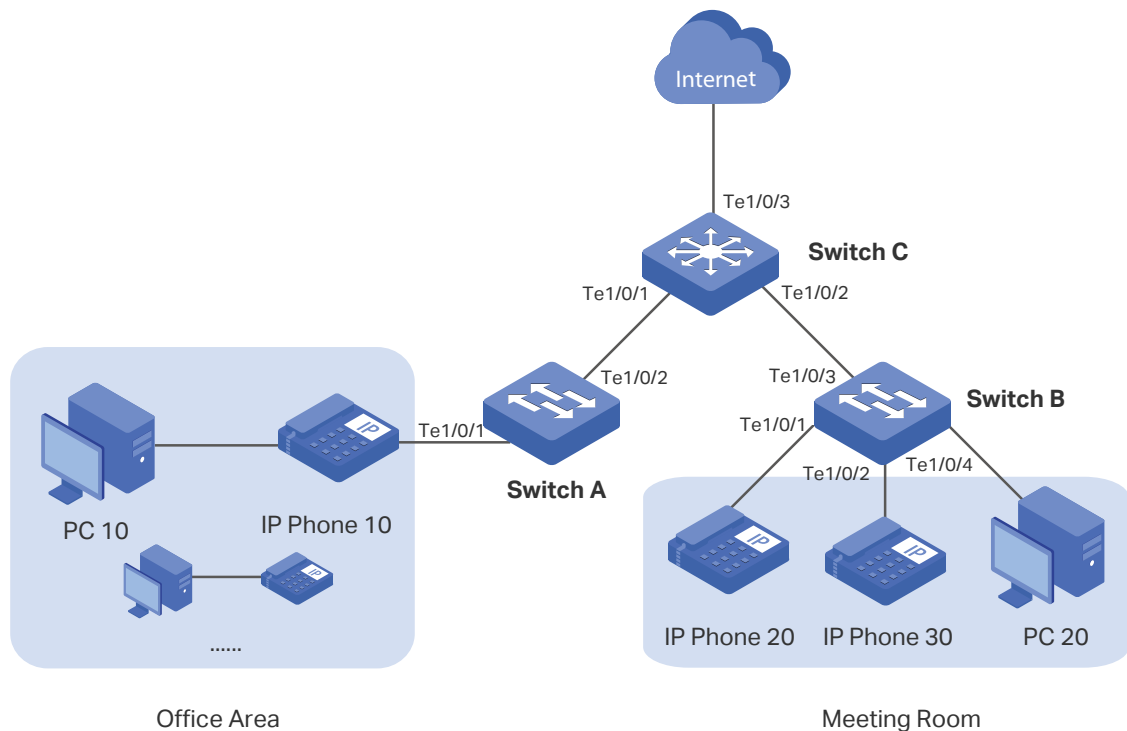

Demonstrated with T1700X-16TS, this chapter provides configuration procedures in two ways: using the GUI and using the CLI.

## 3.4 Using the GUI

### ■ Configurations for Switch A

- 1) Choose the menu **VLAN > 802.1Q VLAN > VLAN Config** and click **Create** to load the following page. Create VLAN 10.

Figure 3-2 Creating a VLAN

**VLAN Info**

VLAN ID:  (2 - 4094)

Name:  (16 characters maximum)

---

**Untagged port**

UNIT:  LAGS

|   |   |   |   |    |    |    |    |    |    |    |    |    |    |
|---|---|---|---|----|----|----|----|----|----|----|----|----|----|
| 2 | 4 | 6 | 8 | 10 | 12 | 14 | 16 | 18 | 20 | 22 | 24 | 26 | 28 |
| 1 | 3 | 5 | 7 | 9  | 11 | 13 | 15 | 17 | 19 | 21 | 23 | 25 | 27 |

---

**Tagged port**

UNIT:  LAGS

|   |   |   |   |    |    |    |    |    |    |    |    |    |    |
|---|---|---|---|----|----|----|----|----|----|----|----|----|----|
| 2 | 4 | 6 | 8 | 10 | 12 | 14 | 16 | 18 | 20 | 22 | 24 | 26 | 28 |
| 1 | 3 | 5 | 7 | 9  | 11 | 13 | 15 | 17 | 19 | 21 | 23 | 25 | 27 |

Unselected Port(s)

Selected Port(s)

Not Available for Selection

- 2) Choose the menu **QoS > Voice VLAN > Global Config** to load the following page. Enable voice VLAN, enter 10 in the **VLAN ID** field and set aging time as 1440 minutes and priority as 6. Then click **Apply**.

Figure 3-3 Configuring Voice VLAN Globally

**Global Config**

Voice VLAN:  Enable  Disable

VLAN ID:  (2 - 4094)

Aging Time:  min (1-43200, default: 1440)

Priority:  ▼

- 3) Choose the menu **QoS > Voice VLAN > Port Config** to load the following page. Select port 1/0/1, choose auto mode and enable security mode. Select port 1/0/2 and choose manual mode. Click **Apply**.



Figure 3-4 Configuring Voice VLAN Mode on Port 1/0/1

Port Config

UNIT: 1 LAGS

| Select                              | Port   | Port Mode | Security Mode | Member State | LAG |
|-------------------------------------|--------|-----------|---------------|--------------|-----|
| <input type="checkbox"/>            |        | Auto      | Enable        |              |     |
| <input checked="" type="checkbox"/> | 1/0/1  | Auto      | Disable       | Inactive     | --- |
| <input type="checkbox"/>            | 1/0/2  | Auto      | Disable       | Inactive     | --- |
| <input type="checkbox"/>            | 1/0/3  | Auto      | Disable       | Inactive     | --- |
| <input type="checkbox"/>            | 1/0/4  | Auto      | Disable       | Inactive     | --- |
| <input type="checkbox"/>            | 1/0/5  | Auto      | Disable       | Inactive     | --- |
| <input type="checkbox"/>            | 1/0/6  | Auto      | Disable       | Inactive     | --- |
| <input type="checkbox"/>            | 1/0/7  | Auto      | Disable       | Inactive     | --- |
| <input type="checkbox"/>            | 1/0/8  | Auto      | Disable       | Inactive     | --- |
| <input type="checkbox"/>            | 1/0/9  | Auto      | Disable       | Inactive     | --- |
| <input type="checkbox"/>            | 1/0/10 | Auto      | Disable       | Inactive     | --- |
| <input type="checkbox"/>            | 1/0/11 | Auto      | Disable       | Inactive     | --- |
| <input type="checkbox"/>            | 1/0/12 | Auto      | Disable       | Inactive     | --- |
| <input type="checkbox"/>            | 1/0/13 | Auto      | Disable       | Inactive     | --- |
| <input type="checkbox"/>            | 1/0/14 | Auto      | Disable       | Inactive     | --- |
| <input type="checkbox"/>            | 1/0/15 | Auto      | Disable       | Inactive     | --- |

Figure 3-5 Configuring Voice VLAN Mode on Port 1/0/2

Port Config

UNIT: 1 LAGS

| Select                              | Port   | Port Mode | Security Mode | Member State | LAG |
|-------------------------------------|--------|-----------|---------------|--------------|-----|
| <input type="checkbox"/>            |        | Manual    |               |              |     |
| <input type="checkbox"/>            | 1/0/1  | Auto      | Enable        | Inactive     | --- |
| <input checked="" type="checkbox"/> | 1/0/2  | Auto      | Disable       | Inactive     | --- |
| <input type="checkbox"/>            | 1/0/3  | Auto      | Disable       | Inactive     | --- |
| <input type="checkbox"/>            | 1/0/4  | Auto      | Disable       | Inactive     | --- |
| <input type="checkbox"/>            | 1/0/5  | Auto      | Disable       | Inactive     | --- |
| <input type="checkbox"/>            | 1/0/6  | Auto      | Disable       | Inactive     | --- |
| <input type="checkbox"/>            | 1/0/7  | Auto      | Disable       | Inactive     | --- |
| <input type="checkbox"/>            | 1/0/8  | Auto      | Disable       | Inactive     | --- |
| <input type="checkbox"/>            | 1/0/9  | Auto      | Disable       | Inactive     | --- |
| <input type="checkbox"/>            | 1/0/10 | Auto      | Disable       | Inactive     | --- |
| <input type="checkbox"/>            | 1/0/11 | Auto      | Disable       | Inactive     | --- |
| <input type="checkbox"/>            | 1/0/12 | Auto      | Disable       | Inactive     | --- |
| <input type="checkbox"/>            | 1/0/13 | Auto      | Disable       | Inactive     | --- |
| <input type="checkbox"/>            | 1/0/14 | Auto      | Disable       | Inactive     | --- |
| <input type="checkbox"/>            | 1/0/15 | Auto      | Disable       | Inactive     | --- |

- Choose the menu **VLAN > 802.1Q VLAN > VLAN Config** and edit VLAN 10 to load the following page. Add port 1/0/2 to the voice VLAN.

Figure 3-6 Adding Port 1/0/2 to the Voice VLAN

**VLAN Info**

VLAN ID:  (2 - 4094)

Name:  (16 characters maximum)

---

**Untagged port**

UNIT:  LAGS

|                            |                            |                            |                            |                             |                             |                             |                             |                             |                             |                             |                             |                             |                             |
|----------------------------|----------------------------|----------------------------|----------------------------|-----------------------------|-----------------------------|-----------------------------|-----------------------------|-----------------------------|-----------------------------|-----------------------------|-----------------------------|-----------------------------|-----------------------------|
| <input type="checkbox"/> 2 | <input type="checkbox"/> 4 | <input type="checkbox"/> 6 | <input type="checkbox"/> 8 | <input type="checkbox"/> 10 | <input type="checkbox"/> 12 | <input type="checkbox"/> 14 | <input type="checkbox"/> 16 | <input type="checkbox"/> 18 | <input type="checkbox"/> 20 | <input type="checkbox"/> 22 | <input type="checkbox"/> 24 | <input type="checkbox"/> 26 | <input type="checkbox"/> 28 |
| <input type="checkbox"/> 1 | <input type="checkbox"/> 3 | <input type="checkbox"/> 5 | <input type="checkbox"/> 7 | <input type="checkbox"/> 9  | <input type="checkbox"/> 11 | <input type="checkbox"/> 13 | <input type="checkbox"/> 15 | <input type="checkbox"/> 17 | <input type="checkbox"/> 19 | <input type="checkbox"/> 21 | <input type="checkbox"/> 23 | <input type="checkbox"/> 25 | <input type="checkbox"/> 27 |

---

**Tagged port**

UNIT:  LAGS

|                                       |                            |                            |                            |                             |                             |                             |                             |                             |                             |                             |                             |                             |                             |
|---------------------------------------|----------------------------|----------------------------|----------------------------|-----------------------------|-----------------------------|-----------------------------|-----------------------------|-----------------------------|-----------------------------|-----------------------------|-----------------------------|-----------------------------|-----------------------------|
| <input checked="" type="checkbox"/> 2 | <input type="checkbox"/> 4 | <input type="checkbox"/> 6 | <input type="checkbox"/> 8 | <input type="checkbox"/> 10 | <input type="checkbox"/> 12 | <input type="checkbox"/> 14 | <input type="checkbox"/> 16 | <input type="checkbox"/> 18 | <input type="checkbox"/> 20 | <input type="checkbox"/> 22 | <input type="checkbox"/> 24 | <input type="checkbox"/> 26 | <input type="checkbox"/> 28 |
| <input type="checkbox"/> 1            | <input type="checkbox"/> 3 | <input type="checkbox"/> 5 | <input type="checkbox"/> 7 | <input type="checkbox"/> 9  | <input type="checkbox"/> 11 | <input type="checkbox"/> 13 | <input type="checkbox"/> 15 | <input type="checkbox"/> 17 | <input type="checkbox"/> 19 | <input type="checkbox"/> 21 | <input type="checkbox"/> 23 | <input type="checkbox"/> 25 | <input type="checkbox"/> 27 |

Unselected Port(s)   
  Selected Port(s)   
  Not Available for Selection

- Choose the menu **LLDP > Basic Config > Global Config** to load the following page. Enable LLDP globally.

Figure 3-7 Enabling LLDP Globally

**Global Config**

LLDP:  Enable  Disable

- Choose the menu **LLDP > LLDP-MED > Global Config** to load the following page. Set fast start count as 4.

Figure 3-8 Configuring LLDP-MED Globally

**LLDP-MED Parameters Config**

Fast Start Count:  (1-10)

Device Class: Network Connectivity

- Choose the menu **LLDP > LLDP-MED > Port Config** to load the following page. Enable LLDP-MED on port 1/0/1.

Figure 3-9 Configuring LLDP-MED on Ports

**LLDP-MED Port Config**

UNIT: **1**

| Select                              | Port   | LLDP-MED Status | Included TLVs          |
|-------------------------------------|--------|-----------------|------------------------|
| <input type="checkbox"/>            |        | Enable ▾        |                        |
| <input checked="" type="checkbox"/> | 1/0/1  | Disable         | <a href="#">Detail</a> |
| <input type="checkbox"/>            | 1/0/2  | Disable         | <a href="#">Detail</a> |
| <input type="checkbox"/>            | 1/0/3  | Disable         | <a href="#">Detail</a> |
| <input type="checkbox"/>            | 1/0/4  | Disable         | <a href="#">Detail</a> |
| <input type="checkbox"/>            | 1/0/5  | Disable         | <a href="#">Detail</a> |
| <input type="checkbox"/>            | 1/0/6  | Disable         | <a href="#">Detail</a> |
| <input type="checkbox"/>            | 1/0/7  | Disable         | <a href="#">Detail</a> |
| <input type="checkbox"/>            | 1/0/8  | Disable         | <a href="#">Detail</a> |
| <input type="checkbox"/>            | 1/0/9  | Disable         | <a href="#">Detail</a> |
| <input type="checkbox"/>            | 1/0/10 | Disable         | <a href="#">Detail</a> |
| <input type="checkbox"/>            | 1/0/11 | Disable         | <a href="#">Detail</a> |
| <input type="checkbox"/>            | 1/0/12 | Disable         | <a href="#">Detail</a> |
| <input type="checkbox"/>            | 1/0/13 | Disable         | <a href="#">Detail</a> |
| <input type="checkbox"/>            | 1/0/14 | Disable         | <a href="#">Detail</a> |
| <input type="checkbox"/>            | 1/0/15 | Disable         | <a href="#">Detail</a> |

Click **Detail** of port1/0/1 to load the following page. Configure the TLV information which will be carried in LLDP-MED frames and sent out by port 1/0/1. Select all TLVs, and configure location identification parameters.

Figure 3-10 Configuring TLVs

| Included TLVs                                      |                                                             |                                                            |
|----------------------------------------------------|-------------------------------------------------------------|------------------------------------------------------------|
| <input checked="" type="checkbox"/> Network Policy | <input checked="" type="checkbox"/> Location Identification | <input checked="" type="checkbox"/> Extended Power-Via-MDI |
| <input checked="" type="checkbox"/> Inventory      | <input checked="" type="checkbox"/> All                     |                                                            |

| Location Identification Parameters                                                                                      |                                                |
|-------------------------------------------------------------------------------------------------------------------------|------------------------------------------------|
| <input type="checkbox"/> Emergency Number:                                                                              | <input type="text"/> Chars.(10-25)             |
| <input checked="" type="checkbox"/> Civic Address                                                                       |                                                |
| What:                                                                                                                   | <input type="text" value="Switch"/>            |
| Country Code:                                                                                                           | <input type="text" value="CN China(Default)"/> |
| Language:                                                                                                               | <input type="text"/>                           |
| Province/State:                                                                                                         | <input type="text"/>                           |
| County/Parish/District:                                                                                                 | <input type="text"/>                           |
| City/Township:                                                                                                          | <input type="text"/>                           |
| Street:                                                                                                                 | <input type="text"/>                           |
| House Number:                                                                                                           | <input type="text"/>                           |
| Name:                                                                                                                   | <input type="text"/>                           |
| Postal/Zip Code:                                                                                                        | <input type="text"/>                           |
| Room Number:                                                                                                            | <input type="text"/>                           |
| Post Office Box:                                                                                                        | <input type="text"/>                           |
| Additional Information:                                                                                                 | <input type="text"/>                           |
| <input type="button" value="Back"/> <input checked="" type="button" value="Apply"/> <input type="button" value="Help"/> |                                                |

For details about LLDP-MED, please refer to [Configuring LLDP](#).

8) Click **Save Config** to save the settings.

#### ■ Configurations for Switch B

1) Choose the menu **VLAN > 802.1Q VLAN > VLAN Config** and click **Create** to load the following page. Create VLAN 10.

Figure 3-11 Creating a VLAN

**VLAN Info**

VLAN ID:  (2 - 4094)

Name:  (16 characters maximum)

- 2) Choose the menu **QoS > Voice VLAN > Global Config** to load the following page. Enable voice VLAN, enter 10 in the **VLAN ID** field and set priority as 6.

Figure 3-12 Configuring Voice VLAN Globally

**Global Config**

Voice VLAN:  Enable  Disable

VLAN ID:  (2 - 4094)

Ageing Time:  min (1-43200, default: 1440)

Priority:

- 3) Choose the menu **QoS > Voice VLAN > Port Config** to load the following page. Select ports 1/0/1-3, choose manual mode and enable security mode.

Figure 3-13 Configuring Voice VLAN Mode on Ports

**Port Config**

UNIT:  LAGS

| Select                              | Port   | Port Mode                           | Security Mode                       | Member State | LAG |
|-------------------------------------|--------|-------------------------------------|-------------------------------------|--------------|-----|
| <input type="checkbox"/>            |        | <input type="text" value="Manual"/> | <input type="text" value="Enable"/> |              |     |
| <input checked="" type="checkbox"/> | 1/0/1  | Auto                                | Disable                             | Inactive     | --- |
| <input checked="" type="checkbox"/> | 1/0/2  | Auto                                | Disable                             | Inactive     | --- |
| <input checked="" type="checkbox"/> | 1/0/3  | Auto                                | Disable                             | Inactive     | --- |
| <input type="checkbox"/>            | 1/0/4  | Auto                                | Disable                             | Inactive     | --- |
| <input type="checkbox"/>            | 1/0/5  | Auto                                | Disable                             | Inactive     | --- |
| <input type="checkbox"/>            | 1/0/6  | Auto                                | Disable                             | Inactive     | --- |
| <input type="checkbox"/>            | 1/0/7  | Auto                                | Disable                             | Inactive     | --- |
| <input type="checkbox"/>            | 1/0/8  | Auto                                | Disable                             | Inactive     | --- |
| <input type="checkbox"/>            | 1/0/9  | Auto                                | Disable                             | Inactive     | --- |
| <input type="checkbox"/>            | 1/0/10 | Auto                                | Disable                             | Inactive     | --- |
| <input type="checkbox"/>            | 1/0/11 | Auto                                | Disable                             | Inactive     | --- |
| <input type="checkbox"/>            | 1/0/12 | Auto                                | Disable                             | Inactive     | --- |
| <input type="checkbox"/>            | 1/0/13 | Auto                                | Disable                             | Inactive     | --- |
| <input type="checkbox"/>            | 1/0/14 | Auto                                | Disable                             | Inactive     | --- |
| <input type="checkbox"/>            | 1/0/15 | Auto                                | Disable                             | Inactive     | --- |

- 4) Choose the menu **VLAN > 802.1Q VLAN > VLAN Config** and edit VLAN 10 to load the following page. Add ports 1/0/1-3 to the voice VLAN.

Figure 3-14 Adding Ports to the Voice VLAN

**VLAN Info**

VLAN ID:  (2 - 4094)

Name:  (16 characters maximum)

---

**Untagged port**

UNIT:  LAGS

|                                       |                            |                            |                            |                             |                             |                             |                             |                             |                             |                             |                             |                             |                             |
|---------------------------------------|----------------------------|----------------------------|----------------------------|-----------------------------|-----------------------------|-----------------------------|-----------------------------|-----------------------------|-----------------------------|-----------------------------|-----------------------------|-----------------------------|-----------------------------|
| <input checked="" type="checkbox"/> 2 | <input type="checkbox"/> 4 | <input type="checkbox"/> 6 | <input type="checkbox"/> 8 | <input type="checkbox"/> 10 | <input type="checkbox"/> 12 | <input type="checkbox"/> 14 | <input type="checkbox"/> 16 | <input type="checkbox"/> 18 | <input type="checkbox"/> 20 | <input type="checkbox"/> 22 | <input type="checkbox"/> 24 | <input type="checkbox"/> 26 | <input type="checkbox"/> 28 |
| <input checked="" type="checkbox"/> 1 | <input type="checkbox"/> 3 | <input type="checkbox"/> 5 | <input type="checkbox"/> 7 | <input type="checkbox"/> 9  | <input type="checkbox"/> 11 | <input type="checkbox"/> 13 | <input type="checkbox"/> 15 | <input type="checkbox"/> 17 | <input type="checkbox"/> 19 | <input type="checkbox"/> 21 | <input type="checkbox"/> 23 | <input type="checkbox"/> 25 | <input type="checkbox"/> 27 |

---

**Tagged port**

UNIT:  LAGS

|                            |                                       |                            |                            |                             |                             |                             |                             |                             |                             |                             |                             |                             |                             |
|----------------------------|---------------------------------------|----------------------------|----------------------------|-----------------------------|-----------------------------|-----------------------------|-----------------------------|-----------------------------|-----------------------------|-----------------------------|-----------------------------|-----------------------------|-----------------------------|
| <input type="checkbox"/> 2 | <input type="checkbox"/> 4            | <input type="checkbox"/> 6 | <input type="checkbox"/> 8 | <input type="checkbox"/> 10 | <input type="checkbox"/> 12 | <input type="checkbox"/> 14 | <input type="checkbox"/> 16 | <input type="checkbox"/> 18 | <input type="checkbox"/> 20 | <input type="checkbox"/> 22 | <input type="checkbox"/> 24 | <input type="checkbox"/> 26 | <input type="checkbox"/> 28 |
| <input type="checkbox"/> 1 | <input checked="" type="checkbox"/> 3 | <input type="checkbox"/> 5 | <input type="checkbox"/> 7 | <input type="checkbox"/> 9  | <input type="checkbox"/> 11 | <input type="checkbox"/> 13 | <input type="checkbox"/> 15 | <input type="checkbox"/> 17 | <input type="checkbox"/> 19 | <input type="checkbox"/> 21 | <input type="checkbox"/> 23 | <input type="checkbox"/> 25 | <input type="checkbox"/> 27 |

Unselected Port(s)  
 Selected Port(s)  
 Not Available for Selection

5) Click **Save Config** to save the settings.

▪ **Configurations for Switch C**

1) Choose the menu **VLAN > 802.1Q VLAN > VLAN Config** and click **Create** to load the following page. Create VLAN 10 and add ports 1/0/1-3 as tagged ports to the VLAN.

Figure 3-15 Creating a VLAN and Adding Ports to the VLAN

**VLAN Info**

VLAN ID:  (2 - 4094)

Name:  (16 characters maximum)

**Untagged port**

UNIT:  LAGS

|   |   |   |   |    |    |    |    |    |    |    |    |    |    |
|---|---|---|---|----|----|----|----|----|----|----|----|----|----|
| 2 | 4 | 6 | 8 | 10 | 12 | 14 | 16 | 18 | 20 | 22 | 24 | 26 | 28 |
| 1 | 3 | 5 | 7 | 9  | 11 | 13 | 15 | 17 | 19 | 21 | 23 | 25 | 27 |

**Tagged port**

UNIT:  LAGS

|   |   |   |   |    |    |    |    |    |    |    |    |    |    |
|---|---|---|---|----|----|----|----|----|----|----|----|----|----|
| 2 | 4 | 6 | 8 | 10 | 12 | 14 | 16 | 18 | 20 | 22 | 24 | 26 | 28 |
| 1 | 3 | 5 | 7 | 9  | 11 | 13 | 15 | 17 | 19 | 21 | 23 | 25 | 27 |

Unselected Port(s)
 Selected Port(s)
 Not Available for Selection

- 2) Click **Save Config** to save the settings.

## 3.5 Using the CLI

- Configurations for Switch A

- 1) Create VLAN 10.

```
Switch_A#configure
```

```
Switch_A(config)#vlan 10
```

```
Switch_A(config-vlan)#name VoiceVLAN
```

```
Switch_A(config-vlan)#exit
```

- 2) Configure the aging time as 1440 minutes for port in automatic voice VLAN mode, and set the 802.1p priority of voice packets as 6. Set VLAN 10 as the voice VLAN.

```
Switch_A(config)#voice vlan aging 1440
```

```
Switch_A(config)#voice vlan priority 6
```

```
Switch_A(config)#voice vlan 10
```

- 3) Configure port 1/0/1 to automatic voice VLAN mode and enable security mode.

```
Switch_A(config)#interface ten-gigabitEthernet 1/0/1
```

```
Switch_A(config-if)#switchport voice vlan mode auto
```

```
Switch_A(config-if)#switchport voice vlan security
```

```
Switch_A(config-if)#exit
```

- 4) Configure port 1/0/2 to manual voice VLAN mode, and add it to the voice VLAN as a tagged port.

```
Switch_A(config)#interface ten-gigabitEthernet 1/0/2
```

```
Switch_A(config-if)#switchport voice vlan mode manual
```

```
Switch_A(config-if)#switchport general allowed vlan 10 tagged
```

```
Switch_A(config-if)#exit
```

- 5) Enable LLDP globally and set the fast start count of LLDP-MED frame as 4.

```
Switch_A(config)#lldp
```

```
Switch_A(config)#lldp med-fast-count 4
```

- 6) Enable the LLDP-MED feature on port 1/0/1.

```
Switch_A(config)#interface ten-gigabitEthernet 1/0/1
```

```
Switch_A(config-if)#lldp med-status
```

- 7) Select all MED TLVs to be carried in LLDP frames and sent out by port 1/0/1.

```
Switch_A(config-if)#lldp med-tlv-select all
```

- 8) Configure the location identification parameters for the IP phone on port 1/0/1. For details about LLDP-MED, please refer to [Configuring LLDP](#).

```
Switch(config-if)#lldp med-location civic-address language English city  
Vancouver street X east hastings street postal-zipcode V6A 1P9
```

```
Switch_A(config-if)#end
```

```
Switch_A#copy running-config startup-config
```

#### ■ Configurations for Switch B

- 1) Create VLAN 10.

```
Switch_B#configure
```

```
Switch_B(config)#vlan 10
```

```
Switch_B(config-vlan)#name VoiceVLAN
```

```
Switch_B(config-vlan)#exit
```

- 2) Set the 802.1p priority of voice packets as 6 and VLAN 10 as the voice VLAN.

```
Switch_B(config)#voice vlan priority 6
```

```
Switch_B(config)#voice vlan 10
```



- 3) Configure ports 1/0/1-3 to manual voice VLAN mode and enable security mode.

```
Switch_B(config)#interface range ten-gigabitEthernet 1/0/1-3
Switch_B(config-if-range)#switchport voice vlan mode manual
Switch_B(config-if-range)#switchport voice vlan security
Switch_B(config-if-range)#exit
```

- 4) Add ports 1/0/1-3 to the voice VLAN.

```
Switch_B(config)#interface range ten-gigabitEthernet 1/0/1-2
Switch_B(config-if-range)#switchport general vlan 10 untagged
Switch_B(config-if-range)#exit
Switch_B(config)#interface ten-gigabitEthernet 1/0/3
Switch_B(config-if)#switchport general allowed vlan 10 tagged
Switch_B(config-if)#end
Switch_B#copy running-config startup-config
```

#### ■ Configurations for Switch C

- 1) Create VLAN 10 and add ports 1/0/1-3 to the VLAN.

```
Switch_C#configure
Switch_C(config)#vlan 10
Switch_C(config-vlan)#name VoiceVLAN
Switch_C(config-vlan)#exit
Switch_C(config)#interface range ten-gigabitEthernet 1/0/1-3
Switch_C(config-if-range)#switchport general allowed vlan 10 tagged
Switch_C(config-if-range)#end
Switch_C#copy running-config startup-config
```

### Verify the Configurations

#### ■ Switch A

Verify the global configuration of voice VLAN:

```
Switch_A#show voice vlan
Voice VLAN status: Enabled
VLAN ID: 10
Aging Time: 1440
```

Voice Priority: 6

Verify the voice VLAN configuration on the ports:

Switch\_A#show voice vlan switchport

| Port    | Auto-mode | Security | State    | LAG |
|---------|-----------|----------|----------|-----|
| Te1/0/1 | Auto      | Enabled  | Inactive | N/A |
| Te1/0/2 | Manual    | Disabled | Active   | N/A |
| Te1/0/3 | Auto      | Disabled | Inactive | N/A |

.....

- Switch B

Verify the global configuration of voice VLAN:

Switch\_B#show voice vlan

Voice VLAN status: Enabled

VLAN ID: 10

Aging Time: 1440

Voice Priority: 6

Verify the voice VLAN configuration on the ports:

Switch\_B#show voice vlan switchport

| Port    | Auto-mode | Security | State  | LAG |
|---------|-----------|----------|--------|-----|
| Te1/0/1 | Manual    | Enabled  | Active | N/A |
| Te1/0/2 | Manual    | Enabled  | Active | N/A |
| Te1/0/3 | Manual    | Enabled  | Active | N/A |

.....

- Switch C

Verify the voice VLAN configuration for VLAN 10:

Switch\_C#show vlan id 10

| VLAN | Name      | Status | Ports                     |
|------|-----------|--------|---------------------------|
| 10   | VoiceVlan | active | Te1/0/1, Te1/0/2, Te1/0/3 |

# 4 Appendix: Default Parameters

Default settings of voice VLAN are listed in the following tables.

Table 4-1 Default Settings of Global Configuration

| Parameter  | Default Setting |
|------------|-----------------|
| Voice VLAN | Disable         |
| VLAN ID    | None            |
| Aging Time | 1440 minutes    |
| Priority   | 6               |

Table 4-2 Default Settings of Port Configuration

| Parameter     | Default Setting |
|---------------|-----------------|
| Port Mode     | Auto            |
| Security Mode | Disable         |
| Member State  | Inactive        |

Table 4-3 Entries in the OUI Table

| OUI               | MASK              | Description   |
|-------------------|-------------------|---------------|
| 00-01-e3-00-00-00 | ff-ff-ff-00-00-00 | Siemens Phone |
| 00-03-6b-00-00-00 | ff-ff-ff-00-00-00 | Cisco Phone   |
| 00-04-0d-00-00-00 | ff-ff-ff-00-00-00 | Avaya Phone   |
| 00-60-b9-00-00-00 | ff-ff-ff-00-00-00 | Philips Phone |
| 00-d0-1e-00-00-00 | ff-ff-ff-00-00-00 | Pingtel Phone |
| 00-e0-75-00-00-00 | ff-ff-ff-00-00-00 | PolyCom Phone |
| 00-e0-bb-00-00-00 | ff-ff-ff-00-00-00 | 3Com Phone    |

# Part 19

## Configuring ACL

### CHAPTERS

1. ACL
2. ACL Configurations
3. Configuration Example for ACL
4. Appendix: Default Parameters

# 1 ACL

## 1.1 Overview

The rapid growth of network size and traffic brings challenges to network security and bandwidth allocation. Packet filtering can help prevent unauthorized access behaviors, limit network traffic and improve bandwidth use.

ACL (Access Control List) filters traffic as it passes through a switch, and permits or denies packets crossing specified interfaces or VLANs. It accurately identifies and processes the packets based on the ACL rules. In this way, ACL ensures security and high service quality of networks.

ACL helps to:

- Prevent various network attacks, such as attacks caused by IP (Internet Protocol), TCP (Transmission Control Protocol), and ICMP (Internet Control Message Protocol) packets.
- Manage network access behaviors, such as controlling access to a network or to specific resources in your network.

## 1.2 Supported Features

### ACL Binding

An ACL takes effect after it is directly bound to an interface or VLAN. After ACL binding, the packets that match a permit rule or deny rule will be forwarded or discarded.

### Policy Binding

An ACL also takes effect when it is applied to a policy which is bound to an interface or VLAN. After policy binding, the packets that match a permit rule or deny rule will be forwarded or discarded.

# 2 ACL Configurations

To configure ACL Binding, follow these steps:

- 1) Create an ACL and configure the rules.
- 2) Bind the ACL to a port or VLAN.

To configure Policy Binding, follow these steps:

- 1) Create an ACL and configure the rules.
- 2) Create a Policy and configure the policy action.
- 3) Bind the Policy to a port or VLAN.

## Configuration Guidelines

- A packet “matches” an ACL rule when it meets the rule’s matching criteria, no matter the operation to be performed is “permit” or “deny”.
- If no ACL rule is configured or no matching rule is found, the packets will be forwarded without being processed by the ACL.

## 2.1 Using the GUI

### 2.1.1 Creating an ACL

You can create different types of ACL and define the rules based on source MAC or IP address, destination MAC or IP address, protocol type and so on.

**MAC ACL:** MAC ACL uses source and destination MAC addresses for matching operations.

**Standard-IP ACL:** Standard-IP ACL uses source and destination IP addresses for matching operations.

**Extended-IP ACL:** Extended-IP ACL uses source and destination IP addresses, IP protocols and so on for matching operations.

Choose the menu **ACL > ACL Config > ACL Create** to load the following page.

Figure 2-1 Creating an ACL

**ACL Create**

ACL ID:

0-499 MAC ACL  
500-1499 Standard-IP ACL  
1500-2499 Extend-IP ACL  
3500-4499 IPv6 ACL

Rule Order:

Follow these steps to create an ACL:

- 1) Enter a number to identify the ACL.

|        |                                     |
|--------|-------------------------------------|
| ACL ID | Enter a number to identify the ACL. |
|--------|-------------------------------------|

- 2) Click **Apply**.

## 2.1.2 Configuring ACL Rules

Add rules to the ACL. For details, refer to “*Configuring the MAC ACL Rule*”, “*Configuring the Standard-IP ACL Rule*”, “*Configuring the Extend-IP ACL Rule*”, and “*Configuring the IPv6 ACL Rule*”.

### ■ Configuring the MAC ACL Rule

Choose the menu **ACL > ACL Config > MAC ACL** to load the following page.

Figure 2-2 Creating the MAC ACL Rule

**Create MAC-Rule**

ACL ID:

Rule ID:  (0-999)

Operation:

S-MAC:  Mask:  (Format: 00-00-00-00-00-01)

D-MAC:  Mask:

Follow these steps to create the MAC ACL rule:

- 1) Select an MAC ACL from the drop-down list, enter a Rule ID, and specify the operation for the matched packets.



|           |                                                                                                                                                                               |
|-----------|-------------------------------------------------------------------------------------------------------------------------------------------------------------------------------|
| ACL ID    | Select an MAC ACL from the drop-down list.                                                                                                                                    |
| Rule ID   | Specify the rule ID, which ranges from 0 to 999.<br><br>It should not be the same as any existing MAC ACL Rule IDs.                                                           |
| Operation | Select an operation to be performed when a packet matches the rule.<br><br><b>Permit:</b> To forward the matched packets.<br><br><b>Deny:</b> To discard the matched packets. |

2) Configure the rule's packet-matching criteria.

|            |                                                                                                                                             |
|------------|---------------------------------------------------------------------------------------------------------------------------------------------|
| S-MAC/Mask | Enter the source MAC address with a mask. A value of 1 in the mask indicates that the corresponding bit in the address will be matched.     |
| D-MAC/Mask | Enter the destination IP address with a mask. A value of 1 in the mask indicates that the corresponding bit in the address will be matched. |

3) Click **Apply**.

■ **Configuring the Standard-IP ACL Rule**

Choose the menu **ACL > ACL Config > Standard-IP ACL** to load the following page.

Figure 2-3 Creating the Standard-IP ACL Rule

**Create Standard-IP Rule**

ACL ID:  ▼

Rule ID:  (0-1999)

Operation:  ▼

S-IP:  Mask:  (Format: 192.168.0.1)

D-IP:  Mask:

Follow these steps to create the Standard-IP ACL rule:

- 1) Select a Standard-IP ACL from the drop-down list, enter a Rule ID, and specify the operation for the matched packets.

|         |                                                                                                                              |
|---------|------------------------------------------------------------------------------------------------------------------------------|
| ACL ID  | Select a Standard-IP ACL from the drop-down list.                                                                            |
| Rule ID | Specify the rule ID, which ranges from 0 to 1999.<br><br>It should not be the same as any existing Standard-IP ACL Rule IDs. |

|                  |                                                                                                                                                                               |
|------------------|-------------------------------------------------------------------------------------------------------------------------------------------------------------------------------|
| <b>Operation</b> | Select an operation to be performed when a packet matches the rule.<br><br><b>Permit:</b> To forward the matched packets.<br><br><b>Deny:</b> To discard the matched packets. |
|------------------|-------------------------------------------------------------------------------------------------------------------------------------------------------------------------------|

2) Configure the rule’s packet-matching criteria.

|                  |                                                                                                                                               |
|------------------|-----------------------------------------------------------------------------------------------------------------------------------------------|
| <b>S-IP/Mask</b> | Specify the source IP address with a mask. A value of 1 in the mask indicates that the corresponding bit in the address will be matched.      |
| <b>D-IP/Mask</b> | Specify the destination IP address with a mask. A value of 1 in the mask indicates that the corresponding bit in the address will be matched. |

3) Click **Apply**.

■ **Configuring the Extend-IP ACL Rule**

Choose the menu **ACL > ACL Config > Extend-IP ACL** to load the following page.

Figure 2-4 Creating the Extend-IP ACL Rule

**Create Extend-IP Rule**

ACL ID:  (v)

Rule ID:  (0-1999)

Operation:  (v)

S-IP:  Mask:  (Format: 192.168.0.1)

D-IP:  Mask:

IP Protocol:  (v)

S-Port:

D-Port:

Follow these steps to create the Extend-IP ACL rule:

1) Select an Extend-IP ACL from the drop-down list, enter a Rule ID, and specify the operation for the matched packets.

|                  |                                                                                                                                                                               |
|------------------|-------------------------------------------------------------------------------------------------------------------------------------------------------------------------------|
| <b>ACL ID</b>    | Select a Extend-IP ACL ACL from the drop-down list.                                                                                                                           |
| <b>Rule ID</b>   | Specify the rule ID, which ranges from 0 to 1999.<br><br>It should not be the same as any existing Extend-IP ACL ACL Rule IDs.                                                |
| <b>Operation</b> | Select an operation to be performed when a packet matches the rule.<br><br><b>Permit:</b> To forward the matched packets.<br><br><b>Deny:</b> To discard the matched packets. |

2) Configure the rule’s packet-matching criteria.

|                 |                                                                                                                                               |
|-----------------|-----------------------------------------------------------------------------------------------------------------------------------------------|
| S-IP/Mask       | Specify the source IP address with a mask. A value of 1 in the mask indicates that the corresponding bit in the address will be matched.      |
| D-IP/Mask       | Specify the destination IP address with a mask. A value of 1 in the mask indicates that the corresponding bit in the address will be matched. |
| IP Protocol     | Select a protocol type from the drop-down list. The default is All, which indicates that packets of all protocols will be matched.            |
| S-Port / D-Port | Enter the TCP/UDP source and destination port if TCP/UDP protocol is selected. The port number ranges from 0 to 65535.                        |

3) Click **Apply**.

■ **Configuring the IPv6 ACL Rule**

Choose the menu **ACL > ACL Config > IPv6 ACL** to load the following page.

Figure 2-5 Creating the IPv6 ACL Rule

**Create IPv6 Rule**

ACL ID:  ▼

Rule ID:  (0-999)

Operation:  ▼

DSCP:  (0-63)

Flow Label:  (5-hex number)

IPv6 Source IP: (Format: FE80::1)

S-IP:

Mask:

IPv6 Destination IP:

D-IP:

Mask:

S-Port:  (0-65535)

D-Port:

Follow these steps to create the IPv6 ACL rule:

- 1) Select an IPv6 ACL from the drop-down list, enter a Rule ID, and specify the operation for the rule.

|        |                                             |
|--------|---------------------------------------------|
| ACL ID | Select an IPv6 ACL from the drop-down list. |
|--------|---------------------------------------------|

|           |                                                                                                                                                                               |
|-----------|-------------------------------------------------------------------------------------------------------------------------------------------------------------------------------|
| Rule ID   | Specify the rule ID, which ranges from 0 to 999.<br><br>It should not be the same as any existing IPv6 ACL Rule IDs.                                                          |
| Operation | Select an operation to be performed when a packet matches the rule.<br><br><b>Permit:</b> To forward the matched packets.<br><br><b>Deny:</b> To discard the matched packets. |

## 2) Configure the rule's packet-matching criteria.

|                     |                                                                                                                                                                                                                                                                                                                               |
|---------------------|-------------------------------------------------------------------------------------------------------------------------------------------------------------------------------------------------------------------------------------------------------------------------------------------------------------------------------|
| DSCP                | Specify a DSCP value to be matched.                                                                                                                                                                                                                                                                                           |
| Flow Label          | Specify a Flow Label value to be matched.                                                                                                                                                                                                                                                                                     |
| IPv6 Source IP      | When selected, enter the source IP address with a mask.                                                                                                                                                                                                                                                                       |
| S-IP                | Enter the source IPv6 address to be matched. All types of IPv6 address will be checked. You may enter a complete 128-bit IPv6 address but only the first 64 bits will be valid.                                                                                                                                               |
| Mask                | The mask is required if the source IPv6 address is entered. Enter the mask in complete format (for example, ffff:ffff:0000:ffff).<br><br>The IP address mask specifies which bits in the source IPv6 address to match the rule. A value of 1 in the mask indicates that the corresponding bit in the address will be matched. |
| IPv6 Destination IP | When selected, enter the destination IPv6 address with a mask.                                                                                                                                                                                                                                                                |
| D-IP                | Enter the destination IPv6 address to be matched. All types of IPv6 address will be checked. You may enter a complete 128-bit IPv6 address but only the first 64 bits will be valid.                                                                                                                                          |
| Mask                | The mask is required if the destination IPv6 address is entered. Enter the complete mask (for example, ffff:ffff:0000:ffff).<br><br>The IP address mask specifies which bits in the source IP address to match the rule. A value of 1 in the mask indicates that the corresponding bit in the address will be matched.        |
| S-Port / D-Port     | Enter the TCP/UDP source and destination port.                                                                                                                                                                                                                                                                                |

## 3) Click **Apply**.

### ■ Verifying the Rule Table

The rules in an ACL are listed in ascending order of configuration time, regardless of their rule IDs. By default, a rule configured earlier is listed before a rule configured later. The switch matches a received packet with the rules in order. When a packet matches a rule, the device stops the match process and performs the action defined in the rule.

In the ACL rule table, you can view all the ACLs and their rules. You can also delete an ACL or an ACL rule, or change the matching order if needed.

Choose the menu **ACL > ACL Config > ACL Summary** to load the following page.

Figure 2-6 ACL Information

| Search Options                                                                                               |             |         |                                       |               |                           |  |
|--------------------------------------------------------------------------------------------------------------|-------------|---------|---------------------------------------|---------------|---------------------------|--|
| Select an ACL:                                                                                               | ACL 2       |         |                                       |               |                           |  |
| ACL Type:                                                                                                    | MAC ACL     |         | <input type="button" value="Delete"/> |               |                           |  |
| Rule Order:                                                                                                  | User Config |         |                                       |               |                           |  |
| Rule Table                                                                                                   |             |         |                                       |               |                           |  |
| Select                                                                                                       | Index       | Rule ID | S-MAC Address                         | D-MAC Address | Operation                 |  |
| <input type="checkbox"/>                                                                                     | 1           | 1       | ---                                   | ---           | Edit   Detail   Up   Down |  |
| <input type="button" value="All"/> <input type="button" value="Delete"/> <input type="button" value="Help"/> |             |         |                                       |               |                           |  |

### 2.1.3 Configuring Policy

To configure the policy, follow these steps:

- 1) Create a policy.
- 2) Apply an ACL to the Policy.

#### ■ Creating a Policy

Choose the menu **ACL > Policy Config > Policy Create** to load the following page.

Figure 2-7 Creating a Policy

| Create Policy |                                                                             |
|---------------|-----------------------------------------------------------------------------|
| Policy Name:  | <input type="button" value="Apply"/><br><input type="button" value="Help"/> |

Follow these steps to create a policy:

Enter a Policy Name, and click **Apply**.

|             |                                                  |
|-------------|--------------------------------------------------|
| Policy Name | Enter a Policy Name between 1 and 16 characters. |
|-------------|--------------------------------------------------|

#### ■ Applying an ACL to the Policy

Choose the menu **ACL > Policy Config > Action Create** to load the following page.

Figure 2-8 Configuring the Action of the Policy

| Create Action:                                                           |       |
|--------------------------------------------------------------------------|-------|
| Select Policy:                                                           | 1     |
| Select ACL:                                                              | ACL 2 |
| <input type="button" value="Apply"/> <input type="button" value="Help"/> |       |

Follow these steps to configure the action of the policy:

Select your preferred policy and ACL, and click **Apply**.

|               |                                            |
|---------------|--------------------------------------------|
| Select Policy | Select a Policy from the drop-down list.   |
| Select ACL    | Select an ACL to be applied to the Policy. |

### 2.1.4 Configuring the ACL Binding and Policy Binding

You can select ACL binding or Policy binding according to your needs. An ACL or Policy takes effect only after it is bound to a port or VLAN.

#### Configuring the ACL Binding

You can bind the ACL to a port or a VLAN. The received packets will then be matched and processed according to the ACL rules.

- Binding the ACL to a Port

Choose the menu **ACL > ACL Binding > Port Binding** to load the following page.

Figure 2-9 Binding the ACL to a Port

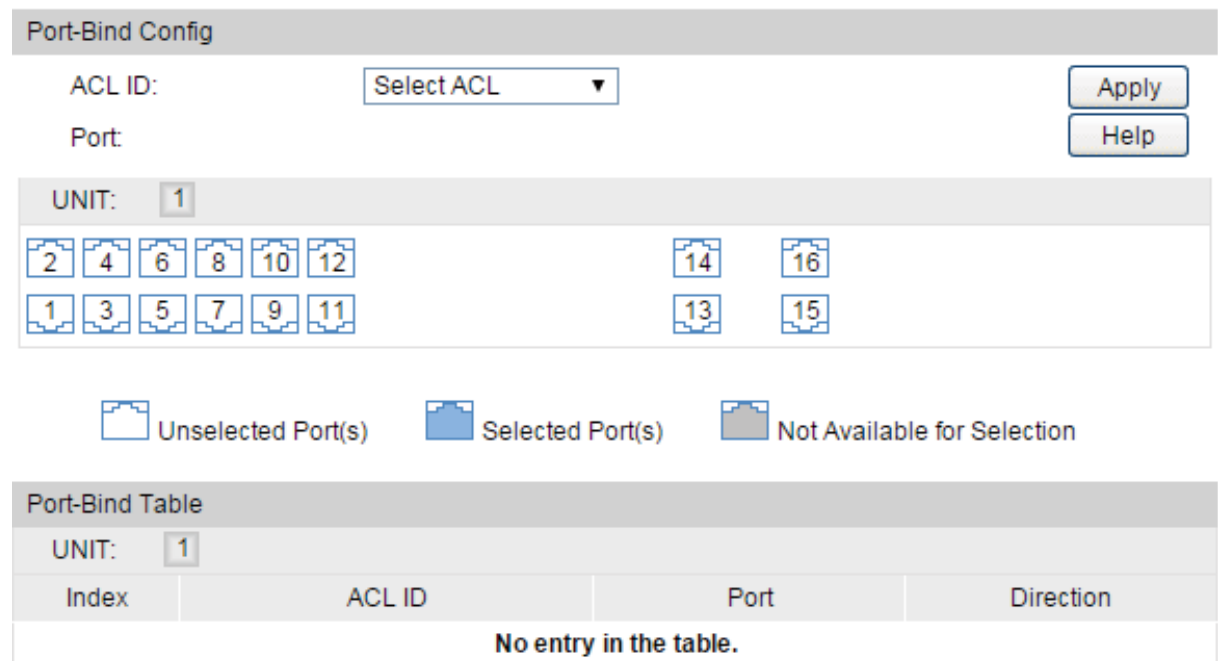

Follow these steps to bind the ACL to a Port:

Select the ACL and the port, and click **Apply**.

|        |                                        |
|--------|----------------------------------------|
| ACL ID | Select an ACL from the drop-down list. |
|--------|----------------------------------------|

- **Binding the ACL to a VLAN**

Choose the menu **ACL > ACL Binding > VLAN Binding** to load the following page.

Figure 2-10 Binding the ACL to a VLAN

**VLAN-Bind Config**

ACL ID:

VLAN ID:  (Format: 1)

**VLAN-Bind Table**

| Index                  | ACL ID | VLAN ID | Direction |
|------------------------|--------|---------|-----------|
| No entry in the table. |        |         |           |

Follow these steps to bind the ACL to a VLAN:

Select the ACL and enter the VLAN ID, and click **Apply**.

|                |                                        |
|----------------|----------------------------------------|
| <b>ACL ID</b>  | Select an ACL from the drop-down list. |
| <b>VLAN ID</b> | Enter the VLAN ID.                     |

- **Configuring the Policy Binding**

You can bind the Policy to a port or a VLAN. The received packets will then be matched and processed according to this Policy.

- **Binding the Policy to a Port**

Choose the menu **ACL > Policy Binding > Port Binding** to load the following page.

Figure 2-11 Binding the Policy to a Port

**Port-Bind Config**

Policy Name:

Port:

UNIT:

|   |   |   |   |    |    |    |    |
|---|---|---|---|----|----|----|----|
| 2 | 4 | 6 | 8 | 10 | 12 | 14 | 16 |
| 1 | 3 | 5 | 7 | 9  | 11 | 13 | 15 |

Unselected Port(s)

Selected Port(s)

Not Available for Selection

**Port-Bind Table**

UNIT:

| Index                         | Policy Name | Port | Direction |
|-------------------------------|-------------|------|-----------|
| <b>No entry in the table.</b> |             |      |           |

Follow these steps to bind the Policy to a Port:

Select the Policy and the port to be bound, and click **Apply**.

---

Policy Name Select a Policy from the drop-down list.

---

- **Binding the Policy to a VLAN**

Choose the menu **ACL > Policy Binding > VLAN Binding** to load the following page.

Figure 2-12 Binding the Policy to a VLAN

**VLAN-Bind Config**

Policy Name:

VLAN ID:  (Format: 1)

**VLAN-Bind Table**

| Index                         | Policy Name | VLAN ID | Direction |
|-------------------------------|-------------|---------|-----------|
| <b>No entry in the table.</b> |             |         |           |

Follow these steps to bind the Policy to a VLAN:

Select the ACL and enter the VLAN ID, and click **Apply**.



|         |                                        |
|---------|----------------------------------------|
| ACL ID  | Select an ACL from the drop-down list. |
| VLAN ID | Enter the VLAN ID.                     |

## Verifying the Binding Configuration

### ■ Verifying the ACL Binding

You can view both port binding and VLAN binding entries in the table. You can also delete existing entries if needed.

Choose the menu **ACL > ACL Binding > Binding Table** to load the following page.

Figure 2-13 Verifying the ACL Binding

**Search Options**

Show Mode:  ▼

**ACL Vlan-Bind Table**

| Select                 | Index | ACL ID | Interface | Direction |
|------------------------|-------|--------|-----------|-----------|
| No entry in the table. |       |        |           |           |

**ACL Port-Bind Table**

UNIT:

| Select                   | Index | ACL ID | Interface | Direction |
|--------------------------|-------|--------|-----------|-----------|
| <input type="checkbox"/> |       |        |           |           |
| No entry in the table.   |       |        |           |           |

### ■ Verifying the Policy Binding

You can view both port binding and VLAN binding entries in the table. You can also delete existing entries if needed.

Choose the menu **ACL > Policy Binding > Binding Table** to load the following page.

Figure 2-14 Verifying the Policy Binding

**Search Options**

Show Mode:  ▼

**Policy Vlan-Bind Table**

| Select                 | Index | Policy Name                        | Interface                             | Direction |
|------------------------|-------|------------------------------------|---------------------------------------|-----------|
| No entry in the table. |       |                                    |                                       |           |
|                        |       | <input type="button" value="All"/> | <input type="button" value="Delete"/> |           |

**Policy Port-Bind Table**

UNIT:

| Select                   | Index | Policy Name                        | Interface                             | Direction                           |
|--------------------------|-------|------------------------------------|---------------------------------------|-------------------------------------|
| <input type="checkbox"/> |       |                                    |                                       |                                     |
| No entry in the table.   |       |                                    |                                       |                                     |
|                          |       | <input type="button" value="All"/> | <input type="button" value="Delete"/> | <input type="button" value="Help"/> |

## 2.2 Using the CLI

### 2.2.1 Configuring ACL

Follow the steps to create different types of ACL and configure the ACL rules.

You can define the rules based on source or destination IP addresses, source or destination MAC addresses, protocol type and so on.

- **Configuring the MAC ACL**

Step 1 **configure**

Enter global configuration mode

Step 2 **mac access-list *access-list-num***

Input an MAC ACL ID to enter MAC Access-list mode. If it is a new ID , the ACL will be created and the switch will enter MAC Access-list mode.

*access-list-num*: Enter an ACL ID between 0 and 499.

---

Step 3 **rule** *rule-id* {deny | permit} [ [**smac** *source-mac*] **smask** *source-mac-mask* ] [ [**dmac** *destination-mac*] **dmask** *destination-mac-mask* ]

Add an MAC ACL rule.

*rule-id*: Specify the rule ID, which ranges from 0 to 999. It should not be the same as any existing MAC ACL rule IDs

deny | permit: Specify the operation to be performed with the packets that match the rule. By default, it is set to permit. The packets will be discarded if "deny" is selected and forwarded if "permit" is selected.

*source-mac*: Enter the source MAC address. The format is FF:FF:FF:FF:FF:FF.

*source-mac-mask*: Enter the mask of the source MAC address. This is required if a source MAC address is entered. The format is FF:FF:FF:FF:FF:FF.

*destination-mac*: Enter the destination MAC address. The format is FF:FF:FF:FF:FF:FF.

*destination-mac-mask*: Enter the mask of the destination MAC address. This is required if a destination MAC address is entered. The format is FF:FF:FF:FF:FF:FF.

---

Step 4 **show access-list** [*access-list-num*]

(Optional) View the current ACL configuration.

*access-list-num*: The ID number of the ACL.

---

Step 5 **end**

Return to privileged EXEC mode.

---

Step 6 **copy running-config startup-config**

Save the settings in the configuration file.

---

The following example shows how to create MAC ACL 50 and configure Rule 1 to permit packets with source MAC address 00:34:a2:d4:34:b5:

```
Switch#configure
```

```
Switch(config)#mac access-list 50
```

```
Switch(config-mac-acl)#rule 1 permit smac 00:34:a2:d4:34:b5 smask ff:ff:ff:ff:ff:ff
```

```
Switch(config-mac-acl)#show access-list 50
```

```
mac access list 50
```

```
Rule 1 permit smac 00:34:a2:d4:34:b5 smask ff:ff:ff:ff:ff:ff
```

```
Switch(config-mac-acl)#end
```

```
Switch#copy running-config startup-config
```

## ■ Configuring the Standard-IP ACL

---

|        |                                                                                                                                                                                                                                                                                                                                                                                                                                                                                                                                                                                                                                                                                                                                                                                                                                                                                                                                                                                                                                         |
|--------|-----------------------------------------------------------------------------------------------------------------------------------------------------------------------------------------------------------------------------------------------------------------------------------------------------------------------------------------------------------------------------------------------------------------------------------------------------------------------------------------------------------------------------------------------------------------------------------------------------------------------------------------------------------------------------------------------------------------------------------------------------------------------------------------------------------------------------------------------------------------------------------------------------------------------------------------------------------------------------------------------------------------------------------------|
| Step 1 | <b>configure</b><br>Enter global configuration mode.                                                                                                                                                                                                                                                                                                                                                                                                                                                                                                                                                                                                                                                                                                                                                                                                                                                                                                                                                                                    |
| Step 2 | <b>access-list create <i>access-list-num</i></b><br>Create a Standard-IP ACL.<br><br><i>access-list-num</i> : Enter an ACL ID. The ID ranges from 500 to 1499.                                                                                                                                                                                                                                                                                                                                                                                                                                                                                                                                                                                                                                                                                                                                                                                                                                                                          |
| Step 3 | <b>access-list standard <i>acl-id</i> rule <i>rule-id</i> { deny   permit } [[ sip <i>source-ip</i> ] smask <i>source-ip-mask</i>] [[ dip <i>destination-ip</i> ] dmask <i>destination-ip-mask</i> ]</b><br>Add a rule to the ACL.<br><br><i>acl-id</i> : The ID number of the ACL you have created.<br><br><i>rule-id</i> : Specify the rule ID, which ranges from 0 to 1999. It should not be the same as any existing Standard-IP rule IDs<br><br><i>deny   permit</i> : Specify the operation to be performed with the packets that match the rule. Deny means to discard; permit means to forward. By default, it is set to permit.<br><br><i>source-ip</i> : Enter the source IP address.<br><br><i>source-ip-mask</i> : Enter the mask of the source IP address. This is required if a source IP address is entered.<br><br><i>destination-ip</i> : Enter the destination IP address.<br><br><i>destination-ip-mask</i> : Enter the mask of the destination IP address. This is required if a destination IP address is entered. |
| Step 4 | <b>show access-list [<i>access-list-num</i>]</b><br>(Optional) View the current ACL configuration.<br><br><i>access-list-num</i> : The ID number of the ACL.                                                                                                                                                                                                                                                                                                                                                                                                                                                                                                                                                                                                                                                                                                                                                                                                                                                                            |
| Step 5 | <b>end</b><br>Return to privileged EXEC mode.                                                                                                                                                                                                                                                                                                                                                                                                                                                                                                                                                                                                                                                                                                                                                                                                                                                                                                                                                                                           |
| Step 6 | <b>copy running-config startup-config</b><br>Save the settings in the configuration file.                                                                                                                                                                                                                                                                                                                                                                                                                                                                                                                                                                                                                                                                                                                                                                                                                                                                                                                                               |

---

The following example shows how to create Standard-IP ACL 600, and configure Rule 1 to permit packets with source IP address 192.168.1.100:

```
Switch#configure
```

```
Switch(config)#access-list create 600
```

```
Switch(config)#rule 1 permit sip 192.168.1.100 smask 255.255.255.255
```

```
Switch(config)#show access-list 600
```

```
Standard IP access list 600
```

```
rule 1 permit sip 192.168.1.100 smask 255.255.255.255
```

```
Switch(config)#end
```

```
Switch#copy running-config startup-config
```

### ■ Configuring the Extend-IP ACL

|        |                                                                                                                                                                                                                                                                                                                                                                                                                                                                                                                                                                                                                                                                                                                                                                                                                                                                                                                                                                                                                                                                                                                                                                                                                                                                                                                                                                               |
|--------|-------------------------------------------------------------------------------------------------------------------------------------------------------------------------------------------------------------------------------------------------------------------------------------------------------------------------------------------------------------------------------------------------------------------------------------------------------------------------------------------------------------------------------------------------------------------------------------------------------------------------------------------------------------------------------------------------------------------------------------------------------------------------------------------------------------------------------------------------------------------------------------------------------------------------------------------------------------------------------------------------------------------------------------------------------------------------------------------------------------------------------------------------------------------------------------------------------------------------------------------------------------------------------------------------------------------------------------------------------------------------------|
| Step 1 | <b>configure</b><br>Enter global configuration mode                                                                                                                                                                                                                                                                                                                                                                                                                                                                                                                                                                                                                                                                                                                                                                                                                                                                                                                                                                                                                                                                                                                                                                                                                                                                                                                           |
| Step 2 | <b>access-list create <i>access-list-num</i></b><br>Create an Extend-IP ACL<br><br><i>access-list-num</i> : Enter an ACL ID. The ID ranges from 1500 to 2499.                                                                                                                                                                                                                                                                                                                                                                                                                                                                                                                                                                                                                                                                                                                                                                                                                                                                                                                                                                                                                                                                                                                                                                                                                 |
| Step 3 | <b>access-list extended <i>acl-id</i> rule <i>rule-id</i> {deny   permit} [ [<i>sip</i> <i>source-ip</i>] <i>smask</i> <i>source-ip-mask</i>] [ [<i>dip</i> <i>destination-ip</i>] <i>dmask</i> <i>destination-ip-mask</i>] [<i>s-port</i> <i>s-port</i>] [<i>d-port</i> <i>d-port</i>] [<i>protocol</i> <i>protocol</i>]</b><br>Add a rule to the ACL.<br><br><i>acl-id</i> : The ID number of the ACL you have created.<br><br><i>rule-id</i> : Specify the rule ID, which ranges from 0 to 1999. It should not be the same as any existing Extend-IP ACL IDs<br><br>deny   permit: Specify the operation to be performed with the packets that match the rule. Deny means to discard; permit means to forward. By default, it is permit.<br><br><i>source-ip</i> : Enter the source IP address.<br><br><i>source-ip-mask</i> : Enter the mask of the source IP address. This is required if a source IP address is entered.<br><br><i>destination-ip</i> : Enter the destination IP address.<br><br><i>destination-ip-mask</i> : Enter the mask of the destination IP address. This is required if a destination IP address is entered.<br><br><i>s-port</i> : Enter the TCP/UDP source port if TCP/UDP protocol is selected.<br><br><i>d-port</i> : Enter the TCP/UDP destination port if TCP/UDP protocol is selected.<br><br><i>protocol</i> : Specify a protocol type. |
| Step 4 | <b>show access-list [<i>access-list-num</i>]</b><br>(Optional) View the current ACL configuration.<br><br><i>access-list-num</i> : The ID number of the ACL.                                                                                                                                                                                                                                                                                                                                                                                                                                                                                                                                                                                                                                                                                                                                                                                                                                                                                                                                                                                                                                                                                                                                                                                                                  |
| Step 5 | <b>end</b><br>Return to privileged EXEC mode.                                                                                                                                                                                                                                                                                                                                                                                                                                                                                                                                                                                                                                                                                                                                                                                                                                                                                                                                                                                                                                                                                                                                                                                                                                                                                                                                 |
| Step 6 | <b>copy running-config startup-config</b><br>Save the settings in the configuration file.                                                                                                                                                                                                                                                                                                                                                                                                                                                                                                                                                                                                                                                                                                                                                                                                                                                                                                                                                                                                                                                                                                                                                                                                                                                                                     |

The following example shows how to create Extend-IP ACL 1700 and configure Rule7 to deny Telnet packets with source IP 192.168.2.100:

```
Switch#configure
```

```
Switch(config)#access-list create 1700
```

```
Switch(config)#access-list extended 1700 Rule 7 deny sip 192.168.2.100 smask  
255.255.255.255 protocol 6 d-port 23
```

```
Switch(config)#show access-list 1700
```

```
Extended IP access list 1700
```

```
Rule 7 deny sip 192.168.2.100 smask 255.255.255.255 protocol 6 d-port 23
```

```
Switch(config)#end
```

```
Switch#copy running-config startup-config
```

#### ■ Configuring the IPv6 ACL

---

Step 1     **configure**

Enter global configuration mode

---

Step 2     **access-list combined** *access-list-num*

Create an IPv6 ACL.

*access-list-num*: Enter an ACL ID. The ID ranges from 3500 to 4999.

---

---

Step 3 **access-list ipv6 *acl-id* rule *rule-id* {permit | deny}[dscp *dscp-value*] [flow-label *flow-label-value*] [sip *source-ip-address* sip-mask *source-ip-mask*] [dip *destination-ip-address* dip-mask *destination-ip-mask*] [s-port *source-port-number*] [d-port *destination-port-number*]**

Add a rule to the ACL.

*acl-id*: The ID number of the ACL you have created.

*rule-id*: Specify the rule ID, which ranges from 0 to 999. It should not be the same as any existing IPv6 ACL IDs

permit|deny: Specify the operation to be performed with the packets that match the rule. Deny means to discard; permit means to forward. By default, it is permit.

*dscp-value*: Specify a DSCP value to be matched.

*flow-label-value*: Specify a Flow Label value to be matched.

*source-ip-address*: Enter the source IP address. Enter the destination IPv6 address to be matched. All types of IPv6 address will be checked. You may enter a complete 128-bit IPv6 address but only the first 64 bits will be valid.

*source-ip-mask*: Enter the source IP address mask. The mask is required if the source IPv6 address is entered. Enter the mask in complete format (for example, ffff:ffff:0000:ffff). The mask specifies which bits in the source IPv6 address to match the rule.

*destination-ip-address*: Enter the destination IPv6 address to be matched. All types of IPv6 address will be checked. You may enter a complete 128-bit IPv6 addresses but only the first 64 bits will be valid.

*destination-ip-mask*: Enter the source IP address mask. The mask is required if the source IPv6 address is entered. Enter the mask in complete format (for example, ffff:ffff:0000:ffff). The mask specifies which bits in the source IPv6 address to match the rule.

*source-port-number*: Enter the TCP/UDP source port if TCP/UDP protocol is selected.

*destination-port-number*: Enter the TCP/UDP destination port if TCP/UDP protocol is selected.

---

Step 4 **show access-list [*access-list-num*]**

(Optional) View the current ACL configuration.

*access-list-num*: The ID number of the ACL.

---

Step 5 **end**

Return to privileged EXEC mode.

---

Step 6 **copy running-config startup-config**

Save the settings in the configuration file.

---

The following example shows how to create IPv6 ACL 3600 and configure Rule 1 to deny packets with source IPv6 address CDCD:910A:2222:5498:8475:1111:3900:2020:

**Switch#configure**

**Switch(config)#access-list create 3600**

**Switch(config)#access-list ipv6 3600 Rule 1 deny sip  
CDCD:910A:2222:5498:8475:1111:3900:2020 sip-mask ffff:ffff:ffff:ffff**

```
Switch(config)#show access-list 3600
```

```
IPv6 access list 3600
```

```
rule 1 deny sip cdc:910a:2222:5498:8475:1111:3900:2020 sip-mask ffff:ff:ff:ffff:ffff
```

```
Switch(config)#end
```

```
Switch#copy running-config startup-config
```

## 2.2.2 Configuring Policy

Follow the steps below to create a policy and configure the policy actions.

|        |                                                                                                                                                                                                          |
|--------|----------------------------------------------------------------------------------------------------------------------------------------------------------------------------------------------------------|
| Step 1 | <b>configure</b><br>Enter global configuration mode                                                                                                                                                      |
| Step 2 | <b>access-list policy name <i>name</i></b><br>Create a Policy.<br><br><i>name</i> : Assign the policy a name with 1 to 16 characters.                                                                    |
| Step 3 | <b>access-list policy action <i>policy-name acl-id</i></b><br>Apply an ACL to the Policy.<br><br><i>policy-name</i> : The name of the policy.<br><i>acl-id</i> : The ID number of the ACL to be applied. |
| Step 4 | <b>show access-list policy <i>name</i></b><br>(Optional) View the information of a specified policy.<br><br><i>name</i> : The policy name desired to show..                                              |
| Step 5 | <b>end</b><br>Return to privileged EXEC mode.                                                                                                                                                            |
| Step 6 | <b>copy running-config startup-config</b><br>Save the settings in the configuration file.                                                                                                                |

The following example shows how to create Policy RD, and apply ACL 600 to Policy RD:

```
Switch#configure
```

```
Switch(config)#access-list policy name RD
```

```
Switch(config)#access-list policy action RD 600
```

```
Switch(config-action)#exit
```

```
Switch(config)#show access-list policy RD
```

```
Policy name : RD
```



```
access-list 600
```

```
Switch(config)#end
```

```
Switch#copy running-config startup-config
```

## 2.2.3 ACL Binding and Policy Binding

You can select ACL binding or Policy binding according to your needs. An ACL Rule and Policy takes effect only after they are bound to a port or VLAN.

### ■ ACL Binding

You can bind the ACL to a port or a VLAN. The received packets will then be matched and processed according to the ACL rules.

|        |                                                                                                                                                                                                                                                                                                                                                                                                                                                                                                                                                                                                                                                                                                                                       |
|--------|---------------------------------------------------------------------------------------------------------------------------------------------------------------------------------------------------------------------------------------------------------------------------------------------------------------------------------------------------------------------------------------------------------------------------------------------------------------------------------------------------------------------------------------------------------------------------------------------------------------------------------------------------------------------------------------------------------------------------------------|
| Step 1 | <b>configure</b><br>Enter global configuration mode                                                                                                                                                                                                                                                                                                                                                                                                                                                                                                                                                                                                                                                                                   |
| Step 2 | <b>interface {fastEthernet <i>port</i>   range fastEthernet <i>port-list</i>   gigabitEthernet <i>port</i>   range gigabitEthernet <i>port-list</i>}</b><br><b>access-list bind acl <i>acl-id</i></b><br><br>(Optional) Enter the interface configuration mode and bind the ACL to the port.<br><br><i>port</i>   <i>port-list</i> : The port (ports) to which the policy will bind.<br><i>policy-name</i> : The name of the policy.<br><br><b>interface vlan <i>vlan-id</i></b><br><b>access-list bind acl <i>acl-id</i></b><br><br>(Optional) Enter layer 3 interface configuration mode and bind the ACL to the VLAN.<br><br><i>vlan-id</i> : The VLAN to which the policy will bind.<br><i>acl-id</i> : The ID number of the ACL. |
| Step 3 | <b>show access-list bind</b><br><br>(Optional) View the configuration of binding.                                                                                                                                                                                                                                                                                                                                                                                                                                                                                                                                                                                                                                                     |
| Step 4 | <b>end</b><br>Return to privileged EXEC mode.                                                                                                                                                                                                                                                                                                                                                                                                                                                                                                                                                                                                                                                                                         |
| Step 5 | <b>copy running-config startup-config</b><br>Save the settings in the configuration file.                                                                                                                                                                                                                                                                                                                                                                                                                                                                                                                                                                                                                                             |

The following example shows how to bind ACL 1 to port 3 and ACL 2 to VLAN 4:

```
Switch#configure
```

```
Switch(config)#interface ten-gigabitEthernet 1/0/3
```

```
Switch(config-if)#access-list bind acl 1
```

```
Switch(config-if)#exit
```

```
Switch(config)#interface vlan 4
```

```
Switch(config-if)#access-list bind acl 2
```

```
Switch(config-if)#show access-list bind
```

| Index | Policy Name | Interface/VID | Direction | Type |
|-------|-------------|---------------|-----------|------|
| ----- | -----       | -----         | -----     | ---- |
| Index | ACL ID      | Interface/VID | Direction | Type |
| ----- | -----       | -----         | -----     | ---- |
| 1     | 1           | Te1/0/3       | Ingress   | Port |
| 2     | 2           | 4             | Ingress   | Vlan |

```
Switch(config-if)#end
```

```
Switch#copy running-config startup-config
```

#### ■ Policy Binding

You can bind the Policy to a port or a VLAN, then the received packets will be matched and operated based on the Policy.

|        |                                                                                                                                                                                                                                                                                                                                                                                                                                                                                                                                                                                                                                                                                                                                                             |
|--------|-------------------------------------------------------------------------------------------------------------------------------------------------------------------------------------------------------------------------------------------------------------------------------------------------------------------------------------------------------------------------------------------------------------------------------------------------------------------------------------------------------------------------------------------------------------------------------------------------------------------------------------------------------------------------------------------------------------------------------------------------------------|
| Step 1 | <p><b>configure</b></p> <p>Enter global configuration mode</p>                                                                                                                                                                                                                                                                                                                                                                                                                                                                                                                                                                                                                                                                                              |
| Step 2 | <p><b>interface</b> {<i>fastEthernet port</i>   <i>range fastEthernet port-list</i>   <i>gigabitEthernet port</i>   <i>range gigabitEthernet port-list</i>}<br/> <b>access-list bind</b> <i>policy-name</i></p> <p>(Optional) Enter the interface configuration mode and bind the policy to the port.</p> <p><i>port</i>   <i>port-list</i>: The port (ports) to which the policy will bind.<br/> <i>policy-name</i>: The name of the policy.</p> <p><b>interface vlan</b> <i>vlan-id</i><br/> <b>access-list bind</b> <i>policy-name</i></p> <p>(Optional) Enter layer 3 interface configuration mode and bind the policy to the VLAN.</p> <p><i>vlan-id</i>: The VLAN to which the policy will bind.<br/> <i>policy-name</i>: The name of the policy.</p> |
| Step 3 | <p><b>show access-list bind</b></p> <p>(Optional) View the configuration of binding.</p>                                                                                                                                                                                                                                                                                                                                                                                                                                                                                                                                                                                                                                                                    |
| Step 4 | <p><b>end</b></p> <p>Return to privileged EXEC mode.</p>                                                                                                                                                                                                                                                                                                                                                                                                                                                                                                                                                                                                                                                                                                    |

**Step 5** `copy running-config startup-config`

Save the settings in the configuration file.

The following example shows how to bind Policy 1 to port 2 and Policy 2 to VLAN 2:

**Switch#configure**

**Switch(config)#interface ten-gigabitEthernet 1/0/2**

**Switch(config-if)#access-list bind policy 1**

**Switch(config-if)#exit**

**Switch(config)#interface vlan 2**

**Switch(config-if)#access-list bind policy 2**

**Switch(config-if)#show access-list bind**

| Index | Policy Name | Interface/VID | Direction | Type |
|-------|-------------|---------------|-----------|------|
| ----- | -----       | -----         | -----     | ---- |
| 1     | 1           | Te1/0/2       | Ingress   | Port |
| 2     | 2           | 2             | Ingress   | Vlan |
| Index | ACL ID      | Interface/VID | Direction | Type |
| ----- | -----       | -----         | -----     | ---- |

**Switch(config-if)#end**

**Switch#copy running-config startup-config**

# 3 Configuration Example for ACL

## 3.1 Network Requirements

A company's server group can provide different types of services. It is required that:

- The Marketing department can only access the server group.
- The Marketing department can only visit HTTP and HTTPS websites on the Internet.

## 3.2 Network Topology

As shown below, computers in the Marketing department are connected to the switch via port 1/0/1, and the server group is connected to the switch via port 1/0/2.

Figure 3-1 Network Topology

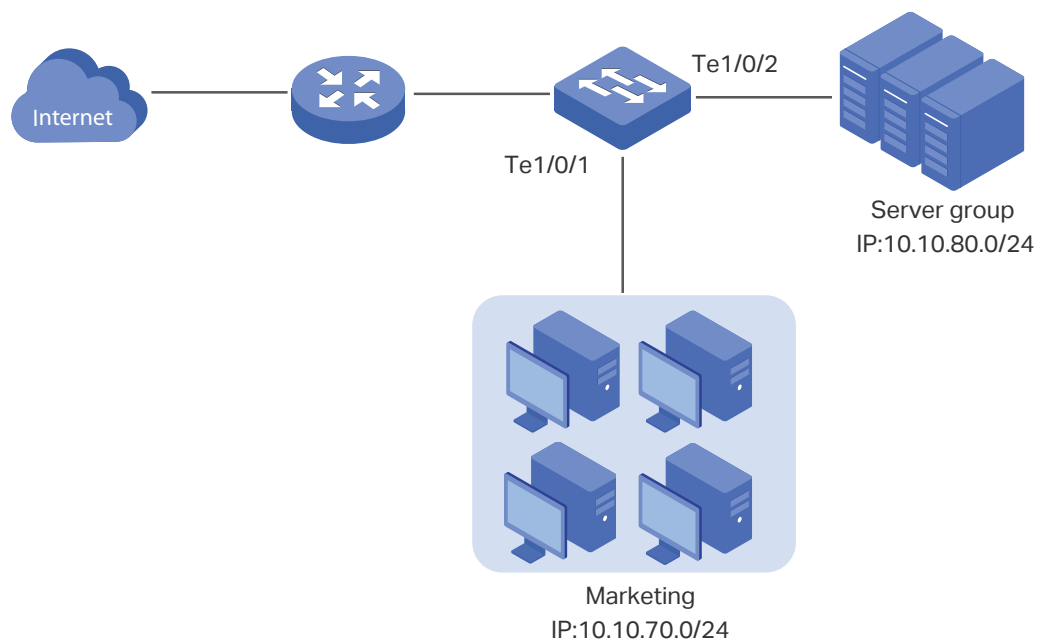

## 3.3 Configuration Scheme

To meet the requirements above, you can configure packet filtering by creating an Extend-IP ACL and configuring rules for it.

- **Configuring ACL**
  - 1) Configure a permit rule to match packets with source IP address 10.10.70.0/24, and destination IP address 110.10.80.0/24. This rule allows the Marketing department to access the server group.

- 2) Configure permit rules to match packets with source IP address 10.10.70.0/24, and destination ports TCP 80, TCP 443 and TCP/UDP 53. These rules allow the Marketing department to visit http and HTTPS websites on the Internet.
- 3) Configure a deny rule to match packets with source IP address 10.10.70.0. This rule blocks other network services.

The switch matches the packets with the rules in order, starting with Rule 1. If a packet matches a rule, the switch stops the matching process.

#### ▪ Binding Configuration

Apply the Extend-IP ACL to a Policy and bind the Policy to port 1/0/1 so that the ACL rules will apply to the Marketing department only.

Demonstrated with T1700X-16TS, this chapter explains configuration procedures in two ways: using the GUI and using the CLI.

## 3.4 Using the GUI

- 1) Choose the menu **ACL > ACL Config > ACL Create** to load the following page. Then create Extend-IP ACL 1600.

Figure 3-2 Creating an Extend-IP ACL

The screenshot shows the 'ACL Create' configuration page. The 'ACL ID' field is set to '1600' and is highlighted with a red box. Below the field, there are four radio button options: '0-499 MAC ACL', '500-1499 Standard-IP ACL', '1500-2499 Extend-IP ACL', and '3500-4499 IPv6 ACL'. The '1500-2499 Extend-IP ACL' option is selected. Below these options, there is a 'Rule Order' section with a radio button for 'User Config' which is also selected. At the bottom, there are two buttons: 'Apply' and 'Help', with the 'Apply' button highlighted by a red box.

- 2) Choose the menu **ACL > ACL Config > Extend-IP ACL** to load the following page. Configure Rule 1 to match packets with the source IP address 10.10.70.0/24 and destination IP address 10.10.80.0/24.

Figure 3-3 Configuring Rule 1

**Create Extend-IP Rule**

ACL ID:  (v)

Rule ID:  (0-1999)

Operation:  (v)

S-IP:  Mask:  (Format: 192.168.0.1)

D-IP:  Mask:

IP Protocol:  (v)

S-Port:

D-Port:

- 3) Choose the menu **ACL > ACL Config > Extend ACL** to load the following page. Configure rule 2 and rule 3 to permit packets with source IP 10.10.70.0 and destination port TCP 80 (http service port) and UDP 443 (HTTPS service port).

Figure 3-4 Configuring Rule 2

**Create Extend-IP Rule**

ACL ID:  (v)

Rule ID:  (0-1999)

Operation:  (v)

S-IP:  Mask:  (Format: 192.168.0.1)

D-IP:  Mask:

IP Protocol:  (v)

S-Port:

D-Port:

Figure 3-5 Configuring Rule 3

**Create Extend-IP Rule**

ACL ID:  (v)

Rule ID:  (0-1999)

Operation:  (v)

S-IP:  Mask:  (Format: 192.168.0.1)

D-IP:  Mask:

IP Protocol:  (v)

S-Port:

D-Port:

- 4) Choose the menu **ACL > Policy Config > Policy Create** to load the following page. Configure Rule 4 and Rule 5 to permit packets with source IP 10.10.70.0 and with destination port TCP 53 or UDP 53 (DNS service port).

Figure 3-6 Configuring Rule 4

**Create Extend-IP Rule**

ACL ID:

Rule ID:  (0-1999)

Operation:

S-IP:  Mask:  (Format: 192.168.0.1)

D-IP:  Mask:

IP Protocol:

S-Port:

D-Port:

Figure 3-7 Configuring Rule 5

**Create Extend-IP Rule**

ACL ID:

Rule ID:  (0-1999)

Operation:

S-IP:  Mask:  (Format: 192.168.0.1)

D-IP:  Mask:

IP Protocol:

S-Port:

D-Port:

- 5) Choose the menu **ACL > Policy Config > Policy Create** to load the following page. Configure Rule 6 to deny packets with source IP 10.10.70.0.

Figure 3-8 Configuring Rule 6

**Create Extend-IP Rule**

ACL ID: ACL 1600 ▼

Rule ID: 6 (0-1999)

Operation: Deny ▼

S-IP: 10.10.70.0 Mask: 255.255.255.0 (Format: 192.168.0.1)

D-IP:  Mask:

IP Protocol: All ▼

S-Port:

D-Port:

Apply
Help

- 6) Choose the menu **ACL > Policy Config > Policy Create** to load the following page. Then create Policy Market.

Figure 3-9 Creating the Policy

**Create Policy**

Policy Name: Market

Apply  
Help

- 7) Choose the menu **ACL > Policy Config > Action Create** to load the the following page. Then apply ACL 1600 to Policy Market.

Figure 3-10 Applying the ACL to the Policy

**Create Action:**

Select Policy: Market ▼

Select ACL: ACL 1600 ▼

Apply
Help

- 8) Choose the menu **ACL > Policy Binding > Port Binding** to load the following page. Bind Policy Market to port 1/0/1 to make it effective.



Figure 3-11 Binding the Policy to Port 1/0/1

Port-Bind Config

Policy Name: Market Apply  
Help

Port:

UNIT: 1

|   |   |   |   |    |    |    |    |
|---|---|---|---|----|----|----|----|
| 2 | 4 | 6 | 8 | 10 | 12 | 14 | 16 |
| 1 | 3 | 5 | 7 | 9  | 11 | 13 | 15 |

Unselected Port(s)
 Selected Port(s)
 Not Available for Selection

Port-Bind Table

UNIT: 1

| Index                  | Policy Name | Port | Direction |
|------------------------|-------------|------|-----------|
| No entry in the table. |             |      |           |

- 9) Click **Save Config** to save the settings.

### 3.5 Using the CLI

- 1) Create Extended-IP ACL 1600.

```
Switch#configure
```

```
Switch(config)#access-list create 1600
```

- 2) Configure rule 1 to permit packets with source IP 10.10.70.0 and destination IP 10.10.80.0.

```
Switch(config)#access-list extended 1600 rule 1 permit sip 10.10.70.0 smask 255.255.255.0 dip 10.10.80.0 dmask 255.255.255.0
```

- 3) Configure Rule 2 and Rule 3 to permit packets with source IP 10.10.70.0, and destination port TCP 80 (http service port) or TCP 443 (HTTPS service port).

```
Switch(config)#access-list extended 1600 rule 2 permit sip 10.10.70.0 smask 255.255.255.0 protocol 6 d-port 80
```

```
Switch(config)#access-list extended 1600 rule 3 permit sip 10.10.70.0 smask 255.255.255.0 protocol 6 d-port 443
```

- 4) Configure Rule 4 and Rule 5 to permit packets with source IP 10.10.70.0, and destination port TCP53 or UDP 53.

```
Switch(config)#access-list extended 1600 rule 4 permit sip 10.10.70.0 smask 255.255.255.0 protocol 6 d-port 53
```

```
Switch(config)#access-list extended 1600 rule 5 permit sip 10.10.70.0 smask
255.255.255.0 protocol 17 d-port 53
```

- 5) Configure Rule 6 to deny packets with source IP 10.10.70.0.

```
Switch(config)#access-list extended 1600 rule 6 deny sip 10.10.70.0 smask
255.255.255.0
```

- 6) Create Policy Market, and then apply ACL 1600 to it.

```
Switch(config)#access-list policy name Market
Switch(config)#access-list policy action Market 1600
Switch(config-action)#exit
```

- 7) Bind Policy Market to port 1/0/1.

```
Switch(config)#interface ten-gigabitEthernet 1/0/1
Switch(config-if)#access-list bind Market
Switch(config-if)#end
Switch#copy running-config startup-config
```

## Verify the Configurations

Verify the configurations:

```
Switch(config)#show access-list 1600
```

```
Extended IP access list 1600
```

```
rule 1 permit sip 10.10.70.0 smask 255.255.255.0 dip 10.10.80.0 dmask 255.255.255.0
rule 2 permit sip 10.10.70.0 smask 255.255.255.0 protocol 6 d-port 80
rule 3 permit sip 10.10.70.0 smask 255.255.255.0 protocol 6 d-port 443
rule 4 permit sip 10.10.70.0 smask 255.255.255.0 protocol 6 d-port 53
rule 5 permit sip 10.10.70.0 smask 255.255.255.0 protocol 17 d-port 53
rule 6 deny sip 10.10.70.0 smask 255.255.255.0
```

```
Switch(config)#show access-list bind
```

| Index | Policy Name | Interface/VID | Direction | Type |
|-------|-------------|---------------|-----------|------|
| ----- | -----       | -----         | -----     | ---- |
| 1     | Market      | Te1/0/1       | Ingress   | Port |
| Index | Acl Id      | Interface/VID | Direction | Type |
| ----- | -----       | -----         | -----     | ---- |

# 4 Appendix: Default Parameters

For MAC ACL:

| Parameter | Default Setting |
|-----------|-----------------|
| Operation | Permit          |

For Standard-IP ACL:

| Parameter | Default Setting |
|-----------|-----------------|
| Operation | Permit          |

For Extend-IP ACL:

| Parameter   | Default Setting |
|-------------|-----------------|
| Operation   | Permit          |
| IP Protocol | All             |

For IPv6 ACL:

| Parameter | Default Setting |
|-----------|-----------------|
| Operation | Permit          |

# Part 20

## Configuring Network Security

### CHAPTERS

1. Network Security
2. IP-MAC Binding Configurations
3. DHCP Snooping Configuration
4. ARP Inspection Configurations
5. DoS Defend Configuration
6. 802.1X Configuration
7. AAA Configuration
8. Configuration Examples
9. Appendix: Default Parameters

# 1 Network Security

## 1.1 Overview

Network Security provides multiple protection measures for the network. Users can configure the security functions according to their needs.

## 1.2 Supported Features

The switch supports multiple network security features, for example, IP-MAC Binding, DHCP Snooping, ARP Inspection and so on.

### IP-MAC Binding

IP-MAC Binding is used to bind the IP address, MAC address, VLAN ID and the connected port number of the specified host. Based on the IP-MAC binding table, the switch can filter the illegal ARP packets with the ARP Detection feature, so as to prevent the network from ARP cheating attacks.

The binding entries can be manually configured, or learned by ARP scanning or DHCP snooping.

### DHCP Snooping

DHCP Snooping supports the basic DHCP security feature and the Option 82 feature.

- Basic DHCP Security

During the working process of DHCP, generally there is no authentication mechanism between the DHCP server and the clients. If there are several DHCP servers on the network, security problems and network interference will happen. DHCP Snooping resolves this problem.

As the following figure shows, the port connected to the legal DHCP server is configured as a trusted port, and other ports are configured as untrusted ports. When receiving the DHCP discover or DHCP request packets, the switch forwards them to the legal DHCP server only through the trusted port. When receiving the respond packets, the switch will determine whether to send or not depending on the type of receiving port: packets received from the trusted port will be forwarded, otherwise they will be discarded. DHCP Snooping ensures that users get IP addresses only from the legal DHCP server, enhancing the network security.

Figure 1-1 Network Topology of Basic DHCP Security

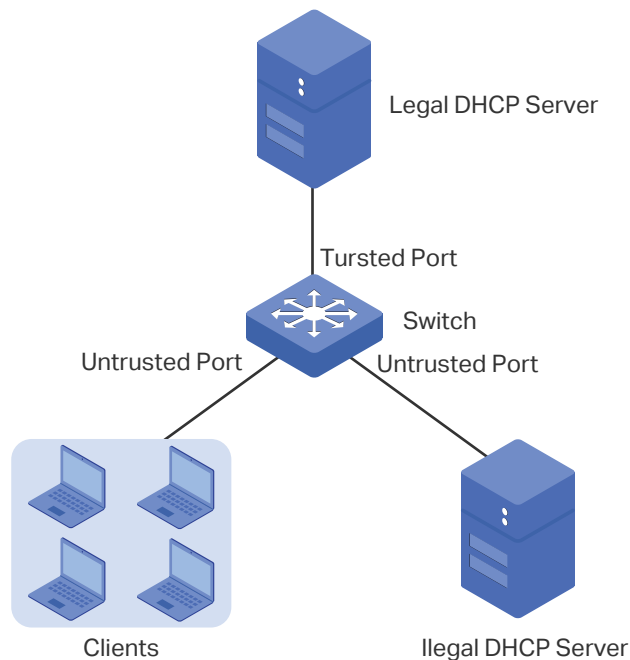

Additionally, with DHCP Snooping, the switch can monitor the IP address obtaining process of each client host and record the IP address, MAC address, VLAN ID and the connected port number of the host for automatic binding.

- Option 82

Option 82 records the location of the DHCP client. The switch can add option 82 to the DHCP request packet and then transmit the packet to the DHCP server. Administrators can check the location of the DHCP client via option 82. The DHCP server supporting option 82 can also set the distribution policy of IP addresses and the other parameters, providing a more flexible address distribution way.

## ARP Inspection

In an actual complex network, there are high security risks during ARP implementation procedure. The cheating attacks against ARP, such as imitating gateway, cheating gateway, cheating terminal hosts and ARP flooding attack, frequently occur to the network. ARP Inspection can prevent the network from these ARP attacks.

- Prevent ARP Cheating Attacks

Based on the predefined IP-MAC Binding entries, the ARP Inspection can be configured to detect the ARP packets and filter the illegal ones so as to prevent the network from ARP cheating attacks.

- Prevent ARP Flooding Attack

With the ARP Defend feature the switch can terminate receiving the ARP packets for 300 seconds when the transmission speed of the legal ARP packet on the port exceeds the defined value so as to avoid ARP flooding attack.

## DoS Defend

The DoS (Denial of Service) defend feature provides protection against DoS attacks. DoS attacks occupy the network bandwidth maliciously by sending numerous service requests to the hosts. It results in an abnormal service or breakdown of the network.

With DoS Defend feature, the switch can analyze the specific fields of the IP packets, distinguish the malicious DoS attack packets and discard them directly. Also, DoS Defend feature can limit the transmission rate of the legal packets if the over legal packets may incur a breakdown of the network.

## 802.1X

802.1X protocol is a protocol for port-based Network Access Control. It is used to authenticate and control access from devices connected to the ports. If the device connected to the port is authenticated by the authentication server successfully, its request to access the LAN will be accepted; if not, its request will be denied.

802.1X authentication uses the typical client-server model which contains three device roles: client/supplicant, authenticator and authentication server. This is described in the figure below:

Figure 1-2 802.1X Authentication Model

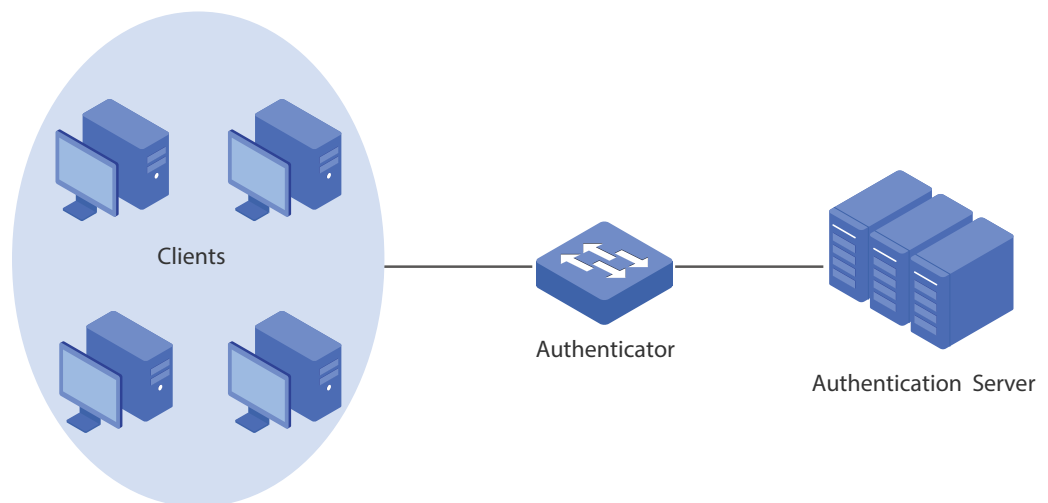

- Client

A client is a host, usually a computer, connected to a switch via a physical port. We recommend that you install TP-Link 802.1X authentication client software on the client hosts, enabling them to request 802.1X authentication to access the LAN.

- Authenticator

An authenticator is usually a network device that supports 802.1X protocol. The switch is an authenticator.

The authenticator acts as an intermediate proxy between the client and the authentication server. The authenticator requests user information from the client and sends it to the authentication server; also, the authenticator obtains responses from the authentication

server and send them to the client. The authenticator allows authenticated clients to access the LAN through the connected ports but denies clients from accessing the LAN through the unauthenticated ports.

- **Authentication Server**

The authentication server is usually the host running the RADIUS server program. It stores information of clients, confirms whether a client is legal and informs the authenticator whether a client is authenticated.

## AAA

AAA stands for authentication, authorization and accounting. On TP-Link switches, this feature is mainly used to authenticate the users trying to log in to the switch or get administrative privileges. The administrator can create guest accounts and an Enable password for other users. The guests do not have administrative privileges without the Enable password provided.

AAA provides a safe and efficient authentication method. The authentication can be processed locally on the switch or centrally on the RADIUS/TACACS+ server(s). As the following figure shows, the network administrator can centrally configure the management accounts of the switches on the RADIUS server and use this server to authenticate the users trying to access the switch or get administrative privileges.

Figure 1-3 Network Topology of AAA

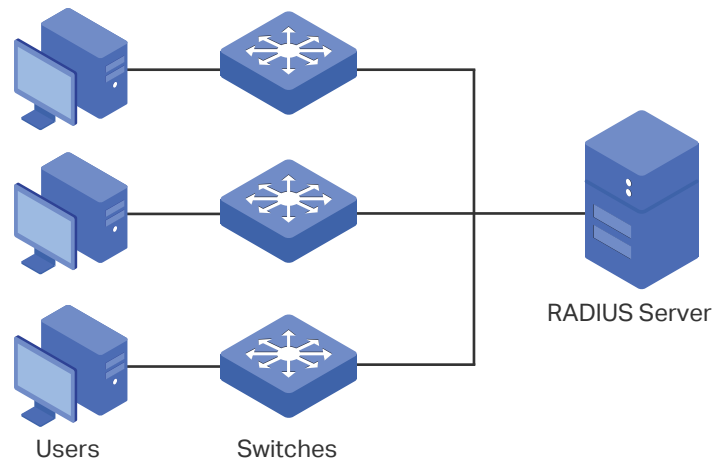



# 2 IP-MAC Binding Configurations

You can complete IP-MAC binding in two ways:

- Manual Binding
- Dynamical Binding (including ARP Scanning and DHCP Snooping)

Additionally, you can search the specified entries in the Binding Table.

## 2.1 Using the GUI

### 2.1.1 Binding Entries Manually

You can manually bind the IP address, MAC address, VLAN ID and the Port number together on the condition that you have got the related information of the hosts on the network.

Choose the menu **Network Security > IP-MAC Binding > Manual Binding** to load the following page.

Figure 2-1 Manual Binding

Manual Binding Option

Host Name:  (20 characters maximum)

IP Address:  (Format: 192.168.0.1)

MAC Address:  (Format: 00-00-00-00-00-01)

VLAN ID:  (1-4094)

Protect Type:  ▼

Port

UNIT: 

|   |   |   |   |    |    |    |    |
|---|---|---|---|----|----|----|----|
| 2 | 4 | 6 | 8 | 10 | 12 | 14 | 16 |
| 1 | 3 | 5 | 7 | 9  | 11 | 13 | 15 |

Unselected Port(s)   
  Selected Port(s)   
  Not Available for Selection

Manual Binding Table

UNIT:

| Select                 | Host Name | IP Address | MAC Address | VLAN ID | Port | Protect Type | Source | Collision |
|------------------------|-----------|------------|-------------|---------|------|--------------|--------|-----------|
| No entry in the table. |           |            |             |         |      |              |        |           |

In the **Manual Binding Option** section, follow these steps to configure IP-MAC Binding:

- 1) Enter the following information to specify a host.

---

|             |                                         |
|-------------|-----------------------------------------|
| Host Name   | Enter the host name for identification. |
| IP Address  | Enter the IP address.                   |
| MAC Address | Enter the MAC address.                  |
| VLAN ID     | Enter the VLAN ID.                      |

---

2) Select protect type for the entry.

---

|              |                                                                                                                                                                                                 |
|--------------|-------------------------------------------------------------------------------------------------------------------------------------------------------------------------------------------------|
| Protect Type | Select the protect type for the entry:<br><br><b>None:</b> This entry will not be applied to any feature.<br><br><b>ARP Detection:</b> This entry will be applied to the ARP Detection feature. |
|--------------|-------------------------------------------------------------------------------------------------------------------------------------------------------------------------------------------------|

---

3) Select the port that is connected to this host.

4) Click **Bind**.

## 2.1.2 Binding Entries Dynamically

The binding entries can be dynamically learned from ARP Scanning and DHCP Snooping.

### ■ ARP Scanning

With ARP Scanning, the switch sends the ARP request packets of the specified IP field to the hosts. Upon receiving the ARP reply packet, the switch can get the IP address, MAC address, VLAN ID and the connected port number of the host. You can bind these entries conveniently.

Choose the menu **Network Security > IP-MAC Binding > ARP Scanning** to load the following page.

Figure 2-2 ARP Scanning

**Scanning Option**

Start IP Address:

End IP Address:

VLAN ID:  (1-4094)

---

**Scanning Result**

UNIT:

| Select                   | Host Name            | IP Address    | MAC Address       | VLAN ID | Port   | Protect Type                      | Source   | Collision |
|--------------------------|----------------------|---------------|-------------------|---------|--------|-----------------------------------|----------|-----------|
| <input type="checkbox"/> | <input type="text"/> |               |                   |         |        | <input type="text" value="None"/> |          |           |
| <input type="checkbox"/> | ---                  | 192.168.0.4   | 00-0a-eb-13-12-27 | 1       | 1/0/16 | None                              | Scanning | ---       |
| <input type="checkbox"/> | ---                  | 192.168.0.15  | 00-0a-eb-13-12-91 | 1       | 1/0/10 | None                              | Scanning | ---       |
| <input type="checkbox"/> | ---                  | 192.168.0.18  | 00-0a-eb-13-12-47 | 1       | 1/0/32 | None                              | Scanning | ---       |
| <input type="checkbox"/> | ---                  | 192.168.0.30  | 00-ca-0a-09-72-25 | 1       | 1/0/48 | None                              | Scanning | ---       |
| <input type="checkbox"/> | ---                  | 192.168.0.37  | 00-0a-eb-13-12-db | 1       | 1/0/40 | None                              | Scanning | ---       |
| <input type="checkbox"/> | ---                  | 192.168.0.73  | 00-0a-eb-00-13-01 | 1       | 1/0/28 | None                              | Scanning | ---       |
| <input type="checkbox"/> | ---                  | 192.168.0.61  | f4-f2-6d-c3-28-62 | 1       | 1/0/28 | None                              | Scanning | ---       |
| <input type="checkbox"/> | ---                  | 192.168.0.115 | 00-11-22-33-44-ac | 1       | 1/0/10 | None                              | Scanning | ---       |
| <input type="checkbox"/> | ---                  | 192.168.0.117 | 00-0a-eb-13-12-3e | 1       | 1/0/14 | None                              | Scanning | ---       |
| <input type="checkbox"/> | ---                  | 192.168.0.200 | 00-19-66-35-e1-b0 | 1       | 1/0/26 | None                              | Scanning | ---       |

Follow these steps to configure IP-MAC Binding via ARP scanning:

- 1) In the **Scanning Option** section, specify an IP address range and a VLAN ID. Then click **Scan** to scan the entries in the specified IP address range and VLAN.

**Start IP Address/End IP Address** Specify an IP range by entering a start and end IP address.

**VLAN ID** Specify a VLAN ID.

- 2) In the **Scanning Result** section, select one or more entries and configure the relevant parameters. Then click **Apply**.

**Host Name** Enter a host name for identification.

**IP Address** Displays the IP address.

**MAC Address** Displays the MAC address.

**VLAN ID** Displays the VLAN ID.

**Port** Displays the port number.

**Protect Type** Select the protect type for the entry:

**None:** This entry will not be applied to the ARP Detection feature. It is the default setting.

**ARP Detection:** This entry will be applied to the ARP Detection feature.

**Source** Displays the source of the entry.

**Collision**

Displays the collision status of the entry.

**Warning:** The collision entries have the same IP address and MAC address, and all the collision entries are valid. This kind of collision may be caused by the MSTP function.

**Critical:** The collision entries have the same IP address but different MAC addresses. For the collision entries learned from the same source, only the newly added entry will be valid. For the collision entries learned from different sources, only the entry with the highest priority will be valid. The priority of different entry types, from high to low, is Manually, ARP Scanning and DHCP Snooping.

■ **DHCP Snooping**

With DHCP Snooping enabled, the switch can monitor the IP address obtaining process of the host, and record the IP address, MAC address, VLAN ID and the connected port number of the host.

For instructions on how to configure DHCP Snooping, refer to *DHCP Snooping Configurations*.

### 2.1.3 Viewing the Binding Entries

With the Binding Table, you can view and search the specified binding entries.

Choose the menu **Network Security > IP-MAC Binding > Binding Table** to load the following page.

Figure 2-3 Binding Table

**Search**

Source: Snooping Search

IP:  Select

**Binding Table**

UNIT: 1

| Select                   | Host Name            | IP Address   | MAC Address       | VLAN ID | Port   | Protect Type     | Source   | Collision |
|--------------------------|----------------------|--------------|-------------------|---------|--------|------------------|----------|-----------|
| <input type="checkbox"/> | <input type="text"/> |              |                   |         |        | <span>...</span> |          |           |
| <input type="checkbox"/> | ---                  | 192.168.0.15 | 00-0a-eb-13-12-91 | 1       | 1/0/10 | ARP Detection    | Scanning | ---       |

All Apply Delete Help

In the **Search** section, specify the search criteria to search your desired entries.

**Source**

Select the source of the entry and click **Search**.

**All:** Displays the entries from all sources.

**Manual:** Displays the manually binding entries.

**Scanning:** Displays the binding entries learned from ARP Scanning.

**Snooping:** Displays the binding entries learned from DHCP Snooping.

**IP:**

Enter an IP address and click **Select** to search the specific entry.

In the **Binding Table** section, you can view the searched entries. Additionally, you can configure the host name and protect type for one or more entries, and click **Apply**.

|              |                                                                                                                                                                                                                                                                                                                                                                                                                                                                                                                                                                                                                                                                      |
|--------------|----------------------------------------------------------------------------------------------------------------------------------------------------------------------------------------------------------------------------------------------------------------------------------------------------------------------------------------------------------------------------------------------------------------------------------------------------------------------------------------------------------------------------------------------------------------------------------------------------------------------------------------------------------------------|
| Host Name    | Enter a host name for identification.                                                                                                                                                                                                                                                                                                                                                                                                                                                                                                                                                                                                                                |
| IP Address   | Displays the IP address.                                                                                                                                                                                                                                                                                                                                                                                                                                                                                                                                                                                                                                             |
| MAC Address  | Displays the MAC address.                                                                                                                                                                                                                                                                                                                                                                                                                                                                                                                                                                                                                                            |
| VLAN ID      | Displays the VLAN ID.                                                                                                                                                                                                                                                                                                                                                                                                                                                                                                                                                                                                                                                |
| Port         | Displays the port number.                                                                                                                                                                                                                                                                                                                                                                                                                                                                                                                                                                                                                                            |
| Protect Type | Select the protect type for the entry:<br><br><b>None:</b> This entry will not be applied to the ARP Detection feature.<br><br><b>ARP Detection:</b> This entry will be applied to the ARP Detection feature.                                                                                                                                                                                                                                                                                                                                                                                                                                                        |
| Source       | Displays the source of the entry.                                                                                                                                                                                                                                                                                                                                                                                                                                                                                                                                                                                                                                    |
| Collision    | Displays the collision status of the entry.<br><br><b>Warning:</b> The collision entries have the same IP address and MAC address, and all the collision entries are valid. This kind of collision may be caused by the MSTP function.<br><br><b>Critical:</b> The collision entries have the same IP address but different MAC addresses. For the collision entries learned from the same source, only the newly added entry will be valid. For the collision entries learned from different sources, only the entry with the highest priority will be valid. The priority of different entry types, from high to low, is Manually, ARP Scanning and DHCP Snooping. |

## 2.2 Using the CLI

Binding entries via ARP scanning is not supported by the CLI; Binding entries via DHCP Snooping is introduced in *DHCP Snooping Configurations*. The following sections introduce how to bind entries manually and view the binding entries.

### 2.2.1 Binding Entries Manually

You can manually bind the IP address, MAC address, VLAN ID and the Port number together on the condition that you have got the related information of the hosts.

Follow these steps to manually bind entries:

|        |                                                      |
|--------|------------------------------------------------------|
| Step 1 | <b>configure</b><br>Enter global configuration mode. |
|--------|------------------------------------------------------|

- 
- Step 2      **ip source binding** *hostname ip-addr mac-addr vlan vlan-id interface { gigabitEthernet | ten-gigabitEthernet } port { none | arp-detection } [ forced-source {arp-scanning | dhcp-snooping} ]*
- Manually bind the host name, IP address, MAC address, VLAN ID and port number of the host, and configure the protect type for the host. In addition, you can change the source of the entry as ARP Scanning or DHCP Snooping.
- hostname*: Specify a name for the host. It contains 20 characters at most.
- ip-addr*: Enter the IP address of the host.
- mac-addr*: Enter the MAC address of the host, in the format of xx:xx:xx:xx:xx:xx.
- vlan-id*: Enter the VLAN ID of the host.
- port*: Enter the number of the port on which the host is connected.
- none | arp-detection*: Specify the protect type for the entry. None indicates this entry will not take effect; arp-detection indicates this entry will take effect on the ARP detection feature.
- arp-scanning | dhcp-snooping*: Change the source of the entry to ARP Scanning or DHCP Snooping.
- 
- Step 3      **show ip source binding**
- Verify the binding entry.
- 
- Step 4      **end**
- Return to privileged EXEC mode.
- 
- Step 5      **copy running-config startup-config**
- Save the settings in the configuration file.
- 

The following example shows how to bind an entry with the hostname host1, IP address 192.168.0.55, MAC address AA-BB-CC-DD-EE-FF, VLAN ID 10, port number 1/0/5, and enable this entry for the ARP detection feature.

### Switch#configure

```
Switch(config)#ip source binding host1 192.168.0.55 aa:bb:cc:dd:ee:ff vlan 10 interface
ten-gigabitEthernet 1/0/5 arp-detection
```

### Switch(config)#show ip source binding

| U   | No. | Host  | IP-Addr      | MAC-Addr          | VID | Port    | ACL   | Col.  |
|-----|-----|-------|--------------|-------------------|-----|---------|-------|-------|
| --- | --- | ----- | -----        | -----             | --- | -----   | ----- | ----- |
| 1   | 1   | host1 | 192.168.0.55 | aa:bb:cc:dd:ee:ff | 10  | Te1/0/5 | ARP-D |       |

### Switch(config)#end

### Switch#copy running-config startup-config

## 2.2.2 Viewing Binding Entries

On privileged EXEC mode or any other configuration mode, you can use the following command to view binding entries:

---

### **show ip source binding**

View the information of binding entries, including the host name, IP address, MAC address, VLAN ID, port number, protect type and collision status.

There are two types of collision status: Warning and Critical.

**Warning:** The collision entries have the same IP address and MAC address, and all the collision entries are valid. This kind of collision may be caused by the MSTP function.

**Critical:** The collision entries have the same IP address but different MAC addresses. For the collision entries learned from the same source, only the newly added entry will be valid. For the collision entries learned different sources, only the entry with the highest priority will be valid. The priority of different entry types, from high to low, is Manually, ARP Scanning and DHCP Snooping.

---

# 3 DHCP Snooping Configuration

To complete DHCP Snooping configuration, follow these steps:

- 1) Enable DHCP Snooping on VLAN.
- 2) Configure DHCP Snooping on the specified port.
- 3) (Optional) Configure Option 82 on the specified port.

*Tips:* The switch can dynamically bind the entries via DHCP Snooping after step 1 and step 2 are completed. By default, the binding entries are applied to ARP Detection.

## Configuration Guidelines

DHCP Snooping and DHCP Relay cannot be used at the same time on the switch. When both of these features are enabled, only DHCP Relay will work.

## 3.1 Using the GUI

### 3.1.1 Enabling DHCP Snooping on VLAN

Choose the menu **Network Security > DHCP Snooping > Global Config** to load the following page.

Figure 3-1 Global Config

**DHCP Snooping Configuration**

DHCP Snooping:  Enable  Disable

VLAN ID:   Enable  Disable  
(1-4094, format: 1,3,4-7,11-30)

VLAN Configuration Display:

Follow these steps to enable DHCP Snooping:

- 1) Globally enable DHCP Snooping.
- 2) Enable DHCP Snooping on a VLAN or range of VLANs.

---

**VLAN ID** Specify the VLAN ID in the format shown on the page.

---



**VLAN Configuration Display** Displays the VLANs that have been enabled with DHCP Snooping.

3) Click **Apply**.

### 3.1.2 Configuring DHCP Snooping on Ports

Choose the menu **Network Security > DHCP Snooping > Port Config** to load the following page.

Figure 3-2 Port Config

| DHCP Snooping Port Configuration          |        |                               |                               |                               |                               |     |
|-------------------------------------------|--------|-------------------------------|-------------------------------|-------------------------------|-------------------------------|-----|
| UNIT: <input type="text" value="1"/> LAGS |        |                               |                               |                               |                               |     |
| Select                                    | Port   | Trusted Port                  | MAC Verify                    | Rate Limit                    | Decline Protect               | LAG |
| <input type="checkbox"/>                  |        | <input type="text" value=""/> | <input type="text" value=""/> | <input type="text" value=""/> | <input type="text" value=""/> |     |
| <input type="checkbox"/>                  | 1/0/1  | Disable                       | Enable                        | Disable                       | Disable                       | --- |
| <input type="checkbox"/>                  | 1/0/2  | Disable                       | Enable                        | Disable                       | Disable                       | --- |
| <input type="checkbox"/>                  | 1/0/3  | Disable                       | Enable                        | Disable                       | Disable                       | --- |
| <input type="checkbox"/>                  | 1/0/4  | Disable                       | Enable                        | Disable                       | Disable                       | --- |
| <input type="checkbox"/>                  | 1/0/5  | Disable                       | Enable                        | Disable                       | Disable                       | --- |
| <input type="checkbox"/>                  | 1/0/6  | Disable                       | Enable                        | Disable                       | Disable                       | --- |
| <input type="checkbox"/>                  | 1/0/7  | Disable                       | Enable                        | Disable                       | Disable                       | --- |
| <input type="checkbox"/>                  | 1/0/8  | Disable                       | Enable                        | Disable                       | Disable                       | --- |
| <input type="checkbox"/>                  | 1/0/9  | Disable                       | Enable                        | Disable                       | Disable                       | --- |
| <input type="checkbox"/>                  | 1/0/10 | Disable                       | Enable                        | Disable                       | Disable                       | --- |
| <input type="checkbox"/>                  | 1/0/11 | Disable                       | Enable                        | Disable                       | Disable                       | --- |
| <input type="checkbox"/>                  | 1/0/12 | Disable                       | Enable                        | Disable                       | Disable                       | --- |
| <input type="checkbox"/>                  | 1/0/13 | Disable                       | Enable                        | Disable                       | Disable                       | --- |
| <input type="checkbox"/>                  | 1/0/14 | Disable                       | Enable                        | Disable                       | Disable                       | --- |
| <input type="checkbox"/>                  | 1/0/15 | Disable                       | Enable                        | Disable                       | Disable                       | --- |

Follow these steps to configure DHCP Snooping on the specified port:

1) Select one or more ports and configure the parameters.

**Trusted Port** Select Enable to set the port that is connected to the DHCP server as a trusted port. Select Disable to set the other ports as untrusted ports.

**MAC Verify** Enable or disable the MAC Verify feature. There are two fields in the DHCP packet that contain the MAC address of the host. The MAC Verify feature compares the two fields of a DHCP packet and discards the packet if the two fields are different. This prevents the IP address resource on the DHCP server from being exhausted by forged MAC addresses.

|                        |                                                                                                                                                                                                         |
|------------------------|---------------------------------------------------------------------------------------------------------------------------------------------------------------------------------------------------------|
| <b>Rate Limit</b>      | Select to enable the rate limit feature and specify the maximum number of DHCP packets that can be forwarded on the port per second. The excessive DHCP packets will be discarded.                      |
| <b>Decline Protect</b> | Select to enable the decline protect feature and specify the maximum number of DHCP Decline packets that can be forwarded on the port per second. The excessive DHCP Decline packets will be discarded. |
| <b>LAG</b>             | Displays the LAG that the port is in.                                                                                                                                                                   |

2) Click **Apply**.

### 3.1.3 (Optional) Configuring Option 82

Option 82 records the location of the DHCP client. The switch can add option 82 to the DHCP request packet and then transmit the packet to the DHCP server. Administrators can check the location of the DHCP client via option 82. The DHCP server supporting Option 82 can also set the distribution policy of IP addresses and other parameters, providing a more flexible address distribution way.

Choose the menu **Network Security > DHCP Snooping > Option 82 Config** to load the following page.

Figure 3-3 Option 82 Config

| Select                   | Port   | Option 82 Support | Operation Strategy | Circuit ID Customization | Circuit ID | Remote ID Customization | Remote ID | LAG |
|--------------------------|--------|-------------------|--------------------|--------------------------|------------|-------------------------|-----------|-----|
| <input type="checkbox"/> | 1/0/1  | Disable           | Keep               | Disable                  |            | Disable                 |           | --- |
| <input type="checkbox"/> | 1/0/2  | Disable           | Keep               | Disable                  |            | Disable                 |           | --- |
| <input type="checkbox"/> | 1/0/3  | Disable           | Keep               | Disable                  |            | Disable                 |           | --- |
| <input type="checkbox"/> | 1/0/4  | Disable           | Keep               | Disable                  |            | Disable                 |           | --- |
| <input type="checkbox"/> | 1/0/5  | Disable           | Keep               | Disable                  |            | Disable                 |           | --- |
| <input type="checkbox"/> | 1/0/6  | Disable           | Keep               | Disable                  |            | Disable                 |           | --- |
| <input type="checkbox"/> | 1/0/7  | Disable           | Keep               | Disable                  |            | Disable                 |           | --- |
| <input type="checkbox"/> | 1/0/8  | Disable           | Keep               | Disable                  |            | Disable                 |           | --- |
| <input type="checkbox"/> | 1/0/9  | Disable           | Keep               | Disable                  |            | Disable                 |           | --- |
| <input type="checkbox"/> | 1/0/10 | Disable           | Keep               | Disable                  |            | Disable                 |           | --- |
| <input type="checkbox"/> | 1/0/11 | Disable           | Keep               | Disable                  |            | Disable                 |           | --- |
| <input type="checkbox"/> | 1/0/12 | Disable           | Keep               | Disable                  |            | Disable                 |           | --- |
| <input type="checkbox"/> | 1/0/13 | Disable           | Keep               | Disable                  |            | Disable                 |           | --- |
| <input type="checkbox"/> | 1/0/14 | Disable           | Keep               | Disable                  |            | Disable                 |           | --- |
| <input type="checkbox"/> | 1/0/15 | Disable           | Keep               | Disable                  |            | Disable                 |           | --- |

Follow these steps to configure Option 82:

1) Select one or more ports and configure the parameters.

|                          |                               |
|--------------------------|-------------------------------|
| <b>Option 82 Support</b> | Enable the Option 82 feature. |
|--------------------------|-------------------------------|

|                          |                                                                                                                                                                                                                                                                                                                                                                                                                                                                                                                                                                                                           |
|--------------------------|-----------------------------------------------------------------------------------------------------------------------------------------------------------------------------------------------------------------------------------------------------------------------------------------------------------------------------------------------------------------------------------------------------------------------------------------------------------------------------------------------------------------------------------------------------------------------------------------------------------|
| Operation Strategy       | <p>Select the operation for the Option 82 field of the DHCP request packets.</p> <p><b>Keep:</b> Indicates keeping the Option 82 field of the packets.</p> <p><b>Replace:</b> Indicates replacing the Option 82 field of the packets with one defined by the switch. By default, the Circuit ID is defined to be the VLAN and the number of the port which receives the DHCP Request packets. The Remote ID is defined as the MAC address of the DHCP Snooping device which receives the DHCP Request packets.</p> <p><b>Drop:</b> Indicates discarding the packets that include the Option 82 field.</p> |
| Circuit ID Customization | Select Enable to manually define the circuit ID field, which is a sub-option of Option 82. The circuit ID configurations of the switch and the DHCP server should be compatible with each other.                                                                                                                                                                                                                                                                                                                                                                                                          |
| Circuit ID               | Enter the customized circuit ID, which contains up to 64 characters.                                                                                                                                                                                                                                                                                                                                                                                                                                                                                                                                      |
| Remote ID Customization  | Select Enable to manually define the remote ID field, which is a sub-option of Option 82. The remote ID configurations of the switch and the DHCP server should be compatible with each other.                                                                                                                                                                                                                                                                                                                                                                                                            |
| Remote ID                | Enter the customized remote ID, which contains up to 64 characters.                                                                                                                                                                                                                                                                                                                                                                                                                                                                                                                                       |
| LAG                      | Displays the LAG that the port is in.                                                                                                                                                                                                                                                                                                                                                                                                                                                                                                                                                                     |

2) Click **Apply**.

## 3.2 Using the CLI

### 3.2.1 Globally Configuring DHCP Snooping

Follow these steps to globally configure DHCP Snooping:

|        |                                                                                                                                                                                  |
|--------|----------------------------------------------------------------------------------------------------------------------------------------------------------------------------------|
| Step 1 | <p><b>configure</b></p> <p>Enter global configuration mode.</p>                                                                                                                  |
| Step 2 | <p><b>ip dhcp snooping</b></p> <p>Globally enable DHCP Snooping.</p>                                                                                                             |
| Step 3 | <p><b>ip dhcp snooping vlan <i>vlan-range</i></b></p> <p>Enable DHCP Snooping on the specified VLAN.</p> <p><i>vlan-range:</i> Enter the vlan range in the format of 1-3, 5.</p> |
| Step 4 | <p><b>show ip dhcp snooping</b></p> <p>Verify global configuration of DHCP Snooping.</p>                                                                                         |

- 
- |        |                                               |
|--------|-----------------------------------------------|
| Step 5 | <b>end</b><br>Return to privileged EXEC mode. |
|--------|-----------------------------------------------|
- 
- |        |                                                                                           |
|--------|-------------------------------------------------------------------------------------------|
| Step 6 | <b>copy running-config startup-config</b><br>Save the settings in the configuration file. |
|--------|-------------------------------------------------------------------------------------------|
- 

The following example shows how to enable DHCP Snooping globally and on VLAN 5:

**Switch#configure**

**Switch(config)#ip dhcp snooping**

**Switch(config)#ip dhcp snooping vlan 5**

**Switch(config)#show ip dhcp snooping**

Global Status: Enable

VLAN ID: 5

**Switch(config-if)#end**

**Switch#copy running-config startup-config**

### 3.2.2 Configuring DHCP Snooping on Ports

Follow these steps to configure DHCP Snooping on the specified ports.

- 
- |        |                                                      |
|--------|------------------------------------------------------|
| Step 1 | <b>configure</b><br>Enter global configuration mode. |
|--------|------------------------------------------------------|
- 
- |        |                                                                                                                                                                                                                                                                                 |
|--------|---------------------------------------------------------------------------------------------------------------------------------------------------------------------------------------------------------------------------------------------------------------------------------|
| Step 2 | <b>interface {fastEthernet <i>port</i>   range fastEthernet <i>port-list</i>   gigabitEthernet <i>port</i>   range gigabitEthernet <i>port-list</i>   ten-gigabitEthernet <i>port</i>   range ten-gigabitEthernet <i>port-list</i> }</b><br>Enter interface configuration mode. |
|--------|---------------------------------------------------------------------------------------------------------------------------------------------------------------------------------------------------------------------------------------------------------------------------------|
- 
- |        |                                                                                                                                                                                                                                                                                                               |
|--------|---------------------------------------------------------------------------------------------------------------------------------------------------------------------------------------------------------------------------------------------------------------------------------------------------------------|
| Step 3 | <b>ip dhcp snooping trust</b><br>Set the port that is connected to the DHCP server as a trusted port. The switch can forward the DHCP packets on the trusted port and discard the DHCP response packets on the untrusted port, so as to ensure that users get proper IP addresses from the legal DHCP server. |
|--------|---------------------------------------------------------------------------------------------------------------------------------------------------------------------------------------------------------------------------------------------------------------------------------------------------------------|
- 
- |        |                                                                                                                                                                                                                                                                                                                                                                                        |
|--------|----------------------------------------------------------------------------------------------------------------------------------------------------------------------------------------------------------------------------------------------------------------------------------------------------------------------------------------------------------------------------------------|
| Step 4 | <b>ip dhcp snooping mac-verify</b><br>Enable the MAC Verify feature. There are two fields in the DHCP packet that contain the MAC address of the host. The MAC Verify feature compares the two fields of a DHCP packet and discards the packet if the two fields are different. This prevents the IP address resource on the DHCP server from being exhausted by forged MAC addresses. |
|--------|----------------------------------------------------------------------------------------------------------------------------------------------------------------------------------------------------------------------------------------------------------------------------------------------------------------------------------------------------------------------------------------|
-

- 
- Step 5      **ip dhcp snooping limit rate *value***
- Enable the limit rate feature and specify the maximum number of DHCP messages that can be forwarded on the port per second. The excessive DHCP packets will be discarded.
- value*: Specify the limit rate value. Seven options are provided: 0, 5,10,15,20,25 and 30 (packets/second). The default value is 0, which indicates disabling limit rate.
- 
- Step 6      **ip dhcp snooping decline rate *value***
- Enable the decline protect feature and specify the maximum number of Decline packets can be forwarded per second on the port. The excessive DHCP Decline packets will be discarded.
- value*: Specify the limit rate value of Decline packets. Seven options are provided: 0, 5,10,15,20,25 and 30 (packets/second). The default value is 0, which indicates disabling this feature.
- 
- Step 7      **show ip dhcp snooping interface [ fastEthernet *port* | gigabitEthernet *port* | ten-gigabitEthernet *port* | port-channel *port-channel-id* ]**
- Verify the DHCP Snooping configuration of the port.
- 
- Step 8      **end**
- Return to privileged EXEC mode.
- 
- Step 9      **copy running-config startup-config**
- Save the settings in the configuration file.
- 

The following example shows how to configure port 1/0/1 as a trusted port, enable the MAC verify feature, and set the limit rate as 10 pps and decline rate as 20 pps on this port:

**Switch#configure**

**Switch(config)#interface ten-gigabitEthernet 1/0/1**

**Switch(config-if)#ip dhcp snooping trust**

**Switch(config-if)#ip dhcp snooping mac-verify**

**Switch(config-if)#ip dhcp snooping limit rate 10**

**Switch(config-if)#ip dhcp snooping decline rate 20**

**Switch(config-if)#show ip dhcp snooping interface ten-gigabitEthernet 1/0/1**

| Interface | Trusted | MAC-Verify | Limit-Rate | Dec-rate | LAG |
|-----------|---------|------------|------------|----------|-----|
| -----     | -----   | -----      | -----      | -----    | --- |
| Te1/0/1   | Enable  | Enable     | 10         | 20       | N/A |

**Switch(config-if)#end**

**Switch#copy running-config startup-config**

### 3.2.3 (Optional) Configuring Option 82

Option 82 records the location of the DHCP client. The switch can add the Option 82 to the DHCP request packet and then transmit the packet to the DHCP server. Administrators can check the location of the DHCP client via option 82. The DHCP server supporting Option 82 can also set the distribution policy of IP addresses and other parameters, providing more flexible address distribution way.

Follow these steps to configure Option 82:

---

|        |                                                                                                                                                                                                                                                                                                                                                                                                                                                                                                                                                                                                                                                                                                                        |
|--------|------------------------------------------------------------------------------------------------------------------------------------------------------------------------------------------------------------------------------------------------------------------------------------------------------------------------------------------------------------------------------------------------------------------------------------------------------------------------------------------------------------------------------------------------------------------------------------------------------------------------------------------------------------------------------------------------------------------------|
| Step 1 | <b>configure</b><br>Enter global configuration mode.                                                                                                                                                                                                                                                                                                                                                                                                                                                                                                                                                                                                                                                                   |
| Step 2 | <b>interface {fastEthernet <i>port</i>   range fastEthernet <i>port-list</i>   gigabitEthernet <i>port</i>   range gigabitEthernet <i>port-list</i>   ten-gigabitEthernet <i>port</i>   range ten-gigabitEthernet <i>port-list</i> }</b><br>Enter interface configuration mode.                                                                                                                                                                                                                                                                                                                                                                                                                                        |
| Step 3 | <b>ip dhcp snooping information option</b><br>Enable the Option 82 feature on the port.                                                                                                                                                                                                                                                                                                                                                                                                                                                                                                                                                                                                                                |
| Step 4 | <b>ip dhcp snooping information strategy { keep   replace   drop }</b><br>Specify the operation for the Option 82 field of the DHCP request packets from the Host. Three options are provided:<br><br><b>keep:</b> Indicates keeping the Option 82 field of the packets.<br><br><b>replace:</b> Indicates replacing the Option 82 field of the packets with one defined by switch. By default, the Circuit ID is defined to be the VLAN and the number of the port which receives the DHCP Request packets. The Remote ID is defined to be the MAC address of the DHCP Snooping device which receives the DHCP Request packets.<br><br><b>drop:</b> Indicates discarding the packets that include the Option 82 field. |
| Step 5 | <b>ip dhcp snooping information circuit-id <i>string</i></b><br>Configure the circuit ID. The circuit ID configurations of the switch and the DHCP server should be compatible with each other.<br><br><b><i>string:</i></b> Enter the circuit ID, which contains up to 64 characters.                                                                                                                                                                                                                                                                                                                                                                                                                                 |
| Step 6 | <b>ip dhcp snooping information remote-id <i>string</i></b><br>Configure the remote ID. The remote ID configurations of the switch and the DHCP server should be compatible with each other.<br><br><b><i>string:</i></b> Enter the remote ID, which contains up to 64 characters.                                                                                                                                                                                                                                                                                                                                                                                                                                     |
| Step 7 | <b>show ip dhcp snooping information interface { fastEthernet <i>port</i>   gigabitEthernet <i>port</i>   ten-gigabitEthernet <i>port</i>   port-channel <i>port-channel-id</i> }</b><br>Verify the Option 82 configuration of the port.                                                                                                                                                                                                                                                                                                                                                                                                                                                                               |
| Step 8 | <b>end</b><br>Return to privileged EXEC mode.                                                                                                                                                                                                                                                                                                                                                                                                                                                                                                                                                                                                                                                                          |

---

---

Step 9      **copy running-config startup-config**  
 Save the settings in the configuration file.

---

The following example shows how to enable Option 82 on port 1/0/7 and configure the strategy as replace, the circuit-id as VLAN20 and the remote-id as Host1:

**Switch#configure**

**Switch(config)#interface ten-gigabitEthernet 1/0/7**

**Switch(config-if)#ip dhcp snooping information option**

**Switch(config-if)#ip dhcp snooping information strategy replace**

**Switch(config-if)#ip dhcp snooping information circuit-id VLAN20**

**Switch(config-if)#ip dhcp snooping information remote-id Host1**

**Switch(config-if)#show ip dhcp snooping information interface ten-gigabitEthernet 1/0/7**

| Interface | Option 82 Status | Operation Strategy | Circuit ID | Remote ID | LAG   |
|-----------|------------------|--------------------|------------|-----------|-------|
| -----     | -----            | -----              | -----      | -----     | ----- |
| Te1/0/7   | Enable           | Replace            | VLAN20     | Host1     | N/A   |

**Switch(config-if)#end**

**Switch#copy running-config startup-config**

# 4 ARP Inspection Configurations

With ARP Inspection configurations, you can:

- Configure ARP Detection
- Configure ARP Defend
- View ARP Statistics

## 4.1 Using the GUI

### 4.1.1 Configuring ARP Detection

The ARP Detection feature allows the switch to detect the ARP packets based on the binding entries in the IP-MAC Binding Table and filter out the illegal ARP packets. Before ARP Detection configuration, complete IP-MAC Binding configuration. For details, refer to *IP-MAC Binding Configurations*.

Choose the menu **Network Security > ARP Inspection > ARP Detect** to load the following page.

Figure 4-1 ARP Detect

Follow these steps to configure ARP Detection:

- 1) In the **ARP Detect** section, enable the ARP Detection feature.
- 2) In the **Trusted Port** section, select one or more ports to be configured as the trusted port(s), on which the ARP Detection function will be inactive. The specific ports, such as up-link ports and routing ports are suggested to be set as trusted.



3) Click **Apply**.

### 4.1.2 Configuring ARP Defend

With ARP Defend enabled, the switch can terminate receiving the ARP packets for 300 seconds when the transmission speed of the legal ARP packet on the port exceeds the defined value so as to avoid ARP Attack flood.

Choose the menu **Network Security > ARP Inspection > ARP Defend** to load the following page.

Figure 4-2 ARP Defend

| ARP Defend                           |        |                                                                |                               |                     |        |     |           |
|--------------------------------------|--------|----------------------------------------------------------------|-------------------------------|---------------------|--------|-----|-----------|
| UNIT: <input type="text" value="1"/> |        |                                                                |                               |                     |        |     |           |
| Select                               | Port   | Defend                                                         | Speed (10-100)pps             | Current Speed (pps) | Status | LAG | Operation |
| <input type="checkbox"/>             |        | <input type="text" value=""/> <input type="button" value="v"/> | <input type="text" value=""/> |                     |        |     |           |
| <input type="checkbox"/>             | 1/0/1  | Disable                                                        | 15                            | ---                 | ---    | --- | ---       |
| <input type="checkbox"/>             | 1/0/2  | Disable                                                        | 15                            | ---                 | ---    | --- | ---       |
| <input type="checkbox"/>             | 1/0/3  | Disable                                                        | 15                            | ---                 | ---    | --- | ---       |
| <input type="checkbox"/>             | 1/0/4  | Disable                                                        | 15                            | ---                 | ---    | --- | ---       |
| <input type="checkbox"/>             | 1/0/5  | Disable                                                        | 15                            | ---                 | ---    | --- | ---       |
| <input type="checkbox"/>             | 1/0/6  | Disable                                                        | 15                            | ---                 | ---    | --- | ---       |
| <input type="checkbox"/>             | 1/0/7  | Disable                                                        | 15                            | ---                 | ---    | --- | ---       |
| <input type="checkbox"/>             | 1/0/8  | Disable                                                        | 15                            | ---                 | ---    | --- | ---       |
| <input type="checkbox"/>             | 1/0/9  | Disable                                                        | 15                            | ---                 | ---    | --- | ---       |
| <input type="checkbox"/>             | 1/0/10 | Disable                                                        | 15                            | ---                 | ---    | --- | ---       |
| <input type="checkbox"/>             | 1/0/11 | Disable                                                        | 15                            | ---                 | ---    | --- | ---       |
| <input type="checkbox"/>             | 1/0/12 | Disable                                                        | 15                            | ---                 | ---    | --- | ---       |
| <input type="checkbox"/>             | 1/0/13 | Disable                                                        | 15                            | ---                 | ---    | --- | ---       |
| <input type="checkbox"/>             | 1/0/14 | Disable                                                        | 15                            | ---                 | ---    | --- | ---       |
| <input type="checkbox"/>             | 1/0/15 | Disable                                                        | 15                            | ---                 | ---    | --- | ---       |

Follow these steps to configure ARP Defend:

1) Select one or more ports and configure the parameters.

|                            |                                                                                                                                                                                                                                                                                                          |
|----------------------------|----------------------------------------------------------------------------------------------------------------------------------------------------------------------------------------------------------------------------------------------------------------------------------------------------------|
| <b>Defend</b>              | Enable the ARP Defend feature.                                                                                                                                                                                                                                                                           |
| <b>Speed (10-100) pps</b>  | Specify the maximum number of the ARP packets that can be received on the port per second. The valid values are from 10 to 100 pps (packet/second), and the default value is 15.                                                                                                                         |
| <b>Current Speed (pps)</b> | Displays the current speed of receiving the ARP packets on the port.                                                                                                                                                                                                                                     |
| <b>Status</b>              | <p>Displays the status of the ARP attack:</p> <p><b>Normal:</b> The forwarding of ARP packets on the port is normal.</p> <p><b>Drop ARP300sec:</b> The speed of receiving the ARP packets has exceeded the specified value, and the port will drop the received ARP packets in the next 300 seconds.</p> |

|           |                                                                                                                            |
|-----------|----------------------------------------------------------------------------------------------------------------------------|
| LAG       | Displays the LAG that the port is in.                                                                                      |
| Operation | Click the <b>Recover</b> button to restore the port to the normal status. The ARP Defend for this port will be re-enabled. |

2) Click **Apply**.

### 4.1.3 Viewing ARP Statistics

You can view the number of the illegal ARP packets received on each port, which facilitates you to locate the network malfunction and take the related protection measures.

Choose the menu **Network Security > ARP Inspection > ARP Statistics** to load the following page.

Figure 4-3 ARP Statistics

**Auto Refresh**

Auto Refresh:  Enable  Disable Apply

Refresh Interval:  sec(3-300)

**Illegal ARP Packet**

UNIT:

| Port   | Trusted Port | Illegal ARP Packet |
|--------|--------------|--------------------|
| 1/0/1  | No           | 0                  |
| 1/0/2  | No           | 0                  |
| 1/0/3  | No           | 0                  |
| 1/0/4  | No           | 0                  |
| 1/0/5  | No           | 0                  |
| 1/0/6  | No           | 0                  |
| 1/0/7  | No           | 0                  |
| 1/0/8  | No           | 0                  |
| 1/0/9  | No           | 0                  |
| 1/0/10 | No           | 0                  |
| 1/0/11 | No           | 0                  |
| 1/0/12 | No           | 0                  |
| 1/0/13 | No           | 0                  |
| 1/0/14 | No           | 0                  |
| 1/0/15 | No           | 0                  |

Clear
Refresh
Help

In the **Auto Refresh** section, you can enable the auto refresh feature and specify the refresh interval, and thus the web page will be automatically refreshed.

In the **Illegal ARP Packet** section, you can view the number of illegal ARP packets on each port.

|                    |                                                           |
|--------------------|-----------------------------------------------------------|
| Trusted Port       | Indicates whether the port is an ARP trusted port or not. |
| Illegal ARP Packet | Displays the number of the received illegal ARP packets.  |

## 4.2 Using the CLI

### 4.2.1 Configuring ARP Detection

The ARP Detection feature allows the switch to detect the ARP packets basing on the binding entries in the IP-MAC Binding Table and filter the illegal ARP packets. Before ARP Detection configuration, complete IP-MAC Binding configuration. For details, refer to *IP-MAC Binding Configurations*.

Follow these steps to configure ARP Detection:

|        |                                                                                                                                                                                                                                                                                 |
|--------|---------------------------------------------------------------------------------------------------------------------------------------------------------------------------------------------------------------------------------------------------------------------------------|
| Step 1 | <b>configure</b><br>Enter global configuration mode.                                                                                                                                                                                                                            |
| Step 2 | <b>ip arp inspection</b><br>Globally enable the ARP Detection feature.                                                                                                                                                                                                          |
| Step 3 | <b>interface {fastEthernet <i>port</i>   range fastEthernet <i>port-list</i>   gigabitEthernet <i>port</i>   range gigabitEthernet <i>port-list</i>   ten-gigabitEthernet <i>port</i>   range ten-gigabitEthernet <i>port-list</i> }</b><br>Enter interface configuration mode. |
| Step 4 | <b>ip arp inspection trust</b><br>Configure the port as a trusted port, on which the ARP Detection function will not take effect. The specific ports, such as up-linked ports and routing ports are suggested to be set as trusted ports.                                       |
| Step 5 | <b>show ip arp inspection</b><br>Verify the ARP Inspection configuration.                                                                                                                                                                                                       |
| Step 6 | <b>end</b><br>Return to privileged EXEC mode.                                                                                                                                                                                                                                   |
| Step 7 | <b>copy running-config startup-config</b><br>Save the settings in the configuration file.                                                                                                                                                                                       |

The following example shows how to globally enable ARP Detection and configure port 1/0/1 as a trusted port.

```
Switch#configure
```

```
Switch(config)#ip arp inspection
```

```
Switch(config)#interface ten-gigabitEthernet 1/0/1
```

```
Switch(config-if)#ip arp inspection trust
```

```
Switch(config-if)#show ip arp inspection
```

```
ARP detection global status: Enabled
```

```
Port    Trusted
```

```
Te1/0/1  YES
```

```
Te1/0/2  NO
```

```
.....
```

```
Switch(config-if)#end
```

```
Switch#copy running-config startup-config
```

## 4.2.2 Configuring ARP Defend

With ARP Defend enabled, the switch can terminate receiving the ARP packets for 300 seconds when the transmission speed of the legal ARP packet on the port exceeds the defined value so as to avoid ARP Attack flood.

Follow these steps to configure ARP Defend:

|        |                                                                                                                                                                                                                                                                                      |
|--------|--------------------------------------------------------------------------------------------------------------------------------------------------------------------------------------------------------------------------------------------------------------------------------------|
| Step 1 | <b>configure</b><br>Enter global configuration mode.                                                                                                                                                                                                                                 |
| Step 2 | <b>interface {fastEthernet <i>port</i>   range fastEthernet <i>port-list</i>   gigabitEthernet <i>port</i>   range gigabitEthernet <i>port-list</i>   ten-gigabitEthernet <i>port</i>   range ten-gigabitEthernet <i>port-list</i> }</b><br>Enter interface configuration mode.      |
| Step 3 | <b>ip arp inspection</b><br>Enable the ARP defend feature on the port.                                                                                                                                                                                                               |
| Step 4 | <b>ip arp inspection limit-rate <i>value</i></b><br>Specify the maximum number of the ARP packets can be received on the port per second.<br><br><i>value</i> : Specify the limit rate value. The valid values are from 10 to 100 pps (packets/second), and the default value is 15. |
| Step 5 | <b>show ip arp inspection interface</b><br>(Optional) View the configurations and status of the ports.                                                                                                                                                                               |
| Step 6 | <b>ip arp inspection recover</b><br>(Optional) For ports which the speed of receiving ARP packets has exceeded the limit, use this command to restore the port from Discard status to Normal status.                                                                                 |

---

|        |                                 |
|--------|---------------------------------|
| Step 7 | <b>end</b>                      |
|        | Return to privileged EXEC mode. |

---

|        |                                              |
|--------|----------------------------------------------|
| Step 8 | <b>copy running-config startup-config</b>    |
|        | Save the settings in the configuration file. |

---

The following example shows how to enable ARP Defend and configure the ARP inspection limit-rate as 20 pps on port 1/0/2:

**Switch#configure**

**Switch(config)#interface ten-gigabitEthernet 1/0/2**

**Switch(config-if)#ip arp inspection**

**Switch(config-if)#ip arp inspection limit-rate 20**

**Switch(config-if)#show ip arp inspection interface ten-gigabitEthernet 1/0/2**

| Port    | OverSpeed | Rate | Current | Status | LAG |
|---------|-----------|------|---------|--------|-----|
| Te1/0/2 | Enabled   | 20   | N/A     | Normal | N/A |

**Switch(config-if)#end**

**Switch#copy running-config startup-config**

The following example shows how to restore the port 1/0/1 that is in Discard status to Normal status:

**Switch#configure**

**Switch(config)#show ip arp inspection interface**

| Port    | OverSpeed | Rate | Current | Status       | LAG |
|---------|-----------|------|---------|--------------|-----|
| Te1/0/1 | Enabled   | 15   | N/A     | Discard,290s | N/A |
| Te1/0/2 | Enabled   | 15   | N/A     | Normal       | N/A |

.....

**Switch(config)#interface ten-gigabitEthernet 1/0/1**

**Switch(config-if)#ip arp recover**

**Switch(config-if)#show ip arp inspection interface ten-gigabitEthernet 1/0/1**

| Port    | OverSpeed | Rate | Current | Status | LAG |
|---------|-----------|------|---------|--------|-----|
| Te1/0/1 | Disabled  | 15   | N/A     | Normal | N/A |

**Switch(config-if)#end**

**Switch#copy running-config startup-config**

### 4.2.3 Viewing ARP Statistics

On privileged EXEC mode or any other configuration mode, you can use the following command to view ARP statistics:

---

**show ip arp inspection statistics**

View the ARP statistics on each port, including whether the port is trusted port and the number of received ARP packets on the port.

---

# 5 DoS Defend Configuration

## 5.1 Using the GUI

Choose the menu **Network Security > DoS Defend > DoS Defend** to load the following page.

Figure 5-1 Dos Defend

**Configure**

DoS Protection:       Enable    Disable

| Select                   | Defend Type          |
|--------------------------|----------------------|
| <input type="checkbox"/> | Land Attack          |
| <input type="checkbox"/> | Scan SYNFIN          |
| <input type="checkbox"/> | Xmascan              |
| <input type="checkbox"/> | NULL Scan            |
| <input type="checkbox"/> | SYN sPort less 1024  |
| <input type="checkbox"/> | Blat Attack          |
| <input type="checkbox"/> | Ping Flooding        |
| <input type="checkbox"/> | SYN/SYN-ACK Flooding |
| <input type="checkbox"/> | WinNuke Attack       |

Follow these steps to configure DoS Defend:

- 1) In the **Configure** section, enable DoS Protection.
- 2) In the **Defend Table** section, select one or more defend types according to your needs. The following table introduces each type of DoS attack.

|                    |                                                                                                                                                                                                                                                                                                         |
|--------------------|---------------------------------------------------------------------------------------------------------------------------------------------------------------------------------------------------------------------------------------------------------------------------------------------------------|
| <b>Land Attack</b> | The attacker sends a specific fake SYN (synchronous) packet to the destination host. Because both of the source IP address and the destination IP address of the SYN packet are set to be the IP address of the host, the host will be trapped in an endless circle of building the initial connection. |
| <b>Scan SYNFIN</b> | The attacker sends the packet with its SYN field and the FIN field set to 1. The SYN field is used to request initial connection whereas the FIN field is used to request disconnection. Therefore, the packet of this type is illegal.                                                                 |
| <b>Xmascan</b>     | The attacker sends the illegal packet with its TCP index, FIN, URG and PSH field set to 1.                                                                                                                                                                                                              |

|                              |                                                                                                                                                                                                                                                                                                                                                                                                                                           |
|------------------------------|-------------------------------------------------------------------------------------------------------------------------------------------------------------------------------------------------------------------------------------------------------------------------------------------------------------------------------------------------------------------------------------------------------------------------------------------|
| <b>NULL Scan</b>             | The attacker sends the illegal packet with its TCP index and all the control fields set to 0. During the TCP connection and data transmission, the packets with all control fields set to 0 are considered illegal.                                                                                                                                                                                                                       |
| <b>SYN sPort less 1024:</b>  | The attacker sends the illegal packet with its TCP SYN field set to 1 and source port smaller than 1024.                                                                                                                                                                                                                                                                                                                                  |
| <b>Blat Attack:</b>          | The attacker sends the illegal packet with the same source port and destination port on Layer 4 and with its URG field set to 1. Similar to the Land Attack, the system performance of the attacked host is reduced because the Host circularly attempts to build a connection with the attacker.                                                                                                                                         |
| <b>Ping Flooding:</b>        | The attacker floods the destination system with Ping packets, creating a broadcast storm that makes it impossible for the system to respond to legal communication.                                                                                                                                                                                                                                                                       |
| <b>SYN/SYN-ACK Flooding:</b> | The attacker uses a fake IP address to send TCP request packets to the server. Upon receiving the request packets, the server responds with SYN-ACK packets. Since the IP address is fake, no response will be returned. The server will keep on sending SYN-ACK packets. If the attacker sends overflowing fake request packets, the network resource will be occupied maliciously and the requests of the legal clients will be denied. |
| <b>WinNuke Attack</b>        | Because the Operation System with bugs cannot correctly process the URG (Urgent Pointer) of TCP packets, the attacker sends this type of packets to the TCP port 139 (NetBIOS) of the host with the Operation System bugs, which will cause the host with a blue screen.                                                                                                                                                                  |

3) Click **Apply**.

## 5.2 Using the CLI

Follow these steps to configure DoS Defend:

|        |                                                                  |
|--------|------------------------------------------------------------------|
| Step 1 | <b>configure</b><br>Enter global configuration mode.             |
| Step 2 | <b>ip dos-prevent</b><br>Globally enable the DoS defend feature. |



---

|        |                                                                                                                                                                                                                                                                                                                                                                                                                                                                                                                                                                                                                                                                                                                                                                                                                                                                                                                                                                                                                                                                                                                                                                                                                                                                                                                                                                                                                                                                                                                                                                                                                                                                                                                                                                                                                                                                                                                                                                                                                                                                                                                                                                                                                                                                                                                                                                                                                                                                                                                                                                                                                  |
|--------|------------------------------------------------------------------------------------------------------------------------------------------------------------------------------------------------------------------------------------------------------------------------------------------------------------------------------------------------------------------------------------------------------------------------------------------------------------------------------------------------------------------------------------------------------------------------------------------------------------------------------------------------------------------------------------------------------------------------------------------------------------------------------------------------------------------------------------------------------------------------------------------------------------------------------------------------------------------------------------------------------------------------------------------------------------------------------------------------------------------------------------------------------------------------------------------------------------------------------------------------------------------------------------------------------------------------------------------------------------------------------------------------------------------------------------------------------------------------------------------------------------------------------------------------------------------------------------------------------------------------------------------------------------------------------------------------------------------------------------------------------------------------------------------------------------------------------------------------------------------------------------------------------------------------------------------------------------------------------------------------------------------------------------------------------------------------------------------------------------------------------------------------------------------------------------------------------------------------------------------------------------------------------------------------------------------------------------------------------------------------------------------------------------------------------------------------------------------------------------------------------------------------------------------------------------------------------------------------------------------|
| Step 3 | <p><b>ip dos-prevent type { land   scan-synfin   xma-scan   null-scan   port-less-1024   blat   ping-flood   syn-flood   win-nuke }</b></p> <p>Configure one or more defend types according to your needs. The types of DoS attack are introduced as follows.</p> <p><b>land:</b> The attacker sends a specific fake SYN (synchronous) packet to the destination host. Because both the source IP address and the destination IP address of the SYN packet are set to be the IP address of the host, the host will be trapped in an endless circle of building the initial connection.</p> <p><b>scan-synfin:</b> The attacker sends the packet with its SYN field and the FIN field set to 1. The SYN field is used to request initial connection whereas the FIN field is used to request disconnection. Therefore, a packet of this type is illegal.</p> <p><b>xma-scan:</b> The attacker sends the illegal packet with its TCP index, FIN, URG and PSH field set to 1.</p> <p><b>null-scan:</b> The attacker sends the illegal packet with its TCP index and all the control fields set to 0. During the TCP connection and data transmission, the packets with all the control fields set to 0 are considered as the illegal packets.</p> <p><b>port-less-1024:</b> The attacker sends the illegal packet with its TCP SYN field set to 1 and source port smaller than 1024.</p> <p><b>blat:</b> The attacker sends the illegal packet with the same source port and destination port on Layer 4 and with its URG field set to 1. Similar to the Land Attack, the system performance of the attacked host is reduced because the Host circularly attempts to build a connection with the attacker.</p> <p><b>ping-flood:</b> The attacker floods the destination system with Ping packets, creating a broadcast storm that makes it impossible for system to respond to legal communication.</p> <p><b>syn-flood:</b> The attacker uses a fake IP address to send TCP request packets to the server. Upon receiving the request packets, the server responds with SYN-ACK packets. Since the IP address is fake, no response will be returned. The server will keep on sending SYN-ACK packets. If the attacker sends overflowing fake request packets, the network resource will be occupied maliciously and the requests of the legal clients will be denied.</p> <p><b>win-nuke:</b> An Operation System with bugs cannot process the URG (Urgent Pointer) of TCP packets. If the attacker sends TCP packets to port139 (NetBIOS) of the host with Operation System bugs, it will cause blue screen.</p> |
| Step 4 | <p><b>show ip dos-prevent</b></p> <p>Verify the Dos Defend configuration.</p>                                                                                                                                                                                                                                                                                                                                                                                                                                                                                                                                                                                                                                                                                                                                                                                                                                                                                                                                                                                                                                                                                                                                                                                                                                                                                                                                                                                                                                                                                                                                                                                                                                                                                                                                                                                                                                                                                                                                                                                                                                                                                                                                                                                                                                                                                                                                                                                                                                                                                                                                    |
| Step 5 | <p><b>end</b></p> <p>Return to privileged EXEC mode.</p>                                                                                                                                                                                                                                                                                                                                                                                                                                                                                                                                                                                                                                                                                                                                                                                                                                                                                                                                                                                                                                                                                                                                                                                                                                                                                                                                                                                                                                                                                                                                                                                                                                                                                                                                                                                                                                                                                                                                                                                                                                                                                                                                                                                                                                                                                                                                                                                                                                                                                                                                                         |
| Step 6 | <p><b>copy running-config startup-config</b></p> <p>Save the settings in the configuration file.</p>                                                                                                                                                                                                                                                                                                                                                                                                                                                                                                                                                                                                                                                                                                                                                                                                                                                                                                                                                                                                                                                                                                                                                                                                                                                                                                                                                                                                                                                                                                                                                                                                                                                                                                                                                                                                                                                                                                                                                                                                                                                                                                                                                                                                                                                                                                                                                                                                                                                                                                             |

---

The following example shows how to enable the DoS Defend type named land:

### Switch#configure

```
Switch(config)#ip dos-prevent
```

```
Switch(config)#ip dos-prevent type land
```

```
Switch(config)#show ip dos-prevent
```

```
DoS Prevention State:    Enabled
```

```
Type                    Status
```

```
-----
```

```
-----
```

```
Land Attack            Enabled
```

```
Scan SYNFIN           Disabled
```

```
Xmascan                Disabled
```

```
.....
```

```
Switch(config)#end
```

```
Switch#copy running-config startup-config
```

# 6 802.1X Configuration

To complete the 802.1X configuration, follow these steps:

- 1) Configure the RADIUS server.
- 2) Configure 802.1X globally.
- 3) Configure 802.1X on ports.

## Configuration Guidelines

802.1X authentication and Port Security cannot be enabled at the same time. Before enabling 802.1X authentication, make sure that Port Security is disabled.

## 6.1 Using the GUI

### 6.1.1 Configuring the RADIUS Server

Enable AAA function on the switch, configure the parameters of RADIUS sever and configure the RADIUS server group.

- Enabling AAA function

Choose the menu **Network Security > AAA > Global Config** to load the following page.

Figure 6-1 Enable AAA Function



The screenshot shows a configuration page titled "Global Config". Under the heading "AAA:", there are two radio buttons: "Enable" (which is selected) and "Disable". To the right of these options is an "Apply" button.

In the **Global Config** section, enable AAA function on the switch and click **Apply**.

- Adding the RADIUS Server

Choose the menu **Network Security > AAA > RADIUS Config** to load the following page.

Figure 6-2 RADIUS Config

**Server Config**

Server IP:  (Format:192.168.0.1)

Shared Key:

Auth Port:  (1-65535)

Acct Port:  (1-65535)

Retransmit:  (1-3)

Timeout:  sec(1-9)

---

**Server List**

| Select                   | Server IP    | Shared Key           | Auth Port            | Acct Port            | Retransmit           | Timeout              |
|--------------------------|--------------|----------------------|----------------------|----------------------|----------------------|----------------------|
| <input type="checkbox"/> |              | <input type="text"/> | <input type="text"/> | <input type="text"/> | <input type="text"/> | <input type="text"/> |
| <input type="checkbox"/> | 192.168.0.10 | 123456               | 1812                 | 1813                 | 2                    | 5                    |
| <input type="checkbox"/> | 192.168.0.20 | 123456               | 1812                 | 1813                 | 2                    | 5                    |

Follow these steps to create a protocol template:

- 1) In the **Server Config** section, configure the parameters of RADIUS server.
- 2) Click **Apply**.

|                   |                                                                                                                                                                 |
|-------------------|-----------------------------------------------------------------------------------------------------------------------------------------------------------------|
| <b>Server IP</b>  | Enter the IP address of the server running the RADIUS secure protocol.                                                                                          |
| <b>Shared Key</b> | Enter the shared key between the RADIUS server and the switch. The RADIUS server and the switch use the key string to encrypt passwords and exchange responses. |
| <b>Auth Port</b>  | Specify the UDP destination port on the RADIUS server for authentication requests. The default setting is 1812.                                                 |
| <b>Acct Port</b>  | Specify the UDP destination port on the RADIUS server for accounting requests. The default setting is 1813.                                                     |
| <b>Retransmit</b> | Specify the number of times a request is resent to the server if the server does not respond. The default setting is 2.                                         |
| <b>Timeout</b>    | Specify the time interval that the switch waits for the server to reply before resending. The default setting is 5 seconds.                                     |

■ **Configuring the RADIUS Server Group**

You can configure the radius servers for authentication and accounting. If multiple radius servers are available, you are suggested to add them to different server groups respectively for authentication and accounting.

Choose the menu **Network Security > AAA > Server Group** to load the following page.

Figure 6-3 Adding a Server Group

**Add New Server Group**

Server Group:

Server Type: RADIUS ▼

---

**Aaa Application List**

| Select                   | Server Group | Server Type | Operation            |
|--------------------------|--------------|-------------|----------------------|
| <input type="checkbox"/> |              |             |                      |
| <input type="checkbox"/> | radius       | RADIUS      | <a href="#">edit</a> |
| <input type="checkbox"/> | Group1       | RADIUS      | <a href="#">edit</a> |
| <input type="checkbox"/> | RADIUS1      | RADIUS      | <a href="#">edit</a> |
| <input type="checkbox"/> | tacacs       | TACACS+     | <a href="#">edit</a> |

Follow these steps to create a protocol template:

- 1) In the **Add New Server Group** section, specify the name and server type for the new server group, and click **Add**.

---

**Server Group:** Specify the name of the new server group.

---

**Server Type:** Select the type of the server group as RADIUS.

---

- 2) Select the newly added group, and click **edit** in the **Operation** column.

Figure 6-4 Edit the Group

**Aaa Application List**

| Select                              | Server Group | Server Type | Operation            |
|-------------------------------------|--------------|-------------|----------------------|
| <input type="checkbox"/>            |              |             |                      |
| <input type="checkbox"/>            | radius       | RADIUS      | <a href="#">edit</a> |
| <input type="checkbox"/>            | Group1       | RADIUS      | <a href="#">edit</a> |
| <input type="checkbox"/>            | RADIUS1      | RADIUS      | <a href="#">edit</a> |
| <input checked="" type="checkbox"/> | radius1      | RADIUS      | <a href="#">edit</a> |
| <input type="checkbox"/>            | tacacs       | TACACS+     | <a href="#">edit</a> |

- 3) Select the server to be added to the group from the **Server IP** drop-down list . Then click **Add** to add this server to the server group.

Figure 6-5 Add Server to Group

**Add Server IP**

Server Group:

Server Type:

Server IP:

---

**Server List**

| Select                   | Server Ip |
|--------------------------|-----------|
| <input type="checkbox"/> |           |
| No entry in the table.   |           |

- **Configuring the Dot1x List**

Choose the menu **Network Security > AAA > Dot1x List** to load the following page.

Figure 6-6 Configuring the Dot1x List

**Authentication Dot1x Method List**

| Select                   | List    | Pri1                          |
|--------------------------|---------|-------------------------------|
| <input type="checkbox"/> |         | <input type="text" value=""/> |
| <input type="checkbox"/> | default | radius                        |

---

**Accounting Dot1x Method List**

| Select                   | List    | Pri1                          |
|--------------------------|---------|-------------------------------|
| <input type="checkbox"/> |         | <input type="text" value=""/> |
| <input type="checkbox"/> | default | radius                        |

Follow these steps to configure RADIUS server groups for 802.1X authentication and accounting:

- 1) In the **Authentication Dot1x Method List** section, select an existing RADIUS server group for authentication from the Pri1 drop-down list and click **Apply**.
- 2) In the **Accounting Dot1x Method List** section, select an existing RADIUS server group for accounting from the Pri1 drop-down list and click **Apply**.

## 6.1.2 Configuring 802.1X Globally

Choose the menu **Network Security > 802.1X > Global Config** to load the following page.

Figure 6-7 Global Config

**Global Config**

802.1X:  Enable  Disable

Auth Method:  ▼

Handshake:  Enable  Disable

Guest VLAN:  Enable  Disable

Guest VLAN ID:  (2-4094)

Accounting:  Enable  Disable

---

**Authentication Config**

Quiet:  Enable  Disable

Quiet Period:  sec (1-999)

Retry Times:  (1-9)

Supplicant Timeout:  sec (1-9)

Follow these steps to configure 802.1X global parameters:

- 1) In the **Global Config** section, enable 802.1X globally and click **Apply**.

### Auth Method

Select the 802.1X authentication method.

**PAP:** The 802.1X authentication system uses EAP packets to exchange information between the switch and the client. The transmission of EAP (Extensible Authentication Protocol) packets is terminated at the switch and the EAP packets are converted to other protocol (such as RADIUS) packets, and transmitted to the authentication server.

**EAP:** The 802.1X authentication system uses EAP packets to exchange information between the switch and the client. The EAP packets with authentication data are encapsulated in the advanced protocol (such as RADIUS) packets, and transmitted to the authentication server.

### Handshake

Enable or disable the Handshake feature. The Handshake feature is used to detect the connection status between the TP-Link 802.1X Client and the switch. Please disable Handshake feature if you are using other client softwares instead of TP-Link 802.1X Client.

---

|                      |                                                                                                                                                                                                                                                                                                                |
|----------------------|----------------------------------------------------------------------------------------------------------------------------------------------------------------------------------------------------------------------------------------------------------------------------------------------------------------|
| <b>Guest VLAN</b>    | Select whether to enable Guest VLAN. By default, it is disabled.<br><br>If the Guest VLAN is enabled, a port can access resources in the guest VLAN even though the port is not yet authenticated; if guest VLAN is disabled and the port is not authenticated, the port cannot visit any resource in the LAN. |
| <b>Guest VLAN ID</b> | Enter the guest VLAN's ID. It must be an existing VLAN with the ID ranging from 2 to 4094.                                                                                                                                                                                                                     |
| <b>Accounting</b>    | Enable or disable 802.1X accounting function.                                                                                                                                                                                                                                                                  |

---

- 2) In the **Authentication Config** section, enable Quiet, configure the Quiet timer, and click **Apply**.

---

|                           |                                                                                                                                                                                                                                                                         |
|---------------------------|-------------------------------------------------------------------------------------------------------------------------------------------------------------------------------------------------------------------------------------------------------------------------|
| <b>Quiet</b>              | Enable or disable the Quiet timer.                                                                                                                                                                                                                                      |
| <b>Quiet Period</b>       | Specify the Quiet Period. It ranges from 1 to 999 seconds and the default time is 10 seconds.<br><br>The quiet period starts after the authentication fails. During the quiet period, the switch does not process authentication requests from the same client.         |
| <b>Retry Times</b>        | Specify the maximum number of attempts to send the authentication packet. It ranges from 1 to 9 times and the default is 3 times.                                                                                                                                       |
| <b>Supplicant Timeout</b> | Specify the maximum time which the switch waits for a response from the client. It ranges from 1 to 9 seconds and the default time is 3 seconds.<br><br>If the switch does not receive any reply from the client within the specified time, it will resend the request. |

---



### 6.1.3 Configuring 802.1X on Ports

Choose the menu **Network Security > 802.1X > Port Config** to load the following page.

Figure 6-8 Port Config

| Port Config              |        |                                      |                                      |                                   |                                        |            |     |
|--------------------------|--------|--------------------------------------|--------------------------------------|-----------------------------------|----------------------------------------|------------|-----|
| UNIT: 1                  |        |                                      |                                      |                                   |                                        |            |     |
| Select                   | Port   | Status                               | Guest VLAN                           | Control Mode                      | Control Type                           | Authorized | LAG |
| <input type="checkbox"/> |        | <input type="text" value="Disable"/> | <input type="text" value="Disable"/> | <input type="text" value="Auto"/> | <input type="text" value="MAC Based"/> |            |     |
| <input type="checkbox"/> | 1/0/1  | Disable                              | Disable                              | Auto                              | MAC Based                              | Authorized | --- |
| <input type="checkbox"/> | 1/0/2  | Disable                              | Disable                              | Auto                              | MAC Based                              | Authorized | --- |
| <input type="checkbox"/> | 1/0/3  | Disable                              | Disable                              | Auto                              | MAC Based                              | Authorized | --- |
| <input type="checkbox"/> | 1/0/4  | Disable                              | Disable                              | Auto                              | MAC Based                              | Authorized | --- |
| <input type="checkbox"/> | 1/0/5  | Disable                              | Disable                              | Auto                              | MAC Based                              | Authorized | --- |
| <input type="checkbox"/> | 1/0/6  | Disable                              | Disable                              | Auto                              | MAC Based                              | Authorized | --- |
| <input type="checkbox"/> | 1/0/7  | Disable                              | Disable                              | Auto                              | MAC Based                              | Authorized | --- |
| <input type="checkbox"/> | 1/0/8  | Disable                              | Disable                              | Auto                              | MAC Based                              | Authorized | --- |
| <input type="checkbox"/> | 1/0/9  | Disable                              | Disable                              | Auto                              | MAC Based                              | Authorized | --- |
| <input type="checkbox"/> | 1/0/10 | Disable                              | Disable                              | Auto                              | MAC Based                              | Authorized | --- |
| <input type="checkbox"/> | 1/0/11 | Disable                              | Disable                              | Auto                              | MAC Based                              | Authorized | --- |
| <input type="checkbox"/> | 1/0/12 | Disable                              | Disable                              | Auto                              | MAC Based                              | Authorized | --- |
| <input type="checkbox"/> | 1/0/13 | Disable                              | Disable                              | Auto                              | MAC Based                              | Authorized | --- |
| <input type="checkbox"/> | 1/0/14 | Disable                              | Disable                              | Auto                              | MAC Based                              | Authorized | --- |
| <input type="checkbox"/> | 1/0/15 | Disable                              | Disable                              | Auto                              | MAC Based                              | Authorized | --- |

Configure 802.1X authentication on the desired port and click **Apply** .

|                     |                                                                                                                                                                                                                                                                                                                                                                                                            |
|---------------------|------------------------------------------------------------------------------------------------------------------------------------------------------------------------------------------------------------------------------------------------------------------------------------------------------------------------------------------------------------------------------------------------------------|
| <b>Status</b>       | Enable 802.1X authentication on the port.                                                                                                                                                                                                                                                                                                                                                                  |
| <b>Guest VLAN</b>   | Select whether to enable Guest VLAN on the port.                                                                                                                                                                                                                                                                                                                                                           |
| <b>Control Mode</b> | <p>Select the Control Mode for the port. By default, it is Auto.</p> <p><b>Auto:</b> If this option is selected, the port can access the network only when it is authenticated.</p> <p><b>Force-Authorized:</b> If this option is selected, the port can access the network without authentication.</p> <p><b>Force-Unauthorized:</b> If this option is selected, the port can never be authenticated.</p> |
| <b>Control Type</b> | <p>Select the Control Type for the port. By default, it is MAC Based.</p> <p><b>MAC Based:</b> All clients connected to the port need to be authenticated.</p> <p><b>Port Based:</b> If a client connected to the port is authenticated, other clients can access the LAN without authentication.</p>                                                                                                      |
| <b>Authorized</b>   | Displays whether the port is authorized or not.                                                                                                                                                                                                                                                                                                                                                            |
| <b>LAG</b>          | Displays the LAG the port belongs to.                                                                                                                                                                                                                                                                                                                                                                      |

---

 **Note:**

If a port is in an LAG, its 802.1X authentication function cannot be enabled. Also, a port with 802.1X authentication enabled cannot be added to any LAG.

---

## 6.2 Using the CLI

### 6.2.1 Configuring the RADIUS Server

Follow these steps to configure RADIUS:

|        |                                                                                                                                                                                                                                                                                                                                                                                                                                                                                                                                                                                                                                                                                                                                                                                                                                                                                                                                                                                                                                                                                                                                                                                                                                                                                                                                                                                                                                                                                                                                                                                                                                                                                                                                                                                                                                                                                                            |
|--------|------------------------------------------------------------------------------------------------------------------------------------------------------------------------------------------------------------------------------------------------------------------------------------------------------------------------------------------------------------------------------------------------------------------------------------------------------------------------------------------------------------------------------------------------------------------------------------------------------------------------------------------------------------------------------------------------------------------------------------------------------------------------------------------------------------------------------------------------------------------------------------------------------------------------------------------------------------------------------------------------------------------------------------------------------------------------------------------------------------------------------------------------------------------------------------------------------------------------------------------------------------------------------------------------------------------------------------------------------------------------------------------------------------------------------------------------------------------------------------------------------------------------------------------------------------------------------------------------------------------------------------------------------------------------------------------------------------------------------------------------------------------------------------------------------------------------------------------------------------------------------------------------------------|
| Step 1 | <p><b>configure</b></p> <p>Enter global configuration mode.</p>                                                                                                                                                                                                                                                                                                                                                                                                                                                                                                                                                                                                                                                                                                                                                                                                                                                                                                                                                                                                                                                                                                                                                                                                                                                                                                                                                                                                                                                                                                                                                                                                                                                                                                                                                                                                                                            |
| Step 2 | <p><b>aaa enable</b></p> <p>Enable the AAA function globally.</p>                                                                                                                                                                                                                                                                                                                                                                                                                                                                                                                                                                                                                                                                                                                                                                                                                                                                                                                                                                                                                                                                                                                                                                                                                                                                                                                                                                                                                                                                                                                                                                                                                                                                                                                                                                                                                                          |
| Step 3 | <p><b>radius-server host</b> <i>ip-address</i> [<b>auth-port</b> <i>port-id</i>] [<b>acct-port</b> <i>port-id</i>] [<b>timeout</b> <i>time</i>] [<b>retransmit</b> <i>number</i>] [<b>key</b> {[ 0 ] <i>string</i>   7 <i>encrypted-string</i> }]</p> <p>Add the RADIUS server and configure the related parameters as needed.</p> <p><b>host</b> <i>ip-address</i>: Enter the IP address of the server running the RADIUS protocol.</p> <p><b>auth-port</b> <i>port-id</i>: Specify the UDP destination port on the RADIUS server for authentication requests. The default setting is 1812.</p> <p><b>acct-port</b> <i>port-id</i>: Specify the UDP destination port on the RADIUS server for accounting requests. The default setting is 1813. Generally, the accounting feature is not used in the authentication account management.</p> <p><b>timeout</b> <i>time</i>: Specify the time interval that the switch waits for the server to reply before resending. The valid values are from 1 to 9 seconds and the default setting is 5 seconds.</p> <p><b>retransmit</b> <i>number</i>: Specify the number of times a request is resent to the server if the server does not respond. The valid values are from 1 to 3 and the default setting is 2.</p> <p><b>key</b> {[ 0 ] <i>string</i>   7 <i>encrypted-string</i> }: Specify the shared key. 0 and 7 prevent the encryption type. 0 indicates that an unencrypted key will follow. 7 indicates that a symmetric encrypted key with a fixed length will follow. By default, the encryption type is 0. <i>string</i> is the shared key for the switch and the server, which contains 31 characters at most. <i>encrypted-string</i> is a symmetric encrypted key with a fixed length, which you can copy from the configuration file of another switch. The key or encrypted-key you configured here will be displayed in the encrypted form.</p> |
| Step 4 | <p><b>aaa group radius</b> <i>group-name</i></p> <p>Create a radius server group.</p> <p><b>radius</b>: Specify the group type as radius.</p> <p><b>group-name</b>: Specify a name for the group.</p>                                                                                                                                                                                                                                                                                                                                                                                                                                                                                                                                                                                                                                                                                                                                                                                                                                                                                                                                                                                                                                                                                                                                                                                                                                                                                                                                                                                                                                                                                                                                                                                                                                                                                                      |

---

---

|         |                                                                                                                                                                                                                                                                                                                                                                                                                                                                                                                        |
|---------|------------------------------------------------------------------------------------------------------------------------------------------------------------------------------------------------------------------------------------------------------------------------------------------------------------------------------------------------------------------------------------------------------------------------------------------------------------------------------------------------------------------------|
| Step 5  | <b>server ip-address</b><br>Add the existing servers to the server group.<br><i>ip-address</i> : Specify IP address of the server to be added to the group.                                                                                                                                                                                                                                                                                                                                                            |
| Step 6  | <b>exit</b><br>Return to global configuration mode.                                                                                                                                                                                                                                                                                                                                                                                                                                                                    |
| Step 7  | <b>aaa authentication dot1x default { method }</b><br>Select the radius group for 802.1X authentication.<br><i>method</i> : Specify the radius group for 802.1X authentication.<br><b>aaa accounting dot1x default { method }</b><br>Select the radius group for 802.1X accounting.<br><i>method</i> : Specify the radius group for 802.1X accounting.<br><br>Note: If multiple radius servers are available, you are suggested to add them to different server groups respectively for authentication and accounting. |
| Step 8  | <b>show aaa global</b><br>(Optional) Verify the global configuration of AAA.                                                                                                                                                                                                                                                                                                                                                                                                                                           |
| Step 9  | <b>show radius-server</b><br>(Optional) Verify the configuration of RADIUS server.                                                                                                                                                                                                                                                                                                                                                                                                                                     |
| Step 10 | <b>show aaa group [ group-name ]</b><br>(Optional) Verify the configuration of server group.                                                                                                                                                                                                                                                                                                                                                                                                                           |
| Step 11 | <b>show aaa authentication dot1x</b><br>(Optional) Verify the authentication method list.                                                                                                                                                                                                                                                                                                                                                                                                                              |
| Step 12 | <b>show aaa accounting dot1x</b><br>(Optional) Verify the accounting method list.                                                                                                                                                                                                                                                                                                                                                                                                                                      |
| Step 13 | <b>end</b><br>Return to privileged EXEC mode.                                                                                                                                                                                                                                                                                                                                                                                                                                                                          |
| Step 14 | <b>copy running-config startup-config</b><br>Save the settings in the configuration file.                                                                                                                                                                                                                                                                                                                                                                                                                              |

---

The following example shows how to enable AAA, add a RADIUS server to the server group named radius1, and apply this server group to the 802.1X authentication. The IP address of the RADIUS server is 192.168.0.100; the shared key is 123456; the authentication port is 1812; the accounting port is 1813.

```
Switch#configure
```

```
Switch#aaa enable
```

```
Switch(config)#radius-server host 192.168.0.100 key 123456 auth-port 1812 acct-port 1813
```

```
Switch(config)#aaa group radius radius1
```

```
Switch(aaa-group)#server 192.168.0.100
```

```
Switch(aaa-group)#exit
```

```
Switch(config)#aaa authentication dot1x default radius1
```

```
Switch(config)#aaa accounting dot1x default radius1
```

```
Switch(config)#show radius-server
```

| Server Ip     | Auth Port | Acct Port | Timeout | Retransmit | Shared key |
|---------------|-----------|-----------|---------|------------|------------|
| 192.168.0.100 | 1812      | 1813      | 5       | 2          | 123456     |

```
Switch(config)#show aaa group radius1
```

```
192.168.0.100
```

```
Switch(config)#show aaa authentication dot1x
```

| Methodlist | pri1    | pri2 | pri3 | pri4 |
|------------|---------|------|------|------|
| default    | radius1 | --   | --   | --   |

```
Switch(config)#show aaa accounting dot1x
```

| Methodlist | pri1    | pri2 | pri3 | pri4 |
|------------|---------|------|------|------|
| default    | radius1 | --   | --   | --   |

```
Switch(config)#show aaa global
```

```
AAA global status: Enable
```

```
Switch(config)#end
```

```
Switch#copy running-config startup-config
```

## 6.2.2 Configuring 802.1X Globally

Follow these steps to configure 802.1X globally:

- |        |                                                                            |
|--------|----------------------------------------------------------------------------|
| Step 1 | <b>configure</b><br>Enter global configuration mode.                       |
| Step 2 | <b>dot1x system-auth-control</b><br>Enable 802.1X authentication globally. |

---

|        |                                                                                                                                                                                                                                                                                                                                                                                                                                                                                                                                                                                                                                                                                                                                                                                                                                                                                           |
|--------|-------------------------------------------------------------------------------------------------------------------------------------------------------------------------------------------------------------------------------------------------------------------------------------------------------------------------------------------------------------------------------------------------------------------------------------------------------------------------------------------------------------------------------------------------------------------------------------------------------------------------------------------------------------------------------------------------------------------------------------------------------------------------------------------------------------------------------------------------------------------------------------------|
| Step 3 | <b>dot1x auth-method { pap   eap }</b><br>Configure the 802.1X authentication method.<br><br><b>pap:</b> Specify the authentication method as PAP. If this option is selected, the 802.1X authentication system uses EAP (Extensible Authentication Protocol) packets to exchange information between the switch and the client. The transmission of EAP packets is terminated at the switch and the EAP packets are converted to other protocol (such as RADIUS) packets, and transmitted to the authentication server.<br><br><b>eap:</b> Specify the authentication method as EAP. If this option is selected, the 802.1X authentication system uses EAP packets to exchange information between the switch and the client. The EAP packets with authentication data are encapsulated in the advanced protocol (such as RADIUS) packets, and transmitted to the authentication server. |
| Step 4 | <b>dot1x guest-vlan vid</b><br>(Optional) Enable guest VLAN globally.<br><br><b>vid:</b> Specify the ID of the VLAN to be configured as the guest VLAN. It must be an existing VLAN with the ID ranging from 2 to 4094. Clients in the guest VLAN can only access resources from specific VLANs.                                                                                                                                                                                                                                                                                                                                                                                                                                                                                                                                                                                          |
| Step 5 | <b>dot1x quiet-period [time]</b><br>(Optional) Enable the quiet feature for 802.1X authentication and configure the quiet period.<br><br><b>time:</b> Set a value between 1 and 999 seconds for the quiet period. It is 10 seconds by default. The quiet period starts after the authentication fails. During the quiet period, the switch does not process authentication requests from the same client.                                                                                                                                                                                                                                                                                                                                                                                                                                                                                 |
| Step 6 | <b>dot1x timeout supplicant-timeout time</b><br>Configure the supplicant timeout period.<br><br><b>time:</b> Specify the maximum time for which the switch waits for response from the client. It ranges from 1 to 9 seconds and the default time is 3 seconds. If the switch does not receive any reply from the client within the specified time, it will resend the request.                                                                                                                                                                                                                                                                                                                                                                                                                                                                                                           |
| Step 7 | <b>dot1x max-reauth-req times</b><br>Specify the maximum number of attempts to send the authentication packet for the client.<br><br><b>times:</b> The maximum attempts for the client to send the authentication packet. It ranges from 1 to 9 and the default is 3.                                                                                                                                                                                                                                                                                                                                                                                                                                                                                                                                                                                                                     |
| Step 8 | <b>show dot1x global</b><br>(Optional) Verify global configurations of 802.1X.                                                                                                                                                                                                                                                                                                                                                                                                                                                                                                                                                                                                                                                                                                                                                                                                            |
| Step 9 | <b>end</b><br>Return to privileged EXEC mode.                                                                                                                                                                                                                                                                                                                                                                                                                                                                                                                                                                                                                                                                                                                                                                                                                                             |

---

---

Step 10      **copy running-config startup-config**  
Save the settings in the configuration file.

---

The following example shows how to enable 802.1X authentication, configure PAP as the authentication method and keep other parameters as default:

**Switch#configure**

**Switch(config)#dot1x system-auth-control**

**Switch(config)#dot1x auth-method pap**

**Switch(config)#show dot1x global**

```
802.1X State:          Enabled
Authentication Method:  PAP
Handshake State:       Enabled
Guest VLAN State:      Disable
Guest VLAN ID:         N/A
802.1X Accounting State:  Disable
Quiet-period State:    Disable
Quiet-period Timer:    10 sec.
Max Retry-times For RADIUS Packet: 3
Supplicant Timeout:    3 sec.
```

**Switch(config)#end**

**Switch#copy running-config startup-config**

### 6.2.3 Configuring 802.1X on Ports

Follow these steps to configure the port:

---

Step 1      **configure**  
Enter global configuration mode.

---

Step 2      **interface {fastEthernet *port* | range fastEthernet *port-list* | gigabitEthernet *port* | range gigabitEthernet *port-list* | ten-gigabitEthernet *port* | range ten-gigabitEthernet *port-list* }**  
Enter interface configuration mode.  
*port*: Enter the ID of the port to be configured.

---

---

|        |                                                                                                                                                                                                                                                                                                                                                                                                                                                                                      |
|--------|--------------------------------------------------------------------------------------------------------------------------------------------------------------------------------------------------------------------------------------------------------------------------------------------------------------------------------------------------------------------------------------------------------------------------------------------------------------------------------------|
| Step 3 | <b>dot1x</b><br>Enable 802.1X authentication for the port.                                                                                                                                                                                                                                                                                                                                                                                                                           |
| Step 4 | <b>dot1x port-method { mac-based   port-based }</b><br>Configure the control type for the port. By default, it is mac-based.<br><br><b>mac-based:</b> All clients connected to the port need to be authenticated.<br><br><b>port-based:</b> If a client connected to the port is authenticated, other clients can access the LAN without authentication.                                                                                                                             |
| Step 5 | <b>dot1x guest-vlan</b><br>(Optional) Enable guest VLAN on the port.<br><br>Note: Before enabling guest VLAN, the control type of the port should be configured as port-based.                                                                                                                                                                                                                                                                                                       |
| Step 6 | <b>dot1x port-control { auto   authorized-force   unauthorized-force }</b><br>Configure the control mode for the port. By default, it is auto.<br><br><b>auto:</b> If this option is selected, the port can access the network only when it is authenticated.<br><br><b>authorized-force:</b> If this option is selected, the port can access the network without authentication.<br><br><b>unauthorized-force:</b> If this option is selected, the port can never be authenticated. |
| Step 7 | <b>show dot1x interface [fastEthernet <i>port</i>   gigabitEthernet <i>port</i>   ten-gigabitEthernet <i>port</i>]</b><br>(Optional) Verify the configurations of 802.1X authentication on the port.<br><br><b>port:</b> Enter the ID of the port to be configured. If no specific port is entered, the switch will show configurations of all ports.                                                                                                                                |
| Step 8 | <b>end</b><br>Return to privileged EXEC mode.                                                                                                                                                                                                                                                                                                                                                                                                                                        |
| Step 9 | <b>copy running-config startup-config</b><br>Save the settings in the configuration file.                                                                                                                                                                                                                                                                                                                                                                                            |

---

The following example shows how to enable 802.1X authentication on port 1/0/2, configure the control type as port-based, and configure the control mode as auto:

```
Switch#configure
```

```
Switch(config)#interface ten-gigabitEthernet 1/0/2
```

```
Switch(config-if)#dot1x
```

```
Switch(config-if)#dot1x port-method port-based
```

```
Switch(config-if)#dot1x port-control auto
```

```
Switch(config-if)#show dot1x interface ten-gigabitEthernet 1/0/2
```

| Port    | State   | GuestVLAN | PortControl | PortMethod | Authorized   | LAG |
|---------|---------|-----------|-------------|------------|--------------|-----|
| ----    | -----   | -----     | -----       | -----      | -----        | --- |
| Te1/0/2 | enabled | disabled  | auto        | port-based | unauthorized | N/A |

```
Switch(config-if)#end
```

```
Switch#copy running-config startup-config
```



# 7 AAA Configuration

In the AAA feature, the authentication can be processed locally on the switch or centrally on the RADIUS/TACACS+ server(s). To ensure the stability of the authentication system, you can configure multiple servers and authentication methods at the same time. This chapter introduces how to configure this kind of comprehensive authentication in AAA.

To complete the configuration, follow these steps:

- 1) Globally enable AAA.
- 2) Add the servers.
- 3) Configure the server groups.
- 4) Configure the method list.
- 5) Configure the AAA application list.
- 6) Configure the login account and the Enable password.

## Configuration Guidelines

The basic concepts and working mechanism of AAA are as follows:

### ■ Server Group

Multiple servers running the same protocol can be added to a server group, and the servers in the group will authenticate the users in the order they are added. The server that is first added to the group has the highest priority, and is responsible for authentication under normal circumstances. If the first one breaks down or doesn't respond to the authentication request for some reason, the second sever will start working for authentication, and so on.

### ■ Method List

A server group is regarded as a method, and the local authentication is another method. Several methods can be configured to form a method list. The switch uses the first method in the method list to authenticate the user, and if that method fails to respond, the switch selects the next method. This process continues until the user has a successful communication with a method or until all defined methods are exhausted. If the authentication succeeds or the secure server or the local switch denies the user's access, the authentication process stops and no other methods are attempted.

Two types of method list are provided: Login method list for users of all types to access the switch, and Enable method list for guests to get administrative privileges.

### ■ AAA Application List

The switch supports the following access applications: Telnet, SSH and HTTP. You can select the configured authentication method lists for each application.

## 7.1 Using the GUI

### 7.1.1 Globally Enabling AAA

Choose the menu **Network Security > AAA > Global Conifg** to load the following page.

Figure 7-1 Global Configuration

**Global Config**

AAA:  Enable  Disable Apply

Follow these steps to globally enable AAA:

- 1) In the **Global Config** section, enable AAA.
- 2) Click **Apply**.

### 7.1.2 Adding Servers

You can add one or more RADIUS/TACACS+ servers on the switch for authentication. If multiple servers are added, the server that is first added to the group has the highest priority and authenticates the users trying to access the switch. The others act as backup servers in case the first one breaks down.

- **Adding RADIUS Server**

Choose the menu **Network Security > AAA > RADIUS Conifg** to load the following page.

Figure 7-2 RADIUS Server Configuration

**Server Config**

Server IP:  (Format:192.168.0.1)

Shared Key:

Auth Port:  (1-65535)

Acct Port:  (1-65535) Add

Retransmit:  (1-3)

Timeout:  sec(1-9)

**Server List**

| Select                   | Server IP | Shared Key           | Auth Port            | Acct Port            | Retransmit           | Timeout              |
|--------------------------|-----------|----------------------|----------------------|----------------------|----------------------|----------------------|
| <input type="checkbox"/> |           | <input type="text"/> | <input type="text"/> | <input type="text"/> | <input type="text"/> | <input type="text"/> |

No entry in the table.

All
Apply
Delete
Help

Follow these steps to add a RADIUS server:

- 1) In the **Server Config** section, configure the following parameters.

|            |                                                                                                                                                                 |
|------------|-----------------------------------------------------------------------------------------------------------------------------------------------------------------|
| Server IP  | Enter the IP address of the server running the RADIUS secure protocol.                                                                                          |
| Shared Key | Enter the shared key between the RADIUS server and the switch. The RADIUS server and the switch use the key string to encrypt passwords and exchange responses. |
| Auth Port  | Specify the UDP destination port on the RADIUS server for authentication requests. The default setting is 1812.                                                 |
| Acct Port  | Specify the UDP destination port on the RADIUS server for accounting requests. The default setting is 1813. Usually, it is used in the 802.1X feature.          |
| Retransmit | Specify the number of times a request is resent to the server if the server does not respond. The default setting is 2.                                         |
| Timeout    | Specify the time interval that the switch waits for the server to reply before resending. The default setting is 5 seconds.                                     |

2) Click **Add** to add the RADIUS server on the switch.

■ Adding TACACS+ Server

Choose the menu **Network Security > AAA > TACACS+ Config** to load the following page.

Figure 7-3 TACACS+ Server Configuration

**Server Config**

Server IP:  (Format: 192.168.0.1)

Timeout:  sec(1-9)

Shared Key:

Server Port:  (1-65535)

**Server List**

| Select                   | Server IP | Timeout              | Shared Key           | Port                 |
|--------------------------|-----------|----------------------|----------------------|----------------------|
| <input type="checkbox"/> |           | <input type="text"/> | <input type="text"/> | <input type="text"/> |
| No entry in the table.   |           |                      |                      |                      |

Follow these steps to add a TACACS+ server:

1) In the **Server Config** section, configure the following parameters.

|             |                                                                                                                                                                   |
|-------------|-------------------------------------------------------------------------------------------------------------------------------------------------------------------|
| Server IP   | Enter the IP address of the server running the TACACS+ secure protocol.                                                                                           |
| Timeout     | Specify the time interval that the switch waits for the server to reply before resending. The default setting is 5 seconds.                                       |
| Shared Key  | Enter the shared key between the TACACS+ server and the switch. The TACACS+ server and the switch use the key string to encrypt passwords and exchange responses. |
| Server Port | Specify the TCP port used on the TACACS+ server for AAA. The default setting is 49.                                                                               |

- 2) Click **Add** to add the TACACS+ server on the switch.

### 7.1.3 Configuring Server Groups

The switch has two built-in server groups, one for RADIUS servers and the other for TACACS+ servers. The servers running the same protocol are automatically added to the default server group. You can add new server groups as needed.

Choose the menu **Network Security > AAA > Server Group** to load the following page.

Figure 7-4 Add New Server Group

**Add New Server Group**

Server Group:

Server Type: RADIUS ▼

Add

| Aaa Application List     |              |             |                      |
|--------------------------|--------------|-------------|----------------------|
| Select                   | Server Group | Server Type | Operation            |
| <input type="checkbox"/> |              |             |                      |
| <input type="checkbox"/> | radius       | RADIUS      | <a href="#">edit</a> |
| <input type="checkbox"/> | Auth         | RADIUS      | <a href="#">edit</a> |
| <input type="checkbox"/> | tacacs       | TACACS+     | <a href="#">edit</a> |

All
Delete
Help

The two default server groups in the list cannot be edited or deleted. You can follow these steps to configure a new server group:

- 1) In the **Add New Server Group** section, configure the group name and the server type, and click **Add** to add the new server group.

|                     |                                                                                     |
|---------------------|-------------------------------------------------------------------------------------|
| <b>Server Group</b> | Specify a name for the server group.                                                |
| <b>Server Type</b>  | Select the server type for the group. Two options are provided: RADIUS and TACACS+. |

- 2) Select the newly added group, and click **edit** in the **Operation** column.

Figure 7-5 Edit the Group

| Aaa Application List                |              |             |                      |
|-------------------------------------|--------------|-------------|----------------------|
| Select                              | Server Group | Server Type | Operation            |
| <input type="checkbox"/>            |              |             |                      |
| <input type="checkbox"/>            | radius       | RADIUS      | <a href="#">edit</a> |
| <input type="checkbox"/>            | Auth         | RADIUS      | <a href="#">edit</a> |
| <input checked="" type="checkbox"/> | Group1       | RADIUS      | <a href="#">edit</a> |
| <input type="checkbox"/>            | tacacs       | TACACS+     | <a href="#">edit</a> |

All
Delete
Help

- 3) Select the server to be added to the group from the **Server IP** drop-down list . Then click **Add** to add this server to the server group.

Figure 7-6 Add Server to Group

**Add Server IP**

Server Group:

Server Type:

Server IP:

---

**Server List**

| Select                   | Server Ip |
|--------------------------|-----------|
| <input type="checkbox"/> |           |
| No entry in the table.   |           |

### 7.1.4 Configuring the Method List

A method list describes the authentication methods and their sequence to authenticate the users. The switch supports Login Method List for users of all types to gain access to the switch, and Enable Method List for guests to get administrative privileges.

Choose the menu **Network Security > AAA > Method List** to load the following page.

Figure 7-7 Add New Method

**Add Method List**

Method List Name:

List Type:

Pri1:

Pri2:

Pri3:

Pri4:

---

**Authentication Login Method List**

| Select                   | List    | Pri1                            | Pri2                            | Pri3                            | Pri4                            |
|--------------------------|---------|---------------------------------|---------------------------------|---------------------------------|---------------------------------|
| <input type="checkbox"/> |         | <input type="text" value="--"/> | <input type="text" value="--"/> | <input type="text" value="--"/> | <input type="text" value="--"/> |
| <input type="checkbox"/> | default | local                           | --                              | --                              | --                              |

---

**Authentication Enable Method List**

| Select                   | List    | Pri1                            | Pri2                            | Pri3                            | Pri4                            |
|--------------------------|---------|---------------------------------|---------------------------------|---------------------------------|---------------------------------|
| <input type="checkbox"/> |         | <input type="text" value="--"/> | <input type="text" value="--"/> | <input type="text" value="--"/> | <input type="text" value="--"/> |
| <input type="checkbox"/> | default | none                            | --                              | --                              | --                              |

There are two default methods respectively for the Login authentication and the Enable authentication.

You can edit the default methods or follow these steps to add a new method:

- 1) In the **Add Method List** section, configure the parameters for the method to be added.

|                         |                                                                                                                                                                                                                                                                                                                                                                                                                                                                                                                                                                                                            |
|-------------------------|------------------------------------------------------------------------------------------------------------------------------------------------------------------------------------------------------------------------------------------------------------------------------------------------------------------------------------------------------------------------------------------------------------------------------------------------------------------------------------------------------------------------------------------------------------------------------------------------------------|
| <b>Method List Name</b> | Specify a name for the method.                                                                                                                                                                                                                                                                                                                                                                                                                                                                                                                                                                             |
| <b>List Type</b>        | Select the authentication type. Two options are provided: Authentication Login and Authentication Enable.                                                                                                                                                                                                                                                                                                                                                                                                                                                                                                  |
| <b>Pri1- Pri4</b>       | Specify the authentication methods in order. The method with priority 1 authenticates a user first, the method with priority 2 is tried if the previous method does not respond, and so on.<br><br><b>local:</b> Use the local database in the switch for authentication.<br><br><b>none:</b> No authentication is used.<br><br><b>radius:</b> Use the remote RADIUS server/server groups for authentication.<br><br><b>tacacs:</b> Use the remote TACACS+ server/server groups for authentication.<br><br><b>Other user-defined server groups:</b> Use the user-defined server groups for authentication. |

- 2) Click **Add** to add the new method.

### 7.1.5 Configuring the AAA Application List

Choose the menu **Network Security > AAA > Global Config** to load the following page.

Figure 7-8 Configure Application List

| Aaa Application List     |        |            |             |
|--------------------------|--------|------------|-------------|
| Select                   | Module | Login List | Enable list |
| <input type="checkbox"/> |        | default ▾  | default ▾   |
| <input type="checkbox"/> | telnet | default    | default     |
| <input type="checkbox"/> | ssh    | default    | default     |
| <input type="checkbox"/> | http   | default    | default     |

Follow these steps to configure the AAA application list.

- 1) In the **AAA Application List** section, select an access application and configure the Login list and Enable list.

|                    |                                                                                                                                          |
|--------------------|------------------------------------------------------------------------------------------------------------------------------------------|
| <b>Module</b>      | Displays the configurable applications on the switch: telnet, ssh and http.                                                              |
| <b>Login List</b>  | Select a previously configured Login method list. This method list will authenticate the users trying to log in to the switch.           |
| <b>Enable List</b> | Select a previously configured Enable method list. This method list will authenticate the users trying to get administrative privileges. |

- 2) Click **Apply**.

## 7.1.6 Configuring Login Account and Enable Password

The login account and Enable password can be configured locally on the switch or centrally on the RADIUS/TACACS+ server(s).

### ■ On the Switch

The local username and password for login can be configured in the User Management feature. For details, refer to *Managing System*.

To configure the local Enable password for getting administrative privileges, choose the menu **Network Security > AAA > Global Config** to load the following page.

Figure 7-9 Configure Enable Password



The screenshot shows a web interface for configuring the 'Enable Admin' password. At the top, there is a grey header bar with the text 'Enable Admin'. Below this, the label 'Enable Password:' is followed by a text input field. To the right of the input field is a button labeled 'Apply'.

Specify the Enable password in the **Enable Admin** section, and click **Apply**.

*Tips:* The logged-in guests can enter the Enable password on this page to get administrative privileges.

### ■ On the Server

The accounts created by the RADIUS/TACACS+ server can only view the configurations and some network information without the Enable password.

Some configuration principles on the server are as follows:

- For Login authentication configuration, more than one login account can be created on the server. Besides, both the user name and password can be customized.
- For Enable password configuration:

On RADIUS server, the user name should be set as **\$enable\$**, and the Enable password is customizable. All the users trying to get administrative privileges share this Enable password.

On TACACS+ server, the Enable password is set with the login account, and each account has its own Enable password.

*Tips:* The logged-in guests can get administrative privileges by using the command **enable-admin** and providing the Enable password.

## 7.2 Using the CLI

### 7.2.1 Globally Enabling AAA

Follow these steps to globally enable AAA:

---

|        |                                           |                                              |
|--------|-------------------------------------------|----------------------------------------------|
| Step 1 | <b>configure</b>                          | Enter global configuration mode.             |
| Step 2 | <b>aaa enable</b>                         | Globally enable the AAA feature.             |
| Step 3 | <b>show aaa global</b>                    | Verify the global configuration of AAA.      |
| Step 4 | <b>end</b>                                | Return to privileged EXEC mode.              |
| Step 5 | <b>copy running-config startup-config</b> | Save the settings in the configuration file. |

---

The following example shows how to globally enable AAA:

```
Switch#configure
Switch(config)#aaa enable
Switch(config)#show aaa global
AAA global status:      Enable
.....
Switch(config)#end
Switch#copy running-config startup-config
```

### 7.2.2 Adding Servers

You can add one or more RADIUS/TACACS+ servers on the switch for authentication. If multiple servers are added, the server with the highest priority authenticates the users trying to access the switch, and the others act as backup servers in case the first one breaks down.

- **Adding RADIUS Server**

Follow these steps to add RADIUS server on the switch:



|        |                                                                                                                                                                                                                                                                                                                                                                                                                                                                                                                                                                                                                                                                                                                                                                                                                                                                                                                                                                                                                                                                                                                                                                                                                                                                                                                                                                                                                                                                                                                                                                                                                                                                                                                                                                                                                                           |
|--------|-------------------------------------------------------------------------------------------------------------------------------------------------------------------------------------------------------------------------------------------------------------------------------------------------------------------------------------------------------------------------------------------------------------------------------------------------------------------------------------------------------------------------------------------------------------------------------------------------------------------------------------------------------------------------------------------------------------------------------------------------------------------------------------------------------------------------------------------------------------------------------------------------------------------------------------------------------------------------------------------------------------------------------------------------------------------------------------------------------------------------------------------------------------------------------------------------------------------------------------------------------------------------------------------------------------------------------------------------------------------------------------------------------------------------------------------------------------------------------------------------------------------------------------------------------------------------------------------------------------------------------------------------------------------------------------------------------------------------------------------------------------------------------------------------------------------------------------------|
| Step 1 | <b>configure</b><br>Enter global configuration mode.                                                                                                                                                                                                                                                                                                                                                                                                                                                                                                                                                                                                                                                                                                                                                                                                                                                                                                                                                                                                                                                                                                                                                                                                                                                                                                                                                                                                                                                                                                                                                                                                                                                                                                                                                                                      |
| Step 2 | <b>radius-server host <i>ip-address</i> [ <i>auth-port port-id</i> ] [ <i>acct-port port-id</i> ] [ <i>timeout time</i> ] [ <i>retransmit number</i> ] [ <i>key</i> { [ 0 ] <i>string</i>   7 <i>encrypted-string</i> } }</b><br>Add the RADIUS server and configure the related parameters as needed.<br><br><b>host <i>ip-address</i></b> : Enter the IP address of the server running the RADIUS protocol.<br><br><b>auth-port <i>port-id</i></b> : Specify the UDP destination port on the RADIUS server for authentication requests. The default setting is 1812.<br><br><b>acct-port <i>port-id</i></b> : Specify the UDP destination port on the RADIUS server for accounting requests. The default setting is 1813. Usually, it is used in the 802.1X feature.<br><br><b>timeout <i>time</i></b> : Specify the time interval that the switch waits for the server to reply before resending. The valid values are from 1 to 9 seconds and the default setting is 5 seconds.<br><br><b>retransmit <i>number</i></b> : Specify the number of times a request is resent to the server if the server does not respond. The valid values are from 1 to 3 and the default setting is 2.<br><br><b>key { [ 0 ] <i>string</i>   7 <i>encrypted-string</i> }</b> : Specify the shared key. 0 and 7 represent the encryption type. 0 indicates that an unencrypted key will follow. 7 indicates that a symmetric encrypted key with a fixed length will follow. By default, the encryption type is 0. <i>string</i> is the shared key for the switch and the server, which contains 31 characters at most. <i>encrypted-string</i> is a symmetric encrypted key with a fixed length, which you can copy from the configuration file of another switch. The key or encrypted-key you configure here will be displayed in the encrypted form. |
| Step 3 | <b>show radius-server</b><br>Verify the configuration of RADIUS server.                                                                                                                                                                                                                                                                                                                                                                                                                                                                                                                                                                                                                                                                                                                                                                                                                                                                                                                                                                                                                                                                                                                                                                                                                                                                                                                                                                                                                                                                                                                                                                                                                                                                                                                                                                   |
| Step 4 | <b>end</b><br>Return to privileged EXEC mode.                                                                                                                                                                                                                                                                                                                                                                                                                                                                                                                                                                                                                                                                                                                                                                                                                                                                                                                                                                                                                                                                                                                                                                                                                                                                                                                                                                                                                                                                                                                                                                                                                                                                                                                                                                                             |
| Step 5 | <b>copy running-config startup-config</b><br>Save the settings in the configuration file.                                                                                                                                                                                                                                                                                                                                                                                                                                                                                                                                                                                                                                                                                                                                                                                                                                                                                                                                                                                                                                                                                                                                                                                                                                                                                                                                                                                                                                                                                                                                                                                                                                                                                                                                                 |

The following example shows how to add a RADIUS server on the switch. Set the IP address of the server as 192.168.0.10, the authentication port as 1812, the shared key as 123456, the timeout as 8 seconds and the retransmit number as 3.

**Switch#configure**

**Switch(config)#radius-server host 192.168.0.10 auth-port 1812 timeout 8 retransmit 3 key 123456**

**Switch(config)#show radius-server**

| Server Ip    | Auth Port | Acct Port | Timeout | Retransmit | Shared key |
|--------------|-----------|-----------|---------|------------|------------|
| 192.168.0.10 | 1812      | 1813      | 8       | 3          | 123456     |

**Switch(config)#end**

## Switch#copy running-config startup-config

### ■ Adding TACACS+ Server

Follow these steps to add TACACS+ server on the switch:

|        |                                                                                                                                                                                                                                                                                                                                                                                                                                                                                                                                                                                                                                                                                                                                                                                                                                                                                                                                                                                                                                                                                                                                                                                                                                                                                                                                                           |
|--------|-----------------------------------------------------------------------------------------------------------------------------------------------------------------------------------------------------------------------------------------------------------------------------------------------------------------------------------------------------------------------------------------------------------------------------------------------------------------------------------------------------------------------------------------------------------------------------------------------------------------------------------------------------------------------------------------------------------------------------------------------------------------------------------------------------------------------------------------------------------------------------------------------------------------------------------------------------------------------------------------------------------------------------------------------------------------------------------------------------------------------------------------------------------------------------------------------------------------------------------------------------------------------------------------------------------------------------------------------------------|
| Step 1 | <b>configure</b><br>Enter global configuration mode.                                                                                                                                                                                                                                                                                                                                                                                                                                                                                                                                                                                                                                                                                                                                                                                                                                                                                                                                                                                                                                                                                                                                                                                                                                                                                                      |
| Step 2 | <b>tacacs-server host <i>ip-address</i> [ port <i>port-id</i> ] [ timeout <i>time</i> ] [ key { [ 0 ] <i>string</i>   7 <i>encrypted-string</i> } ]</b><br>Add the RADIUS server and configure the related parameters as needed.<br><br><b>host <i>ip-address</i></b> : Enter the IP address of the server running the TACACS+ protocol.<br><br><b>port <i>port-id</i></b> : Specify the TCP destination port on the TACACS+ server for authentication requests. The default setting is 49.<br><br><b>timeout <i>time</i></b> : Specify the time interval that the switch waits for the server to reply before resending. The valid values are from 1 to 9 seconds and the default setting is 5 seconds.<br><br><b>key { [ 0 ] <i>string</i>   7 <i>encrypted-string</i> }</b> : Specify the shared key. 0 and 7 represent the encryption type. 0 indicates that an unencrypted key will follow. 7 indicates that a symmetric encrypted key with a fixed length will follow. By default, the encryption type is 0. <i>string</i> is the shared key for the switch and the server, which contains 31 characters at most. <i>encrypted-string</i> is a symmetric encrypted key with a fixed length, which you can copy from the configuration file of another switch. The key or encrypted-key you configured here will be displayed in the encrypted form. |
| Step 3 | <b>show tacacs-server</b><br>Verify the configuration of TACACS+ server.                                                                                                                                                                                                                                                                                                                                                                                                                                                                                                                                                                                                                                                                                                                                                                                                                                                                                                                                                                                                                                                                                                                                                                                                                                                                                  |
| Step 4 | <b>end</b><br>Return to privileged EXEC mode.                                                                                                                                                                                                                                                                                                                                                                                                                                                                                                                                                                                                                                                                                                                                                                                                                                                                                                                                                                                                                                                                                                                                                                                                                                                                                                             |
| Step 5 | <b>copy running-config startup-config</b><br>Save the settings in the configuration file.                                                                                                                                                                                                                                                                                                                                                                                                                                                                                                                                                                                                                                                                                                                                                                                                                                                                                                                                                                                                                                                                                                                                                                                                                                                                 |

The following example shows how to add a TACACS+server on the switch. Set the IP address of the server as 192.168.0.20, the authentication port as 49, the shared key as 123456, and the timeout as 8 seconds.

### Switch#configure

```
Switch(config)#tacacs-server host 192.168.0.20 auth-port 49 timeout 8 key 123456
```

### Switch(config)#show tacacs-server

| Server Ip    | Port | Timeout | Shared key |
|--------------|------|---------|------------|
| 192.168.0.20 | 49   | 8       | 123456     |

### Switch(config)#end

```
Switch#copy running-config startup-config
```

## 7.2.3 Configuring Server Groups

The switch has two built-in server groups, one for RADIUS and the other for TACACS+. The servers running the same protocol are automatically added to the default server group. You can add new server groups as needed.

The two default server groups cannot be deleted or edited. Follow these steps to add a server group:

---

|        |                                                                                                                                                                                          |
|--------|------------------------------------------------------------------------------------------------------------------------------------------------------------------------------------------|
| Step 1 | <b>configure</b><br>Enter global configuration mode.                                                                                                                                     |
| Step 2 | <b>aaa group { radius   tacacs } group-name</b><br>Create a server group.<br><br><i>radius   tacacs:</i> Specify the group type.<br><br><i>group-name:</i> Specify a name for the group. |
| Step 3 | <b>server ip-address</b><br>Add the existing servers to the server group.<br><br><i>ip-address:</i> Specify IP address of the server to be added to the group.                           |
| Step 4 | <b>show aaa group [ group-name ]</b><br>Verify the configuration of server group.                                                                                                        |
| Step 5 | <b>end</b><br>Return to privileged EXEC mode.                                                                                                                                            |
| Step 6 | <b>copy running-config startup-config</b><br>Save the settings in the configuration file.                                                                                                |

---

The following example shows how to create a RADIUS server group named RADIUS1 and add the existing two RADIUS servers whose IP address is 192.168.0.10 and 192.168.0.20 to the group.

```
Switch#configure
```

```
Switch(config)#aaa group radius RADIUS1
```

```
Switch(aaa-group)#server 192.168.0.10
```

```
Switch(aaa-group)#server 192.168.0.20
```

```
Switch(aaa-group)#show aaa group RADIUS1
```

```
192.168.0.10
```

```
192.168.0.20
```

```
Switch(aaa-group)#end
```

```
Switch#copy running-config startup-config
```

## 7.2.4 Configuring the Method List

A method list describes the authentication methods and their sequence to authenticate the users. The switch supports Login Method List for users of all types to gain access to the switch, and Enable Method List for guests to get administrative privileges.

Follow these steps to configure the method list:

|        |                                                                                                                                                                                                                                                                                                                                                                                                                                                                                                                                        |
|--------|----------------------------------------------------------------------------------------------------------------------------------------------------------------------------------------------------------------------------------------------------------------------------------------------------------------------------------------------------------------------------------------------------------------------------------------------------------------------------------------------------------------------------------------|
| Step 1 | <b>configure</b><br>Enter global configuration mode.                                                                                                                                                                                                                                                                                                                                                                                                                                                                                   |
| Step 2 | <b>aaa authentication login { method-list } { method1 } [ method2 ] [ method3 ] [ method4 ]</b><br>Configure a login method list.<br><br><i>method-list</i> : Specify a name for the method list.<br><br><i>method1/method2/method3/method4</i> : Specify the authentication methods in order. The first method authenticates a user first, the second method is tried if the previous method does not respond, and so on. The default methods include radius, tacacs, local and none. None means no authentication is used for login. |
| Step 3 | <b>aaa authentication enable { method-list } { method1 } [ method2 ] [ method3 ] [ method4 ]</b><br>Configure an Enable password method list.<br><br><i>method-list</i> : Specify a name for the method list.<br><br><i>method1/method2/method3/method4</i> : Specify the authentication methods in order. The default methods include radius, tacacs, local and none. None means no authentication is used for getting administrative privileges.                                                                                     |
| Step 4 | <b>show aaa authentication [ login   enable ]</b><br>Verify the configuration method list.                                                                                                                                                                                                                                                                                                                                                                                                                                             |
| Step 5 | <b>end</b><br>Return to privileged EXEC mode.                                                                                                                                                                                                                                                                                                                                                                                                                                                                                          |
| Step 6 | <b>copy running-config startup-config</b><br>Save the settings in the configuration file.                                                                                                                                                                                                                                                                                                                                                                                                                                              |

The following example shows how to create a Login method list named Login1, and configure the method 1 as the default radius server group and the method 2 as local.

```
Switch#configure
```

```
Switch(config)##aaa authentication login Login1 radius local
```

```
Switch(config)#show aaa authentication login
```

```

Methodlist  pri1    pri2    pri3    pri4
default     local  --      --      --
Login1      radius local   --      --

```

**Switch(config)#end**

**Switch#copy running-config startup-config**

The following example shows how to create an Enable method list named Enable1, and configure the method 1 as the default radius server group and the method 2 as local.

**Switch#configure**

**Switch(config)##aaa authentication enable Enable1 radius local**

**Switch(config)#show aaa authentication enable**

```

Methodlist  pri1    pri2    pri3    pri4
default     local  --      --      --
Enable1     radius local   --      --

```

**Switch(config)#end**

**Switch#copy running-config startup-config**

## 7.2.5 Configuring the AAA Application List

You can configure authentication method lists on the following access applications: Telnet, SSH and HTTP.

- **Telnet**

Follow these steps to apply the Login and Enable method lists for the application Telnet:

|        |                                                                                                                                                                                  |
|--------|----------------------------------------------------------------------------------------------------------------------------------------------------------------------------------|
| Step 1 | <b>configure</b><br>Enter global configuration mode.                                                                                                                             |
| Step 2 | <b>line telnet</b><br>Enter line configuration mode.                                                                                                                             |
| Step 3 | <b>login authentication { <i>method-list</i> }</b><br>Apply the Login method list for the application Telnet.<br><i>method-list</i> : Specify the name of the Login method list. |

- 
- Step 4      **enable authentication { *method-list* }**  
 Apply the Enable method list for the application Telnet.  
*method-list*: Specify the name of the Enable method list.
- 
- Step 5      **show aaa global**  
 Verify the configuration of application list.
- 
- Step 6      **end**  
 Return to privileged EXEC mode.
- 
- Step 7      **copy running-config startup-config**  
 Save the settings in the configuration file.
- 

The following example shows how to apply the existing Login method list named Login1 and Enable method list named Enable1 for the application Telnet.

**Switch#configure**

**Switch(config)#line telnet**

**Switch(config-line)#login authentication Login1**

**Switch(config-line)#enable authentication Enable1**

**Switch(config-line)#show aaa global**

.....

|        |            |             |
|--------|------------|-------------|
| Module | Login List | Enable List |
| Telnet | Login1     | Enable1     |
| Ssh    | default    | default     |
| Http   | default    | default     |

**Switch(config-line)#end**

**Switch#copy running-config startup-config**

#### ■ SSH

Follow these steps to apply the Login and Enable method lists for the application SSH:

- 
- Step 1      **configure**  
 Enter global configuration mode.
- 
- Step 2      **line ssh**  
 Enter line configuration mode.
-

- 
- Step 3      **login authentication { *method-list* }**  
 Apply the Login method list for the application SSH.  
*method-list*: Specify the name of the Login method list.
- 
- Step 4      **enable authentication { *method-list* }**  
 Apply the Enable method list for the application SSH.  
*method-list*: Specify the name of the Enable method list.
- 
- Step 5      **show aaa global**  
 Verify the configuration of application list.
- 
- Step 6      **end**  
 Return to privileged EXEC mode.
- 
- Step 7      **copy running-config startup-config**  
 Save the settings in the configuration file.
- 

The following example shows how to apply the existing Login method list named Login1 and Enable method list named Enable1 for the application SSH.

**Switch#configure**

**Switch(config)#line ssh**

**Switch(config-line)#login authentication Login1**

**Switch(config-line)#enable authentication Enable1**

**Switch(config-line)#show aaa global**

.....

| Module | Login List | Enable List |
|--------|------------|-------------|
| Telnet | default    | default     |
| Ssh    | Login1     | Enable1     |
| Http   | default    | default     |

**Switch(config-line)#end**

**Switch#copy running-config startup-config**

#### ■ HTTP

Follow these steps to apply the Login and Enable method lists for the application HTTP:

- 
- Step 1      **configure**  
 Enter global configuration mode.
-

---

|        |                                                                                                                                                                                                         |
|--------|---------------------------------------------------------------------------------------------------------------------------------------------------------------------------------------------------------|
| Step 2 | <p><b>ip http login authentication { <i>method-list</i> }</b></p> <p>Apply the Login method list for the application HTTP.</p> <p><i>method-list</i>: Specify the name of the Login method list.</p>    |
| <hr/>  |                                                                                                                                                                                                         |
| Step 3 | <p><b>ip http enable authentication { <i>method-list</i> }</b></p> <p>Apply the Enable method list for the application HTTP.</p> <p><i>method-list</i>: Specify the name of the Enable method list.</p> |
| <hr/>  |                                                                                                                                                                                                         |
| Step 5 | <p><b>show aaa global</b></p> <p>Verify the configuration of application list.</p>                                                                                                                      |
| <hr/>  |                                                                                                                                                                                                         |
| Step 5 | <p><b>end</b></p> <p>Return to privileged EXEC mode.</p>                                                                                                                                                |
| <hr/>  |                                                                                                                                                                                                         |
| Step 6 | <p><b>copy running-config startup-config</b></p> <p>Save the settings in the configuration file.</p>                                                                                                    |

---

The following example shows how to apply the existing Login method list named Login1 and Enable method list named Enable1 for the application HTTP:

**Switch#configure**

**Switch(config)#ip http login authentication Login1**

**Switch(config)#ip http enable authentication Enable1**

**Switch(config)#show aaa global**

.....

| Module | Login List | Enable List |
|--------|------------|-------------|
| Telnet | default    | default     |
| Ssh    | default    | default     |
| Http   | Login1     | Enable1     |

**Switch(config)#end**

**Switch#copy running-config startup-config**

## 7.2.6 Configuring Login Account and Enable Password

The login account and Enable password can be configured locally on the switch or centrally on the RADIUS/TACACS+ server(s).

- **On the Switch**

The local username and password for login can be configured in the User Management feature. For details, refer to *Managing System*.



To configure the local Enable password for getting administrative privileges, follow these steps:

---

|        |                                                                                                                                                                                                                                                                                                                                                                                                                                                                                                                                                                                                                                                                                                                                                                                                                                                                                                                                                                                                                                                                                                                                                                                                                                                                           |
|--------|---------------------------------------------------------------------------------------------------------------------------------------------------------------------------------------------------------------------------------------------------------------------------------------------------------------------------------------------------------------------------------------------------------------------------------------------------------------------------------------------------------------------------------------------------------------------------------------------------------------------------------------------------------------------------------------------------------------------------------------------------------------------------------------------------------------------------------------------------------------------------------------------------------------------------------------------------------------------------------------------------------------------------------------------------------------------------------------------------------------------------------------------------------------------------------------------------------------------------------------------------------------------------|
| Step 1 | <b>configure</b><br>Enter global configuration mode.                                                                                                                                                                                                                                                                                                                                                                                                                                                                                                                                                                                                                                                                                                                                                                                                                                                                                                                                                                                                                                                                                                                                                                                                                      |
| Step 2 | <b>enable admin password</b> {[0] <i>password</i>   7 <i>encrypted-password</i> }<br>Set the Enable password. This command uses symmetric encryption.<br><br>0 and 7 represent the encryption type. 0 indicates that an unencrypted key will follow. 7 indicates that a symmetric encrypted key with a fixed length will follow. By default, the encryption type is 0. <i>password</i> is a string from 1 to 31 alphanumeric characters or symbols. <i>encrypted-password</i> is a symmetric encrypted key with a fixed length, which you can copy from the configuration file of another switch. The key or encrypted-key you configured here will be displayed in the encrypted form.<br><br><b>enable admin secret</b> {[0] <i>password</i>   5 <i>encrypted-password</i> }<br>Set the Enable password. This command uses MD5 encryption.<br><br>0 and 5 are the encryption type. 0 indicates that an unencrypted key will follow. 5 indicates that an MD5 encrypted password with fixed length will follow. By default, the encryption type is 0. <i>password</i> is a string from 1 to 31 alphanumeric characters or symbols. <i>encrypted-password</i> is an MD5 encrypted password with fixed length, which you can copy from another switch's configuration file. |
| Step 3 | <b>end</b><br>Return to privileged EXEC mode.                                                                                                                                                                                                                                                                                                                                                                                                                                                                                                                                                                                                                                                                                                                                                                                                                                                                                                                                                                                                                                                                                                                                                                                                                             |
| Step 4 | <b>copy running-config startup-config</b><br>Save the settings in the configuration file.                                                                                                                                                                                                                                                                                                                                                                                                                                                                                                                                                                                                                                                                                                                                                                                                                                                                                                                                                                                                                                                                                                                                                                                 |

---

#### ■ On the Server

The accounts created by the RADIUS/TACACS+ server can only view the configurations and some network information without the Enable password.

Some configuration principles on the server are as follows:

- For Login authentication configuration, more than one login account can be created on the server. Besides, both the user name and password can be customized.
- For Enable password configuration:

On RADIUS server, the user name should be set as **\$enable\$**, and the Enable password is customizable. All the users trying to get administrative privileges share this Enable password.

On TACACS+ server, the Enable password is set with the login account, and each account has its own Enable password.

**Tips:** The logged-in guests can get administrative privileges by using the command **enable-admin** and providing the Enable password.

# 8 Configuration Examples

## 8.1 Example for DHCP Snooping and ARP Detection

### 8.1.1 Network Requirements

As shown below, User 1 and User 2 get IP addresses from the DHCP server, and User 3 has a static IP address. All of them are in the default VLAN 1. Now, untrusted DHCP packets need to be filtered to ensure that the DHCP clients (User 1 and User 2) can get the IP addresses from the legal DHCP server. Additionally, the network needs to be prevented from ARP attacks.

Figure 8-1 Network Topology

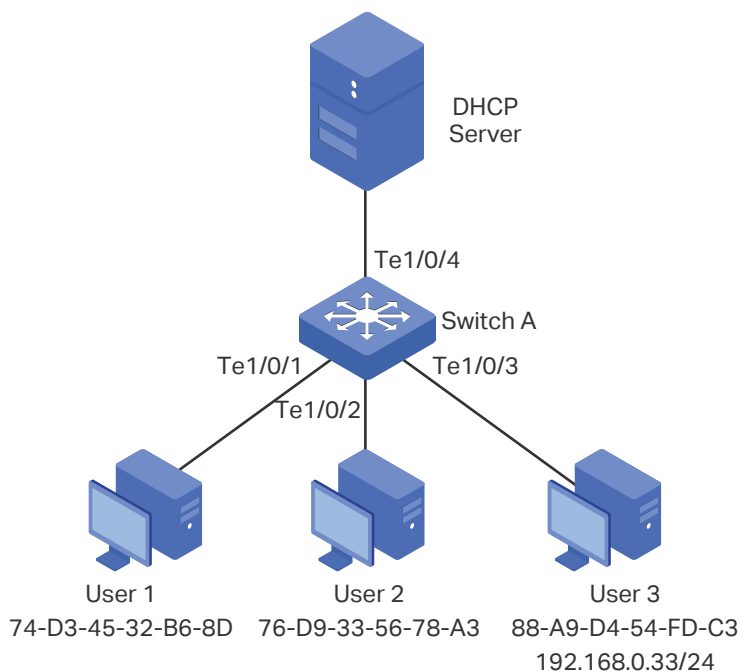

### 8.1.2 Configuration Scheme

To meet these requirements, you can configure DHCP Snooping to filter the untrusted DHCP messages from the illegal DHCP server and configure ARP Detection and ARP Defend to prevent the network from ARP attacks. The overview of configuration is as follows:

- 1) Configure DHCP Snooping on Switch A. Set port 1/0/4 as the trusted port and other ports as untrusted ports.
- 2) Configure IP-MAC Binding on Switch A. The binding entries for User 1 and User 2 are automatically recorded via DHCP Snooping, and you need to manually bind the entry for User 3.

- 3) Enable ARP Detection on Switch A to prevent ARP cheating attacks.
- 4) Configure ARP Defend on Switch A to limit the speed of receiving the legal ARP packets on each port, thus to prevent ARP flooding attacks.

Demonstrated with T1700X-16TS, the following sections provide configuration procedure in two ways: using the GUI and using the CLI.

### 8.1.3 Using the GUI

- 1) Choose the menu **Network Security > DHCP Snooping > Global Config** to load the following page. Because all users are in the default VLAN 1, enable DHCP Snooping on VLAN 1. Click **Apply**.

Figure 8-2 Global Config

**DHCP Snooping Configuration**

DHCP Snooping:  Enable  Disable

VLAN ID:   Enable  Disable  
(1-4094, format: 1,3,4-7,11-30)

VLAN Configuration Display:

- 2) Choose the menu **Network Security > DHCP Snooping > Port Config** to load the following page. Set port 1/0/4 as the trusted port and ports 1/0/1-port1/0/3 as untrusted ports. and click **Apply**.

Figure 8-3 Port Config

| DHCP Snooping Port Configuration |        |                               |                               |                               |                               |     |
|----------------------------------|--------|-------------------------------|-------------------------------|-------------------------------|-------------------------------|-----|
| UNIT: 1 LAGS                     |        |                               |                               |                               |                               |     |
| Select                           | Port   | Trusted Port                  | MAC Verify                    | Rate Limit                    | Decline Protect               | LAG |
| <input type="checkbox"/>         |        | <input type="text" value=""/> | <input type="text" value=""/> | <input type="text" value=""/> | <input type="text" value=""/> |     |
| <input type="checkbox"/>         | 1/0/1  | Disable                       | Enable                        | Disable                       | Disable                       | --- |
| <input type="checkbox"/>         | 1/0/2  | Disable                       | Enable                        | Disable                       | Disable                       | --- |
| <input type="checkbox"/>         | 1/0/3  | Disable                       | Enable                        | Disable                       | Disable                       | --- |
| <input type="checkbox"/>         | 1/0/4  | Enable                        | Enable                        | Disable                       | Disable                       | --- |
| <input type="checkbox"/>         | 1/0/5  | Disable                       | Enable                        | Disable                       | Disable                       | --- |
| <input type="checkbox"/>         | 1/0/6  | Disable                       | Enable                        | Disable                       | Disable                       | --- |
| <input type="checkbox"/>         | 1/0/7  | Disable                       | Enable                        | Disable                       | Disable                       | --- |
| <input type="checkbox"/>         | 1/0/8  | Disable                       | Enable                        | Disable                       | Disable                       | --- |
| <input type="checkbox"/>         | 1/0/9  | Disable                       | Enable                        | Disable                       | Disable                       | --- |
| <input type="checkbox"/>         | 1/0/10 | Disable                       | Enable                        | Disable                       | Disable                       | --- |
| <input type="checkbox"/>         | 1/0/11 | Disable                       | Enable                        | Disable                       | Disable                       | --- |
| <input type="checkbox"/>         | 1/0/12 | Disable                       | Enable                        | Disable                       | Disable                       | --- |
| <input type="checkbox"/>         | 1/0/13 | Disable                       | Enable                        | Disable                       | Disable                       | --- |
| <input type="checkbox"/>         | 1/0/14 | Disable                       | Enable                        | Disable                       | Disable                       | --- |
| <input type="checkbox"/>         | 1/0/15 | Disable                       | Enable                        | Disable                       | Disable                       | --- |

- Choose the menu **Network Security > IP-MAC Binding > Manual Binding** to load the following page. Enter the host name, IP address, MAC address and VLAN ID of User 3, select ARP Detection as the protect type, and select port 1/0/3 on the panel. Click **Bind**.

Figure 8-4 Manual Binding

Manual Binding Option

Host Name:  (20 characters maximum)

IP Address:  (Format: 192.168.0.1)

MAC Address:  (Format: 00-00-00-00-00-01)

VLAN ID:  (1-4094)

Protect Type:

Port:

UNIT: 1

|   |   |   |   |    |    |    |    |
|---|---|---|---|----|----|----|----|
| 2 | 4 | 6 | 8 | 10 | 12 | 14 | 16 |
| 1 | 3 | 5 | 7 | 9  | 11 | 13 | 15 |

Unselected Port(s)   
  Selected Port(s)   
  Not Available for Selection

- Choose the menu **Network Security > IP-MAC Binding > Binding Table** to load the following page. Select Source type as All, and click **Search** to view all the entries that have been bound.

Figure 8-5 Binding Table

Search

Source:

IP:

Binding Table

UNIT: 1

| Select                   | Host Name            | IP Address   | MAC Address       | VLAN ID | Port  | Protect Type                  | Source | Collision |
|--------------------------|----------------------|--------------|-------------------|---------|-------|-------------------------------|--------|-----------|
| <input type="checkbox"/> | <input type="text"/> |              |                   |         |       | <input type="text" value=""/> |        |           |
| <input type="checkbox"/> | User 3               | 192.168.0.33 | 88-a9-d4-54-fd-c3 | 1       | 1/0/3 | ARP Detection                 | Manual | ---       |
| <input type="checkbox"/> | ---                  | 19.168.0.20  | 74-d3-45-32-b6-8d | 1       | 1/0/1 | ARP Detection                 | Manual | ---       |
| <input type="checkbox"/> | ---                  | 192.168.0.21 | 76-d9-33-56-78-a3 | 1       | 1/0/2 | ARP Detection                 | Manual | ---       |

- 5) Choose the menu **Network Security > ARP Inspection > ARP Detect** to load the following page. Enable ARP Detection and set ports 1/0/4 as trusted port. Click **Apply**.

Figure 8-6 ARP Detect

ARP Detect

ARP Detect:  Enable  Disable

Trusted Port

UNIT: 1

2  4  6  8  10  12  14  16  
 1  3  5  7  9  11  13  15

Unselected Port(s)  Selected Port(s)  Not Available for Selection

- 6) Choose the menu **Network Security > ARP Inspection > ARP Defend** to load the following page. Enable ARP Defend for ports 1/0/1-3 and click **Apply**.

Figure 8-7 ARP Defend

| ARP Defend                          |        |         |                   |                     |        |     |           |
|-------------------------------------|--------|---------|-------------------|---------------------|--------|-----|-----------|
| UNIT: 1                             |        |         |                   |                     |        |     |           |
| Select                              | Port   | Defend  | Speed (10-100)pps | Current Speed (pps) | Status | LAG | Operation |
| <input type="checkbox"/>            |        | Enable  |                   |                     |        |     |           |
| <input checked="" type="checkbox"/> | 1/0/1  | Disable | 15                | ---                 | ---    | --- | ---       |
| <input checked="" type="checkbox"/> | 1/0/2  | Disable | 15                | ---                 | ---    | --- | ---       |
| <input checked="" type="checkbox"/> | 1/0/3  | Disable | 15                | ---                 | ---    | --- | ---       |
| <input type="checkbox"/>            | 1/0/4  | Disable | 15                | ---                 | ---    | --- | ---       |
| <input type="checkbox"/>            | 1/0/5  | Disable | 15                | ---                 | ---    | --- | ---       |
| <input type="checkbox"/>            | 1/0/6  | Disable | 15                | ---                 | ---    | --- | ---       |
| <input type="checkbox"/>            | 1/0/7  | Disable | 15                | ---                 | ---    | --- | ---       |
| <input type="checkbox"/>            | 1/0/8  | Disable | 15                | ---                 | ---    | --- | ---       |
| <input type="checkbox"/>            | 1/0/9  | Disable | 15                | ---                 | ---    | --- | ---       |
| <input type="checkbox"/>            | 1/0/10 | Disable | 15                | ---                 | ---    | --- | ---       |
| <input type="checkbox"/>            | 1/0/11 | Disable | 15                | ---                 | ---    | --- | ---       |
| <input type="checkbox"/>            | 1/0/12 | Disable | 15                | ---                 | ---    | --- | ---       |
| <input type="checkbox"/>            | 1/0/13 | Disable | 15                | ---                 | ---    | --- | ---       |
| <input type="checkbox"/>            | 1/0/14 | Disable | 15                | ---                 | ---    | --- | ---       |
| <input type="checkbox"/>            | 1/0/15 | Disable | 15                | ---                 | ---    | --- | ---       |

- 7) Click **Save Config** to save the settings.

### 8.1.4 Using the CLI

- 1) Enable DHCP Snooping globally and on VLAN 1.

```
Switch_A#configure
```

```
Switch_A(config)#ip dhcp snooping
```

```
Switch_A(config)#ip dhcp snooping vlan 1
```

- 2) Configure port 1/0/4 as a trusted port.

```
Switch_A(config)#interface ten-gigabitEthernet 1/0/4
```

```
Switch_A(config-if)#ip dhcp snooping trust
```

```
Switch_A(config-if)#exit
```

- 3) Manually bind the entry for User 3.

```
Switch_A(config)#ip source binding User3 192.168.0.33 88:a9:d4:54:fd:c3 vlan 1
interface ten-gigabitEthernet 1/0/3 arp-detection
```

- 4) Enable ARP Detection globally and set port 1/0/4 as a trusted port.

```
Switch_A(config)#ip arp inspection
```

```
Switch_A(config)#interface ten-gigabitEthernet 1/0/4
```

```
Switch_A(config-if)#ip arp inspection trust
```

```
Switch_A(config-if)#exit
```

- 5) Configure ARP Defend on ports 1/0/1-3.

```
Switch_A(config)#interface range ten-gigabitEthernet 1/0/1-3
```

```
Switch_A(config-if-range)#ip arp inspection
```

```
Switch_A(config-if-range)#ip arp inspection limit-rate 15
```

```
Switch_A(config-if-range)#end
```

```
Switch_A#copy running-config startup-config
```

### Verify the Configuration

Verify the configuration of DHCP Snooping:

```
Switch_A#show ip dhcp snooping
```

```
Global Status: Enable
```

```
VLAN ID: 1
```

```
Switch_A#show ip dhcp snooping interface
```

| Interface | Trusted | MAC-Verify | Limit-Rate | Dec-rate | LAG |
|-----------|---------|------------|------------|----------|-----|
| Te1/0/1   | Disable | Enable     | 0          | 0        | N/A |
| Te1/0/2   | Disable | Enable     | 0          | 0        | N/A |
| Te1/0/3   | Disable | Enable     | 0          | 0        | N/A |
| Te1/0/4   | Enable  | Enable     | 0          | 0        | N/A |
| .....     |         |            |            |          |     |

Verify the IP-MAC Binding entries:

```
Switch_A#show ip source binding
```

| U | No. | Host  | IP-Addr      | MAC-Addr          | VID | Port    | ACL   | Col. |
|---|-----|-------|--------------|-------------------|-----|---------|-------|------|
| 1 | 1   | User1 | 192.168.0.20 | 74:d3:45:32:6b:8d | 1   | Te1/0/1 | ARP-D |      |
| 1 | 2   | User2 | 192.168.0.21 | 76:d9:33:56:78:a3 | 1   | Te1/0/2 | ARP-D |      |
| 1 | 3   | User3 | 192.168.0.33 | 88:a9:d4:54:fd:c3 | 1   | Te1/0/3 | ARP-D |      |

Verify the configuration of ARP Detection:

```
Switch_A#show ip arp inspection
```

ARP detection global status: Enabled

Port Trusted

Te1/0/1 NO

Te1/0/2 NO

Te1/0/3 NO

Te1/0/4 YES

.....

Verify the configuration of ARP Defend:

Switch\_A#show ip arp inspection interface

| Port    | OverSpeed | Rate | Current | Status | LAG |
|---------|-----------|------|---------|--------|-----|
| Te1/0/1 | Enabled   | 15   | N/A     | Normal | N/A |
| Te1/0/2 | Enabled   | 15   | N/A     | Normal | N/A |
| Te1/0/3 | Enabled   | 15   | N/A     | Normal | N/A |
| Te1/0/4 | Disabled  | 15   | N/A     | N/A    | N/A |

.....

## 8.2 Example for 802.1X

### 8.2.1 Network Requirements

The network administrator wants to control access from the end users (clients) in the company. It is required that all clients need to be authenticated separately and that only the authenticated clients can access the Internet.

### 8.2.2 Configuration Scheme

- To authenticate clients separately, enable 802.1X authentication, configure the control mode as auto, and set the control type as MAC based.
- Enable 802.1X authentication on the ports connected to clients.
- Keep 802.1X authentication disabled on ports connected to the authentication server and the Internet, which ensures unrestricted connections between the switch and the authentication server or the Internet.



## 8.2.3 Network Topology

As shown in the following figure, Switch A acts as the authenticator. Port 1/0/1 is connected to the client, port 1/0/2 is connected to the RADIUS server, and port 1/0/3 is connected to the Internet.

Figure 8-8 Network Topology

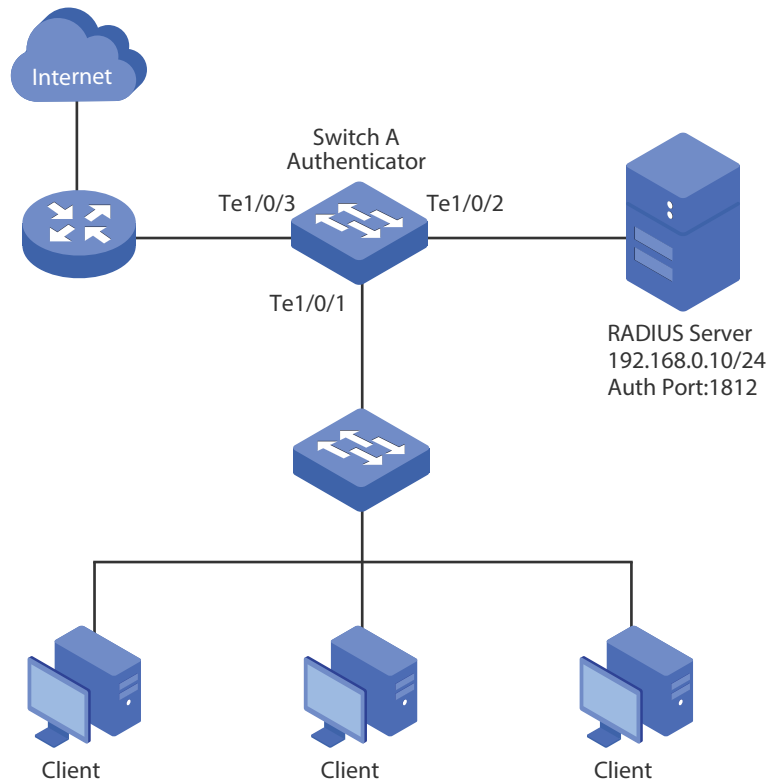

Demonstrated with T1700X-16TS acting as the authenticator, the following sections provide configuration procedure in two ways: using the GUI and using the CLI.

## 8.2.4 Using the GUI

- 1) Choose the menu **Network Security > AAA > Global Config** to load the following page. Enable AAA function globally on the switch.

Figure 8-9 Enable AAA Function



- 2) Choose the menu **Network Security > AAA > RADIUS Config** to load the following page. Configure the parameters of the RADIUS server.

Figure 8-10 RADIUS Config

**Server Config**

Server IP:  (Format: 192.168.0.1)

Shared Key:

Auth Port:  (1-65535)

Acct Port:  (1-65535)

Retransmit:  (1-3)

Timeout:  sec(1-9)

---

**Server List**

| Select                   | Server IP | Shared Key           | Auth Port            | Acct Port            | Retransmit           | Timeout              |
|--------------------------|-----------|----------------------|----------------------|----------------------|----------------------|----------------------|
| <input type="checkbox"/> |           | <input type="text"/> | <input type="text"/> | <input type="text"/> | <input type="text"/> | <input type="text"/> |

No entry in the table.

- Choose the menu **Network Security > AAA > Server Group** to load the following page. In the **Add New Server Group** section, specify the group name as radius1 and the server type as RADIUS. Click **Add** to create the server group.

Figure 8-11 Create Server Group

**Add New Server Group**

Server Group:

Server Type:

- On the same page, select the newly created server group and click **edit** to load the following page. Select 192.168.0.10 from the drop-down list, and click **Add** to add the server to the group.

Figure 8-12 Add Servers to Server Group

**Add Server IP**

Server Group:

Server Type:

Server IP:

- Choose the menu **Network Security > AAA > Dot1x List** to load the following page. In the **Authentication Dot1x Method List** section, select radius1 as the radius server group for authentication, and click **Apply**.

Figure 8-13 Configure Authentication RADIUS Server

**Authentication Dot1x Method List**

| Select                              | List    | Pri1                 |
|-------------------------------------|---------|----------------------|
| <input type="checkbox"/>            |         | <input type="text"/> |
| <input checked="" type="checkbox"/> | default | radius1              |

- 6) Choose the menu **Network Security > 802.1X Authentication > Global Config** to load the following page. Enable 802.1X authentication and configure the Authentication Method as EAP. Enable the Quiet feature and then keep the default authentication settings.

Figure 8-14 Global Config

**Global Config**

|                |                                                                       |                                      |
|----------------|-----------------------------------------------------------------------|--------------------------------------|
| 802.1X:        | <input checked="" type="radio"/> Enable <input type="radio"/> Disable | <input type="button" value="Apply"/> |
| Auth Method:   | <input type="text" value="EAP"/> ▼                                    |                                      |
| Handshake:     | <input checked="" type="radio"/> Enable <input type="radio"/> Disable |                                      |
| Guest VLAN:    | <input type="radio"/> Enable <input checked="" type="radio"/> Disable |                                      |
| Guest VLAN ID: | <input type="text" value=""/> (2-4094)                                |                                      |
| Accounting:    | <input type="radio"/> Enable <input checked="" type="radio"/> Disable |                                      |

---

**Authentication Config**

|                     |                                                                       |                                                                             |
|---------------------|-----------------------------------------------------------------------|-----------------------------------------------------------------------------|
| Quiet:              | <input checked="" type="radio"/> Enable <input type="radio"/> Disable | <input type="button" value="Apply"/><br><input type="button" value="Help"/> |
| Quiet Period:       | <input type="text" value="10"/> sec (1-999)                           |                                                                             |
| Retry Times:        | <input type="text" value="3"/> (1-9)                                  |                                                                             |
| Supplicant Timeout: | <input type="text" value="3"/> sec (1-9)                              |                                                                             |

- 7) Choose the menu **Network Security > 802.1X Authentication > Port Config** to load the following page. For port 1/0/1, enable 802.1X authentication, set the Control Mode as auto and set the Control Type as MAC Based; For port 1/0/2 and port 1/0/3, disable 802.1X authentication.

Figure 8-15 Port Config

Port Config

UNIT: 1

| Select                              | Port   | Status  | Guest VLAN | Control Mode | Control Type | Authorized | LAG |
|-------------------------------------|--------|---------|------------|--------------|--------------|------------|-----|
| <input type="checkbox"/>            |        | Enable  |            | Auto         | MAC Based    |            |     |
| <input checked="" type="checkbox"/> | 1/0/1  | Disable | Disable    | Auto         | MAC Based    | Authorized | --- |
| <input type="checkbox"/>            | 1/0/2  | Disable | Disable    | Auto         | MAC Based    | Authorized | --- |
| <input type="checkbox"/>            | 1/0/3  | Disable | Disable    | Auto         | MAC Based    | Authorized | --- |
| <input type="checkbox"/>            | 1/0/4  | Disable | Disable    | Auto         | MAC Based    | Authorized | --- |
| <input type="checkbox"/>            | 1/0/5  | Disable | Disable    | Auto         | MAC Based    | Authorized | --- |
| <input type="checkbox"/>            | 1/0/6  | Disable | Disable    | Auto         | MAC Based    | Authorized | --- |
| <input type="checkbox"/>            | 1/0/7  | Disable | Disable    | Auto         | MAC Based    | Authorized | --- |
| <input type="checkbox"/>            | 1/0/8  | Disable | Disable    | Auto         | MAC Based    | Authorized | --- |
| <input type="checkbox"/>            | 1/0/9  | Disable | Disable    | Auto         | MAC Based    | Authorized | --- |
| <input type="checkbox"/>            | 1/0/10 | Disable | Disable    | Auto         | MAC Based    | Authorized | --- |
| <input type="checkbox"/>            | 1/0/11 | Disable | Disable    | Auto         | MAC Based    | Authorized | --- |
| <input type="checkbox"/>            | 1/0/12 | Disable | Disable    | Auto         | MAC Based    | Authorized | --- |
| <input type="checkbox"/>            | 1/0/13 | Disable | Disable    | Auto         | MAC Based    | Authorized | --- |
| <input type="checkbox"/>            | 1/0/14 | Disable | Disable    | Auto         | MAC Based    | Authorized | --- |
| <input type="checkbox"/>            | 1/0/15 | Disable | Disable    | Auto         | MAC Based    | Authorized | --- |

- 8) Click **Save Config** to save the settings.

## 8.2.5 Using the CLI

- 1) Enable AAA function globally and configure the RADIUS parameters.

```
Switch_A(config)#aaa enable
```

```
Switch_A(config)#radius-server host 192.168.0.10 auth-port 1812 key 123456
```

```
Switch_A(config)#aaa group radius radius1
```

```
Switch_A(aaa-group)#server 192.168.0.10
```

```
Switch_A(aaa-group)#exit
```

```
Switch_A(config)#aaa authentication dot1x default radius1
```

```
Switch_A(config)#end
```

```
Switch_A#copy running-config startup-config
```

- 2) Globally enable 802.1X authentication and set the authentication method; enable the quiet feature and configure relevant parameters.

```
Switch_A#configure
```

```
Switch_A(config)#dot1x system-auth-control
```

```
Switch_A(config)#dot1x auth-method eap
```

```
Switch_A(config)#dot1x quiet-period
```

- 3) Disable 802.1X authentication on port 1/0/2 and port 1/0/3. Enable 802.1X authentication on port 1/0/1, set the control mode as auto, and set the control type as MAC based.

```
Switch_A(config)#interface ten-gigabitEthernet 1/0/2
```

```
Switch_A(config-if)#no dot1x
```

```
Switch_A(config-if)#exit
```

```
Switch_A(config)#interface ten-gigabitEthernet 1/0/3
```

```
Switch_A(config-if)#no dot1x
```

```
Switch_A(config-if)#exit
```

```
Switch_A(config)#interface ten-gigabitEthernet 1/0/1
```

```
Switch_A(config-if)#dot1x
```

```
Switch_A(config-if)#dot1x port-method mac-based
```

```
Switch_A(config-if)#dot1x port-control auto
```

```
Switch_A(config-if)#exit
```

### Verify the Configurations

Verify the global configurations of 802.1X authentication:

```
Switch_A#show dot1x global
```

```
802.1X State:          Enabled
```

```
Authentication Method: EAP
```

```
Handshake State:      Enabled
```

```
Guest VLAN State:     Disabled
```

```
Guest VLAN ID:        N/A
```

```
802.1X Accounting State: Disabled
```

```
Quiet-period State:   Enabled
```

```
Quiet-period Timer:   10 sec.
```

```
Max Retry-times For RADIUS Packet: 3
```

```
Supplicant Timeout:   3 sec.
```

Verify the configurations of 802.1X authentication on the port:

```
Switch_A#show dot1x interface
```

| Port    | State    | GuestVLAN | PortControl | PortMethod | Authorized | LAG |
|---------|----------|-----------|-------------|------------|------------|-----|
| Te1/0/1 | enabled  | disabled  | auto        | mac-based  | authorized | N/A |
| Te1/0/2 | disabled | disabled  | auto        | mac-based  | authorized | N/A |
| Te1/0/3 | disabled | disabled  | auto        | mac-based  | authorized | N/A |

.....

Verify the configurations of RADIUS :

```
Switch_A#show aaa global
```

```
AAA global status:      Enable
Module      Login List  Enable List
Console     default    default
Telnet      default    default
Ssh         default    default
Http        default    default
```

```
Switch_A#show aaa authentication dot1x
```

```
Methodlist  pri1     pri2     pri3     pri4
default     radius1  --       --       --
```

```
Switch_A#show aaa group radius1
```

```
192.168.0.10
```

## 8.3 Example for AAA

### 8.3.1 Network Requirements

As shown below, the switch needs to be managed remotely via Telnet. In addition, the senior administrator of the company wants to create an account for the less senior administrators, who can only view the configurations and some network information without the Enable password provided.

Two RADIUS servers are deployed in the network to provide a safer authenticate method for the administrators trying to log in or get administrative privileges. If RADIUS Server 1 breaks down and doesn't respond to the authentication request, RADIUS Server 2 will work, so as to ensure the stability of the authentication system.

Figure 8-16 Network Topology

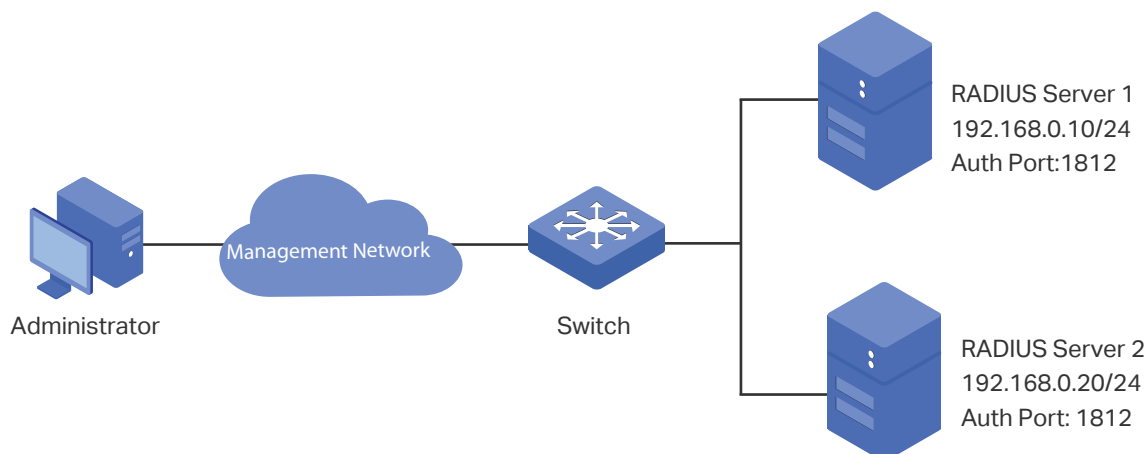

### 8.3.2 Configuration Scheme

To implement this requirement, the senior administrator can create the login account and the Enable password on the two RADIUS servers, and configure the AAA feature on the switch. The IP addresses of the two RADIUS servers are 192.168.0.10/24 and 192.168.0.20/24; the authentication port number is 1812; the shared key is 123456.

The overview of configuration on the switch is as follows:

- 1) Globally enable AAA.
- 1) Add the two RADIUS servers on the switch.
- 2) Create a new RADIUS server group and add the two servers to the group. Make sure that RADIUS Server 1 is the first server for authentication.
- 3) Configure the method list.
- 4) Configure the AAA application list.

Demonstrated with T1700X-16TS, the following sections provide configuration procedure in two ways: using the GUI and using the CLI.

### 8.3.3 Using the GUI

- 1) Choose the menu **Network Security > AAA > Global Config** to load the following page. In the **Global Config** section, enable AAA and click **Apply**.

Figure 8-17 Global Config



- 2) Choose the menu **Network Security > AAA > RADIUS Server** to load the following page. Configure the Server IP as 192.168.0.10, the Shared Key as 123456, the Auth Port as 1812, and keep the other parameters as default. Click **Add** to add RADIUS Server 1 on the switch.

Figure 8-18 Add RADIUS Server 1

**Server Config**

Server IP:  (Format: 192.168.0.1)

Shared Key:

Auth Port:  (1-65535)

Acct Port:  (1-65535)

Retransmit:  (1-3)

Timeout:  sec(1-9)

---

**Server List**

| Select                   | Server IP | Shared Key           | Auth Port            | Acct Port            | Retransmit           | Timeout              |
|--------------------------|-----------|----------------------|----------------------|----------------------|----------------------|----------------------|
| <input type="checkbox"/> |           | <input type="text"/> | <input type="text"/> | <input type="text"/> | <input type="text"/> | <input type="text"/> |

No entry in the table.

- 3) On the same page, configure the Server IP as 192.168.0.20, the Shared Key as 123456, the Auth Port as 1812, and keep the other parameters as default. Click **Add** to add RADIUS Server 2 on the switch.

Figure 8-19 Add RADIUS Server 2

**Server Config**

Server IP:  (Format: 192.168.0.1)

Shared Key:

Auth Port:  (1-65535)

Acct Port:  (1-65535)

Retransmit:  (1-3)

Timeout:  sec(1-9)

---

**Server List**

| Select                   | Server IP    | Shared Key           | Auth Port            | Acct Port            | Retransmit           | Timeout              |
|--------------------------|--------------|----------------------|----------------------|----------------------|----------------------|----------------------|
| <input type="checkbox"/> |              | <input type="text"/> | <input type="text"/> | <input type="text"/> | <input type="text"/> | <input type="text"/> |
| <input type="checkbox"/> | 192.168.0.10 | 123456               | 1812                 | 1813                 | 2                    | 5                    |

- 4) Choose the menu **Network Security > AAA > Server Group** to load the following page. In the **Add New Server Group** section, specify the group name as RADIUS1 and the server type as RADIUS. Click **Add** to create the server group.



Figure 8-20 Create Server Group

**Add New Server Group**

Server Group:

Server Type:

---

**Aaa Application List**

| Select                   | Server Group | Server Type | Operation            |
|--------------------------|--------------|-------------|----------------------|
| <input type="checkbox"/> |              |             |                      |
| <input type="checkbox"/> | radius       | RADIUS      | <a href="#">edit</a> |
| <input type="checkbox"/> | Group1       | RADIUS      | <a href="#">edit</a> |
| <input type="checkbox"/> | tacacs       | TACACS+     | <a href="#">edit</a> |

- 5) On the same page, select the newly created server group and click **edit** to load the following page. Select 192.168.0.10 from the drop-down list, and click **Add** to add RADIUS Server 1 to the group. Then select 192.168.0.20 from the drop-down list, and click **Add** to add RADIUS Server 2 to the group.

Figure 8-21 Add Servers to Server Group

**Add Server IP**

Server Group:

Server Type:

Server IP:

---

**Server List**

| Select                   | Server Ip    |
|--------------------------|--------------|
| <input type="checkbox"/> |              |
| <input type="checkbox"/> | 192.168.0.10 |

- 6) Choose the menu **Network Security > AAA > Method List** to load the following page. Specify the Method List Name as Method-Login, select the List Type as Authentication Login, and select the Pri1 as RADIUS1. Click **Add** to set the method list for the Login authentication.

Figure 8-22 Configure Login Method List

**Add Method List**

Method List Name:

List Type:

Pri1:

Pri2:

Pri3:

Pri4:

- 7) On the same page, specify the Method List Name as Method-Enable, select the List Type as Authentication Enable, and select the Pri1 as RADIUS1. Click **Add** to set the method list for the Enable password authentication.

Figure 8-23 Configure Enable Method List

**Add Method List**

Method List Name:

List Type:

Pri1:

Pri2:

Pri3:

Pri4:

- 8) Choose the menu **Network Security > AAA > Global Config** to load the following page. In the **AAA Application List** section, select telnet and configure the Login List as Method-Login and Enable List as Method-Enable. Then click **Apply**.

Figure 8-24 Configure AAA Application List

**Aaa Application List**

| Select                              | Module | Login List                                | Enable list                                |
|-------------------------------------|--------|-------------------------------------------|--------------------------------------------|
| <input type="checkbox"/>            |        | <input type="text" value="Method-Login"/> | <input type="text" value="Method-Enable"/> |
| <input checked="" type="checkbox"/> | telnet | default                                   | default                                    |
| <input type="checkbox"/>            | ssh    | default                                   | default                                    |
| <input type="checkbox"/>            | http   | default                                   | default                                    |

- 9) Click **Save Config** to save the settings.

### 8.3.4 Using the CLI

- 1) Enable AAA globally.

```
Switch#configure
```

```
Switch(config)#aaa enable
```

- 2) Add RADIUS Server 1 and RADIUS Server 2 on the switch.

```
Switch(config)#radius-server host 192.168.0.10 auth-port 1812 key 123456
```

```
Switch(config)#radius-server host 192.168.0.20 auth-port 1812 key 123456
```

- 3) Create a new server group named RADIUS1 and add the two RADIUS servers to the server group.

```
Switch(config)#aaa group radius RADIUS1
```

```
Switch(aaa-group)#server 192.168.0.10
```

```
Switch(aaa-group)#server 192.168.0.20
```

```
Switch(aaa-group)#exit
```

- 4) Create two method lists: Method-Login and Method-Enable, and configure the server group RADIUS1 as the authentication method for the two method lists.

```
Switch(config)#aaa authentication login Method-Login RADIUS1
```

```
Switch(config)#aaa authentication enable Method-Enable RADIUS1
```

- 5) Configure Method-Login and Method-Enable as the authentication method for the Telnet application.

```
Switch(config)#line telnet
```

```
Switch(config-line)#login authentication Method-Login
```

```
Switch(config-line)#enable authentication Method-Enable
```

```
Switch(config-line)#end
```

```
Switch#copy running-config startup-config
```

## Verify the Configuration

Verify the configuration of the RADIUS servers:

```
Switch#show radius-server
```

| Server Ip    | Auth Port | Acct Port | Timeout | Retransmit | Shared key |
|--------------|-----------|-----------|---------|------------|------------|
| 192.168.0.10 | 1812      | 1813      | 5       | 2          | 123456     |
| 192.168.0.20 | 1812      | 1813      | 5       | 2          | 123456     |

Verify the configuration of server group RADIUS1:

```
Switch#show aaa group RADIUS1
```

```
192.168.0.10
```

```
192.168.0.20
```

Verify the configuration of the method lists:

```
Switch#show aaa authentication
```

```
Authentication Login Methodlist:
```

| Methodlist   | pri1    | pri2 | pri3 | pri4 |
|--------------|---------|------|------|------|
| default      | local   | --   | --   | --   |
| Method-Login | RADIUS1 | --   | --   | --   |

```
Authentication Enable Methodlist:
```

| Methodlist    | pri1    | pri2 | pri3 | pri4 |
|---------------|---------|------|------|------|
| default       | none    | --   | --   | --   |
| Method-Enable | RADIUS1 | --   | --   | --   |

.....

Verify the status of the AAA feature and the configuration of the AAA application list:

```
Switch#show aaa global
```

```
AAA global status:    Enable
```

| Module | Login List   | Enable List   |
|--------|--------------|---------------|
| Telnet | Method-Login | Method-Enable |
| Ssh    | default      | default       |
| Http   | default      | default       |

# 9 Appendix: Default Parameters

Default settings of Network Security are listed in the following tables.

Table 9-1 IP-MAC Binding

| Parameter    | Default Setting               |
|--------------|-------------------------------|
| Protect Type | For Manual Binding: None      |
|              | For ARP Scanning: None        |
|              | For DHCP Snooping: ARP Detect |

Table 9-2 DHCP Snooping

| Parameter                | Default Setting |
|--------------------------|-----------------|
| Global Config            |                 |
| DHCP Snooping            | Disable         |
| VLAN ID                  | Disable         |
| Port Config              |                 |
| Trusted Port             | Disable         |
| MAC Verify               | Enable          |
| Rate Limit               | Disable         |
| Decline Protect          | Disable         |
| Option 82 Config         |                 |
| Option 82 Support        | Disable         |
| Operation Strategy       | Keep            |
| Circuit ID Customization | Disable         |
| Circuit ID               | None            |
| Remote ID Customization  | Disable         |
| Remote ID                | None            |

Table 9-3 ARP Inspection

| Parameter        | Default Setting |
|------------------|-----------------|
| ARP Detect       |                 |
| ARP Detect       | Disable         |
| Trusted Port     | None            |
| ARP Defend       |                 |
| Defend           | Disable         |
| Speed            | 15 pps          |
| ARP Statistics   |                 |
| Auto Refresh     | Disable         |
| Refresh Interval | 5 seconds       |

Table 9-4 802.1X

| Parameter             | Default Setting |
|-----------------------|-----------------|
| Global Config         |                 |
| 802.1X Authentication | Disable         |
| Auth Method           | EAP             |
| Guest VLAN            | Disable         |
| Accounting            | Disable         |
| Quiet Feature         |                 |
| Quiet Feature         | Disable         |
| Quiet Period          | 10 seconds      |
| Retry Times           | 3               |
| Supplicant Timeout    | 3 seconds       |
| Port Config           |                 |
| 802.1X Status         | Disable         |
| Guest VLAN            | Disable         |

| Parameter                        | Default Setting                    |
|----------------------------------|------------------------------------|
| Control Mode                     | Auto                               |
| Control Type                     | MAC Based                          |
| Dot1X List                       |                                    |
| Authentication Dot1x Method List | List Name: default<br>Pri1: radius |
| Accounting Dot1x Method List     | List Name: default<br>Pri1:radius  |

Table 9-5 DoS Defend

| Parameter  | Default Setting |
|------------|-----------------|
| DoS Defend | Disable         |

Table 9-6 AAA

| Parameter      | Default Setting |
|----------------|-----------------|
| Global Config  |                 |
| AAA            | Disable         |
| RADIUS Config  |                 |
| Server IP      | None            |
| Shared Key     | None            |
| Auth Port      | 1812            |
| Acct Port      | 1813            |
| Retransmit     | 2               |
| Timeout        | 5 seconds       |
| TACACS+ Config |                 |
| Server IP      | None            |
| Timeout        | 5 seconds       |
| Shared Key     | None            |

| Parameter                                                             | Default Setting                             |
|-----------------------------------------------------------------------|---------------------------------------------|
| Port                                                                  | 49                                          |
| Server Group: There are two default server groups: radius and tacacs. |                                             |
| Method List                                                           |                                             |
| Authentication Login Method List                                      | List name: default<br>Pri1: local           |
| Authentication Enable Method List                                     | List name: default<br>Pri1: none            |
| AAA Application List                                                  |                                             |
| telnet                                                                | Login List: default<br>Enable List: default |
| ssh                                                                   | Login List: default<br>Enable List: default |
| http                                                                  | Login List: default<br>Enable List: default |



# Part 21

## Configuring LLDP

### CHAPTERS

1. LLDP
2. LLDP Configurations
3. LLDP-MED Configurations
4. Viewing LLDP Settings
5. Viewing LLDP-MED Settings
6. Configuration Example
7. Appendix: Default Parameters

# 1 LLDP

## 1.1 Overview

LLDP (Link Layer Discovery Protocol) is a neighbor discovery protocol that is used for network devices to advertise information about themselves to other devices on the network. This protocol is a standard IEEE 802.1ab defined protocol and runs over the Layer 2 (the data-link layer) , which allows for interoperability between network devices of different vendors.

With the LLDP feature, network administrators can get the managed network devices' information from the switch or the NMS (Network Management System), which can help them know about the network topology, examine the network connectivity and troubleshoot the network faults.

LLDP-MED (Media Endpoint Discovery) is an extension of LLDP that is used to advertise information between network devices and media endpoints. It is specially used together with Voice VLAN to allow VoIP (Voice over Internet Protocol) device to access the network. VoIP devices can use LLDP-MED for auto-configuration to minimize the configuration effort.

## 1.2 Supported Features

The switch supports LLDP and LLDP-MED.

LLDP allows the local device to encapsulate its management address, device ID, interface ID and other information into a LLDPDU (Link Layer Discovery Protocol Data Unit) and periodically advertise this LLDPDU to its neighbor devices on the network. The neighbors store the received LLDPDU in a standard MIB (Management Information Base), making it possible for the information to be accessed by a Network Management System (NMS) using a management protocol such as the Simple Network Management Protocol (SNMP).

LLDP-MED allows the network device to send its information including Voice VLAN information, PoE (Power over Ethernet) capacity and etc. to the media endpoint devices for auto-configuration. The media endpoint devices (IP phones) receive the Voice VLAN information and finish the auto-configuration, then send the voice traffic carrying VLAN tag, which can provide preferential treatment to the voice traffic in the Voice VLAN.

# 2 LLDP Configurations

With LLDP configurations, you can:

- 1) Enable the LLDP feature on the switch.
- 2) (Optional) Configure the LLDP feature globally.
- 3) (Optional) Configure the LLDP feature for the interface.

## 2.1 Using the GUI

### 2.1.1 Global Config

Choose the **LLDP > Basic Config > Global Config** to load the following page.

Figure 2-1 Global Config

| Global Config          |                                                                                                                |
|------------------------|----------------------------------------------------------------------------------------------------------------|
| LLDP:                  | <input checked="" type="radio"/> Enable <input type="radio"/> Disable <span style="float: right;">Apply</span> |
| Parameters Config      |                                                                                                                |
| Transmit Interval:     | <input type="text" value="30"/> sec(5-32768)                                                                   |
| Hold Multiplier:       | <input type="text" value="4"/> (2-10)                                                                          |
| Transmit Delay:        | <input type="text" value="2"/> sec(1-8192) <span style="float: right;">Apply</span>                            |
| Reinit Delay:          | <input type="text" value="2"/> sec(1-10) <span style="float: right;">Help</span>                               |
| Notification Interval: | <input type="text" value="5"/> sec(5-3600)                                                                     |
| Fast Start Times:      | <input type="text" value="3"/> (1-10)                                                                          |

Follow these steps to enable LLDP and configure the LLDP feature globally.

- 1) In the **Global Config** section, enable LLDP. Click **Apply**.
- 2) In the **Parameters Config** section, configure the LLDP parameters. Click **Apply**.

|                              |                                                                                                                                                                                                                                                                                                                                                                                                                                                                                          |
|------------------------------|------------------------------------------------------------------------------------------------------------------------------------------------------------------------------------------------------------------------------------------------------------------------------------------------------------------------------------------------------------------------------------------------------------------------------------------------------------------------------------------|
| <b>Transmit Interval</b>     | Enter the interval between successive LLDP packets that are periodically sent from the local device to its neighbors. The default is 30 seconds.                                                                                                                                                                                                                                                                                                                                         |
| <b>Hold Multiplier</b>       | Specify the amount of time the neighbor device should hold the received information before discarding it. The default is 4.<br><br>TTL (Time to Live) = Hold Multiplier * Transmit Interval.                                                                                                                                                                                                                                                                                             |
| <b>Transmit Delay</b>        | Specify the amount of time that the local device waits before sending another LLDP packet to its neighbors. When the local information changes, the local device will send LLDP packets to inform its neighbors. If frequent changes occur to the local device, LLDP packets will flood. After specifying a transmit delay time, the local device will wait for a delay time to send LLDP packets when changes occur to avoid frequent LLDP packet forwarding. The default is 2 seconds. |
| <b>Reinit Delay</b>          | Specify the delay time that the local port waits before changing its Admin Status. When a local port's Admin Status changes, the local device will send Trap messages. After specifying a reinit delay time, the local device will wait for a delay time to send Trap messages to avoid frequent Trap forwarding. The default is 2 seconds.                                                                                                                                              |
| <b>Notification Interval</b> | Enter the interval between successive Trap messages that are periodically sent from the local device to the NMS. The default is 5 seconds.                                                                                                                                                                                                                                                                                                                                               |
| <b>Fast Start Times</b>      | Specify the number of LLDP packets that the local port sends when its Admin Status changes from Disable (or Rx_Only) to Tx&RX (or Tx_Only). The default is 3.<br><br>In this case, the local device will shorten the Transmit Interval of LLDP packets to 1 second to make it quickly discovered by its neighbors. After the specified number of LLDP packets are sent, the Transmit Interval will be restored to the specified value.                                                   |

## 2.1.2 Port Config

Choose th menu **LLDP > Basic Config > Policy Config** to load the following page.

Figure 2-2 Port Config

| Port Config              |        |                               |                               |                                     |                                     |                                     |                                     |                                     |                                     |                                     |                                     |                                     |                                     |
|--------------------------|--------|-------------------------------|-------------------------------|-------------------------------------|-------------------------------------|-------------------------------------|-------------------------------------|-------------------------------------|-------------------------------------|-------------------------------------|-------------------------------------|-------------------------------------|-------------------------------------|
| UNIT:                    |        | 1                             |                               |                                     |                                     |                                     |                                     |                                     |                                     |                                     |                                     |                                     |                                     |
| Select                   | Port   | Admin Status                  | Notification Mode             | Included TLVs                       |                                     |                                     |                                     |                                     |                                     |                                     |                                     |                                     |                                     |
| <input type="checkbox"/> |        | <input type="text" value=""/> | <input type="text" value=""/> | <input checked="" type="checkbox"/> | <input checked="" type="checkbox"/> | <input checked="" type="checkbox"/> | <input checked="" type="checkbox"/> | <input checked="" type="checkbox"/> | <input checked="" type="checkbox"/> | <input checked="" type="checkbox"/> | <input checked="" type="checkbox"/> | <input checked="" type="checkbox"/> | <input checked="" type="checkbox"/> |
| <input type="checkbox"/> | 1/0/1  | Tx&Rx                         | Enable                        | PD                                  | SC                                  | SD                                  | SN                                  | SA                                  | PV                                  | VP                                  | VA                                  | LA                                  | PS                                  |
| <input type="checkbox"/> | 1/0/2  | Tx&Rx                         | Disable                       | PD                                  | SC                                  | SD                                  | SN                                  | SA                                  | PV                                  | VP                                  | VA                                  | LA                                  | PS                                  |
| <input type="checkbox"/> | 1/0/3  | Tx&Rx                         | Disable                       | PD                                  | SC                                  | SD                                  | SN                                  | SA                                  | PV                                  | VP                                  | VA                                  | LA                                  | PS                                  |
| <input type="checkbox"/> | 1/0/4  | Tx&Rx                         | Disable                       | PD                                  | SC                                  | SD                                  | SN                                  | SA                                  | PV                                  | VP                                  | VA                                  | LA                                  | PS                                  |
| <input type="checkbox"/> | 1/0/5  | Tx&Rx                         | Disable                       | PD                                  | SC                                  | SD                                  | SN                                  | SA                                  | PV                                  | VP                                  | VA                                  | LA                                  | PS                                  |
| <input type="checkbox"/> | 1/0/6  | Tx&Rx                         | Disable                       | PD                                  | SC                                  | SD                                  | SN                                  | SA                                  | PV                                  | VP                                  | VA                                  | LA                                  | PS                                  |
| <input type="checkbox"/> | 1/0/7  | Tx&Rx                         | Disable                       | PD                                  | SC                                  | SD                                  | SN                                  | SA                                  | PV                                  | VP                                  | VA                                  | LA                                  | PS                                  |
| <input type="checkbox"/> | 1/0/8  | Tx&Rx                         | Disable                       | PD                                  | SC                                  | SD                                  | SN                                  | SA                                  | PV                                  | VP                                  | VA                                  | LA                                  | PS                                  |
| <input type="checkbox"/> | 1/0/9  | Tx&Rx                         | Disable                       | PD                                  | SC                                  | SD                                  | SN                                  | SA                                  | PV                                  | VP                                  | VA                                  | LA                                  | PS                                  |
| <input type="checkbox"/> | 1/0/10 | Tx&Rx                         | Disable                       | PD                                  | SC                                  | SD                                  | SN                                  | SA                                  | PV                                  | VP                                  | VA                                  | LA                                  | PS                                  |
| <input type="checkbox"/> | 1/0/11 | Tx&Rx                         | Disable                       | PD                                  | SC                                  | SD                                  | SN                                  | SA                                  | PV                                  | VP                                  | VA                                  | LA                                  | PS                                  |
| <input type="checkbox"/> | 1/0/12 | Tx&Rx                         | Disable                       | PD                                  | SC                                  | SD                                  | SN                                  | SA                                  | PV                                  | VP                                  | VA                                  | LA                                  | PS                                  |
| <input type="checkbox"/> | 1/0/13 | Tx&Rx                         | Disable                       | PD                                  | SC                                  | SD                                  | SN                                  | SA                                  | PV                                  | VP                                  | VA                                  | LA                                  | PS                                  |
| <input type="checkbox"/> | 1/0/14 | Tx&Rx                         | Disable                       | PD                                  | SC                                  | SD                                  | SN                                  | SA                                  | PV                                  | VP                                  | VA                                  | LA                                  | PS                                  |
| <input type="checkbox"/> | 1/0/15 | Tx&Rx                         | Disable                       | PD                                  | SC                                  | SD                                  | SN                                  | SA                                  | PV                                  | VP                                  | VA                                  | LA                                  | PS                                  |

Follow these steps to configure the LLDP feature for the interface.

- 1) Select the desired port and set its Admin Status and Notification Mode.

|                                 |                                                                                                                                                                                                                                                                                                                                                                                                                                                                   |
|---------------------------------|-------------------------------------------------------------------------------------------------------------------------------------------------------------------------------------------------------------------------------------------------------------------------------------------------------------------------------------------------------------------------------------------------------------------------------------------------------------------|
| <p><b>Admin Status</b></p>      | <p>Set Admin Status for the port to deal with LLDP packets.</p> <p>Tx&amp;Rx: The port will transmit LLDP packets and process the received LLDP packets.</p> <p>Rx_Only: The port will only process the received LLDP packets but not transmit LLDP packets.</p> <p>Tx_Only: The port will only transmit LLDP packets but not process the received LLDP packets.</p> <p>Disable: The port will not transmitLLDP packets or process the received LLDP packets.</p> |
| <p><b>Notification Mode</b></p> | <p>Select whether to enable SNMP on the port. If it is enabled, the local device will send Trap messages to inform the NMS when the local information changes.</p>                                                                                                                                                                                                                                                                                                |

- 2) Select the TLVs (Type/Length/Value) included in the LLDP packets according to your needs.

---

|                      |                                                                                                                                                                                                                                                                                                                                                                                                                                                                                                                                                                                                                                                                                                                                                                                                                                                                                                                                                                                                                                                                                                                                                                                                                                                                                                                                                                                                                                                                                                                                                                                                                          |
|----------------------|--------------------------------------------------------------------------------------------------------------------------------------------------------------------------------------------------------------------------------------------------------------------------------------------------------------------------------------------------------------------------------------------------------------------------------------------------------------------------------------------------------------------------------------------------------------------------------------------------------------------------------------------------------------------------------------------------------------------------------------------------------------------------------------------------------------------------------------------------------------------------------------------------------------------------------------------------------------------------------------------------------------------------------------------------------------------------------------------------------------------------------------------------------------------------------------------------------------------------------------------------------------------------------------------------------------------------------------------------------------------------------------------------------------------------------------------------------------------------------------------------------------------------------------------------------------------------------------------------------------------------|
| <b>Included TLVs</b> | <p>Configure the TLVs included in the outgoing LLDP packets.</p> <p>TP-Link supports the following TLVs:</p> <p>PD: Used to advertise the port description defined by the IEEE 802 LAN station.</p> <p>SC: Used to advertise the supported functions and whether or not these functions are enabled.</p> <p>SD: Used to advertise the system's description including the full name and version identification of the system's hardware type, software operating system, and networking software.</p> <p>SN: Used to advertise the system name.</p> <p>SA: Used to advertise the local device's management address to make it possible to be managed by SNMP.</p> <p>PV: Used to advertise the 802.1Q VLAN ID of the port.</p> <p>VP: Used to advertise the protocol VLAN ID of the port.</p> <p>VA: Used to advertise the name of the VLAN which the port is in.</p> <p>LA: Used to advertise whether the link is capable of being aggregated, whether the link is currently in an aggregation, and the port ID when it is in an aggregation.</p> <p>PS: Used to advertise the port's attributes including the duplex and bit-rate capability of the sending IEEE 802.3 LAN node that is connected to the physical medium, the current duplex and bit-rate settings of the sending IEEE 802.3 LAN node and whether these settings are the result of auto-negotiation during link initiation or of manual set override action.</p> <p>FS: Used to advertise the maximum frame size capability of the implemented MAC and PHY.</p> <p>PW: Used to advertise the port's PoE (Power over Ethernet) support capabilities.</p> |
|----------------------|--------------------------------------------------------------------------------------------------------------------------------------------------------------------------------------------------------------------------------------------------------------------------------------------------------------------------------------------------------------------------------------------------------------------------------------------------------------------------------------------------------------------------------------------------------------------------------------------------------------------------------------------------------------------------------------------------------------------------------------------------------------------------------------------------------------------------------------------------------------------------------------------------------------------------------------------------------------------------------------------------------------------------------------------------------------------------------------------------------------------------------------------------------------------------------------------------------------------------------------------------------------------------------------------------------------------------------------------------------------------------------------------------------------------------------------------------------------------------------------------------------------------------------------------------------------------------------------------------------------------------|

---

## 2.2 Using the CLI

### 2.2.1 Global Config

Enable the LLDP feature on the switch and configure the LLDP parameters.

---

|        |                                                       |
|--------|-------------------------------------------------------|
| Step 1 | <b>configure</b><br>Enter global configuration mode.  |
| Step 2 | <b>lldp</b><br>Enable the LLDP feature on the switch. |

---

|        |                                                                                                                                                                    |
|--------|--------------------------------------------------------------------------------------------------------------------------------------------------------------------|
| Step 3 | <b>lldp hold-multiplier</b>                                                                                                                                        |
|        | (Optional) Specify the amount of time the neighbor device should hold the received information before discarding it. The default is 4.                             |
|        | TTL (Time to Live) = Hold Multiplier * Transmit Interval.                                                                                                          |
| Step 4 | <b>lldp timer { tx-interval tx-interval   tx-delay tx-delay   reinit-delay reinit-delay   notify-interval notify-interval   fast-count fast-count }</b>            |
|        | (Optional) Configure the timers for LLDP packet forwarding.                                                                                                        |
|        | <i>tx-interval:</i> Enter the interval between successive LLDP packets that are periodically sent from the local device to its neighbors.                          |
|        | <i>tx-delay:</i> Specify the amount of time that the local device waits before sending another LLDP packet to its neighbors. The default is 2 seconds.             |
|        | <i>reinit-delay:</i> Specify the amount of time that the local device waits before sending another LLDP packet to its neighbors. The default is 2 seconds.         |
|        | <i>notify-interval:</i> Enter the interval between successive Trap messages that are periodically sent from the local device to the NMS. The default is 5 seconds. |
|        | <i>fast-count:</i> Specify the number of packets that the local port sends when its Admin Status changes. The default is 3.                                        |
| Step 5 | <b>show lldp</b>                                                                                                                                                   |
|        | Display the LLDP information.                                                                                                                                      |
| Step 6 | <b>end</b>                                                                                                                                                         |
|        | Return to Privileged EXEC Mode.                                                                                                                                    |
| Step 7 | <b>copy running-config startup-config</b>                                                                                                                          |
|        | Save the settings in the configuration file.                                                                                                                       |

The following example shows how to configure the following parameters, lldp timer=4, tx-interval=30 seconds, tx-delay=2 seconds, reinit-delay=3 seconds, notify-interval=5 seconds, fast-count=3.

```
Switch#configure
```

```
Switch(config)#lldp
```

```
Switch(config)#lldp hold-multiplier 4
```

```
Switch(config)#lldp timer tx-interval 30 tx-delay 2 reinit-delay 3 notify-interval 5 fast-count 3
```

```
Switch(config)#show lldp
```

```
LLDP Status: Enabled
```

```
Tx Interval: 30 seconds
```

TTL Multiplier: 4

Tx Delay: 2 seconds

Initialization Delay: 2 seconds

Trap Notification Interval: 5 seconds

Fast-packet Count: 3

LLDP-MED Fast Start Repeat Count: 4

**Switch(config)#end**

**Switch#copy running-config startup-config**

## 2.2.2 Port Config

Select the desired port and set its Admin Status, Notification Mode and the TLVs included in the LLDP packets.

|        |                                                                                                                                                                                                                                                                                 |
|--------|---------------------------------------------------------------------------------------------------------------------------------------------------------------------------------------------------------------------------------------------------------------------------------|
| Step 1 | <b>configure</b><br>Enter global configuration mode.                                                                                                                                                                                                                            |
| Step 2 | <b>interface {fastEthernet <i>port</i>   range fastEthernet <i>port-list</i>   gigabitEthernet <i>port</i>   range gigabitEthernet <i>port-list</i>   ten-gigabitEthernet <i>port</i>   range ten-gigabitEthernet <i>port-list</i> }</b><br>Enter interface configuration mode. |
| Step 3 | <b>lldp receive</b><br>(Optional) Set the mode for the port to receive LLDP packets. It is enabled by default.                                                                                                                                                                  |
| Step 4 | <b>lldp transmit</b><br>(Optional) Set the mode for the port to send LLDP packets. It is enabled by default.                                                                                                                                                                    |
| Step 5 | <b>lldp snmp-trap</b><br>(Optional) Enable the Notification Mode feature on the port. If it is enabled, the local device will send Trap messages to inform the SNMP server when local information changes. It is disabled by default.                                           |
| Step 6 | <b>lldp tlv-select</b><br>(Optional) Configure the TLVs included in the outgoing LLDP packets. By default, the outgoing LLDP packets include all TLVs.                                                                                                                          |
| Step 7 | <b>show lldp interface { fastEthernet <i>port</i>   gigabitEthernet <i>port</i>   ten-gigabitEthernet <i>port</i> }</b><br>Display LLDP configuration of the corresponding port.                                                                                                |
| Step 8 | <b>end</b><br>Return to Privileged EXEC Mode.                                                                                                                                                                                                                                   |
| Step 9 | <b>copy running-config startup-config</b><br>Save the settings in the configuration file.                                                                                                                                                                                       |



The following example shows how to configure the port 1/0/1. The port can receive and transmit LLDP packets, its notification mode is enabled and the outgoing LLDP packets include all TLVs.

```
Switch#configure
```

```
Switch(config)#lldp
```

```
Switch(config)#interface ten-gigabitEthernet 1/0/1
```

```
Switch(config-if)#lldp receive
```

```
Switch(config-if)#lldp transmit
```

```
Switch(config-if)#lldp snmp-trap
```

```
Switch(config-if)#lldp tlv-select all
```

```
Switch(config-if)#show lldp interface ten-gigabitEthernet 1/0/1
```

```
LLDP interface config:
```

```
ten-gigabitEthernet 1/0/1:
```

```
Admin Status: TxRx
```

```
SNMP Trap: Enabled
```

```
TLV Status
```

```
--- -----
```

|                    |     |
|--------------------|-----|
| Port-Description   | Yes |
| System-Capability  | Yes |
| System-Description | Yes |
| System-Name        | Yes |
| Management-Address | Yes |
| Port-VLAN-ID       | Yes |
| Protocol-VLAN-ID   | Yes |
| VLAN-Name          | Yes |
| Link-Aggregation   | Yes |
| MAC-Physic         | Yes |
| Max-Frame-Size     | Yes |
| Power              | Yes |

```
Switch(config-if)#end
```

```
Switch#copy running-config startup-config
```

# 3 LLDP-MED Configurations

With LLDP-MED configurations, you can:

- 1) Configure the LLDP-MED feature globally.
- 2) Enable and configure the LLDP-MED feature on the interface.

## Configuration Guidelines

LLDP-MED is used together with Voice VLAN to implement VoIP access. Besides the configuration of LLDP-MED feature, you also need configure the Voice VLAN feature. Refer to *Configuring Voice VLAN* for detailed instructions.

## 3.1 Using the GUI

### 3.1.1 Global Config

Choose the **LLDP > LLDP-MED > Global Config** to load the following page.

Figure 3-1 LLDP-MED Parameters Config

| LLDP-MED Parameters Config |                                       |                                      |
|----------------------------|---------------------------------------|--------------------------------------|
| Fast Start Count:          | <input type="text" value="4"/> (1-10) | <input type="button" value="Apply"/> |
| Device Class:              | Network Connectivity                  | <input type="button" value="Help"/>  |

Configure the Fast Start Count and view the current device class. Click **Apply**.

**Fast Start Count** Specify the number of successive LLDP-MED frames that the local device sends when fast start mechanism is activated. The default is 4.

If the LLDP-MED status on the port is changed from Disable to Enable, the fast start mechanism will be activated, and the local device will send the specified number of LLDP packets carrying LLDP-MED information. After that, the Transmit Interval will be restored to the specified value.

**Device Class** Display the current device class.

LLDP-MED defines two device classes, Network Connectivity Device and Endpoint Device. The switch is a Network Connectivity device.

### 3.1.2 Port Config

Choose the menu **LLDP > LLDP-MED > Policy Config** to load the following page.

Figure 3-2 LLDP-MED Port Config

| LLDP-MED Port Config                 |        |                                                                |                        |
|--------------------------------------|--------|----------------------------------------------------------------|------------------------|
| UNIT: <input type="text" value="1"/> |        |                                                                |                        |
| Select                               | Port   | LLDP-MED Status                                                | Included TLVs          |
| <input type="checkbox"/>             |        | <input type="text" value=""/> <input type="button" value="v"/> |                        |
| <input type="checkbox"/>             | 1/0/1  | Disable                                                        | <a href="#">Detail</a> |
| <input type="checkbox"/>             | 1/0/2  | Disable                                                        | <a href="#">Detail</a> |
| <input type="checkbox"/>             | 1/0/3  | Disable                                                        | <a href="#">Detail</a> |
| <input type="checkbox"/>             | 1/0/4  | Disable                                                        | <a href="#">Detail</a> |
| <input type="checkbox"/>             | 1/0/5  | Disable                                                        | <a href="#">Detail</a> |
| <input type="checkbox"/>             | 1/0/6  | Disable                                                        | <a href="#">Detail</a> |
| <input type="checkbox"/>             | 1/0/7  | Disable                                                        | <a href="#">Detail</a> |
| <input type="checkbox"/>             | 1/0/8  | Disable                                                        | <a href="#">Detail</a> |
| <input type="checkbox"/>             | 1/0/9  | Disable                                                        | <a href="#">Detail</a> |
| <input type="checkbox"/>             | 1/0/10 | Disable                                                        | <a href="#">Detail</a> |
| <input type="checkbox"/>             | 1/0/11 | Disable                                                        | <a href="#">Detail</a> |
| <input type="checkbox"/>             | 1/0/12 | Disable                                                        | <a href="#">Detail</a> |
| <input type="checkbox"/>             | 1/0/13 | Disable                                                        | <a href="#">Detail</a> |
| <input type="checkbox"/>             | 1/0/14 | Disable                                                        | <a href="#">Detail</a> |
| <input type="checkbox"/>             | 1/0/15 | Disable                                                        | <a href="#">Detail</a> |

Follow these steps to enable LLDP-MED:

- 1) Select the desired port and enable LLDP-MED. Click **Apply**.
- 2) Click **Detail** to enter the following page. Configure the TLVs included in the outgoing LLDP packets. If **Location Identification** is selected, you need configure the Emergency Number or select Civic Address to configure the details. Click **Apply**.

Figure 3-3 LLDP-MED Port Config-Detail

| Included TLVs                                      |                                                             |                                                            |
|----------------------------------------------------|-------------------------------------------------------------|------------------------------------------------------------|
| <input checked="" type="checkbox"/> Network Policy | <input checked="" type="checkbox"/> Location Identification | <input checked="" type="checkbox"/> Extended Power-Via-MDI |
| <input checked="" type="checkbox"/> Inventory      | <input checked="" type="checkbox"/> All                     |                                                            |

| Location Identification Parameters                |                                                |
|---------------------------------------------------|------------------------------------------------|
| <input type="checkbox"/> Emergency Number:        | <input type="text"/> Chars.(10-25)             |
| <input checked="" type="checkbox"/> Civic Address |                                                |
| What:                                             | <input type="text" value="Switch"/>            |
| Country Code:                                     | <input type="text" value="CN China(Default)"/> |
| Language:                                         | <input type="text"/>                           |
| Province/State:                                   | <input type="text"/>                           |
| County/Parish/District:                           | <input type="text"/>                           |
| City/Township:                                    | <input type="text"/>                           |
| Street:                                           | <input type="text"/>                           |
| House Number:                                     | <input type="text"/>                           |
| Name:                                             | <input type="text"/>                           |
| Postal/Zip Code:                                  | <input type="text"/>                           |
| Room Number:                                      | <input type="text"/>                           |
| Post Office Box:                                  | <input type="text"/>                           |
| Additional Information:                           | <input type="text"/>                           |

|                                |                                                                                                                                                                                                                                                                             |
|--------------------------------|-----------------------------------------------------------------------------------------------------------------------------------------------------------------------------------------------------------------------------------------------------------------------------|
| <b>Network Policy</b>          | Used to advertise VLAN configuration and the associated Layer 2 and Layer 3 attributes of the port to the Endpoint devices.                                                                                                                                                 |
| <b>Location Identification</b> | Used to assign the location identifier information to the Endpoint devices.<br>If this option is selected, you can configure the emergency number or the detailed address of the Endpoint device in the Location Identification Parameters section.                         |
| <b>Extended Power-Via-MDI</b>  | Used to advertise the detailed PoE information including power supply priority and supply status between LLDP-MED Endpoint devices and Network Connectivity devices.                                                                                                        |
| <b>Inventory</b>               | Used to advertise the inventory information. The Inventory TLV set contains seven basic Inventory management TLVs, that is, Hardware Revision TLV, Firmware Revision TLV, Software Revision TLV, Serial Number TLV, Manufacturer Name TLV, Model Name TLV and Asset ID TLV. |
| <b>Emergency Number</b>        | Configure the emergency number to call CAMA or PSAP. The number should contain 10-25 characters.                                                                                                                                                                            |

---

|                      |                                                                                                                                                                                                                                                                                                                                                |
|----------------------|------------------------------------------------------------------------------------------------------------------------------------------------------------------------------------------------------------------------------------------------------------------------------------------------------------------------------------------------|
| <b>Civic Address</b> | <p>Configure the address of the audio device in the IETF defined address format.</p> <p>What: Specify the role type of the local device, DHCP Server, Switch or LLDP-MED Endpoint.</p> <p>Country Code: Enter the country code defined by ISO 3166 , for example, CN, US.</p> <p>Language, Province/State etc.: Enter the regular details.</p> |
|----------------------|------------------------------------------------------------------------------------------------------------------------------------------------------------------------------------------------------------------------------------------------------------------------------------------------------------------------------------------------|

---

## 3.2 Using the CLI

### 3.2.1 Global Config

---

|        |                                                                                                                                                                                                                                                                                                                                                                                                    |
|--------|----------------------------------------------------------------------------------------------------------------------------------------------------------------------------------------------------------------------------------------------------------------------------------------------------------------------------------------------------------------------------------------------------|
| Step 1 | <p><b>configure</b></p> <p>Enter global configuration mode.</p>                                                                                                                                                                                                                                                                                                                                    |
| Step 2 | <p><b>lldp</b></p> <p>Enable the LLDP feature on the switch.</p>                                                                                                                                                                                                                                                                                                                                   |
| Step 3 | <p><b>lldp med-fast-count count</b></p> <p>(Optional) Specify the number of successive LLDP-MED frames that the local device sends when fast start mechanism is activated. When the fast start mechanism is activated, the local device will send the specified number of LLDP packets carrying LLDP-MED information.</p> <p><i>count</i>: The valid value are from 1 to 10. The default is 4.</p> |
| Step 4 | <p><b>show lldp</b></p> <p>Display the LLDP information.</p>                                                                                                                                                                                                                                                                                                                                       |
| Step 5 | <p><b>end</b></p> <p>Return to Privileged EXEC Mode.</p>                                                                                                                                                                                                                                                                                                                                           |
| Step 6 | <p><b>copy running-config startup-config</b></p> <p>Save the settings in the configuration file.</p>                                                                                                                                                                                                                                                                                               |

---

The following example shows how to configure LLDP-MED fast count as 4:

```
Switch#configure
```

```
Switch(config)#lldp
```

```
Switch(config)#lldp med-fast-count 4
```

```
Switch(config)#show lldp
```

```
LLDP Status:                Enabled
```

```
Tx Interval:                30 seconds
```

|                                   |           |
|-----------------------------------|-----------|
| TTL Multiplier:                   | 4         |
| Tx Delay:                         | 2 seconds |
| Initialization Delay:             | 2 seconds |
| Trap Notification Interval:       | 5 seconds |
| Fast-packet Count:                | 3         |
| LLDP-MED Fast Start Repeat Count: | 4         |

**Switch(config)#end**

**Switch#copy running-config startup-config**

### 3.2.2 Port Config

Select the desired port, enable LLDP-MED and select the TLVs (Type/Length/Value) included in the outgoing LLDP packets according to your needs.

|        |                                                                                                                                                                                                                                                                                                                                                                                                                                                                                                                                                                                                                                                                                                                                                                                                                                                                                                                                                                                                                                                                                                                                                                                                                                                                                     |
|--------|-------------------------------------------------------------------------------------------------------------------------------------------------------------------------------------------------------------------------------------------------------------------------------------------------------------------------------------------------------------------------------------------------------------------------------------------------------------------------------------------------------------------------------------------------------------------------------------------------------------------------------------------------------------------------------------------------------------------------------------------------------------------------------------------------------------------------------------------------------------------------------------------------------------------------------------------------------------------------------------------------------------------------------------------------------------------------------------------------------------------------------------------------------------------------------------------------------------------------------------------------------------------------------------|
| Step 1 | <b>configure</b><br>Enter global configuration mode.                                                                                                                                                                                                                                                                                                                                                                                                                                                                                                                                                                                                                                                                                                                                                                                                                                                                                                                                                                                                                                                                                                                                                                                                                                |
| Step 2 | <b>interface {fastEthernet <i>port</i>   range fastEthernet <i>port-list</i>   gigabitEthernet <i>port</i>   range gigabitEthernet <i>port-list</i>   ten-gigabitEthernet <i>port</i>   range ten-gigabitEthernet <i>port-list</i> }</b><br>Enter interface configuration mode.                                                                                                                                                                                                                                                                                                                                                                                                                                                                                                                                                                                                                                                                                                                                                                                                                                                                                                                                                                                                     |
| Step 3 | <b>lldp med-status</b><br>(Optional) Enable the LLDP-MED on the port. It is disabled by default.                                                                                                                                                                                                                                                                                                                                                                                                                                                                                                                                                                                                                                                                                                                                                                                                                                                                                                                                                                                                                                                                                                                                                                                    |
| Step 4 | <b>lldp med-tlv-select { [ inventory-management ] [ location ] [ network-policy ] [ power-management ] [ all ] }</b><br>(Optional) Configure the LLDP-MED TLVs included in the outgoing LLDP packets. By default, the outgoing LLDP packets include all TLVs.<br><br>If LLDP-MED Location TLV is selected, configure the parameters as follows:<br><b>lldp med-location { emergency-number <i>identifier</i>   civic-address [ language <i>language</i>   province-state <i>province-state</i>   lci-county-name <i>county</i>   lci-city <i>city</i>   street <i>street</i>   house-number <i>house-number</i>   name <i>name</i>   postal-zipcode <i>postal-zipcode</i>   room-number <i>room-number</i>   post-office-box <i>post-office-box</i>   additional <i>additional</i>   country-code <i>country-code</i>   what { dhcp-server   endpoint   switch } ] }</b><br><br>Configure the LLDP-MED Location TLV included in the outgoing LLDP packets. Used to assign the location identifier information to the Endpoint devices.<br><br><i>identifier</i> : Configure the emergency number to call CAMA or PSAP. The number should contain 10-25 characters.<br><br><i>language, province-state, county, etc.</i> : Configure the address in the IETF defined address format. |
| Step 5 | <b>show lldp interface { fastEthernet <i>port</i>   gigabitEthernet <i>port</i>   ten-gigabitEthernet <i>port</i> }</b><br>Display LLDP configuration of the corresponding port.                                                                                                                                                                                                                                                                                                                                                                                                                                                                                                                                                                                                                                                                                                                                                                                                                                                                                                                                                                                                                                                                                                    |

- 
- Step 6      **end**  
Return to Privileged EXEC Mode.
- 
- Step 7      **copy running-config startup-config**  
Save the settings in the configuration file.
- 

The following example shows how to enable LLDP-MED on port 1/0/1, configure the LLDP-MED TLVs included in the outgoing LLDP packets.

**Switch(config)#lldp**

**Switch(config)#lldp med-fast-count 4**

**Switch(config)#interface ten-gigabitEthernet 1/0/1**

**Switch(config-if)#lldp med-status**

**Switch(config-if)#lldp med-tlv-select all**

**Switch(config-if)#show lldp interface ten-gigabitEthernet 1/0/1**

LLDP interface config:

ten-gigabitEthernet 1/0/1:

Admin Status: TxRx

SNMP Trap: Enabled

TLV Status

--- -----

Port-Description                      Yes

System-Capability                    Yes

System-Description                  Yes

System-Name                          Yes

Management-Address Yes

Port-VLAN-ID Yes

Protocol-VLAN-ID Yes

VLAN-Name Yes

Link-Aggregation Yes

MAC-Physic Yes

Max-Frame-Size                      Yes

Power                                    Yes

LLDP-MED Status: Enabled

TLV Status

--- -----

Network Policy Yes

Location Identification Yes

Extended Power Via MDI Yes

Inventory Management Yes

**Switch(config)#end**

**Switch#copy running-config startup-config**



# 4 Viewing LLDP Settings

This chapter introduces how to view the LLDP settings on the local device.

## 4.1 Using GUI

### 4.1.1 Viewing LLDP Device Info

- Viewing the Local Info

Choose the menu **LLDP > Device Info > Local Info** to load the following page.

Figure 4-1 Local Info

**Auto Refresh**

Auto Refresh:  Enable  Disable

Refresh Rate:  sec(3-300)

**Local Info**

UNIT:

2

4

6

8

10

12

14

16

1

3

5

7

9

11

13

15

Unselected Port(s)

Selected Port(s)

Not Available for Selection

**Port 1/0/3**

|                                |                                                                |
|--------------------------------|----------------------------------------------------------------|
| Local Interface:               | 1/0/3                                                          |
| Chassis ID Subtype:            | MAC address                                                    |
| Chassis ID:                    | 98-DE-D0-FB-46-19                                              |
| Port ID Subtype:               | Interface name                                                 |
| Port ID:                       | TenGigabitEthernet1/0/3                                        |
| TTL:                           | 120                                                            |
| Port Description:              | TenGigabitEthernet1/0/3 Interface                              |
| System Name:                   | T1700X-16TS                                                    |
| System Description:            | JetStream 12-Port 10GBase-T Smart Switch with 4 10G SFP+ Slots |
| System Capabilities Supported: | Bridge Router                                                  |
| System Capabilities Enabled:   | Bridge Router                                                  |
| Management Address:            | 192.168.0.17                                                   |

Follow these steps to view the local information:

- 1) In the **Auto Refresh** section, enable the Auto Refresh feature and set the Refresh Rate according to your needs. Click **Apply**.
- 2) In the **Local Info** section, select the desired port and view its associated local device information.

|                               |                                                                                                           |
|-------------------------------|-----------------------------------------------------------------------------------------------------------|
| Local Interface               | Displays the local port ID.                                                                               |
| Chassis ID Subtype            | Displays the Chassis ID type.                                                                             |
| Chassis ID                    | Displays the value of the Chassis ID.                                                                     |
| Port ID Subtype               | Displays the Port ID type.                                                                                |
| Port ID                       | Displays the value of the Port ID.                                                                        |
| TTL                           | Specify the amount of time the neighbor device should hold the received information before discarding it. |
| Port Description              | Displays the description of the local port.                                                               |
| System Name                   | Displays the system name of the local device.                                                             |
| System Description            | Displays the system description of the local device.                                                      |
| System Capabilities Supported | Displays the supported capabilities of the local system.                                                  |
| System Capabilities Enabled   | Displays the primary functions of the local device.                                                       |
| Management Address            | Displays the management address of the local device.                                                      |

## ■ Viewing the Neighbor Info

Choose the menu **LLDP > Device Info > Neighbor Info** to load the following page.

Figure 4-2 Neighbor Info

**Auto Refresh**

Auto Refresh:  Enable  Disable

Refresh Rate:  sec(3-300)

---

UNIT:

2

4

6

8

10

12

14

16

1

3

5

7

9

11

Unselected Port(s)

Selected Port(s)

Not Available for Selection

---

**Port 1/0/1 Neighbor(s) Info**

| System Name                   | Chassis ID | System Description | Neighbor Port | Information |
|-------------------------------|------------|--------------------|---------------|-------------|
| <b>No entry in the table.</b> |            |                    |               |             |

Follow these steps to view the neighbor information:

- 1) In the **Auto Refresh** section, enable the Auto Refresh feature and set the Refresh Rate according to your needs. Click **Apply**.
- 2) In the **Local Info** section, select the desired port and view its associated neighbor device information.

|                           |                                                                                   |
|---------------------------|-----------------------------------------------------------------------------------|
| <b>System Name</b>        | Displays the system name of the neighbor device.                                  |
| <b>Chassis ID</b>         | Displays the Chassis ID of the neighbor device.                                   |
| <b>System Description</b> | Displays the system description of the neighbor device.                           |
| <b>Neighbor Port</b>      | Displays the port ID of the neighbor device which is connected to the local port. |
| <b>Information</b>        | Click to view the details of the neighbor device.                                 |

## 4.1.2 Viewing LLDP Statistics

Choose the menu **LLDP > Device Statistics > Statistics Info** to load the following page.

Figure 4-3 Static Info

**Auto Refresh**

Auto Refresh:  Enable  Disable Apply

Refresh Rate:  sec(3-300)

**Global Statistics**

| Last Update        | Total Inserts | Total Deletes | Total Drops | Total Ageouts |
|--------------------|---------------|---------------|-------------|---------------|
| 5 days 17h:40m:34s | 0             | 0             | 0           | 0             |

**Neighbors Statistics**

UNIT:

| Port  | Transmit Total | Receive Total | Discards | Errors | Ageouts | TLV Discards | TLV Unknowns |
|-------|----------------|---------------|----------|--------|---------|--------------|--------------|
| 1/0/1 | 0              | 0             | 0        | 0      | 0       | 0            | 0            |
| 1/0/2 | 3              | 0             | 0        | 0      | 0       | 0            | 0            |
| 1/0/3 | 0              | 0             | 0        | 0      | 0       | 0            | 0            |
| 1/0/4 | 29             | 0             | 0        | 0      | 0       | 0            | 0            |
| 1/0/5 | 0              | 0             | 0        | 0      | 0       | 0            | 0            |
| 1/0/6 | 0              | 0             | 0        | 0      | 0       | 0            | 0            |
| 1/0/7 | 0              | 0             | 0        | 0      | 0       | 0            | 0            |
| 1/0/8 | 0              | 0             | 0        | 0      | 0       | 0            | 0            |
| 1/0/9 | 0              | 0             | 0        | 0      | 0       | 0            | 0            |

Clear
Refresh
Help

Follow these steps to view LLDP statistics:

- 1) In the **Auto Refresh** section, enable the Auto Refresh feature and set the Refresh Rate according to your needs. Click **Apply**.
- 2) In the **Global Statistics** section, view the global statistics of the local device.

|                      |                                                                                 |
|----------------------|---------------------------------------------------------------------------------|
| <b>Last Update</b>   | Displays the time when the statistics updated.                                  |
| <b>Total Inserts</b> | Displays the latest number of neighbors the local device has created.           |
| <b>Total Deletes</b> | Displays the latest number of neighbors the local device has removed.           |
| <b>Total Drops</b>   | Displays the latest number of neighbors the local device has discarded.         |
| <b>Total Ageouts</b> | Displays the latest number of neighbors that have aged out on the local device. |

- 3) In the **Neighbors Statistics** section, view the statistics of the corresponding port.

---

|                |                                                                                          |
|----------------|------------------------------------------------------------------------------------------|
| Transmit Total | Displays the total number of the LLDP packets sent via the port.                         |
| Receive Total  | Displays the total number of the LLDP packets received via the port.                     |
| Discards       | Displays the total number of the LLDP packets discarded by the port.                     |
| Errors         | Displays the total number of the error LLDP packets received via the port.               |
| Ageouts        | Displays the number of the aged out neighbors that are connected to the port.            |
| TLV Discards   | Displays the total number of the TLVs discarded by the port when receiving LLDP packets. |
| TLV Unknowns   | Displays the total number of the unknown TLVs included in the received LLDP packets.     |

---

## 4.2 Using CLI

- Viewing the Local Info

---

```
show lldp local-information interface { fastEthernet port | gigabitEthernet port | ten-gigabitEthernet port }
```

View the LLDP details of a specific port or all the ports on the local device.

---

- Viewing the Neighbor Info

---

```
show lldp neighbor-information interface { fastEthernet port | gigabitEthernet port | ten gigabitEthernet port }
```

Display the information of the neighbor device which is connected to the port.

---

- Viewing LLDP Statistics

---

```
show lldp traffic interface { fastEthernet port | gigabitEthernet port | tengigabitEthernet port }
```

View the statistics of the corresponding port on the local device.

---

# 5 Viewing LLDP-MED Settings

## 5.1 Using GUI

- Viewing the Local Info

Choose the menu **LLDP > Device Info > Local Info** to load the following page.

Figure 5-1 LLDP-MED Local Info

**Auto Refresh**

Auto Refresh:  Enable  Disable

Refresh Rate:  sec(3-300)

**Local Info**

UNIT:

|                                     |                          |                          |                          |                          |                          |                          |                          |
|-------------------------------------|--------------------------|--------------------------|--------------------------|--------------------------|--------------------------|--------------------------|--------------------------|
| <input type="checkbox"/>            | <input type="checkbox"/> | <input type="checkbox"/> | <input type="checkbox"/> | <input type="checkbox"/> | <input type="checkbox"/> | <input type="checkbox"/> | <input type="checkbox"/> |
| <input type="checkbox"/>            | <input type="checkbox"/> | <input type="checkbox"/> | <input type="checkbox"/> | <input type="checkbox"/> | <input type="checkbox"/> | <input type="checkbox"/> | <input type="checkbox"/> |
| <input checked="" type="checkbox"/> | <input type="checkbox"/> | <input type="checkbox"/> | <input type="checkbox"/> | <input type="checkbox"/> | <input type="checkbox"/> | <input type="checkbox"/> | <input type="checkbox"/> |

Unselected Port(s)
  Selected Port(s)
  Not Available for Selection

**Port 1/0/1**

|                                |                      |
|--------------------------------|----------------------|
| Local Interface:               | 1/0/1                |
| Device Type:                   | Network Connectivity |
| Application Type:              | Reserved             |
| Unknown Policy Flag:           | Yes                  |
| VLAN tagged:                   | No                   |
| Media Policy VLAN ID:          | 0                    |
| Media Policy Layer 2 Priority: | 0                    |
| Media Policy DSCP:             | 0                    |

Follow these steps to view LLDP-MED local information:

- In the **Auto Refresh** section, enable the Auto Refresh feature and set the Refresh Rate according to your needs. Click **Apply**.
- In the **LLDP-MED Local Info** section, select the desired port and view the LLDP-MED settings.

---

|                        |                             |
|------------------------|-----------------------------|
| <b>Local Interface</b> | Displays the local port ID. |
|------------------------|-----------------------------|

---

|                               |                                                                            |
|-------------------------------|----------------------------------------------------------------------------|
| Device Type                   | Displays the local device type defined by LLDP-MED.LLDP-MED.               |
| Application Type              | Displays the supported applications of the local device.                   |
| Unknown Policy Flag           | Displays the unknown location settings included in the network policy TLV. |
| VLAN tagged                   | Displays the VLAN Tag type of the applications, tagged or untagged.        |
| Media Policy VLAN ID          | Displays the 802.1Q VLAN ID of the port.                                   |
| Media Policy Layer 2 Priority | Displays the Layer 2 priority used in the specific application.            |
| Media Policy DSCP             | Displays the DSCP value used in the specific application.                  |

■ Viewing the Neighbor Info

Choose the menu **LLDP > Device Info > Neighbor Info** to load the following page.

Figure 5-2 LLDP-MED Neighbor Info

Auto Refresh

Auto Refresh:  Enable  Disable

Refresh Rate:  sec(3-300)

UNIT:

|   |   |   |   |    |    |    |    |
|---|---|---|---|----|----|----|----|
| 2 | 4 | 6 | 8 | 10 | 12 | 14 | 16 |
| 1 | 3 | 5 | 7 | 9  | 11 | 13 | 15 |

Unselected Port(s)

Selected Port(s)

Not Available for Selection

Port 1/0/1 Neighbor(s) Info

| System Name                   | Chassis ID | System Description | Neighbor Port | Information |
|-------------------------------|------------|--------------------|---------------|-------------|
| <b>No entry in the table.</b> |            |                    |               |             |

Follow these steps to view LLDP-MED neighbor information:

- 1) In the **Auto Refresh** section, enable the Auto Refresh feature and set the Refresh Rate according to your needs. Click **Apply**.
- 2) In the **LLDP-MED Neighbor Info** section, select the desired port and view the LLDP-MED settings.

---

|                      |                                                           |
|----------------------|-----------------------------------------------------------|
| Device Type          | Displays the LLDP-MED device type of the neighbor device. |
| Application Type     | Displays the application type of the neighbor device.     |
| Location Data Format | Displays the location type of the neighbor device.        |
| Power Type           | Displays the power type of the neighbor device.           |
| Information          | View more LLDP-MED details of the neighbor device.        |

---

## 5.2 Using CLI

- Viewing the Local Info

---

```
show lldp local-information interface { fastEthernet port | gigabitEthernet port | ten-gigabitEthernet port }
```

View the LLDP details of a specific port or all the ports on the local device.

---

- Viewing the Neighbor Info

---

```
show lldp neighbor-information interface { fastEthernet port | gigabitEthernet port | ten-gigabitEthernet port }
```

Display the information of the neighbor device which is connected to the port.

---

- Viewing LLDP Statistics

---

```
show lldp traffic interface { fastEthernet port | gigabitEthernet port | ten-gigabitEthernet port }
```

View the statistics of the corresponding port.

---



# 6 Configuration Example

## 6.1 Example for Configuring LLDP

### 6.1.1 Network Requirements

The network administrator needs view the information of the devices in the company network to know about the link situation and network topology so that he can troubleshoot the potential network faults in advance.

### 6.1.2 Network Topology

Exemplified with the following situation:

Port Te1/0/1 on Switch A is directly connected to port Te1/0/2 on Switch B. Switch B is directly connected to the PC. The administrator can view the device information using the NMS.

Figure 6-1 LLDP Network Topology

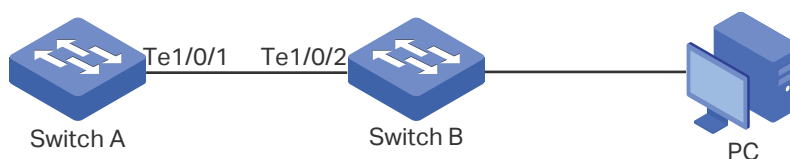

### 6.1.3 Configuration Scheme

LLDP can meet the network requirements. Enable the LLDP feature globally on Switch A and Switch B. Configure the related LLDP parameters on the corresponding ports.

Configuring Switch A and Switch B:

The configurations of Switch A and Switch B are similar. The following introductions take Switch A as an example. Demonstrated with T1700X-16TS, this chapter provides configuration procedures in two ways: using the GUI and using the CLI.

### 6.1.4 Using the GUI

- 1) Choose the menu **LLDP > Basic Config > Global Config** to load the following page. Enable LLDP globally and configure the related parameters. Here we take the default settings as an example.

Figure 6-2 LLDP Global Config

**Global Config**

LLDP:  Enable  Disable Apply

---

**Parameters Config**

Transmit Interval:  sec(5-32768)

Hold Multiplier:  (2-10)

Transmit Delay:  sec(1-8192) Apply

Reinit Delay:  sec(1-10) Help

Notification Interval:  sec(5-3600)

Fast Start Times:  (1-10)

- Choose the menu **LLDP > Basic Config > Port Config** to load the following page. Set the Admin Status of port Te1/0/1 to Tx&Rx, enable Notification Mode and configure all the TLVs included in the outgoing LLDP packets.

Figure 6-3 LLDP Port Config

**Port Config**

UNIT:

| Select                              | Port   | Admin Status | Notification Mode | Included TLVs                       |                                     |                                     |                                     |                                     |                                     |                                     |                                     |                                     |                                     |                                     |                                     |                                     |
|-------------------------------------|--------|--------------|-------------------|-------------------------------------|-------------------------------------|-------------------------------------|-------------------------------------|-------------------------------------|-------------------------------------|-------------------------------------|-------------------------------------|-------------------------------------|-------------------------------------|-------------------------------------|-------------------------------------|-------------------------------------|
| <input type="checkbox"/>            |        | Tx&Rx        | Enable            | <input checked="" type="checkbox"/> | <input checked="" type="checkbox"/> | <input checked="" type="checkbox"/> | <input checked="" type="checkbox"/> | <input checked="" type="checkbox"/> | <input checked="" type="checkbox"/> | <input checked="" type="checkbox"/> | <input checked="" type="checkbox"/> | <input checked="" type="checkbox"/> | <input checked="" type="checkbox"/> | <input checked="" type="checkbox"/> | <input checked="" type="checkbox"/> | <input checked="" type="checkbox"/> |
| <input checked="" type="checkbox"/> | 1/0/1  | Tx&Rx        | Enable            | PD                                  | SC                                  | SD                                  | SN                                  | SA                                  | PV                                  | VP                                  | VA                                  | LA                                  | PS                                  | FS                                  | PW                                  |                                     |
| <input type="checkbox"/>            | 1/0/2  | Tx&Rx        | Disable           | PD                                  | SC                                  | SD                                  | SN                                  | SA                                  | PV                                  | VP                                  | VA                                  | LA                                  | PS                                  | FS                                  | PW                                  |                                     |
| <input type="checkbox"/>            | 1/0/3  | Tx&Rx        | Disable           | PD                                  | SC                                  | SD                                  | SN                                  | SA                                  | PV                                  | VP                                  | VA                                  | LA                                  | PS                                  | FS                                  | PW                                  |                                     |
| <input type="checkbox"/>            | 1/0/4  | Tx&Rx        | Disable           | PD                                  | SC                                  | SD                                  | SN                                  | SA                                  | PV                                  | VP                                  | VA                                  | LA                                  | PS                                  | FS                                  | PW                                  |                                     |
| <input type="checkbox"/>            | 1/0/5  | Tx&Rx        | Disable           | PD                                  | SC                                  | SD                                  | SN                                  | SA                                  | PV                                  | VP                                  | VA                                  | LA                                  | PS                                  | FS                                  | PW                                  |                                     |
| <input type="checkbox"/>            | 1/0/6  | Tx&Rx        | Disable           | PD                                  | SC                                  | SD                                  | SN                                  | SA                                  | PV                                  | VP                                  | VA                                  | LA                                  | PS                                  | FS                                  | PW                                  |                                     |
| <input type="checkbox"/>            | 1/0/7  | Tx&Rx        | Disable           | PD                                  | SC                                  | SD                                  | SN                                  | SA                                  | PV                                  | VP                                  | VA                                  | LA                                  | PS                                  | FS                                  | PW                                  |                                     |
| <input type="checkbox"/>            | 1/0/8  | Tx&Rx        | Disable           | PD                                  | SC                                  | SD                                  | SN                                  | SA                                  | PV                                  | VP                                  | VA                                  | LA                                  | PS                                  | FS                                  | PW                                  |                                     |
| <input type="checkbox"/>            | 1/0/9  | Tx&Rx        | Enable            | PD                                  | SC                                  | SD                                  | SN                                  | SA                                  | PV                                  | VP                                  | VA                                  | LA                                  | PS                                  | FS                                  | PW                                  |                                     |
| <input type="checkbox"/>            | 1/0/10 | Tx&Rx        | Disable           | PD                                  | SC                                  | SD                                  | SN                                  | SA                                  | PV                                  | VP                                  | VA                                  | LA                                  | PS                                  | FS                                  | PW                                  |                                     |
| <input type="checkbox"/>            | 1/0/11 | Tx&Rx        | Disable           | PD                                  | SC                                  | SD                                  | SN                                  | SA                                  | PV                                  | VP                                  | VA                                  | LA                                  | PS                                  | FS                                  | PW                                  |                                     |
| <input type="checkbox"/>            | 1/0/12 | Tx&Rx        | Disable           | PD                                  | SC                                  | SD                                  | SN                                  | SA                                  | PV                                  | VP                                  | VA                                  | LA                                  | PS                                  | FS                                  | PW                                  |                                     |
| <input type="checkbox"/>            | 1/0/13 | Tx&Rx        | Disable           | PD                                  | SC                                  | SD                                  | SN                                  | SA                                  | PV                                  | VP                                  | VA                                  | LA                                  | PS                                  | FS                                  | PW                                  |                                     |
| <input type="checkbox"/>            | 1/0/14 | Tx&Rx        | Disable           | PD                                  | SC                                  | SD                                  | SN                                  | SA                                  | PV                                  | VP                                  | VA                                  | LA                                  | PS                                  | FS                                  | PW                                  |                                     |
| <input type="checkbox"/>            | 1/0/15 | Tx&Rx        | Disable           | PD                                  | SC                                  | SD                                  | SN                                  | SA                                  | PV                                  | VP                                  | VA                                  | LA                                  | PS                                  | FS                                  | PW                                  |                                     |

All
Apply
Help

### 6.1.5 Using CLI

- Enable LLDP globally and configure the corresponding parameters.

```
Switch_A#configure
Switch_A(config)#lldp
Switch_A(config)#lldp hold-multiplier 4
Switch_A(config)#lldp timer tx-interval 30 tx-delay 2 reinit-delay 3 notify-interval 5 fast-count 3
```

- 2) Set the Admin Status of port Te1/0/1 to Tx&Rx, enable Notification Mode and configure all the TLVs included in the outgoing LLDP packets.

```
Switch_A#configure
Switch_A(config)#interface ten-gigabitEthernet 1/0/1
Switch_A(config-if)#lldp receive
Switch_A(config-if)#lldp transmit
Switch_A(config-if)#lldp snmp-trap
Switch_A(config-if)#lldp tlv-select all
Switch_A(config-if)#end
Switch_A#copy running-config startup-config
```

## Verify the Configurations

### View LLDP settings globally

```
Switch_A#show lldp

LLDP Status:                Enabled
Tx Interval:                 30 seconds
TTL Multiplier:              4
Tx Delay:                    2 seconds
Initialization Delay:        2 seconds
Trap Notification Interval:   5 seconds
Fast-packet Count:           3
LLDP-MED Fast Start Repeat Count: 4
```

### View LLDP settings on each port

```
Switch_A#show lldp interface ten-gigabitEthernet 1/0/1

LLDP interface config:
ten-gigabitEthernet 1/0/1:
```

|                         |          |
|-------------------------|----------|
| Admin Status:           | TxRx     |
| SNMP Trap:              | Enabled  |
| TLV                     | Status   |
| ---                     | -----    |
| Port-Description        | Yes      |
| System-Capability       | Yes      |
| System-Description      | Yes      |
| System-Name             | Yes      |
| Management-Address      | Yes      |
| Port-VLAN-ID            | Yes      |
| Protocol-VLAN-ID        | Yes      |
| VLAN-Name               | Yes      |
| Link-Aggregation        | Yes      |
| MAC-Physic              | Yes      |
| Max-Frame-Size          | Yes      |
| Power                   | Yes      |
| LLDP-MED Status:        | Disabled |
| TLV                     | Status   |
| ---                     | -----    |
| Network Policy          | Yes      |
| Location Identification | Yes      |
| Extended Power Via MDI  | Yes      |
| Inventory Management    | Yes      |

### View the Local Info

```
Switch_A#show lldp local-information interface ten-gigabitEthernet 1/0/1
```

```
LLDP local Information:
```

```
ten-gigabitEthernet 1/0/1:
```

|               |                   |
|---------------|-------------------|
| Chassis type: | MAC address       |
| Chassis ID:   | 00:0A:EB:13:23:97 |
| Port ID type: | Interface name    |

|                                    |                                                                |
|------------------------------------|----------------------------------------------------------------|
| Port ID:                           | TenGigabitEthernet1/0/1                                        |
| Port description:                  | TenGigabitEthernet1/0/1 Interface                              |
| TTL:                               | 120                                                            |
| System name:                       | T1700X-16TS                                                    |
| System description:                | JetStream 12-Port 10GBase-T Smart Switch with 4 10G SFP+ Slots |
| System capabilities supported:     | Bridge Router                                                  |
| System capabilities enabled:       | Bridge Router                                                  |
| Management address type:           | ipv4                                                           |
| Management address:                | 192.168.0.1                                                    |
| Management address interface type: | IfIndex                                                        |
| Management address interface ID:   | 1                                                              |
| Management address OID:            | 0                                                              |
| Port VLAN ID(PVID):                | 1                                                              |
| Port and protocol VLAN ID(PPVID):  | 0                                                              |
| Port and protocol VLAN supported:  | Yes                                                            |
| Port and protocol VLAN enabled:    | No                                                             |
| VLAN name of VLAN 1:               | System-VLAN                                                    |
| Protocol identity:                 |                                                                |
| Auto-negotiation supported:        | Yes                                                            |
| Auto-negotiation enabled:          | Yes                                                            |
| OperMau:                           | speed(10000)/duplex(Full)                                      |
| Link aggregation supported:        | Yes                                                            |
| Link aggregation enabled:          | No                                                             |
| Aggregation port ID:               | 0                                                              |
| Power port class:                  | PD                                                             |
| PSE power supported:               | No                                                             |
| PSE power enabled:                 | No                                                             |
| PSE pairs control ability:         | No                                                             |
| Maximum frame size:                | 1518                                                           |

|                        |                                   |
|------------------------|-----------------------------------|
| LLDP-MED Capabilities: | Capabilities                      |
|                        | Network Policy                    |
|                        | Location Identification           |
|                        | Inventory                         |
| Device Type:           | Network Connectivity              |
| Application type:      | Reserved                          |
| Unknown policy:        | Yes                               |
| Tagged:                | No                                |
| VLAN ID:               | 0                                 |
| Layer 2 Priority:      | 0                                 |
| DSCP:                  | 0                                 |
| Location Data Format:  | Civic Address LCI                 |
| - What:                | Switch                            |
| - Country Code:        | CN                                |
| Hardware Revision:     | T1700X-16TS 2.0                   |
| Firmware Revision:     | Reserved                          |
| Software Revision:     | 2.0.0 Build 20160905 Rel.74744(s) |
| Serial Number:         | Reserved                          |
| Manufacturer Name:     | TP-Link                           |
| Model Name:            | T1700X-16TS 2.0                   |
| Asset ID:              | unknown                           |

### View the Neighbor Info

```
Switch_A#show lldp neighbor-information interface ten-gigabitEthernet 1/0/1
```

LLDP Neighbor Information:

ten-gigabitEthernet 1/0/1:

Neighbor index 1:

|               |                      |
|---------------|----------------------|
| Chassis type: | MAC address          |
| Chassis ID:   | 00:0A:EB:13:18:2D    |
| Port ID type: | Interface name       |
| Port ID:      | GigabitEthernet1/0/2 |

|                                    |                                                                   |
|------------------------------------|-------------------------------------------------------------------|
| Port description:                  | GigabitEthernet1/0/2 Interface                                    |
| TTL:                               | 120                                                               |
| System name:                       | T1700X-16TS                                                       |
| System description:                | JetStream 12-Port 10GBase-T Smart Switch with 4 10G<br>SFP+ Slots |
| System capabilities supported:     | Bridge Router                                                     |
| System capabilities enabled:       | Bridge Router                                                     |
| Management address type:           | ipv4                                                              |
| Management address:                | 192.168.0.1                                                       |
| Management address interface type: | IfIndex                                                           |
| Management address interface ID:   | 1                                                                 |
| Management address OID:            | 0                                                                 |
| Port VLAN ID(PVID):                | 1                                                                 |
| Port and protocol VLAN ID(PPVID):  | 0                                                                 |
| Port and protocol VLAN supported:  | Yes                                                               |
| Port and protocol VLAN enabled:    | No                                                                |
| VLAN name of VLAN 1:               | System-VLAN                                                       |
| Protocol identity:                 |                                                                   |
| Auto-negotiation supported:        | Yes                                                               |
| Auto-negotiation enabled:          | Yes                                                               |
| OperMau:                           | speed(10000)/duplex(Full)                                         |
| Link aggregation supported:        | Yes                                                               |
| Link aggregation enabled:          | No                                                                |
| Aggregation port ID:               | 0                                                                 |
| Power port class:                  | PSE                                                               |
| PSE power supported:               | Yes                                                               |
| PSE power enabled:                 | Yes                                                               |
| PSE pairs control ability:         | No                                                                |

## 6.2 Example for Configuring LLDP-MED

### 6.2.1 Network Requirements

The marketing department needs establish the voice conversation with the field office. They want to install IP phones in their office and meet the following requirements:

- Save the switch ports for more IP phones due to the limited number of the ports on the switch in the office;
- The voice traffic is transmitted in a separate VLAN to guarantee the voice quality.
- The IP phones can finish the Voice VLAN configuration automatically to minimize the configuration effort.

### 6.2.2 Configuration Scheme

To save the limited ports on the switch, connect the IP phone and the PC in a series, then the IP phone and PC can share the same port on the switch.

Configure LLDP-MED to work together with Voice VLAN to guarantee the voice quality and reduce the configuration effort. Configure the port which the IP phone is connected with, then IP phone can automatically finish its Voice VLAN configuration using the received LLDP-MED packets and send tagged voice packets to the switch. Voice packets will be transmitted in the Voice VLAN while other traffic will be transmitted in the default VLAN. Please note that the PVID of the port which the IP phone is connected with cannot be the same as the VLAN ID of the Voice VLAN. Refer to [Configuring Voice VLAN](#) for detailed instructions.

### 6.2.3 Network Topology

Demonstrated with the configuration of one IP phone:

One end of the IP phone is connected to the PC, the other end is connect to port Te1/0/1 on the switch. Port Te1/0/2 on the switch is connect to the voice gateway.

Figure 6-4 LLDP-MED Network Topology

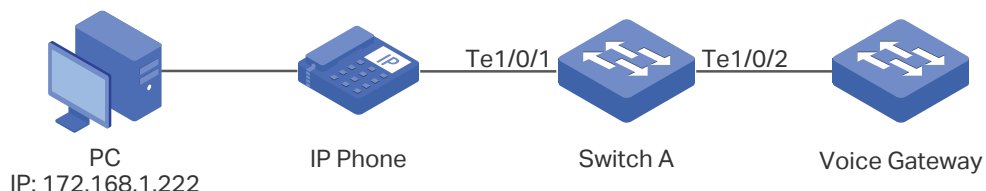

To ensure the voice traffic can be preferentially treated, configure the corresponding settings on each device in the link. Demonstrated with T1700X-16TS, this section provides configuration procedures in two ways: using the GUI and using the CLI.



## 6.2.4 Using the GUI

- 1) Choose the menu **VLAN > 802.1Q VLAN > VLAN Config** to load the following page. Create VLAN 10, and name it as Voice VLAN.

Figure 6-5 Creating a VLAN

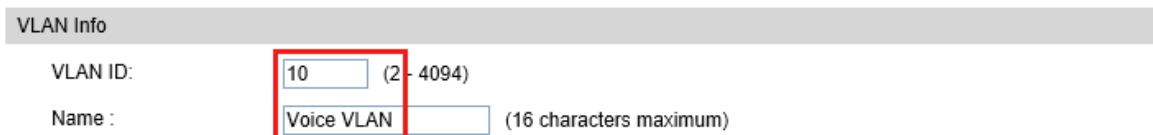

**VLAN Info**

VLAN ID:  (2 - 4094)

Name :  (16 characters maximum)

- 2) Enable and configure the Voice VLAN.

Choose the menu **QoS > Voice VLAN > Global Config**, enable Voice VLAN and set the VLAN ID to 10.

Figure 6-6 Configuring Voice VLAN Globally

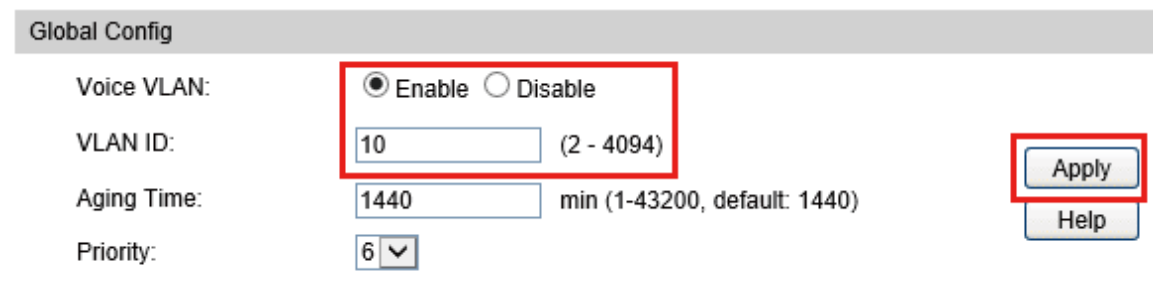

**Global Config**

Voice VLAN:  Enable  Disable

VLAN ID:  (2 - 4094)

Aging Time:  min (1-43200, default: 1440)

Priority:  ▼

Choose the menu **QoS > Voice VLAN > Port Config**, set the Voice VLAN mode on Te1/0/1 and Te1/0/2 as Auto and Manual respectively.

Figure 6-7 Configuring Voice VLAN Mode on Port 1/0/1

Port Config

UNIT: 1 LAGS

| Select                              | Port   | Port Mode | Security Mode | Member State | LAG |
|-------------------------------------|--------|-----------|---------------|--------------|-----|
| <input type="checkbox"/>            |        | Auto      | Enable        |              |     |
| <input checked="" type="checkbox"/> | 1/0/1  | Auto      | Disable       | Inactive     | --- |
| <input type="checkbox"/>            | 1/0/2  | Auto      | Disable       | Inactive     | --- |
| <input type="checkbox"/>            | 1/0/3  | Auto      | Disable       | Inactive     | --- |
| <input type="checkbox"/>            | 1/0/4  | Auto      | Disable       | Inactive     | --- |
| <input type="checkbox"/>            | 1/0/5  | Auto      | Disable       | Inactive     | --- |
| <input type="checkbox"/>            | 1/0/6  | Auto      | Disable       | Inactive     | --- |
| <input type="checkbox"/>            | 1/0/7  | Auto      | Disable       | Inactive     | --- |
| <input type="checkbox"/>            | 1/0/8  | Auto      | Disable       | Inactive     | --- |
| <input type="checkbox"/>            | 1/0/9  | Auto      | Disable       | Inactive     | --- |
| <input type="checkbox"/>            | 1/0/10 | Auto      | Disable       | Inactive     | --- |
| <input type="checkbox"/>            | 1/0/11 | Auto      | Disable       | Inactive     | --- |
| <input type="checkbox"/>            | 1/0/12 | Auto      | Disable       | Inactive     | --- |
| <input type="checkbox"/>            | 1/0/13 | Auto      | Disable       | Inactive     | --- |
| <input type="checkbox"/>            | 1/0/14 | Auto      | Disable       | Inactive     | --- |
| <input type="checkbox"/>            | 1/0/15 | Auto      | Disable       | Inactive     | --- |

Figure 6-8 Configuring Voice VLAN Mode on Port 1/0/2

Port Config

UNIT: 1 LAGS

| Select                              | Port   | Port Mode | Security Mode | Member State | LAG |
|-------------------------------------|--------|-----------|---------------|--------------|-----|
| <input type="checkbox"/>            |        | Manual    |               |              |     |
| <input type="checkbox"/>            | 1/0/1  | Auto      | Enable        | Inactive     | --- |
| <input checked="" type="checkbox"/> | 1/0/2  | Auto      | Disable       | Inactive     | --- |
| <input type="checkbox"/>            | 1/0/3  | Auto      | Disable       | Inactive     | --- |
| <input type="checkbox"/>            | 1/0/4  | Auto      | Disable       | Inactive     | --- |
| <input type="checkbox"/>            | 1/0/5  | Auto      | Disable       | Inactive     | --- |
| <input type="checkbox"/>            | 1/0/6  | Auto      | Disable       | Inactive     | --- |
| <input type="checkbox"/>            | 1/0/7  | Auto      | Disable       | Inactive     | --- |
| <input type="checkbox"/>            | 1/0/8  | Auto      | Disable       | Inactive     | --- |
| <input type="checkbox"/>            | 1/0/9  | Auto      | Disable       | Inactive     | --- |
| <input type="checkbox"/>            | 1/0/10 | Auto      | Disable       | Inactive     | --- |
| <input type="checkbox"/>            | 1/0/11 | Auto      | Disable       | Inactive     | --- |
| <input type="checkbox"/>            | 1/0/12 | Auto      | Disable       | Inactive     | --- |
| <input type="checkbox"/>            | 1/0/13 | Auto      | Disable       | Inactive     | --- |
| <input type="checkbox"/>            | 1/0/14 | Auto      | Disable       | Inactive     | --- |
| <input type="checkbox"/>            | 1/0/15 | Auto      | Disable       | Inactive     | --- |

Choose the menu **VLAN > 802.1Q VLAN > VLAN Config** to load the following page. Add port 1/0/2 to the Voice VLAN.

Figure 6-9 Adding Port 1/0/2 to the Voice VLAN

The screenshot shows the 'VLAN Info' configuration page. The 'VLAN ID' is set to 10 (range 2-4094) and the 'Name' is 'Voice VLAN' (16 characters maximum). Below this are two sections for port configuration:

- Untagged port:** UNIT: 1 LAGS. A grid of port buttons (1-16) is shown. Port 2 is highlighted with a blue border.
- Tagged port:** UNIT: 1 LAGS. A grid of port buttons (1-16) is shown. Port 2 is highlighted with a blue border and a red box.

Buttons for 'All', 'Clear', 'Apply', and 'Help' are visible at the bottom of the port selection area. A legend at the bottom indicates: Unselected Port(s) (white box), Selected Port(s) (blue box), and Not Available for Selection (grey box).

- 3) Choose the **LLDP > Basic Config > Global Config** to load the following page and enable LLDP globally.

Figure 6-10 LLDP Global Config

The screenshot shows the 'Global Config' page for LLDP. The 'LLDP' status is set to 'Enable' (radio button selected), with 'Disable' as an option. The 'Apply' button is highlighted with a red box.

- 4) Choose the **LLDP > LLDP-MED > Global Config** to load the following page and configure the fast start count. The default is 4.

Figure 6-11 LLDP-MED Global Config

The screenshot shows the 'LLDP-MED Parameters Config' page. The 'Fast Start Count' is set to 4 (range 1-10). The 'Device Class' is set to 'Network Connectivity'. The 'Apply' and 'Help' buttons are visible.

- 5) Choose the menu **LLDP > LLDP-MED > Policy Config** to load the following page. Select port 1/0/1 and enable LLDP-MED.

Figure 6-12 LLDP-MED Port Config

| LLDP-MED Port Config                |        |                                         |                        |
|-------------------------------------|--------|-----------------------------------------|------------------------|
| UNIT: 1                             |        |                                         |                        |
| Select                              | Port   | LLDP-MED Status                         | Included TLVs          |
| <input type="checkbox"/>            |        | Enable <input type="button" value="v"/> |                        |
| <input checked="" type="checkbox"/> | 1/0/1  | Enable                                  | <a href="#">Detail</a> |
| <input type="checkbox"/>            | 1/0/2  | Disable                                 | <a href="#">Detail</a> |
| <input type="checkbox"/>            | 1/0/3  | Disable                                 | <a href="#">Detail</a> |
| <input type="checkbox"/>            | 1/0/4  | Disable                                 | <a href="#">Detail</a> |
| <input type="checkbox"/>            | 1/0/5  | Disable                                 | <a href="#">Detail</a> |
| <input type="checkbox"/>            | 1/0/6  | Disable                                 | <a href="#">Detail</a> |
| <input type="checkbox"/>            | 1/0/7  | Disable                                 | <a href="#">Detail</a> |
| <input type="checkbox"/>            | 1/0/8  | Disable                                 | <a href="#">Detail</a> |
| <input type="checkbox"/>            | 1/0/9  | Disable                                 | <a href="#">Detail</a> |
| <input type="checkbox"/>            | 1/0/10 | Disable                                 | <a href="#">Detail</a> |
| <input type="checkbox"/>            | 1/0/11 | Disable                                 | <a href="#">Detail</a> |
| <input type="checkbox"/>            | 1/0/12 | Disable                                 | <a href="#">Detail</a> |
| <input type="checkbox"/>            | 1/0/13 | Disable                                 | <a href="#">Detail</a> |
| <input type="checkbox"/>            | 1/0/14 | Disable                                 | <a href="#">Detail</a> |
| <input type="checkbox"/>            | 1/0/15 | Disable                                 | <a href="#">Detail</a> |

Click **Detail** in the Port 1/0/1 entry to configure TLVs included in the outgoing LLDP-MED packets.

Figure 6-13 LLDP-MED Port Config-Detail

| Included TLVs                                      |                                                             |                                                            |
|----------------------------------------------------|-------------------------------------------------------------|------------------------------------------------------------|
| <input checked="" type="checkbox"/> Network Policy | <input checked="" type="checkbox"/> Location Identification | <input checked="" type="checkbox"/> Extended Power-Via-MDI |
| <input checked="" type="checkbox"/> Inventory      | <input checked="" type="checkbox"/> All                     |                                                            |

In the Location Identification Parameters section, configure the detailed address of the IP phone. Click **Apply**.

Figure 6-14 Configure the detailed address of the IP phone

| Included TLVs                                      |                                                             |                                                            |
|----------------------------------------------------|-------------------------------------------------------------|------------------------------------------------------------|
| <input checked="" type="checkbox"/> Network Policy | <input checked="" type="checkbox"/> Location Identification | <input checked="" type="checkbox"/> Extended Power-Via-MDI |
| <input checked="" type="checkbox"/> Inventory      | <input checked="" type="checkbox"/> All                     |                                                            |

| Location Identification Parameters                |                                                |
|---------------------------------------------------|------------------------------------------------|
| <input type="checkbox"/> Emergency Number:        | <input type="text"/> Chars.(10-25)             |
| <input checked="" type="checkbox"/> Civic Address |                                                |
| What:                                             | <input type="text" value="Switch"/>            |
| Country Code:                                     | <input type="text" value="CN China(Default)"/> |
| Language:                                         | <input type="text"/>                           |
| Province/State:                                   | <input type="text"/>                           |
| County/Parish/District:                           | <input type="text"/>                           |
| City/Township:                                    | <input type="text"/>                           |
| Street:                                           | <input type="text"/>                           |
| House Number:                                     | <input type="text"/>                           |
| Name:                                             | <input type="text"/>                           |
| Postal/Zip Code:                                  | <input type="text"/>                           |
| Room Number:                                      | <input type="text"/>                           |
| Post Office Box:                                  | <input type="text"/>                           |
| Additional Information:                           | <input type="text"/>                           |

## 6.2.5 Using the CLI

- 1) Create VLAN 10 and name it as Voice VLAN.

```
Switch_A(config)#vlan 10
```

```
Switch_A(config-vlan)#name Voice_VLAN
```

```
Switch_A(config)#voice vlan 10
```

- 2) Configure the Voice VLAN mode on port Te1/0/1 as Auto.

```
Switch_A(config)#interface ten-gigabitEthernet 1/0/1
```

```
Switch_A(config-if)#switchport voice vlan mode auto
```

```
Switch_A(config-if)#exit
```

- 3) Configure the Voice VLAN mode on port Te1/0/2 as Manual and add port Te1/0/2 to Voice VLAN.

```
Switch_A(config)#interface ten-gigabitEthernet 1/0/2
```

```
Switch_A(config-if)#switchport voice vlan mode manual
```

```
Switch_A(config-if)#switchport general allowed vlan 10 tagged
```

```
Switch_A(config-if)#exit
```

- 4) Enable LLDP globally.

```
Switch_A(config)#lldp
```

- 5) Configure the fast start count of LLDP-MED. The default is 4.

```
Switch_A(config)#lldp med-fast-count 4
```

- 6) Enable the LLDP-MED on port Te1/0/1.

```
Switch_A(config)#interface ten-gigabitEthernet 1/0/1
```

```
Switch_A(config-if)#lldp med-status
```

- 7) Configure the LLDP-MED TLVs included in the outgoing LLDP packets.

```
Switch_A(config-if)#lldp med-tlv-select all
```

- 8) Configure the detailed address of the IP phone.

```
Switch_A(config-if)#lldp med-location civic-address language English Ici-city  
Vancouver street X east hastings street postal-zipcode V6A 1P9
```

## Verify the Configurations

### View global LLDP-MED settings:

```
Switch_A#show lldp
```

```
LLDP Status:                Enabled
Tx Interval:                 30 seconds
TTL Multiplier:              4
Tx Delay:                    2 seconds
Initialization Delay:        2 seconds
Trap Notification Interval:   5 seconds
Fast-packet Count:           3
LLDP-MED Fast Start Repeat Count: 4
```

### View LLDP-MED settings on each port:

```
Switch_A#show lldp interface ten-gigabitEthernet 1/0/1
```

```
LLDP interface config:
```

```
ten-gigabitEthernet 1/0/1:
```

|                         |         |
|-------------------------|---------|
| Admin Status:           | TxRx    |
| SNMP Trap:              | Enabled |
| TLV                     | Status  |
| ---                     | -----   |
| Port-Description        | Yes     |
| System-Capability       | Yes     |
| System-Description      | Yes     |
| System-Name             | Yes     |
| Management-Address      | Yes     |
| Port-VLAN-ID            | Yes     |
| Protocol-VLAN-ID        | Yes     |
| VLAN-Name               | Yes     |
| Link-Aggregation        | Yes     |
| MAC-Physic              | Yes     |
| Max-Frame-Size          | Yes     |
| Power                   | Yes     |
| LLDP-MED Status:        | Enabled |
| TLV                     | Status  |
| ---                     | -----   |
| Network Policy          | Yes     |
| Location Identification | Yes     |
| Extended Power Via MDI  | Yes     |
| Inventory Management    | Yes     |

**View the local information:**

```
Switch_A#show lldp local-information interface ten-gigabitEthernet 1/0/1
```

```
LLDP local Information:
```

```
ten-gigabitEthernet 1/0/1:
```

|               |                   |
|---------------|-------------------|
| Chassis type: | MAC address       |
| Chassis ID:   | 00:0A:EB:13:23:97 |
| Port ID type: | Interface name    |

|                                    |                                                                   |
|------------------------------------|-------------------------------------------------------------------|
| Port ID:                           | TenGigabitEthernet1/0/1                                           |
| Port description:                  | TenGigabitEthernet1/0/1 Interface                                 |
| TTL:                               | 120                                                               |
| System name:                       | Switch                                                            |
| System description:                | JetStream 12-Port 10GBase-T Smart Switch with 4<br>10G SFP+ Slots |
| System capabilities supported:     | Bridge Router                                                     |
| System capabilities enabled:       | Bridge Router                                                     |
| Management address type:           | ipv4                                                              |
| Management address:                | 192.168.0.226                                                     |
| Management address interface type: | IfIndex                                                           |
| Management address interface ID:   | 1                                                                 |
| Management address OID:            | 0                                                                 |
| Port VLAN ID(PVID):                | 1                                                                 |
| Port and protocol VLAN ID(PPVID):  | 0                                                                 |
| Port and protocol VLAN supported:  | Yes                                                               |
| Port and protocol VLAN enabled:    | No                                                                |
| VLAN name of VLAN 1:               | System-VLAN                                                       |
| Protocol identity:                 |                                                                   |
| Auto-negotiation supported:        | Yes                                                               |
| Auto-negotiation enabled:          | Yes                                                               |
| OperMau:                           | speed(100)/duplex(Full)                                           |
| Link aggregation supported:        | Yes                                                               |
| Link aggregation enabled:          | Yes                                                               |
| Aggregation port ID:               | 1                                                                 |
| Power port class:                  | PD                                                                |
| PSE power supported:               | No                                                                |
| PSE power enabled:                 | No                                                                |
| PSE pairs control ability:         | No                                                                |
| Maximum frame size:                | 1518                                                              |



|                           |                                   |
|---------------------------|-----------------------------------|
| LLDP-MED Capabilities:    | Capabilities                      |
|                           | Network Policy                    |
|                           | Location Identification           |
|                           | Inventory                         |
| Device Type:              | Network Connectivity              |
| Application type:         | Reserved                          |
| Unknown policy:           | Yes                               |
| Tagged:                   | No                                |
| VLAN ID:                  | 0                                 |
| Layer 2 Priority:         | 0                                 |
| DSCP:                     | 0                                 |
| Location Data Format:     | Civic Address LCI                 |
| - What:                   | Switch                            |
| - Country Code:           | CN                                |
| - Language:               | chinese                           |
| - Province/State:         | Guangdong                         |
| - County/Parish/District: | China                             |
| - City/Township:          | Shenzhen                          |
| - Street:                 | Keyuan Road                       |
| - Name:                   | South Building No.5               |
| - Postal/Zip Code:        | 518057                            |
| Hardware Revision:        | T1700X-16TS 2.0                   |
| Firmware Revision:        | Reserved                          |
| Software Revision:        | 2.0.0 Build 20160909 Rel.52515(s) |
| Serial Number:            | Reserved                          |
| Manufacturer Name:        | TP-Link                           |
| Model Name:               | T1700X-16TS 2.0                   |
| Asset ID:                 | unknown                           |

**View the neighbor information:**

```
Switch_A#show lldp neighbor-information interface ten-gigabitEthernet 1/0/1
```

## LLDP Neighbor Information:

ten-gigabitEthernet 1/0/1:

## Neighbor index 1:

|                                    |                                       |
|------------------------------------|---------------------------------------|
| Chassis type:                      | Network address                       |
| Chassis ID:                        | 192.168.1.117                         |
| Port ID type:                      | Locally assigned                      |
| Port ID:                           | 64A0E714DC54:P1                       |
| Port description:                  | SW PORT                               |
| TTL:                               | 180                                   |
| System name:                       | SEP64A0E714DC54                       |
| System description:                | Cisco IP Phone 7931G,V4, term default |
| System capabilities supported:     | Bridge Telephone                      |
| System capabilities enabled:       | Bridge Telephone                      |
| Management address type:           | ipv4                                  |
| Management address:                | 192.168.1.117                         |
| Management address interface type: | UnKnown                               |
| Port VLAN ID(PVID):                |                                       |
| Port and protocol VLAN ID(PPVID):  |                                       |
| Port and protocol VLAN supported:  |                                       |
| Port and protocol VLAN enabled:    |                                       |
| Protocol identity:                 |                                       |
| Auto-negotiation supported:        | Yes                                   |
| Auto-negotiation enabled:          | Yes                                   |
| OperMau:                           | speed(100)/duplex(Full)               |
| Link aggregation supported:        |                                       |
| Link aggregation enabled:          |                                       |
| Aggregation port ID:               |                                       |
| Power port class:                  |                                       |
| PSE power supported:               |                                       |
| PSE power enabled:                 |                                       |

PSE pairs control ability:

Maximum frame size:

LLDP-MED Capabilities:           Capabilities  
                                          Network Policy  
                                          Extended Power via MDI - PD  
                                          Inventory

Device Type:                        Endpoint Class III

Application type:                   Voice

Unknown policy:                    No

Tagged:                              No

VLAN ID:                             4095

Layer 2 Priority:                    5

DSCP:                                46

Application type:                   Voice Signaling

Unknown policy:                    No

Tagged:                              No

VLAN ID:                             4095

Layer 2 Priority:                    4

DSCP:                                32

Power Type:                         PD Device

Power Source:                       Unknown

Power Priority:                      Unknown

Power Value:                        7.0w

Hardware Revision:                 4

Firmware Revision:                 tnp31.3-2-0-11.bin

Software Revision:                 term31.default

Serial Number:                      FCH1537A2JV

Manufacturer Name:                 Cisco Systems, Inc.

# 7 Appendix: Default Parameters

Default settings of LLDP are listed in the following tables.

## Default LLDP Settings

Table 7-1 Default LLDP Settings

| Parameter             | Default Setting |
|-----------------------|-----------------|
| LLDP                  | Disable         |
| Transmit Interval     | 30 seconds      |
| Hold Multiplier       | 4               |
| Transmit Delay        | 2 seconds       |
| Reinit Delay          | 2 seconds       |
| Notification Interval | 5 seconds       |
| Fast Start Times      | 3               |

Table 7-2 Default LLDP Settings on the Port

| Parameter         | Default Setting |
|-------------------|-----------------|
| Admin Status      | Tx&Rx           |
| Notification Mode | Disable         |
| Included TLVs     | All             |

## Default LLDP-MED Settings

Table 7-3 Default LLDP-MED Settings

| Parameter        | Default Setting |
|------------------|-----------------|
| Fast Start Count | 4               |
| LLDP-MED Status  | Disable         |
| Included TLVs    | All             |

# Part 22

## Configuring Maintenance

### CHAPTERS

1. Maintenance
2. Monitoring the System
3. System Log Configurations
4. Diagnosing the Device
5. Diagnosing the Network
6. Configuration Example for Remote Log
7. Appendix: Default Parameters

# 1 Maintenance

## 1.1 Overview

The maintenance module assembles various system tools for network troubleshooting.

## 1.2 Supported Features

The maintenance module includes system monitor, log, device diagnose, and network diagnose.

### System Monitor

You can monitor the memory and the CPU utilizations of the switch.

### Log

You can check system messages for debugging and network management.

### Device Diagnose

You can test the cable connection status, cable length and error length for troubleshooting.

### Network Diagnose

The network diagnose function includes Ping test and Tracert test. With them, you can test the connectivity between the switch and one node of the network, or the connectivity of the gateways on the path from the source to the destination.

# 2 Monitoring the System

The system monitor configurations include:

- Monitoring the CPU;
- Monitoring the memory.

## Configuration Guidelines

The CPU and memory utilizations should be always under 80%, and excessive use may result in switch malfunctions. For example, the switch fails to respond to management requests. In similar situations, you can monitor the system to verify a CPU or memory utilization problem.

## 2.1 Using the GUI

### 2.1.1 Monitoring the CPU

Choose the menu **Maintenance > System Monitor > CPU Monitor** to load the following page.

Figure 2-1 Monitoring the CPU

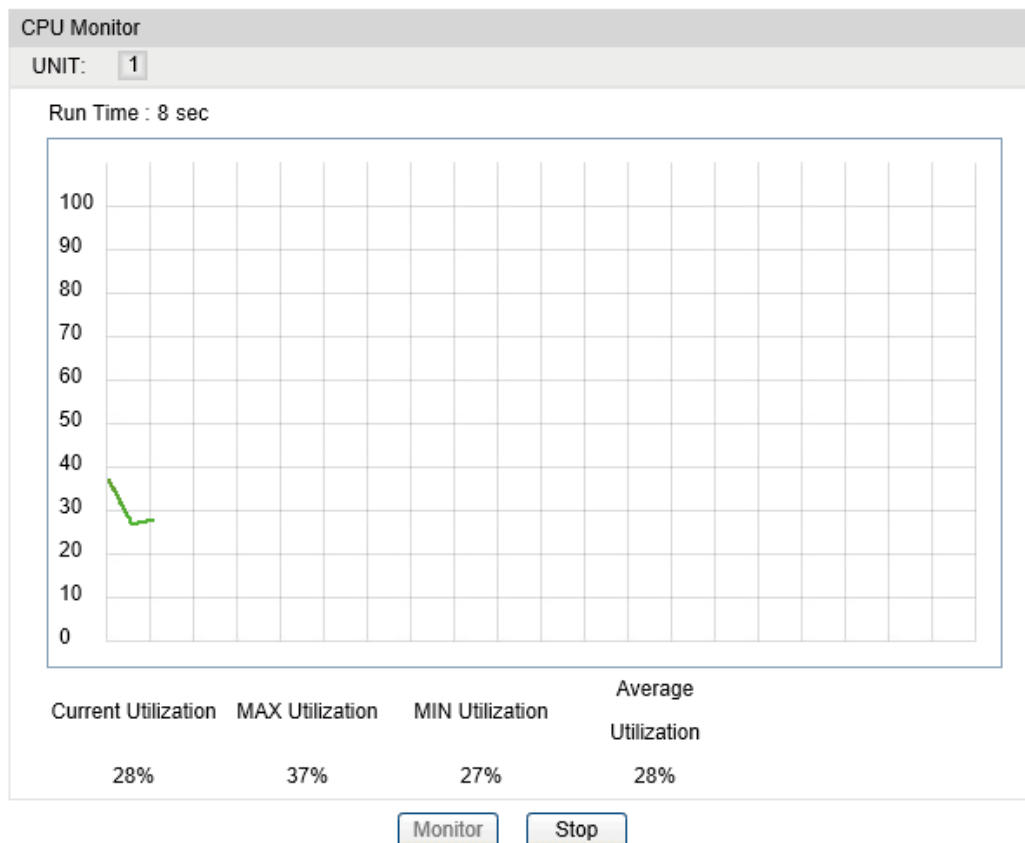

Click **Monitor** to enable the switch to monitor and display its CPU utilization rate every four seconds.

## 2.1.2 Monitoring the Memory

Choose the menu **Maintenance > System Monitor > Memory Monitor** to load the following page.

Figure 2-2 Monitoring the Memory

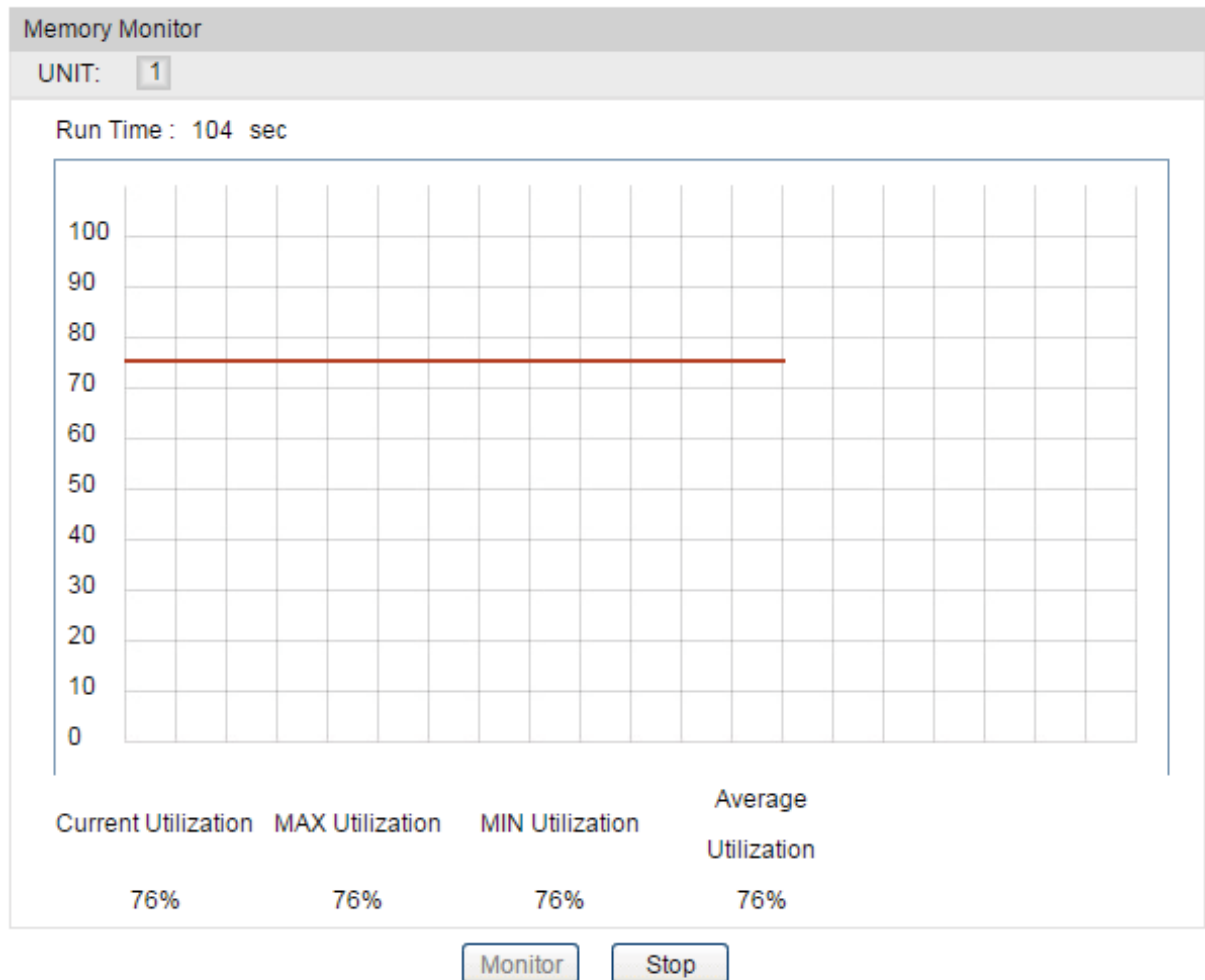

Click **Monitor** to enable the switch to monitor and display its memory utilization rate every four seconds.

## 2.2 Using the CLI

### 2.2.1 Monitoring the CPU

On privileged EXEC mode or any other configuration mode, you can use the following command to view the CPU utilization:



**show cpu-utilization**

View the memory utilization of the switch in the last 5 seconds, 1minute and 5minutes.

The following example shows how to monitor the CPU:

**Switch#show cpu-utilization**

```
Unit |          CPU Utilization
No.  | Five-Seconds One-Minute Five-Minutes
-----+-----
1    | 13%          13%          13%
```

## 2.2.2 Monitoring the Memory

On privileged EXEC mode or any other configuration mode, you can use the following command to view the memory utilization:

**show memory-utilization**

View the memory utilization of the switch in the last 5 seconds, 1minute and 5minutes.

The following example shows how to monitor the memory:

**Switch#show memory-utilization**

```
Unit | Current Memory Utilization
-----+-----
1    | 74%
```

# 3 System Log Configurations

System log configurations include:

- Configuring the local log;
- Configuring the remote log;
- Backing up log files;
- Viewing the log table.

## Configuration Guidelines

Logs are classified into the following eight levels. Messages of levels 0 to 4 mean the functionality of the switch is affected. Please take actions according to the log message.

Table 3-1 Levels of Logs

| Severity      | Level | Description                                                                                                              | Example                                                       |
|---------------|-------|--------------------------------------------------------------------------------------------------------------------------|---------------------------------------------------------------|
| Emergencies   | 0     | The system is unusable and you have to reboot the switch.                                                                | Software malfunctions affect the functionality of the switch. |
| Alerts        | 1     | Actions must be taken immediately.                                                                                       | The memory utilization reaches the limit.                     |
| Critical      | 2     | Cause analysis or actions must be taken immediately.                                                                     | The memory utilization reaches the warning threshold.         |
| Errors        | 3     | Error operations or unusual processing that will not affect subsequent operations but that should be noted and analyzed. | Wrong command or password is entered.                         |
| Warnings      | 4     | Conditions that may cause process failure and that should be noted.                                                      | Error protocol packets are detected.                          |
| Notifications | 5     | Normal but significant conditions.                                                                                       | The <b>shutdown</b> command is applied to a port.             |
| Informational | 6     | Normal messages for your information.                                                                                    | The <b>display</b> command is used.                           |
| Debugging     | 7     | Debug-level messages that you can ignore.                                                                                | General operational information.                              |

## 3.1 Using the GUI

### 3.1.1 Configuring the Local Log

Choose the menu **Maintenance > Log> Local Log** to load the following page.

Figure 3-1 Configuring the Local Log

| Local Log Config         |            |                                        |                                       |               |
|--------------------------|------------|----------------------------------------|---------------------------------------|---------------|
| Select                   | Channel    | Severity                               | Status                                | Sync-Periodic |
| <input type="checkbox"/> |            | <input type="text" value="level_6"/> ▾ | <input type="text" value="Enable"/> ▾ |               |
| <input type="checkbox"/> | Log Buffer | level_6                                | Enable                                | Immediately   |
| <input type="checkbox"/> | Log File   | level_3                                | Disable                               | 24 hour(s)    |

Follow these steps to configure the local log:

- 1) Select your desired channel and configure the corresponding severity and status.

|                      |                                                                                                                                                                                                                                                                                                                                                                                                                                                                                                                                                |
|----------------------|------------------------------------------------------------------------------------------------------------------------------------------------------------------------------------------------------------------------------------------------------------------------------------------------------------------------------------------------------------------------------------------------------------------------------------------------------------------------------------------------------------------------------------------------|
| <b>Channel</b>       | <p>Local log includes 2 channels: log buffer and log file.</p> <p>Log buffer indicates the RAM for saving system log. The channel is enabled by default. The information in the log buffer is displayed on the <b>Maintenance &gt; Log&gt; Log Table</b> page. It will be lost when the switch is restarted.</p> <p>Log File indicates the flash sector for saving system log. The information in the log file will not be lost after the switch is restarted and can be exported on the <b>Maintenance &gt; Log &gt; Backup Log</b> page.</p> |
| <b>Severity</b>      | <p>Specify the severity level of the log information that is saved to the selected channel. Only the log with the same or smaller severity level value can be saved. There are 8 severity levels marked from 0 to 7. The smaller value means the higher priority.</p>                                                                                                                                                                                                                                                                          |
| <b>Status</b>        | <p>Enable or disable the channel.</p>                                                                                                                                                                                                                                                                                                                                                                                                                                                                                                          |
| <b>Sync-Periodic</b> | <p>By default, the log information is saved in the log buffer immediately, and synchronized to the log file every 24 hours. If necessary, you can modify the log synchronization frequency using the CLI.</p>                                                                                                                                                                                                                                                                                                                                  |

- 2) Click **Apply**.

### 3.1.2 Configuring the Remote Log

Remote Log enables the switch to send system logs to a host. To display the logs, the host should run a log server that complies with the syslog standard.

Choose the menu **Maintenance > Log > Remote Log** to load the following page.

Figure 3-2 Configuring the Remote Log

| Log Host                 |       |                      |          |                                                       |                                                                       |
|--------------------------|-------|----------------------|----------|-------------------------------------------------------|-----------------------------------------------------------------------|
| Select                   | Index | Host IP              | UDP Port | Severity                                              | Status                                                                |
| <input type="checkbox"/> |       | <input type="text"/> |          | <input type="text"/> <input type="button" value="v"/> | <input type="text" value="Disable"/> <input type="button" value="v"/> |
| <input type="checkbox"/> | 1     | 0.0.0.0              | 514      | level_6                                               | Disable                                                               |
| <input type="checkbox"/> | 2     | 0.0.0.0              | 514      | level_6                                               | Disable                                                               |
| <input type="checkbox"/> | 3     | 0.0.0.0              | 514      | level_6                                               | Disable                                                               |
| <input type="checkbox"/> | 4     | 0.0.0.0              | 514      | level_6                                               | Disable                                                               |

Follow these steps to configure remote log:

- 1) Select an entry to enable the status, and then set the host IP address and severity.

|          |                                                                                                                                                                                         |
|----------|-----------------------------------------------------------------------------------------------------------------------------------------------------------------------------------------|
| Host IP  | Specify an IP address for the log host.                                                                                                                                                 |
| UDP Port | Displays the UDP port that receives and sends the log information. And the switch uses the standard port 514.                                                                           |
| Severity | Specify the severity level of the log information sent to the selected log host. Only the log with the same or smaller severity level value will be sent to the corresponding log host. |
| Status   | Enable or disable the log host.                                                                                                                                                         |

- 2) Click **Apply**.

### 3.1.3 Backing up the Log File

Choose the menu **Maintenance > Log > Backup Log** to load the following page.

Figure 3-3 Backup Log

| Backup Log                                    |                                     |
|-----------------------------------------------|-------------------------------------|
| Click the button here to backup the log file: |                                     |
| <input type="button" value="Backup Log"/>     | <input type="button" value="Help"/> |

Click **Backup Log** to save the system log as a file on your computer. If the switch system breaks down, you can check the file for troubleshooting.

### 3.1.4 Viewing the Log Table

Choose the menu **Maintenance > Log > Log Table** to load the following page.

Figure 3-4 Viewing the Log Table

| Log Info |                     |             |           |                                                                                 |
|----------|---------------------|-------------|-----------|---------------------------------------------------------------------------------|
| UNIT: 1  |                     |             |           |                                                                                 |
| Index    | Time                | Module      | Severity  | Content                                                                         |
|          |                     | All Modules | All Level |                                                                                 |
| 1        | 2006-01-20 02:45:46 | User        | level_5   | Login the web by admin on web (192.168.0.200).                                  |
| 2        | 2006-01-20 02:02:46 | LLDP        | level_6   | LLDP-MED status of port Gi1/0/1 enabled by admin on web (192.168.0.200).        |
| 3        | 2006-01-20 01:51:15 | LLDP        | level_6   | LLDP notification of port Gi1/0/9 enabled by admin on web (192.168.0.200).      |
| 4        | 2006-01-20 01:20:20 | User        | level_5   | Login the web by admin on web (192.168.0.200).                                  |
| 5        | 2006-01-19 11:21:04 | RADIUS      | level_6   | Add server 192.168.0.10 to RADIUS Server entry by admin on web (192.168.0.200). |
| 6        | 2006-01-19 11:20:11 | RADIUS      | level_6   | Del server 192.168.0.20 by admin on web (192.168.0.200).                        |
| 7        | 2006-01-19 11:20:11 | RADIUS      | level_6   | Del server 192.168.0.10 by admin on web (192.168.0.200).                        |
| 8        | 2006-01-19 11:02:32 | RADIUS      | level_6   | Add server 192.168.0.20 to RADIUS Server entry by admin on web (192.168.0.200). |
| 9        | 2006-01-19 11:02:24 | RADIUS      | level_6   | Add server 192.168.0.10 to RADIUS Server entry by admin on web (192.168.0.200). |
| 10       | 2006-01-19 11:01:31 | RADIUS      | level_6   | Del server 192.168.0.10 by admin on web (192.168.0.200).                        |
| 11       | 2006-01-19 10:59:15 | RADIUS      | level_6   | Add server 192.168.0.10 to RADIUS Server entry by admin on web (192.168.0.200). |
| 12       | 2006-01-19 10:27:21 | User        | level_5   | Login the web by admin on web (192.168.0.200).                                  |
| 13       | 2006-01-19 09:55:07 | VoIP        | level_6   | Set port Gi1/0/1 as non-security mode port by admin on web (192.168.0.200).     |

Select a module and a severity to view the corresponding log information.

|                 |                                                                                                                                                                    |
|-----------------|--------------------------------------------------------------------------------------------------------------------------------------------------------------------|
| <b>Time</b>     | To get the exact time when the log event occurs, you need to configure the system time on the <b>System &gt; System Info &gt; System Time</b> Web management page. |
| <b>Module</b>   | Select a module from the drop-down list to display the corresponding log information.                                                                              |
| <b>Severity</b> | Select a severity level to display the log information whose severity level value is the same or smaller.                                                          |

## 3.2 Using the CLI

### 3.2.1 Configuring the Local Log

Follow these steps to configure the local log:

|               |                                                                                                                                                                                                              |
|---------------|--------------------------------------------------------------------------------------------------------------------------------------------------------------------------------------------------------------|
| <b>Step 1</b> | <b>configure</b><br>Enter global configuration mode.                                                                                                                                                         |
| <b>Step 2</b> | <b>logging buffer</b><br>The switch stores the system log messages to the RAM. And the information will be lost when the switch is restarted. You can view the logs with <b>show logging buffer</b> command. |

---

|        |                                                                                                                                                                                                                                                                                                                                                                                                                                                                                                                     |
|--------|---------------------------------------------------------------------------------------------------------------------------------------------------------------------------------------------------------------------------------------------------------------------------------------------------------------------------------------------------------------------------------------------------------------------------------------------------------------------------------------------------------------------|
| Step 3 | <b>logging buffer level <i>level</i></b><br>Specify the severity level of the log information that should be saved to the buffer.<br><i>level</i> : Enter the severity level ranging from 0 to 7. The smaller value has the higher priority. Only the log with the same or smaller severity level value can be saved. The default level is 6, indicating that the log information of levels 0 to 6 will be saved in the log buffer.                                                                                 |
| Step 4 | <b>logging file flash</b><br>Store the log messages in the flash sector of the switch. The information in the flash will not be lost after the switch is restarted. You can view the logs with <b>show logging flash</b> command.                                                                                                                                                                                                                                                                                   |
| Step 5 | <b>logging file flash frequency { <i>periodic</i> <i>periodic</i>   <i>immediate</i> }</b><br>Specify the frequency to synchronize the system log file in the log buffer to the flash.<br><i>periodic</i> : Specify the frequency ranging from 1 to 48 hours. By default, the synchronization process takes place every 24 hours.<br><i>immediate</i> : The system log file in the buffer will be synchronized to the flash immediately. This option means frequent operations on the flash and is not recommended. |
| Step 6 | <b>logging file flash level <i>level</i></b><br>Specify the severity level of the log information that should be saved to the flash.<br><i>level</i> : Enter the severity level ranging from 0 to 7. The smaller value has the higher priority. Only the log with the same or smaller severity level value can be saved to the flash. The default level is 3, indicating that the log message of levels 0 to 3 will be saved in the log flash.                                                                      |
| Step 7 | <b>show logging local-config</b><br>View the configuration information of the local log.                                                                                                                                                                                                                                                                                                                                                                                                                            |
| Step 8 | <b>end</b><br>Return to privileged EXEC mode.                                                                                                                                                                                                                                                                                                                                                                                                                                                                       |
| Step 9 | <b>copy running-config startup-config</b><br>Save the settings in the configuration file.                                                                                                                                                                                                                                                                                                                                                                                                                           |

---

The following example shows how to configure the local log on the switch. Save logs of levels 0 to 5 to the log buffer, and synchronize logs of levels 0 to 2 to the flash every 10 hours:

```
Switch#configure
```

```
Switch(config)#logging buffer
```

```
Switch(config)#logging buffer level 5
```

```
Switch(config)#logging file flash
```

```
Switch(config)#logging file flash frequency periodic 10
```

```
Switch(config)#logging file flash level 2
```

```
Switch(config)#show logging local-config
```

| Channel | Level | Status | Sync-Periodic |
|---------|-------|--------|---------------|
| -----   | ----- | -----  | -----         |
| Buffer  | 5     | enable | Immediately   |
| Flash   | 2     | enable | 10 hour(s)    |
| Monitor | 5     | enable | Immediately   |

**Switch(config)#end**

**Switch#copy running-config startup-config**

### 3.2.2 Configuring the Remote Log

Remote Log enables the switch to send system logs to a host. To display the logs, the host should run a log server that complies with the syslog standard.

Follow these steps to set the remote log:

---

|        |                                                                 |
|--------|-----------------------------------------------------------------|
| Step 1 | <p><b>configure</b></p> <p>Enter global configuration mode.</p> |
|--------|-----------------------------------------------------------------|

---

|        |                                                                                                                                                                                                                                                                                                                                                                                                                                                                                                                                                                                                                                                                                                                                                                                                      |
|--------|------------------------------------------------------------------------------------------------------------------------------------------------------------------------------------------------------------------------------------------------------------------------------------------------------------------------------------------------------------------------------------------------------------------------------------------------------------------------------------------------------------------------------------------------------------------------------------------------------------------------------------------------------------------------------------------------------------------------------------------------------------------------------------------------------|
| Step 2 | <p><b>logging host index <i>idx</i> host-ip level</b></p> <p>Configure the log host which receives the system logs from other devices. You can remotely monitor the settings and operation status of other devices through the log host.</p> <p><i>idx</i>: Enter the index of the log host. The switch supports 4 log hosts at most.</p> <p><i>host-ip</i>: Specify the IP address for the log host.</p> <p><i>level</i>: Enter the severity level of the log information that should be sent to each log host. The range is 0 to 7, and the smaller value has the higher priority. Only the log with the same or smaller severity level value will be sent to the corresponding log host. The default is 6, indicating that the log information of levels 0 to 6 will be sent to the log host.</p> |
|--------|------------------------------------------------------------------------------------------------------------------------------------------------------------------------------------------------------------------------------------------------------------------------------------------------------------------------------------------------------------------------------------------------------------------------------------------------------------------------------------------------------------------------------------------------------------------------------------------------------------------------------------------------------------------------------------------------------------------------------------------------------------------------------------------------------|

---

|        |                                                                                                                                                                                                                                                                                                    |
|--------|----------------------------------------------------------------------------------------------------------------------------------------------------------------------------------------------------------------------------------------------------------------------------------------------------|
| Step 3 | <p><b>show logging loghost [ <i>index</i> ]</b></p> <p>View the configuration information of the log host.</p> <p><i>index</i>: Enter the index of the log host to view the corresponding configuration information. If no value is specified, information of all log hosts will be displayed.</p> |
|--------|----------------------------------------------------------------------------------------------------------------------------------------------------------------------------------------------------------------------------------------------------------------------------------------------------|

---

|        |                                                          |
|--------|----------------------------------------------------------|
| Step 4 | <p><b>end</b></p> <p>Return to privileged EXEC mode.</p> |
|--------|----------------------------------------------------------|

---

|        |                                                                                                      |
|--------|------------------------------------------------------------------------------------------------------|
| Step 5 | <p><b>copy running-config startup-config</b></p> <p>Save the settings in the configuration file.</p> |
|--------|------------------------------------------------------------------------------------------------------|

---

The following example shows how to set the remote log on the switch. Enable log host 2, set its IP address as 192.168.0.148, and allow logs of levels 0 to 5 to be sent to the host:

**Switch#configure**

**Switch(config)# logging host index 2 192.168.0.148 5**

```
Switch(config)# show logging loghost
```

| Index | Host-IP       | Severity | Status  |
|-------|---------------|----------|---------|
| ----- | -----         | -----    | -----   |
| 1     | 0.0.0.0       | 6        | disable |
| 2     | 192.168.0.148 | 5        | enable  |
| 3     | 0.0.0.0       | 6        | disable |
| 4     | 0.0.0.0       | 6        | disable |

```
Switch(config)#end
```

```
Switch#copy running-config startup-config
```



# 4 Diagnosing the Device

## 4.1 Using the GUI

Choose the menu **Maintenance > Device Diagnose > Cable Test** to load the following page.

Figure 4-1 Diagnosing the Device

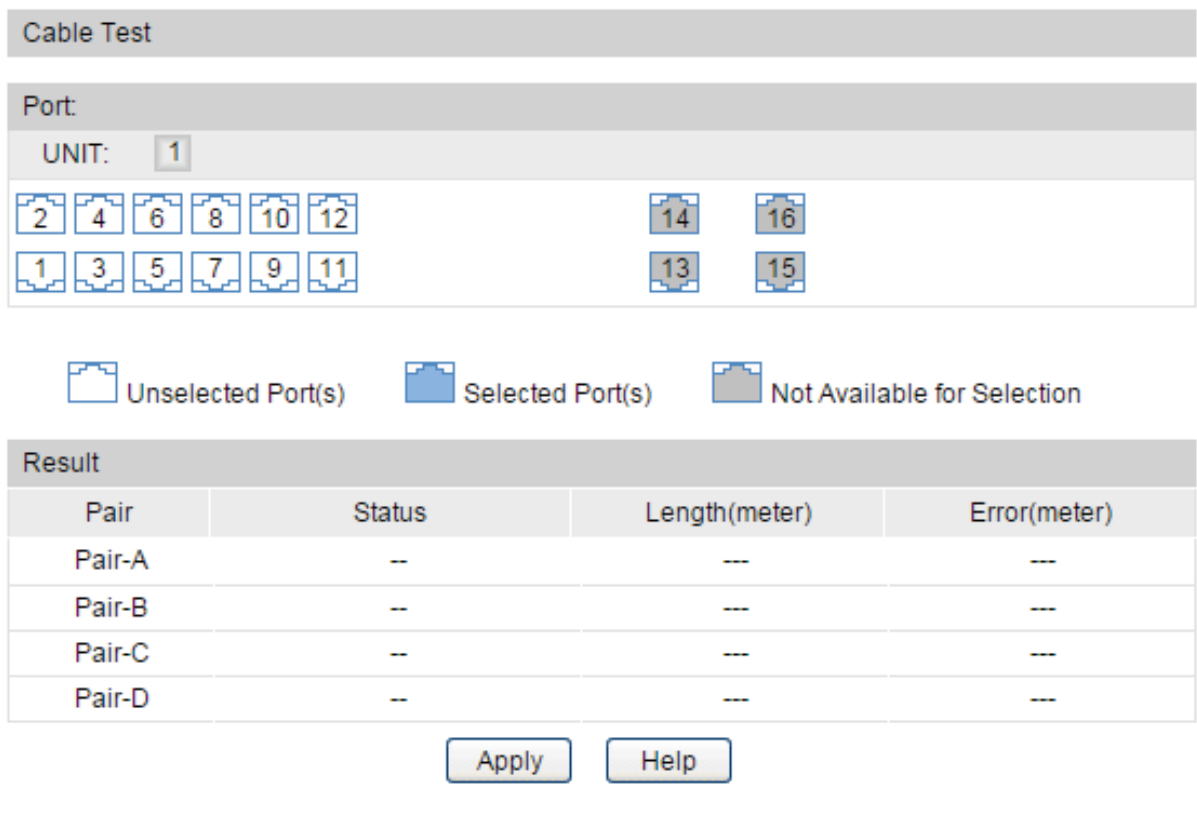

- 1) In the **Port** section, select your desired port for the test.
- 2) In the **Result** section, click **Apply** and check the test results.

|      |                                                                                                                   |
|------|-------------------------------------------------------------------------------------------------------------------|
| Port | Select the port for cable testing. The interval between two cable tests for one port must be more than 3 seconds. |
| Pair | Displays the Pair number.                                                                                         |

|        |                                                                                                                                                                                                                                                                                                                                                                                                 |
|--------|-------------------------------------------------------------------------------------------------------------------------------------------------------------------------------------------------------------------------------------------------------------------------------------------------------------------------------------------------------------------------------------------------|
| Status | <p>Displays the cable status. Test results include normal, close, open and crosstalk.</p> <p>Normal : The cable is normally connected.</p> <p>Close: A short circuit caused by an abnormal contact of wires in the cable.</p> <p>Open: No device is connected to the other end or the connectivity is broken.</p> <p>Crosstalk: Impedance mismatch caused by the poor quality of the cable.</p> |
| Length | <p>If the connection status is normal, here displays the length range of the cable. The value makes sense only when the cable is longer than 30m.</p>                                                                                                                                                                                                                                           |
| Error  | <p>If the connection status is short, close or crosstalk, here displays the length from the port to the trouble spot. The value makes sense only when the cable is longer than 30m.</p>                                                                                                                                                                                                         |

## 4.2 Using the CLI

On privileged EXEC mode or any other configuration mode, you can use the following command to check the connection status of the cable that is connected to the switch.

```
show cable-diagnostics interface { gigabitEthernet port | ten-gigabitEthernet port }
```

View the cable diagnostics of the connected Ethernet Port.

*port*: Enter the port number in 1/0/1 format to check the result of the cable test.

The following example shows how to check the cable diagnostics of port 1/0/2:

```
Switch#show cable-diagnostics interface ten-gigabitEthernet 1/0/2
```

| Port    | Pair   | Status | Length      | Error |
|---------|--------|--------|-------------|-------|
| Te1/0/2 | Pair-A | Normal | 2 (+/- 10m) | ---   |
|         | Pair-B | Normal | 2 (+/- 10m) | ---   |
|         | Pair-C | Normal | 0 (+/- 10m) | ---   |
|         | Pair-D | Normal | 2 (+/- 10m) | ---   |

# 5 Diagnosing the Network

The configuration includes:

- Configuring the Ping Test;
- Configuring the Tracert Test.

## 5.1 Using the GUI

### 5.1.1 Configuring the Ping Test

Choose the menu **Maintenance > Network Diagnose > Ping** to load the following page.

Figure 5-1 Configuring the Ping Test

| Ping Config     |                                                                            |
|-----------------|----------------------------------------------------------------------------|
| Destination IP: | <input type="text" value="192.168.0.115"/>                                 |
| Ping Times:     | <input type="text" value="4"/> (1-10)                                      |
| Data Size:      | <input type="text" value="64"/> byte (1-1500)                              |
| Interval:       | <input type="text" value="1000"/> millisec (100-1000)                      |
|                 | <input type="button" value="Ping"/><br><input type="button" value="Help"/> |

| Ping Result                                            |
|--------------------------------------------------------|
| Pinging 192.168.0.115 with 64 bytes of data :          |
| Reply from 192.168.0.115 : bytes=64 time<16ms TTL=64   |
| Reply from 192.168.0.115 : bytes=64 time<16ms TTL=64   |
| Reply from 192.168.0.115 : bytes=64 time<16ms TTL=64   |
| Reply from 192.168.0.115 : bytes=64 time<16ms TTL=64   |
|                                                        |
| Ping statistics for :                                  |
| Packets: Sent = 4 , Received = 4 , Lost = 0 (0% loss): |
| Approximate round trip times in milli-seconds:         |
| Minimum = 5ms , Maximum = 14ms , Average = 7ms         |

Follow these steps to test the connectivity between the switch and another device in the network:

- 1) In the **Ping Config** section, enter the IP address of the destination device for Ping test, set Ping times, data size and interval according to your needs, and then click **Ping** to start the test.

|                |                                                                                                              |
|----------------|--------------------------------------------------------------------------------------------------------------|
| Destination IP | Enter the IP address of the destination node for Ping test. Both IPv4 and IPv6 are supported.                |
| Ping Times     | Enter the amount of times to send test data for Ping test. We recommend that you keep the default 4 times.   |
| Data Size      | Enter the size of the sending data for Ping test. We recommend that you keep the default 64 bytes.           |
| Interval       | Specify the interval to send ICMP request packets. We recommend that you keep the default 1000 milliseconds. |

- 2) In the **Ping Result** section, check the test results.

## 5.1.2 Configuring the Tracert Test

Choose the menu **Maintenance > Network Diagnose > Tracert** to load the following page.

Figure 5-2 Configuring the Tracert Test

The screenshot shows two sections: 'Tracert Config' and 'Tracert Result'. In the 'Tracert Config' section, there are two input fields: 'Destination IP' with the value '192.168.0.100' and 'Max Hop' with the value '4'. To the right of these fields are two buttons: 'Tracert' and 'Help'. The 'Tracert Result' section is currently empty.

Follow these steps to test connectivity between the switch and routers along the path from the source to the destination:

- 1) In the **Tracert Config** section, enter the IP address of the destination, set the max hop, and then click **Tracert** to start the test.

|                |                                                                                   |
|----------------|-----------------------------------------------------------------------------------|
| Destination IP | Enter the IP address of the destination device. Both IPv4 and IPv6 are supported. |
| Max Hop        | Specify the maximum number of the route hops the test data can pass through.      |

- 2) In the **Tracert Result** section, check the test results.

## 5.2 Using the CLI

### 5.2.1 Configuring the Ping Test

On privileged EXEC mode or any other configuration mode, you can use the following command to test the connectivity between the switch and one node of the network.

---

```
ping [ ip | ipv6 ] { ip_addr } [ -n count ] [ -l count ] [ -i count ]
```

Test the connectivity between the switch and destination device.

**ip**: The type of the IP address for ping test should be IPv4.

**ipv6**: The type of the IP address for ping test should be IPv6.

**ip\_addr**: The IP address of the destination node for ping test. If the parameter ip/ipv6 is not selected, both IPv4 and IPv6 addresses are supported, such as 192.168.0.100 or fe80::1234.

**-n count**: Specify the amount of times to send test data for Ping testing. The values are from 1 to 10 times; the default is 4 times.

**-l count**: Specify the size of the sending data for ping testing. The values are from 1 to 1500 bytes; the default is 64 bytes.

**-i count**: Specify the interval to send ICMP request packets. The values are from 100 to 1000 milliseconds; the default is 1000 milliseconds.

---

The following example shows how to test the connectivity between the switch and the destination device with the IP address 192.168.0.10. Specify the ping times as 3, the data size as 1000 bytes and the interval as 500 milliseconds:

```
Switch#ping ip 192.168.0.10 -n 3 -l 1000 -i 500
```

Pinging 192.168.0.10 with 1000 bytes of data :

Reply from 192.168.0.10 : bytes=1000 time<16ms TTL=64

Reply from 192.168.0.10 : bytes=1000 time<16ms TTL=64

Reply from 192.168.0.10 : bytes=1000 time<16ms TTL=64

Ping statistics for 192.168.0.10:

Packets: Sent = 3 , Received = 3 , Lost = 0 (0% loss)

Approximate round trip times in milli-seconds:

Minimum = 0ms , Maximum = 0ms , Average = 0ms

## 5.2.2 Configuring the Tracert Test

On privileged EXEC mode or any other configuration mode, you can use the following command to test the connectivity between the switch and routers along the path from the source to the destination:

---

```
tracert [ ip | ipv6 ] ip_addr [ maxHops ]
```

Test the connectivity of the gateways along the path from the source to the destination.

**ip:** The type of the IP address for tracert test should be IPv4.

**ipv6:** The type of the IP address for tracert test should be IPv6.

**ip\_addr:** Enter the IP address of the destination device. If the parameter ip/ipv6 is not selected, both IPv4 and IPv6 addresses are supported, such as 192.168.0.100 or fe80::1234.

**maxHops:** Specify the maximum number of the route hops the test data can pass through. The range is 1 to 30 hops; the default is 4 hops.

---

The following example shows how to test the connectivity between the switch and the network device with the IP address 192.168.0.100. Set the maxhops as 2:

```
Switch#tracert 192.168.0.100 2
```

```
Tracing route to 192.168.0.100 over a maximum of 2 hops
```

```
 1    8 ms  1 ms  2 ms  192.168.1.1
 2    2 ms  2 ms  2 ms  192.168.0.100
```

```
Trace complete.
```

# 6 Configuration Example for Remote Log

## 6.1 Network Requirements

The company network manager needs to monitor network of department A for troubleshooting.

Figure 6-1 Network Topology

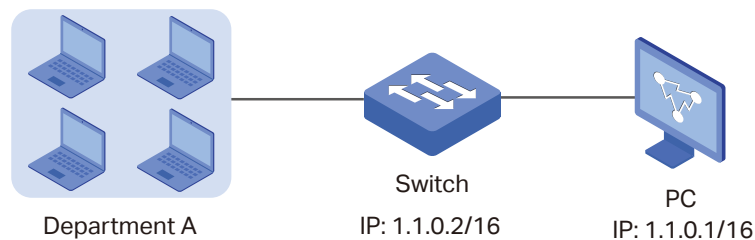

## 6.2 Configuration Scheme

The network manager can configure the remote log to receive system logs from monitored devices. Make sure the switch and the PC are reachable to each other; configure a log server that complies with the syslog standard on the PC and set the PC as the log host.

Demonstrated with T1700X-16TS, this chapter provides configuration procedures in two ways: using the GUI and Using the CLI.

## 6.3 Using the GUI

- 1) Choose the menu **Maintenance > Log > Remote Log** to load the following page. Enable host 1, and set the PC IP address 1.1.0.1 as the host IP address, and the severity as level\_5; click **Apply**.

Figure 6-2 Remote Log Host

| Log Host                            |       |         |          |          |         |
|-------------------------------------|-------|---------|----------|----------|---------|
| Select                              | Index | Host IP | UDP Port | Severity | Status  |
| <input type="checkbox"/>            |       | 1.1.0.1 |          | level_5  | Enable  |
| <input checked="" type="checkbox"/> | 1     | 0.0.0.0 | 514      | level_6  | Disable |
| <input type="checkbox"/>            | 2     | 0.0.0.0 | 514      | level_6  | Disable |
| <input type="checkbox"/>            | 3     | 0.0.0.0 | 514      | level_6  | Disable |
| <input type="checkbox"/>            | 4     | 0.0.0.0 | 514      | level_6  | Disable |

## 6.4 Using the CLI

Configure the remote log host.

```
Switch#configure
```

```
Switch(config)# logging host index 1 1.1.0.1 5
```

```
Switch(config)#end
```

```
Switch#copy running-config startup-config
```

### Verify the Configurations

```
Switch# show logging loghost
```

| Index | Host-IP | Severity | Status  |
|-------|---------|----------|---------|
| ----  | -----   | -----    | -----   |
| 1     | 1.1.0.1 | 5        | enable  |
| 2     | 0.0.0.0 | 6        | disable |
| 3     | 0.0.0.0 | 6        | disable |
| 4     | 0.0.0.0 | 6        | disable |



# 7 Appendix: Default Parameters

Default settings of maintenance are listed in the following tables.

Table 7-1 Default Settings of Local Log

| Parameter                   | Default Setting |
|-----------------------------|-----------------|
| Status of Log Buffer        | Enabled         |
| Severity of Log Buffer      | Level_6         |
| Sync-Periodic of Log Buffer | Immediately     |
| Status of Log File          | Disabled        |
| Severity of Log File        | Level_3         |
| Sync-Periodic of Log File   | 24 hours        |

Table 7-2 Default Settings of Remote Log

| Parameter | Default Setting |
|-----------|-----------------|
| Host IP   | 0.0.0.0         |
| UDP Port  | 514             |
| Severity  | Level_6         |
| Status    | Disabled        |

Table 7-3 Default Settings of Ping Config

| Parameter      | Default Setting   |
|----------------|-------------------|
| Destination IP | 192.168.0.1       |
| Ping Times     | 4                 |
| Data Size      | 64 bytes          |
| Interval       | 1000 milliseconds |

Table 7-4 Default Settings of Tracert Config

| Parameter      | Default Setting |
|----------------|-----------------|
| Destination IP | 192.168.0.100   |
| Max Hop        | 4 hops          |

# Part 23

## Configuring SNMP & RMON

### CHAPTERS

1. SNMP Overview
2. SNMP Configurations
3. Notification Configurations
4. RMON Overview
5. RMON Configurations
6. Configuration Example
7. Appendix: Default Parameters

# 1 SNMP Overview

SNMP (Simple Network Management Protocol) is a standard network management protocol, widely used on TCP/IP networks. It facilitates device management using NMS (Network Management System) software. With SNMP, network managers can view or modify network device information, and troubleshoot according to notifications sent by those devices in a timely manner.

The device supports three SNMP versions: SNMPv1, SNMPv2c and SNMPv3. Table 1-1 lists features supported by different SNMP versions, and Table 1-2 shows corresponding application scenarios.

Table 1-1 Features Supported by Different SNMP Versions

| Feature                    | SNMPv1                               | SNMPv2c                              | SNMPv3                                                                                                |
|----------------------------|--------------------------------------|--------------------------------------|-------------------------------------------------------------------------------------------------------|
| Access Control             | Based on SNMP Community and MIB View | Based on SNMP Community and MIB View | Based on SNMP User, Group, and MIB View                                                               |
| Authentication and Privacy | Based on Community Name              | Based on Community Name              | Supported authentication and privacy modes are as follows:<br>Authentication: MD5/SHA<br>Privacy: DES |
| Trap                       | Supported                            | Supported                            | Supported                                                                                             |
| Inform                     | Not supported                        | Supported                            | Supported                                                                                             |

Table 1-2 Application Scenarios of Different Versions

| Version | Application Scenario                                                                                                                                                                                                                                                                                         |
|---------|--------------------------------------------------------------------------------------------------------------------------------------------------------------------------------------------------------------------------------------------------------------------------------------------------------------|
| SNMPv1  | Applicable to small-scale networks with simple networking, low security requirements or good stability (such as campus networks and small enterprise networks).                                                                                                                                              |
| SNMPv2c | Applicable to medium and large-scale networks with low security requirements and those with good security (such as VPNs), but with busy services in which the traffic congestion may occur. You can configure Inform to ensure that the notifications from managed devices are received by network managers. |
| SNMPv3  | Applicable to networks of various scales, particularly those that have high security requirements and require devices to be managed by authenticated administrators (such as when data needs to be transferred on public networks).                                                                          |

# 2 SNMP Configurations

To complete the SNMP configuration, choose an SNMP version according to network requirements and supportability of the NMS software, and then follow these steps:

- **Choose SNMPv3**

- 1) Enable SNMP.
- 2) Create an SNMP view for managed objects.
- 3) Create an SNMP group, and specify the access rights.
- 4) Create SNMP users, and configure the authentication mode, privacy mode and corresponding passwords.

- **Choose SNMPv1 or SNMPv2c**

- 1) Enable SNMP.
- 2) Create an SNMP view for managed objects.
- 3) Direct configuration: Create a community, specify the accessible view and the corresponding access rights.

Indirect configuration: See steps 3) and 4) of *Choose SNMPv3*. In this situation, the user name functions as the community name, and the Read/Write View is the same for the user and the group.

## 2.1 Using the GUI

### 2.1.1 Enabling SNMP

Choose the **SNMP > SNMP Config > Global Config** to load the following page.

Figure 2-1 Global Config

|                      |                                                                       |                                                                                   |
|----------------------|-----------------------------------------------------------------------|-----------------------------------------------------------------------------------|
| <b>Global Config</b> |                                                                       |                                                                                   |
| SNMP:                | <input type="radio"/> Enable <input checked="" type="radio"/> Disable | <input type="button" value="Apply"/>                                              |
| <b>Local Engine</b>  |                                                                       |                                                                                   |
| Local Engine ID:     | <input type="text" value="80002e5703000aeb13237b"/> (10-64 Hex)       | <input type="button" value="Default ID"/><br><input type="button" value="Apply"/> |
| <b>Remote Engine</b> |                                                                       |                                                                                   |
| Remote Engine ID:    | <input type="text"/> (0 or 10-64 Hex)                                 | <input type="button" value="Apply"/><br><input type="button" value="Help"/>       |

Follow these steps to configure SNMP globally:

- 1) In the **Global Config** section, enable SNMP. Click **Apply**.
- 2) In the **Local Engine** section, configure the local engine ID. Click **Apply**.

**Local Engine ID** Set the ID of the local SNMP Agent with 10 to 64 hexadecimal digits.

The local engine ID is a unique alphanumeric string used to identify the SNMP engine on the switch.

- 3) In the **Remote Engine** section, configure the remote engine ID. Click **Apply**.

**Remote Engine ID** Set the ID of the remote SNMP manager with 10 to 64 hexadecimal digits. If no remote SNMP manager is needed, you can leave this field empty.

The remote engine ID is a unique alphanumeric string. It is used to identify the SNMP engine on the remote device that receives inform messages from Switch.

#### Note:

The engine ID must contain an even number of characters.

### 2.1.2 Creating an SNMP View

Create an SNMP view, and configure the content of the view. NMS (Network Management System) manages MIB (Management Information Base) variables based on the SNMP view.

Choose the menu **SNMP > SNMP Config > SNMP View** to load the following page.

Figure 2-2 SNMP View

**View Config**

View Name:  (16 characters maximum)

MIB Object ID:  (61 characters maximum) Create

View Type:  Include  Exclude

**View Table**

| Select                   | View Name   | View Type | MIB Object ID  |
|--------------------------|-------------|-----------|----------------|
| <input type="checkbox"/> | viewDefault | Include   | 1              |
| <input type="checkbox"/> | viewDefault | Exclude   | 1.3.6.1.6.3.15 |
| <input type="checkbox"/> | viewDefault | Exclude   | 1.3.6.1.6.3.16 |
| <input type="checkbox"/> | viewDefault | Exclude   | 1.3.6.1.6.3.18 |

All
Delete
Help

Set the view name and one MIB variable that is related to the view. Choose the view type and click **Create** to add the view entry.

|                      |                                                                                                                                                                                                                                                                                  |
|----------------------|----------------------------------------------------------------------------------------------------------------------------------------------------------------------------------------------------------------------------------------------------------------------------------|
| <b>View Name</b>     | Set the view name with 1 to 16 characters. A complete view consists of all MIB objects that have the same view name.                                                                                                                                                             |
| <b>MIB Object ID</b> | Enter a MIB Object ID to specify a specific function of the device. For specific ID rules, refer to the device related MIBs.                                                                                                                                                     |
| <b>View Type</b>     | <p>Set the view to include or exclude the related MIB object. By default, it is included.</p> <p><b>Include:</b> The NMS can view or manage the function indicated by the object.</p> <p><b>Exclude:</b> The NMS cannot view or manage the function indicated by the object.</p> |

### 2.1.3 Creating an SNMP Group

Create an SNMP group and configure related parameters.

Choose the menu **SNMP > SNMP Config > SNMP Group** to load the following page.

Figure 2-3 SNMP Group

**Group Config**

Group Name:  (16 characters maximum)

Security Model:  ▼

Security Level:  ▼

Read View:  ▼

Write View:  ▼

Notify View:  ▼

**Group Table**

| Select                 | Group Name | Security Model | Security Level | Read View | Write View | Notify View | Operation |
|------------------------|------------|----------------|----------------|-----------|------------|-------------|-----------|
| No entry in the table. |            |                |                |           |            |             |           |

Follow these steps to create an SNMP Group:

- 1) Set the group name and security model. If you choose SNMPv3 as the security model, you need to further configure security level.

|                       |                                                                                                                                                                                                                                                                                                                                                                                                                                                                                                                                                                                                                                 |
|-----------------------|---------------------------------------------------------------------------------------------------------------------------------------------------------------------------------------------------------------------------------------------------------------------------------------------------------------------------------------------------------------------------------------------------------------------------------------------------------------------------------------------------------------------------------------------------------------------------------------------------------------------------------|
| <b>Group Name</b>     | <p>Set the SNMP group name. You may enter 1 to 16 characters.</p> <p>The identifier of a group consists of a group name, security model and security level. Groups of the same identifier are recognized as being in the same group.</p>                                                                                                                                                                                                                                                                                                                                                                                        |
| <b>Security Model</b> | <p>Choose the corresponding SNMP version of the security model. By default, it is SNMPv1.</p> <p><b>v1:</b> The security model of the group is SNMPv1. In this mode, community name match is used for authentication. You can configure the community name on the SNMP community page.</p> <p><b>v2c:</b> The security model of the group is SNMPv2. In this mode, community name match is used for authentication. You can configure the community name on the SNMP community page.</p> <p><b>v3:</b> The security model of the group is SNMPv3. In this mode, USM (User-Based Security Model) is used for authentication.</p> |
| <b>Security Level</b> | <p>Set the security level which for the SNMPv3 group. The default is noAuthNoPriv.</p> <p><b>noAuthNoPriv:</b> No authentication mode or privacy mode is applied to check or encrypt packets.</p> <p><b>authNoPriv:</b> An authentication mode is applied to check packets, but no privacy mode is applied to encrypt them.</p> <p><b>authPriv:</b> An authentication mode and a privacy mode are applied to check and encrypt packets.</p>                                                                                                                                                                                     |

- 2) Set the read, write and notify view of the SNMP Group. Click **Create**.

|                    |                                                                                                                                                                                                                         |
|--------------------|-------------------------------------------------------------------------------------------------------------------------------------------------------------------------------------------------------------------------|
| <b>Read View</b>   | Choose a view to allow parameters to be viewed but not modified by the NMS. The view is necessary for any group. By default, the view is viewDefault. To modify parameters of a view, you need to add it to Write View. |
| <b>Write View</b>  | Choose a view to allow parameters to be modified but not viewed by the NMS. The default is none. The view in Write View should also be added to Read View.                                                              |
| <b>Notify View</b> | Choose a view to allow it to send notifications to the NMS.                                                                                                                                                             |

### 2.1.4 Creating SNMP Users

Choose the menu **SNMP > SNMP Config > SNMP User** to load the following page.

Figure 2-4 SNMP User

**User Config**

User Name:  (16 characters maximum)

User Type:  Group Name:

Security Model:  Security Level:

Auth Mode:  Auth Password:  (16 characters maximum)

Privacy Mode:  Privacy Password:  (16 characters maximum)

**User Table**

| Select                 | User Name | User Type | Group Name | Security Model | Security Level | Auth Mode | Privacy Mode | Operation |
|------------------------|-----------|-----------|------------|----------------|----------------|-----------|--------------|-----------|
| No entry in the table. |           |           |            |                |                |           |              |           |

Follow these steps to create an SNMP user:

- 1) Specify the user name, user type and the group which the user belongs to. Set the security model according to the related parameters of the specified group. If you choose SNMPv3, you need to configure the security level.

|                   |                                                                                                                                                                                                                                                                                                                                                                          |
|-------------------|--------------------------------------------------------------------------------------------------------------------------------------------------------------------------------------------------------------------------------------------------------------------------------------------------------------------------------------------------------------------------|
| <b>User Name</b>  | Set the SNMP user name. You may use 1 to 16 characters. For different entries, user names cannot be the same.                                                                                                                                                                                                                                                            |
| <b>User Type</b>  | Choose a user type to indicate the location of the user. The default is Local User.<br><br><b>Local User:</b> The user resides on the local engine, which is the SNMP Agent of the switch.<br><br><b>Remote User:</b> The user resides on a remote engine, which is the SNMP Agent of some other device. For this user type, you need to set the remote engine ID first. |
| <b>Group Name</b> | Choose the group that the user belongs to. Users with the same Group Name, Security Model and Security Level will be in the same group.                                                                                                                                                                                                                                  |



---

|                       |                                                                                                                                                                                                                                                                                                                                                                                                    |
|-----------------------|----------------------------------------------------------------------------------------------------------------------------------------------------------------------------------------------------------------------------------------------------------------------------------------------------------------------------------------------------------------------------------------------------|
| <b>Security Model</b> | <p>Choose the SNMP version of the security model. The default is SNMPv1. The setting should be identical with that of the specified group.</p> <p><b>v1:</b> The group's security model is SNMPv1.</p> <p><b>v2c:</b> In this mode, Community Name is used for authentication. You can configure Community Name on the SNMP Community.</p> <p><b>v3:</b> The group's security model is SNMPv3.</p> |
|-----------------------|----------------------------------------------------------------------------------------------------------------------------------------------------------------------------------------------------------------------------------------------------------------------------------------------------------------------------------------------------------------------------------------------------|

---

|                       |                                                                                                                                                                                                                                                                                                                                                                                                                                       |
|-----------------------|---------------------------------------------------------------------------------------------------------------------------------------------------------------------------------------------------------------------------------------------------------------------------------------------------------------------------------------------------------------------------------------------------------------------------------------|
| <b>Security Level</b> | <p>Set the security level for the SNMPv3 group. The default is noAuthNoPriv.</p> <p><b>noAuthNoPriv:</b> No authentication mode or privacy mode is applied to check or encrypt packets.</p> <p><b>authNoPriv:</b> An authentication mode is applied to check packets, but no privacy mode is applied to encrypt them.</p> <p><b>authPriv:</b> An authentication mode and a privacy mode are applied to check and encrypt packets.</p> |
|-----------------------|---------------------------------------------------------------------------------------------------------------------------------------------------------------------------------------------------------------------------------------------------------------------------------------------------------------------------------------------------------------------------------------------------------------------------------------|

---

- 2) If you have chosen **authNoPriv** or **authPriv** as the security level, you need to set corresponding Auth Mode or Privacy Mode. If not, skip the step.

---

|                  |                                                                                                                                                                                                                                                                                                                            |
|------------------|----------------------------------------------------------------------------------------------------------------------------------------------------------------------------------------------------------------------------------------------------------------------------------------------------------------------------|
| <b>Auth Mode</b> | <p>If you have chosen authNoPriv as the security level, you need to set Auth Mode, which is None by default.</p> <p><b>MD5:</b> Enable the HMAC-MD5 algorithm for authentication.</p> <p><b>SHA:</b> Enable the SHA (Secure Hash Algorithm) algorithm for authentication. SHA algorithm is securer than MD5 algorithm.</p> |
|------------------|----------------------------------------------------------------------------------------------------------------------------------------------------------------------------------------------------------------------------------------------------------------------------------------------------------------------------|

---

|                      |                                      |
|----------------------|--------------------------------------|
| <b>Auth Password</b> | Set the password for authentication. |
|----------------------|--------------------------------------|

---

|                     |                                                                                                                                                                                                                                     |
|---------------------|-------------------------------------------------------------------------------------------------------------------------------------------------------------------------------------------------------------------------------------|
| <b>Privacy Mode</b> | <p>If you have chosen authPriv as the security level, you need to set both Auth Mode and Privacy Mode. The privacy mode is None by default.</p> <p><b>DES:</b> Enable the DES (Data Encryption Standard) algorithm for privacy.</p> |
|---------------------|-------------------------------------------------------------------------------------------------------------------------------------------------------------------------------------------------------------------------------------|

---

|                         |                                  |
|-------------------------|----------------------------------|
| <b>Privacy Password</b> | Set the password for encryption. |
|-------------------------|----------------------------------|

---

- 3) Click **Create**.

## 2.1.5 Creating SNMP Communities

If you want to use SNMPv1 or SNMPv2c as the security model, you can create SNMP communities directly.

Choose the menu **SNMP > SNMP Config > SNMP Community** to load the following page.

Figure 2-5 SNMP Community

**Community Config**

Community Name:  (16 characters maximum)

Access:

MIB View:

---

**Community Table**

| Select                 | Community Name | Access | MIB View | Operation |
|------------------------|----------------|--------|----------|-----------|
| No entry in the table. |                |        |          |           |

Set the community name, access rights and the related view. Click **Create**.

**Community Name** Set the community name with 1 to 16 characters. For SNMPv1 and SNMPv2c, the community name match is used for authentication.

**Access** Specify the access right to the related view. The default is read-only.

**read-only:** The NMS can view but not modify parameters of the specified view.

**read-write:** The NMS can view and modify parameters of the specified view.

**MIB View** Choose a view to allow it to be accessed by the community. The default is viewDefault.

## 2.2 Using the CLI

### 2.2.1 Enabling SNMP

Step 1 **configure**  
Enter global configuration mode.

Step 2 **snmp-server**  
Enabling SNMP.

---

Step 3 **snmp-server engineID** {[ *local local-engineID*] [*remote remote-engineID*]}

(Optional) Configure the local engine ID and the remote engine ID.

*local-engineID*: Enter the local engine ID with 10 to 64 hexadecimal digits. The ID must contain an even number of characters. It is a unique alphanumeric string, used to identify the SNMP engine on the switch.

*remote-engineID*: Enter the remote engine ID with 10 to 64 hexadecimal digits. The ID must contain an even number of characters. The remote engine ID is a unique alphanumeric string. It is used to identify the SNMP engine on the remote device that receives inform messages from Switch.

Note that the switch will automatically generate a local engine ID if the ID is not set or is deleted.

---

Step 4 **show snmp-server**

Displays the global settings of SNMP.

---

Step 5 **show smnp-server engineID**

Displays the engine ID of SNMP.

---

Step 6 **end**

Return to privileged EXEC mode.

---

Step 7 **copy running-config startup-config**

Save the settings in the configuration file.

---

The following example shows how to enable SNMP and set 123456789a as the remote engine ID:

**Switch#configure**

**Switch(config)#snmp-server**

**Switch(config)#snmp-server engineID remote 123456789a**

**Switch(config)#show snmp-server**

SNMP agent is enabled.

- 0 SNMP packets input
- 0 Bad SNMP version errors
- 0 Unknown community name
- 0 Illegal operation for community name supplied
- 0 Encoding errors
- 0 Number of requested variables
- 0 Number of altered variables
- 0 Get-request PDUs

- 0 Get-next PDUs
- 0 Set-request PDUs
- 0 SNMP packets output
- 0 Too big errors(Maximum packet size 1500)
- 0 No such name errors
- 0 Bad value errors
- 0 General errors
- 0 Response PDUs
- 0 Trap PDUs

**Switch(config)#show snmp-server engineID**

Local engine ID : 80002e5703000aeb132397

Remote engine ID: 123456789a

**Switch(config)#end**

**Switch#copy running-config startup-config**

## 2.2.2 Creating an SNMP View

Specify the OID (Object Identifier) of the view to determine objects to be managed.

|        |                                                                                                                                                                                                                                                                                                                                                                                                                                                                                                                                                                                                     |
|--------|-----------------------------------------------------------------------------------------------------------------------------------------------------------------------------------------------------------------------------------------------------------------------------------------------------------------------------------------------------------------------------------------------------------------------------------------------------------------------------------------------------------------------------------------------------------------------------------------------------|
| Step 1 | <p><b>configure</b></p> <p>Enter global configuration mode.</p>                                                                                                                                                                                                                                                                                                                                                                                                                                                                                                                                     |
| Step 2 | <p><b>snmp-server view</b> <i>name mib-oid</i> {include   exclude}</p> <p>Configure the view.</p> <p><i>name</i> : Enter a view name with 1 to 16 characters.You can create multiple entries with each associated to a MIB object. A complete view consists of all MIB objects that have the same view name.</p> <p><i>mib-oid</i> : Enter the MIB object ID with 1 to 61 characters.</p> <p><i>include exclude</i> : Specify a view type. Include indicates that objects of the view can be managed by the NMS, while exclude indicates that objects of the view cannot be managed by the NMS.</p> |
| Step 3 | <p><b>show snmp-server view</b></p> <p>Displays the view table.</p>                                                                                                                                                                                                                                                                                                                                                                                                                                                                                                                                 |
| Step 4 | <p><b>end</b></p> <p>Return to Privileged EXEC Mode.</p>                                                                                                                                                                                                                                                                                                                                                                                                                                                                                                                                            |

---

Step 5      **copy running-config startup-config**  
Save the settings in the configuration file.

---

The following example shows how to set a view to allow the NMS to manage all function. Name the view as View:

**Switch#configure**

**Switch(config)#snmp-server view View 1 include**

**Switch(config)#show snmp-server view**

| No. | View Name   | Type    | MOID           |
|-----|-------------|---------|----------------|
| --- | -----       | -----   | ----           |
| 1   | viewDefault | include | 1              |
| 2   | viewDefault | exclude | 1.3.6.1.6.3.15 |
| 3   | viewDefault | exclude | 1.3.6.1.6.3.16 |
| 4   | viewDefault | exclude | 1.3.6.1.6.3.18 |
| 5   | View        | include | 1              |

**Switch(config)#end**

**Switch#copy running-config startup-config**

### 2.2.3 Creating an SNMP Group

Create an SNMP group and set user access control with read, write and notify views. Meanwhile, set the authentication and privacy modes to secure the communication between the NMS and managed devices.

---

Step 1      **configure**  
Enter global configuration mode.

---

- 
- Step 2      **snmp-server group** *name* [ **smode** {v1 | v2c | v3}] [ **slev** {noAuthNoPriv | authNoPriv | authPriv}] [ **read** *read-view*] [ **write** *write-view*] [ **notify** *notify-view*]
- Set an SNMP group.
- name* : Enter the group name with 1 to 16 characters. The identifier of a group consists of a group name, security model and security level. Groups of the same identifier are recognized as being in the same group.
- v1 | v2c | v3* : Choose a security mode for the SNMP group from the following: SNMPv1, SNMPv2c, SNMPv3. The default is v1.
- noAuthNoPriv | authNoPriv | authPriv* : For groups of SNMPv3, choose a security level among noAuthNoPriv (no authorization and no encryption), authNoPriv (authorization and no encryption), authPriv (authorization and encryption). The default is noAuthNoPriv. Please note that if you have chosen v1 or v2c as the security mode, the security level cannot be configured.
- read-view* : Set the view as read-only. And then the NMS can view parameters of the specified view.
- write-view* : Set the view as write-only. And then the NMS can modify parameters of the specified view. Please note that the view in write-view should also be in read-view.
- notify-view* : Set the view as notify-only view. And then the NMS can get notifications of the specified view from the agent.
- 
- Step 3      **show snmp-server group**
- Displays SNMP group entries.
- 
- Step 4      **end**
- Return to Privileged EXEC Mode.
- 
- Step 5      **copy running-config startup-config**
- Save the settings in the configuration file.
- 

The following example shows how to create an SNMPv3 group. Name the group as nms-monitor, enable Auth Mode and Privacy Mode, and set the view as read View and notify View:

**Switch#configure**

**Switch(config)#snmp-server group** nms-monitor **smode** v3 **slev** authPriv **read** View **notify** View

**Switch(config)#show snmp-server group**

| No. | Name        | Sec-Mode | Sec-Lev  | Read-View | Write-View | Notify-View |
|-----|-------------|----------|----------|-----------|------------|-------------|
| 1   | nms-monitor | v3       | authPriv | View      |            | View        |

**Switch(config)#end**

**Switch#copy running-config startup-config**

## 2.2.4 Creating SNMP Users

Configure users of the SNMP group. Users belong to the group, and use the same security level and access rights as the group.

|        |                                                                                                                                                                                                                                                                                                                                                                                                                                                                                                                                                                                                                                                                                                                                                                                                                                                                                                                                                                                                                                                                                                                                                                                                                                                                                                                                                                                                                                                                                                                                                                                                                                                                                                                                                                                                                                                                                                                                                                                                                                                                                                                                                                                                                                                                                                                                                        |
|--------|--------------------------------------------------------------------------------------------------------------------------------------------------------------------------------------------------------------------------------------------------------------------------------------------------------------------------------------------------------------------------------------------------------------------------------------------------------------------------------------------------------------------------------------------------------------------------------------------------------------------------------------------------------------------------------------------------------------------------------------------------------------------------------------------------------------------------------------------------------------------------------------------------------------------------------------------------------------------------------------------------------------------------------------------------------------------------------------------------------------------------------------------------------------------------------------------------------------------------------------------------------------------------------------------------------------------------------------------------------------------------------------------------------------------------------------------------------------------------------------------------------------------------------------------------------------------------------------------------------------------------------------------------------------------------------------------------------------------------------------------------------------------------------------------------------------------------------------------------------------------------------------------------------------------------------------------------------------------------------------------------------------------------------------------------------------------------------------------------------------------------------------------------------------------------------------------------------------------------------------------------------------------------------------------------------------------------------------------------------|
| Step 1 | <p><b>configure</b></p> <p>Enter global configuration mode.</p>                                                                                                                                                                                                                                                                                                                                                                                                                                                                                                                                                                                                                                                                                                                                                                                                                                                                                                                                                                                                                                                                                                                                                                                                                                                                                                                                                                                                                                                                                                                                                                                                                                                                                                                                                                                                                                                                                                                                                                                                                                                                                                                                                                                                                                                                                        |
| Step 2 | <p><b>snmp-server user</b> <i>name</i> { local   remote } <i>group-name</i> [ <b>smode</b> { v1   v2c   v3 } ] [ <b>slev</b> { noAuthNoPriv   authNoPriv   authPriv } ] [ <b>cmode</b> { none   MD5   SHA } ] [ <b>cpwd</b> <i>confirm-pwd</i> ] [ <b>emode</b> { none   DES } ] [ <b>epwd</b> <i>encrypt-pwd</i> ]</p> <p>Configure users of the SNMP group.</p> <p><i>name</i> : Enter the user name with 1 to 16 characters.</p> <p><i>local</i>   <i>remote</i> : Choose a user type. Local indicates that the user is connected to a local SNMP engine, while remote means that the user is connected to a remote SNMP engine.</p> <p><i>group-name</i> : Enter the name of the group which the user belongs to. The group is determined by the group name, security mode and security level.</p> <p><i>v1</i>   <i>v2c</i>   <i>v3</i> : Choose a security mode for the SNMP group from the following: SNMPv1, SNMPv2c, SNMPv3.</p> <p><i>noAuthNoPriv</i>   <i>authNoPriv</i>   <i>authPriv</i> : For SNMPv3 groups, choose a security level from noAuthNoPriv (no authorization and no encryption), authNoPriv (authorization and no encryption), authPriv (authorization and encryption). The default is noAuthNoPriv. Please note that if you have chosen v1 or v2c as the security mode, security level cannot be configured.</p> <p><i>none</i>   <i>MD5</i>   <i>SHA</i> : Choose an authentication algorithm which is only for the user of SNMPv3. SHA authentication mode has a higher security than MD5 mode. By default, the Authentication Mode is none.</p> <p><i>confirm-pwd</i> : Enter an authentication password with 1 to 16 characters excluding question mark and space. This password in the configuration file will be displayed in the symmetric encrypted form.</p> <p><i>none</i>   <i>DES</i> : Choose a privacy mode which is only for the user of SNMPv3. None indicates no privacy method is used, and DES indicates DES encryption method is used. By default, the Privacy Mode is none. Please note that if you have chosen v1 or v2c as the security mode, the privacy mode cannot be configured.</p> <p><i>encrypt-pwd</i> : Enter a privacy password with 1 to 16 characters excluding question mark and space. This password in the configuration file will be displayed in the symmetric encrypted form.</p> |
| Step 3 | <p><b>show snmp-server user</b></p> <p>Displays the information of SNMP users.</p>                                                                                                                                                                                                                                                                                                                                                                                                                                                                                                                                                                                                                                                                                                                                                                                                                                                                                                                                                                                                                                                                                                                                                                                                                                                                                                                                                                                                                                                                                                                                                                                                                                                                                                                                                                                                                                                                                                                                                                                                                                                                                                                                                                                                                                                                     |
| Step 4 | <p><b>end</b></p> <p>Return to privileged EXEC mode.</p>                                                                                                                                                                                                                                                                                                                                                                                                                                                                                                                                                                                                                                                                                                                                                                                                                                                                                                                                                                                                                                                                                                                                                                                                                                                                                                                                                                                                                                                                                                                                                                                                                                                                                                                                                                                                                                                                                                                                                                                                                                                                                                                                                                                                                                                                                               |
| Step 5 | <p><b>copy running-config startup-config</b></p> <p>Save the settings in the configuration file.</p>                                                                                                                                                                                                                                                                                                                                                                                                                                                                                                                                                                                                                                                                                                                                                                                                                                                                                                                                                                                                                                                                                                                                                                                                                                                                                                                                                                                                                                                                                                                                                                                                                                                                                                                                                                                                                                                                                                                                                                                                                                                                                                                                                                                                                                                   |

The following example shows how to create an SNMP user on the switch. Name the user as admin, and set the user as a remote user, SNMPv3 as the security mode, authPriv as the

security level, SHA as the authentication algorithm, 1234 as the authentication password, DES as the privacy algorithm and 1234 as the privacy password:

**Switch#configure**

**Switch(config)#snmp-server user** admin remote nms-monitor **smode** v3 **slev** authPriv **cmode** SHA **cpwd** 1234 **emode** DES **epwd** 1234

**Switch(config)#show snmp-server user**

| No. | U-Name | U-Type | G-Name      | S-Mode | S-Lev    | A-Mode | P-Mode |
|-----|--------|--------|-------------|--------|----------|--------|--------|
| --- | -----  | -----  | -----       | -----  | -----    | -----  | -----  |
| 1   | admin  | remote | nms-monitor | v3     | authPriv | SHA    | DES    |

**Switch(config)#end**

**Switch#copy running-config startup-config**

## 2.2.5 Creating SNMP Communities

For SNMPv1 and SNMPv2c the Community Name is used for authentication, functioning as the password.

|        |                                                                                                                                                                                                                                                                                                                                                                                                                                                                                                                                                                 |
|--------|-----------------------------------------------------------------------------------------------------------------------------------------------------------------------------------------------------------------------------------------------------------------------------------------------------------------------------------------------------------------------------------------------------------------------------------------------------------------------------------------------------------------------------------------------------------------|
| Step 1 | <b>configure</b><br>Enter global configuration mode.                                                                                                                                                                                                                                                                                                                                                                                                                                                                                                            |
| Step 2 | <b>snmp-server community</b> <i>name</i> { <i>read-only</i>   <i>read-write</i> } <i>mib-view</i><br>Configure the community.<br><i>name</i> : Enter a group name with 1 to 16 characters.<br><i>read-only</i>   <i>read-write</i> : Choose an access permissions for the community. Read-only indicates that the NMS can view but cannot modify parameters of the view, while read-write indicates that the NMS can both view and modify.<br><i>mib-view</i> : Enter a view to allow it to be accessed by the community. The name contains 1 to 61 characters. |
| Step 3 | <b>show snmp-server community</b><br>Displays community entries.                                                                                                                                                                                                                                                                                                                                                                                                                                                                                                |
| Step 4 | <b>end</b><br>Return to privileged EXEC mode.                                                                                                                                                                                                                                                                                                                                                                                                                                                                                                                   |
| Step 5 | <b>copy running-config startup-config</b><br>Save the settings in the configuration file.                                                                                                                                                                                                                                                                                                                                                                                                                                                                       |

The following example shows how to set an SNMP community. Name the community as the nms-monitor, and allow the NMS to view and modify parameters of View:

**Switch#configure**



```
Switch(config)#snmp-server community nms-monitor read-write View
```

```
Switch(config)#show snmp-server community
```

| Index | Name        | Type       | MIB-View |
|-------|-------------|------------|----------|
| ----- | -----       | -----      | -----    |
| 1     | nms-monitor | read-write | View     |

```
Switch(config)#end
```

```
Switch#copy running-config startup-config
```

# 3 Notification Configurations

With Notification enabled, the switch can send notifications to the NMS about important events relating to the device's operation. This facilitates the monitoring and management of the NMS.

## Configuration Guidelines

- To guarantee the communication between the switch and the NMS, ensure the switch and the NMS are able to reach one another.
- Functions of the SNMP Extend Trap can be configured only with CLI. If needed, please refer to *(Optional) Enabling the SNMP Extend Trap*, *(Optional) Enabling the VLAN Trap*, and *(Optional) Enabling the Link-status Trap*.

## 3.1 Using the GUI

Choose the menu **SNMP > Notification > Notification Config** to load the following page.

Figure 3-1 Notification Config

**Host Config**

|                 |                                   |                 |                                           |                                                                               |
|-----------------|-----------------------------------|-----------------|-------------------------------------------|-------------------------------------------------------------------------------|
| IP Address:     | <input type="text"/>              | UDP Port:       | <input type="text" value="162"/>          | <input type="button" value="Create"/><br><input type="button" value="Clear"/> |
| User:           | <input type="text"/>              | IP Mode:        | <input type="text" value="IPv4"/>         |                                                                               |
| Security Model: | <input type="text" value="v1"/>   | Security Level: | <input type="text" value="noAuthNoPriv"/> |                                                                               |
| Type:           | <input type="text" value="Trap"/> |                 |                                           |                                                                               |
| Retry:          | <input type="text"/>              | (1-255)         |                                           |                                                                               |
| Timeout:        | <input type="text"/>              | sec(1-3600)     |                                           |                                                                               |

**Notification Table**

| Select                 | IP Address | IP Mode | UDP Port | User | Security Model | Security Level | Type | Retry | Timeout | Operation |
|------------------------|------------|---------|----------|------|----------------|----------------|------|-------|---------|-----------|
| No entry in the table. |            |         |          |      |                |                |      |       |         |           |

Follow these steps to configure notification:

- 1) Specify the IP address of the host, the UDP port that sends notifications, and choose the IP mode according to the network environment.

### IP Address

If you set the **IP Mode** to IPv4, specify an IPv4 address for the host.

If you set the **IP Mode** to IPv6, specify an IPv6 address for the host..

### UDP Port

Specify a UDP port on the host to send notifications. The default is port 162. For communication security, we recommend that you change the port number under the condition that communications on other UDP ports are not affected.

- |         |                                                                                  |
|---------|----------------------------------------------------------------------------------|
| IP Mode | Choose an IP mode for the host, which should be coordinated with the IP Address. |
|---------|----------------------------------------------------------------------------------|
- 2) Specify the user name or community name used by the NMS, and configure the security model and security level based on the settings of the user or community.
- |                |                                                                                                                                                                                                                                                                                                                                                                                                                                                                       |
|----------------|-----------------------------------------------------------------------------------------------------------------------------------------------------------------------------------------------------------------------------------------------------------------------------------------------------------------------------------------------------------------------------------------------------------------------------------------------------------------------|
| User Name      | Specify the user name or community name used by the NMS.                                                                                                                                                                                                                                                                                                                                                                                                              |
| Security Model | <p>Choose the corresponding SNMP version for the NMS.</p> <p>The version should be consistent with settings of the user or community.</p> <p>v1: The NMS uses SNMPv1.</p> <p>v2: The NMS uses SNMPv2c.</p> <p>v3: The NMS uses SNMPv3.</p>                                                                                                                                                                                                                            |
| Security Level | <p>Choose the security level for the NMS that uses SNMPv3. The setting should be consistent with that of the specified user or community.</p> <p>noAuthNoPriv: No authentication mode or privacy mode is applied to check or encrypt packets.</p> <p>authNoPriv: An authentication mode is applied to check packets, but no privacy mode to encrypt packets.</p> <p>authPriv: An authentication mode and a privacy mode are applied to check and encrypt packets.</p> |
- 3) Choose a notification type based on the SNMP version. If you choose the Inform type, you need to set retry times and timeout interval.
- |         |                                                                                                                                                                                                                                                                                                                                                                                                                                                                                                                                                                                                                                                                                          |
|---------|------------------------------------------------------------------------------------------------------------------------------------------------------------------------------------------------------------------------------------------------------------------------------------------------------------------------------------------------------------------------------------------------------------------------------------------------------------------------------------------------------------------------------------------------------------------------------------------------------------------------------------------------------------------------------------------|
| Type    | <p>Choose a notification type for the NMS that uses SNMPv2c or SNMPv3; the default type is Trap.</p> <p>Trap: Set the switch to send Trap messages to the NMS. When the NMS receives a trap message, it will not send a response to the switch. Thus the switch cannot determine whether the trap is received or not, and the trap that is not received will not be resent.</p> <p>Inform: Set the switch to send Inform messages to the NMS. When the NMS receives an Inform message, it sends a response to the switch. If the switch does not receive a response within the Timeout interval, it will resend the Inform message. Therefore, Informs are more reliable than Traps.</p> |
| Retry   | Set the retry times for Informs; the default is 3. The switch will resend the Inform message if it does not receive response from the NMS within the timeout interval. It will stop sending Inform messages when the retry time reaches the limit.                                                                                                                                                                                                                                                                                                                                                                                                                                       |
| Timeout | Set the length of time that the switch waits for a response from the NMS after sending an inform message; the default is 100 seconds. Set the length of time that the switch waits for a response from the NMS after sending an inform message; the default is 100 seconds.                                                                                                                                                                                                                                                                                                                                                                                                              |
- 4) Click **Create**.

## 3.2 Using the CLI

### 3.2.1 Configuring the Host

Configure parameters of the NMS host and packet handling mechanism.

|        |                                                                                                                                                                                                                                                                                                                                                                                                                                                                                                                                                                                                                                                                                                                                                                                                                                                                                                                                                                                                                                                                                                                                                                                                                                                                                                                                                                                                                                                                                                                                                                                                                                                                                                                                                                                                                                                                                                                                                                                                                                                                                                                                                                                                                                                                                                                                                                                                                                                                                                                                                                                                                                        |
|--------|----------------------------------------------------------------------------------------------------------------------------------------------------------------------------------------------------------------------------------------------------------------------------------------------------------------------------------------------------------------------------------------------------------------------------------------------------------------------------------------------------------------------------------------------------------------------------------------------------------------------------------------------------------------------------------------------------------------------------------------------------------------------------------------------------------------------------------------------------------------------------------------------------------------------------------------------------------------------------------------------------------------------------------------------------------------------------------------------------------------------------------------------------------------------------------------------------------------------------------------------------------------------------------------------------------------------------------------------------------------------------------------------------------------------------------------------------------------------------------------------------------------------------------------------------------------------------------------------------------------------------------------------------------------------------------------------------------------------------------------------------------------------------------------------------------------------------------------------------------------------------------------------------------------------------------------------------------------------------------------------------------------------------------------------------------------------------------------------------------------------------------------------------------------------------------------------------------------------------------------------------------------------------------------------------------------------------------------------------------------------------------------------------------------------------------------------------------------------------------------------------------------------------------------------------------------------------------------------------------------------------------------|
| Step 1 | <p><b>configure</b></p> <p>Enter global configuration mode.</p>                                                                                                                                                                                                                                                                                                                                                                                                                                                                                                                                                                                                                                                                                                                                                                                                                                                                                                                                                                                                                                                                                                                                                                                                                                                                                                                                                                                                                                                                                                                                                                                                                                                                                                                                                                                                                                                                                                                                                                                                                                                                                                                                                                                                                                                                                                                                                                                                                                                                                                                                                                        |
| Step 2 | <p><b>snmp-server host</b> <i>ip udp-port user-name</i> [<b>smode</b> { v1   v2c   v3 }] [<b>slev</b> {noAuthNoPriv   authNoPriv   authPriv }] [<b>type</b> { trap   inform}] [<b>retries</b> <i>retries</i>] [<b>timeout</b> <i>timeout</i>]</p> <p>Configure parameters of the NMS host and packet handling mechanism.</p> <p><i>ip</i>: Specify the IP address of the NMS Host in IPv4 or IPv6. Please make sure the IP addresses of the Host and the switch are able to reach to each other.</p> <p><i>udp-port</i>: Specify a UDP port on the host to send notifications. The default is port 162. For communication security, we recommend that you change the port number under the condition that communications on other UDP ports are not affected.</p> <p><i>user-name</i>: Enter the name used by the NMS. When the NMS uses SNMPv1 or SNMPv2c, enter the Community Name; when the NMS uses SNMPv3, enter the User Name of the SNMP Group.</p> <p><i>v1   v2c   v3</i> : Choose a security mode for the SNMP group from the following: SNMPv1, SNMPv2c, SNMPv3.</p> <p><i>noAuthNoPriv   authNoPriv   authPriv</i>: For SNMPv3 groups, choose a security level from noAuthNoPriv (no authorization and no encryption), authNoPriv (authorization and no encryption), authPriv (authorization and encryption). The default is noAuthNoPriv. Please note that if you have chosen v1 or v2c as the security mode, security level cannot be configured.</p> <p><i>trap   inform</i>: Choose the information type which is only for SNMPv2c or SNMPv3; the default is trap. When the NMS receives a trap message, it will not send a response to the switch. Thus the switch cannot determine whether the trap is received or not, and the trap that is not received will not be resent. When the NMS receives an Inform message, it will send a response to the switch. If the switch does not receive a response within the Timeout interval, it will resend the Inform message. Therefore, Informs are more reliable than Traps.</p> <p><i>retries</i> : Set the retry times for Inform messages. The range is 1 to 255 and the default is 3. The switch will resend the Inform message if it does not receive response from the NMS within the timeout interval. And it will stop sending Inform message when the retry times reaches the limit.</p> <p><i>timeout</i> : Set the length of time that the switch waits for a response. The range is 1 to 3600 seconds; the default is 100 seconds. The switch will resend the Inform message if it does not receive a response from the NMS within the timeout interval.</p> |
| Step 3 | <p><b>show snmp-server host</b></p> <p>Displays the information of the host.</p>                                                                                                                                                                                                                                                                                                                                                                                                                                                                                                                                                                                                                                                                                                                                                                                                                                                                                                                                                                                                                                                                                                                                                                                                                                                                                                                                                                                                                                                                                                                                                                                                                                                                                                                                                                                                                                                                                                                                                                                                                                                                                                                                                                                                                                                                                                                                                                                                                                                                                                                                                       |
| Step 4 | <p><b>end</b></p> <p>Return to privileged EXEC mode.</p>                                                                                                                                                                                                                                                                                                                                                                                                                                                                                                                                                                                                                                                                                                                                                                                                                                                                                                                                                                                                                                                                                                                                                                                                                                                                                                                                                                                                                                                                                                                                                                                                                                                                                                                                                                                                                                                                                                                                                                                                                                                                                                                                                                                                                                                                                                                                                                                                                                                                                                                                                                               |

**Step 5**      **copy running-config startup-config**

Save the settings in the configuration file.

The following example shows how to set the NMS host IP address as 172.168.1.222, UDP port as port 162, name used by the NMS as admin, security model as SNMPv3, security level as authPriv, notification type as Inform, retry times as 3, and the timeout interval as 100 seconds:

**Switch#configure**

```
Switch(config)#snmp-server host 172.168.1.222 162 admin smode v3 slev authPriv type
inform retries 3 timeout 100
```

**Switch(config)#show snmp-server host**

| No. | Des-IP        | UDP   | Name  | SecMode | SecLev   | Type   | Retry | Timeout |
|-----|---------------|-------|-------|---------|----------|--------|-------|---------|
| --- | -----         | ----- | ----  | -----   | -----    | ----   | ----- | -----   |
| 1   | 172.168.1.222 | 162   | admin | v3      | authPriv | inform | 3     | 100     |

**Switch(config)#end****Switch#copy running-config startup-config**

## 3.2.2 Enabling SNMP Notification

- Enabling the SNMP Standard Trap

**Step 1**      **configure**

Enter global configuration mode.

**Step 2**      **snmp-server traps snmp [ linkup | linkdown | warmstart | coldstart | auth-failure ]**

Configure parameters of basic traps supported on the switch.

*linkup:* When a port status changes from linkdown to linkup, the switch sends a linkup trap. The trap is enabled by default. And the trap can be triggered when you connect a device to a port.

*linkdown:* When a port status changes from linkup to linkdown, the switch sends a linkdown trap. The trap is enabled by default and can be triggered when you disconnect the device from the port.

*warmstart:* The trap indicates the SNMP feature on the switch is reinitialized with the physical configuration unchanged. The trap is enabled by default and can be triggered if you disable and then enable SNMP after the SNMP is completely configured and enabled.

*coldstart:* The trap indicates an SNMP initialization caused by the reinitialization of the switch system. The trap is enabled by default. The trap can be triggered when you reboot the switch.

*auth-failure:* The switch will send the trap when the SNMP request fails in authentication. The trap is enabled by default.

- 
- |        |                                               |
|--------|-----------------------------------------------|
| Step 3 | <b>end</b><br>Return to privileged EXEC mode. |
|--------|-----------------------------------------------|
- 
- |        |                                                                                           |
|--------|-------------------------------------------------------------------------------------------|
| Step 4 | <b>copy running-config startup-config</b><br>Save the settings in the configuration file. |
|--------|-------------------------------------------------------------------------------------------|
- 

The following example shows how to configure the switch to send linkup traps:

**Switch#configure**

**Switch(config)#snmp-server traps snmp linkup**

**Switch(config)#end**

**Switch#copy running-config startup-config**

■ (Optional) Enabling the SNMP Extend Trap

- 
- |        |                                                      |
|--------|------------------------------------------------------|
| Step 1 | <b>configure</b><br>Enter global configuration mode. |
|--------|------------------------------------------------------|
- 
- |        |                                                                                                                                   |
|--------|-----------------------------------------------------------------------------------------------------------------------------------|
| Step 2 | <b>snmp-server traps { bandwidth-control   cpu   flash   lldp   loopback-detection   storm-control   spanning-tree   memory }</b> |
|--------|-----------------------------------------------------------------------------------------------------------------------------------|
- Configure parameters of extended traps supported on the switch.
- bandwidth-control:** The trap is used to monitor whether the bandwidth has reached the limit that you have set. The trap is disabled by default. The trap can be triggered when the feature is enabled and packets are sent to the port with a rate higher than what you have set.
- cpu:** The trap is used to monitor the load status of the switch CPU. And the trap is disabled by default. The trap can be triggered when the utilization rate of the CPU has exceeded the limit that you have set. The limit of CPU utilization rate for the switch is 80% by default.
- flash:** The trap is used to monitor whether the flash is modified. And the trap is disabled by default. The trap can be triggered when the flash is modified by saving configurations, factory resetting, upgrading and importing configurations.
- lldp:** The trap is used to monitor LLDP. And the trap is disabled by default. The trap can be triggered when any changes occur on the adjacent port.
- loopback-detection:** The feature is used to detect loopbacks. And the trap is disabled by default. The system will generate the trap when a loopback is detected or cleared.
- storm-control:** The feature is used to monitor network storms. And the trap is disabled by default. The system will generate the trap when the rate of broadcast or multicast reaches the limit of storm control.
- spanning-tree:** The feature is used to monitor the spanning tree status. And the trap is disabled by default. The system will generate the trap in the following situations: a port changes from non-forwarding state to forwarding state or the other way round; a port receives a packet with TC flag or a TCN packet.
- memory:** The feature is used to monitor the memory. And the trap is disabled by default. The system will generate the trap when the memory utilization exceeds 80%.
-

- 
- |        |                                               |
|--------|-----------------------------------------------|
| Step 3 | <b>end</b><br>Return to privileged EXEC mode. |
|--------|-----------------------------------------------|
- 
- |        |                                                                                           |
|--------|-------------------------------------------------------------------------------------------|
| Step 4 | <b>copy running-config startup-config</b><br>Save the settings in the configuration file. |
|--------|-------------------------------------------------------------------------------------------|
- 

The following example shows how to configure the switch to enable bandwidth-control traps:

```
Switch#configure
```

```
Switch(config)#snmp-server traps bandwidth-control
```

```
Switch(config)#end
```

```
Switch#copy running-config startup-config
```

- (Optional) Enabling the VLAN Trap

- 
- |        |                                                      |
|--------|------------------------------------------------------|
| Step 1 | <b>configure</b><br>Enter global configuration mode. |
|--------|------------------------------------------------------|
- 
- |        |                                                                                                                                                                                                                                                                                                                                                       |
|--------|-------------------------------------------------------------------------------------------------------------------------------------------------------------------------------------------------------------------------------------------------------------------------------------------------------------------------------------------------------|
| Step 2 | <b>snmp-server traps vlan [ create   delete ]</b><br>Enable SNMP extended VLAN-related traps.<br><br><b>create:</b> Enable VLAN-created trap. It is sent when new VLAN is created successfully. By default, it is disabled.<br><br><b>delete:</b> Enable VLAN-deleted trap. It is sent when VLAN is deleted successfully. By default, it is disabled. |
|--------|-------------------------------------------------------------------------------------------------------------------------------------------------------------------------------------------------------------------------------------------------------------------------------------------------------------------------------------------------------|
- 
- |        |                                               |
|--------|-----------------------------------------------|
| Step 3 | <b>end</b><br>Return to privileged EXEC mode. |
|--------|-----------------------------------------------|
- 
- |        |                                                                                           |
|--------|-------------------------------------------------------------------------------------------|
| Step 4 | <b>copy running-config startup-config</b><br>Save the settings in the configuration file. |
|--------|-------------------------------------------------------------------------------------------|
- 

The following example shows how to configure the switch to enable VLAN-created trap:

```
Switch#configure
```

```
Switch(config)#snmp-server traps vlan create
```

```
Switch(config)#end
```

```
Switch#copy running-config startup-config
```

- (Optional) Enabling the Link-status Trap

- 
- |        |                                                      |
|--------|------------------------------------------------------|
| Step 1 | <b>configure</b><br>Enter global configuration mode. |
|--------|------------------------------------------------------|
-

- 
- Step 2      **interface {fastEthernet *port* | range fastEthernet *port-list* | gigabitEthernet *port* | range gigabitEthernet *port-list* | ten-gigabitEthernet *port* | range ten-gigabitEthernet *port-list* }**
- Configure notification traps on the specified ports.
- port/port-list*: The number or the list of the Ethernet ports that you desire to configure notification traps.
- 
- Step 3      **snmp-server traps link-status**
- Enable SNMP extended linkup and linkdown traps. By default, it is disabled.
- 
- Step 4      **end**
- Return to privileged EXEC mode.
- 
- Step 5      **copy running-config startup-config**
- Save the settings in the configuration file.
- 

The following example shows how to configure the switch to enable link-status trap:

**Switch#configure**

**Switch(config)#interface ten-gigabitEthernet 1/0/1**

**Switch(config-if)#snmp-server traps link-status**

**Switch(config-if)#end**

**Switch#copy running-config startup-config**



# 4 RMON Overview

RMON (Remote Network Monitoring) together with the SNMP system allows the network manager to monitor remote network devices efficiently. RMON reduces traffic flow between the NMS and managed devices, which is convenient for management in large networks.

RMON includes two parts: the NMS and the Agents running on every network device. The NMS is usually a host that runs the management software to manage Agents of network devices. And the Agent is usually a switch or router that collects traffic statistics (such as total packets on a network segment during a certain time period, or total correct packets that are sent to a host). Based on SNMP protocol, the NMS collects network data through communication with Agents. However, the NMS cannot obtain every datum of RMON MIB because of the limited device resources. Generally, the NMS can only get information of the following four groups: statistics, history, event and alarm.

# 5 RMON Configurations

With RMON configurations, you can:

- Configuring the statistics group.
- Configuring the history group.
- Configuring the event group.
- Configuring the alarm group.

## Configuration Guidelines

To ensure that the NMS receives notifications normally, please complete configurations of SNMP and SNMP Notification before RMON configurations.

## 5.1 Using the GUI

### 5.1.1 Configuring Statistics

Choose the menu **SNMP > RMON > Statistics** to load the following page.

Figure 5-1 Statistics Config

**Statistics Config**

ID:  (1-65535)

Port:   (Format: 1/0/1)

Owner:  (16 characters maximum)

Status:

**Statistics Table**

| Select                 | ID | Port | Owner | Status | Operation |
|------------------------|----|------|-------|--------|-----------|
| No entry in the table. |    |      |       |        |           |

Specify the entry ID, the port to be monitored, and the owner name of the entry. Set the entry as valid or underCreation, and click **Create**.

|               |                                                                                                                                                                         |
|---------------|-------------------------------------------------------------------------------------------------------------------------------------------------------------------------|
| <b>ID</b>     | Enter the ID of the entry.                                                                                                                                              |
| <b>Port</b>   | Click <b>Choose</b> to specify an Ethernet port to be monitored in the entry, or enter the port number in the format of 1/0/1.                                          |
| <b>Owner</b>  | Enter the owner name of the entry with 1 to 16 characters.                                                                                                              |
| <b>Status</b> | Set the entry as valid or underCreation. By default, it is valid.<br><br>Valid: The entry is created and valid.<br><br>underCreation: The entry is created but invalid. |

### 5.1.2 Configuring History

Choose the menu **SNMP > RMON > History** to load the following page.

Figure 5-2 History Control Table

| History Control Table    |       |                      |                      |                      |                      |                                |
|--------------------------|-------|----------------------|----------------------|----------------------|----------------------|--------------------------------|
| Select                   | Index | Port                 | Interval(sec)        | Max Buckets          | Owner                | Status                         |
| <input type="checkbox"/> |       | <input type="text"/> | <input type="text"/> | <input type="text"/> | <input type="text"/> | <input type="text" value="▼"/> |
| <input type="checkbox"/> | 1     | 1/0/1                | 1800                 | 50                   | monitor              | Disable                        |
| <input type="checkbox"/> | 2     | 1/0/1                | 1800                 | 50                   | monitor              | Disable                        |
| <input type="checkbox"/> | 3     | 1/0/1                | 1800                 | 50                   | monitor              | Disable                        |
| <input type="checkbox"/> | 4     | 1/0/1                | 1800                 | 50                   | monitor              | Disable                        |
| <input type="checkbox"/> | 5     | 1/0/1                | 1800                 | 50                   | monitor              | Disable                        |
| <input type="checkbox"/> | 6     | 1/0/1                | 1800                 | 50                   | monitor              | Disable                        |
| <input type="checkbox"/> | 7     | 1/0/1                | 1800                 | 50                   | monitor              | Disable                        |
| <input type="checkbox"/> | 8     | 1/0/1                | 1800                 | 50                   | monitor              | Disable                        |
| <input type="checkbox"/> | 9     | 1/0/1                | 1800                 | 50                   | monitor              | Disable                        |
| <input type="checkbox"/> | 10    | 1/0/1                | 1800                 | 50                   | monitor              | Disable                        |
| <input type="checkbox"/> | 11    | 1/0/1                | 1800                 | 50                   | monitor              | Disable                        |
| <input type="checkbox"/> | 12    | 1/0/1                | 1800                 | 50                   | monitor              | Disable                        |

Follow these steps to configure history:

- 1) Select a history entry, and specify a port to be monitored.

|              |                                                                                                    |
|--------------|----------------------------------------------------------------------------------------------------|
| <b>Index</b> | Displays the index of history entries. There are 12 history entries all together.                  |
| <b>Port</b>  | Specify a port in 1/0/1 format to be monitored. To change the port, please enable the entry first. |

- 2) Set the sample interval and the maximum buckets of history entries.

|                    |                                                                                                                                                                                                                               |
|--------------------|-------------------------------------------------------------------------------------------------------------------------------------------------------------------------------------------------------------------------------|
| <b>Interval</b>    | Set the sample interval from 10 to 3600 seconds; the default is 1800 seconds. Every history entry has its own timer. For the monitored port, the switch collects packet information and generates a record in every interval. |
| <b>Max Buckets</b> | Set the maximum number of records for the history entry. When the number of records exceeds the limit, the earliest record will be overwritten. The ranges are from 10 to 130; the default is 50.                             |

3) Enter the owner name, and set the status of the entry. Click **Apply**.

|               |                                                                                                                                      |
|---------------|--------------------------------------------------------------------------------------------------------------------------------------|
| <b>Owner</b>  | Enter the owner name of the entry with 1 to 16 characters. By default, it is monitor.                                                |
| <b>Status</b> | Enable or disable the entry. By default, it is disabled.<br><br>Enable: The entry is enabled.<br><br>Disable: The entry is disabled. |

### 5.1.3 Configuring Event

Choose the menu **SNMP > RMON > Event** to load the following page.

Figure 5-3 Event Table

| Event Table              |       |                      |                      |                                   |                      |                                      |
|--------------------------|-------|----------------------|----------------------|-----------------------------------|----------------------|--------------------------------------|
| Select                   | Index | User                 | Description          | Type                              | Owner                | Status                               |
| <input type="checkbox"/> |       | <input type="text"/> | <input type="text"/> | <input type="text" value="None"/> | <input type="text"/> | <input type="text" value="Disable"/> |
| <input type="checkbox"/> | 1     | public               |                      | None                              | monitor              | Disable                              |
| <input type="checkbox"/> | 2     | public               |                      | None                              | monitor              | Disable                              |
| <input type="checkbox"/> | 3     | public               |                      | None                              | monitor              | Disable                              |
| <input type="checkbox"/> | 4     | public               |                      | None                              | monitor              | Disable                              |
| <input type="checkbox"/> | 5     | public               |                      | None                              | monitor              | Disable                              |
| <input type="checkbox"/> | 6     | public               |                      | None                              | monitor              | Disable                              |
| <input type="checkbox"/> | 7     | public               |                      | None                              | monitor              | Disable                              |
| <input type="checkbox"/> | 8     | public               |                      | None                              | monitor              | Disable                              |
| <input type="checkbox"/> | 9     | public               |                      | None                              | monitor              | Disable                              |
| <input type="checkbox"/> | 10    | public               |                      | None                              | monitor              | Disable                              |
| <input type="checkbox"/> | 11    | public               |                      | None                              | monitor              | Disable                              |
| <input type="checkbox"/> | 12    | public               |                      | None                              | monitor              | Disable                              |

Follow these steps to configure event:

1) Choose an event entry, and set the SNMP User of the entry.

|              |                                                                                                                                             |
|--------------|---------------------------------------------------------------------------------------------------------------------------------------------|
| <b>Index</b> | Displays the index of event entries. There are 12 event entries all together.                                                               |
| <b>User</b>  | Enter the SNMP user name or community name of the entry. The name should be what you have set in SNMP previously. By default, it is public. |

2) Set the description and type of the event.

|                    |                                                                                                                                                                                                                                                                                                                                                                                                                                                            |
|--------------------|------------------------------------------------------------------------------------------------------------------------------------------------------------------------------------------------------------------------------------------------------------------------------------------------------------------------------------------------------------------------------------------------------------------------------------------------------------|
| <b>Description</b> | Teve a description to the event.                                                                                                                                                                                                                                                                                                                                                                                                                           |
| <b>Type</b>        | <p>Specify the action type of the event; then the switch will take the specified action to deal with the event. By default, the type is None.</p> <p>None: No action.</p> <p>Log: The switch records the event in the log, and the NMS should initiate requests to get notifications.</p> <p>Notify: The switch initiates notifications to the NMS.</p> <p>Log&amp;Notify: The switch records the event in the log and sends notifications to the NMS.</p> |

3) Enter the owner name, and set the status of the entry. Click **Apply**.

|               |                                                                                                                                             |
|---------------|---------------------------------------------------------------------------------------------------------------------------------------------|
| <b>Owner</b>  | Enter the owner name of the entry with 1 to 16 characters. By default, it is monitor.                                                       |
| <b>Status</b> | <p>Enable or disable the entry. By default, it is disabled.</p> <p>Enable: The entry is enabled.</p> <p>Disable: The entry is disabled.</p> |

### 5.1.4 Configuring Alarm

Before you begin, please complete configurations of Statistics entries and Event entries, because the Alarm entries must be associated with Statistics and Event entries.

Choose the menu **SNMP > RMON > Alarm** to load the following page.

Figure 5-4 Alarm Config

| Select                   | Index | Variable | Statistics | Sample Type | Rising Threshold | Rising Event | Falling Threshold | Falling Event | Alarm Type | Interval(sec) | Owner   | Status  |
|--------------------------|-------|----------|------------|-------------|------------------|--------------|-------------------|---------------|------------|---------------|---------|---------|
| <input type="checkbox"/> |       |          |            |             |                  |              |                   |               |            |               |         |         |
| <input type="checkbox"/> | 1     | RecBytes |            | Absolute    | 100              |              | 100               |               | All        | 1800          | monitor | Disable |
| <input type="checkbox"/> | 2     | RecBytes |            | Absolute    | 100              |              | 100               |               | All        | 1800          | monitor | Disable |
| <input type="checkbox"/> | 3     | RecBytes |            | Absolute    | 100              |              | 100               |               | All        | 1800          | monitor | Disable |
| <input type="checkbox"/> | 4     | RecBytes |            | Absolute    | 100              |              | 100               |               | All        | 1800          | monitor | Disable |
| <input type="checkbox"/> | 5     | RecBytes |            | Absolute    | 100              |              | 100               |               | All        | 1800          | monitor | Disable |
| <input type="checkbox"/> | 6     | RecBytes |            | Absolute    | 100              |              | 100               |               | All        | 1800          | monitor | Disable |
| <input type="checkbox"/> | 7     | RecBytes |            | Absolute    | 100              |              | 100               |               | All        | 1800          | monitor | Disable |
| <input type="checkbox"/> | 8     | RecBytes |            | Absolute    | 100              |              | 100               |               | All        | 1800          | monitor | Disable |
| <input type="checkbox"/> | 9     | RecBytes |            | Absolute    | 100              |              | 100               |               | All        | 1800          | monitor | Disable |
| <input type="checkbox"/> | 10    | RecBytes |            | Absolute    | 100              |              | 100               |               | All        | 1800          | monitor | Disable |
| <input type="checkbox"/> | 11    | RecBytes |            | Absolute    | 100              |              | 100               |               | All        | 1800          | monitor | Disable |
| <input type="checkbox"/> | 12    | RecBytes |            | Absolute    | 100              |              | 100               |               | All        | 1800          | monitor | Disable |

Follow these steps to configure alarm:

- 1) Select an alarm entry, choose a variable to be monitored, and associate the entry with a statistics entry.

|              |                                                                               |
|--------------|-------------------------------------------------------------------------------|
| <b>Index</b> | Displays the index of alarm entries. There are 12 alarm entries all together. |
|--------------|-------------------------------------------------------------------------------|

|                                                                                                                                   |                                                                                                                                                                                                                                                                                                                                                                                                                                                                                                                                                                                                                                                                                                                                                                                                                                             |
|-----------------------------------------------------------------------------------------------------------------------------------|---------------------------------------------------------------------------------------------------------------------------------------------------------------------------------------------------------------------------------------------------------------------------------------------------------------------------------------------------------------------------------------------------------------------------------------------------------------------------------------------------------------------------------------------------------------------------------------------------------------------------------------------------------------------------------------------------------------------------------------------------------------------------------------------------------------------------------------------|
| <b>Variable</b>                                                                                                                   | <p>Set the alarm variable to be monitored. The switch will monitor the specified variable in sample intervals and act in the set way when the alarm is triggered. The default variable is RecBytes.</p> <p>RecBytes: Total received bytes.</p> <p>RecPackets: Total received packets.</p> <p>BPackets: Total broadcast packets.</p> <p>MPackets: Total multicast packets.</p> <p>CRC&amp;Align ERR: Packets that range from 64 to 1518 bytes and contain FCS Error or Alignment Error.</p> <p>Undersize: Packets that are smaller than 64 bytes.</p> <p>Oversize: Packets that are larger than 1518 bytes.</p> <p>Jabbers: Packets that are sent when port collisions occur.</p> <p>Collisions: Collision times in the network segment.</p> <p>64, 65-127, 128-255, 256-511, 512-1023, 1024-10240: Total packets of the specified size.</p> |
| <b>Statistics</b>                                                                                                                 | <p>Associate the alarm entry with a statistics entry. Then the switch monitors the specified variable of the statistics entry.</p>                                                                                                                                                                                                                                                                                                                                                                                                                                                                                                                                                                                                                                                                                                          |
| <p>2) Set the sample type, the rising and falling threshold, the corresponding event action, and the alarm type of the entry.</p> |                                                                                                                                                                                                                                                                                                                                                                                                                                                                                                                                                                                                                                                                                                                                                                                                                                             |
| <b>Sample Type</b>                                                                                                                | <p>Set the sampling method of the specified variable; the default is absolute.</p> <p>Absolute: Compare the sampling value against the preset threshold.</p> <p>Delta: The switch obtains the difference between the sampling values of the current interval and the previous interval, and then compares the difference against the preset threshold.</p>                                                                                                                                                                                                                                                                                                                                                                                                                                                                                  |
| <b>Rising Threshold</b>                                                                                                           | <p>Set the rising threshold of the variable. When the sampled value exceeds the threshold, the system will trigger the corresponding <b>Rising Event</b>. The ranges are from 1 to 2147483647; the default is 100.</p>                                                                                                                                                                                                                                                                                                                                                                                                                                                                                                                                                                                                                      |
| <b>Rising Event</b>                                                                                                               | <p>Specify the index of the event that will be triggered when the sampled value exceeds the preset threshold.</p>                                                                                                                                                                                                                                                                                                                                                                                                                                                                                                                                                                                                                                                                                                                           |
| <b>Falling Threshold</b>                                                                                                          | <p>Set the falling threshold of the variable. When the sampled value is below the threshold, the system will trigger the corresponding <b>Falling Event</b>. The ranges are from 1 to 2147483647; the default is 100.</p>                                                                                                                                                                                                                                                                                                                                                                                                                                                                                                                                                                                                                   |
| <b>Falling Event</b>                                                                                                              | <p>Specify the index of the event that will be triggered when the sampled value is below the preset threshold.</p>                                                                                                                                                                                                                                                                                                                                                                                                                                                                                                                                                                                                                                                                                                                          |

---

|                   |                                                                                                                    |
|-------------------|--------------------------------------------------------------------------------------------------------------------|
| <b>Alarm Type</b> | Specify the alarm type for the entry. By default, the alarm type is all.                                           |
|                   | Rising: The alarm is triggered only when the sampled value exceeds the rising threshold.                           |
|                   | Falling: The alarm is triggered only when the sampled value is below the falling threshold.                        |
|                   | All: The alarm is triggered when the sampled value exceeds the rising threshold or is below the falling threshold. |

---

3) Enter the owner name, and set the status of the entry. Click **Apply**.

---

|               |                                                                                       |
|---------------|---------------------------------------------------------------------------------------|
| <b>Owner</b>  | Enter the owner name of the entry with 1 to 16 characters. By default, it is monitor. |
| <b>Status</b> | Enable or disable the entry. By default, it is disabled.                              |
|               | Enable: The entry is enabled.                                                         |
|               | Disable: The entry is disabled.                                                       |

---

## 5.2 Using the CLI

### 5.2.1 Configuring Statistics

---

|        |                                                                                                                                                                                                                                                                                                                                                                                                                                                                                                                                                                                                                                                                                                                                                                                             |
|--------|---------------------------------------------------------------------------------------------------------------------------------------------------------------------------------------------------------------------------------------------------------------------------------------------------------------------------------------------------------------------------------------------------------------------------------------------------------------------------------------------------------------------------------------------------------------------------------------------------------------------------------------------------------------------------------------------------------------------------------------------------------------------------------------------|
| Step 1 | <b>configure</b><br>Enter global configuration mode.                                                                                                                                                                                                                                                                                                                                                                                                                                                                                                                                                                                                                                                                                                                                        |
| Step 2 | <b>rmon statistics</b> <i>index</i> <b>interface</b> {[ <b>gigabitEthernet</b> <i>port</i> ] [ <b>ten-gigabitEthernet</b> <i>port</i> ]} [ <b>owner</b> <i>owner-name</i> ] [ <b>status</b> { underCreation   valid }]<br>Configure RMON statistic entries.<br><br><i>index</i> : Enter the ID of the statistics entry from 1 to 65535 in the format of 1-3 or 5.<br><br><i>port</i> : Enter the port number in 1/0/1 format to bind it to the entry.<br><br><i>owner-name</i> : Enter the owner name of the entry with 1 to 16 characters. The default name is monitor.<br><br><b>underCreation   valid</b> : Enter the status of the entry. UnderCreation indicates that the entry is created but invalid, while valid indicates the entry is created and valid. By default, it is valid. |
| Step 3 | <b>show rmon statistics</b> [ <i>index</i> ]<br>Displays the statistics entries and their configurations.<br><br><i>index</i> : Enter the index of statistics entries that you want to view. The ranges are from 1 to 65535.                                                                                                                                                                                                                                                                                                                                                                                                                                                                                                                                                                |
| Step 4 | <b>end</b><br>Return to privileged EXEC mode.                                                                                                                                                                                                                                                                                                                                                                                                                                                                                                                                                                                                                                                                                                                                               |

---

- 
- Step 5      **copy running-config startup-config**  
Save the settings in the configuration file.
- 

The following example shows how to create two statistics entries on the switch to monitor port 1/0/1 and 1/0/2 respectively. The owner of the entry is monitor and the entry is valid:

**Switch#configure**

**Switch(config)#rmon statistics 1 interface ten-gigabitEthernet 1/0/1 owner monitor status valid**

**Switch(config)#rmon statistics 2 interface ten-gigabitEthernet 1/0/2 owner monitor status valid**

**Switch(config)#show rmon statistics**

| Index | Port    | Owner   | State |
|-------|---------|---------|-------|
| ----- | ----    | -----   | ----- |
| 1     | Te1/0/1 | monitor | valid |
| 2     | Te1/0/2 | monitor | valid |

**Switch(config)#end**

**Switch#copy running-config startup-config**

## 5.2.2 Configuring History

- 
- Step 1      **configure**  
Enter global configuration mode.
- 

- Step 2      **rmon history index interface { fastEthernet port | gigabitEthernet port | ten-gigabitEthernet port } [ interval seconds ] [ owner owner-name ] [ buckets number ]**

Configuring RMON history entries.

*index*: Enter the index of the history entry from 1 to 12 in the format of 1-3 or 5.

*port*: Enter the port number in 1/0/1 format to bind it to the entry.

*seconds*: Set the sample interval. The values are from 10 to 3600 seconds; the default is 1800 seconds.

*owner-name*: Enter the owner name of the entry with 1 to 16 characters. The default name is monitor.

*number*: Set the maximum number of records for the history entry. When the number of records exceeds the limit, the earliest record will be overwritten. The values are from 10 to 130; the default is 50.

---



---

**Step 3**      **show rmon history [ *index* ]**

Displays the specified history entry and related configurations.

*index*: Enter the index of history entries that you want to view. The range is 1 to 12, and the format is 1-3 or 5.

---

**Step 4**      **end**

Return to privileged EXEC mode.

---

**Step 5**      **copy running-config startup-config**

Save the settings in the configuration file.

---

The following example shows how to create a history entry on the switch to monitor port 1/0/1. Set the sample interval as 100 seconds, max buckets as 50, and the owner as monitor:

**Switch#configure****Switch(config)#rmon history 1 interface ten-gigabitEthernet 1/0/1 interval 100 owner monitor buckets 50****Switch(config)#show rmon history**

| Index | Port    | Interval | Buckets | Owner   | State  |
|-------|---------|----------|---------|---------|--------|
| 1     | Te1/0/1 | 100      | 50      | monitor | Enable |

**Switch(config)#end****Switch#copy running-config startup-config**

## 5.2.3 Configuring Event

---

**Step 1**      **configure**

Enter global configuration mode.

- 
- Step 2      **rmon event** *index* [ **user** *user-name* ] [ **description** *description* ] [ **type** { none | log | notify | log-notify } ] [ **owner** *owner-name* ]
- Configuring RMON event entries.
- index*: Enter the index of the event entry from 1 to 12 in the format of 1-3 or 5.
- user-name*: Enter the SNMP user name or community name of the entry. The name should be what you have set in SNMP previously. The default name is public.
- description*: Teve a description to the entry with 1 to 16 characters. By default, the description is empty.
- none | log | notify | log-notify*: Specify the action type of the event; then the switch will take the specified action to deal with the event. By default, the type is none. None indicates the switch takes no action, log indicates the switch records the event, notify indicates the switch sends notifications to the NMS, and log-notify indicates the switch records the event and sends notifications to the NMS.
- owner-name*: Enter the owner name of the entry with 1 to 16 characters. The default name is monitor.
- 
- Step 3      **show rmon event** [ *index* ]
- Displays the specified event entry and related configurations.
- index*: Enter the index of event entries that you want to view. The range is 1 to 12, and the format is 1-3 or 5.
- 
- Step 4      **end**
- Return to privileged EXEC mode.
- 
- Step 5      **copy running-config startup-config**
- Save the settings in the configuration file.
- 

The following example shows how to create an event entry on the switch. Set the user name as admin, the event type as Notify (set the switch to initiate notifications to the NMS), and the owner as monitor:

**Switch#configure**

**Switch(config)#rmon event 1 user admin description rising-notify type notify owner monitor**

**Switch(config)#show rmon event**

| Index | User  | Description   | Type   | Owner   | State  |
|-------|-------|---------------|--------|---------|--------|
| ----- | ----  | -----         | ----   | -----   | -----  |
| 1     | admin | rising-notify | Notify | monitor | Enable |

**Switch(config)#end**

**Switch#copy running-config startup-config**

## 5.2.4 Configuring Alarm

Step 1

**configure**

Enter global configuration mode.

Step 2

**rmon alarm** *index* { **stats-index** *sindex* } [ **alarm-variable** { revbyte | revpkt | bpkt | mpkt | crc-align | undersize | oversize | jabber | collision | 64 | 65-127 | 128-255 | 256-511 | 512-1023 | 1024-10240 } ] [ **s-type** { absolute | delta } ] [ **rising-threshold** *r-hold* ] [ **rising-event-index** *r-event* ] [ **falling-threshold** *f-hold* ] [ **falling-event-index** *f-event* ] [ **a-type** { rise | fall | all } ] [ **owner** *owner-name* ] [ **interval** *interval* ]

Configuring RMON alarm entries.

*index*: Enter the index of the alarm entry from 1 to 12 in the format of 1-3 or 5.

*sindex*: Set the index of the related statistics entry from 1 to 65535.

*revbyte* | *revpkt* | *bpkt* | *mpkt* | *crc-align* | *undersize* | *oversize* | *jabber* | *collision* | 64 | 65-127 | 128-255 | 256-511 | 512-1023 | 1024-10240: Choose an alarm variable to monitor. The switch will monitor the specified variable in sample intervals and act in the set way when the alarm is triggered. The default variable is revbyte.

*revbyte* means total received bytes; *revpkt* means total received packets; *bpkt* means total broadcast packets. *mpkt* means total multicast packets; *crc-align* means packets that range from 64 to 1518 bytes and contain FCS Error or Alignment Error; *undersize* means packets that are smaller than 64 bytes; *oversize* means packets that are larger than 1518 bytes; *jabber* means packets that are sent when port collisions occur; *collision* means the collision times in the network segment; 64 | 65-127 | 128-255 | 256-511 | 512-1023 | 1024-10240 means total packets of the specified size.

*absolute* | *delta*: Choose the sampling mode. The default is absolute. In the absolute mode, the switch compares the sampling value against the preset threshold; in the delta mode, the switch obtains the difference between the sampling values of the current interval and the previous interval, and then compares the difference against the preset threshold.

*r-hold*: Enter the rising threshold from 1 to 2147483647; the default is 100.

*r-event*: Enter the event entry index from 1 to 12 to bind it to the rising threshold. The event entry will be triggered when the sampling value exceeds the preset threshold.

*f-hold*: Enter a falling threshold from 1 to 2147483647; the default is 100.

*f-event*: Enter the event entry index from 1 to 12 to bind it to the falling threshold. The event entry will be triggered when the sampling value goes below the preset threshold.

*rise* | *fall* | *all*: Choose an alarm type; the default is all. Rise indicates that the alarm is triggered only when the sampled value exceeds the rising threshold. Fall indicates that the alarm is triggered only when the sampled value is below the falling threshold. All indicates that the alarm is triggered when the sampled value exceeds the rising threshold or is below the falling threshold.

*owner-name*: Enter the owner name of the entry using 1 to 16 characters. The default name is monitor.

*interval*: Set the sampling interval. The value ranges from 10 to 3600 seconds; the default is 1800 seconds.

---

|        |                                                                                                                                                                                                                                                     |
|--------|-----------------------------------------------------------------------------------------------------------------------------------------------------------------------------------------------------------------------------------------------------|
| Step 3 | <p><b>show rmon alarm [ <i>index</i> ]</b></p> <p>Displays the specified alarm entry and related configurations.</p> <p><i>index</i>: Enter the index of alarm entries that you want to view. The range is 1 to 12, and the format is 1-3 or 5.</p> |
| Step 4 | <p><b>end</b></p> <p>Return to privileged EXEC mode.</p>                                                                                                                                                                                            |
| Step 5 | <p><b>copy running-config startup-config</b></p> <p>Save the settings in the configuration file.</p>                                                                                                                                                |

---

The following example shows how to set an alarm entry to monitor Bpackets on the switch. Set the related Statistics entry ID as 1, the sample type as Absolute, the rising threshold as 3000, the related rising event entry index as 1, the falling threshold as 2000, the related falling event index as 2, the alarm type as all, the notification interval as 10 seconds, and the owner of the entry as monitor:

#### Switch#configure

```
Switch(config)#rmon alarm 1 stats-index 1 alarm-variable bpkt s-type absolute rising-
threshold 3000 rising-event-index 1 falling-threshold 2000 falling-event-index 2 a-type
all interval 10 owner monitor
```

#### Switch(config)#show rmon alarm

```
Index-State:    1-Enabled
Statistics index: 1
Alarm variable:  BPkt
Sample Type:    Absolute
RHold-REvent:  3000-1
FHold-FEvent:   2000-2
Alarm startup:  All
Interval:       10
Owner:          monitor
```

#### Switch(config)#end

#### Switch#copy running-config startup-config

# 6 Configuration Example

## 6.1 Network Requirements

A company that deploys NMS to monitor the operation status of TP-Link switches has requirements as follows:

- 1) Monitor traffic flow of specified ports, and send notifications to the NMS when the actual rate of transmitting and receiving packets exceeds the preset threshold.
- 2) Monitor the sending status of specified ports, and regularly collect and save data for follow-up checks. Specifically, during the sample interval, the switch should notify the NMS when the number of packets transmitted and received on the port exceeds the preset threshold; the switch should record but not notify the NMS when the number of packets transmitted and received is below the threshold.

## 6.2 Configuration Scheme

- 1) Set a limit on the rate of the specified ports, and then enable SNMP on Switch A. Configure SNMP and Notification, and enable Trap notifications on the ports. Switch A can then send notifications to the NMS when the actual rate exceeds the preset threshold.
- 2) After SNMP and Notification configurations, you need to create statistic entries on the ports to monitor the real-time transmitting and receiving of packets and create history entries to regularly collect and save related data. Create two event entries: one is the notify type used to notify the NMS, the other is the log type used to record related events. In addition, create an alarm entry to monitor BPkets (Broadcast Packets), set the rising threshold and falling threshold, and bind the rising event to the notify event entry, and the falling event to the log event entry.

## 6.3 Network Topology

As shown in the following figure, the NMS host with IP address 172.168.1.222 is connected to the core switch, Switch B. On Switch A, ports 1/0/1 and 1/0/2 are monitored by the NMS; port 1/0/3 is connected to Switch B. And port 1/0/3 and the NMS are able to reach one another.

Figure 6-1 Network Topology

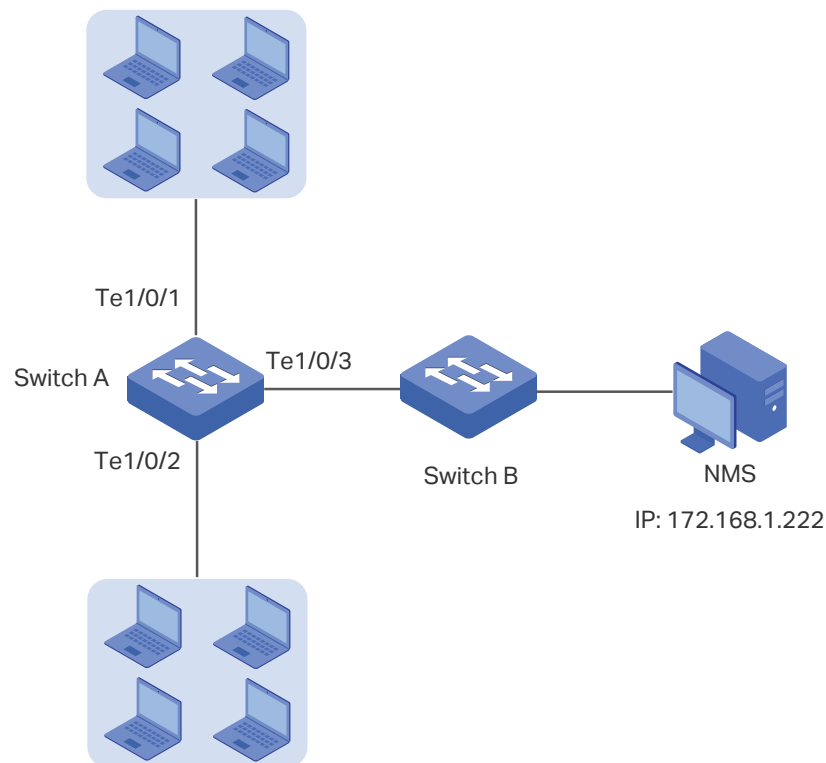

Demonstrated with T1700X-16TS, this chapter provides configuration procedures in two ways: using the GUI and using the CLI.

## 6.4 Using the GUI

- **Configuring Rate Limit on ports**

Configure the rate limit on required ports. For detailed configuration, please refer to *Configuring QoS*.

- **Configuring SNMP**

- 1) Choose **SNMP > SNMP Config > Global Config** to load the following page. Enable SNMP, and set the Remote Engine ID as 123456789a. Click **Apply**.

Figure 6-2 Enabling SNMP

**Global Config**

SNMP:  **Enable**  Disable

---

**Local Engine**

Local Engine ID:  (10-64 Hex)

---

**Remote Engine**

Remote Engine ID:  (0 or 10-64 Hex)

- 2) Choose **SNMP > SNMP Config > SNMP View** to load the following page. Name the SNMP view as View, set MIB Object ID as 1 (which means all functions), and set the view type as Include. Click **Create**.

Figure 6-3 SNMP View Configuration

**View Config**

View Name:  (16 characters maximum)

MIB Object ID:  (61 characters maximum)

View Type:  **Include**  Exclude

---

**View Table**

| Select                   | View Name   | View Type | MIB Object ID  |
|--------------------------|-------------|-----------|----------------|
| <input type="checkbox"/> | viewDefault | Include   | 1              |
| <input type="checkbox"/> | viewDefault | Exclude   | 1.3.6.1.6.3.15 |
| <input type="checkbox"/> | viewDefault | Exclude   | 1.3.6.1.6.3.16 |
| <input type="checkbox"/> | viewDefault | Exclude   | 1.3.6.1.6.3.18 |

- 3) Choose **SNMP > SNMP Config > SNMP Group** to load the following page. Create a group with the name of nms-monitor, choose SNMPv3 and enable authentication and privacy, and add View to Read View and Notify View. Click **Create**.

Figure 6-4 SNMP Group Configuration

**Group Config**

Group Name:  (16 characters maximum)

Security Model:

Security Level:

Read View:

Write View:

Notify View:

---

**Group Table**

| Select                 | Group Name | Security Model | Security Level | Read View | Write View | Notify View | Operation |
|------------------------|------------|----------------|----------------|-----------|------------|-------------|-----------|
| No entry in the table. |            |                |                |           |            |             |           |

- 4) Choose **SNMP > SNMP Config > SNMP User** to load the following page. Create a user named admin for the NMS, set the user type as Remote User and specify the group name. Set the Security Model and Security Level in accordance with those of the group mms-monitor. Choose SHA authentication algorithm and DES privacy algorithm, and set corresponding passwords. Click **Create**.

Figure 6-5 User Config

**User Config**

User Name:  (16 characters maximum)

User Type:

Security Model:

Auth Mode:

Privacy Mode:

Group Name:

Security Level:

Auth Password:  (16 characters maximum)

Privacy Password:  (16 characters maximum)

---

**User Table**

| Select                 | User Name | User Type | Group Name | Security Model | Security Level | Auth Mode | Privacy Mode | Operation |
|------------------------|-----------|-----------|------------|----------------|----------------|-----------|--------------|-----------|
| No entry in the table. |           |           |            |                |                |           |              |           |

- 5) Choose **SNMP > Notification > Notification Config** to load the following page. Specify the IP address of the NMS host and the port of the host for transmitting notifications. Set the User, Security Model and Security Level according to configurations of the SNMP User. Choose the type as Inform, and set the retry times as 3, with the timeout period as 100 seconds. Click **Create**.



Figure 6-6 Notification Configuration

**Host Config**

IP Address: 172.168.1.222      UDP Port: 162

User: admin      IP Mode: IPv4

Security Model: v3      Security Level: authPriv

Type: Inform

Retry: 3 (1-255)

Timeout: 100 sec(1-3600)

Create  
Clear

---

**Notification Table**

| Select                 | IP Address | IP Mode | UDP Port | User | Security Model | Security Level | Type | Retry | Timeout | Operation |
|------------------------|------------|---------|----------|------|----------------|----------------|------|-------|---------|-----------|
| No entry in the table. |            |         |          |      |                |                |      |       |         |           |

All    Delete    Help

6) Click **Save Config** to save the settings.

- Enabling Bandwith-control Trap

The feature can be configured only with the CLI. You can enter the following commands under the CLI configuration mode:

Switch>enable      Enter Privileged EXEC Mode.

Switch#config      Enter global configuration mode.

Switch(config)#snmp-server traps bandwidth-control      Enable Bandwith-control trap.

- Configuring RMON

1) Choose **SNMP > RMON > Statistics** to load the following page. Create two entries and bind them to ports 1/0/1 and 1/0/2 respectively. Set the owner of the entries as monitor and the status as valid.

Figure 6-7 Configuring Entry 1

**Statistics Config**

ID: 1 (1-65535)

Port: 1/0/1 Choose (Format: 1/0/1)

Owner: monitor (16 characters maximum)

Status: valid

Create  
Clear

---

**Statistics Table**

| Select                 | ID | Port | Owner | Status | Operation |
|------------------------|----|------|-------|--------|-----------|
| No entry in the table. |    |      |       |        |           |

All    Delete    Help

Figure 6-8 Configuring Entry 2

**Statistics Config**

ID:  (1-65535)

Port:   (Format: 1/0/1)

Owner:  (16 characters maximum)

Status:

---

**Statistics Table**

| Select                   | ID | Port  | Owner   | Status | Operation            |
|--------------------------|----|-------|---------|--------|----------------------|
| <input type="checkbox"/> | 1  | 1/0/1 | monitor | valid  | <a href="#">Edit</a> |

- 2) Choose the menu **SNMP > RMON > History** to load the following page. Configure entries 1 and 2. Bind entries 1 and 2 to ports 1/0/1 and 1/0/2 respectively, and set the Interval as 100 seconds, Max Buckets as 50, the owner of the entries as monitor, and the status as Enable.

Figure 6-9 History Configuration

**History Control Table**

| Select                   | Index | Port                 | Interval(sec)        | Max Buckets          | Owner                | Status                         |
|--------------------------|-------|----------------------|----------------------|----------------------|----------------------|--------------------------------|
| <input type="checkbox"/> |       | <input type="text"/> | <input type="text"/> | <input type="text"/> | <input type="text"/> | <input type="text" value="▼"/> |
| <input type="checkbox"/> | 1     | 1/0/1                | 100                  | 50                   | monitor              | Enable                         |
| <input type="checkbox"/> | 2     | 1/0/2                | 100                  | 50                   | monitor              | Enable                         |
| <input type="checkbox"/> | 3     | 1/0/1                | 1800                 | 50                   | monitor              | Disable                        |
| <input type="checkbox"/> | 4     | 1/0/1                | 1800                 | 50                   | monitor              | Disable                        |
| <input type="checkbox"/> | 5     | 1/0/1                | 1800                 | 50                   | monitor              | Disable                        |
| <input type="checkbox"/> | 6     | 1/0/1                | 1800                 | 50                   | monitor              | Disable                        |
| <input type="checkbox"/> | 7     | 1/0/1                | 1800                 | 50                   | monitor              | Disable                        |
| <input type="checkbox"/> | 8     | 1/0/1                | 1800                 | 50                   | monitor              | Disable                        |
| <input type="checkbox"/> | 9     | 1/0/1                | 1800                 | 50                   | monitor              | Disable                        |
| <input type="checkbox"/> | 10    | 1/0/1                | 1800                 | 50                   | monitor              | Disable                        |
| <input type="checkbox"/> | 11    | 1/0/1                | 1800                 | 50                   | monitor              | Disable                        |
| <input type="checkbox"/> | 12    | 1/0/1                | 1800                 | 50                   | monitor              | Disable                        |

- 3) Choose the menu **SNMP > RMON > Event** to load the following page. Configure entries 1 and 2. For entry 1, set the SNMP user name as admin, type as Notify, description as "rising notify", owner as monitor, and status as enable. For entry 2, set the SNMP user name as admin, type as Log, description as "falling log", owner as monitor, and status as enable.

Figure 6-10 Event Configuration

| Event Table              |       |        |               |        |         |         |
|--------------------------|-------|--------|---------------|--------|---------|---------|
| Select                   | Index | User   | Description   | Type   | Owner   | Status  |
| <input type="checkbox"/> |       |        |               |        |         |         |
| <input type="checkbox"/> | 1     | admin  | rising notify | Notify | monitor | Enable  |
| <input type="checkbox"/> | 2     | admin  | failing       | Log    | monitor | Enable  |
| <input type="checkbox"/> | 3     | public |               | None   | monitor | Disable |
| <input type="checkbox"/> | 4     | public |               | None   | monitor | Disable |
| <input type="checkbox"/> | 5     | public |               | None   | monitor | Disable |
| <input type="checkbox"/> | 6     | public |               | None   | monitor | Disable |
| <input type="checkbox"/> | 7     | public |               | None   | monitor | Disable |
| <input type="checkbox"/> | 8     | public |               | None   | monitor | Disable |
| <input type="checkbox"/> | 9     | public |               | None   | monitor | Disable |
| <input type="checkbox"/> | 10    | public |               | None   | monitor | Disable |
| <input type="checkbox"/> | 11    | public |               | None   | monitor | Disable |
| <input type="checkbox"/> | 12    | public |               | None   | monitor | Disable |

- Choose **SNMP > RMON > Alarm** to load the following page. Configure entries 1 and 2. For entry 1, set the alarm variable as Bpackets, related statistics entry ID as 1 (bound to port 1/0/1), the sample type as Absolute, the rising threshold as 3000, associated rising event entry ID as 1 (which is the notify type), the falling threshold as 2000, the associated falling event entry ID as 2 (which is the log type), the alarm type as all, the interval as 10 seconds, the owner name as monitor. For entry 2, set the associated statistics entry ID as 2 (bound to port 1/0/2). Other configurations are the same as those of entry 1.

Figure 6-11 Alarm Configuration

| Alarm Config             |       |          |            |             |                  |              |                   |               |            |               |         |         |
|--------------------------|-------|----------|------------|-------------|------------------|--------------|-------------------|---------------|------------|---------------|---------|---------|
| Select                   | Index | Variable | Statistics | Sample Type | Rising Threshold | Rising Event | Falling Threshold | Falling Event | Alarm Type | Interval(sec) | Owner   | Status  |
| <input type="checkbox"/> |       |          |            |             |                  |              |                   |               |            |               |         |         |
| <input type="checkbox"/> | 1     | Bpackets | 1          | Absolute    | 3000             | 1            | 2000              | 2             | All        | 10            | monitor | Enable  |
| <input type="checkbox"/> | 2     | Bpackets | 2          | Absolute    | 3000             | 1            | 2000              | 2             | All        | 10            | monitor | Enable  |
| <input type="checkbox"/> | 3     | RecBytes |            | Absolute    | 100              |              | 100               |               | All        | 1800          | monitor | Disable |
| <input type="checkbox"/> | 4     | RecBytes |            | Absolute    | 100              |              | 100               |               | All        | 1800          | monitor | Disable |
| <input type="checkbox"/> | 5     | RecBytes |            | Absolute    | 100              |              | 100               |               | All        | 1800          | monitor | Disable |
| <input type="checkbox"/> | 6     | RecBytes |            | Absolute    | 100              |              | 100               |               | All        | 1800          | monitor | Disable |
| <input type="checkbox"/> | 7     | RecBytes |            | Absolute    | 100              |              | 100               |               | All        | 1800          | monitor | Disable |
| <input type="checkbox"/> | 8     | RecBytes |            | Absolute    | 100              |              | 100               |               | All        | 1800          | monitor | Disable |
| <input type="checkbox"/> | 9     | RecBytes |            | Absolute    | 100              |              | 100               |               | All        | 1800          | monitor | Disable |
| <input type="checkbox"/> | 10    | RecBytes |            | Absolute    | 100              |              | 100               |               | All        | 1800          | monitor | Disable |
| <input type="checkbox"/> | 11    | RecBytes |            | Absolute    | 100              |              | 100               |               | All        | 1800          | monitor | Disable |
| <input type="checkbox"/> | 12    | RecBytes |            | Absolute    | 100              |              | 100               |               | All        | 1800          | monitor | Disable |

- Click **Save Config** to save settings.

## 6.5 Using the CLI

- Configuring Rate Limit on ports

Configure the rate limit on required ports. For detailed configuration, please refer to [Configuring QoS](#).

### ■ Configuring SNMP

- 1) Enable SNMP and specify the remote engine ID.

```
Switch#configure
```

```
Switch(config)#snmp-server
```

```
Switch(config)#snmp-server engineID remote 123456789a
```

- 2) Create a view with the name View; set the MIB Object ID as 1 (which represents all functions), and the view type as Include.

```
Switch(config)#snmp-server view View 1 include
```

- 3) Create a group of SNMPv3 with the name of nms-monitor. Enable Auth Mode and Privacy Mode, and set the view as read View and notify view.

```
Switch(config)#snmp-server group nms-monitor smode v3 slev authPriv read View notify View
```

- 4) Create an SNMP user with the name admin. Set the user as a remote user and configure the security mode and security level based on the group. Set the Auth Mode as SHA algorithm, password as 1234, the Privacy Mode as DES, and password as 1234.

```
Switch(config)#snmp-server user admin remote nms-monitor smode v3 slev authPriv cmode SHA cpwd 1234 emode DES epwd 1234
```

- 5) To configure Notification, specify the IP address of the NMS host and UDP port. Set the User, Security Model and Security Level according to configurations of the SNMP User. Choose the type as Inform, and set the retry times as 3, and the timeout period as 100 seconds.

```
Switch(config)#snmp-server host 172.168.1.222 162 admin smode v3 slev authPriv type inform retries 3 timeout 100
```

### ■ Enable Bandwidth-control Trap

```
Switch(config)#snmp-server traps bandwidth-control
```

### ■ Configuring RMON

- 1) Create two Statistics entries to monitor ports 1/0/1 and 1/0/2 respectively. The owner of the entries is set as monitor, and the status is set as valid.

```
Switch(config)#rmon statistics 1 interface ten-gigabitEthernet 1/0/1 owner monitor status valid
```

```
Switch(config)#rmon statistics 2 interface ten-gigabitEthernet 1/0/2 owner monitor status valid
```

- 2) Create two history entries and bind them to ports 1/0/1 and 1/0/2 respectively. Set the sample interval as 100 seconds, max buckets as 50, and the owner as monitor.

```
Switch(config)#rmon history 1 interface ten-gigabitEthernet 1/0/1 interval 100 owner monitor buckets 50
```

```
Switch(config)#rmon history 2 interface ten-gigabitEthernet 1/0/2 interval 100 owner monitor buckets 50
```

- 3) Create two event entries named admin, which is the SNMP user name. Set entry 1 as the Notify type and its description as "rising notify". Set entry 2 as the Log type and its description as "falling log". Set the owner of them as monitor.

```
Switch(config)#rmon event 1 user admin description rising-notify type notify owner monitor
```

```
Switch(config)#rmon event 2 user admin description falling-log type log owner monitor
```

- 4) Create two alarm entries. For entry 1, set the alarm variable as BPkets, associated statistics entry ID as 1 (bound to port 1/0/1), the sample type as Absolute, the rising threshold as 3000, the associated rising event entry ID as 1 (Notify type), the falling threshold as 2000, the associated falling event entry ID as 2 (the log type), the alarm type as all, the interval as 10 seconds, and the owner name as monitor. For entry 2, set the associated statistics entry ID as 2 (bound to port 1/0/2), while all other configurations are the same as those of entry 1.

```
Switch(config)#rmon alarm 1 stats-index 1 alarm-variable bpkt s-type absolute rising-threshold 3000 rising-event-index 1 falling-threshold 2000 falling-event-index 2 a-type all interval 10 owner monitor
```

```
Switch(config)#rmon alarm 2 stats-index 2 alarm-variable bpkt s-type absolute rising-threshold 3000 rising-event-index 1 falling-threshold 2000 falling-event-index 2 a-type all interval 10 owner monitor
```

## Verify the Configurations

Verify global SNMP configurations:

```
Switch(config)#show snmp-server
```

SNMP agent is enabled.

- 0 SNMP packets input
- 0 Bad SNMP version errors
- 0 Unknown community name
- 0 Illegal operation for community name supplied
- 0 Encoding errors
- 0 Number of requested variables
- 0 Number of altered variables
- 0 Get-request PDUs
- 0 Get-next PDUs
- 0 Set-request PDUs
- 0 SNMP packets output

```

0 Too big errors(Maximum packet size 1500)
0 No such name errors
0 Bad value errors
0 General errors
0 Response PDUs
0 Trap PDUs

```

Verify SNMP engine ID:

```

Switch(config)#show snmp-server engineID
Local engine ID : 80002e5703000aeb132397
Remote engine ID: 123456789a

```

Verify SNMP view configurations:

```

Switch(config)#show snmp-server view

```

| No. | View Name   | Type    | MOID           |
|-----|-------------|---------|----------------|
| 1   | viewDefault | include | 1              |
| 2   | viewDefault | exclude | 1.3.6.1.6.3.15 |
| 3   | viewDefault | exclude | 1.3.6.1.6.3.16 |
| 4   | viewDefault | exclude | 1.3.6.1.6.3.18 |
| 5   | View        | include | 1              |

Verify SNMP group configurations:

```

Switch(config)#show snmp-server group

```

| No. | Name        | Sec-Mode | Sec-Lev  | Read-View | Write-View | Notify-View |
|-----|-------------|----------|----------|-----------|------------|-------------|
| 1   | nms-monitor | v3       | authPriv | View      |            | View        |

Verify SNMP user configurations:

```

Switch(config)#show snmp-server user

```

| No. | U-Name | U-Type | G-Name | S-Mode | S-Lev | A-Mode | P-Mode |
|-----|--------|--------|--------|--------|-------|--------|--------|
|     |        |        |        |        |       |        |        |

```
1 admin remote nms-monitor v3 authPriv SHA DES
```

Verify SNMP host configurations:

```
Switch(config)#show snmp-server host
```

| No. | Des-IP        | UDP | Name  | SecMode | SecLev   | Type   | Retry | Timeout |
|-----|---------------|-----|-------|---------|----------|--------|-------|---------|
| 1   | 172.168.1.222 | 162 | admin | v3      | authPriv | inform | 3     | 100     |

Verify RMON statistics configurations:

```
Switch(config)#show rmon statistics
```

| Index | Port    | Owner   | State |
|-------|---------|---------|-------|
| 1     | Te1/0/1 | monitor | valid |
| 2     | Te1/0/2 | monitor | valid |

Verify RMON history configurations:

```
Switch(config)#show rmon history
```

| Index | Port    | Interval | Buckets | Owner   | State  |
|-------|---------|----------|---------|---------|--------|
| 1     | Te1/0/1 | 100      | 50      | monitor | Enable |
| 2     | Te1/0/2 | 100      | 50      | monitor | Enable |

Verify RMON event configurations:

```
Switch(config)#show rmon event
```

| Index | User  | Description   | Type   | Owner   | State  |
|-------|-------|---------------|--------|---------|--------|
| 1     | admin | rising-notify | Notify | monitor | Enable |
| 2     | admin | falling-log   | Log    | monitor | Enable |

Verify RMON alarm configurations:

```
Switch(config)#show rmon alarm
```

```
Index-State:      1-Enabled
```

```
Statistics index: 1
```

```
Alarm variable:   BPkt
```

```
Sample Type:     Absolute
```

```
RHold-REvent:    3000-1
```

```
FHold-FEvent:    2000-2
```

```
Alarm startup:   All
```

```
Interval:        10
```

```
Owner:           monitor
```

```
Index-State:      2-Enabled
```

```
Statistics index: 2
```

```
Alarm variable:   BPkt
```

```
Sample Type:     Absolute
```

```
RHold-REvent:    3000-1
```

```
FHold-FEvent:    2000-2
```

```
Alarm startup:   All
```

```
Interval:        10
```

```
Owner:           monitor
```



# 7 Appendix: Default Parameters

Default settings of SNMP are listed in the following table.

Table 7-1 Default Global Config Settings

| Parameter        | Default Setting |
|------------------|-----------------|
| SNMP             | Disable         |
| Local Engine ID  | Automatically   |
| Remote Engine ID | None            |

Table 7-2 Default SNMP View Settings

| Parameter     | Default Setting |
|---------------|-----------------|
| View Name     | None            |
| MIB Object ID | None            |
| View Type     | Include         |

Table 7-3 Default SNMP View Table Settings

| View Name   | View Type | MIB Object ID  |
|-------------|-----------|----------------|
| viewDefault | Include   | 1              |
| viewDefault | Exclude   | 1.3.6.1.6.3.15 |
| viewDefault | Exclude   | 1.3.6.1.6.3.16 |
| viewDefault | Exclude   | 1.3.6.1.6.3.18 |

Table 7-4 Default Group Settings

| Parameter      | Default Setting |
|----------------|-----------------|
| Group Name     | None            |
| Security Model | v1              |
| Security Level | noAuthNoPriv    |
| Read View      | viewDefault     |
| Write View     | None            |
| Notify View    | None            |

Table 7-5 Default User Settings

| Parameter        | Default Setting |
|------------------|-----------------|
| User Name        | None            |
| User Type        | Local User      |
| Group Name       | None            |
| Security Model   | v1              |
| Security Level   | noAuthNoPriv    |
| Auth Mode        | None            |
| Auth Password    | None            |
| Privacy Mode     | None            |
| Privacy Password | None            |

Table 7-6 Default Community Settings

| Parameter      | Default Setting |
|----------------|-----------------|
| Community Name | None            |
| Access         | read-only       |
| MIB View       | viewDefault     |

Default settings of Notification are listed in the following table.

Table 7-7 Default Host Config Settings

| Parameter      | Default Setting                                |
|----------------|------------------------------------------------|
| IP Address     | None                                           |
| UDP Port       | 162                                            |
| User           | None                                           |
| IP Mode        | IPv4                                           |
| Security Model | v1                                             |
| Security Level | noAuthNoPriv                                   |
| Type           | Trap                                           |
| Retry          | None in trap mode; 3 times in Inform mode.     |
| Timeout        | None in trap mode; 100 seconds in Inform mode. |

Table 7-8 Default Statistics Config Settings

| Parameter | Default Setting |
|-----------|-----------------|
| ID        | None            |
| Port      | None            |
| Owner     | None            |
| IP Mode   | valid           |

Table 7-9 Default Settings for History Entries

| Parameter   | Default Setting |
|-------------|-----------------|
| Port        | 1/0/1           |
| Interval    | 1800 seconds    |
| Max Buckets | 50              |
| Owner       | monitor         |
| Status      | Disable         |

Table 7-10 Default Settings for Event Entries

| Parameter   | Default Setting |
|-------------|-----------------|
| User        | public          |
| Description | None            |
| Type        | None            |
| Owner       | monitor         |
| Status      | Disable         |

Table 7-11 Default Settings for Alarm Entries

| Parameter         | Default Setting |
|-------------------|-----------------|
| Variable          | RecBytes        |
| Statistics        | None            |
| Sample Type       | Absolute        |
| Rising Threshold  | 100             |
| Rising Event      | None            |
| Falling Threshold | 100             |
| Falling Event     | None            |
| Alarm Type        | All             |
| Interval          | 1800 seconds    |
| Owner             | monitor         |

| Parameter | Default Setting |
|-----------|-----------------|
| Status    | Disable         |