

TP-LINK®

User Guide

TL-MC1400

14-Slot Rackmount Chassis



Rev: 1.0.0
7106500762

COPYRIGHT & TRADEMARKS

Specifications are subject to change without notice. **TP-LINK**[®] is a registered trademark of TP-LINK TECHNOLOGIES CO., LTD. Other brands and product names are trademarks or registered trademarks of their respective holders.

No part of the specifications may be reproduced in any form or by any means or used to make any derivative such as translation, transformation, or adaptation without permission from TP-LINK TECHNOLOGIES CO., LTD. Copyright © 2009 TP-LINK TECHNOLOGIES CO., LTD. All rights reserved.

<http://www.tp-link.com>

FCC STATEMENT



This equipment has been tested and found to comply with the limits for a Class A digital device, pursuant to part 15 of the FCC Rules. These limits are designed to provide reasonable protection against harmful interference when the equipment is operated in a commercial environment. This equipment generates, uses, and can radiate radio frequency energy and, if not installed and used in accordance with the instruction manual, may cause harmful interference to radio communications. Operation of this equipment in a residential area is likely to cause harmful interference in which case the user will be required to correct the interference at his own expense.

This device complies with part 15 of the FCC Rules. Operation is subject to the following two conditions:

- 1) This device may not cause harmful interference.
- 2) This device must accept any interference received, including interference that may cause undesired operation.

Any changes or modifications not expressly approved by the party responsible for compliance could void the user's authority to operate the equipment.

CE Mark Warning



This is a class A product. In a domestic environment, this product may cause radio interference, in which case the user may be required to take adequate measures.

Package Contents

The following items should be found in your box:

- One TL-MC1400 14-Slot Rackmount Chassis
- One AC Power Cord (used for the power supply of 110V/220V)
- Fourteen retainer-plates (equipped with locking knobs)
- This User Guide



Note: Make sure that the package contains the above items. If any of the listed items are damaged or missing, please contact with your distributor.

Convention:

TL-MC1400 or the chassis mentioned in this User Guide stands for TL-MC1400 14-Slot Rackmount Chassis without any explanation.

CONTENTS

| | | |
|--------------------|--|----------|
| Chapter 1. | Introduction of the Product..... | 1 |
| 1.1 | Overview of the Product..... | 1 |
| 1.2 | Features..... | 1 |
| 1.3 | Basic Requirements..... | 2 |
| Chapter 2. | Identifying External Components..... | 3 |
| 2.1 | Front Panel | 3 |
| 2.2 | Rear Panel | 3 |
| Chapter 3. | Installation | 4 |
| 3.1 | Installing the Media Converters in the Chassis.. | 4 |
| 3.2 | Mounting the Chassis in the Rack | 5 |
| 3.3 | Power On | 5 |
| Appendix A: | Specifications | 7 |
| Appendix B: | The Product List of MC Series | 8 |

Chapter 1. Introduction of the Product

Thank you for choosing the TL-MC1400 14-Slot Rackmount Chassis.

1.1 Overview of the Product

The TL-MC1400 14-Slot Rackmount Chassis is specially designed for accommodating and managing the MC series Cassette Media Converters. It is a standard 19-inch 2U height rack-mount chassis which can be suitably mounted in the standard 19-inch rack.

With the 14 slots, the TL-MC1400 chassis is able to accommodate up to 14 media converters, which can highly save the space and make the cables neat.

For more important, the TL-MC1400 provides a more reliable and effective solution for the network system since it allows the Hot-plugging of the media converters and power supplies. Meanwhile, an optional additional power supply is available for installation in chassis, which ensures the continuous power for the media converters.

1.2 Features

- Standard 19-inch rack-mountable, 2U height
- 14 slots to accommodate up to 14 media converters
- 2 cooling fans with air filters on the rear panel
- Allows the Hot-plugging for all the media converters and power supplies
- Optional dual-power line inputs available
- Offers the over-voltage and over-current protections
- Supports 100V/220V AC

- Adopts the passive-backplane architecture and ensures the steady power input for each media converter
- Supports TP-LINK full line of media converters

1.3 Basic Requirements

- Place the chassis in a well ventilated dry place.
- Ensure the chassis is electrically connected to ground.
- Avoid directly looking towards the output port of the light modules when the Media Converter is powered on, otherwise it may cause injury to your eyes.

Chapter 2. Identifying External Components

This Chapter describes the front panel and the rear panel of the TL-MC1400 chassis.

2.1 Front Panel

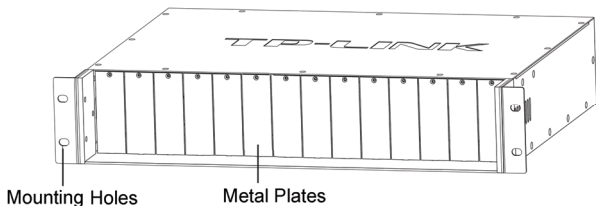

2.2 Rear Panel

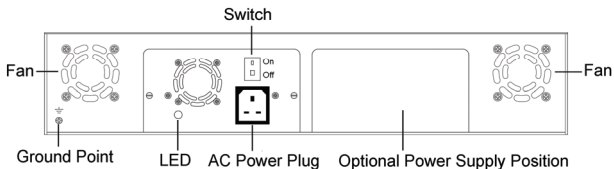

Note: An optional AC or DC power supply is available for installation in the optional power supply position of the chassis.

Chapter 3. Installation

3.1 Installing the Media Converters in the Chassis

To install the media converters in the TL-MC1400 chassis, please follow the steps:

- 1) Firstly, tweak out the two screws on the side near the switch of the media converter. Then install the retainer-plate (provided with the chassis) to the media converter using the screws you just removed from the media converter.

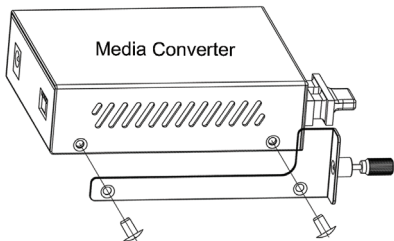

- 2) Secondly, remove the front metal plate of the slot on the chassis, then carefully slide the media converter into the slot and lock it tightly with the equipped locking knob.

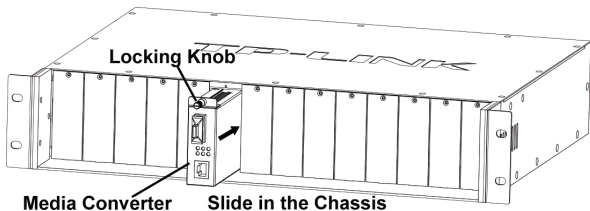

3.2 Mounting the Chassis in the Rack

The dimension of the TL-MC1400 chassis is designed according to the standard 19-inch rack-mountable steel case of Electronic Industries Association.

Power off the chassis before mounting it in the rack, and then fasten it to the rack with screws through the holes of the “L” brackets on each side.

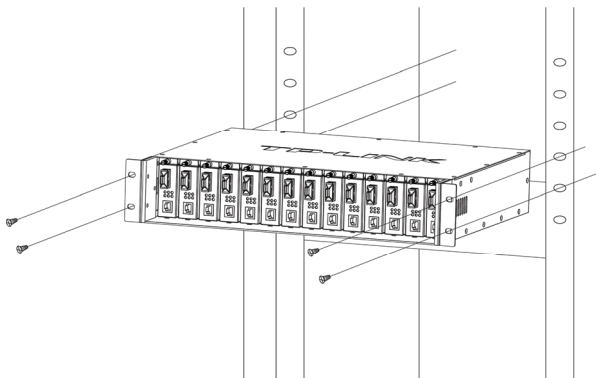

3.3 Power On

1) Connect the chassis to ground

Before connecting the chassis to the power, please make sure the Ground Point of the chassis is electrically connected to ground by wires, as the following figure.

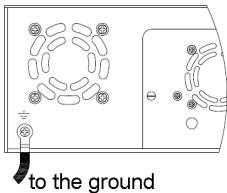

Note: The Ground Point (marked with \equiv) of the chassis is located on the lower left corner of the rear panel.

2) Connect the chassis to the power

Please connect the Chassis's power plug to the AC outlet with the provided power cord as the following figure. Then you can control the power by the switch identified with "On" and "Off".

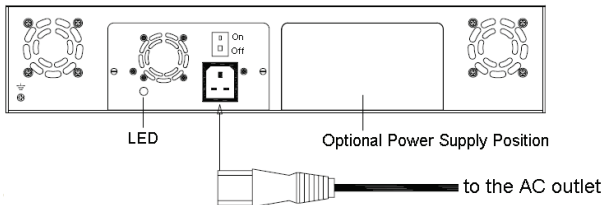

Note: The LED will indicate the working status of the Chassis. A steady light of the LED indicates the Chassis works properly. If the LED is off, it indicates that the Chassis is abnormal.

Appendix A: Specifications

| Environmental and Physical | |
|----------------------------|---|
| AC power supply | Input: 100-240V~ 50/60Hz 3.0A (Max) |
| | Output: +9.5VDC, 9.5A (Max) |
| | $V_{\text{ripple}}: \leq 50\text{mv}$ |
| | Noise: $\leq 100\text{mv}$ |
| Operating Temperature | 0°C - 40°C (32°F ~104°F) |
| Storage Temperature | -40°C - 70°C (-40°F ~158°F) |
| Operating Humidity | 10%~90% non-condensing |
| Storage Humidity | 5%~90% non-condensing |
| Dimensions (W×D×H) | 19.0x14.1x3.4in.(482x358x86mm) Standard 19-Inch, 2U height |
| Weight | 8Kg |

Appendix B: The Product List of MC Series

The Chassis can accommodate 14 Cassette Media Converters of MC series. The detailed types of MC series Cassette Media Converters are listed as below.

| Model | Description |
|---------|--|
| MC100CM | Fast Ethernet Media Converter (10/100M RJ45 to 100M multi-mode SC Fiber) |
| MC110CS | Fast Ethernet Media Converter (10/100M RJ45 to 100M single-mode SC Fiber) |
| MC111CS | WDM Fast Ethernet Media Converter (10/100M RJ45 to 100M single-mode SC Fiber) |
| MC112CS | WDM Fast Ethernet Media Converter (10/100M RJ45 to 100M single-mode SC Fiber) |
| MC200CM | Gigabit Ethernet Media Converter (10/100/1000M RJ45 to 1000M multi-mode SC Fiber) |
| MC210CS | Gigabit Ethernet Media Converter (10/100/1000M RJ45 to 1000M single-mode SC Fiber) |
| MC211CS | WDM Gigabit Ethernet Media Converter (10/100/1000M RJ45 to 1000M single -mode SC Fiber) |
| MC212CS | WDM Gigabit Ethernet Media Converter (10/100/1000M RJ45 to 1000M single -mode SC Fiber) |
| MC220L | Gigabit Ethernet Media Converter (10/100/1000M RJ45 to 1000M multi-mode/single-mode LC Fiber) |



TP-LINK®

TP-LINK TECHNOLOGIES CO., LTD.

<http://www.tp-link.com>