

**TP-LINK®**

# Archer D20

# User Guide

AC750 Wireless Dual Band  
ADSL2+ Modem Router

# Contents

<b>About This Guide</b> .....	<b>1</b>
<b>Chapter 1. Get to Know About Your Modem Router</b> .....	<b>2</b>
1. 1. Product Overview .....	3
1. 2. Main Features .....	4
1. 3. Panel Layout .....	5
1. 3. 1.Top View .....	5
1. 3. 2.The Back Panel .....	7
<b>Chapter 2. Connect the Hardware</b> .....	<b>8</b>
2. 1. Position Your Modem Router .....	9
2. 2. Connect Your Modem Router .....	9
<b>Chapter 3. Log into Your Modem Router</b> .....	<b>12</b>
<b>Chapter 4. Set Up Internet Connections</b> .....	<b>14</b>
4. 1. Use Quick Setup Wizard .....	15
4. 2. Manually Set up an Internet Connection .....	15
4. 3. Set up an IPv6 Connection .....	16
4. 4. Test Internet Connectivity .....	18
<b>Chapter 5. Bandwidth Control</b> .....	<b>19</b>
<b>Chapter 6. Network Security</b> .....	<b>23</b>
6. 1. MAC Filtering .....	24
6. 2. Access Control .....	25
6. 3. IP & MAC Binding .....	27
<b>Chapter 7. IPTV</b> .....	<b>29</b>
<b>Chapter 8. USB Settings</b> .....	<b>31</b>
8. 1. Local Storage Sharing .....	32
8. 1. 1.Access the USB disk .....	32

8. 1. 2.	Customize Your Settings.....	34
8. 2.	Remote Access via FTP Server.....	37
8. 2. 1.	Access the USB disk .....	37
8. 2. 2.	Customize Your Settings.....	40
8. 3.	Media Sharing.....	41
8. 3. 1.	Access the USB disk .....	42
8. 3. 2.	Customize Your Settings.....	43
8. 4.	Printer Sharing .....	44
<b>Chapter 9. Parental Controls.....</b>		<b>49</b>
<b>Chapter 10. Guest Network .....</b>		<b>53</b>
10. 1.	Create a Network for Guests .....	54
10. 2.	Customize Guest Network Options.....	54
<b>Chapter 11. NAT Forwarding.....</b>		<b>56</b>
11. 1.	Share Local Resources in the Internet by Virtual Server.....	57
11. 2.	Open Ports Dynamically by Port Triggering.....	58
11. 3.	Make Applications Free from Port Restriction by DMZ .....	59
11. 4.	Make Xbox Online Games Run Smoothly by UPnP .....	60
<b>Chapter 12. Specify Your Network Settings .....</b>		<b>62</b>
12. 1.	LAN Settings .....	63
12. 1. 1.	Change the LAN IP Address .....	63
12. 1. 2.	Use the Modem Router as a DHCP Server .....	63
12. 1. 3.	Reserve LAN IP Addresses .....	64
12. 2.	Wireless Settings .....	65
12. 2. 1.	Specify Basic Wireless Settings.....	65
12. 2. 2.	Use WPS for Wireless Connection .....	67
12. 2. 3.	Schedule Your Wireless Function .....	69
12. 2. 4.	View Wireless Information.....	70
12. 2. 5.	Advanced Wireless Settings .....	71
12. 3.	Set Up a Dynamic DNS Service Account.....	73
12. 4.	Interface Grouping .....	73
12. 5.	Create Static Routes .....	75
12. 6.	Set up a VPN Connection .....	77
12. 7.	Set Up the IPv6 Tunnel.....	81

12. 7. 1. Use the Public IPv6 Tunnel Service-6to4 .....	81
12. 7. 2. Specify the 6rd Tunnel with Parameters Provided by Your ISP .....	82

**Chapter 13. Administrate Your Network ..... 84**

13. 1. Set System Time and Region .....	85
13. 2. Update the Firmware .....	86
13. 3. Back up and Restore Configuration Settings .....	86
13. 4. Change the Administrator Account .....	87
13. 5. Local Management .....	88
13. 6. Remote Management .....	89
13. 7. System Log .....	89
13. 8. Monitor the Internet Traffic Statistics .....	91
13. 9. CWMP Settings .....	92
13. 10. SNMP Settings .....	94

**Appendix A: Specifications ..... 96**

**Appendix B: Troubleshooting ..... 97**







# About This Guide

This guide provides details of each function and shows how to configure the modem router appropriate to your needs. In addition to this guide, a Quick Installation Guide is also released with each TP-LINK modem router, you are suggested to configure your modem router for quick Internet setup by following the published Quick Installation Guide before you get started with a further configuration.

## Conventions

In this guide the following conventions are used:

Convention	Description
modem router/ router	Stands for AC750 Wireless Dual Band ADSL2+ Modem Router without any explanation.
parameters	Parameters provided in the screenshots are just references for setting up the device, which may differ from the actual situation. You can set the parameters according to your demand.
screenshots	The demonstrated screenshots may look a little different from the actual web page of your device due to the various firmware versions. Please just configure your product based on the actual web page.
<i>Blue Italic</i>	Hyperlinks are in blue italic. You can click to redirect to a website or a specific section.
Blue	Contents to be emphasized and texts on the web page are in blue, including the menus, items, buttons, etc.
>	The menu structures to show the path to load the corresponding page. For example, <a href="#">Advanced</a> > <a href="#">Wireless</a> > <a href="#">MAC Filtering</a> means the MAC Filtering function page is under the Wireless menu that is located in the Advanced tab.
 Note:	Ignoring this type of note might result in a malfunction or damage to the device.
 Tips:	Indicates important information that helps you make better use of your device.
symbols on the web page	<ul style="list-style-type: none"><li> click to edit the corresponding entry.</li><li> click to delete the corresponding entry.</li><li> click to enable or disable the corresponding entry.</li></ul>

## Chapter 1

---

# Get to Know About Your Modem Router

---

This chapter introduces what the modem router can do and shows its main features and appearance.

This chapter contains the following sections:

- *Product Overview*
- *Main Features*
- *Panel Layout*

## 1.1. Product Overview

### What This Product Does

TP-LINK's Archer D20 AC750 Wireless Dual Band ADSL2+ Modem Router is a combined wired/wireless network connection device with integrated wireless router and ADSL modem, reducing hassle of configuration and saving space. Featuring a variety of features and rich functionality, Archer D20 is the perfect hub of your home or business network.

### 802.11ac - The Next Generation of Wi-Fi

TP-LINK's Archer D20 comes with the next generation Wi-Fi standard – 802.11ac, backward compatible with 802.11n and 3 times faster than wireless N speeds. With higher power efficiency and robust security, 802.11ac is the perfect way to accelerate a home multimedia network and solve congestion that multiple devices may cause.

### 750Mbps Concurrent Dual Band - More Bandwidth, Less Interference

With 433Mbps wireless speeds over the crystal clear 5GHz band and 300Mbps over the 2.4GHz band, Archer D20 offers you the flexibility of two dedicated networks and ensures amazing wireless performance. Simple tasks such as sending e-mails or web browsing can be handled by the 2.4GHz band while bandwidth intensive tasks like online gaming or HD video streaming can be processed by the 5GHz band – all at the same time.

### Broad Wi-Fi Coverage

Featuring two fixed external antennas and high power amplifiers, Archer D20 is able to boost Wi-Fi coverage throughout your home.

### Multifunctional USB Port – Easy Storage and Sharing

Using the Archer D20's multi-functional USB 2.0 port, you can share a printer with multiple computers and devices on your network and can also share files & media at home or via the FTP server while away from home.

### Interchangeable LAN/WAN Port - Versatile Connectivity

The Archer D20 supports ADSL or Ethernet WAN connections (EWAN), which allows users to have the flexibility of different Internet connections among ADSL, cable or fiber modem using its interchangeable LAN/WAN port. This unique feature makes it easier when users need to change to fiber or cable services when necessary.

### Guest Network

Guest Network Access provides secure Wi-Fi access for guests sharing your home or office network in a controlled manner without needing to expose private Wi-Fi access codes or other personal data.

## IPv6 Supported

Archer D20 supports IPv6, which is the foundation of the next generation of the Internet and enables a range of new services and improved user experience.

## 1.2. Main Features

- Supports 802.11ac - The next generation of Wi-Fi, compatible with 802.11n
- Simultaneous 2.4GHz 300Mbps and 5GHz 450Mbps connections for 750Mbps of total available bandwidth
- 2 dual band fixed external antennas and high power amplifiers provide stable signals and optimal wireless coverage
- Supports USB Storage Sharing, Print Server, FTP Server, Media Server. Share a printer locally and files & media with networked devices or remotely via FTP server
- Ethernet WAN (EWAN) offers another broadband connectivity option for connecting VDSL, cable or fiber modems
- Adopts Advanced DMT modulation and demodulation technology.
- Downstream data rates up to 24Mbps, upstream data rates up to 1Mbps.
- Supports long transfers, the max line length can reach to 6.5Km.
- Supports Multiple PVC (Permanent Virtual Circuit).
- Built-in DHCP server.
- High speed and asymmetrical data transmit mode, provides safe and exclusive bandwidth.
- Compatible with all mainstreams DSLAM (CO).
- Provides integrated access of internet and route function which face to SOHO user.
- Guest Network Access provides secure Wi-Fi access for guests sharing your home or office network
- Parental Controls allow parents or administrators to establish restricted access policies for children or staff
- IP-based Bandwidth Control makes it easier for you to manage the bandwidth of devices connected to the router
- Supports IP/MAC filter and URL filter, Access Control list
- SPI and NAT firewall protects end-user devices from potential attacks from the Internet
- WPA-PSK/WPA2-PSK encryptions provide user networks with active defense against security threats
- Supports remote configuration and management through SNMP and CWMP.
- Easy one-touch WPA wireless security encryption with the WPS button
- Wi-Fi On/Off Button allows users to turn their wireless radio on or off

- Supports firmware upgrade and Web management
- Supports Virtual Server, DMZ host and Port Triggering
- Supports Dynamic DNS, UPnP and Static Routing
- Supports system log and flow Statistics
- Supports IPv6



## 1.3. Panel Layout

### 1.3.1. Top View









The modem router's LEDs are located on the top panel (View from top to bottom). You can check the modem router's working status by following the LED Explanation table.

#### LED Explanation

Name	Status	Indication
 Power	On	System initialization complete.
	Flashing	System initializing or firmware upgrading is in process. Do not disconnect or power off the modem router.
	Off	Power is off. Please ensure that the power adapter is connected correctly.
 ADSL	On	ADSL line is synchronized and ready to use.
	Flashing	The ADSL negotiation is in progress.
	Off	ADSL synchronization failed. Please refer to Note 1 for troubleshooting.

### LED Explanation

Name	Status	Indication
 Internet	On	The network is available with a successful Internet connection.
	Off	There is no successful Internet connection or the modem router is operating in Bridge mode. Please refer to Note 2 for troubleshooting.
 Wireless 2.4Ghz	On	The wireless 2.4GHz band is working properly.
	Off	The wireless 2.4GHz band is disabled.
 Wireless 5Ghz	On	The wireless 5GHz band is working properly.
	Off	The wireless 5GHz band is disabled.
 LAN	On	At least one LAN port is connected.
	Off	No LAN port is connected.
 WPS	On	A wireless device has been successfully added to the network by WPS function.
	Flashing	WPS handshaking is in process and will continue for about 2 minutes. Please press the WPS button on other wireless devices that you want to add to the network while the LED is flashing.
	Off	A wireless device has failed to be added to the network by WPS function.
 USB	On	The USB device is identified and ready to use.
	Flashing	The USB device is being identified.
	Off	No USB device is plugged into the USB port.

**Note:**

1. If the ADSL LED is off, please check your Internet connection first. Refer to [Connect Your Modem Router](#) for more information about how to make Internet connection correctly. If you have already made a right connection, please contact your ISP to make sure your Internet service is available now.
2. If the Internet LED is off, please check your ADSL LED first. If your ADSL LED is also off, please refer to [Note 1](#). If your ADSL LED is ON, please check your Internet configuration. You may need to check this part of information with your ISP and make sure everything have been input correctly.

### 1.3.2. The Back Panel



The modem router's back panel shows the connection ports, buttons and antennas. Refer to the following for detailed instructions.

Item	Description
ADSL	For connecting the modem router to the Internet. Connect the port to the splitter or directly connect the port to the phone jack via a phone cable. For details, please refer to <a href="#">Connect Your Modem Router</a> .
USB	For connecting to a USB storage device or a USB printer.
WiFi ON/OFF	For turning on/off the Wi-Fi function.
WPS/RESET	The switch for the WPS and RESET function. RESET: There are two ways to reset the modem router's factory defaults. Method one: With the modem router powered on, use a pin to press and hold the RESET button for at least 8-10 seconds. And the modem router will reboot to its factory default settings. Method two: Restore the default settings from Backup & Restore of the modem router's Web-based Management.
LAN1, LAN2, LAN3, LAN4/WAN	For connecting the modem router to your PC or other Ethernet network devices. In wireless router mode you will be able to connect to Cable/FTTH/VDSL/ADSL devices.
POWER ON/OFF	The switch for the power. Press it to power on or off the modem router.
POWER	For connecting the modem router to power socket via the provided power adapter.
Antennas	Used for wireless operation and data transmit. Upright them for the best Wi-Fi performance.

## Chapter 2

---

# Connect the Hardware

---

This chapter contains the following sections:

- *Position Your Modem Router*
- *Connect Your Modem Router*



## 2.1. Position Your Modem Router

With the modem router, you can access your network from anywhere within the wireless network coverage. However, the wireless signal strength and coverage varies depending on the actual environment where your modem router is in. Many obstacles may limit the range of the wireless signal, for example, concrete structures, thickness and number of walls.

For your security and best Wi-Fi performance, please:

- Do Not locate the modem router in the place where it will be exposed to moisture or excessive heat.
- Keep away from the strong electromagnetic radiation and the device of electromagnetic sensitive.
- Place the modem router in a location where it can be connected to the various devices as well as to a power source.

Make sure the cables and power cord are safely placed out of the way so they do not create a tripping hazard.

◆ **Tips:** The modem router can be placed on a shelf or desktop.

Generally, the modem router is placed on a horizontal surface. The device can also be mounted on the wall as shown in the following picture.

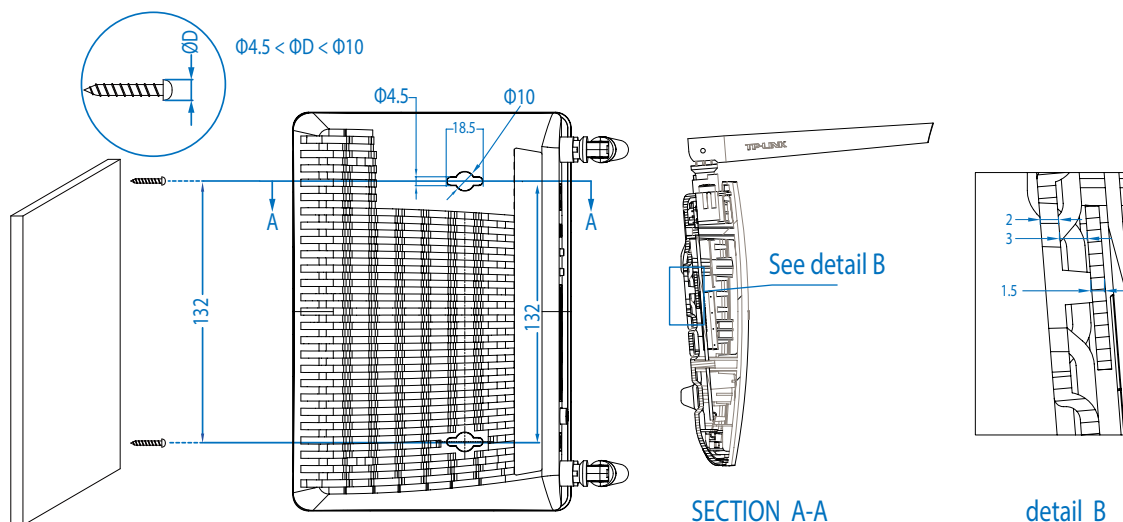

■ **Note:**

The diameter of the screw is between 4.5mm and 10mm, and the distance of two screws is 132mm. The screws that project from the wall need around 7mm based, and the length of the screw needs to be at least 25mm to withstand the weight of the product.

## 2.2. Connect Your Modem Router

Follow the steps below to connect your modem router.

1. Connect the ADSL line and power adapter. The electrical outlet shall be installed near the device and shall be easily accessible

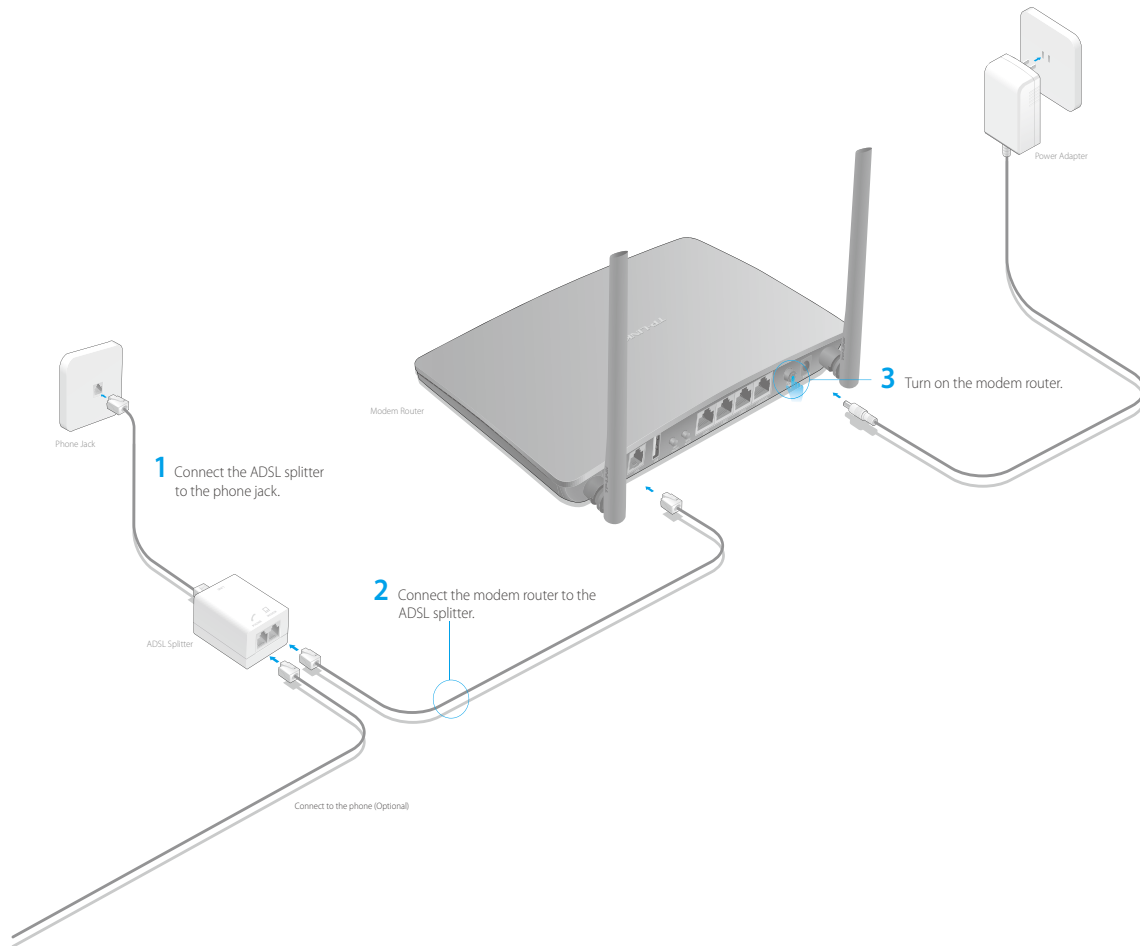

2. Connect your computer to the modem router.

#### Method 1: Wired

Connect your computer's Ethernet port to the LAN port on the modem router Archer D20 via the Ethernet cable.

#### Method 2: Wirelessly

Use the default SSID (Wireless Network Name) and Wireless Password printed on the product label of the modem router to connect wirelessly.

#### Method 3: Use the WPS button

Wireless devices that support WPS, including Android phones, tablets, most USB network cards, can be connected to your router through this method. (WPS is not supported by IOS devices.)

#### Note:

The WPS function cannot be configured if the wireless function of the router is disabled. Also, the WPS function will be disabled if your wireless encryption is WEP. Please make sure the wireless function is enabled and is configured with the appropriate encryption before configuring the WPS.

- 1) Tap the WPS icon on the device's screen.
- 2) Immediately press the WPS button on your modem router.
- 3) The WPS LED flashes for about two minutes during the WPS process.
- 4) When the WPS LED is on, the client device has successfully connected to the modem router.

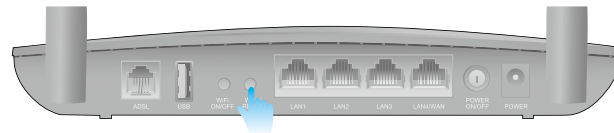
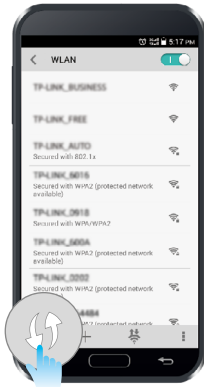

## Chapter 3

---

# Log into Your Modem Router

---

With a Web-based utility, it is easy to configure and manage the Archer D20 AC750 Wireless Dual Band ADSL2+ Modem Router. The Web-based utility can be used on any Windows, Macintosh or UNIX OS with a Web browser, such as Microsoft Internet Explorer, Mozilla Firefox or Apple Safari.

Follow the steps below to log into your modem router.

1. If the TCP/IP Protocol on your computer is set to the static (fixed) IP address, you need to change it to obtain an IP address automatically.
2. Launch a web browser and type in <http://tplinkmodem.net> or <http://192.168.1.1>. Set a strong password using 1-15 characters and click [Save](#).

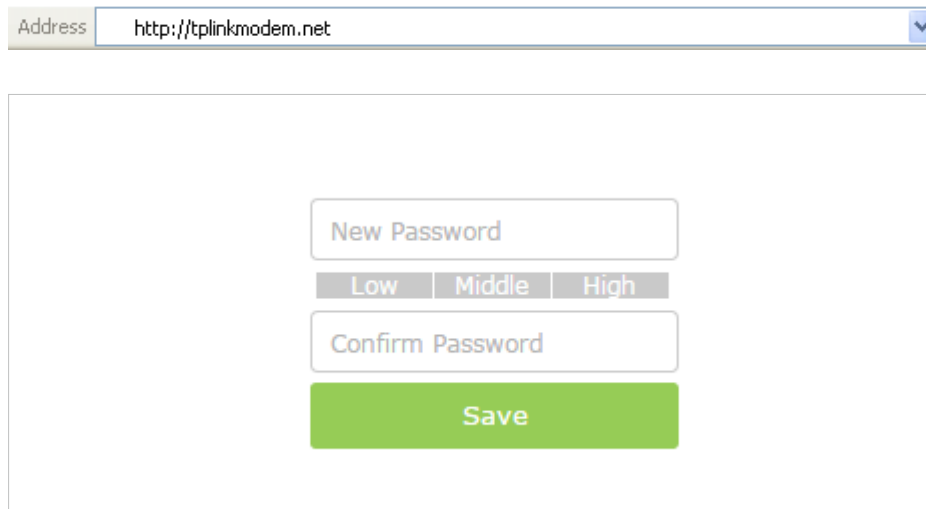

Address

New Password

Low Middle High

Confirm Password

Save

3. Enter the password you set and click [Login](#).

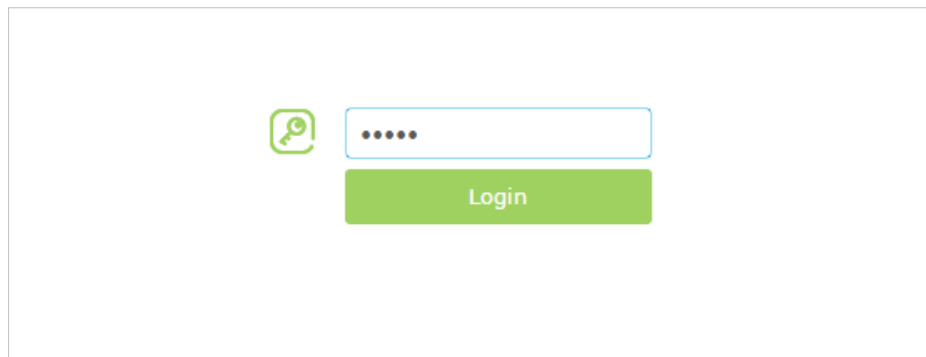



Login

■ **Note:** For subsequent logins, you only need to enter the password that you have set to log in.

## Chapter 4

---

# Set Up Internet Connections

---

This chapter introduces how to connect your modem router to the Internet. The modem router is equipped with a web-based Quick Setup wizard. It has many ISP information built in, automates many of the steps and verifies that those steps have been successfully completed. Furthermore, you can also set up an IPv6 connection if your ISP provided IPv6 service.

This chapter includes the following sections:

- *Use Quick Setup Wizard*
- *Manually Set up an Internet Connection*
- *Set up an IPv6 Connection*
- *Test Internet Connectivity*

## 4.1. Use Quick Setup Wizard

To set up your modem router with several easy steps quickly:

1. Visit <http://tplinkmodem.net>, and log in with the password you set for the modem router.
2. Click **Quick Setup**, select your **ISP** from the dropdown list or select **Other** if you can't find your ISP, then click **Next**.

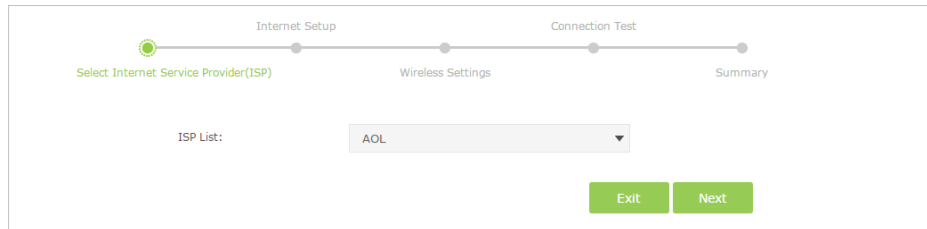

3. Follow the on-screen instructions to complete the setup.

■ **Note:**

1. During the quick setup process, you can change the preset wireless network name (SSID) and wireless password. Once done, all your wireless devices must use the new SSID and password to connect to the modem router.
2. The modem router supports two operation modes, DSL Modem Router Mode and Wireless Router mode. If you already have a modem or your Internet comes via an Ethernet cable from the wall, you can set up the modem router as a regular wireless router to share the Internet. Refer to [Appendix B: Troubleshooting](#) for details.

## 4.2. Manually Set up an Internet Connection

To manually add an Internet connection without following the instructions of the Quick Setup wizard:

1. Visit <http://tplinkmodem.net>, and log in with the password you set for the modem router.
2. Go to **Basic** > **Internet** page. Select your **ISP**, and the **VPI** and **VCI** values will be automatically filled in. Enter the information provided by your ISP for the **Connection Type**. If you can't find your ISP in the **ISP List**, select **Other** and then enter the information provided by your ISP.

Internet Connection Setup

ISP List: AOL

VPI: 0 (0-255)

VCI: 38 (1-65535)

Connection Type: PPPoE

Username: 12345678

Password: [masked]

Save

3. Click [Save](#) to make the settings effective and you can refer to [Test Internet Connectivity](#) to test the Internet connection.

💡 **Tips:** You can view and edit all Internet connections on [Advanced](#) > [Network](#) > [Internet](#) page.

### 4.3. Set up an IPv6 Connection

If the DSL line your ISP provided also supports IPv6 connection and your ISP has provided some detailed IPv6 parameters, you can configure the modem router to permit IPv6 connection.

Follow the steps below to set up an IPv6 connection.

1. Configure the WAN settings.
  - 1) Visit <http://tplinkmodem.net>, and log in with the password you set for the modem router.
  - 2) Go to [Advanced](#) > [Network](#) > [Internet](#) page. Select your WAN Interface Name and click the  (Edit) icon.

WAN Interface

[Refresh](#) [Add](#) [Delete All](#)

WAN Interface Name	VPI/VCI	Status	Operation	Modify
pppoe_8_35_0_d	8/35	Connected	Disconnect	 

- 3) Scroll down to configure the IPv6 parameters.



IPv6:  Enable

Addressing Type: SLAAC ▼

IPv6 Gateway: Current Connection ▼

⌵ Advanced

Select the checkbox to enable IPv6 feature.

**Addressing Type:** Consult your ISP for the addressing type, DHCPv6 or SLAAC. SLAAC is the most commonly used addressing type.

**IPv6 Gateway:** Keep the default setting as Current Connection.

■ **Note:** If your ISP has provided the IPv6 address, click [Advanced](#) to reveal more settings. Check to use IPv6 specified by ISP and enter the parameters provided by your ISP.

- 4) Click [OK](#) to make the settings effective.
2. Configure the IPv6 LAN settings. Go to [Advanced](#) > [Network](#) > [LAN Settings](#) page. Select [IPv6](#) to configure IPv6 LAN parameters.

IP Version:  IPv4  IPv6

Group: Default

Address Type:  RADVD  DHCPv6 Server

Enable RDNSS

Enable ULA Prefix

Site Prefix Type:  Delegated  Static

Prefix Delegated WAN Connection: pppoe\_0\_38\_1\_d ▼

Save

- 1) Select the [Prefix Delegated WAN Connection](#), the IPv6 connection you just set up, from the drop-down list.
  - 2) Leave the rest of the settings as default.
  - 3) Click [Save](#) to make the settings effective.
3. Done. IPv6 service is available for your network.

## 4.4. Test Internet Connectivity

After manually setting up the Internet connection, you need to know the Internet connectivity. The modem router provides a diagnostic tool to help you locate the malfunction.

1. Visit <http://tplinkmodem.net>, and log in with the password you set for the modem router.
2. Go to [Advanced](#) > [System Tools](#) > [Diagnostics](#) page.

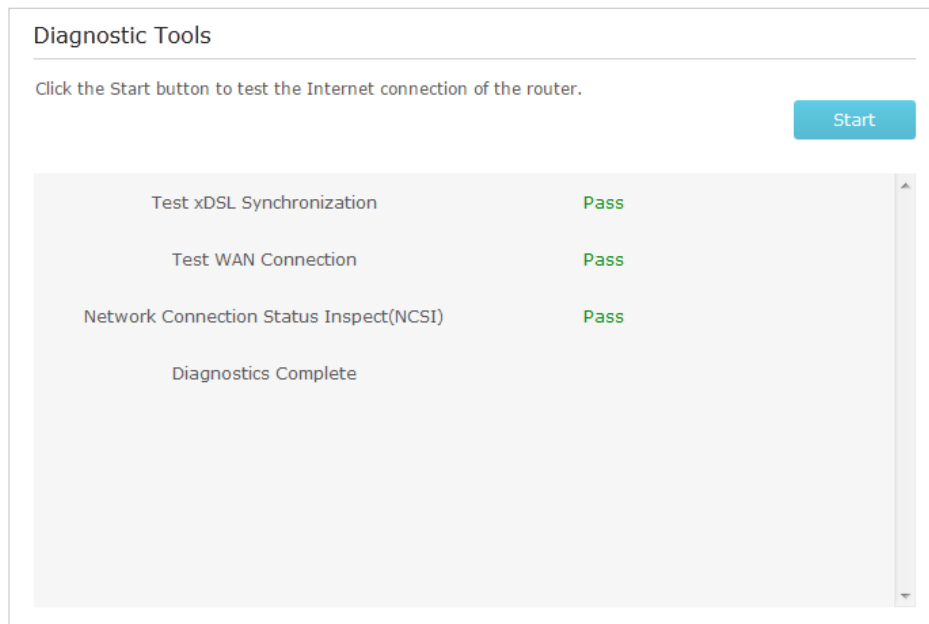

3. Click [Start](#) to test the Internet connectivity and you will see the test result in the gray box.

## Chapter 5

---

# Bandwidth Control

---

The Bandwidth Control feature is used to fully utilize your limited bandwidth and optimize the load respectively. With this feature enabled, you can assign a specific minimum or maximum bandwidth for each computer, thus minimizing the impact caused when the connection is under heavy load.

**I want to:** Use an independent bandwidth and enjoy a good Internet experience without being affected by other users who are sharing the same router.

**For example,** my roommate and I share 512Kbps Upstream Bandwidth and 8Mbps Downstream Bandwidth via this router, she likes to watch live show and play online games, which may take up much bandwidth. I don't want to be affected, so we agree to equally distribute the bandwidth. Our IP addresses are 192.168.1.101 and 192.168.1.110.

**Tips:** To use the bandwidth control feature, you'd better set static IP Address on each computer to be controlled or configure Address reservation on the modem router in order to manage easily. About how to configure address reservation, please refer to [Reserve LAN IP Addresses](#).

**How can I do that?**

1. Visit <http://tplinkmodem.net>, and log in with the password you set for the modem router.
2. Go to [Advanced](#) > [Bandwidth Control](#) page.

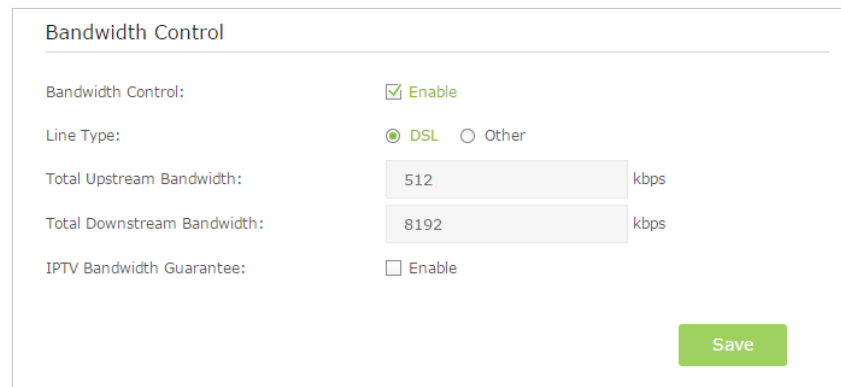

The screenshot shows the 'Bandwidth Control' configuration page. It includes the following settings:

- Bandwidth Control:**  Enable
- Line Type:**  DSL  Other
- Total Upstream Bandwidth:** 512 kbps
- Total Downstream Bandwidth:** 8192 kbps
- IPTV Bandwidth Guarantee:**  Enable

A green 'Save' button is located at the bottom right of the form.

3. Enable [Bandwidth Control](#), choose [DSL](#) on the line type. If you don't know how to choose the line type, please contact your ISP which line type you have access.
4. Enter the [Total Upstream Bandwidth](#) and the [Total Downstream Bandwidth](#) given by your ISP. (1Mbps=1024Kbps). Click [Save](#) to save the settings.
5. Click [Add](#) to add controlling rules for each computer respectively.

### Controlling Rules

+ Add - Delete

<input type="checkbox"/>	Description	Priority	Up(min/max)	Down(min/max)	Enable	Modify
--	--	--	--	--	--	--

IP Range:  -

Port Range:  -

Protocol:  ▼









Priority:  ▼ (1 means the highest priority.)

Upstream:  to

Downstream:  to

Enable this entry

- 1) **IP Range:** Enter the IP address. The field can be single IP address or IP address range according to your demands. When you configure the single IP address, the computer with this IP address will get independent given bandwidth. When you configure the IP address range, all computers in the range will share the given bandwidth.
  - 2) **Port Range:** Keep the default settings. The default port range of TCP protocol or UDP protocol is from 1 to 65535.
  - 3) **Protocol:** Keep the default setting. Or you can choose the TCP protocol or UDP protocol or both of them.
  - 4) **Priority:** Keep the default setting. You can change the value if you want to first guarantee the bandwidth for one computer. The smaller value has the higher priority.
  - 5) **Upstream/Downstream:** Enter the bandwidth according to your division.
  - 6) Check to enable this entry and click **OK** to save the settings.
6. Follow the steps above to add a rule for the other computer. And then you will get the following table.

Controlling Rules						
 Add  Delete						
<input type="checkbox"/>	Description	Priority	Up(min/max)	Down(min/max)	Enable	Modify
<input type="checkbox"/>	192.168.1.110	5	250/500 kbps	2000/4000 kbps		 
<input type="checkbox"/>	192.168.1.101	5	250/500 kbps	2000/4000 kbps		 

**Done!**

Now you and your roommate have an independent bandwidth.

## Chapter 6

---

# Network Security

---

This chapter guides you on how to protect your home network from unauthorized users by implementing these three network security functions. You can block or allow specific client devices to access your wireless network using MAC Filtering, or using Access Control for wired and wireless networks, or you can prevent ARP spoofing and ARP attacks using IP & MAC Binding.

- *MAC Filtering*
- *Access Control*
- *IP & MAC Binding*

## 6.1. MAC Filtering

This function exploits the uniqueness of the MAC (Medium Access Control) address, a unique 12-digit hexadecimal address (for example, D8:5D:4C:B4:46:EA) of every network device, to determine if the device can or cannot access your wireless network.

**I want to:** Prevent unauthorized users from accessing my wireless network by utilizing the network device's MAC address and IP address.

**For example,** I have a computer that is connected to my wireless network. Now, an unknown device (an intruder) is also using my wireless network, which affects my Internet speed. I would like to control my wireless network with the following capabilities:

- My computer is always allowed to access the wireless network.
- The unknown device is not allowed to access the wireless network.
- I don't have to keep changing my wireless password as often.

**How can I do that?**

1. Visit <http://tplinkmodem.net>, and log in with the password you set for the router.
2. Go to **Advanced > Wireless > MAC Filtering** and enable **Wireless MAC Filtering**.

The screenshot shows the TP-Link Archer D20 web interface. The 'Advanced' tab is selected, and the 'Wireless' section is expanded to 'MAC Filtering'. The 'Enable Wireless MAC Filtering' toggle is turned on. Under 'Filtering Rules', the 'Block wireless access from the devices in the list below' option is selected. The 'Devices List' table is empty. The 'Devices Online' table shows two devices:

ID	Device Name	IP Address	MAC Address	Connection Type
1	WIN7-PC	192.168.0.100	14:CC:20:86:A0:D3	Wireless
2	android-bec84684de86dd53	192.168.0.101	78:E8:B6:9A:5E:21	Wireless

3. Select the filtering rule to either block (recommended) or allow the device(s) in the list.



**To block specific device(s)**

- 1) Select [Block wireless access from the devices in the list below](#) and click [Save](#).
- 2) Select the device(s) to be blocked in the [Devices Online](#) table.
- 3) Click [Block](#) above the [Devices Online](#) table. The selected devices will be added to [Devices List](#) automatically.

**To allow specific device(s)**

- 1) Select [Allow wireless access only from the devices in the list below](#) and click [Save](#).
- 2) Click [Add](#).

Devices List

+ Add - Delete

<input type="checkbox"/>	ID	MAC Address	Description	Enable	Modify
--	--	--	--	--	--

MAC Address:

Description:

Enable this Entry

Cancel
OK

- 3) Enter the [MAC Address](#) (You can copy and paste the [MAC Address](#) from [Devices Online](#) list if the device is connected to your wireless network) and enter the [Description](#) of the device.
- 4) Select the checkbox to enable this entry, and click [OK](#).

**Done!**

Now MAC Filtering is implemented to protect your wireless network.

## 6.2. Access Control

Access Control is used to block or allow specific client devices to access your network (via wired or wireless) based on a list of blocked devices (Blacklist) or a list of allowed devices (Whitelist).

**I want to:**

Block or allow specific client devices to access my network (via wired or wireless).

## How can I do that?

1. Visit <http://tplinkmodem.net>, and log in with the password you set for the router.
2. Go to [Advanced](#) > [Security](#) > [Access Control](#) and enable [Access Control](#).

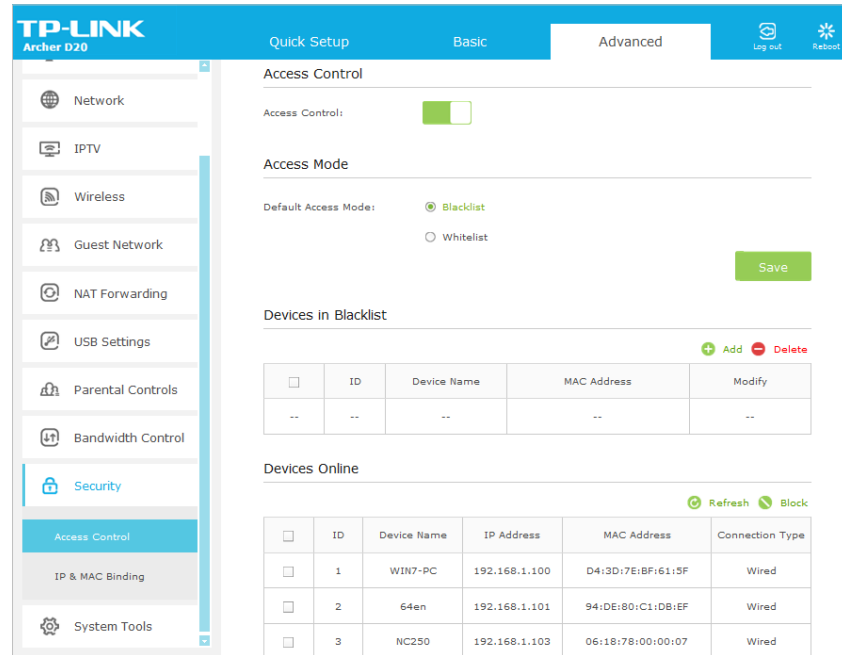

3. Select the access mode to either block (recommended) or allow the device(s) in the list.

### To block specific device(s)

- 1) Select [Blacklist](#) and click [Save](#).
- 2) Select the device(s) to be blocked in the [Devices Online](#) table.
- 3) Click [Block](#) above the [Devices Online](#) table. The selected devices will be added to [Devices in Blacklist](#) automatically.

### To allow specific device(s)

- 1) Select [Whitelist](#) and click [Save](#).
- 2) Click [Add](#).

The screenshot shows a web interface titled "Devices in Whitelist". At the top right, there are two buttons: a green "+ Add" button and a red "- Delete" button. Below this is a table with the following structure:

<input type="checkbox"/>	ID	Device Name	MAC Address	Modify
--	--	--	--	--

Below the table is a form for adding a new device. It contains two input fields:

- Device Name: 64en
- MAC Address: 94:DE:80:C1:DB:EF

At the bottom right of the form are two buttons: "Cancel" and "OK".

3) Enter the **Device Name** and **MAC Address** (You can copy and paste the information from **Devices Online** table if the device is connected to your network).

4) Click **OK**.

**Done!**

Now you can block or allow specific client devices to access your network (via wired or wireless) using the **Blacklist** or **Whitelist**.

### 6.3. IP & MAC Binding

IP & MAC Binding, namely, ARP (Address Resolution Protocol) Binding, is used to bind network device's IP address to its MAC address. This will prevent ARP spoofing and other ARP attacks by denying network access to an device with matching IP address in the Binding list, but unrecognized MAC address.

**I want to:**

Prevent ARP spoofing and ARP attacks.

**How can I do that?**

1. Visit <http://tplinkmodem.net>, and log in with the password you set for the router.
2. Go to **Advanced > Security > IP & MAC Binding** and enable **IP & MAC Binding**.

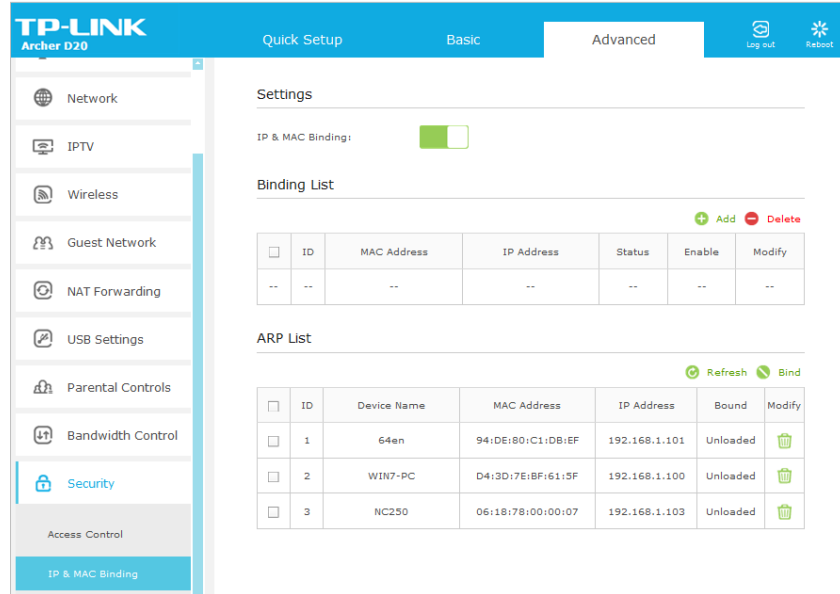

### 3. Bind your device(s) according to your needs.

#### To bind the connected device(s)

- 1) Select the device(s) to be bound in the [ARP List](#).
- 2) Click [Bind](#) to add to the [Binding List](#).

#### To bind the unconnected device

- 1) Click [Add](#).

**Binding List**

+ Add - Delete

<input type="checkbox"/>	ID	MAC Address	IP Address	Status	Enable	Modify
--	--	--	--	--	--	--

MAC Address:

IP Address:

Enable

Cancel
OK

- 2) Enter the [MAC Address](#) and [IP Address](#) that you want to bind.
- 3) Select the checkbox to enable the entry and click [OK](#).

**Done!**

Now you don't need to worry about ARP spoofing and ARP attacks.

## Chapter 7

---

# IPTV

---

IPTV is the abbreviation of Internet Protocol Television. The service can only be delivered through the Internet, and our modem router provides a specific LAN port for IPTV.

By automatically separating IPTV from Internet surfing, we guarantee you a high quality of video streaming and a high speed of Internet surfing.

**I want to:**

Configure the modem router to enable Internet Protocol Television (IPTV) Services.

*For example*, I already bought IPTV service, but this service can only be delivered through the Internet. Therefore, I need to configure my modem router first.

**How can I do that?**

1. Visit <http://tplinkmodem.net>, and log in with the password you set for the router.
2. Go to **Advanced** > **IPTV** to open the configuration page.

IPTV Settings

IPTV:  Enable IPTV

Specify a LAN port for IPTV connection and connect the set-top box to this port.

LAN Port:  LAN1  LAN2  LAN3

Please set the PVC parameters for the IPTV connection.

VPI:  (0-255)

VCI:  (1-65535)

[Save](#)

3. Click **Enable IPTV** to enable this function.
4. Specify a LAN port for IPTV connection and connect the set-top box to this port.
5. Fill in PVC parameters (**VPI** and **VCI**). These parameters are provided by your IPTV service provider.
6. Click **Save** to make the settings effective.

**Done!**

Configurations needed on modem router is done now! You may need other configurations on your set-top box before enjoying your TV.

## Chapter 8

---

# USB Settings

---

This chapter describes how to share and access USB devices connected to the modem router among different clients.

The modem router only supports USB external flash drives, hard drives and USB printers, and does not support USB 3G/4G modems.

This chapter contains the following sections:

- *Local Storage Sharing*
- *Remote Access via FTP Server*
- *Media Sharing*
- *Printer Sharing*

## 8.1. Local Storage Sharing

Share your USB storage devices with different users on the network.

### 8.1.1. Access the USB disk

#### 1. Connect Your USB Disk

Insert your USB storage device into the modem router's USB port directly or using a USB cable. Wait several seconds until the USB LED becomes solid on.

##### ◆ Tips:

- If you use USB hubs, make sure no more than 4 devices are connected to the modem router.
- If the USB storage device requires using bundled external power, make sure the external power has been connected.
- If you use a USB hard drive, make sure its file system is FAT32 or NTFS.
- Before you physically disconnect a USB device from the modem router, safely remove it to avoid data damage: Go to [Advanced](#) > [USB Settings](#) > [Device Settings](#) and click [Safely Remove](#).

#### 2. Access Your USB Disk

By default, all the network clients can access all folders on your USB disk. Refer to the following table for access instructions. You can also customize your sharing content and set a sharing account by referring to [Customize Your Settings](#).

Windows computer

➤ **Method 1:**

Go to [Computer](#) > [Network](#), then click the Network Server Name ([ARCHER\\_D20](#) by default) in the [Computer](#) section.

■ Note:  
Operations in different systems are similar. Here we take Windows 7 as an example.

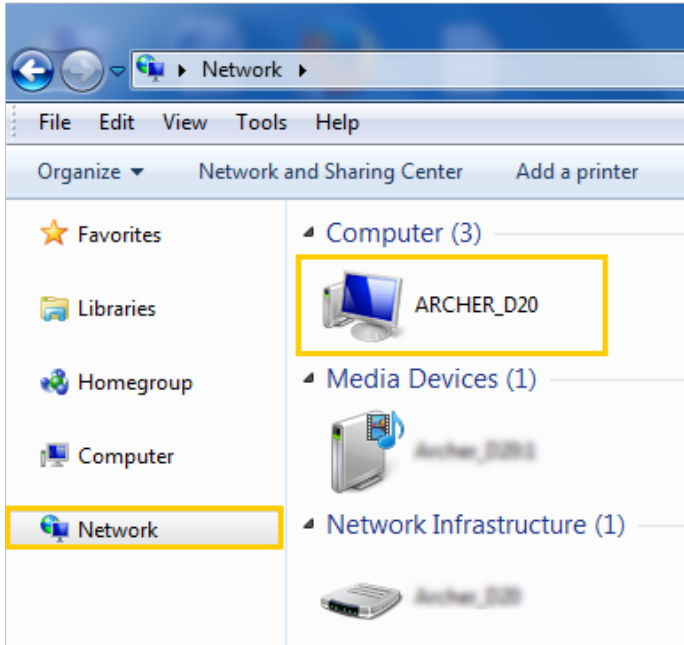

The screenshot shows the Windows 7 Network window. The address bar shows 'Network'. The left sidebar has 'Network' selected. The main pane shows a list of network resources: 'Computer (3)', 'Media Devices (1)', and 'Network Infrastructure (1)'. Under 'Computer (3)', the computer 'ARCHER\_D20' is highlighted with a yellow box. Other computers listed include 'ARCHER\_D20' and 'ARCHER\_D20'.



Windows  
computer➤ **Method 2:**

Open the [Windows Explorer](#) (or go to [Computer](#)) and type the server address [\\tplinkmodem.net](#) or [ftp://tplinkmodem.net](#) in the address bar, then press [Enter].

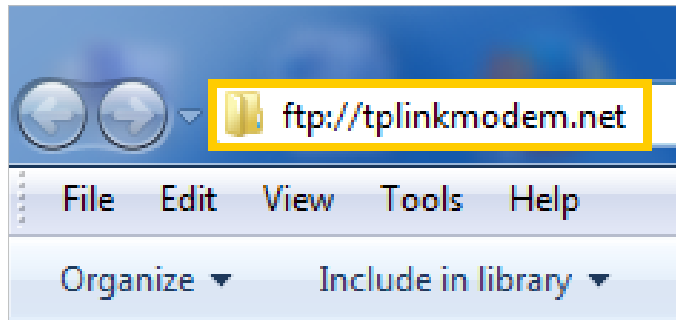

## Mac

- 1) Select [Go](#) > [Connect to Server](#)
- 2) Type the server address [smb://tplinkmodem.net](#)
- 3) Click [Connect](#)

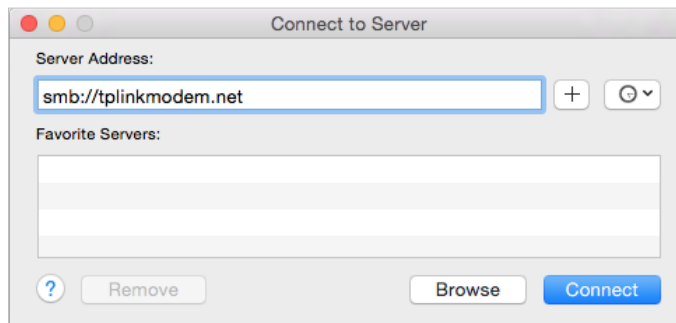

- 4) When prompted, select the [Guest](#) radio box. (If you have set up a username and a password to deny anonymous access to the USB disks, you should select the [Registered User](#) radio box. To learn how to set up an account for the access, refer to [To Set up Authentication for Data Security](#).)

## pad

Use a third-party app for network files management.

◆ **Tips:**

You can also access your USB disk by using your Network/Media Server Name as the server address. Refer to [To Customize the Address of the USB Disk](#) to learn more.

## 8.1.2. Customize Your Settings

### ➤ To Only Share Specific Content

By default, [Share All](#) is enabled so all content on the USB disk is shared. If you want to only share specific folders, follow the steps below:

1. Visit <http://tplinkmodem.net>, then log in with the password you set for the modem router.
2. Select [Basic](#) > [USB Settings](#) > [Sharing Access](#). Focus on the [Folder Sharing](#) section. Click the button to disable [Share All](#), then click [Add](#) to add a new sharing folder.

Folder Sharing

Share All:

+ Add - Delete

<input type="checkbox"/>	ID	Folder Name	Folder Path	Media Sharing	Volume Name	Status	Modify
--	--	--	--	--	--	--	--

Volume Name:  ▼

Folder Path:

Folder Name:

Enable Authentication

Enable Write Access

Enable Media Sharing

3. Select the [Volume Name](#) and [Folder Path](#), then enter a [Folder Name](#) as you like.
4. Decide the way you share the folder:
  - [Enable Authentication](#): Tick to enable authentication for this folder sharing, and you will be required to use a username and password to access the USB disk. Refer to [To Set up Authentication for Data Security](#) to learn more.
  - [Enable Write Access](#): If you tick this check box, network clients can modify this folder.
  - [Enable Media Sharing](#): Tick to enable media sharing for this folder, and you can view photos, play music and watch movies stored on the USB disk directly from DLNA-supported devices. Click [Media Sharing](#) to learn more.
5. Click [OK](#).

**Tips:**

The modem router can share eight volumes at most. You can click  on the page to detach the corresponding volume you do not need to share.

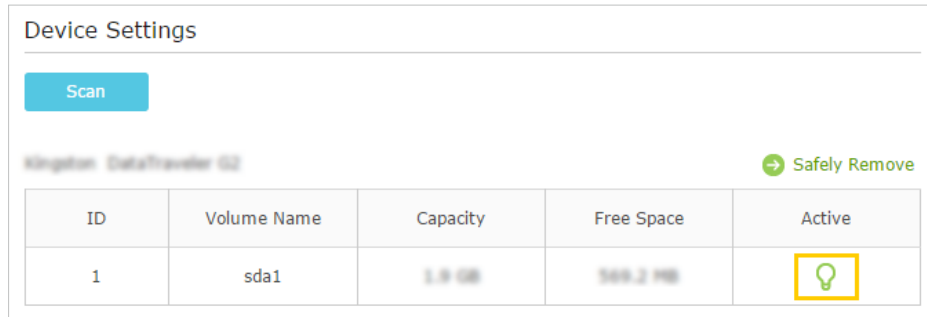
**➤ To Set up Authentication for Data Security**

If you enable **Authentication**, network clients will be required to enter the username and password you set when accessing the USB disk.

1. Visit <http://tplinkmodem.net>, then log in with the password you set for the modem router.
2. Select **Advanced > USB Settings > Sharing Access**.

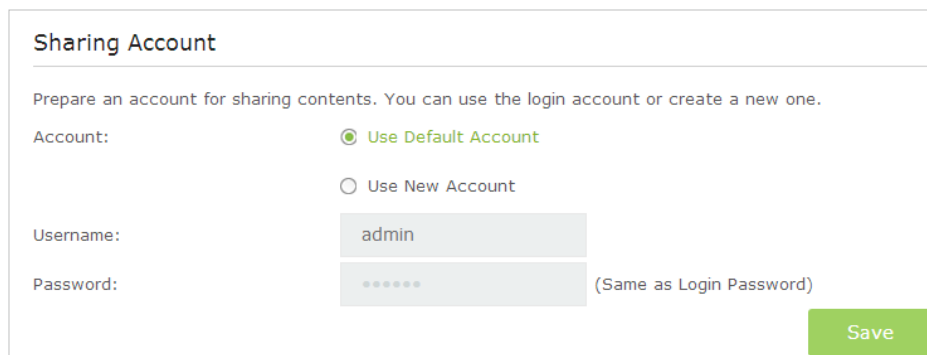

3. Choose to use the default Account (admin) or use a new account and click **Save**.
4. Enable **Authentication** to apply the account you just set.
  - If you leave **Share All** enabled, click the button to enable **Authentication** for all folders.

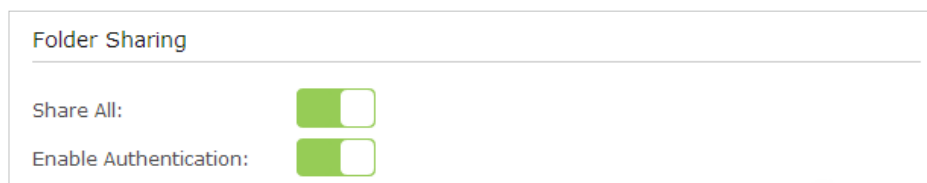

- If **Share All** is disabled, enable **Authentication** for specific folders.

Folder Sharing

Share All:

+ Add - Delete

<input type="checkbox"/>	ID	Folder Name	Folder Path	Media Sharing	Volume Name	Status	Modify
--	--	--	--	--	--	--	--

Volume Name:

Folder Path:

Folder Name:

Enable Authentication

Enable Write Access

Enable Media Sharing

■ **Note:**

Due to Windows credential mechanism, you might be unable to access the USB disk after changing Authentication settings. Please log out from Windows and try to access again. For more details, refer to [T9. What can I do if I cannot access the USB disk after I modify the Authentication settings?](#)

➤ **To Customize the Address of the USB Disk**

You can customize the server name and use the name to access your USB disk.

1. Visit <http://tplinkmodem.net>, then log in with the password you set for the modem router.
2. Select [Advanced](#) > [USB Settings](#) > [Sharing Access](#).
3. Make sure [Network Neighborhood](#) is ticked, and enter a Network/Media Server Name as you like, such as [MyShare](#), then click [Save](#).

Sharing Settings

Network/Media Server Name:

Enable	Access Method	Link	Port
<input checked="" type="checkbox"/>	Media Server	--	--
<input checked="" type="checkbox"/>	Network Neighborhood	\\<del>192.168.1.1</del>	--
<input checked="" type="checkbox"/>	FTP	ftp://192.168.1.1:21	<input type="text" value="21"/>
<input type="checkbox"/>	FTP(via Internet)	ftp://0.0.0.0:21	21

4. Now you can access the USB disk by visiting `\\MyShare` (for Windows) or `smb://MyShare` (for Mac).

## 8.2. Remote Access via FTP Server

You can access your USB disk outside the local area network.

For example:

- Share photos and other large files with your friends without logging in to (and paying for) a photo-sharing site or email system.
- Get a safe backup for the materials for a presentation.
- Remove the files on your camera's memory card from time to time during the journey.

**Note:**

If your ISP assigns a private WAN IP address (such as 192.168.x.x or 10.x.x.x), you cannot use this feature because private addresses are not routed on the Internet.

### 8.2.1. Access the USB disk

#### 1. Connect Your USB Disk

Insert your USB storage device into the modem router's USB port directly or using a USB cable. Wait several seconds until the USB LED becomes solid on.

**Tips:**

- If you use USB hubs, make sure no more than 4 devices are connected to the modem router.
- If the USB storage device requires using bundled external power, make sure the external power has been connected.
- If you use a USB hard drive, make sure its file system is FAT32 or NTFS.
- Before you physically disconnect a USB device from the modem router, safely remove it to avoid data damage: Select **Advanced** > **USB Settings** > **Device Settings** and click  **Safely Remove**.

## 2. Enable Authentication for Data Security

It is strongly recommended that you set and apply a sharing account for data security.

- 1) Visit <http://tplinkmodem.net>, then log in with the password you set for the modem router.
- 2) Select [Advanced](#) > [USB Settings](#) > [Sharing Access](#).
- 3) Choose to use the default Account (admin) or use a new account and click [Save](#).

### Sharing Account

Prepare an account for sharing contents. You can use the login account or create a new one.

Account:  Use Default Account  
 Use New Account

Username:

Password:  (Same as Login Password)

[Save](#)

- 4) Enable [Authentication](#) to apply the sharing account.
  - If you leave [Share All](#) enabled, click the button to enable [Authentication](#) for all folders.

### Folder Sharing

Share All:

Enable Authentication:

- If [Share All](#) is disabled, enable [Authentication](#) for specific folders.

**Folder Sharing**

Share All:

+ Add - Delete

<input type="checkbox"/>	ID	Folder Name	Folder Path	Media Sharing	Volume Name	Status	Modify
--	--	--	--	--	--	--	--

Volume Name:

Folder Path:

Folder Name:

Enable Authentication

Enable Write Access

Enable Media Sharing

### 3. Enable the FTP(via Internet)

Select the check box to enable [FTP\(via Internet\)](#), then click [Save](#).

**Sharing Settings**

Network/Media Server Name:

Enable	Access Method	Link	Port
<input checked="" type="checkbox"/>	Media Server	--	--
<input checked="" type="checkbox"/>	Network Neighborhood	Archer_020	--
<input checked="" type="checkbox"/>	FTP	ftp://192.168.1.1:21	<input type="text" value="21"/>
<input checked="" type="checkbox"/>	FTP(via Internet)	ftp://59.40.2.243:21	21

### 4. Access Your USB Disk via Internet

Now different clients with Internet connection can access the USB disk:

Computer	<p>1) Open the <a href="#">Windows Explorer</a> (or go to <a href="#">Computer</a>, only for Windows users) or open a web browser.</p> <p>2) Type the server address in the address bar: Type in <a href="#">ftp://&lt;WAN IP address of the modem router&gt;:&lt;port number&gt;</a> (such as <a href="#">ftp://59.40.2.243:21</a>). If you have specified the domain name of the modem router, you can also type in <a href="#">ftp://&lt;domain name&gt;:&lt;port number&gt;</a> (such as <a href="#">ftp://MyDomainName:21</a>)</p>
	<div data-bbox="673 579 1152 802" data-label="Image"> <p>The image shows a close-up of the Windows Explorer address bar. The address bar contains the text 'ftp://59.40.2.243:21' and is highlighted with a yellow border. Below the address bar, the menu bar shows 'File', 'Edit', 'View', 'Tools', and 'Help'. Below the menu bar, there are two buttons: 'Organize' and 'Include in library', both with dropdown arrows.</p> </div> <p data-bbox="628 821 1198 846" style="text-align: center;">The Address Bar the Windows Explorer (Windows 7)</p> <p>3) Press <a href="#">Enter</a> on the keyboard.</p> <p>4) Access with the username and password you set in <a href="#">Step 2 Enable Authentication for Data Security</a>.</p> <p><b>◆ Tips:</b> You can also access the USB disk via a third-party app for network files management, which can resume broken file transfers.</p>
Pad	<p>Use a third-party app for network files management.</p>

**◆ Tips:**

Click [Set Up a Dynamic DNS Service Account](#) to learn how to set up a domain name for you modem router.

## 8.2.2. Customize Your Settings

### ➤ To Only Share Specific Content

By default, [Share All](#) is enabled so all content on the USB disk is shared. If you want to only share specific folders, follow the steps below:

1. Visit <http://tplinkmodem.net>, then log in with the password you set for the modem router.
2. Select [Basic](#) > [USB Settings](#) > [Sharing Access](#). Focus on the section of Folder Sharing. Click the button to disable [Share All](#), then click [Add](#) to add a new sharing folder.



Folder Sharing

Share All:

+ Add - Delete

<input type="checkbox"/>	ID	Folder Name	Folder Path	Media Sharing	Volume Name	Status	Modify
--	--	--	--	--	--	--	--

Volume Name: G: ▼

Folder Path: G:/My files Browse

Folder Name: Remote\_Access

Enable Authentication

Enable Write Access

Enable Media Sharing

Cancel OK

3. Select the **Volume Name** and **Folder Path**, then specify the **Folder Name** as you like.
4. Tick **Enable Authentication**. If you allow network clients to modify this folder, tick **Enable Write Access**.
5. Click **OK**.

**Tips:**

The modem router can share eight volumes at most. You can click  on the page to detach the corresponding volume you do not need to share.

Device Settings

Scan

Kingston DataTraveler G2 ➔ Safely Remove

ID	Volume Name	Capacity	Free Space	Active
1	sda1	1.9 GB	149.2 MB	

## 8.3. Media Sharing

The feature of **Media Sharing** allows you to view photos, play music and watch movies stored on the USB disk directly from DLNA-supported devices, such as your computer, pad and PS2/3/4.

### 8.3.1. Access the USB disk

#### 1. Connect Your USB Disk

Insert your USB storage device into the modem router's USB port directly or using a USB cable. Wait several seconds until the USB LED becomes solid on.

◆ **Tips:**

- If you use USB hubs, make sure no more than 4 devices are connected to the modem router.
- If the USB storage device requires using bundled external power, make sure the external power has been connected.
- If you use a USB hard drive, make sure its file system is FAT32 or NTFS.
- Before you physically disconnect a USB device from the modem router, safely remove it to avoid data damage: Go to [Advanced](#) > [USB Settings](#) > [Device Settings](#) and click [➔ Safely Remove](#).

#### 2. Access the Media Files on Your USB Disk

Now the DLNA-supported devices (such as your computer and pad) connected to the modem router can detect and play the media files on the USB disks.

- Go to [Computer](#) > [Network](#), then click the Media Server Name ([Archer\\_D20](#) by default) in the [Media Devices](#) section.

▮ **Note:**

Here we take Windows 7 as an example.

#### Windows computer

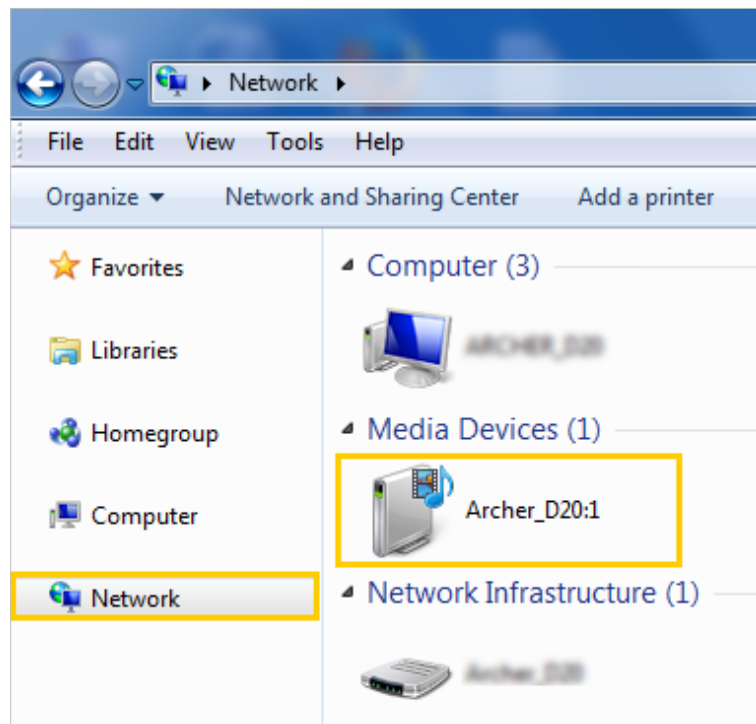

#### Pad

- Use a third-party DLNA-supported player.

### 8.3.2. Customize Your Settings

#### ➤ To Only Share Specific Content

By default, [Share All](#) is enabled so all content on the USB disk is shared. If you want to only share specific folders, follow the steps below:

1. Visit <http://tplinkmodem.net>, then log in with the password you set for the modem router.
2. Select [Basic](#) > [USB Settings](#) > [Sharing Access](#).
3. Focus on the section of [Folder Sharing](#). Click the button to disable [Share All](#), then click [Add](#) to add a new sharing folder.

Folder Sharing

Share All:

[+ Add](#) [- Delete](#)

<input type="checkbox"/>	ID	Folder Name	Folder Path	Media Sharing	Volume Name	Status	Modify
--	--	--	--	--	--	--	--

Volume Name:  ▼

Folder Path:  [Browse](#)

Folder Name:

Enable Authentication

Enable Write Access

**Enable Media Sharing**

[Cancel](#) [OK](#)

4. Select the [Volume Name](#) and [Folder Path](#), then enter a [Folder Name](#) as you like.
5. Tick [Enable Media Sharing](#) and click [OK](#).

#### 💡 Tips:

The modem router can share eight volumes at most. You can click [💡](#) on the page to detach the corresponding volume you do not need to share.

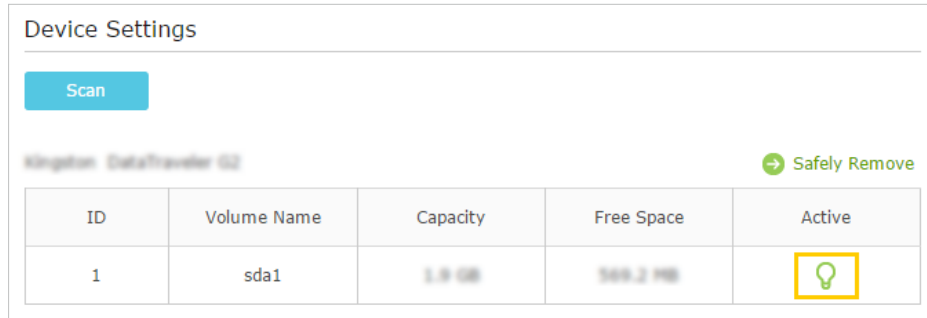

### ➤ To Specify the Media Server

You can also modify the media server name or disable the feature of Media Sharing as needed.

1. Visit <http://tplinkmodem.net>, then log in with the password you set for the modem router.
2. Select **Advanced** > **USB Settings** > **Sharing Access**.
3. Enter a **Network/Media Server Name** as you like, such as **MyShare**. You can deselect the check box of Media Server to disable the media server feature.

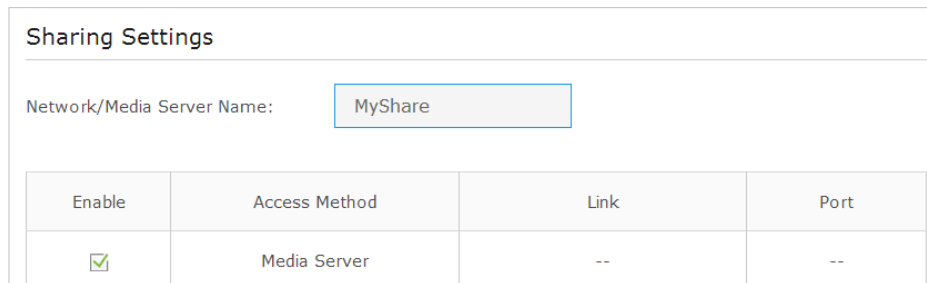

4. Click **Save**.

## 8.4. Printer Sharing

The feature of Printer Sharing helps you share a printer with different computers connected to the modem router.

### ■ Note:

Printers unlisted on this page may be incompatible with the modem router:  
<http://www.tp-link.com/common/compatible/print-server/>.

#### 1. Install the Driver of the Printer

Make sure you have installed the driver of the printer on each computer that needs printer service.

If you do not have the driver, contact the printer manufacturer.

#### 2. Connect the Printer

Cable a printer to the USB port with the USB cable. Wait several seconds until the USB LED becomes solid on.

### 3. Install the TP-LINK USB Printer Controller Utility

TP-LINK USB Printer Controller Utility helps you access the shared printer. Download and Install the utility on each computer that needs printer service.

- 1) Visit <http://www.tp-link.com/app/usb/>.
- 2) Click **PC Utility** (for Windows users) or **Mac Utility** to download the installation file and uncompress it.



- 3) Open the uncompressed folder, then click **TP-LINK USB Printer Controller Setup** (for Windows users) or **TP-Link UDS Printer Controller Installer** (for Mac users) to install the utility.

### 4. Access the Printer

You should set the shared printer as Auto-Connect Printer on every computer that needs printer service.

- 1) Double-click the icon  on your desktop to launch the USB Printer Controller.
- 2) Highlight the printer you share.

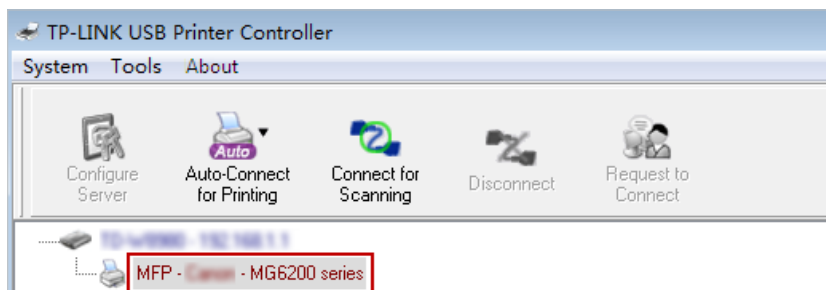

Windows

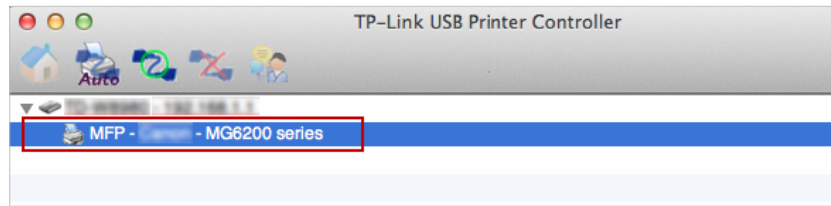

### Mac

- 3) Click the **Auto-Connect for printing** tab to pull down a list, then select **Set Auto-Connect Printer**.

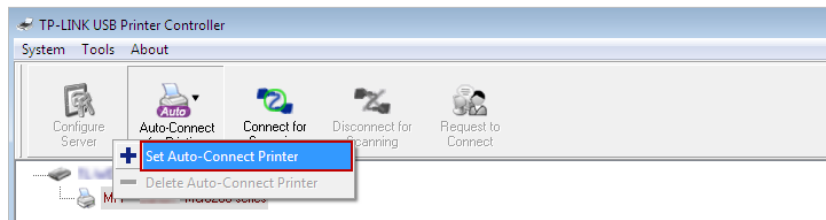

### Windows

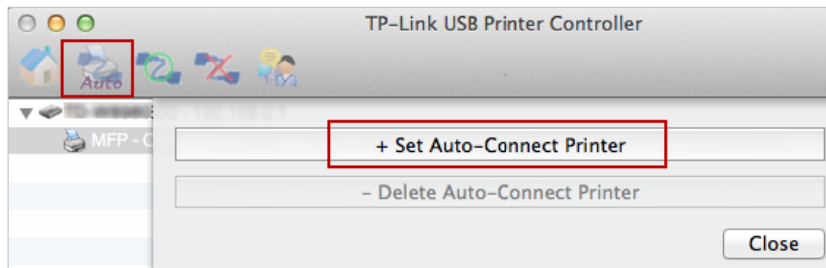

### Mac

- 4) Select the printer you share, then click **Apply**.

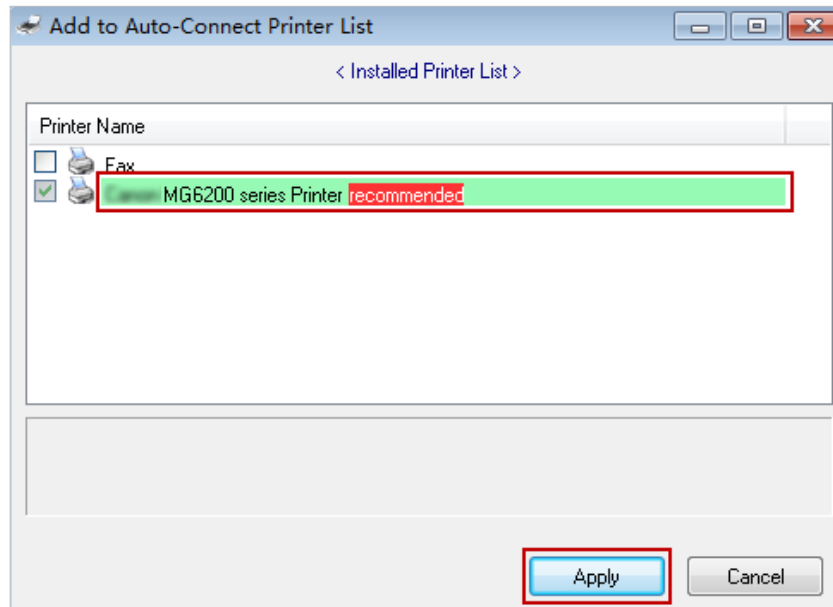

## Windows

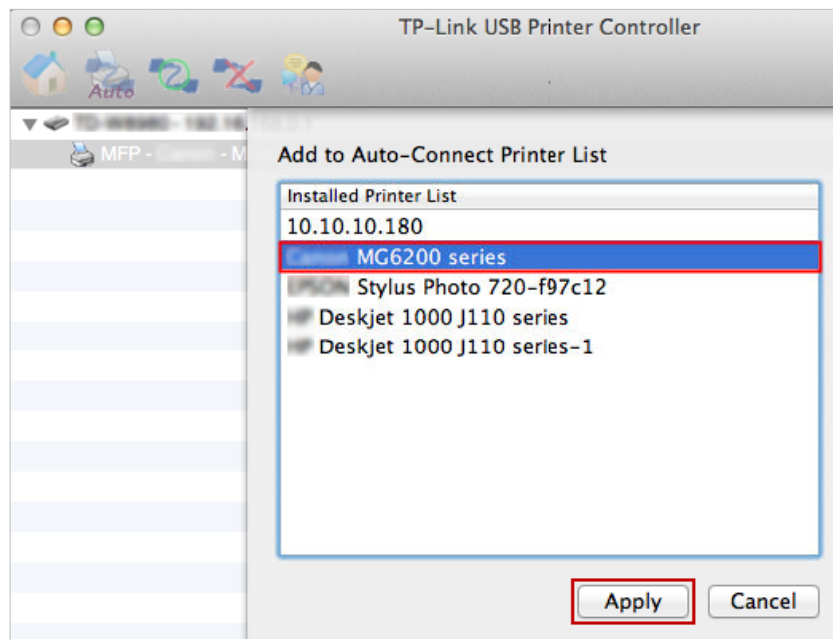

## Mac

- 5) You will see the printer marked as **Auto-Connect Printer**. Now you can print with this printer.

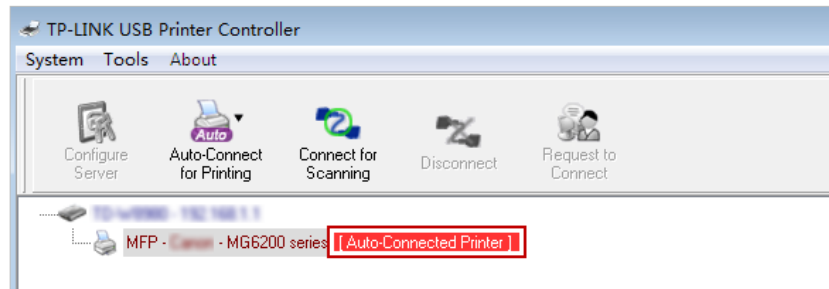

## Windows

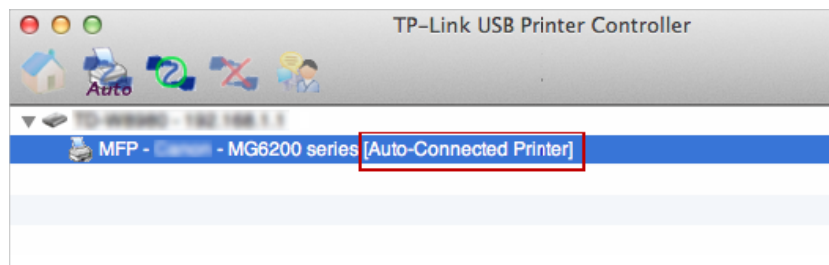

## Mac

### ◆ Tips:

The Print Server also allows different clients to share the scan feature of MFPs (Multi-Function Printers). To scan with [TP-LINK USB Printer Controller](#), right-click the printer and select [Network Scanner](#). Then, a scanning window will pop up. Finish the scanning process by following on-screen instructions.



## Chapter 9

---

# Parental Controls

---

This function allows you to block inappropriate, explicit and malicious websites, and control access to specified websites at specified time.

**I want to:** control what types of websites my children or other home network users can visit and even the time of day they are allowed to access the Internet.

**For example,** I want to allow my children's devices (e.g. a computer or a tablet) to access only [www.tp-link.com](http://www.tp-link.com) and [Wikipedia.org](http://Wikipedia.org) from 18:00 (6PM) to 22:00 (10PM) on weekdays and not other time.

**How can I do that?**

1. Visit <http://tplinkmodem.net>, and log in with the password you set for the router.
2. Go to [Basic](#) or [Advanced](#) > [Parental Controls](#) and enable [Parental Control](#).

Parent Control:

Devices Under Parental Controls

The Internet Access Time is based on the time of the router. The time can be set in "Advanced > System Tools > Time Settings"

<input type="checkbox"/>	ID	Device Name	MAC Address	Internet Access Time	Description	Status	Modify
--	--	--	--	--	--	--	--

Content Restriction

Restriction  Blacklist  Whitelist

Add a New Keyword

3. Click [Add](#).

<input type="checkbox"/>	ID	Device Name	MAC Address	Internet Access Time	Description	Status	Modify
--	--	--	--	--	--	--	--

Device Name:

MAC Address:

Internet Access Time:

Description:

Enable

4. Click [View Existing Devices](#), and select the device to be controlled. Or, enter the [Device Name](#) and [MAC Address](#) manually.
5. Click the  icon to set the Internet Access Time. Drag the cursor over the appropriate cell(s) and click [OK](#).

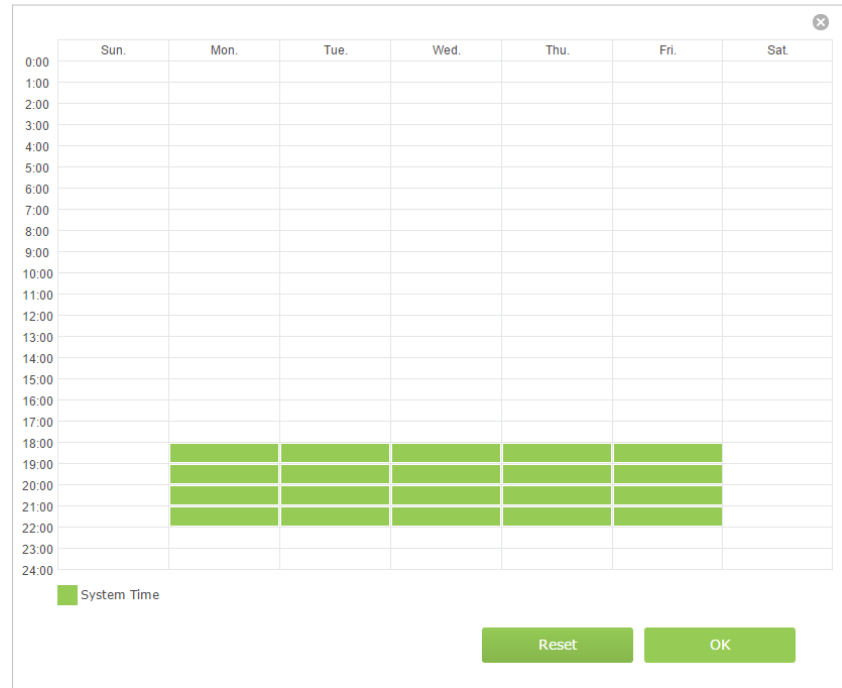

6. Enter a [Description](#) for the entry.
7. Select the checkbox to enable this entry and click [OK](#).
8. Select the restriction mode.
  - 1) In [Blacklist](#) mode, the controlled devices cannot access any websites containing the specified keywords during the Internet Access Time period.
  - 2) In [Whitelist](#) mode, the controlled devices can only access websites containing the specified keywords during the Internet Access Time period.

9. Click [Add a New Keyword](#). You can add up to 200 keywords for both Blacklist and Whitelist. Below are some sample entries to allow access.
  - 1 ) Enter a web address (e.g. [www.tp-link.com](http://www.tp-link.com)) or a web address keyword (e.g. [wikipedia](http://wikipedia)) to only allow or block access to the websites containing that keyword.
  - 2 ) Specify the domain suffix (eg. [.edu](#) or [.org](#)) to allow access only to the websites with that suffix.
  - 3 ) If you wish to block all Internet browsing access, do not add any keyword to the [Whitelist](#).
10. Enter the keywords or websites you want to add and click [Save](#).

**Done!**

Now you can control your children's Internet access according to your needs.

## Chapter 10

---

# Guest Network

---

This function allows you to provide Wi-Fi access for guests without disclosing your main network. When you have guests in your house, apartment, or workplace, you can create a guest network for them. In addition, you can assign network authorities and bandwidth for guests to ensure network security, privacy, and fluency.

- [\*Create a Network for Guests\*](#)
- [\*Customize Guest Network Options\*](#)

## 10.1. Create a Network for Guests

1. Visit <http://tplinkmodem.net>, and log in with the password you set for the modem router.
2. Go to [Advanced](#) > [Guest Network](#). Locate the [Wireless Settings](#) section.
3. Create a 2.4GHz or 5GHz guest network according to your needs.

Wireless Settings

Disable Guest Network

Wireless Network 2.4GHz:  Enable

Wireless Network Name (SSID):   Hide SSID

Security:  None  WPA/WPA2 Personal

Version:  Auto  WPA2-PSK

Encryption:  Auto  TKIP  AES

Password:

Wireless Network 5GHz:  Enable

- 1) Enable [Wireless Network 2.4GHz](#) or [Wireless Network 5GHz](#).
- 2) Set an easy-to-identify SSID. Don't select [Hide SSID](#) unless you want your guests and other people to manually input this SSID for Wi-Fi access.
- 3) Set [Security](#) to [WPA/WPA2 Personal](#), keep the default [Version](#) and [Encryption](#) values, and set an easy-to-remember password.
4. Click [Save](#). Now your guests can access your guest network using the SSID and password you set!

### ◆ Tips:

To view guest network information, go to [Advanced](#) > [Status](#) and find the [Guest Network](#) section.

## 10.2. Customize Guest Network Options

1. Visit <http://tplinkmodem.net>, and log in with the password you set for the modem router.
2. Go to [Advanced](#) > [Guest Network](#).

### Settings

---

See each other:  Allow guests to see each other

Access my local network:  Allow guests to access my local network

USB Storage Sharing:  Allow guests to access my USB storage sharing

Bandwidth Control:  Enable guest network bandwidth control

Save

3. Assign network authorities and bandwidth according to your needs.

- [Allow guests to see each other](#)

Select this checkbox to allow the clients in your guest network to access each other.

- [Allow guests to access my local network](#)

Select this checkbox to allow the clients in your guest network to access your local network, not just Internet access.

- [Allow guests to access my USB storage sharing](#)

Select this checkbox to allow the clients in your guest network to access your router's USB storage sharing.

- [Enable guest network bandwidth control](#)

Select this checkbox to assign the upstream and downstream bandwidth of the guest network. This option is available only when Bandwidth Control is enabled on the [Advanced](#) > [Bandwidth Control](#) page.

Bandwidth Control:  Enable guest network bandwidth control

Upstream (kbps):  -

Downstream (kbps):  -

4. Click [Save](#). Now users in your guest network can enjoy only the network authorities and bandwidth you assigned!

 **Tips:**

To view guest network information, go to [Advanced](#) > [Status](#) and find the [Guest Network](#) section.

## Chapter 11

---

# NAT Forwarding

---

Modem router's NAT (Network Address Translation) feature makes the devices in the LAN use the same public IP address to communicate in the Internet, which protects the local network by hiding IP addresses of the devices. However, it also brings about the problem that external host cannot initiatively communicate with the specified device in the local network.

With forwarding feature the modem router can penetrate the isolation of NAT and allows the external hosts in the Internet to initiatively communicate with the devices in the local network, thus to realize some special functions.

TP-LINK modem router includes four forwarding rules. If two or more rules are set, the priority of implementation from high to low is Virtual Servers, Port Triggering, UPnP and DMZ.

This chapter contains the following sections:

- *Share Local Resources in the Internet by Virtual Server*
- *Open Ports Dynamically by Port Triggering*
- *Make Applications Free from Port Restriction by DMZ*
- *Make Xbox Online Games Run Smoothly by UPnP*



## 11.1. Share Local Resources in the Internet by Virtual Server

When you build up a server in the local network and want to share it on the Internet, Virtual Server can realize the service and provide it to the Internet users. At the same time virtual server can keep the local network safe as other services are still invisible from the Internet.

Virtual server can be used for setting up public services in your local network, such as HTTP, FTP, DNS, POP3/SMTP and Telnet. Different service uses different service port. Port 80 is used in HTTP service, port 21 in FTP service, port 25 in SMTP service and port 110 in POP3 service. Please verify the service port number before the configuration.

**I want to:** share my personal website I've built in local network with my friends through the Internet.

**For example,** the personal website has been built in my home PC (192.168.1.100). I hope that my friends in the Internet can visit my website in some way. The PC is connected to the modem router with the WAN IP address 218.18.232.154.

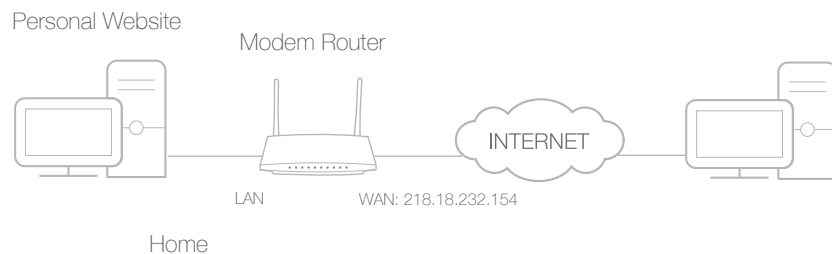

**How can I do that?**

1. Assign a static IP address to your PC, for example 192.168.1.100.
2. Visit <http://tplinkmodem.net>, and log in with the password you set for the modem router.
3. Go to **Advanced > NAT Forwarding > Virtual Servers**, click **Add**.

Virtual Servers

+ Add - Delete

<input type="checkbox"/>	ID	Service Type	External Port	Internal IP	Internal Port	Protocol	Status	Modify
--	--	--	--	--	--	--	--	--

Interface Name:

Service Name:  [View Existing Applications](#)

External Port:  (XX-XX or XX)

Internal IP:

Internal Port:  (XX or Blank, 1-65535)

Protocol:

Enable this Entry

4. Click [View Existing Services](#), and choose **HTTP**. The external port, internal port and protocol will be automatically filled with contents. Enter the PC's IP address 192.168.1.100 in the **Internal IP** field.

5. Click **OK** to save the settings.

◆ **Tips:**

1. It is recommended to keep the default settings of **Internal Port** and **Protocol** if you are not clear about which port and protocol to use.
2. If the service you want to use is not in the **Service Type**, you can enter the corresponding parameters manually. You should verify the port number that the service needs.
3. You can add multiple virtual server rules if you want to provide several services in a modem router. Please note that the **External Port** cannot be overlapped.

**Done!**

Users in the Internet can enter <http://WAN IP> (in this example: <http://218.18.232.154>) to visit your personal website.

◆ **Tips:**

1. WAN IP should be a public IP address. For the WAN IP is assigned dynamically by ISP, it is recommended to apply and register a domain name for the WAN by DDNS, go to [Set Up a Dynamic DNS Service Account](#) for more information. Then you can use <http://domain name> to visit the website.
2. If you have changed the default **External Port**, you should use <http://WAN IP: External Port> or <http://domain name: External Port> to visit the website.

## 11.2. Open Ports Dynamically by Port Triggering

Port triggering can specify a triggering port and its corresponding external ports. When a host in the local network initiates a connection to the triggering port, all the external ports will be opened for subsequent connections. The modem router can record the IP address of the host. When the data from the Internet return to the external ports, the

modem router can forward them to the corresponding host. Port triggering is mainly applied to online games, VoIPs and video players. Common applications include MSN Gaming Zone, Dialpad and Quick Time 4 players, etc.

Follow the steps below to configure the port triggering rules:

1. Visit <http://tplinkmodem.net>, and log in with the password you set for the modem router.
2. Go to [Advanced](#) > [NAT Forwarding](#) > [Port Triggering](#) and click [Add](#).

Port Triggering

+ Add - Delete

<input type="checkbox"/>	ID	Application	Triggering Port	Triggering Protocol	External Port	External Protocol	Status	Modify
--	--	--	--	--	--	--	--	--

Interface Name: pppoe\_0\_38\_1\_d

Application: MSN Gaming Zone [View Existing Applications](#)

Triggering Port: 47624 (XX)

Triggering Protocol: TCP

External Port: 2300-2400,28800-29000 (XX or XX-XX or XX,XX-XX)

External Protocol: TCP

Enable this Entry

Cancel OK

3. Click [View Existing Applications](#), and select the desired application. The triggering port and protocol, the external port and protocol will be automatically filled with contents. Here we take application [MSN Gaming Zone](#) as an example.
4. Click [OK](#) to save the settings.

◆ **Tips:**

1. You can add multiple port triggering rules according to your network need.
2. If the application you need is not listed in the [Existing Applications](#) list, please enter the parameters manually. You should verify the external ports the application uses first and enter them into [External Port](#) field according to the format the page displays.

### 11.3. Make Applications Free from Port Restriction by DMZ

When a PC is set to be a DMZ (Demilitarized Zone) host in the local network, it is totally exposed to the Internet, which can realize the unlimited bidirectional communication between internal hosts and external hosts. The DMZ host becomes a virtual server with

all ports opened. When you are not clear about which ports to open in some special applications, like IP camera and database software, you can set the PC to be a DMZ host.

**Note:**

DMZ is more applicable in the situation that users are not clear about which ports to open. When it is enabled, the DMZ host is totally exposed to the Internet, which may bring some potential safety hazard. If DMZ is not in use, please disable it in time.

**I want to:** make the home PC join the Internet online game without port restriction.

**For example,** Due to some port restriction, when playing the online games, you can login normally but cannot join a team with other players. To solve this problem, set your PC as a DMZ with all ports opened.

**How can I do that?**

1. Assign a static IP address to your PC, for example 192.168.1.100.
2. Visit <http://tplinkmodem.net>, and log in with the password you set for the modem router.
3. Go to **Advanced > NAT Forwarding > DMZ** and select the checkbox to enable DMZ.

4. Enter the IP address 192.168.1.100 in the **DMZ Host IP Address** field.
5. Click **Save** to save the settings.

**Done!**

The configuration is completed. You've set your PC to a DMZ host and now you can make a team to game with other players.

## 11.4. Make Xbox Online Games Run Smoothly by UPnP

UPnP (Universal Plug and Play) protocol allows the applications or host devices to automatically find the front-end NAT device and send request to it to open the corresponding ports. With UPnP enabled, the applications or host devices in the both sides of NAT device can freely communicate with each other realizing the seamless connection of the network. You may need to enable the UPnP if you want

to use applications for multiplayer gaming, peer-to-peer connections, real-time communication (such as VoIP or telephone conference) or remote assistance, etc.

◆ **Tips:**

1. UPnP is enabled by default in this modem router.
2. Only the application supporting UPnP protocol can use this feature.
3. UPnP feature needs the support of operating system (e.g. Windows Vista/ Windows 7/ Windows 8, etc. Some of operating system need to install the UPnP components).

**For example,** When you connect your Xbox to the modem router which has connected to the Internet to play online games, UPnP will send request to the modem router to open the corresponding ports allowing the following data penetrating the NAT to transmit. Therefore, you can play Xbox online games without a hitch.

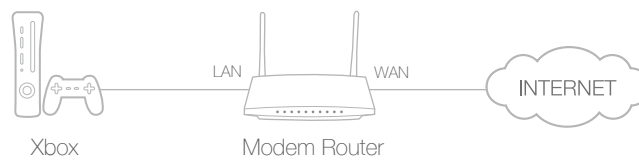

If necessary, you can follow the steps to change the status of UPnP.

1. Visit <http://tplinkmodem.net>, and log in with the password you set for the modem router;
2. Go to **Advanced > NAT Forwarding > UPnP** and toggle on or off according to your needs.

**UPnP**

---

UPnP:

**UPnP Service List**

Client Number: 0 🔄 Refresh

ID	Service Description	External Port	Protocol	Internal IP Address	Internal Port
--	--	--	--	--	--

## Chapter 12

---

# Specify Your Network Settings

---

This chapter introduces how to change the default settings or adjust the basic configuration of the modem router using the web-based management page.

This chapter contains the following sections:

- *LAN Settings*
- *Wireless Settings*
- *Set Up a Dynamic DNS Service Account*
- *Interface Grouping*
- *Create Static Routes*
- *Set up a VPN Connection*
- *Set Up the IPv6 Tunnel*

## 12. 1. LAN Settings

### 12. 1. 1. Change the LAN IP Address

The modem router is preset with a default LAN IP 192.168.1.1, which you can use to log in to its web-based management page. The LAN IP address together with the Subnet Mask also defines the subnet that the connected devices are on. If the IP address conflicts with another device on your local network or your network requires a specific IP subnet, you can change it.

Follow the steps below to change your IP address.

1. Visit <http://tplinkmodem.net>, and log in with the password you set for the modem router.
2. Go to [Advanced](#) > [Network](#) > [LAN Settings](#) page and select [IPv4](#).

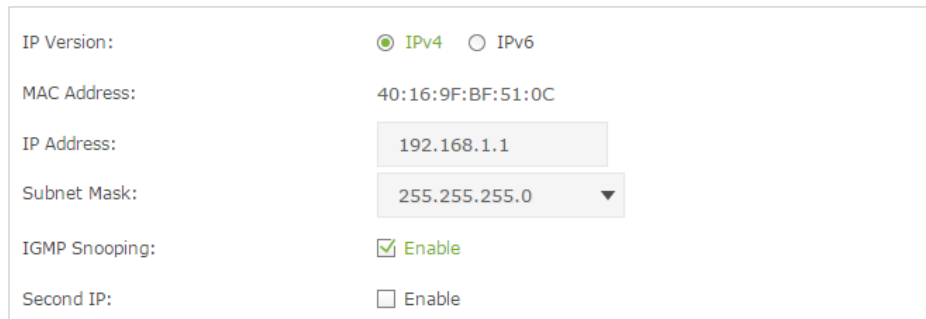

The screenshot shows the LAN Settings configuration page. It includes the following fields and options:

- IP Version:** Radio buttons for IPv4 (selected) and IPv6.
- MAC Address:** 40:16:9F:BF:51:0C
- IP Address:** Text input field containing 192.168.1.1
- Subnet Mask:** Drop-down menu showing 255.255.255.0
- IGMP Snooping:** Checkmark and text 'Enable' (checked)
- Second IP:** Checkmark and text 'Enable' (unchecked)

3. Type in a new [IP Address](#) appropriate to your needs.
4. Select the [Subnet Mask](#) from the drop-down list. The subnet mask together with the IP address identifies the local IP subnet.
5. Keep [IGMP Snooping](#) as enabled by default. IGMP snooping is the process of listening to IGMP (Internet Group Management Protocol) network traffic. The function prevents hosts on a local network from receiving traffic for a multicast group they have not explicitly joined.
6. You can configure the modem router's [Second IP](#) and [Subnet Mask](#) for LAN interface through which you can also access the web management page.
7. Leave the rest of the default settings as they are.
8. Click [Save](#) to make the settings effective.

### 12. 1. 2. Use the Modem Router as a DHCP Server

You can configure the modem router to act as a DHCP server to assign IP addresses to its clients. To use the DHCP server function of the modem router, you must configure all computers on the LAN to obtain an IP Address automatically.

Follow the steps below to configure DHCP server.

1. Visit <http://tplinkmodem.net>, and log in with the password you set for the modem router.
2. Go to [Advanced](#) > [Network](#) > [LAN Settings](#) page and select **IPv4**.

DHCP:  Enable

DHCP Server  DHCP Relay

IP Address Pool: 192.168.1.100 - 192.168.1.199

Address Lease Time: 1440 minutes. (1-2880. The default value is 1440.)

Default Gateway: 192.168.1.1 (optional)

Default Domain: (optional)

Primary DNS: 0.0.0.0 (optional)

Secondary DNS: 0.0.0.0 (optional)

Save

3. Select **DHCP** to enable the DHCP function and select **DHCP Server**.
4. Specify the **IP Address Pool**, the start address and end address must be on the same subnet with LAN IP. The modem router will assign addresses within this specified range to its clients. It is from 192.168.1.100 to 192.168.1.199 by default.
5. Enter a value for the **Address Lease Time**. The **Address Lease Time** is the amount of time in which a DHCP client can lease its current dynamic IP address assigned by the modem router. After the dynamic IP address expires, the user will be automatically assigned a new dynamic IP address. The default is 1440 minutes.
6. Keep the rest of the settings as default and click **Save** to make your settings effective.

■ **Note:**

1. The modem router can be configured to work as a **DHCP Relay**. A DHCP relay is a computer that forwards DHCP data between computers that request IP addresses and the DHCP server that assigns the addresses. Each of the device's interfaces can be configured as a DHCP relay. If it is enabled, the DHCP requests from local PCs will be forwarded to the DHCP server that runs on WAN side.
2. You can also appoint IP addresses within a specified range to devices of the same type by using **Condition Pool** feature. For example, you can assign IP addresses within the range (192.168.1.50 to 192.168.1.80) to Camera devices, thus facilitating the network management. Enable DHCP feature and configure the parameters according to your actual situation on [Advanced](#) > [Network](#) > [LAN Settings](#) page.

### 12.1.3. Reserve LAN IP Addresses

You can view and add a reserved address for a client. When you specify an IP address for a device on the LAN, that device will always receive the same IP address each time when it accesses the DHCP server. If there are some devices in the LAN that require



permanent IP addresses, please configure Address Reservation on the router for the purpose.

Follow the steps below to reserve an IP address for your device.

1. Visit <http://tplinkmodem.net>, and log in with the password you set for the modem router.
2. Go to [Advanced](#) > [Network](#) > [LAN Settings](#) page and select [IPv4](#).
3. Scroll down to locate the [Address Reservation](#) table and click [Add](#) to add an address reservation entry for your device.

Address Reservation

+ Add - Delete

<input type="checkbox"/>	MAC Address	Reserved IP	Group	Enable	Modify
--	--	--	--	--	--

MAC Address:

Reserved IP:

Group: Default ▼

Enable this entry

Cancel OK

4. Enter the [MAC Address](#) of the device for which you want to reserve IP address.
5. Specify the IP address which will be reserved by the router.
6. Check to [Enable this entry](#) and click [OK](#) to make the settings effective.

## 12.2. Wireless Settings

### 12.2.1. Specify Basic Wireless Settings

The modem router's wireless network name (SSID) and password, and security option are preset in the factory. The preset SSID and password can be found on the product label. You can customize the wireless settings according to your needs.

Visit <http://tplinkmodem.net>, and log in with the password you set for the modem router. Go to [Basic](#) > [Wireless](#) page.

The screenshot shows the 'Wireless Settings' page with two sections for 2.4GHz and 5GHz networks. Each section has an 'Enable' checkbox checked, a text input for the SSID, a text input for the password, and a 'Hide SSID' checkbox. The 2.4GHz SSID is 'TP-LINK\_510C' and the 5GHz SSID is 'TP-LINK\_510C\_5G'. Both passwords are '62292863'. A green 'Save' button is located at the bottom right.

➤ **To enable or disable the wireless function:**

Enable the [Wireless Network 2.4GHz](#) or [5GHz](#). If you don't want to use the wireless function, just uncheck the box. If you disable the wireless function, all the wireless settings won't be effective.

➤ **To change the wireless network name (SSID) and wireless password:**

Enter a new SSID using up to 32 characters. The default SSID is TP-LINK\_XXXX and the value is case-sensitive.

■ **Note:**

If you use a wireless device to change the wireless settings, you will be disconnected when the settings are effective. Please write down the new SSID and password for future use.

➤ **To hide SSID:**

Select Hide SSID, and your SSID will not broadcast. Your SSID won't display when you scan for local wireless network list on your wireless device and you need to manually join the network.

➤ **To change the mode or channel:**

Go to [Advanced](#) > [Wireless](#) > [Wireless Settings](#) page and select the wireless network 2.4GHz or 5GHz.

**Mode:** Select the desired mode.

- 802.11n only: Select only if all of your wireless clients are 802.11n devices.
- 802.11gn mixed: Select if you are using both 802.11g and 802.11n wireless clients.
- 802.11bgn mixed: Select if you are using a mix of 802.11b, 11g, and 11n wireless clients.

■ **Note:** When 802.11n only mode is selected, only 802.11n wireless stations can connect to the modem router. It is strongly recommended that you select 802.11bgn mixed, and all of 802.11b, 802.11g, and 802.11n wireless stations can connect to the modem router.

- 802.11ac/n mixed (5Ghz): Select if you are using both 802.11ac and 802.11n wireless clients.
- 802.11a/n/ac mixed (5Ghz): Select if you are using a mix of 802.11a, 802.11n and 802.11ac wireless clients. It is strongly recommended that you select 11a/n/ac mixed.

**Channel:** Select the channel you want to use from the drop-down list. This field determines which operating frequency will be used. It is not necessary to change the wireless channel unless you notice interference problems with another nearby access point.

**Channel Width:** Select the channel width from the drop-down list. The default setting is **Automatic**, which can adjust the channel width for your clients automatically.

➤ **To change the security option:**

1. Go to **Advanced > Wireless > Wireless Settings** page.
2. Select the wireless network 2.4GHz or 5GHz.
3. Select an option from the **Security** drop-down list. The router provides four options, None, WPA/WPA2 Personal (Recommended), WPA/WPA2 Enterprise, WEP. WPA2 uses the newest standard and the security level is the highest. We recommend you don't change the default settings unless necessary.

### 12.2.2. Use WPS for Wireless Connection

You can use WPS feature to add a new wireless device to your existing network quickly.

#### Method 1 Use the Wi-Fi Protected Setup Button

Use this method if your client device has a Wi-Fi Protected Setup button.

1. Press the WPS/RESET button on the back panel of the modem router for 1 second.



2. Press the WPS button of the client device directly.
3. The WPS LED flashes for about two minutes during the WPS process.
4. When the WPS LED is on, the client device has successfully connected to the modem router.

## Method 2 Enter the client device's PIN on the modem router

1. Visit <http://tplinkmodem.net>, and log in with the password you set for the modem router.
2. Go to [Advanced](#) > [Wireless](#) > [WPS](#) page. Select the wireless network 2.4GHz or 5GHz according to your wireless client.

WPS Settings 2.4GHz | 5GHz

Enable WPS:

Select a setup method:

Push Button (Recommended)

PIN Code

Enter the client's PIN:

[Connect](#)

3. Keep the default WPS status as Enabled and select the [PIN Code](#) radio button.
4. Enter the client device's PIN in the field on the above WPS screen. Then click the [Connect](#) button.
5. "[Connect successfully](#)" will appear on the above screen, which means the client device has successfully connected to the modem router.

## Method 3 Enter the modem router's PIN on your client device

Use this method if your client device asks for the modem router's PIN.

1. Visit <http://tplinkmodem.net>, and log in with the password you set for the modem router.
2. Go to [Advanced](#) > [Wireless](#) > [WPS](#) page. Select the wireless network 2.4GHz or 5GHz according to your wireless client.

Router's PIN 2.4GHz | 5GHz

Other devices can connect to the router using the router's WPS PIN code.

Router's PIN:

Current PIN:  [Generate](#) [Restore](#)

3. Keep the Router's PIN status as enabled. Take a note of the Current PIN of the modem router. You can also click the [Generate](#) button to get a new PIN.
4. On the client device, enter the modem router's PIN. (The default PIN is also labeled on the bottom of the modem router.)
5. The WPS LED flashes for about two minutes during the WPS process.
6. When the WPS LED is on, the client device has successfully connected to the modem router.

■ **Note:**

1. The WPS LED on the modem router will light green for five minutes if the device has been successfully added to the network.
2. The WPS function cannot be configured if the wireless function of the modem router is disabled. Please make sure the wireless function is enabled before configuring the WPS.

### 12.2.3. Schedule Your Wireless Function

You can automatically turn off your wireless network (both 2.4GHz and 5GHz) at time when you do not need the wireless connection.

1. Visit <http://tplinkmodem.net>, and log in with the password you set for the modem router.
2. Go to [Advanced](#) > [Wireless](#) > [Wireless Schedule](#) page.
3. Select the 2.4GHz wireless network to configure. Toggle on the button to enable the Wireless Schedule feature.

Task Schedule
2.4GHz | 5GHz

Enable Wireless Schedule:

	Sun.	Mon.	Tue.	Wed.	Thu.	Fri.	Sat.
0:00							
1:00							
2:00							
3:00							
4:00							
5:00							
6:00							
7:00							
8:00							
9:00							
10:00							
11:00							
12:00							
13:00							
14:00							
15:00							
16:00							
17:00							
18:00							
19:00							
20:00							
21:00							
22:00							
23:00							
24:00							

System Time

Restore
Save

4. Set the time. Drag the cursor to cover the time area and click [Save](#) to make the settings effective. The selected time will be in green.
5. Repeat steps 3 and 4 to set time for 5GHz wireless network.

■ **Note:**

1. If you just set time for one wireless band, the other wireless band is still always on, so set time for both of the two bands to schedule your whole wireless network.
2. The wireless LED (2.4GHz , 5GHz ) will turn off if the corresponding wireless network is disabled.
3. The wireless network will be automatically turned on after the time period you set.

### 12. 2. 4. View Wireless Information

➤ **To view the detailed wireless network settings:**

1. Visit <http://tplinkmodem.net>, and log in with the password you set for the modem router.
2. Go to [Advanced](#) > [Status](#) page. You can see the [Wireless](#) box.
3. Select 2.4GHz or 5GHz to view the wireless details.



◆ **Tips:** You can also see the wireless details by clicking the router icon on [Basic > Network Map](#).

➤ **To view the detailed information of the connected wireless clients:**

1. Visit <http://tplinkmodem.net>, and log in with the password you set for the modem router.
2. Go to [Advanced > Wireless > Statistics](#) page.
3. You can view the detailed information of the wireless clients, including its connected wireless band and security option as well as the packets transmitted.

◆ **Tips:** You can also see the wireless details by clicking the wireless clients icon on [Basic > Network Map](#).

### 12.2.5. Advanced Wireless Settings

Advanced wireless settings are for those who have a network concept. If you are not familiar with the settings on this page, it's strongly recommended that you keep the provided default values; otherwise it may result in lower wireless network performance.

1. Visit <http://tplinkmodem.net>, and log in with the password you set for the modem router.
2. Go to [Advanced > Wireless > Advanced Settings](#) page.

Advanced Settings
2.4GHz | 5GHz

---

Beacon Interval:	<input type="text" value="100"/>	(25-1000)
RTS Threshold:	<input type="text" value="2346"/>	(1-2346)
DTIM Interval:	<input type="text" value="1"/>	(1-255)
Group Key Update Period:	<input type="text" value="0"/>	seconds
WMM:	<input checked="" type="checkbox"/> Enable	
Short GI:	<input checked="" type="checkbox"/> Enable	
AP Isolation:	<input type="checkbox"/> Enable	

- **Beacon Interval:** Enter a value between 25 and 1000 in milliseconds to determine the duration between which beacon packets are broadcasted by the router to synchronize the wireless network. The default is 100 milliseconds.
- **RTS Threshold:** Enter a value between 1 and 2346 to determine the packet size of data transmission through the router. By default, the RTS (Request to Send) Threshold size is 2346. If the packet size is greater than the preset threshold, the router sends Request to Send frames to a particular receiving station and negotiates the sending of a data frame, or else the packet will be sent immediately.
- **DTIM Interval:** Enter a value between 1 and 255 to determine the interval of the Delivery Traffic Indication Message (DTIM). 1 indicates the DTIM Interval is the same as **Beacon Interval**.
- **Group Key Update Period:** Enter the number of seconds to control the time interval for the encryption key automatic renewal. The default is 0, indicating no key renewal.
- **Enable WMM:** This feature guarantees the packets with high-priority messages being transmitted preferentially. WMM is enabled compulsively under 802.11n or 802.11ac mode. It is strongly recommended to enable WMM.
- **Enable Short GI:** This feature is enabled by default and recommended to increase the data capacity by reducing the Guard Interval (GI) time.
- **AP Isolation:** Select this checkbox to enable the AP Isolation feature that allows you to confine and restrict all wireless devices on your network from interacting with each other, but still able to access the Internet. AP isolation is disabled by default.
- **WDS:** Select this checkbox to enable the WDS (Wireless Distribution System) Bridging feature to allow the router to bridge with another access point (AP) in a wireless local area network (WLAN). Refer [T7. How to use the WDS Bridging function to extend my wireless network?](#) under [Appendix B: Troubleshooting](#) for detailed instructions.



## 12.3. Set Up a Dynamic DNS Service Account

Most ISPs (Internet service providers) assign a dynamic IP address to the router and you can use this IP address to access your router remotely. However, the IP address can change any time and you don't know when it changes. In this case, you might need the DDNS (Dynamic Domain Name Server) feature on the router to allow you and your friends to access your router and local servers (FTP, HTTP, etc.) using domain name, in no need of checking and remembering the IP address.

■ **Note:** DDNS does not work if the ISP assigns a private WAN IP address (such as 192.168.1.x) to the modem router.

To set up DDNS, please follow the instructions below:

1. Visit <http://tplinkmodem.net>, and log in with the password you set for the modem router.
2. Go to [Advanced](#) > [Network](#) > [Dynamic DNS](#).
3. Select the [DDNS service provider](#) (Dyndns or NO-IP). If you don't have a DDNS account, select a service provider and click [Go to register](#).

4. Enter the username, password and domain name of the account (such as lisa.ddns.net).
5. Click [Login](#) and [Save](#).

◆ **Tips:** If you want to use a new DDNS account, please Logout first, then login with the new account.

## 12.4. Interface Grouping

### I want to:

Divide my devices connected to the modem router into different groups and disallow devices' cross-group communication.

**For example,** in my house, devices connected to LAN1 and LAN3 are for work, while others for entertainment. I want to isolate working devices from others while keep all devices' access to the Internet.

## How can I do that?

1. Visit <http://tplinkmodem.net>, and log in with the password you set for the modem router.
2. Go to [Advanced](#) > [Network](#) > [Interface Grouping](#) to open the configuration page where some interfaces can be grouped together.

Interface Grouping

Note: You cannot disable VLAN when IPTV is enabled.

Enable VLAN:

[+ Add](#)

Group	LAN Interface	WAN Interface	Delete
Default	LAN4	br_8_35_0	
	LAN3		
	LAN2		
	LAN1		
	Wi-Fi_2.4G		
	Wi-Fi_5G		

3. Click to [Add](#) a new group.

Add a New Group

Group Name:

Available LAN	Available WAN
<input type="checkbox"/> LAN4 <input checked="" type="checkbox"/> LAN3 <input type="checkbox"/> LAN2 <input checked="" type="checkbox"/> LAN1 <input type="checkbox"/> Wi-Fi_2.4G <input type="checkbox"/> Wi-Fi_5G	<input type="checkbox"/> br_8_35_0

Enable Group Isolation

4. Name the group.
5. Check the boxes of [LAN1](#) and [LAN3](#) in Available LAN. Here [Wi-Fi 2.4G](#) network and [Wi-Fi 5G](#) network are viewed as a LAN interface respectively.
6. Click [Enable Group Isolation](#) to isolate working devices and disallow other devices from communicating with them.
7. Click [OK](#) to save the settings.

**Done!**

Now your working devices connected to LAN1 and LAN3 are in an isolated group!

■ **Note:** VLAN function is enabled by default. You cannot disable it when IPTV is enabled.

## 12.5. Create Static Routes

A static route is a pre-determined path that network information must travel to reach a specific host or network. Data from one point to another will always follow the same path regardless of other considerations. Normal Internet usage does not require this setting to be configured.

**I want to:**

Visit multiple networks and multiple servers at the same time.

**For example**, in a small office, my PC can surf the Internet, but I also want to visit my company's server. Now I have a switch and another router. I connect the devices as shown in the following figure so that the physical connection between my PC and my company's server is achieved. To surf the Internet and visit my company's network at the same time, I need to configure the static routing.

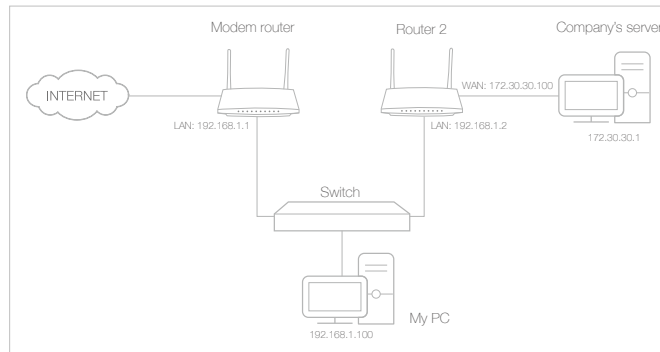
**How can I do that?**

1. Make sure the routers use different LAN IP addresses on the same subnet. Disable Router 2's DHCP function.
2. Visit <http://tplinkmodem.net>, and log in with the password you set for the modem router.
3. Go to **Advanced > Network > Advanced Routing**. Select your current **WAN Interface** and click **Save**.

### Default Gateway Settings IPv4 | IPv6

Select a WAN interface as the system default gateway.

Select WAN Interface: pppoe\_8\_35\_1\_d Save

---

### Static Routing

+ Add - Delete

☐	ID	Destination IP	Subnet Mask	Gateway	Enable	Modify
--	--	--	--	--	--	--

4. Click [Add](#) to add a new static routing entry. Finish the settings according to the following explanations:

### Static Routing

+ Add - Delete

☐	ID	Destination IP	Subnet Mask	Gateway	Enable	Modify
--	--	--	--	--	--	--

Destination IP: 172.30.30.1

Subnet Mask: 255.255.255.255

Gateway: 192.168.0.2

Interface: LAN ▼

Enable this entry

Cancel
OK

- **Destination IP:** The destination IP address that you want to assign to a static route. This IP address cannot be on the same subnet with the WAN IP or LAN IP of the router. In the example, the IP address of the company network is the destination IP address, so here enters 172.30.30.1.
- **Subnet Mask:** Determines the destination network with the destination IP address. If the destination is a single IP address, enter 255.255.255.255; otherwise, enter the subnet mask of the corresponding network IP. In the example, the destination network is a single IP, so here enters 255.255.255.255.
- **Gateway:** The IP address of the gateway device to which the data packets will be sent. This IP address must be on the same subnet with the router's IP which sends out the data. In the example, the data packets will be sent to the LAN port of

Router 2 and then to the Server, so the default gateway should be 192.168.1.2.

- **Interface:** Determined by the port (WAN/LAN) that sends out the data packets. In the example, the data is sent to the gateway through the LAN port, so LAN should be selected.
5. Check to enable this entry and click **OK** to save the settings.

## Done!

Open a web browser on your PC. Enter the company server's IP address to visit the company network.

## 12.6. Set up a VPN Connection

VPN (Virtual Private Network) is a private network established across the public network, generally via the Internet. However, the private network is a logical network without any physical network lines, so it is called Virtual Private Network.

With the wide application of the Internet, more and more data are needed to be shared through the Internet. Connecting the local network to the Internet directly, though can allow the data exchange, will cause the private data to be exposed to all the users on the Internet.

The VPN (Virtual Private Network) technology is developed and used to establish the private network through the public network, which can provides a secure communication to a remote computer or remote network, and guarantee a secured data exchange. IPSec is one of the major implementations of VPNs.

### I want to:

Establish an IPSec VPN tunnel to connect two LANs via Internet so that the hosts in different remote LANs are able to communicate with each as if they are in the same LAN.

**For example,** I am the network administrator of a regional office, I need to let my office staff can visit the headquarter's servers and resources, and vice versa. I know that the modem router in my office and the device in headquarter both support IPSec VPN feature, so I decide to set up a VPN connection with the headquarter office.

The following diagram is a typical VPN topology. Here Site A refers to regional office's network (local network). And Site B refers to the headquarter's network (remote network) which I want to connect.

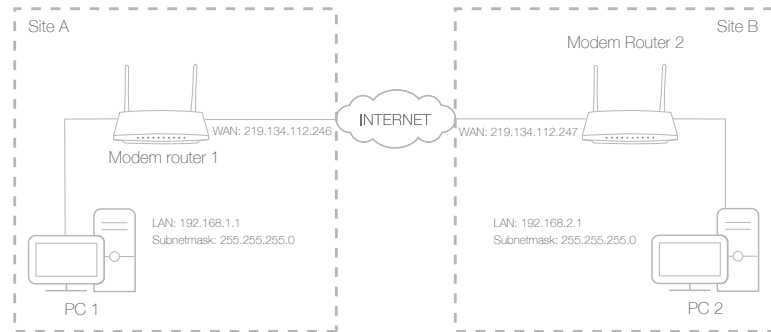

## How can I do that?

1. Make sure of the topology you want to build and record site A (local network) and site B (remote network)'s LAN IP and WAN IP.
2. Configuration on site A (local network).
  - 1) Visit <http://tplinkmodem.net>, and log in with the password you set for the modem router.
  - 2) Go to **Advanced** > **Network** > **IPSec VPN** to open the configuration page. Click **Add** to set up a VPN tunnel.

IPSec Settings

Dead Peer Detection:

+ Add - Delete

<input type="checkbox"/>	Connection Name	Remote Gateway	Local Address	Remote Address	Status	Enable	Modify
--	--	--	--	--	--	--	--

IPSec Connection Name: VPN1

Remote IPSec Gateway (URL): 219.134.112.247 Site B's WAN IP

Tunnel access from local IP addresses: Subnet Address ▼

IP Address for VPN: 192.168.1.0 LAN IP range of Site A

Subnet Mask: 255.255.255.0

Tunnel access from remote IP addresses: Subnet Address ▼

IP Address for VPN: 192.168.2.0 LAN IP range of Site B

Subnet Mask: 255.255.255.0

Key Exchange Method: Auto(IKE) ▼

Authentication Method: Pre-Shared Key ▼

Pre-Shared Key: psk\_key

Perfect Forward Secrecy: Enable ▼

Advanced

Cancel OK

- 3) In the **IPSec Connection Name** column, specify a name.
- 4) In the **Remote IPSec Gateway (URL)** column, Enter Site B's WAN IP address.
- 5) To configure **Site A's LAN**:

In the **Tunnel access from local IP addresses** column, here we take **Subnet Address** as an example. Then input the LAN IP range of Site A in the **IP Address for VPN** column, and input **Subnet Mask** of Site A.

- 6) To configure **Site B's LAN**:

In the **Tunnel access from local IP addresses** column, here we take **Subnet Address** as an example. Then input the LAN IP range of Site B in the **IP Address for VPN** column, and input **Subnet Mask** of Site B.

- 7) Select the **Key Exchange Method** for the policy. We select **Auto(IKE)** here.

- 8) Enter the **Pre-Shared Key** for IKE authentication. Then keep **Perfect Forward Secrecy** enabled.
    - **Note:**  
The key should consist of visible characters without blank space.  
Make sure Site A and Site B use the same key.
  - 9) Leave the **Advanced Settings** as default value. Then click **OK** to save.
3. Configuration on Site B (remote network). Refer to step 2 configuration on Site A and make sure that Site A and Site B use the same **pre-shared keys** and **Perfect Forward Secrecy** settings.
  4. The **Status** column will change to **UP** if the VPN connection has been set up successfully.
  5. Check the VPN connection. You can ping site B' LAN IP from your computer in site A to verify that the IPsec VPN connection is set up correctly.
    - ◆ **Tips:** To check the VPN connection, you can do the following.  
On the host in Site A, press [Windows Logo] + [R] to open Run dialog. Input "cmd" and hit OK.

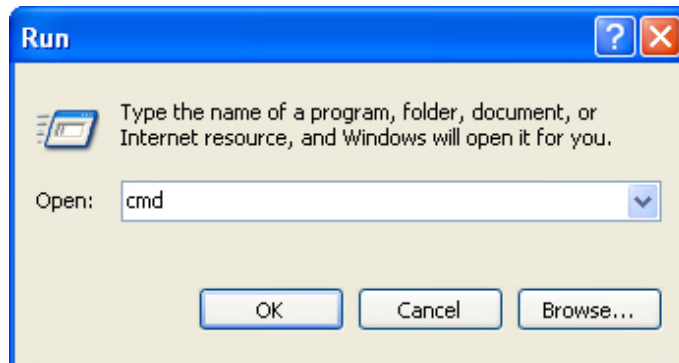

- a . In the CLI window, type in "ping 192.168.2.x" ("192.168.2.x" can be IP address of any host in Site B). Then press [Enter].



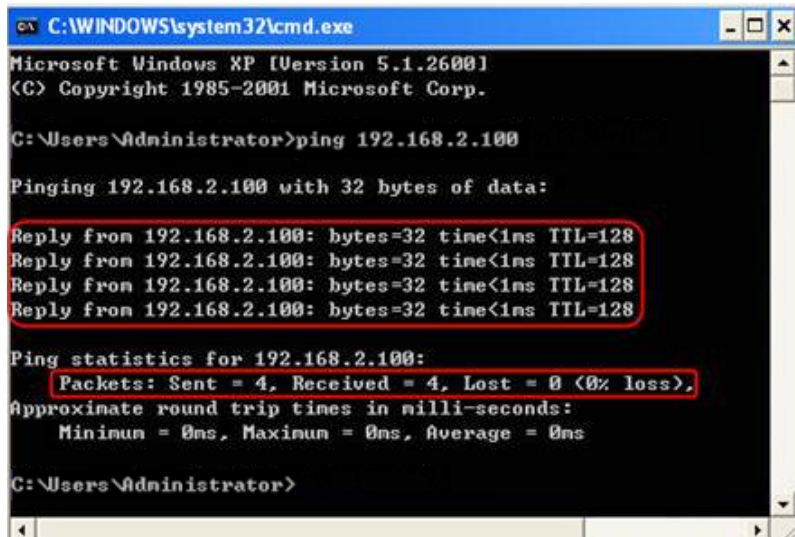

```

C:\WINDOWS\system32\cmd.exe
Microsoft Windows XP [Version 5.1.2600]
(C) Copyright 1985-2001 Microsoft Corp.

C:\Users\Administrator>ping 192.168.2.100

Pinging 192.168.2.100 with 32 bytes of data:

Reply from 192.168.2.100: bytes=32 time<1ms TTL=128
Reply from 192.168.2.100: bytes=32 time<1ms TTL=128
Reply from 192.168.2.100: bytes=32 time<1ms TTL=128
Reply from 192.168.2.100: bytes=32 time<1ms TTL=128

Ping statistics for 192.168.2.100:
    Packets: Sent = 4, Received = 4, Lost = 0 (0% loss),
    Approximate round trip times in milli-seconds:
        Minimum = 0ms, Maximum = 0ms, Average = 0ms

C:\Users\Administrator>

```

If Ping proceeds successfully (gets replies from host in Site B), the IPSec connection is working properly now.

## Done!

Now IPSec VPN is implemented to establish a connection.

### Note:

1. The product supports a maximum of ten simultaneous connections.
2. If one of the site has been off line for a while, for example, if Site A has been disconnected, on Site B you need to click [Disable](#) and then click [Enable](#) after Site A back on line in order to re-establish the IPSec tunnel. Set Up the IPv6 Tunnel

## 12.7. Set Up the IPv6 Tunnel

The IPv6 Tunnel feature helps you obtain IPv6 resources based on an IPv4 WAN connection or vice versa.

IPv6 Tunnel is a transition mechanism that enables IPv6-only hosts to reach IPv4 services or vice versa and allows isolated IPv6 hosts and networks to reach each other over IPv4-only infrastructure before IPv6 completely supplants IPv4. It is a temporary solution for networks that do not support native dual-stack, where both IPv6 and IPv4 run independently.

The modem router provides three tunneling mechanisms: [6to4](#), [6rd](#) and [DS-Lite](#). The way to set up 6rd and DS-Lite tunnel are similar.

### 12.7.1. Use the Public IPv6 Tunnel Service-6to4

The 6to4 tunnel is a kind of public service. If there is any 6to4 server in your network, you can use this mechanism to access IPv6 service. If your ISP provides you with an IPv4-only connection but you want to visit IPv6 websites, you can try to set up a 6to4 tunnel.

**I want to:** Set up the IPv6 tunnel though my ISP doesn't provide me with the tunnel service.

**How can I do that?**

1. Visit <http://tplinkmodem.net>, and log in with the password you set for the modem router.
2. Go to [Advanced](#) > [Network](#) > [IPv6 Tunnel](#).
3. Tick the check box, select [6to4](#) as the tunneling mechanism and select a WAN connection from the drop-down list, then click [Save](#).

**Note:**

If there is no available WAN connection to choose, make sure you have connected to the Internet and the connection type is not Bridge.

**Done!** Now you can visit the IPv6 websites with the 6to4 tunnel.

**Note:**

Still not being able to access IPv6 resources means that not any 6to4 public server was found in your network. You can contact your ISP to sign up for IPv6 connection service.

## 12.7.2. Specify the 6rd Tunnel with Parameters Provided by Your ISP

**I want to:** Specify the 6rd tunnel with the parameters provided by my 6rd tunnel service provider.

**How can I do that?**

1. Visit <http://tplinkmodem.net>, and log in with the password you set for the modem router.
2. Go to [Advanced](#) > [Network](#) > [IPv6 Tunnel](#).
3. Tick the check box, select [6RD](#) as the tunneling mechanism and select a WAN connection from the drop-down list.
4. According to the parameters provided by your ISP, choose [Auto](#) or [Manual](#). More parameters are needed if you choose [Manual](#).
5. Click [Save](#).

### IPv6 Tunnel

Note: You must reconfigure the settings on this page after rebooting the device. You must also ensure the desired WAN connection is connected before you configure the tunnel.

IPv6 Tunnel:  Enable

Mechanism: 6RD

WAN Connection: pppoe\_8\_35\_1\_d

Configuration Type:  Auto  Manual

IPv4 Mask Length: 0

6RD Prefix: ::

6RD Prefix Length: 0

Border Relay IPv4 Address: 0.0.0.0

Save

**Note:**

If there is no available WAN connection to choose, make sure you have connected to the Internet and the connection type is not Bridge.

**Done!**

Now you can visit the IPv6 websites with the 6rd tunnel.

**Tips:**

The way to set up DS-Lite tunnel is similar to that of 6rd tunnel. If you are provided with an IPv6-only WAN connection and have signed up for DS-Lite tunnel service, specify the DS-Lite tunnel by referring to the steps above.

## Chapter 13

---

# Administrate Your Network

---

This chapter introduces how to change the system settings and administrate your modem router's network.

This chapter contains the following sections:

- *Set System Time and Region*
- *Update the Firmware*
- *Back up and Restore Configuration Settings*
- *Change the Administrator Account*
- *Local Management*
- *Remote Management*
- *System Log*
- *Monitor the Internet Traffic Statistics*
- *CWMP Settings*
- *SNMP Settings*

## 13.1. Set System Time and Region

System time is the time displayed while the modem router is running. The system time you configure here will be used for other time-based functions like Parental Controls and Wireless Schedule. You can manually set how to get the system time.

Follow the steps below to set your system time.

1. Visit <http://tplinkmodem.net>, and log in with the password you set for the modem router.
2. Go to [Advanced](#) > [System Tools](#) > [Time Settings](#) page.

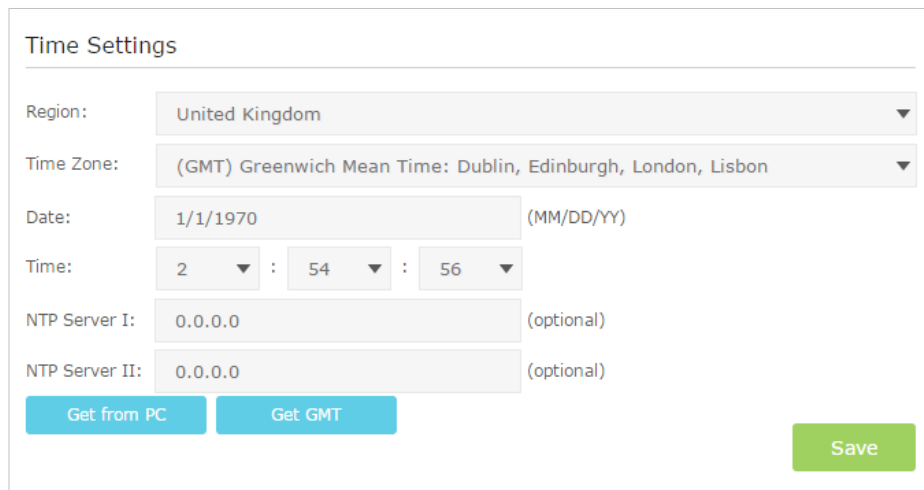

The screenshot shows the 'Time Settings' page. It includes a 'Region' dropdown menu set to 'United Kingdom', a 'Time Zone' dropdown menu set to '(GMT) Greenwich Mean Time: Dublin, Edinburgh, London, Lisbon', a 'Date' input field with '1/1/1970' and '(MM/DD/YY)' label, a 'Time' input field with '2 : 54 : 56' and dropdown arrows, 'NTP Server I' and 'NTP Server II' input fields both set to '0.0.0.0' with '(optional)' labels, and three buttons: 'Get from PC', 'Get GMT', and 'Save'.

3. Select your [Region](#) from the drop-down list. The region is where the wireless function of the device can be used. It may be illegal to use the wireless function of the device in a region other than regions specified in the list. If your country or region is not listed, please contact your local government agency for assistance.
4. Configure the system time using the following methods :
  - [Manually](#): Select your time zone and enter your local time.
  - [Get from PC](#): Click this button if you want to use the current managing PC's time.
  - [Get GMT](#): Click this button if you want to get time from the Internet. Make sure your modem router can access the Internet before you select this way to get system time.
5. Click [Save](#) to make your settings effective.
6. After setting the system time, you can set [Daylight Saving](#) time according to your needs. Tick the checkbox to enable [Daylight Saving](#), set the start and end time and then click [Save](#) to make the settings effective.

### Daylight Saving

---

Daylight Saving:  Enable Daylight Saving

Start: Mar ▼ M Last ▼ W Sun ▼ T 02:00 ▼

End: Oct ▼ M Last ▼ W Sun ▼ T 03:00 ▼

[Save](#)

## 13.2. Update the Firmware

TP-LINK is dedicated to improving and enriching the product features, giving you a better network experience. We will release the latest firmware at TP-LINK official website, you can download the latest firmware file from our website: [www.tp-link.com](http://www.tp-link.com) and upgrade the firmware to the latest version.

Follow the steps below to update your firmware to the latest.

1. Download the latest firmware file from our website: [www.tp-link.com](http://www.tp-link.com).
2. Visit <http://tplinkmodem.net>, and log in with the password you set for the modem router.
3. Go to [Advanced](#) > [System Tools](#) > [Firmware Upgrade](#) page.

### Firmware Upgrade

---

New Firmware File:  [Browse](#)

Firmware Version: 0.8.0 1.1 v0049.0 Build 150728 Rel.33681n

Hardware Version: Archer D20 v1 00000000

[Upgrade](#)

4. Click [Browse](#) to locate the downloaded new firmware file, and click [Upgrade](#).
5. Wait for the upgrading and then the modem router will automatically reboot.

**Note:**

1. Before upgrading the firmware, it's better to back up your current settings. For more details, refer to [Back up and Restore Configuration Settings](#).
2. During the upgrading process, do not turn off or reset the router.
3. The upgraded firmware version must correspond to the hardware.

## 13.3. Back up and Restore Configuration Settings

The configuration settings are stored as a configuration file in the router. You can back up the configuration file to your computer for future use and restore the modem router

to a previous settings from the backup file when needed. Moreover, if needed you can erase the current settings and reset the modem router to the default factory settings.

### To back up configuration settings:

1. Visit <http://tplinkmodem.net>, and log in with the password you set for the modem router.
2. Click [Advanced](#) > [System Tools](#) > [Backup & Restore](#) page.
3. Click [Backup](#) to save a copy of the current settings to your local computer. A conf. bin file will be stored to your computer.

### To restore configuration settings:

1. Visit <http://tplinkmodem.net>, and log in with the password you set for the modem router.
2. Click [Advanced](#) > [System Tools](#) > [Backup & Restore](#) page.

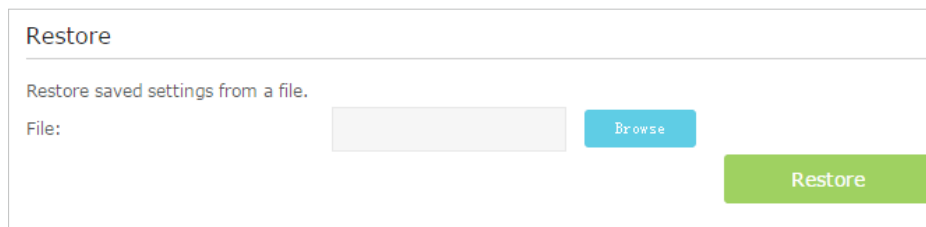

Restore

Restore saved settings from a file.

File:  [Browse](#) [Restore](#)

3. Click [Browse](#) to locate the previous backup configuration file, and click [Restore](#).
4. Wait for the restoring and then the modem router will automatically reboot.

### To reset the modem router to factory default settings:

1. Visit <http://tplinkmodem.net>, and log in with the password you set for the modem router.
2. Click [Advanced](#) > [System Tools](#) > [Backup & Restore](#) page.
3. Click [Factory Restore](#) to reset the modem router.
4. Wait for the resetting and then the modem router will automatically reboot.

#### ■ Note:

1. Do not interrupt or turn off the router during the resetting process.
2. We strongly recommend you back up the current configuration settings before resetting the modem router.

## 13.4. Change the Administrator Account

Admin account is used to log in to the modem router's web-based management page. You are required to set the admin account at first login. You can also change it on the web page.

1. Visit <http://tplinkmodem.net>, and log in with the password you set for the modem router.
2. Go to [Advanced](#) > [System Tools](#)> [Administration](#) page. Locate the [Account Management](#) section.

Account Management

Old Password:

New Password:

Low Middle High

Confirm New Password:

3. Enter the old password. Enter the new password and enter again to confirm.
4. Click [Save](#) to make the settings effective.

## 13.5. Local Management

You can control the local devices' authority to manage the modem router via Local Management feature. By default all local connected devices are allowed to manage the modem router. You can also allow only one device to manage the modem router.

Follow the steps below to specify the local management.

1. Visit <http://tplinkmodem.net>, and log in with the password you set for the modem router.
2. Go to [Advanced](#) > [System Tools](#) > [Administration](#) page. Locate the [Local Management](#) section.
3. Keep the Port as the default setting. Enter the [IP Address](#) or [MAC Address](#) of the local device to manage the modem router.

Local Management

Port:

IP/MAC Address:

4. Click [Save](#) to make the settings effective. Now only the device (192.168.1.100) can manage the modem router. If you want that all local devices can manage the modem router, just leave the [IP/MAC Address](#) field blank.



## 13.6. Remote Management

By default, the remote devices are not allowed to manage the modem router from the Internet.

Follow the steps below to allow remote devices to manage the modem router.

1. Visit <http://tplinkmodem.net>, and log in with the password you set for the modem router.
2. Go to [Advanced](#) > [System Tools](#) > [Administration](#) page. Locate the [Remote Management](#) section.

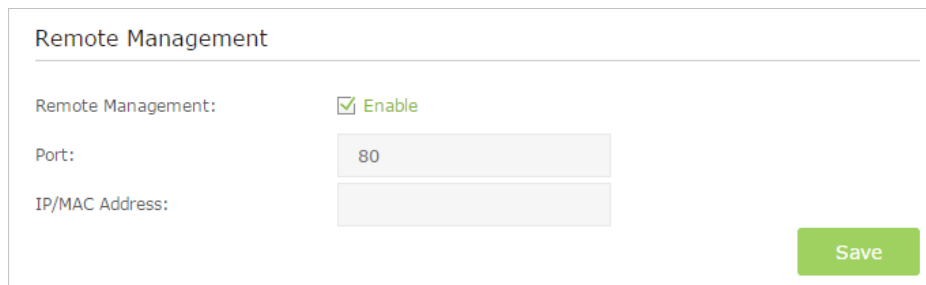

Remote Management

Remote Management:  Enable

Port:

IP/MAC Address:

Save

3. Tick the checkbox to enable [Remote Management](#). Keep the [Port](#) as the default setting. Leave the [IP/MAC Address](#) field blank. If you just want to allow a specific device to manage the modem router, you can enter the IP address of the remote device in the IP/MAC Address field.
4. Click [Save](#) to make the settings effective. Now, all devices on the Internet can log in to [http://modem router's WAN IP address:port number](#) (such as [http://113.116.60.229:80](#)) to manage the modem router.

### ◆ Tips:

1. You can find the WAN IP address of the router on [Basic](#) > [Network Maps](#) > [Internet](#).
2. The router's WAN IP is usually a dynamic IP. Please refer to [Set up a Dynamic DNS Service Account](#) if you want to log in to the router through a domain name.

## 13.7. System Log

System Log can help you know what happened to your modem router, facilitating you to locate the malfunctions. For example when your modem router does not work properly, you will need to save the system log and send it to the technical support for troubleshooting.

1. Visit <http://tplinkmodem.net>, and log in with the password you set for the modem router.
2. Click [Advanced](#) > [System Tools](#) > [System Log](#) page.

**System Log**

Type: ALL ▼

Level: Debug ▼

🔄 Refresh 🗑️ Delete All

ID	Time	Type	Level	Log Content
1	1970-01-01 00:46:15	IGMP	Warning	V2 igmp router ocured! Not matching ours V3.
2	1970-01-01 00:45:15	IGMP	Warning	V2 igmp router ocured! Not matching ours V3.
3	1970-01-01 00:44:10	IGMP	Warning	V2 igmp router ocured! Not matching ours V3.
4	1970-01-01 00:43:10	IGMP	Warning	V2 igmp router ocured! Not matching ours V3.
5	1970-01-01 00:42:41	DHCPD	Notice	Recv REQUEST from 48:43:7C:B0:B4:ED
6	1970-01-01 00:42:39	DHCPD	Notice	Send OFFER with ip 192.168.1.100
7	1970-01-01 00:42:39	DHCPD	Notice	Recv DISCOVER from 48:43:7C:B0:B4:ED
8	1970-01-01 00:42:05	IGMP	Warning	V2 igmp router ocured! Not matching ours V3.

⏪ 1 2 3 4 5 6 7 8 ⏩

Log Settings Save Log

### To view the system logs:

1. Select the log Type. Select [ALL](#) to view all kinds of logs, or select [DHCPD](#) or [IGMP](#) to view the specific logs.
2. Select the log Level and you will see the logs with the specific or higher levels.
3. Click [Refresh](#) to refresh the log list.

### To save the system logs:

You can choose to save the system logs to your local computer or a remote server.

Click [Save Log](#) to save the logs in a txt file to your computer.

Click [Log Settings](#) to set the save path of the logs.

Log Settings

Save Locally

Minimum Level: Information

Save Remotely

Minimum Level: Warning

Server IP: 192.168.1.100

Server Port: 514

Local Facility Name: User

Back Save

- **Save Locally:** Select this option to cache the system log to the router's local memory, select the minimum level of system log to be saved from the drop-down list. The logs will be shown in the table in descending order on the System Log page.
- **Save Remotely:** Select this option to send the system log to a remote server, select the minimum level of system log to be saved from the drop-down list and enter the information of the remote server. If the remote server has a log viewer client or a sniffer tool implemented, you can view and analyze the system log remotely in real-time.

## 13.8. Monitor the Internet Traffic Statistics

The Traffic Statistics page displays the network traffic of the LAN, WAN and WLAN sent and received packets, allowing you to monitor the volume of Internet traffic statistics.

1. Visit <http://tplinkmodem.net>, and log in with the password you set for the modem router.
2. Go to [Advanced](#) > [System Tools](#) > [Statistics](#).
3. Toggle on [Traffic Statistics](#), and then you can monitor the traffic statistics in [Traffic Statistics List](#) section. This function is disabled by default.



**Traffic Statistics**

---

Enable Traffic Statistics:

**Traffic Statistics List**

---

 Refresh
 Reset
 Delete All

IP Address MAC Address	Total Packets	Total Bytes	Current Packets	Current Bytes	Current ICMP Tx	Current UDP Tx	Current SYN Tx	Modify
--	--	--	--	--	--	--	--	--

## 13.9. CWMP Settings

The modem router offers CWMP feature. The function supports TR-069 protocol which collects information, diagnoses the devices and configures the devices automatically via ACS (Auto-Configuration Server).

1. Visit <http://tplinkmodem.net>, and log in with the password you set for the modem router.
2. Go to [Advanced](#) > [System Tools](#) > [CWMP Settings](#) page.

### CWMP Settings

WAN Management Protocol (also called TR-069) allows Auto-Configuration Server (ACS) to perform auto-configuration, provision, connection, and diagnostics to this device. You may configure this function under your ISP's instructions.

Enable CWMP:

Inform:

Inform Interval(seconds):

ACS URL:

ACS Username:

ACS Password:

Interface used by TR-069 client:

Display SOAP messages on serial console:

Connection Request Authentication

Connection Request Username:

Connection Request Password:

Connection Request Path:

Connection Request Port:

Connection Request URL:

[Get RPC Methods](#)

[Save](#)

- **Enable CWMP:** Toggle On to enable the CWMP (CPE WAN Management Protocol) feature.
- **Inform:** Enable this feature to send an Inform message to the ACS (Auto Configuration Server) periodically.
- **Inform Interval:** Enter the time interval in seconds when the Inform message will be sent to the ACS.
- **ACS URL:** Enter the web address of the ACS which is provided by your ISP.
- **ACS Username/Password:** Enter the username/password to log in to the ACS server.
- **Interface used by TR-069 client:** Select which interface to be used by the TR-069 client.
- **Display SOAP messages on serial console:** Toggle to enable or disable this feature.
- **Connection Request Authentication:** Select this checkbox to enable authentication for the connection request.
- **Connection Request Username/Password:** Enter the username/password for the ACS server to log in to the router.
- **Connection Request Path:** Enter the path for the ACS server to log in to the router.

- **Connection Request Port:** Enter the port that connects to the ACS server.
- **Connection Request URL:** Enter the URL that connects to the ACS server.
- **Get RPC methods:** Click to get the methods to support CWMP.

Click **Save** to make the settings effective.

## 13. 10. SNMP Settings

SNMP (Simple Network Management Protocol) has been widely applied in the computer networks currently, which is used for ensuring the transmission of the management information between two nodes. In this way, network administrators can easily search and modify the information on any node on the network. Meanwhile, they can locate faults promptly and implement the fault diagnosis, capacity planning and report generating.

An **SNMP Agent** is an application running on the modem router that performs the operational role of receiving and processing SNMP messages, sending responses to the SNMP manager, and sending traps when an event occurs. So a router contains SNMP “agent” software can be monitored and/or controlled by SNMP Manager using SNMP messages.

1. Visit <http://tplinkmodem.net>, and log in with the password you set for the modem router.
2. Go to **Advanced > System Tools > SNMP Settings** page.

SNMP Settings

Simple Network Management Protocol (SNMP) allows management applications to retrieve status updates and statistics from the SNMP agent within this device.

Enable SNMP Agent:

Read Community: public

Set Community: private

System Name: Archer D20

System Description: 0.8.0 1.1 v0049.0 Bu

System Location:

System Contact:

Trap Manager IP: 0.0.0.0

Save

- **Enable SNMP Agent:** Toggle On to enable the built-in SNMP agent that allows the router to operate as the operational role in receiving and processing of SNMP

messages, sending responses to the SNMP manager, and triggering SNMP traps when an event occurs.

- **Read-only Community:** Displays the default public community string that protects the router from unauthorized access.
- **Set Community:** Displays the default read and write community string that protects the router from unauthorized changes.
- **System Name:** Displays the administratively-assigned name for this managed device.
- **System Description:** Displays the textual description of the managed device. This value should include the full name and version identification of the system's hardware type, software operating-system, and networking software.
- **System Location:** Displays the physical location of this device (e.g., telephone closet, 3rd floor).
- **System Contact:** Displays the textual identification of the contact person for this managed device, together with information on how to contact this person.
- **Trap Manager IP:** Displays the IP address of the host to receive the traps.

You are suggested to keep the default settings. Click **Save** to make the settings effective.

# Appendix A: Specifications

General	
Standards and Protocols	ANSI T1.413, ITU G.992.1, ITU G.992.3, ITU G.992.5, IEEE 802.11a, IEEE 802.11b, IEEE 802.11g, IEEE 802.11n, IEEE 802.11ac, IEEE 802.3, IEEE 802.3u, TCP/IP, PPPoA, PPPoE, SNTP, HTTP, DHCP, ICMP, NAT
Safety & Emission	FCC, CE
Ports	Four 10/100M Auto-Negotiation RJ45 ports (Auto MDI/MDIX) One RJ11 port One USB 2.0 port
Network Medium	10Base-T: UTP category 3, 4, 5 cable 100Base-TX: UTP category-5, 5e cable 1000Base-TX: UTP category-5, 5e cable Max line length: 6.5Km
Data Rates	Downstream: Up to 24Mbps Upstream: Up to 1Mbps
Antennas	Two undetachable external dual band antennas, 2dBi for 2.4GHz and 3dBi for 5GHz
Physical and Environment	
Working Temperature	0 C ~ 40 C
Working Humidity	10% ~ 90% RH (non-condensing)
Storage Temperature	-40 C ~ 70 C
Storage Humidity	5% ~ 90% RH (non-condensing)



# Appendix B:

# Troubleshooting

## T1. How do I restore my modem router's configuration to its factory default settings?

With the modem router powered on, press and hold down the WPS/RESET button on the rear panel of the modem router for 8 seconds until all LEDs turn back on momentarily, then release the button.

■ **Note:** Once the modem router is reset, the current configuration settings will be lost and you will need to re-configure the modem router.

## T2. What can I do if I forgot my password?

### Web Management page password:

Restore the modem router to its factory default settings and then set a new password using 1-15 characters.

### Wireless Network password:

1. The default Wireless Password/PIN is printed on the product label of the modem router.
2. If the default wireless password has been changed, log into the modem router's web management page and go to [Basic](#) > [Wireless](#) to retrieve or reset your password.

## T3. What can I do if I cannot log into the modem router's web management page?

- Make sure the modem router connects to the computer correctly and the corresponding LED indicator(s) light up.
- Make sure the IP address of your computer is configured to obtain an IP address automatically and obtain DNS server address automatically.
- Make sure the default access you input is right.
- Check your computer's settings:
  - 1) Go to [Start](#) > [Control Panel](#) > [Network and Internet](#), and click [View network status and tasks](#);
  - 2) Click [Internet Options](#) on the bottom left;
  - 3) Click [Connections](#), select [Never dial a connection](#);

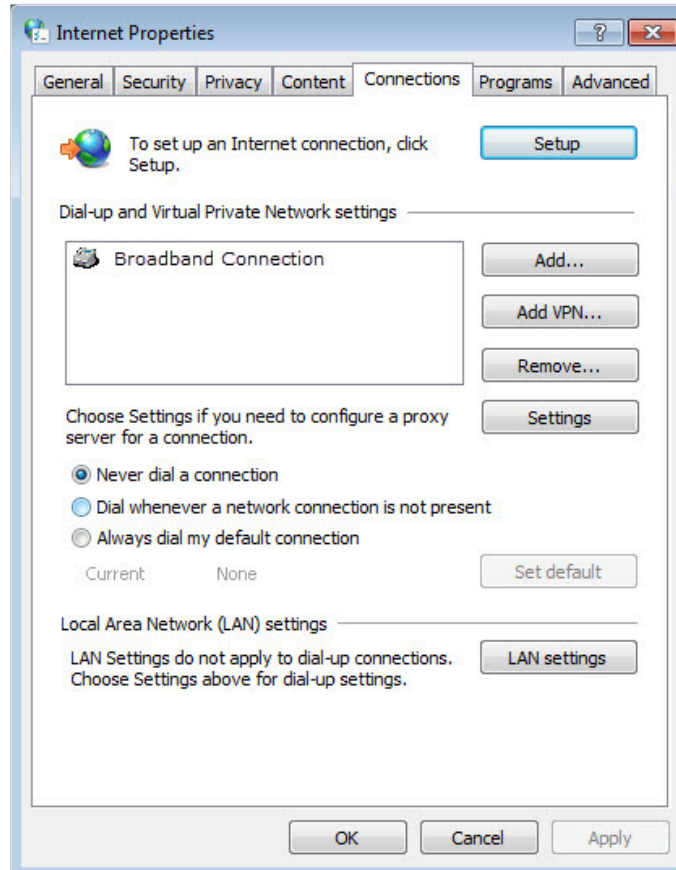

4) Click [LAN settings](#), deselect the following three options and click [OK](#);

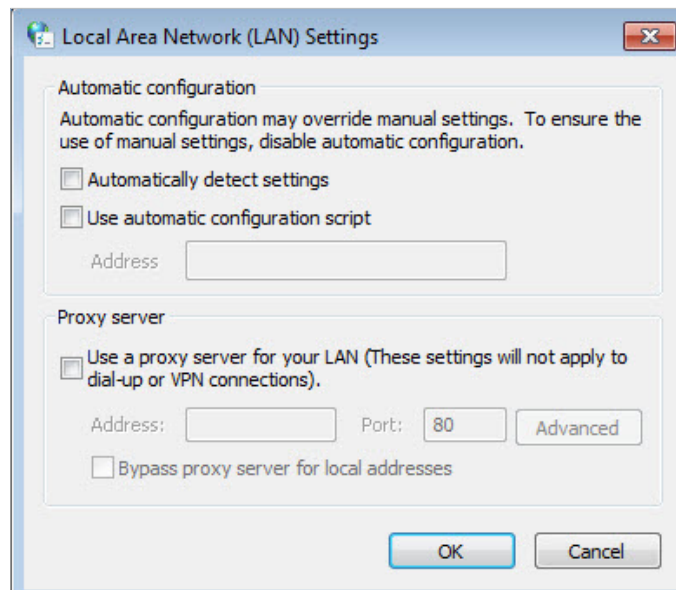

5) Go to [Advanced](#) > [Restore advanced settings](#), click [OK](#) to save the settings.

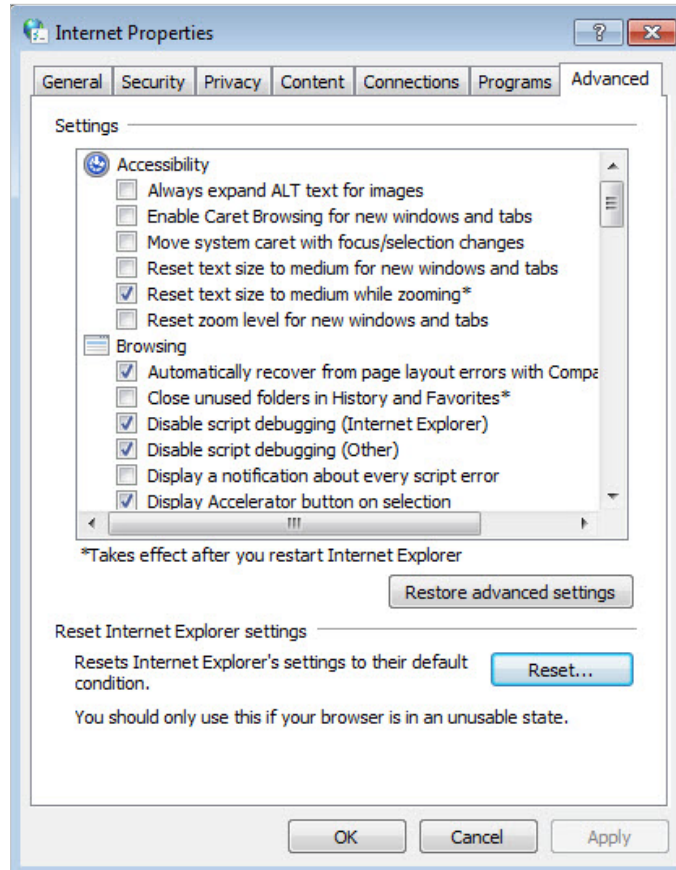

- Change a web browser or computer and log in again.
- Reset the modem router to factory default settings: With the modem router powered on, press and hold down the WPS/RESET button on the rear panel of the modem router for 8 seconds until all LEDs turn back on momentarily, then release the button.

■ Note: You'll need to reconfigure the modem router to surf the Internet once the modem router is reset.

Open a web browser and log in again. If login fails, please contact the technical support.

#### T4. What can I do if I cannot access the Internet?

1. Check to see if all the connectors are connected well, including the telephone line, Ethernet cables and power adapter.
2. Check to see if you can log in to the web management page of the modem router. If you can, try the following steps. If you cannot, please set your computer referring to T3 and then try to see if you can access the Internet. If the problem persists, please go to the next step.
3. Consult your ISP and make sure all the VPI/VCI, Connection Type, account username and password are correct. If there are any mistakes, please correct the settings and try again.

4. Refer to T5 to clone the MAC address.
5. If you still cannot access the Internet, please restore your modem router to its factory default settings and reconfigure your modem router by following the instructions in [Use Quick Setup Wizard](#).
6. Please contact our Technical Support if the problem still exists.

## T5. How to configure MAC Clone?

You can manually change the MAC address of the modem router. It is helpful when your Internet access account provided by your ISP is bound to one specific MAC address, in other words, your ISP just permits only one computer with the authenticated MAC address to access the Internet. In this case, you can use MAC Clone to allow more computers to access the Internet via the same account.

1. Visit <http://tplinkmodem.net>, and log in with password you set for the modem router.
2. Go to [Advanced](#) > [Network](#) > [Internet](#) page. Click the [Add](#) icon, and scroll down to get the [MAC Clone](#) section.

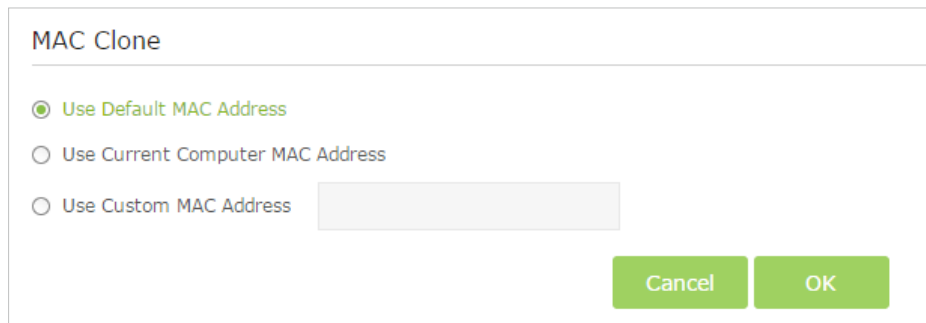

The screenshot shows a dialog box titled "MAC Clone". It has three radio button options: "Use Default MAC Address" (which is selected), "Use Current Computer MAC Address", and "Use Custom MAC Address" (which has a text input field next to it). At the bottom right of the dialog, there are two buttons: "Cancel" and "OK".

- If you are using the computer with the authenticated MAC address to access the modem router, please select [Use Current Computer MAC Address](#).
  - If you know the authenticated MAC address, please select [Use Custom MAC Address](#) and then enter the address.
3. Click [OK](#) to make the settings effective.

## T6. How to use the modem router as a regular wireless router to share my Internet ?

The modem router supports two operation modes, DSL Modem Router Mode and Wireless Router mode. If you already have a modem or your Internet comes via an Ethernet cable from the wall, you can set up the modem router as a regular wireless router to share the Internet.

1. Connect your modem router's LAN4/WAN port to the modem or the network port.

2. Visit <http://tplinkmodem.net>, and log in with password you set for the modem router.
3. Go to [Advanced](#) > [Operation Mode](#) page.

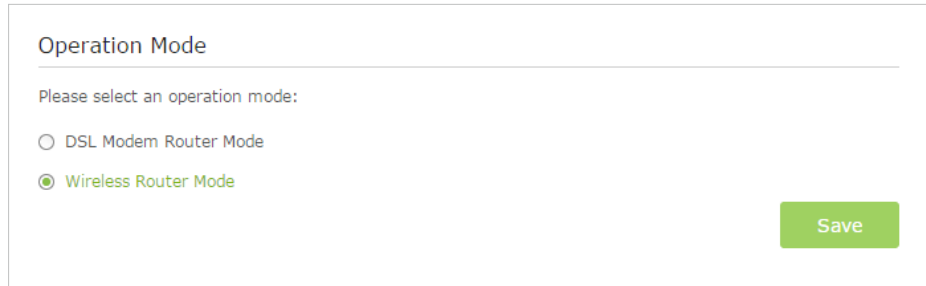

4. Select the [Wireless Router Mode](#) option and click [Save](#) to make the settings effective.

■ Note: IPTV function is not supported in [Wireless Router Mode](#).

## T7. How to use the WDS Bridging function to extend my wireless network?

My house covers a large area. The wireless network coverage of the router I'm using (the root router) is limited. I want to use an extended router to extend the wireless network of the primary router. Follow the steps to configure the modem router.

1. Visit <http://tplinkmodem.net>, and log in with password you set for the modem router.
2. Configure the [LAN IP address](#) of the modem router in the same subnet as the root router. For example, the IP address of the root router is 192.168.1.1, the IP address of the extended router should be from 192.168.1.2 to 192.168.1.254.).
3. Go to [Advanced](#) > [Wireless](#) > [Advanced Settings](#) page and select the wireless network 5GHz. Locate the [WDS \(5GHz\)](#) section and select the checkbox to enable the [WDS Bridging](#) function.

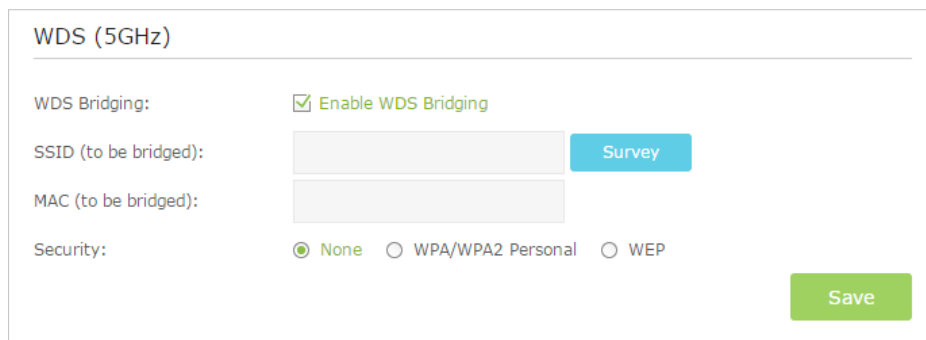

4. Click [Survey](#) to scan all the AP devices and choose the root AP to be bridged.

AP List

Refresh

ID	MAC Address	SSID	Signal strength	Channel	Encryption	Connect
1	E0:05:C5:30:01:46	TP-LINK_0146_5G	14	36	Encrypted	
2	30:B5:C2:33:97:81	TP-LINK_5GHz_0000	6	36	Encrypted	
3	28:04:29:57:10:48	TP-LINK_Extender_5GHz	9	36	None	
4	00:0A:EB:13:7B:02	TP-LINK_Extender_5GHz	13	36	None	

[Back](#)

- Click the connect icon and then the SSID and MAC will be automatically filled in. Configure the Security settings as the AP you choose to be bridged.

WDS (5GHz)

WDS Bridging:  Enable WDS Bridging

SSID (to be bridged):  [Survey](#)

MAC (to be bridged):

Security:  None  WPA/WPA2 Personal  WEP

Version:  WPA-PSK  WPA2-PSK

Encryption:  TKIP  AES

Password:

[Save](#)

- Click [Save](#) to make the settings effective.
- Go to [Advanced](#) > [Network](#) > [LAN Settings](#) page to disable DHCP.

Now, the root's wireless network is extended and you can use the modem router's SSID and password to enjoy the network.

**Note:** The extended router (modem router) can have different SSID and password from the root router, you can change your modem router's SSID and password on [Basic](#) > [Wireless](#) page.

## T8. What can I do if I cannot find my wireless network or I cannot connect the wireless network?

- **If you fail to find any wireless network, please follow the steps below:**
  1. Make sure the wireless function is enabled if you're using a laptop with built-in wireless adapter. You can refer to the relevant document or contact the laptop manufacturer.

2. Make sure the wireless adapter driver is installed successfully and the wireless adapter is enabled.

### On Windows 7

- 1) If you see the message **No connections are available**, it is usually because the wireless function is disabled or blocked somehow;

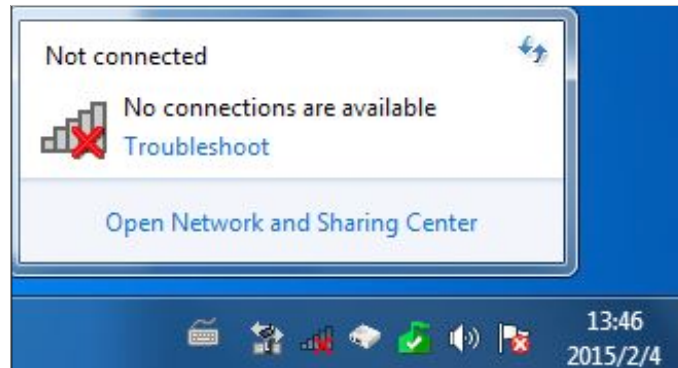

- 2) Clicking on **Troubleshoot** and windows might be able to fix the problem by itself.

### On Windows XP

- 1) If you see the message **Windows cannot configure this wireless connection**, this is usually because windows configuration utility is disabled or you are running another wireless configuration tool to connect the wireless.

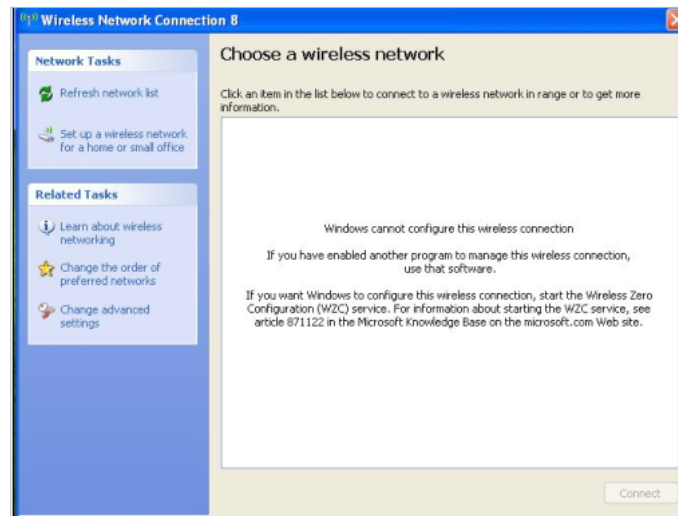

- 2) Exit the wireless configuration tool( the TP-LINK Utility, for example);
- 3) Select and right click on **My Computer** on desktop, select **Manage** to open Computer Management window;
- 4) Expand **Services and Applications > Services**, find and locate **Wireless Zero Configuration** in the Services list on the right side;

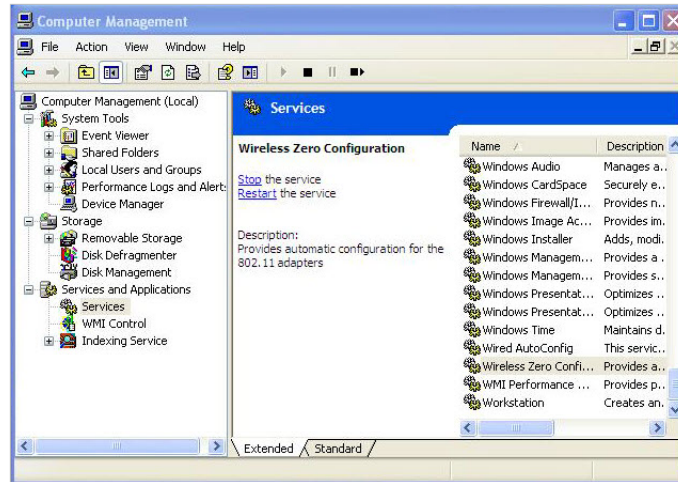

5) Select **Wireless Zero Configuration**, right click, and then select **Properties**;

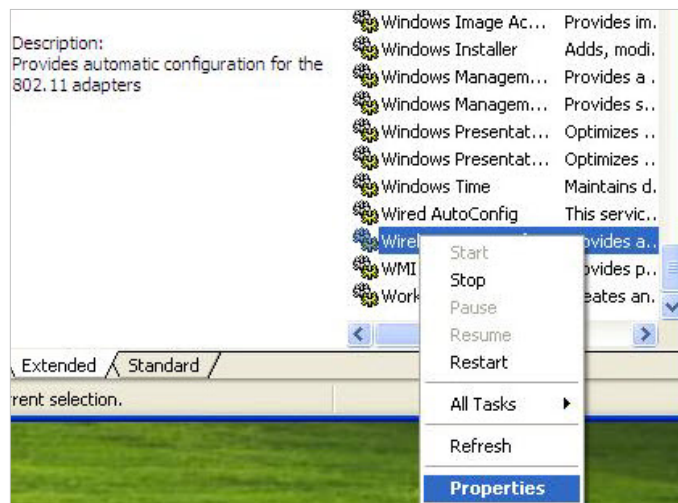

6) Change **Startup type** to **Automatic**, click on Start button and make sure the Service status is Started. And then click **OK**.



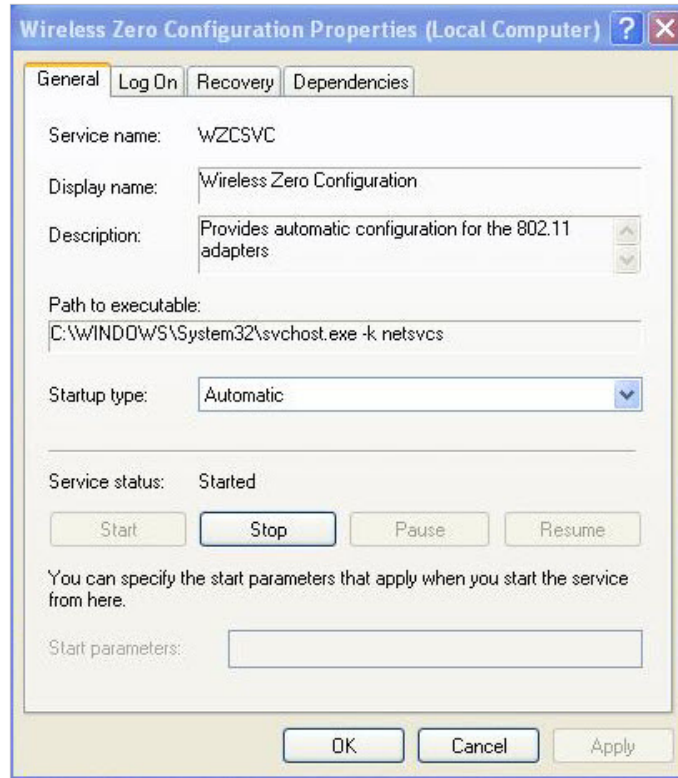

7) Connect to wireless network.

➤ **If you can find other wireless network except your own, please follow the steps below:**

1. Check the WLAN LED indicator on your wireless router/modem;
2. Make sure your computer/device is still in the range of your router/modem, move closer if it is currently too far away;
3. Go to [Advanced](#) > [Wireless](#) > [Wireless Settings](#) page, and check the wireless router settings. Double check your Wireless Name, and make sure the SSID is not hidden;
4. Connect to wireless network.

➤ **If you can find your wireless network but fail to connect, please follow the steps below:**

1. Authenticating problem, password mismatch.
  - 1) Sometimes it will ask you to type in a PIN number when you connect to the wireless network for the first time. This PIN number is different from the Wireless Password/Network Security Key, usually you can only find it on the back of your wireless router/modem;



- 2) If you cannot find the PIN or PIN failed, you may choose “[Connecting using a security key instead](#)”, and then type in the Network Security Key/Wireless Password;



- 3) If it continues on saying network security key mismatch, it is suggested to confirm the wireless password on your wireless router/modem;

■ Note: Wireless password/Network Security Key is case sensitive.



- 4) Connect to wireless network.
2. Windows was unable to connect to XXXX /Cannot join this network/Taking longer than usual to connect to this network.

- 1) Check the wireless signal strength of your network, if it is weak (1~3 bars), please move the router closer and try again;
- 2) Change the wireless Channel of the router to 1,6,or 11 to reduce interference from other networks;
- 3) Re-install or update the driver for your wireless adapter of the computer;
- 4) Connect to wireless network.

### **T9. What can I do if I cannot access the USB disk after I modify the Authentication settings?**

This situation probably happens on your Windows computer due to its special credential mechanism. Once you successfully access the USB disk, the connection will be temporarily recorded and you will be refused to access the USB disk with another account.

You can follow either method below to solve this problem:

- **Method 1:** Log off (sign out) from the Windows to delete the temporary connection record.
- **Method 2: (Only for Local Storage Sharing)** Change the Address of the USB Disk by referring to [To Customize the Address of the USB Disk](#).

### **T10. What can I do if I am still required to enter the password for USB access even though I have selected [Remember my credentials](#) in my Windows computer?**

Because of Windows special credential mechanism, if the USB access username you set is the same as the Windows account name, Windows will be unable to remember the password you set for the USB.

To solve this problem, you can set a different USB access username or make the USB access password the same as your Windows account. After you modify the access account, remember to log off (sign out) from the Windows.

### **T11. Why am I never required to enter the account information for USB access even though I have enabled the Authentication feature?**

This situation probably happens on your Windows computer due to its special credential mechanism. If your USB access username and password are both the same as your Windows account, the Windows will automatically use its account information to access the USB disk. Therefore, you will have no need to enter the username and password.

## **COPYRIGHT & TRADEMARKS**

Specifications are subject to change without notice. **TP-LINK** is a registered trademark of TP-LINK TECHNOLOGIES CO., LTD. Other brands and product names are trademarks or registered trademarks of their respective holders.

No part of the specifications may be reproduced in any form or by any means or used to make any derivative such as translation, transformation, or adaptation without permission from TP-LINK TECHNOLOGIES CO., LTD. Copyright © 2015 TP-LINK TECHNOLOGIES CO., LTD. All rights reserved.

## FCC STATEMENT



This equipment has been tested and found to comply with the limits for a Class B digital device, pursuant to part 15 of the FCC Rules. These limits are designed to provide reasonable protection against harmful interference in a residential installation. This equipment generates, uses and can radiate radio frequency energy and, if not installed and used in accordance with the instructions, may cause harmful interference to radio communications. However, there is no guarantee that interference will not occur in a particular installation. If this equipment does cause harmful interference to radio or television reception, which can be determined by turning the equipment off and on, the user is encouraged to try to correct the interference by one or more of the following measures:

- Reorient or relocate the receiving antenna.
- Increase the separation between the equipment and receiver.
- Connect the equipment into an outlet on a circuit different from that to which the receiver is connected.
- Consult the dealer or an experienced radio/TV technician for help.

This device complies with part 15 of the FCC Rules. Operation is subject to the following two conditions:

- 1) This device may not cause harmful interference.
- 2) This device must accept any interference received, including interference that may cause undesired operation.

Any changes or modifications not expressly approved by the party responsible for compliance could void the user's authority to operate the equipment.

Note: The manufacturer is not responsible for any radio or TV interference caused by unauthorized modifications to this equipment. Such modifications could void the user's authority to operate the equipment.

### **FCC RF Radiation Exposure Statement**

This equipment complies with FCC RF radiation exposure limits set forth for an uncontrolled environment. This device and its antenna must not be co-located or operating in conjunction with any other antenna or transmitter.

"To comply with FCC RF exposure compliance requirements, this grant is applicable to only Mobile Configurations. The antennas used for this transmitter must be installed to provide a separation distance of at least 20 cm from all persons and must not be co-located or operating in conjunction with any other antenna or transmitter."

The device operates in 5.15 ~ 5.25GHz / 5.745 ~ 5.85 GHz frequency range. It is restricted in indoor environment only. This device meets all the other requirements specified in Part 15E, Section 15.407 of the FCC Rules.

## RF Exposure Information

This device meets the EU requirements (1999/519/EC) on the limitation of exposure of the general public to electromagnetic fields by way of health protection.

The device complies with RF specifications when the device used at 20 cm form your body.

## CE Mark Warning



This is a class B product. In a domestic environment, this product may cause radio interference, in which case the user may be required to take adequate measures.

## National Restrictions

This device is intended for home and office use in all EU countries (and other countries following the EU directive 1999/5/EC) without any limitation except for the countries mentioned below:

Country	Restriction	Reason/remark
Belarus	Not implemented	
Norway	Implemented	This subsection does not apply for the geographical area within a radius of 20 km from the centre of Ny-Ålesund on Svalbard
Italy	Implemented	The public use is subject to general authorisation by the respective service provider
Russian Federation	Limited implementation	<p><b>1. SRD with FHSS modulation</b></p> <p>1.1. Maximum 2.5 mW e.i.r.p.</p> <p>1.2. Maximum 100 mW e.i.r.p. Permitted for use SRD for outdoor applications without restriction on installation height only for purposes of gathering telemetry information for automated monitoring and resources accounting systems. Permitted to use SRD for other purposes for outdoor applications only when the installation height is not exceeding 10 m above the ground surface.</p> <p>1.3. Maximum 100 mW e.i.r.p. Indoor applications</p> <p><b>2. SRD with DSSS and other than FHSS wideband modulation</b></p> <p>2.1. Maximum mean e.i.r.p. density is 2 mW/MHz. Maximum 100 mW e.i.r.p.</p> <p>2.2. Maximum mean e.i.r.p. density is 20 mW/MHz. Maximum 100 mW e.i.r.p. It is permitted to use SRD for outdoor applications only for purposes of gathering telemetry information for automated monitoring and resources accounting systems or security systems.</p> <p>2.3. Maximum mean e.i.r.p. density is 10 mW/MHz. Maximum 100 mW e.i.r.p. Indoor applications</p>

Country	Restriction	Reason/remark
Ukraine	Limited implementation	e.i.r.p. $\leq 100$ mW with built-in antenna with amplification factor up to 6 dBi

ATTENTION: Due to EU law, the country settings must be identical to the country where the device is operating (important due to non-harmonised frequencies in the EU).

Restricted to indoor use.

### Canadian Compliance Statement

This device complies with Industry Canada license-exempt RSSs. Operation is subject to the following two conditions:

- (1) This device may not cause interference, and
- (2) This device must accept any interference, including interference that may cause undesired operation of the device.

Le présent appareil est conforme aux CNR d'Industrie Canada applicables aux appareils radio exempts de licence. L'exploitation est autorisée aux deux conditions suivantes :

- (1) l'appareil ne doit pas produire de brouillage;
- (2) l'utilisateur de l'appareil doit accepter tout brouillage radioélectrique subi, même si le brouillage est susceptible d'en compromettre le fonctionnement.

### Caution:

the device for operation in the band 5150–5250 MHz is only for indoor use to reduce the potential for harmful interference to co-channel mobile satellite systems; and

The high-power radars are allocated as primary users (i.e. priority users) of the bands 5250-5350 MHz and 5650-5850 MHz and that these radars could cause interference and/or damage to LE-LAN devices.

### Avertissement:

Le dispositif fonctionnant dans la bande 5150-5250 MHz est réservé uniquement pour une utilisation à l'intérieur afin de réduire les risques de brouillage préjudiciable aux systèmes de satellites mobiles utilisant les mêmes canaux;

En outre, les utilisateurs devraient aussi être avisés que les utilisateurs de radars de haute puissance sont désignés utilisateurs principaux (c.-à-d., qu'ils ont la priorité) pour les bandes 5250-5350 MHz et 5650-5850 MHz et que ces radars pourraient causer du brouillage et/ou des dommages aux dispositifs LAN-EL.

### Radiation Exposure Statement:

This equipment complies with IC radiation exposure limits set forth for an uncontrolled environment. This equipment should be installed and operated with minimum distance 20cm between the radiator & your body.

## Déclaration d'exposition aux radiations:

Cet équipement est conforme aux limites d'exposition aux rayonnements IC établies pour un environnement non contrôlé. Cet équipement doit être installé et utilisé avec un minimum de 20 cm de distance entre la source de rayonnement et votre corps.

## Industry Canada Statement

CAN ICES-3 (B)/NMB-3(B)

## Korea Warning Statements:

당해 무선설비는 운용중 전파혼신 가능성이 있음.

## NCC Notice & BSMI Notice:

注意！

依據 低功率電波輻射性電機管理辦法

第十二條 經型式認證合格之低功率射頻電機，非經許可，公司、商號或使用者均不得擅自變更頻率、加大功率或變更原設計之特性或功能。

第十四條 低功率射頻電機之使用不得影響飛航安全及干擾合法通行；經發現有干擾現象時，應立即停用，並改善至無干擾時方得繼續使用。前項合法通信，指依電信規定作業之無線電信。低功率射頻電機需忍受合法通信或工業、科學以及醫療用電波輻射性電機設備之干擾。

減少電磁波影響，請妥適使用。

安全諮詢及注意事項

- 請使用原裝電源供應器或只能按照本產品注明的電源類型使用本產品。
- 清潔本產品之前請先拔掉電源線。請勿使用液體、噴霧清潔劑或濕布進行清潔。
- 注意防潮，請勿將水或其他液體潑灑到本產品上。
- 插槽與開口供通風使用，以確保本產品的操作可靠並防止過熱，請勿堵塞或覆蓋開口。
- 請勿將本產品置放於靠近熱源的地方。除非有正常的通風，否則不可放在密閉位置中。
- 請不要私自打開機殼，不要嘗試自行維修本產品，請由授權的專業人士進行此項工作。



Продукт сертифіковано згідно с правилами системи УкрСЕПРО на відповідність вимогам нормативних документів та вимогам, що передбачені чинними законодавчими актами України.





## Safety Information

- When product has power button, the power button is one of the way to shut off the product; when there is no power button, the only way to completely shut off power is to disconnect the product or the power adapter from the power source.
- Don't disassemble the product, or make repairs yourself. You run the risk of electric shock and voiding the limited warranty. If you need service, please contact us.
- Avoid water and wet locations.
- Adapter shall be installed near the equipment and shall be easily accessible.
- The plug considered as disconnect device of adapter.



Use only power supplies which are provided by manufacturer and in the original packing of this product.

This product can be used in the following countries:

AT	BG	BY	CA	CZ	DE	DK	EE
ES	FI	FR	GB	GR	HU	IE	IT
LT	LV	MT	NL	NO	PL	PT	RO
RU	SE	SG	SK	TR	UA	US	

**DECLARATION OF CONFORMITY**

For the following equipment:

Product Description: AC750 Wireless Dual Band ADSL2+ Modem Router

Model No.: **Archer D20**

Trademark: **TP-LINK**

We declare under our own responsibility that the above products satisfy all the technical regulations applicable to the product within the scope of Council Directives:

Directives 1999/5/EC, Directives 2004/108/EC, Directives 2006/95/EC, Directives 1999/519/EC, Directives 2011/65/EU

The above product is in conformity with the following standards or other normative documents

**EN 300 328 V1.8.1**

**EN 301 489-1 V1.9.2 & EN 301 489-17 V2.2.1**

**EN 55022: 2010 + AC: 2011**

**EN 55024: 2010**

**EN 60950-1: 2006 + A11: 2009 + A1: 2010 + A12: 2011 + A2: 2013**

**EN 50385: 2002**

**EN 301 893 V1.7.1**

**EN 50581: 2012**

*The product carries the CE Mark:*

**CE 1588** 

Person responsible for making this declaration:

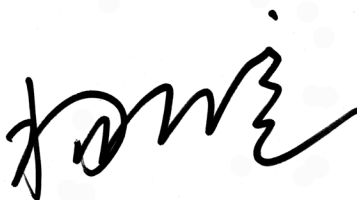

Yang Hongliang  
Product Manager of International Business

Date of issue: 2015/11/06