

TP-LINK®

RE580D

User Guide

AC1900 Wi-Fi Range Extender

Contents

About This Guide	1
Chapter 1. Get to Know About Your Extender	2
1. 1. Product Overview	3
1. 2. Appearance	3
1. 2. 1.LED Explanation.....	4
1. 2. 2.Port and Button Description.....	4
1. 3. Position the Extender.....	5
Chapter 2. Set Up Internet Connection	6
2. 1. Quick Setup.....	7
2. 1. 1.Method One: Via the WPS button	7
2. 1. 2.Method Two: Via a web browser.....	8
2. 2. Position Your Extender.....	11
Chapter 3. Customize Your Network.....	13
3. 1. Check Internet Status.....	14
3. 2. Configure Wireless Network	14
3. 3. Change LAN Settings.....	16
3. 4. Specify DHCP Server Settings.....	17
3. 5. Set Access Control.....	18
Chapter 4. Use Your Extender as a Wireless Adapter.....	21
Chapter 5. Manage Your Extender	23
5. 1. Select Time Zone	24
5. 2. Control LEDs	24
5. 3. Upgrade the Firmware.....	25
5. 4. Backup and Restore Configuration Settings	25
5. 5. Change Admin Account	26
5. 6. System Log	27
FAQ.....	28





About This Guide

This guide is a complementation of Quick Installation Guide. The Quick Installation Guide instructs you on quick Internet setup, and this guide provides details of each function and shows you the way to configure these functions appropriate to your needs.

When using this guide, please notice that features of the extender may vary slightly depending on the model and software version you have, and on your location, language, and Internet service provider. All screenshots, images, parameters and descriptions documented in this guide are used for demonstration only.

Conventions

In this guide the following conventions are used:

Convention	Description
<i>Blue Italic</i>	Hyperlinks are in blue italic. You can click to redirect to a website or a specific section.
Blue	Contents to be emphasized and texts on the web page are in blue, including the menus, items, buttons, etc.
>	The menu structures to show the path to load the corresponding page. For example, Advanced > Wireless > MAC Filtering means the MAC Filtering function page is under the Wireless menu that is located in the Advanced tab.
 Note:	Ignoring this type of note might result in a malfunction or damage to the device.
 Tips:	Indicates important information that helps you make better use of your device.
symbols on the web page	<ul style="list-style-type: none"> click to edit the corresponding entry. click to delete the corresponding entry. click to view more information about items on the page.

More Info

The latest software, management app and utility can be found at [Download Center](#) at www.tp-link.com/support.

The Quick Installation Guide can be found where you find this guide or inside the package of the router.

Specifications can be found on the product page at <http://www.tp-link.com>.

A Technical Support Forum is provided for you to discuss our products at <http://forum.tp-link.com>.

Our Technical Support contact information can be found at Contact Technical Support page at www.tp-link.com/support.

Chapter 1

Get to Know About Your Extender

This chapter introduces what the extender can do and its appearance.

This chapter contains the following sections:

- *Product Overview*
- *Appearance*
- *Position the Extender*

1.1. Product Overview

Bring Dead Zones Back to Life

Tired of Wi-Fi “dead zones”? The TP-LINK extender is connected to your router wirelessly, strengthening and expanding its signal into areas it can’t reach on its own. The device also reduces signal interference to ensure reliable Wi-Fi coverage throughout your home or office.

Easy Installation & Quick Position

The extender works with any standard wireless router. Instantly connect the extender to a router by pressing the router’s WPS button (if available) followed by the extender’s RE/WPS button, or by following the step-by-step Quick Setup instructions of the extender’s web management page.

Once the extender is connected to an existing router, you can take it to an ideal place, no more further configurations. The Intelligent signal light can help to find the best location.

Easy Management with the Tether APP





TP-LINK Tether provides a simple, intuitive way to access and manage your extender with your smart devices.

1.2. Appearance



1.2.1. LED Explanation

You can check the extender's working status by following the LED Explanation table.

Name	Status	Indication
 (RE)	Solid Blue	The extender is connected to the router, and is in a good location.
	Solid Orange	The extender is connected to the router, but is too far away from the router.
	Blinking	The extender is connecting to the network via WPS. This process may take up to 2 minutes.
	Off	No active connection.
 (2.4GHz)	On	The extender is connected to the 2.4GHz wireless network of your host router.
	Off	No 2.4GHz wireless connection.
 (5GHz)	On	The extender is connected to the 5GHz wireless network of your host router.
	Off	No 5GHz wireless connection.
 (POWER)	On	The extender is on.
	Blinking	The extender is initializing.
	Off	The extender is off.
 (Ethernet)	On	The Ethernet port is connected.
	Off	The Ethernet port is not connected.

1.2.2. Port and Button Description

Ports or Buttons	Description
Reset Button (Hole)	Press and hold the Reset button until all the LEDs turn on momentarily to reset the extender to its factory default settings.
RE Button	Press the WPS button on your host router, and immediately press the RE button on the extender. The RE LED of the extender should change from blinking to solid on, indicating successful WPS connection.
LED Button	To turn all LEDs on or off, press the LED button.
On/Off Button	To turn on or off the extender, press the Power button.
Ethernet Ports	Connect your Ethernet-only device to one of the Ethernet ports to join the Wi-Fi network.

1.3. Position the Extender

- To position the extender horizontally

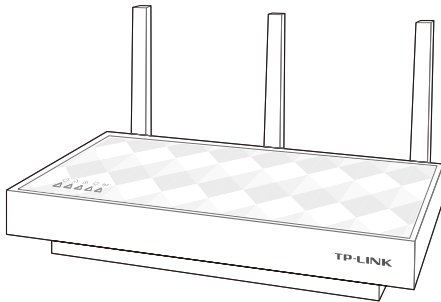

- To position the extender vertically

Find the provided base support, insert its clips into the slots marked with ▲, and then push it leftwards.

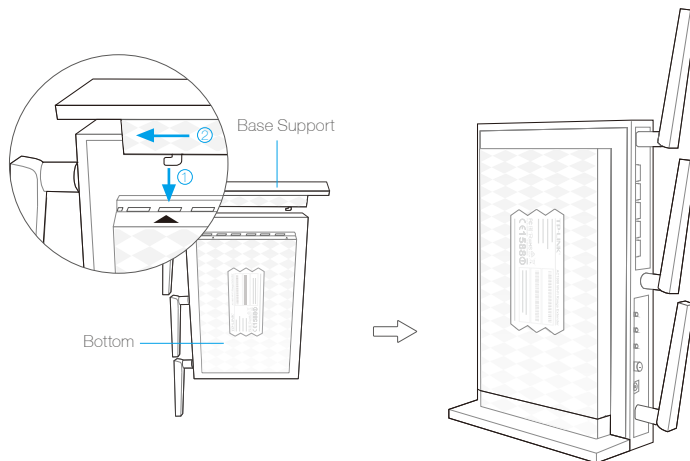

Chapter 2

Set Up Internet Connection

This chapter introduces how to boost your host wireless coverage. Please follow the step-by-step instructions to set up the Internet connection.

This chapter contains the following sections:



- *Quick Setup*
- *Position Your Extender*

2.1. Quick Setup

Power on

Plug the extender into an electrical outlet [near your host router](#), and then wait until the Power LED  changes to solid blue.

Connect to the host network



There are two ways to connect to the host network: via the WPS button or via a web browser. Using the WPS button is an easier way to extend your host network. We recommend you to use this way if your router has a WPS button. The button might look like one of these:  |  | .

2.1.1. Method One: Via the WPS button

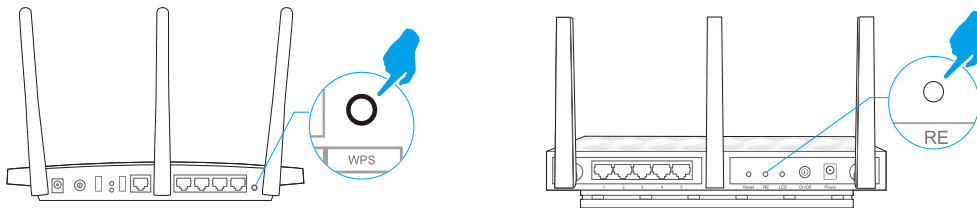
1. Press the WPS button on your host router, and then press the RE button on the extender within 2 minutes.



 **Tips:**

- Some ISP gateways disable the WPS function by default. If the WPS connection fails, please refer to [Method Two: Via a web browser](#).
 - For more information about using WPS button on your host router, please refer to the router manufacturer's user guide.
2. Wait until the  (RE) LED changes from blinking to a solid status, which indicates that the WPS connection is successful. If not, please refer to [Method Two: Via a web browser](#).
 3. If you are connecting the extender to a dual-band router but only  (2.4GHz) or  (5GHz) LED is on, repeat Step 1 and 2 to connect to the other band.
 4. **Enjoy!** Connect to the extended network and enjoy the Internet. Both extended networks share the same SSIDs (network names) and passwords as those of your host networks.

 **Tips:**

Since the performance of the extended networks will be affected by the distance between extender and host router, we highly recommend you to relocate your extender referring to [Position Your Extender](#).

2.1.2. Method Two: Via a web browser

1. Connect your computer to the extender's wireless network.

Tips:

Before connecting, please find the SSID (network name) on the label of the extender.

- For Windows Users

- 1) Unplug the Ethernet cable from your computer (if any).
- 2) Click the Wireless Network Connection icon on the taskbar.



- 3) Click the refresh icon  and connect to the extender's wireless network: [TP-LINK_Extender_2.4GHz](#) or [TP-LINK_Extender_5GHz](#).

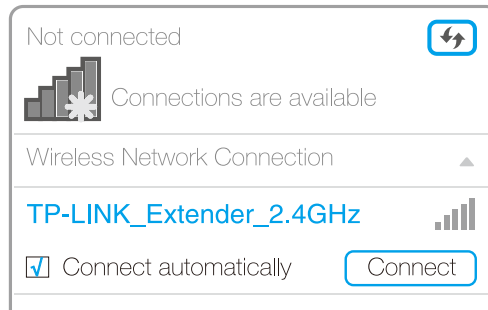

- For Mac OS X Users

- 1) Unplug the Ethernet cable from your computer (if any).
- 2) Click the Wi-Fi icon in the top right corner of the screen, and connect to the extender's network: [TP-LINK_Extender_2.4GHz](#) or [TP-LINK_Extender_5GHz](#).

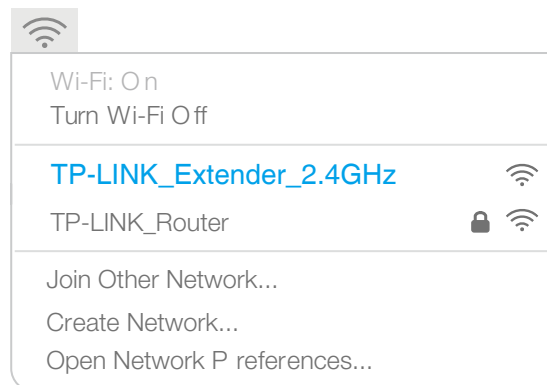

2. Follow the instructions of Quick Setup Wizard to connect the extender to your host router.

- 1) Launch a web browser and type <http://tplinkrepeater.net> in the address field. Use **admin** (all lowercase) for both username and password to log in.

Tips:

If the login window does not pop up, please refer to the [FAQ](#).

- 2) Create a new username and password for secure management purpose, and then click **Confirm**.

- 3) Select your host router's 2.4GHz SSID (network name), enter the password (NOT the password you just created for management), and click **Next**.

ID	SSID	Signal	MAC Address	Security
6	TP-LINK_A687	Signal strength indicator	E8-94-F6-79-A6-87	Lock icon

- 4) Select your host router's 5GHz SSID (network name), enter the password (NOT the password you just created for management), and click [Next](#).

2.4GHz Host Network | Wireless Settings | 5GHz Host Network | Summary

Please select 5GHz host network or skip this network.

ID	SSID	Signal	MAC Address	Security
<input type="radio"/> 2	TP-LINK_000C_5G		E0-05-C5-06-00-0E	
<input checked="" type="radio"/> 3	TP-LINK_A687_5G		E8-94-F6-79-A6-89	

Host 5GHz Password:

[Next](#)

[Exit](#) [Other...](#) [Rescan](#) [Skip](#)

Tips:

If your host router does not support 5GHz wireless network, please click [Skip](#) to continue.

- 5) Either keep the default SSIDs (network names) or customize them for the extended networks, and then click [Next](#).

2.4GHz Host Network | Wireless Settings | 5GHz Host Network | Summary

Extended 2.4GHz SSID: [Copy Host SSID](#)

Hide SSID broadcast

Note: The extended 2.4GHz password is the same as your Host password.

Extended 5GHz SSID: [Copy Host SSID](#)

Hide SSID broadcast

Note: The extended 5GHz password is the same as your Host password.

[Back](#) [Next](#)

- 6) Verify your wireless settings and click [Finish](#). The corresponding LED(s) (2.4GHz or 5GHz) should turn on.

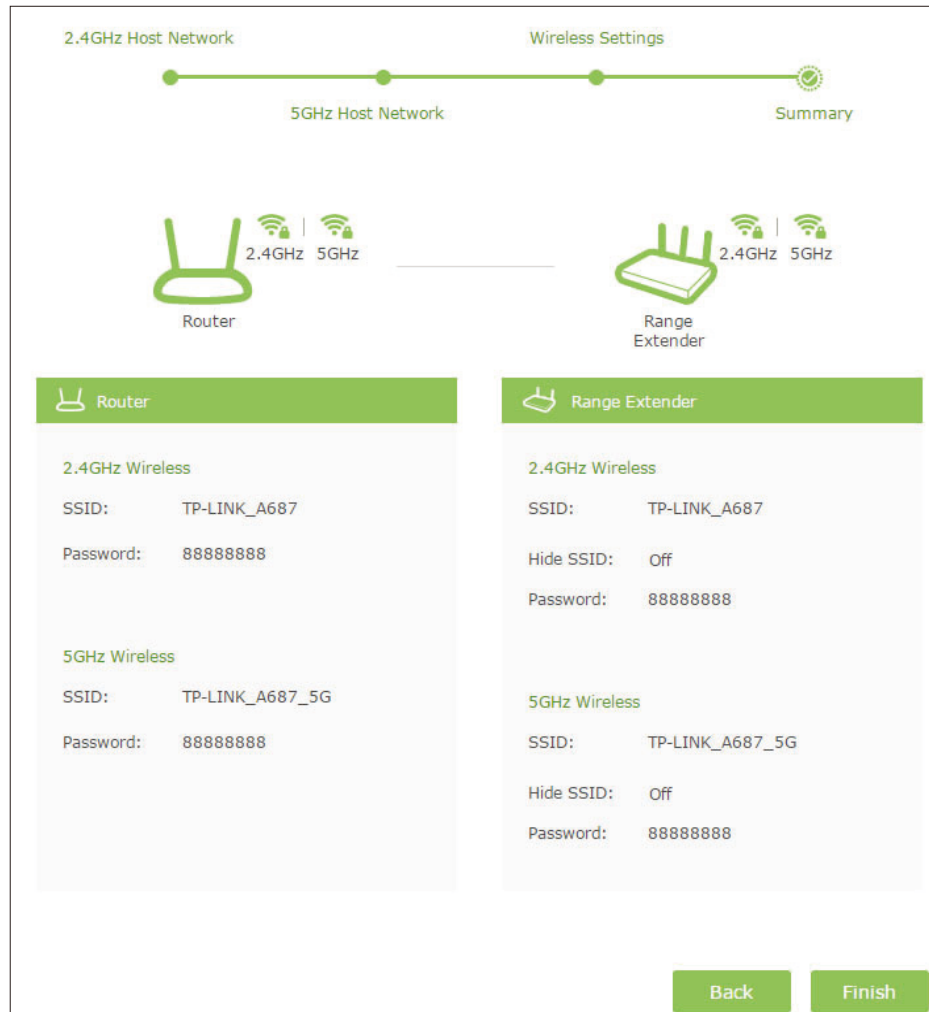

- 7) **Enjoy!** Connect to the extended network and enjoy the Internet. Both extended networks share the same wireless passwords as those of your host networks, but may have different network names if you have customized the SSIDs during the configuration.

Tips:

Since the performance of the extended network will be affected by the distance between extender and host router, we highly recommend you to relocate your extender referring to [Position Your Extender](#).

2.2. Position Your Extender

Please follow the instructions below to achieve optimal performance of the extender.

1. Plug the extender into an electrical outlet between your host router and the Wi-Fi “dead” zone. The location you choose must be within the range of your existing host network.
2. Wait until the (RE) LED is lit and solid blue. If not, relocate it closer to the host router to achieve better signal quality.



☛ Tips:

To minimize signal interference, please choose a location which is far away from Bluetooth devices and other household electronic devices, such as cordless phones, microwave ovens and baby monitors.

Chapter 3

Customize Your Network

This chapter guides you on how to configure network settings that are available for this extender.

This chapter contains the following sections:

- *Check Internet Status*
- *Configure Wireless Network*
- *Change LAN Settings*
- *Specify DHCP Server Settings*
- *Set Access Control*

3.1. Check Internet Status

You can view the Internet status of your extender to check whether you have successfully set up the extended network(s).

1. Visit <http://tplinkrepeater.net>, and log in with the username and password you set for the extender.
2. Go to **Settings** > **Status** to view the Internet status of your extender.

The extender runs normally.

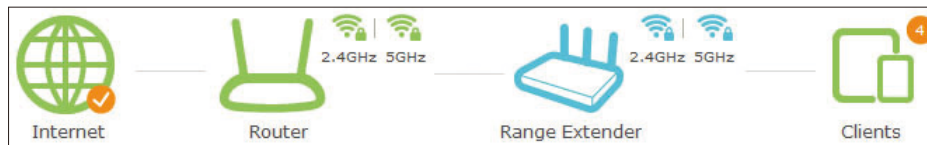

The extender fails to connect to the host networks. Please run the Quick Setup again.



The extender is connected to the host networks, but there are no transmitting data. Please check the Internet connection of your router.

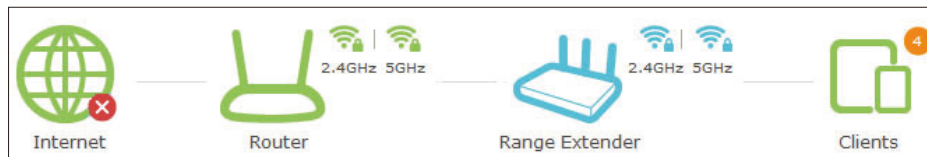

The extender is connected to the router abnormally. Maybe the gateway is set incorrectly in the Static IP. Please set your computer to obtain an IP address automatically.

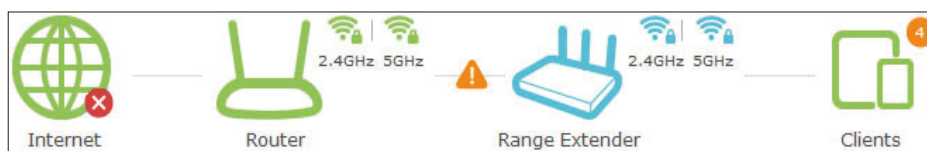

Click the icon of the Internet/Router/Range Extender/Clients to view corresponding information.

3.2. Configure Wireless Network

If you want to extend another host network after Quick Setup, you can refer to this section. Moreover, you can change the wireless settings for your extended networks.

Visit <http://tplinkwifi.net>, and log in with the username and password you set for the extender.

Note:

Here we take the configuration of the 2.4GHz network as an example. If the 5GHz network is available on your extender, please refer to the instructions to set your 5GHz network.

➤ To extend another host network

1. Go to [Settings](#) > [Wireless](#) > [Connect to Network](#).
2. Enable [Connect to 2.4GHz Network](#) and click [Wireless Scanner](#) to find all available networks.

3. Select the 2.4GHz host network you want to extend.

Note:

If the network you want to extend is on but not listed, please try the following steps.

- Move the extender closer to your router, and click [Rescan](#) on the top-right corner of the list.
- You can manually enter the parameters of the network you want to extend, and click [Save](#).

4. Once a host network is selected, the SSID and security type will be automatically filled in. If the selected network is encrypted, enter the password in the [Password](#) field.

5. Click [Save](#).

➤ To enable or disable the extended network:

1. Go to [Settings](#) > [Wireless](#) > [Extended Network](#).
2. The wireless radio is enabled by default. If you want to disable the wireless function of a certain band, just clear the [Enable](#) checkbox. In this case, all the wireless settings of this band will be invalid.
3. Click [Save](#).

➤ **To change the wireless network name (SSID):**

1. Go to [Settings](#) > [Wireless](#) > [Extended Network](#).
2. Create a new SSID in [Extended 2.4GHz SSID](#) or click [Copy Host SSID](#). The value is case-sensitive.
3. Click [Save](#).

📌 **Note:**

If you change the wireless settings via a wireless device, you will be disconnected after the settings are applied. Please write down the new SSID for future use.

➤ **To hide the SSID of the extended network:**

1. Go to [Settings](#) > [Wireless](#) > [Extended Network](#).
2. Select [Hide SSID broadcast](#), and the corresponding SSID will not display when you scan for local wireless networks on your wireless device and you have to manually join the network.
3. Click [Save](#).

3.3. Change LAN Settings

The extender is preset with a default LAN IP 192.168.0.254, with which you can log in to the web management page. The LAN IP address, together with the Subnet Mask, also defines the subnet that the connected devices are on. If the IP address conflicts with another device on your local network or your network requires a specific IP subnet, you can change it.

1. Visit <http://tplinkrepeater.net>, and log in with the username and password you set for the extender.
2. Go to [Settings](#) > [Network](#).
3. Select [Use the following IP address](#).
4. Enter a new IP Address as needed and leave the [Subnet Mask](#) as the default settings and enter the gateway that is in the same subnet as the IP address. The gateway is usually the LAN IP address of your extender.



The screenshot shows a 'Network Settings' form. At the top, there are two radio buttons: 'Obtain an IP address automatically' (unselected) and 'Use the following IP address' (selected). Below this, there are three input fields: 'IP Address' with the value '192.168.0.254', 'Subnet Mask' with '255.255.255.0', and 'Default Gateway' with '192.168.0.254'. A green 'Save' button is located at the bottom right of the form.

5. Click [Save](#).

3.4. Specify DHCP Server Settings

By default, the DHCP (Dynamic Host Configuration Protocol) Server is enabled and the extender acts as a DHCP server; it dynamically assigns TCP/IP parameters to client devices from the IP Address Pool. You can change the settings of the DHCP Server if necessary.

1. Visit <http://tplinkextender.net>, and log in with the username and password you set for the extender.
2. Go to [Settings](#) > [Network](#).

➤ **To specify the IP address that the extender assigns:**

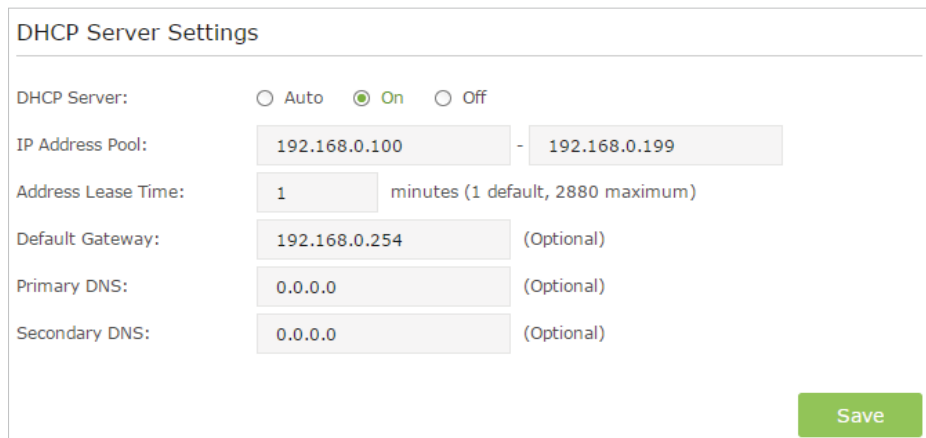

The screenshot shows a 'DHCP Server Settings' form. At the top, there are three radio buttons: 'Auto' (unselected), 'On' (selected), and 'Off' (unselected). Below this, there are several input fields: 'IP Address Pool' with the range '192.168.0.100 - 192.168.0.199', 'Address Lease Time' with the value '1' and the text 'minutes (1 default, 2880 maximum)', 'Default Gateway' with '192.168.0.254' and '(Optional)', 'Primary DNS' with '0.0.0.0' and '(Optional)', and 'Secondary DNS' with '0.0.0.0' and '(Optional)'. A green 'Save' button is located at the bottom right of the form.

1. Select [Auto](#) (recommended) or [On](#) to enable the DHCP Server.
2. Enter the starting and ending IP addresses in the [IP Address Pool](#).
3. Enter other parameters if the ISP offers. The [Default Gateway](#) is automatically filled in and is the same as the LAN IP address of the extender.
4. Click [Save](#).

➤ To view the DHCP Client List

You can view the information of the DHCP clients connected to the extender in the DHCP Client List.

DHCP Client List				
Client Number: 1				 Refresh
ID	Client Name	MAC Address	Assigned IP Address	Lease Time
1	WIN7-PC	D4-3D-7E-BF-61-5F	192.168.0.100	00:00:31

3.5. Set Access Control

Access Control allows you to permit or block specific devices from accessing the Internet for a specific period.

1. Visit <http://tplinkrepeater.net> and log in with the username and password you set for the extender.
2. Go to [Settings](#) > [Wireless](#) > [Access Control](#).
3. Enable [Access Control](#).

Access Control	
Access Control:	<input checked="" type="checkbox"/> On

➤ To block specific device(s)

📌 Note:

Devices connected to the extender via an Ethernet cable can not be blocked.

1. Select [Blacklist](#) and click [Save](#).

Access Mode	
Default Access Mode:	<input checked="" type="radio"/> Blacklist <input type="radio"/> Whitelist
<input type="button" value="Save"/>	

2. Select the device to be blocked in the [Online Devices](#) table by ticking the corresponding checkbox.
3. Click [Block](#) and the selected device(s) will be added to the [Devices in Blacklist](#) table.

Online Devices						
<input checked="" type="checkbox"/>	ID	Device Name	IP Address	MAC Address	Connection Type	Modify
<input checked="" type="checkbox"/>	1	NC450 1.0	192.168.1.112	04-18-78-17-10-6F	Wireless	

Refresh

4. You can also click [Add](#) in the [Devices in Blacklist](#) table and enter the [Device Name](#) and [MAC Address](#) to manually block a certain device.

Devices in Blacklist				
<input type="checkbox"/>	ID	Device Name	MAC Address	Modify
--	--	--	--	--

[+ Add](#) [- Delete](#)

Device Name:

MAC Address:

[Cancel](#) [OK](#)

5. Click [OK](#).

➤ **To permit specific device(s)**

1. Select [Whitelist](#) and click [Save](#).

Access Mode	
Default Access Mode:	<input type="radio"/> Blacklist <input checked="" type="radio"/> Whitelist
Save	

2. Click [Add](#) in the [Devices in Whitelist](#) table, and enter the [Device Name](#) and [MAC Address](#).

Devices in Whitelist

+ Add - Delete

<input type="checkbox"/>	ID	Device Name	MAC Address	Modify
<input type="checkbox"/>	--	--	--	--

Device Name:

MAC Address:

Cancel OK

3. Click [OK](#).

Chapter 4

Use Your Extender as a Wireless Adapter

This chapter presents how to use the extender as a wireless adapter .

The extender can be used as a wireless adapter to connect any wired-only device, such as a Blu-ray player, game console, DVR, or smart TV, to your wireless network.

After configuration, you can connect an Ethernet-enabled device to the extender via an Ethernet cable.

Note:

Extenders that have no Ethernet port do not support this feature.

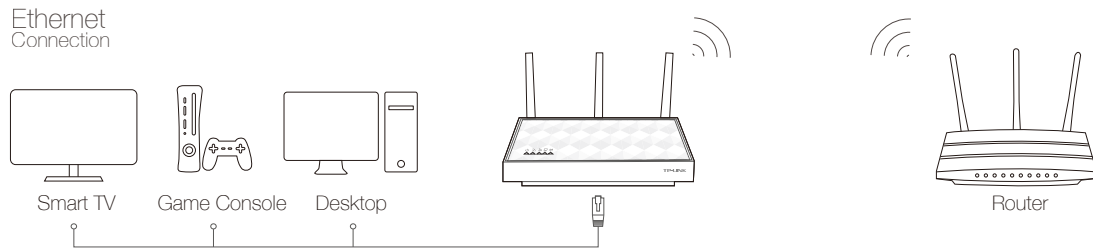

By default, the Ethernet port of the extender is connected to the 5GHz wireless network.

➤ **To change the connected wireless frequency**

1. Visit <http://tplinkrepeater.net>, and log in with the username and password you set for the extender.
2. Go to **Settings > Network**.
3. Select **2.4GHz** or **5GHz** and click **Save**.

Ethernet Port

Host Network for the Ethernet port: 2.4GHz 5GHz

Save

Chapter 5

Manage Your Extender

This chapter presents how to manage and maintain your extender.

This chapter includes the following sections:

- *Select Time Zone*
- *Control LEDs*
- *Upgrade the Firmware*
- *Backup and Restore Configuration Settings*
- *Change Admin Account*
- *System Log*

5.1. Select Time Zone

1. Visit <http://tplinkrepeater.net>, and log in with the username and password you set for the extender.
2. Go to [Settings](#) > [System Tools](#) > [Time Settings](#).
3. Select your local [Time Zone](#) from the drop-down list.

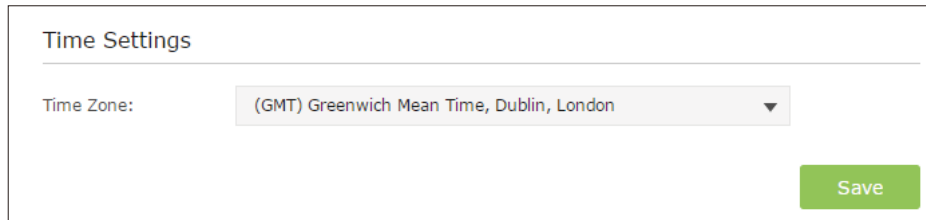

Time Settings

Time Zone: (GMT) Greenwich Mean Time, Dublin, London

Save

4. Click [Save](#).

5.2. Control LEDs

The LEDs of the extender indicate its activities and status. You can enable the Night Mode feature to specify a time period during which the LEDs are off.

1. Visit <http://tplinkrepeater.net>, and log in with the username and password you set for the extender.
2. Go to [Settings](#) > [System Tools](#) > [LED Control](#).
 - **To specify a time period when LEDs are off:**
 1. Select [Night Mode](#).
 2. Specify a time period in the [LED Off Time](#) field, and the LEDs will be off during this period.
 3. Click [Save](#).

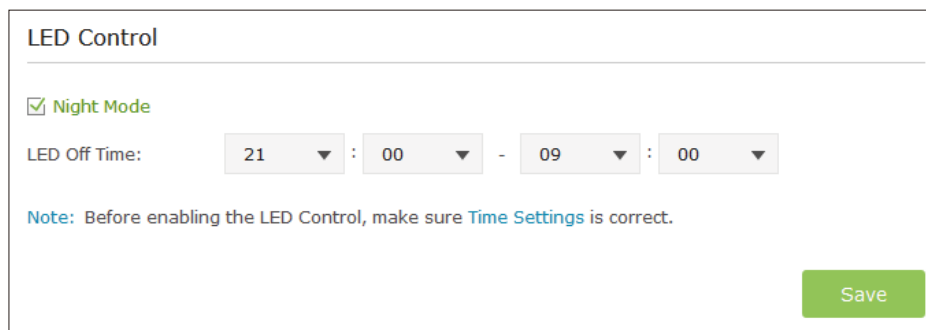

LED Control

Night Mode

LED Off Time: 21 : 00 - 09 : 00

Note: Before enabling the LED Control, make sure [Time Settings](#) is correct.

Save

5.3. Upgrade the Firmware

TP-LINK is dedicated to improving, enriching the product features and giving you a better network experience. You can download the latest firmware file from the [Support](#) page of our website www.tp-link.com and upgrade the firmware to the latest version.

Note:

1. Make sure the latest firmware file is matched with the hardware version (as shown in the download section of the Support page).
2. Make sure that you have a stable connection between the extender and your computer. It is NOT recommended to upgrade the firmware wirelessly.
3. Backup your extender configuration.
4. Do NOT power off the extender during the firmware upgrade.

1. Download the latest firmware file for the extender from our website www.tp-link.com.
2. Visit <http://tplinkrepeater.net>, and log in with the username and password you set for the extender.
3. Go to [Settings](#) > [System Tools](#) > [Firmware Upgrade](#).
4. Click [Browse](#) to locate the downloaded new firmware file, and then click [Upgrade](#).

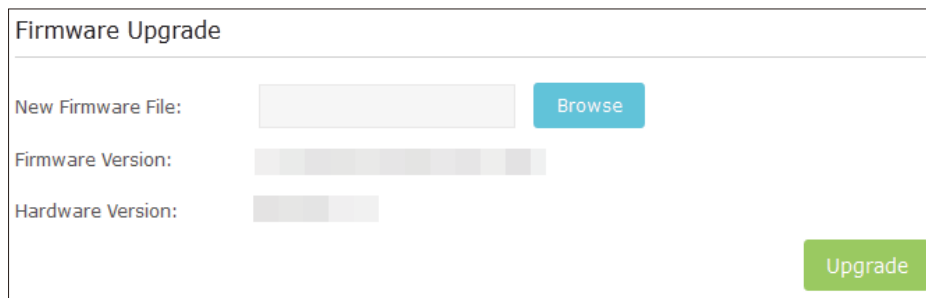

The screenshot shows a web interface titled "Firmware Upgrade". It contains three input fields: "New Firmware File:" with a "Browse" button, "Firmware Version:" with a dropdown menu, and "Hardware Version:" with a dropdown menu. A green "Upgrade" button is located at the bottom right of the form.

5. Wait a few minutes for the upgrade and reboot.

5.4. Backup and Restore Configuration Settings

The configuration settings are stored as a configuration file in the extender. You can backup the configuration file and restore the extender to the previous settings from the backup file when needed. Moreover, if necessary, you can erase the current settings and reset the extender to the default factory settings.

1. Visit <http://tplinkrepeater.net>, and log in with the username and password you set for the extender.
2. Go to [Settings](#) > [System Tools](#) > [Backup & Restore](#).

➤ **To backup configuration settings:**

Click [Backup](#) to save a copy of the current settings to your local computer. A '.bin' file of the current settings will be stored on your computer.

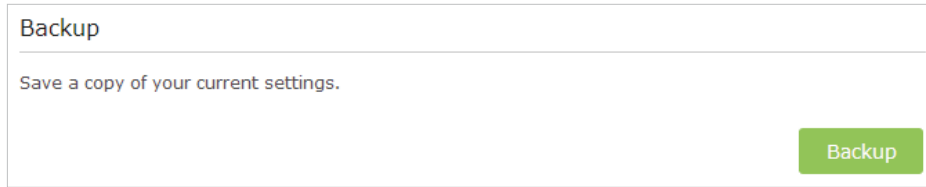

Backup

Save a copy of your current settings.

Backup

➤ **To restore configuration settings:**

1. Click [Browse](#) to locate the backup configuration file stored on your computer, and click [Restore](#).

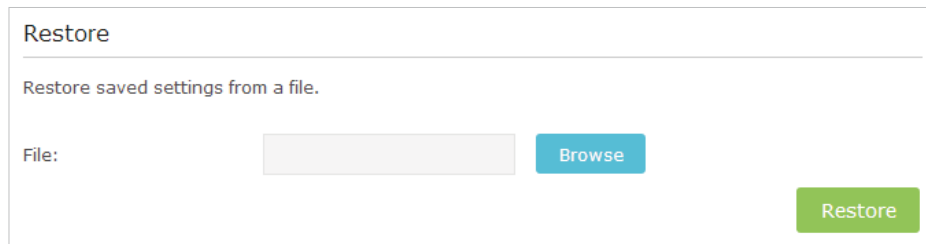

Restore

Restore saved settings from a file.

File: [Browse](#)

Restore

2. Wait a few minutes for the restore and reboot.

■ **Note:** During the restoring process, do not power off or reset the extender.

➤ **To reset the extender to factory default settings:**

1. Click [Factory Restore](#) to reset the extender.



Factory Default Restore

Revert all settings to factory defaults.

Factory Restore

2. Wait a few minutes for the reset and reboot.

■ **Note:**

1. During the resetting process, do not power off or reset the router.
2. We strongly recommend you backup the current configuration settings before resetting the extender.

5.5. Change Admin Account

The account management feature allows you to change your login username and password of the management webpage.

1. Visit <http://tplinkrepeater.net>, and log in with the username and password you set for the extender.
2. Go to [Settings](#) > [System Tools](#) > [Admin Account](#).
3. Enter the old username and password. Then enter the new username and password twice (both case-sensitive) and click [Save](#).

Admin Account

Old Username:

Old Password:

New Username:

New Password:

Low
Middle
High

Confirm Password:

4. Use the new username and password for future logins.

5.6. System Log

When the extender does not work properly, you can save the system log and send it to our technical support for troubleshooting.

1. Visit <http://tplinkrepeater.net>, and log in with the username and password you set for the extender.
 2. Go to [Settings](#) > [System Tools](#) > [System Log](#).
- **To Save the system log in local:**
1. Choose the type and level of the system log as needed.
 2. Click [Save Log](#) to save the system logs to local.

System Log

Log Filter: Type = ALL Level = ALL

ID	Time	Type	Level	Content
3	0 days 06:03:53	DHCPC	INFO	Received a DHCP offer:Server ID is 54.Assigned IP address is 192.168.1.121
2	0 days 06:03:53	DHCPC	INFO	Sent a detection for DHCP.
1	0 days 06:03:52	OTHERS	INFO	User cleared up all the logs.

FAQ

Q1. How to reset the extender to its factory default settings?

- With the extender powered on, use a pin to press the [RESET](#) button until all the LEDs turn on momentarily and then release the button.
- Log into the extender's web management page. Go to [System Tools](#) > [Restore & Backup](#) and click [Factory Restore](#).

Q2. What can I do if I forgot my login password?

Refer to [FAQ](#) > [Q1](#) to reset the extender, and use default [admin](#) (in lowercase) as both username and password to login.

Note: You need to reconfigure the extender to surf the Internet once the extender is reset, and please mark down your new login password for future use.

Q3. What can I do if I forgot my wireless password?

The factory default wireless password is printed on the label of the extender.

If the password has been altered, please connect your computer to the extender using an Ethernet cable and follow the steps below:

1. Visit <http://tplinkrepeater.net>, and log in with the username and password you set for the extender.
2. Go to [Settings](#) > [Wireless](#) to retrieve or reset your wireless password.

Q4. What can I do if I cannot access the web management page?

This can happen for a variety of reasons. Please try the methods below to login again.

- Make sure your computer is connected to the extended network.
- Make sure your computer is configured as [Obtain an IP address automatically](#) and [Obtain DNS server address automatically](#).
- Use the IP address to access the extender. The default IP is [192.168.0.254](#). If the extender is connected to the router, you should go to your router's DHCP client list to obtain the extender's current IP address.
- Reset the extender. Then connect your computer to its wireless network, enter <http://tplinkrepeater.net> or [192.168.0.254](#) in the web browser and press [Enter](#).

Q5. I enabled wireless MAC filter, wireless access control, or access control list (ACL) on my router, what should I do to configure and use the extender?

When a device connects through the extender to your router, the MAC address of the device shown on the router is translated to another MAC address. If your router's MAC

filter, wireless access control, or ACL is enabled, the devices connected to the extender cannot get an IP address from the extender and cannot access the Internet.

To solve this problem, please follow the steps below:

1. Log into your router and disable the MAC filter, wireless access control or ACL.

Note: For more information about how to disable your router's MAC filter, wireless access control or ACL, please refer to your router's user guide.

2. Power on your extender, and run the [Quick Setup](#) to configure your extender.

3. Connect all of your devices to the extended network, and make sure the router's Link LED remains lit.

4. On your router, add all the Online Devices' MAC addresses to your router's MAC filter table.

5. Enable the router's MAC filter, wireless access control, or ACL.

Now, you have successfully configured your extender.

COPYRIGHT & TRADEMARKS

Specifications are subject to change without notice. **TP-LINK** is a registered trademark of TP-LINK TECHNOLOGIES CO., LTD. Other brands and product names are trademarks or registered trademarks of their respective holders.

No part of the specifications may be reproduced in any form or by any means or used to make any derivative such as translation, transformation, or adaptation without permission from TP-LINK TECHNOLOGIES CO., LTD. Copyright © 2016 TP-LINK TECHNOLOGIES CO., LTD. All rights reserved.

FCC STATEMENT



This equipment has been tested and found to comply with the limits for a Class B digital device, pursuant to part 15 of the FCC Rules. These limits are designed to provide reasonable protection against harmful interference in a residential installation. This equipment generates, uses and can radiate radio frequency energy and, if not installed and used in accordance with the instructions, may cause harmful interference to radio communications. However, there is no guarantee that interference will not occur in a particular installation. If this equipment does cause harmful interference to radio or television reception, which can be determined by turning the equipment off and on, the user is encouraged to try to correct the interference by one or more of the following measures:

- Reorient or relocate the receiving antenna.
- Increase the separation between the equipment and receiver.
- Connect the equipment into an outlet on a circuit different from that to which the receiver is connected.
- Consult the dealer or an experienced radio/ TV technician for help.

This device complies with part 15 of the FCC Rules. Operation is subject to the following two conditions:

1. This device may not cause harmful interference.
2. This device must accept any interference received, including interference that may cause undesired operation.

Any changes or modifications not expressly approved by the party responsible for compliance could void the user's authority to operate the equipment.

Note: The manufacturer is not responsible for any radio or TV interference caused by unauthorized modifications to this equipment. Such modifications could void the user's authority to operate the equipment.

FCC RF Radiation Exposure Statement:

This equipment complies with FCC RF radiation exposure limits set forth for an uncontrolled environment. This device and its antenna must not be co-located or operating in conjunction with any other antenna or transmitter.

"To comply with FCC RF exposure compliance requirements, this grant is applicable to only Mobile Configurations. The antennas used for this transmitter must be installed to provide a separation distance of at least 20 cm from all persons and must not be co-located or operating in conjunction with any other antenna or transmitter."

This device is restricted in indoor environment only.

CE Mark Warning



This is a class B product. In a domestic environment, this product may cause radio interference, in which case the user may be required to take adequate measures.

RF Exposure Information

This device meets the EU requirements (1999/5/EC Article 3.1a) on the limitation of exposure of the general public to electromagnetic fields by way of health protection.

The device complies with RF specifications when the device used at 20 cm from your body.

Restricted to indoor use.

Canadian Compliance Statement

This device complies with Industry Canada license-exempt RSSs. Operation is subject to the following two conditions:

1. This device may not cause interference, and
2. This device must accept any interference, including interference that may cause undesired operation of the device.

Le présent appareil est conforme aux CNR d'Industrie Canada applicables aux appareils radio exempts de licence. L'exploitation est autorisée aux deux conditions suivantes :

1. l'appareil ne doit pas produire de brouillage;
2. l'utilisateur de l'appareil doit accepter tout brouillage radioélectrique subi, même si le brouillage est susceptible d'en compromettre le fonctionnement.

This radio transmitter (IC: 8853A-RE580D/ Model: RE580D) has been approved by Industry Canada to operate with the antenna types listed below with the maximum permissible gain indicated. Antenna types not included in this list below, having a gain greater than the maximum gain indicated for that type, are strictly prohibited for use with this device.

Le présent émetteur radio (IC: 8853A-RE580D/ Model: RE580D) a été approuvé par Industrie Canada pour fonctionner avec les types d'antenne énumérés ci-dessous et ayant un gain admissible maximal. Les types d'antenne non inclus dans cette liste ci-dessous et dont le gain est supérieur au gain maximal indiqué, sont strictement interdits pour l'exploitation de l'émetteur.

Antenna	3 dual band detachable antennas
---------	---------------------------------

Caution:

1. The device for operation in the band 5150–5250 MHz is only for indoor use to reduce the potential for harmful interference to co-channel mobile satellite systems;

2. For devices with detachable antenna(s), the maximum antenna gain permitted for devices in the band 5725-5850 MHz shall be such that the equipment still complies with the e.i.r.p. limits specified for point-to-point and non-point-to-point operation as appropriate; and

The high-power radars are allocated as primary users (i.e. priority users) of the bands 5250-5350 MHz and 5650-5850 MHz and that these radars could cause interference and/or damage to LE-LAN devices.

Avertissement:

1. Le dispositif fonctionnant dans la bande 5150-5250 MHz est réservé uniquement pour une utilisation à l'intérieur afin de réduire les risques de brouillage préjudiciable aux systèmes de satellites mobiles utilisant les mêmes canaux;
2. Le gain maximal d'antenne permis pour les dispositifs avec antenne(s) amovible(s) utilisant la bande 5725-5850 MHz doit se conformer à la limitation P.I.R.E spécifiée pour l'exploitation point à point et non point à point, selon le cas.

En outre, les utilisateurs devraient aussi être avisés que les utilisateurs de radars de haute puissance sont désignés utilisateurs principaux (c.-à-d., qu'ils ont la priorité) pour les bandes 5250-5350 MHz et 5650-5850 MHz et que ces radars pourraient causer du brouillage et/ou des dommages aux dispositifs LAN-EL.

Radiation Exposure Statement:

This equipment complies with IC radiation exposure limits set forth for an uncontrolled environment. This equipment should be installed and operated with minimum distance 20cm between the radiator & your body.

Déclaration d'exposition aux radiations:

Cet équipement est conforme aux limites d'exposition aux rayonnements IC établies pour un environnement non contrôlé. Cet équipement doit être installé et utilisé avec un minimum de 20 cm de distance entre la source de rayonnement et votre corps.

Industry Canada Statement

CAN ICES-3 (B)/NMB-3(B)

Korea Warning Statements

당해 무선설비는 운용중 전파혼신 가능성이 있음.

NCC Notice & BSMI Notice

注意！

依據 低功率電波輻射性電機管理辦法

第十二條 經型式認證合格之低功率射頻電機，非經許可，公司、商號或使用者均不得擅自變更頻率、加大功率或變更原設計之特性或功能。

第十四條 低功率射頻電機之使用不得影響飛航安全及干擾合法通行；經發現有干擾現象時，應立即停用，並改善至無干擾時方得繼續使用。前項合法通信，指依電信規定作業之無線電信。低功率射頻電機需忍受合法通信或工業、科學以及醫療用電波輻射性電機設備之干擾。

安全諮詢及注意事項

- 請使用原裝電源供應器或只能按照本產品注明的電源類型使用本產品。
- 清潔本產品之前請先拔掉電源線。請勿使用液體、噴霧清潔劑或濕布進行清潔。
- 注意防潮，請勿將水或其他液體潑灑到本產品上。
- 插槽與開口供通風使用，以確保本產品的操作可靠並防止過熱，請勿堵塞或覆蓋開口。
- 請勿將本產品置放於靠近熱源的地方。除非有正常的通風，否則不可放在密閉位置中。
- 請不要私自打開機殼，不要嘗試自行維修本產品，請由授權的專業人士進行此項工作。



Продукт сертифіковано згідно с правилами системи УкрСЕПРО на відповідність вимогам нормативних документів та вимогам, що передбачені чинними законодавчими актами України.





Safety Information

- When product has power button, the power button is one of the way to shut off the product; when there is no power button, the only way to completely shut off power is to disconnect the product or the power adapter from the power source.
- Don't disassemble the product, or make repairs yourself. You run the risk of electric shock and voiding the limited warranty. If you need service, please contact us.
- Avoid water and wet locations.
- Adapter shall be installed near the equipment and shall be easily accessible.
- The plug considered as disconnect device of adapter.
-  Use only power supplies which are provided by manufacturer and in the original packing of this product. If you have any questions, please don't hesitate to contact us.

This product can be used in the following countries:

AT	BE	BG	CH	CY	CZ	DE	DK
EE	ES	FI	FR	GB	GR	HR	HU
IE	IS	IT	LI	LT	LU	LV	MT
NL	NO	PL	PT	RO	SE	SI	SK

Explanations of the symbols on the product label

Symbol	Explanation
	DC voltage
	<p>RECYCLING</p> <p>This product bears the selective sorting symbol for Waste electrical and electronic equipment (WEEE). This means that this product must be handled pursuant to European directive 2012/19/EU in order to be recycled or dismantled to minimize its impact on the environment.</p> <p>User has the choice to give his product to a competent recycling organization or to the retailer when he buys a new electrical or electronic equipment.</p>