

TP-LINK®

User Guide

TL-SG2216/TL-SG2424/TL-SG2424P/TL-SG2452 Gigabit Smart Switch



COPYRIGHT & TRADEMARKS

Specifications are subject to change without notice. **TP-LINK®** is a registered trademark of TP-LINK TECHNOLOGIES CO., LTD. Other brands and product names are trademarks or registered trademarks of their respective holders.

No part of the specifications may be reproduced in any form or by any means or used to make any derivative such as translation, transformation, or adaptation without permission from TP-LINK TECHNOLOGIES CO., LTD. Copyright © 2015 TP-LINK TECHNOLOGIES CO., LTD. All rights reserved.

<http://www.tp-link.com>

FCC STATEMENT



This equipment has been tested and found to comply with the limits for a Class A digital device, pursuant to part 15 of the FCC Rules. These limits are designed to provide reasonable protection against harmful interference when the equipment is operated in a commercial environment. This equipment generates, uses, and can radiate radio frequency energy and, if not installed and used in accordance with the instruction manual, may cause harmful interference to radio communications. Operation of this equipment in a residential area is likely to cause harmful interference in which case the user will be required to correct the interference at his own expense.

This device complies with part 15 of the FCC Rules. Operation is subject to the following two conditions:

- 1) This device may not cause harmful interference.
- 2) This device must accept any interference received, including interference that may cause undesired operation.

Any changes or modifications not expressly approved by the party responsible for compliance could void the user's authority to operate the equipment.

CE Mark Warning



This is a class A product. In a domestic environment, this product may cause radio interference, in which case the user may be required to take adequate measures.



Продукт сертифіковано згідно з правилами системи УкрСЕПРО на відповідність вимогам нормативних документів та вимогам, що передбачені чинними законодавчими актами України.



Safety Information

- When product has power button, the power button is one of the way to shut off the product; When there is no power button, the only way to completely shut off power is to disconnect the product or the power adapter from the power source.
- Don't disassemble the product, or make repairs yourself. You run the risk of electric shock and voiding the limited warranty. If you need service, please contact us.
- Avoid water and wet locations.

This product can be used in the following countries:

AT	BG	BY	CA	CZ	DE	DK	EE
ES	FI	FR	GB	GR	HU	IE	IT
LT	LV	MT	NL	NO	PL	PT	RO
RU	SE	SK	TR	UA	US		

CONTENTS

Package Contents	1
Chapter 1 About this Guide.....	2
1.1 Intended Readers	2
1.2 Conventions.....	2
1.3 Overview of This Guide	2
Chapter 2 Introduction	6
2.1 Overview of the Switch	6
2.2 Main Features.....	6
2.3 Appearance Description	7
2.3.1 Front Panel	7
2.3.2 Rear Panel.....	10
Chapter 3 Login to the Switch.....	11
3.1 Login.....	11
3.2 Configuration	12
Chapter 4 System.....	13
4.1 System Info.....	13
4.1.1 System Summary.....	13
4.1.2 Device Description	15
4.1.3 System Time	15
4.1.4 Daylight Saving Time	16
4.1.5 System IP.....	17
4.1.6 System IPv6.....	19
4.2 User Management	27
4.2.1 User Table.....	27
4.2.2 User Config	27
4.3 System Tools	29
4.3.1 Config Restore	29
4.3.2 Config Backup.....	29
4.3.3 Firmware Upgrade	30
4.3.4 System Reboot	31
4.3.5 System Reset.....	31
4.4 Access Security	31
4.4.1 Access Control.....	31
4.4.2 SSL Config.....	33
4.4.3 SSH Config	34
Chapter 5 Switching.....	41

5.1	Port.....	41
5.1.1	Port Config.....	41
5.1.2	Port Mirror.....	42
5.1.3	Port Security.....	44
5.1.4	Port Isolation.....	46
5.1.5	Loopback Detection.....	47
5.2	LAG.....	48
5.2.1	LAG Table.....	49
5.2.2	Static LAG.....	50
5.2.3	LACP Config.....	51
5.3	Traffic Monitor.....	53
5.3.1	Traffic Summary.....	53
5.3.2	Traffic Statistics.....	54
5.4	MAC Address.....	56
5.4.1	Address Table.....	56
5.4.2	Static Address.....	57
5.4.3	Dynamic Address.....	59
5.4.4	Filtering Address.....	60
5.5	DHCP Filtering.....	62
Chapter 6	VLAN.....	65
6.1	802.1Q VLAN.....	66
6.1.1	VLAN Config.....	68
6.2	Application Example for 802.1Q VLAN.....	69
Chapter 7	Spanning Tree.....	71
7.1	STP Config.....	76
7.1.1	STP Config.....	76
7.1.2	STP Summary.....	78
7.2	Port Config.....	79
7.3	MSTP Instance.....	80
7.3.1	Region Config.....	81
7.3.2	Instance Config.....	81
7.3.3	Instance Port Config.....	82
7.4	STP Security.....	84
7.4.1	Port Protect.....	84
7.4.2	TC Protect.....	87
7.5	Application Example for STP Function.....	87
Chapter 8	Multicast.....	92

8.1	IGMP Snooping	96
8.1.1	Snooping Config	98
8.1.2	VLAN Config	98
8.1.3	Port Config.....	100
8.1.4	IP-Range.....	102
8.1.5	Multicast VLAN	102
8.1.6	Static Multicast IP.....	105
8.1.7	Packet Statistics.....	106
8.2	MLD Snooping.....	108
8.2.1	Global Config	110
8.2.2	VLAN Config	112
8.2.3	Filter Config.....	113
8.2.4	Port Config.....	114
8.2.5	Static Multicast.....	115
8.2.6	Querier Config.....	115
8.2.7	Packet Statistics.....	117
8.3	Multicast Table	118
8.3.1	IPv4 Multicast Table	118
8.3.2	IPv6 Multicast Table	119
Chapter 9	QoS.....	120
9.1	DiffServ.....	123
9.1.1	Port Priority	123
9.1.2	DSCP Priority.....	124
9.1.3	802.1P/CoS mapping.....	126
9.1.4	Schedule Mode	127
9.2	Bandwidth Control	128
9.2.1	Rate Limit.....	128
9.2.2	Storm Control.....	130
9.3	Voice VLAN	132
9.3.1	Global Config	134
9.3.2	Port Config.....	134
9.3.3	OUI Config.....	136
Chapter 10	ACL.....	138
10.1	ACL Config	138
10.1.1	ACL Summary.....	138
10.1.2	ACL Create	139
10.1.3	MAC ACL	139

10.1.4	Standard-IP ACL	140
10.1.5	Extend-IP ACL	140
10.2	Policy Config.....	141
10.2.1	Policy Summary	142
10.2.2	Policy Create.....	142
10.2.3	Action Create	143
10.3	Policy Binding	143
10.3.1	Binding Table	143
10.3.2	Port Binding	144
10.3.3	VLAN Binding.....	145
10.4	Application Example for ACL	146
Chapter 11	Network Security	148
11.1	802.1X	148
11.1.1	Global Config	153
11.1.2	Port Config.....	154
11.1.3	Radius Server	155
Chapter 12	PoE	158
12.1	PoE Config	158
12.1.1	PoE Config.....	159
12.1.2	PoE Profile.....	160
12.2	PoE Time-Range	161
12.2.1	Time-Range Summary	161
12.2.2	PoE Time-Range Create	162
12.2.3	PoE Holiday Config.....	163
Chapter 13	SNMP.....	164
13.1	SNMP Config.....	166
13.1.1	Global Config	166
13.1.2	SNMP View	167
13.1.3	SNMP Group.....	167
13.1.4	SNMP User	169
13.1.5	SNMP Community.....	171
13.2	Notification.....	173
13.3	RMON.....	174
13.3.1	History Control	175
13.3.2	Event Config	176
13.3.3	Alarm Config	177
Chapter 14	LLDP	179

14.1	Basic Config	183
14.1.1	Global Config	183
14.1.2	Port Config	184
14.2	Device Info	185
14.2.1	Local Info	185
14.2.2	Neighbor Info	186
14.3	Device Statistics	187
14.4	LLDP-MED	188
14.4.1	Global Config	189
14.4.2	Port Config	190
14.4.3	Local Info	192
14.4.4	Neighbor Info	193
Chapter 15	Maintenance	194
15.1	System Monitor	194
15.1.1	CPU Monitor	194
15.1.2	Memory Monitor	195
15.2	Log	195
15.2.1	Log Table	196
15.2.2	Local Log	196
15.2.3	Remote Log	197
15.2.4	Backup Log	198
15.3	Device Diagnostics	199
15.3.1	Cable Test	199
15.4	Network Diagnostics	200
15.4.1	Ping	200
15.4.2	Tracert	201
Appendix A:	Specifications	202
Appendix B:	Configuring the PCs	203
Appendix C:	802.1X Client Software	207
Appendix D:	Glossary	215

Package Contents

The following items should be found in your box:

- One Gigabit Smart Switch
- One power cord
- Two mounting brackets and other fittings
- Installation Guide
- Resource CD for TL-SG2216/TL-SG2424/TL-SG2424P/TL-SG2452, including:
 - This User Guide
 - CLI Reference Guide
 - SNMP Mibs
 - 802.1X Client Software
 - Other Helpful Information



Note:

Make sure that the package contains the above items. If any of the listed items are damaged or missing, please contact your distributor.

Chapter 1 About this Guide

This User Guide contains information for setup and management of TL-SG2216/TL-SG2424/TL-SG2424P/TL-SG2452 Gigabit Smart Switch. Please read this guide carefully before operation.

1.1 Intended Readers

This Guide is intended for network managers familiar with IT concepts and network terminologies.

1.2 Conventions

In this Guide the following conventions are used:

- The switch or TL-SG2216/TL-SG2424/TL-SG2424P/TL-SG2452 mentioned in this Guide stands for TL-SG2216/TL-SG2424/TL-SG2424P/TL-SG2452 Gigabit Smart Switch without any explanation.





Tips:

The TL-SG2216/TL-SG2424/TL-SG2424P/TL-SG2452 switches are sharing this User Guide. They just differ in the number of LED indicators and ports. For simplicity, we will take TL-SG2424 for example throughout this Guide. However, differences with significance will be presented with figures or notes as to attract your attention.

- **Menu Name**→**Submenu Name**→**Tab page** indicates the menu structure. **System**→**System Info**→**System Summary** means the System Summary page under the System Info menu option that is located under the System menu.
- **Bold font** indicates a button, a toolbar icon, menu or menu item.

Symbols in this Guide:

Symbol	Description
 Note:	Ignoring this type of note might result in a malfunction or damage to the device.
 Tips:	This format indicates important information that helps you make better use of your device.

1.3 Overview of This Guide

Chapter	Introduction
Chapter 1 About This Guide	Introduces the guide structure and conventions.
Chapter 2 Introduction	Introduces the features, application and appearance of TL-SG2216/TL-SG2424/TL-SG2424P/TL-SG2452 switch.

Chapter	Introduction
Chapter 3 Login to the Switch	Introduces how to log on to the Web management page.
Chapter 4 System	<p>This module is used to configure system properties of the switch. Here mainly introduces:</p> <ul style="list-style-type: none"> ● System Info: Configure the description, system time and network parameters of the switch. ● User Management: Configure the user name and password for users to log on to the Web management page with a certain access level. ● System Tools: Manage the configuration file of the switch. ● Access Security: Provide different security measures for the login to enhance the configuration management security.
Chapter 5 Switching	<p>This module is used to configure basic functions of the switch. Here mainly introduces:</p> <ul style="list-style-type: none"> ● Port: Configure the basic features for the port. ● LAG: Configure Link Aggregation Group. LAG is to combine a number of ports together to make a single high-bandwidth data path. ● Traffic Monitor: Monitor the traffic of each port. ● MAC Address: Configure the address table of the switch. ● DHCP Filtering: Monitor the process of the host obtaining the IP address from DHCP server.
Chapter 6 VLAN	<p>This module is used to configure VLANs to control broadcast in LANs. Here mainly introduces:</p> <ul style="list-style-type: none"> ● 802.1Q VLAN: Configure port-based VLAN.
Chapter 7 Spanning Tree	<p>This module is used to configure spanning tree function of the switch. Here mainly introduces:</p> <ul style="list-style-type: none"> ● STP Config: Configure and view the global settings of spanning tree function. ● Port Config: Configure CIST parameters of ports. ● MSTP Instance: Configure MSTP instances. ● STP Security: Configure protection function to prevent devices from any malicious attack against STP features.
Chapter 8 Multicast	<p>This module is used to configure multicast function of the switch. Here mainly introduces:</p> <ul style="list-style-type: none"> ● IGMP Snooping: Configure global parameters of IGMP Snooping function, port properties, VLAN and multicast VLAN. ● MLD Snooping: Configure global parameters of MLD Snooping function, port properties, VLAN and multicast VLAN. ● Multicast Table: View the information of IPv4 and IPv6 multicast groups already on the switch.

Chapter	Introduction
Chapter 9 QoS	<p>This module is used to configure QoS function to provide different quality of service for various network applications and requirements. Here mainly introduces:</p> <ul style="list-style-type: none"> ● DiffServ: Configure priorities, port priority, 802.1P priority and DSCP priority. ● Bandwidth Control: Configure rate limit feature to control the traffic rate on each port; configure storm control feature to filter broadcast, multicast and UL frame in the network. ● Voice VLAN: Configure voice VLAN to transmit voice data stream within the specified VLAN so as to ensure the transmission priority of voice data stream and voice quality.
Chapter 10 ACL	<p>This module is used to configure match rules and process policies of packets to filter packets in order to control the access of the illegal users to the network. Here mainly introduces:</p> <ul style="list-style-type: none"> ● ACL Config: ACL rules. ● Policy Config: Configure operation policies. ● Policy Binding: Bind the policy to a port/VLAN to take its effect on a specific port/VLAN.
Chapter 11 Network Security	<p>This module is used to configure the protection measure for the network security. Here introduces:</p> <ul style="list-style-type: none"> ● 802.1X: Configure common access control mechanism for LAN ports to solve mainly authentication and security problems.
Chapter 12 PoE	<p>This module is used to configure the PoE function for the switch to supply power for PD devices. Here mainly introduces:</p> <ul style="list-style-type: none"> ● PoE Config: Configure PoE function globally. ● PoE Time-Range: Configure the effective time for PoE port to supply power..
Chapter 13 SNMP	<p>This module is used to configure SNMP function to provide a management frame to monitor and maintain the network devices. Here mainly introduces:</p> <ul style="list-style-type: none"> ● SNMP Config: Configure global settings of SNMP function. ● Notification: Configure notification function for the management station to monitor and process the events. ● RMON: Configure RMON function to monitor network more efficiently.
Chapter 14 LLDP	<p>This module is used to configure LLDP function to provide information for SNMP applications to simplify troubleshooting. Here mainly introduces:</p> <ul style="list-style-type: none"> ● Basic Config: Configure the LLDP parameters of the device. ● Device Info: View the LLDP information of the local device and its neighbors ● Device Statistics: View the LLDP statistics of the local device ● LLDP-MED: Configure LLDP-MED parameters of the device.

Chapter	Introduction
Chapter 15 Maintenance	<p>This module is used to assemble the commonly used system tools to manage the switch. Here mainly introduces:</p> <ul style="list-style-type: none"> ● System Monitor: Monitor the memory and CPU of the switch. ● Log: View configuration parameters on the switch. ● Device Diagnostics: Test the connection status of the cable connected to the switch, test if the port of the switch and the connected device are available. ● Network Diagnostics: Test if the destination is reachable and the account of router hops from the switch to the destination.
Appendix A Specifications	Lists the hardware specifications of the switch.
Appendix B Configure the PCs	Introduces how to configure the PCs.
Appendix C 802.1X Client Software	Introduces how to use 802.1X Client Software provided for authentication.
Appendix D Glossary	Lists the glossary used in this manual.

[Return to CONTENTS](#)

Chapter 2 Introduction

Thanks for choosing the TL-SG2216/TL-SG2424/TL-SG2424P/TL-SG2452 Gigabit Smart Switch!

2.1 Overview of the Switch

Designed for workgroups and departments, TL-SG2216/TL-SG2424/TL-SG2424P/TL-SG2452 from TP-LINK provides wire-speed performance and full set of layer 2 management features. It provides a variety of service features and multiple powerful functions with high security.

The EIA-standardized framework and smart configuration capacity can provide flexible solutions for a variable scale of networks. QoS and IGMP/MLD snooping/filtering optimize voice and video application. Link aggregation (LACP) increase aggregated bandwidth, optimizing the transport of business critical data. SNMP/SNMPv6, RMON, WEB/CLI/Telnet Log-in bring abundant management policies. TL-SG2216/TL-SG2424/TL-SG2424P/TL-SG2452 switch integrates multiple functions with excellent performance, and is friendly to manage, which can fully meet the need of the users demanding higher networking performance.

2.2 Main Features

- **Resiliency and Availability**

- + IEEE 802.1s Multiple Spanning Tree provides high link availability in multiple VLAN environments.
- + IGMP snooping and MLD snooping automatically prevents flooding of IP multicast traffic.
- + Root Guard protects root bridge from malicious attack or configuration mistakes

- **Layer 2 Switching**

- + Supports up to 512 VLANs simultaneously (out of 4K VLAN IDs).

- **Quality of Service**

- + Supports L2/L3 granular CoS with 4 priority queues per port.
- + Rate limiting confines the traffic flow accurately according to the preset value.

- **Manageability**

- + Supports Telnet, SNMP v1/v2c/v3, RMON and web access.
- + Port Mirroring enables monitoring selected ingress/egress traffic.
- + Simple Network and Management Protocol (SNMP) can be configured over IPv6 transport.
- + IPv6 supports stateless autoconfiguration to manage link, subnet, and site addressing changes.
- + DHCPv6 enables switch to receive configuration parameters, such as IPv6 network addresses from DHCPv6 servers.

2.3 Appearance Description

2.3.1 Front Panel

The front panel of TL-SG2216 is shown as Figure 2-1.



Figure 2-1 Front Panel of TL-SG2216

The front panel of TL-SG2424 is shown as Figure 2-2.



Figure 2-2 Front Panel of TL-SG2424

The front panel of TL-SG2424P is shown as Figure 2-3.

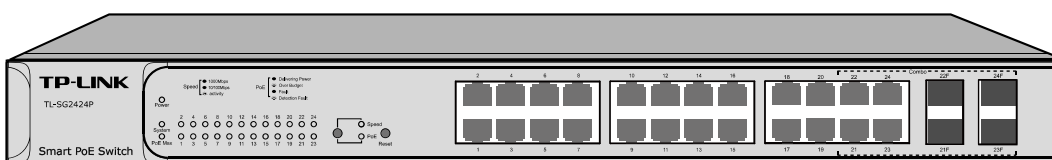

Figure 2-3 Front Panel of TL-SG2424P

The front panel of TL-SG2452 is shown as Figure 2-4.

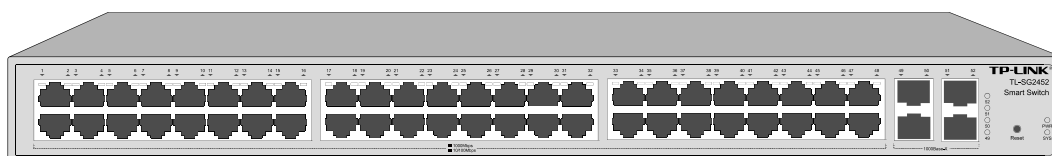

Figure 2-4 Front Panel of TL-SG2452

The following parts are located on the front panel of TL-SG2216/TL-SG2424/TL-SG2424P/TL-SG2452:

- **Reset:** Press this button for five seconds or above to reset the software setting back to factory default setting.
- **10/100/1000Mbps Ports:** Designed to connect to the device with a bandwidth of 10Mbps, 100Mbps or 1000Mbps. Each has a corresponding 1000Mbps LED and link/Act LED.
- **SFP Ports:** Designed to install the SFP module. TL-SG2216/TL-SG2424/TL-SG2424P switch features some SFP transceiver slots that are shared with the associated RJ45 ports. The associated two ports are referred to as “combo” ports, which means they cannot be used simultaneously, otherwise only SFP ports work. TL-SG2452 features 4 individual SFP ports.



Note:

The SFP port can only be used with a gigabit module.

➤ **LEDs**

For TL-SG2216/TL-SG2424:

Name	Status	Indication
Power	On	Power is on.
	Flashing	Power supply is abnormal.
	Off	Power is off or power supply is abnormal.
System	On	The switch is working abnormally.
	Flashing	The switch is working normally.
	Off	The switch is working abnormally.
1000Mbps	On	A 1000Mbps device is connected to the corresponding port.
	Off	A 10/100Mbps device or no device is connected to the corresponding port.
Link/Act	On	A device is connected to the corresponding port but no activity.
	Flashing	Data is being transmitted or received.
	Off	No device is connected to the corresponding port.

For TL-SG2424P:

TL-SG2424P has a LED mode switch button which is for switching the LED status indication. When the Speed LED is on, the port LED is indicating the data transmission rate. When the PoE LED is on, the port LED is indicating the power supply status. By default the Speed LED is on. Pressing the mode switch button, the Speed LED will turn off and the PoE LED will light up. Then the PoE LED will turn off after being on for 60 seconds and the Speed LED will light up again.

When the Speed LED is on, the port LED is indicating the data transmission rate.

Name	Status	Indication	
Power	On	The switch is powered on.	
	Off	The switch is powered off or power supply is abnormal.	
	Flashing	Power supply is abnormal.	
System	Flashing	The switch works properly.	
	On/Off	The switch works improperly.	
10/100/1000Mbps	Green	On	A 1000Mbps device is connected to the corresponding port, but no activity.
		Flashing	Data is being transmitted or received.
	Yellow	On	A 10/100Mbps device is connected to the corresponding port, but no activity.
		Flashing	Data is being transmitted or received.
	Off	No device is connected to the corresponding port.	

When the PoE LED is on, the port LED is indicating the power supply status.

Name	Status	Indication	
Power	On	The switch is powered on.	
	Off	The switch is powered off or power supply is abnormal.	
	Flashing	Power supply is abnormal.	
System	Flashing	The switch works properly.	
	On/Off	The switch works improperly.	
PoE Max	On	The remaining PoE power $\leq 7W$.	
	Flashing	The remaining PoE power keeps $\leq 7W$ after this LED is on for 2 minutes.	
	Off	The remaining PoE power $\geq 7W$.	
10/100/1000Mbps	Green	On	The port is supplying power normally.
		Flashing	The supply power exceeds the corresponding port's maximum power.
	Yellow	On	Overload or short circuit is detected.
		Flashing	Power-on self-test has failed.
	Off	No PoE power supply is provided on the port.	

For TL-SG2452:

Name	Status	Indication	
PWR	On	Power is on.	
	Flashing	Power supply is abnormal.	
	Off	Power is off or power supply is abnormal.	
SYS	On	The switch is working abnormally.	
	Flashing	The switch is working normally.	
	Off	The switch is working abnormally.	
10/100/1000Mbps	Green	On	A 1000Mbps device is connected to the corresponding port but no activity.
		Flashing	Data is being transmitted or received.
	Yellow	On	A 10/100Mbps device is connected to the corresponding port but no activity.
		Flashing	Data is being transmitted or received.
	Off	No device is connected to the corresponding port.	

2.3.2 Rear Panel

The rear panel of TL-SG2216/TL-SG2424/TL-SG2424P/TL-SG2452 features a power socket and a Grounding Terminal (marked with⊕), here we take TL-SG2216 for example.

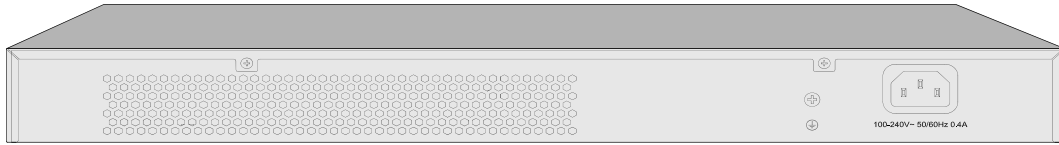

Figure 2-5 Rear Panel

- **Grounding Terminal:** The switch already comes with Lightning Protection Mechanism. You can also ground the switch through the PE (Protecting Earth) cable of AC cord or with Ground Cable.
- **AC Power Socket:** Connect the female connector of the power cord here, and the male connector to the AC power outlet. Please make sure the voltage of the power supply meets the requirement of the input voltage (100-240V~ 50/60Hz 0.4A for TL-SG2216, 100-240V~ 50/60Hz 0.5A for TL-SG2424, 100-240V~ 50/60Hz 3.5A for TL-SG2424P and 100-240V~ 50/60Hz 1.0A for TL-SG2452).

[Return to CONTENTS](#)

Chapter 3 Login to the Switch

3.1 Login

- 1) To access the configuration utility, open a web-browser and type in the default address `http://192.168.0.1` in the address field of the browser, then press the **Enter** key.



Figure 3-1 Web-browser



Tips:

To log in to the switch, the IP address of your PC should be set in the same subnet addresses of the switch. The IP address is 192.168.0.x ("x" is any number from 2 to 254), Subnet Mask is 255.255.255.0. For the detailed instructions as to how to do this, please refer to [Appendix B](#).

- 2) After a moment, a login window will appear, as shown in Figure 3-2. Enter **admin** for the User Name and Password, both in lower case letters. Then click the **Login** button or press the **Enter** key.

A screenshot of a web-based login page for TP-LINK. At the top, there is a dark blue header with the "TP-LINK" logo in white. Below the header, the page has a light blue background. In the center, there are two input fields. The first is labeled "User Name:" and contains the text "admin". The second is labeled "Password:" and contains six black dots. Below these fields are two buttons: "Login" and "Clear".

Figure 3-2 Login

3.2 Configuration

After a successful login, the main page will appear as Figure 3-6, and you can configure the function by clicking the setup menu on the left side of the screen.

The screenshot shows the TP-LINK web interface for the TL-SG2424 switch. The top navigation bar includes tabs for System Summary, Device Description, System Time, Daylight Saving Time, System IP, and System IPv6. The left sidebar contains a menu with categories like System, System Info, User Management, System Tools, Access Security, Switching, VLAN, Spanning Tree, Multicast, QoS, ACL, Network Security, SNMP, Maintenance, and Logout. The 'Save Config' option is highlighted with a red box. The main content area displays a port status diagram and a System Info table.

System Info	
System Description:	24-Port Gigabit Smart Switch with 4 Combo SFP Slots
Device Name:	TL-SG2424
Device Location:	SHENZHEN
System Contact:	www.tp-link.com
Hardware Version:	TL-SG2424 2.0
Firmware Version:	1.0.6 Build 20141119 Rel.60938(s)
IP Address:	192.168.0.1
Subnet Mask:	255.255.255.0
Default Gateway:	
MAC Address:	00-0A-EB-13-12-6D
System Time:	2006-01-01 08:03:07
Run Time:	0 day - 0 hour - 3 min - 17 sec

Figure 3-3 Main Setup-Menu

Note:

Clicking **Apply** can only make the new configurations effective before the switch is rebooted. If you want to keep the configurations effective even the switch is rebooted, please click **Save Config**. You are suggested to click **Save Config** before cutting off the power or rebooting the switch to avoid losing the new configurations.

[Return to CONTENTS](#)

Chapter 4 System

The System module is mainly for system configuration of the switch, including four submenus: **System Info**, **User Management**, **System Tools** and **Access Security**.

4.1 System Info

The System Info, mainly for basic properties configuration, can be implemented on **System Summary**, **Device Description**, **System Time**, **Daylight Saving Time**, **System IP** and **System IPv6** pages.

4.1.1 System Summary

On this page you can view the port connection status and the system information.

The port status diagram shows the working status of 24 10/100/1000Mbps RJ45 ports and 4 SFP ports of the switch.

Choose the menu **System**→**System Info**→**System Summary** to load the following page.

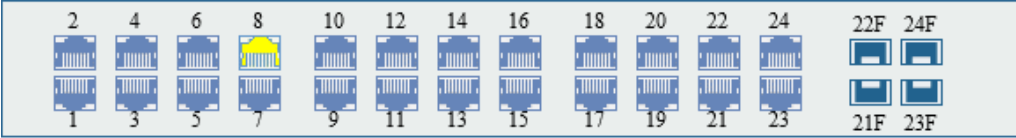

System Info	
System Description:	24-Port Gigabit Smart Switch with 4 Combo SFP Slots
Device Name:	TL-SG2424
Device Location:	SHENZHEN
System Contact:	www.tp-link.com
Hardware Version:	TL-SG2424 2.0
Firmware Version:	1.0.6 Build 20141119 Rel.60938(s)
IP Address:	192.168.0.1
Subnet Mask:	255.255.255.0
Default Gateway:	
MAC Address:	00-0A-EB-13-12-6D
System Time:	2006-01-01 08:03:07
Run Time:	0 day - 0 hour - 3 min - 17 sec

Figure 4-1 System Summary

> Port Status



Indicates the 1000Mbps port is not connected to a device.



Indicates the 1000Mbps port is at the speed of 1000Mbps.



Indicates the 1000Mbps port is at the speed of 10Mbps or 100Mbps.



Indicates the SFP port is not connected to a device.



Indicates the SFP port is at the speed of 1000Mbps.

When the cursor moves on the port, the detailed information of the port will be displayed.

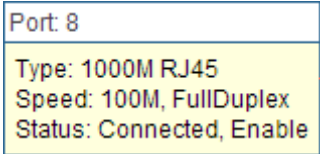

Figure 4-2 Port Information

> **Port Info**

- Port:** Displays the port number of the switch.
- Type:** Displays the type of the port.
- Rate:** Displays the maximum transmission rate of the port.
- Status:** Displays the connection status of the port.

Click a port to display the bandwidth utilization on this port. The actual rate divided by theoretical maximum rate is the bandwidth utilization. The following figure displays the bandwidth utilization monitored every four seconds. Monitoring the bandwidth utilization on each port facilitates you to monitor the network traffic and analyze the network abnormalities.

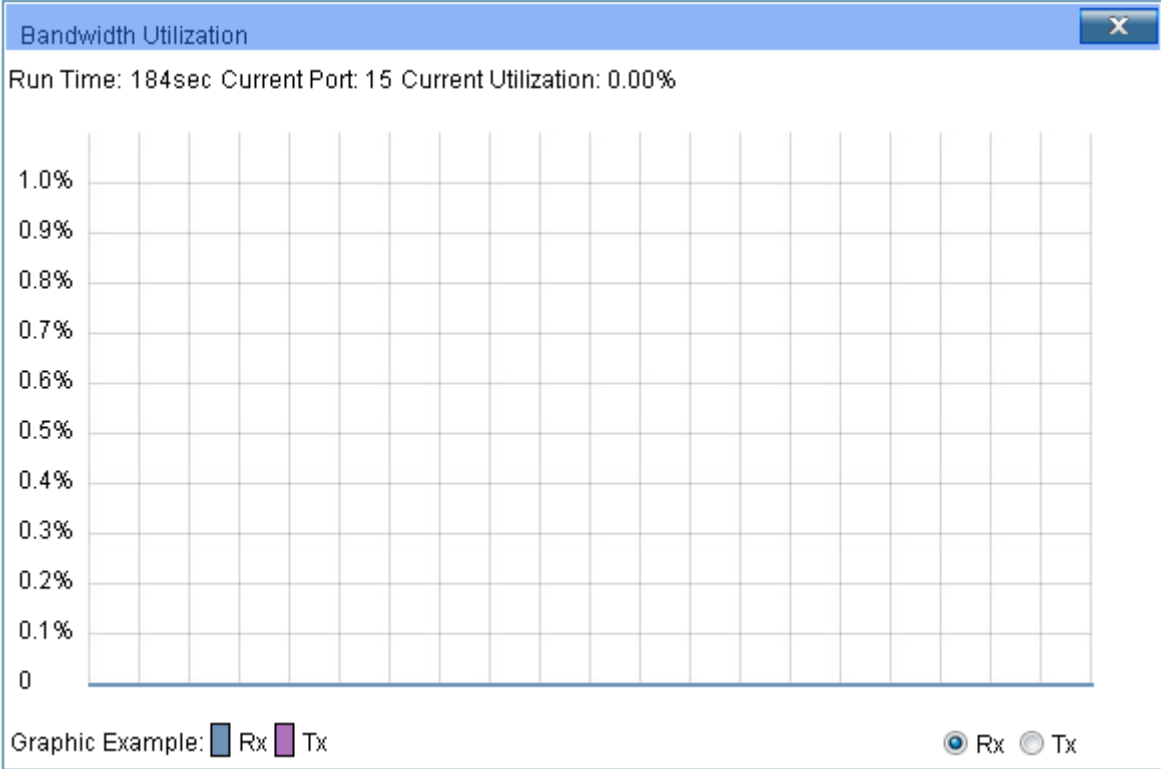

Figure 4-3 Bandwidth Utilization

> **Bandwidth Utilization**

- Rx:** Select Rx to display the bandwidth utilization of receiving packets on this port.
- Tx:** Select Tx to display the bandwidth utilization of sending packets on this port.

4.1.2 Device Description

On this page you can configure the description of the switch, including device name, device location and system contact.

Choose the menu **System**→**System Info**→**Device Description** to load the following page.



Device Description

Device Name:

Device Location:

System Contact:

Apply

Note:

The Device Name, Location and Contact should be not more than 32 characters.

Figure 4-4 Device Description

The following entries are displayed on this screen:

➤ **Device Description**

- Device Name:** Enter the name of the switch.
- Device Location:** Enter the location of the switch.
- System Contact:** Enter your contact information.

4.1.3 System Time

System Time is the time displayed while the switch is running. On this page you can configure the system time and the settings here will be used for other time-based functions.

You can manually set the system time or synchronize with PC's clock as the system time.

Choose the menu **System**→**System Info**→**System Time** to load the following page.

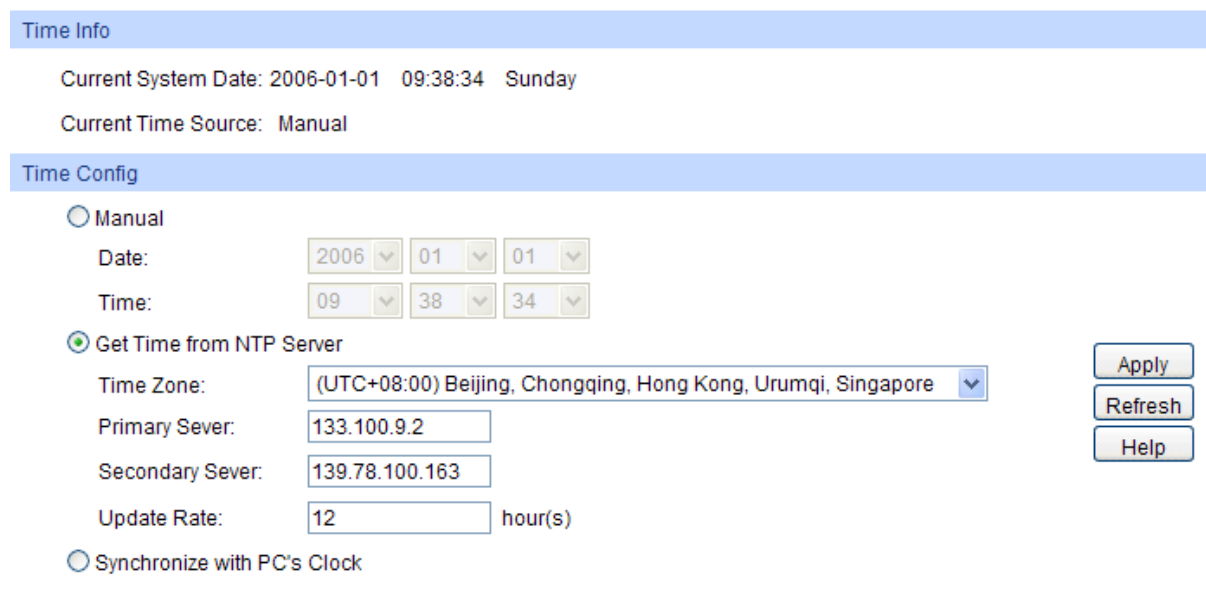

Time Info

Current System Date: 2006-01-01 09:38:34 Sunday

Current Time Source: Manual

Time Config

Manual

Date:

Time:

Get Time from NTP Server

Time Zone:

Primary Sever:

Secondary Sever:

Update Rate: hour(s)

Synchronize with PC's Clock

Apply

Refresh

Help

Figure 4-5 System Time

The following entries are displayed on this screen:

➤ **Time Info**

Current System Date: Displays the current date and time of the switch.

Current Time Source: Displays the current time source of the switch.

➤ **Time Config**

Manual: When this option is selected, you can set the date and time manually.

Get Time from NTP Server: When this option is selected, you can configure the time zone and the IP Address for the NTP Server. The switch will get UTC automatically if it has connected to an NTP Server.

- **Time Zone:** Select your local time.
- **Primary/Secondary Server:** Enter the IP Address for the NTP Server.
- **Update Rate:** Specify the rate fetching time from NTP server.

Synchronize with PC'S Clock: When this option is selected, the administrator PC's clock is utilized.



Note:

1. The system time will be restored to the default when the switch is restarted and you need to reconfigure the system time of the switch.
2. When Get Time from NTP Server is selected and no time server is configured, the switch will get time from the time server of the Internet if it has connected to the Internet.

4.1.4 Daylight Saving Time

Here you can configure the Daylight Saving Time of the switch.

Choose the menu **System**→**System Info**→**Daylight Saving Time** to load the following page.

DST Config

DST Status:

Predefined Mode

USA Australia Europe New Zealand

Recurring Mode

Offset: (minutes)

Start Time: Week Day Month

End Time: Week Day Month

Date Mode

Offset: (minutes)

Start Time: (MM/DD HH:MM)

End Time: (MM/DD HH:MM)

Figure 4-6 Daylight Saving Time

The following entries are displayed on this screen:

➤ **DST Config**

- DST Status:** Enable or disable the DST.
- Predefined Mode:** Select a predefined DST configuration.
- USA: Second Sunday in March, 02:00 ~ First Sunday in November, 02:00.
 - Australia: First Sunday in October, 02:00 ~ First Sunday in April, 03:00.
 - Europe: Last Sunday in March, 01:00 ~ Last Sunday in October, 01:00.
 - New Zealand: Last Sunday in September, 02:00 ~ First Sunday in April, 03:00.
- Recurring Mode:** Specify the DST configuration in recurring mode. This configuration is recurring in use.
- Offset: Specify the time adding in minutes when Daylight Saving Time comes.
 - Start/End Time: Select starting time and ending time of Daylight Saving Time.
- Date Mode:** Specify the DST configuration in Date mode. This configuration is recurring in use.
- Offset: Specify the time adding in minutes when Daylight Saving Time comes.
 - Start/End Time: Select starting time and ending time of Daylight Saving Time.



Note:

1. When the DST is disabled, the predefined mode, recurring mode and date mode cannot be configured.
2. When the DST is enabled, the default daylight saving time is of European in predefined mode.

4.1.5 System IP

Each device in the network possesses a unique IP Address. You can log on to the Web management page to operate the switch using this IP Address. The switch supports three modes to obtain an IP address: Static IP, DHCP and BOOTP. The IP address obtained using a new mode will replace the original IP address. On this page you can configure the system IP of the switch.

Choose the menu **System**→**System Info**→**System IP** to load the following page.

IP Config	
MAC Address:	6C-62-6D-F5-AC-BB
IP Address Mode:	<input checked="" type="radio"/> Static IP <input type="radio"/> DHCP <input type="radio"/> BOOTP
Management VLAN:	<input type="text" value="1"/> (VLAN ID: 1-4094)
IP Address:	<input type="text" value="192.168.0.1"/>
Subnet Mask:	<input type="text" value="255.255.255.0"/>
Default Gateway:	<input type="text"/>

Note:

Changing IP address to a different IP segment will interrupt the network communication, so please keep the new IP address in the same IP segment with the local network.

Figure 4-7 System IP

The following entries are displayed on this screen:

➤ **IP Config**

MAC Address: Displays MAC Address of the switch.

IP Address Mode: Select the mode to obtain IP Address for the switch.

- **Static IP:** When this option is selected, you should enter IP Address, Subnet Mask and Default Gateway manually.
- **DHCP:** When this option is selected, the switch will obtain network parameters from the DHCP Server.
- **BOOTP:** When this option is selected, the switch will obtain network parameters from the BOOTP Server.

Management VLAN: Enter the ID of management VLAN, the only VLAN through which you can get access to the switch. By default VLAN1 owning all the ports is the Management VLAN and you can access the switch via any port on the switch. However, if another VLAN is created and set to be the Management VLAN, you may have to reconnect the management station to a port that is a member of the Management VLAN.

IP Address: Enter the system IP of the switch. The default system IP is 192.168.0.1 and you can change it appropriate to your needs.

Subnet Mask: Enter the subnet mask of the switch.

Default Gateway: Enter the default gateway of the switch.



Note:

1. Changing the IP address to a different IP segment will interrupt the network communication, so please keep the new IP address in the same IP segment with the local network.
2. The switch only possesses one IP address. The IP address configured will replace the original IP address.
3. If the switch gets the IP address from DHCP server, you can see the configuration of the switch in the DHCP server; if DHCP option is selected but no DHCP server exists in the network, a few minutes later, the switch will restore the setting to the default.

4. If DHCP or BOOTP option is selected, the switch will get network parameters dynamically from the Internet, which means that IP address, subnet mask and default gateway cannot be configured.
5. By default, the IP address is 192.168.0.1.

4.1.6 System IPv6

IPv6 (Internet Protocol version 6), also called IPng (IP next generation), was developed by the IETF (Internet Engineering Task Force) as the successor to IPv4 (Internet Protocol version 4). Compared with IPv4, IPv6 increases the IP address size from 32 bits to 128 bits; this solves the IPv4 address exhaustion problem.

➤ IPv6 features

IPv6 has the following features:

1. **Adequate address space:** The source and destination IPv6 addresses are both 128 bits (16 bytes) long. IPv6 can provide 3.4×10^{38} addresses to completely meet the requirements of hierarchical address division as well as allocation of public and private addresses.
2. **Header format simplification:** IPv6 cuts down some IPv4 header fields or move them to IPv6 extension headers to reduce the load of basic IPv6 headers, thus making IPv6 packet handling simple and improving the forwarding efficiency. Although the IPv6 address size is four times that of IPv4 addresses, the size of basic IPv6 headers is 40 bytes and is only twice that of IPv4 headers (excluding the Options field).
3. **Flexible extension headers:** IPv6 cancels the Options field in IPv4 packets but introduces multiple extension headers. In this way, IPv6 enhances the flexibility greatly to provide scalability for IP while improving the handling efficiency. The Options field in IPv4 packets contains 40 bytes at most, while the size of IPv6 extension headers is restricted by that of IPv6 packets.
4. **Built-in security:** IPv6 uses IPSec as its standard extension header to provide end-to-end security. This feature provides a standard for network security solutions and improves the interoperability between different IPv6 applications.
5. **Automatic address configuration:** To simplify the host configuration, IPv6 supports stateful and stateless address configuration.
 - Stateful address configuration means that a host acquires an IPv6 address and related information from a server (for example, DHCP server).
 - Stateless address configuration means that a host automatically configures an IPv6 address and related information on basis of its own link-layer address and the prefix information advertised by a router.

In addition, a host can generate a link-local address on basis of its own link-layer address and the default prefix (FE80::/64) to communicate with other hosts on the link.

6. **Enhanced neighbor discovery mechanism:** The IPv6 neighbor discovery protocol is a group of Internet control message protocol version 6 (ICMPv6) messages that manages the information exchange between neighbor nodes on the same link. The group of ICMPv6

messages takes the place of Address Resolution Protocol (ARP) message, Internet Control Message Protocol version 4 (ICMPv4) router discovery message, and ICMPv4 redirection message to provide a series of other functions.

➤ Introduction to IPv6 address

1. IPv6 address format

An IPv6 address is represented as a series of 16-bit hexadecimal, separated by colons (:). An IPv6 address is divided into eight groups, and the 16 bits of each group are represented by four hexadecimal numbers which are separated by colons, for example, 2001:0d02:0000:0000:0014: 0000:0000:0095. The hexadecimal letters in IPv6 addresses are not case-sensitive.

To simplify the representation of IPv6 addresses, zeros in IPv6 addresses can be handled as follows:

- Leading zeros in each group can be removed. For example, the above-mentioned address can be represented in shorter format as 2001:d02:0:0:14:0:0:95.
- Two colons (::) may be used to compress successive hexadecimal fields of zeros at the beginning, middle, or end of an IPv6 address. For example, the above-mentioned address can be represented in the shortest format as 2001:d02::14:0:0:95.



Note:

Two colons (::) can be used only once in an IPv6 address, usually to represent the longest successive hexadecimal fields of zeros. If two colons are used more than once, the device is unable to determine how many zeros double-colons represent when converting them to zeros to restore a 128-bit IPv6 address.

An IPv6 address consists of two parts: address prefix and interface ID. The address prefix and the interface ID are respectively equivalent to the network ID and the host ID in an IPv4 address.

An IPv6 address prefix is represented in "IPv6 address/prefix length" format, where "IPv6 address" is an IPv6 address in any of the above-mentioned formats and "prefix length" is a decimal number indicating how many leftmost bits from the preceding IPv6 address are used as the address prefix.

2. IPv6 address classification

IPv6 addresses fall into three types: unicast address, multicast address, and anycast address.

- Unicast address: An identifier for a single interface, on a single node. A packet that is sent to a unicast address is delivered to the interface identified by that address.
- Multicast address: An identifier for a set of interfaces (typically belonging to different nodes), similar to an IPv4 multicast address. A packet sent to a multicast address is delivered to all interfaces identified by that address. There are no broadcast addresses in IPv6. Their function is superseded by multicast addresses.

- Anycast address: An identifier for a set of interfaces (typically belonging to different nodes). A packet sent to an anycast address is delivered to one of the interfaces identified by that address (the nearest one, according to the routing protocols' measure of distance).

The type of an IPv6 address is designated by the first several bits called format prefix. The following table lists the mappings between address types and format prefixes.

Type		Format Prefix (binary)	IPv6 Prefix ID
Unicast address	Unassigned address	00...0 (128 bits)	::/128
	Loopback address	00...1 (128 bits)	::1/128
	Link-local address	1111111010	FE80::/10
	Site-local address	1111111011	FEC0::/10
	Global unicast address (currently assigned)	001	2xxx::/4 or 3xxx::/4
	Reserved type (to be assigned in future)	Other formats	
Multicast address		11111111	FF00::/8
Anycast address		Anycast addresses are taken from unicast address space and are not syntactically distinguishable from unicast addresses.	

Table 4-1 Mappings between address types and format prefixes

3. IPv6 Unicast Address:

IPv6 unicast address is an identifier for a single interface. It consists of a subnet prefix and an interface ID.

- Subnet Prefix: This section is allocated by the IANA (The Internet Assigned Numbers Authority), the ISP (Internet Service Provider) or the organizations.
- Interface ID: An interface ID is used to identify interfaces on a link. The interface ID must be unique to the link.

There are several ways to form interface IDs. The IPv6 addresses with format prefixes 001 through 111, except for multicast addresses (1111 1111), are all required to have 64-bit interface IDs in EUI-64 format.

For all IEEE 802 interface types (for example, Ethernet and FDDI interfaces), Interface IDs in the modified EUI-64 format are constructed in the following way:

The first three octets (24 bits) are taken from the Organizationally Unique Identifier (OUI) of the 48-bit link-layer address (the MAC address) of the interface, the fourth and fifth octets (16 bits) are a fixed hexadecimal value of FFFE, and the last three octets (24 bits) are taken from the last three octets of the MAC address. The construction of the interface ID is completed by

setting the universal/local (U/L) bit—the seventh bit of the first octet—to a value of 0 or 1. A value of 0 indicates a locally administered identifier; a value of 1 indicates a globally unique IPv6 interface identifier.

Take MAC address 0012:0B0A:2D51 as an example. Insert **FFFE** to the middle of the address to get 0012:0BFF:FE0A:2D51. Then set the U/L bit to 1 to obtain an interface ID in EUI-64 format as 0212:0BFF:FE0A:2D51.

IPv6 unicast address can be classified into several types, as shown in Table 4-1. The two most common types are introduced below:

Global unicast address

A Global unicast address is an IPv6 unicast address that is globally unique and is routable on the global Internet.

Global unicast addresses are defined by a global routing prefix, a subnet ID, and an interface ID. The IPv6 global unicast address starts with binary value 001 (2000::/3). The global routing prefix is a value assigned to a site (a cluster of subnets/links) by IANA. The subnet ID is an identifier of a subnet within the site.

The figure below shows the structure of a global unicast address.

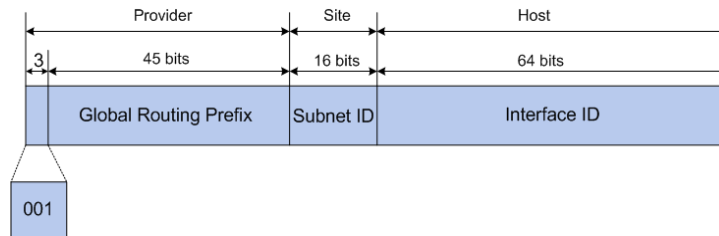

Figure 4-8 Global Unicast Address Format

Link-local address

A link-local address is an IPv6 unicast address that can be automatically configured on any interface using the link-local prefix FE80::/10 (1111 1110 10) and the interface identifier in the modified EUI-64 format. Link-local addresses are used in the neighbor discovery protocol and the stateless autoconfiguration process. Nodes on a local link can use link-local addresses to communicate. The figure below shows the structure of a link-local address.

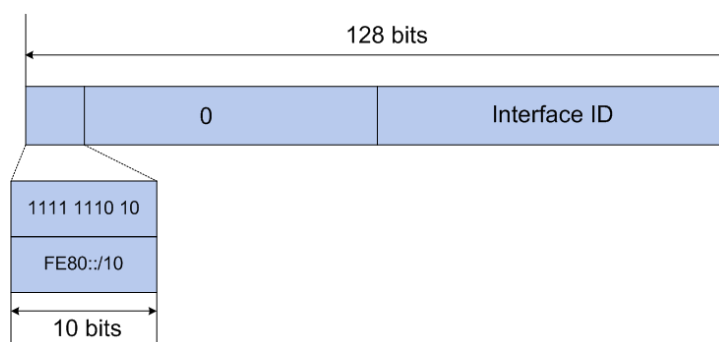

Figure 4-9 Link-local Address Format

IPv6 devices must not forward packets that have link-local source or destination addresses to other links.

Note:

You can configure multiple IPv6 addresses per interface, but only one link-local address.

➤ IPv6 Neighbor Discovery

The IPv6 neighbor discovery process uses ICMP messages and solicited-node multicast addresses to determine the link-layer address of a neighbor on the same network (local link), verify the reachability of a neighbor, and track neighboring devices.

1. IPv6 Neighbor Solicitation Message and Neighbor Advertisement Message

A value of 135 in the Type field of the ICMP packet header identifies a neighbor solicitation (NS) message. Neighbor solicitation messages are sent on the local link when a node wants to determine the link-layer address of another node on the same local link.

After receiving the neighbor solicitation message, the destination node replies by sending a neighbor advertisement (NA) message, which has a value of 136 in the Type field of the ICMP packet header, on the local link. After the source node receives the neighbor advertisement, the source node and destination node can communicate.

Neighbor advertisement messages are also sent when there is a change in the link-layer address of a node on a local link.

Address Resolution

The address resolution procedure is as follows:

- Node A multicasts an NS message. The source address of the NS message is the IPv6 address of an interface of node A and the destination address is the solicited-node multicast address of node B. The NS message contains the link-layer address of node A.
- After receiving the NS message, node B judges whether the destination address of the packet corresponds to the solicited-node multicast address. If yes, node B can learn the link-layer address of node A, and unicasts an NA message containing its link-layer address.
- Node A acquires the link-layer address of node B from the NA message.

Neighbor Reachability Detection

After node A acquires the link-layer address of its neighbor node B, node A can verify whether node B is reachable according to NS and NA messages.

- Node A sends an NS message whose destination address is the IPv6 address of node B.
- If node A receives an NA message from node B, node A considers that node B is reachable. Otherwise, node B is unreachable.

Duplicate Address Detection

Neighbor solicitation messages are used in the stateless autoconfiguration process to verify the uniqueness of unicast IPv6 addresses before the addresses are assigned to an interface. After node A acquires an IPv6 address, it will perform duplicate address detection (DAD) to determine whether the address is being used by other nodes (similar to the gratuitous ARP function of IPv4). DAD is accomplished through NS and NA messages. The DAD procedure is as follows:

- Node A sends an NS message whose source address is the unassigned address :: and destination address is the corresponding solicited-node multicast address of the IPv6 address to be detected. The NS message contains the IPv6 address.
- If node B uses this IPv6 address, node B returns an NA message. The NA message contains the IPv6 address of node B.
- Node A learns that the IPv6 address is being used by node B after receiving the NA message from node B. Otherwise, node B is not using the IPv6 address and node A can use it.

2. IPv6 Router Advertisement Message

Router advertisement (RA) messages, which have a value of 134 in the Type field of the ICMP packet header, are periodically sent out each configured interface of an IPv6 router.

RA messages typically include the following information:

- One or more onlink IPv6 prefixes that nodes on the local link can use to automatically configure their IPv6 addresses.
- Lifetime information for each prefix included in the advertisement.
- Sets of flags that indicate the type of autoconfiguration (stateless or stateful) that can be completed.
- Default router information (whether the device sending the advertisement should be used as a default router and, if so, the amount of time, in seconds, the device should be used as a default router).
- Additional information for hosts, such as the hop limit and maximum transmission unit (MTU) a host should use in packets that it originates.

RAs are also sent in response to device solicitation messages. Device solicitation messages, which have a value of 133 in the Type field of the ICMP packet header, are sent by hosts at system startup or anytime needed so that the host can immediately autoconfigure without needing to wait for the next scheduled RA message.

Hosts discover and select default devices by listening to Router Advertisements (RAs).

Stateless address autoconfiguration means that the node automatically configures an IPv6 address and other information for its interface according to the address prefix and other configuration parameters in the received RA messages.

3. IPv6 Neighbor Redirect Message

A value of 137 in the type field of the ICMP packet header identifies an IPv6 neighbor redirect message. Devices send neighbor redirect messages to inform hosts of better first-hop nodes on the path to a destination.

A device will send an IPv6 ICMP redirect message when the following conditions are satisfied:

- The receiving interface is the forwarding interface.
- The selected route itself is not created or modified by an IPv6 ICMP redirect message.
- The selected route is not the default route.
- The forwarded IPv6 packet does not contain any routing header.

You can configure the system's administrative IPv6 address on this page.

Choose the menu **System** → **System Info** → **System IPv6** to load the following page.

Global Config

IPv6: Enable Disable

Link-local Address Config

Config Mode: Manual Auto

Link-local Address: (Format: fe80::1)

Status: normal

Global Address Autoconfig via RA Message

Enable global address auto configuration via RA message

Global Address Autoconfig via DHCPv6 Server

Enable global address auto configuration via DHCPv6 Server

Add a global address manually

Address Format: EUI-64 Not EUI-64

Global Address: (Format: 3001::1/64)

Global address Table

Select	Global Address	Prefix Length	Type	Prefered Lifetime/Valid Lifetime	Status
<input type="checkbox"/>	<input type="text"/>	<input type="text"/>			

Figure 4-10 System IPv6

The following entries are displayed on this screen:

➤ **Global Config**

IPv6: Enable/Disable IPv6 function globally on the switch.

➤ **Link-local Address Config**

Config Mode: Select the link-local address configuration mode.

- **Manual:** When this option is selected, you should assign a link-local address manually.
- **Auto:** When this option is selected, the switch will generate a link-local address automatically.

Link-local Address: Enter a link-local address.

Status: Displays the status of the link-local address.

- **Normal:** Indicates that the link-local address is normal.
- **Try:** Indicates that the link-local address may be newly configured.
- **Repeat:** Indicates that the link-local address is duplicate. It is illegal to access the switch using the IPv6 address (including link-local and global address).

➤ **Global Address Autoconfig via RA Message**

Enable global address auto configuration via RA message: When this option is enabled, the switch automatically configures a global address and other information according to the address prefix and other configuration parameters from the received RA(Router Advertisement) message.

➤ **Global Address Autoconfig via DHCPv6 Server**

Enable Global Address Autoconfig via DHCPv6 Server: When this option is enabled, the system will try to obtain the global address from the DHCPv6 Server.

➤ **Add a global address manually**

Address Format: You can select the global address format according to your requirements.

- **EUI-64:** Indicates that you only need to specify an address prefix, and then the system will create a global address automatically.
- **Not EUI-64:** Indicates that you have to specify an intact global address.

Global Address: When selecting the mode of EUI-64, please input the address prefix here, otherwise, please input an intact IPv6 address here.

➤ **Global address Table**

Select: Select the desired entry to delete or modify the corresponding global address.

Global Address: Modify the global address.

Prefix Length: Modify the prefix length of the global address.

- Type:** Displays the configuration mode of the global address.
- **Manual:** Indicates that the corresponding address is configured manually.
 - **Auto:** Indicates that the corresponding address is created automatically using the RA message or obtained from the DHCPv6 Server.
- Preferred Lifetime/Valid Lifetime:** Displays the preferred time and valid time of the global address.
- Status:** Displays the status of the global address.
- **Normal:** Indicates that the global address is normal.
 - **Try:** Indicates that the global address may be newly configured.
 - **Repeat:** Indicates that the corresponding address is duplicate. It is illegal to access the switch using this address.



Tips:

After adding a global IPv6 address to your switch manually here, you can configure your PC's global IPv6 address in the same subnet with the switch and login to the switch via its global IPv6 address. For the detailed instructions, please refer to [Appendix B](#).

4.2 User Management

User Management functions to configure the user name and password for users to log on to the Web management page with a certain access level so as to protect the settings of the switch from being randomly changed.

The User Management function can be implemented on **User Table** and **User Config** pages.

4.2.1 User Table

On this page you can view the information about the current users of the switch.

Choose the menu **System**→**User Management**→**User Table** to load the following page.

User Table		
User ID	User Name	Access Level
1	admin	Admin

Figure 4-11 User Table

4.2.2 User Config

On this page you can configure the access level of the user to log on to the Web management page. The switch provides two access levels: Guest and Admin. The guest only can view the settings without the right to configure the switch; the admin can configure all the functions of the switch. The Web management pages contained in this guide are subject to the admin's login without any explanation.

Choose the menu **System**→**User Management**→**User Config** to load the following page.

User Info

User Name:

Access Level: Guest ▾

Password:

Confirm Password:

User Table

Select	User ID	User Name	Access Level	Operation
<input type="checkbox"/>	1	admin	Admin	Edit

Note:

The user name should not be more than 16 characters using digits, English letters and underlines only and password should not be more than 31 characters.

Figure 4-12 User Config

The following entries are displayed on this screen:

➤ **User Info**

- User Name:** Create a name for users' login.
- Access Level:** Select the access level to login.
- Admin: Admin can edit, modify and view all the settings of different functions.
 - Guest: Guest only can view the settings without the right to edit and modify.
- User Status:** Select Enable/Disable the user configuration.
- Password:** Type a password for users' login.
- Confirm Password:** Retype the password.
- Password Display Mode:**
- Simple: Select a simple password display mode.
 - Cipher: Select a cipher password display mode.

➤ **User Table**

- Select:** Select the desired entry to delete the corresponding user information. It is multi-optional. The current user information can't be deleted.
- User ID, Name, Access Level and status:** Displays the current user ID, user name, access level and user status.
- Operation:** Click the **Edit** button of the desired entry, and you can edit the corresponding user information. After modifying the settings, please click the **Modify** button to make the modification effective. Access level and user status of the current user information cannot be modified.

4.3 System Tools

The System Tools function, allowing you to manage the configuration file of the switch, can be implemented on **Config Restore**, **Config Backup**, **Firmware Upgrade**, **System Reboot** and **System Reset** pages.

4.3.1 Config Restore

On this page you can upload a backup configuration file to restore your switch to this previous configuration.

Choose the menu **System**→**System Tools**→**Config Restore** to load the following page.

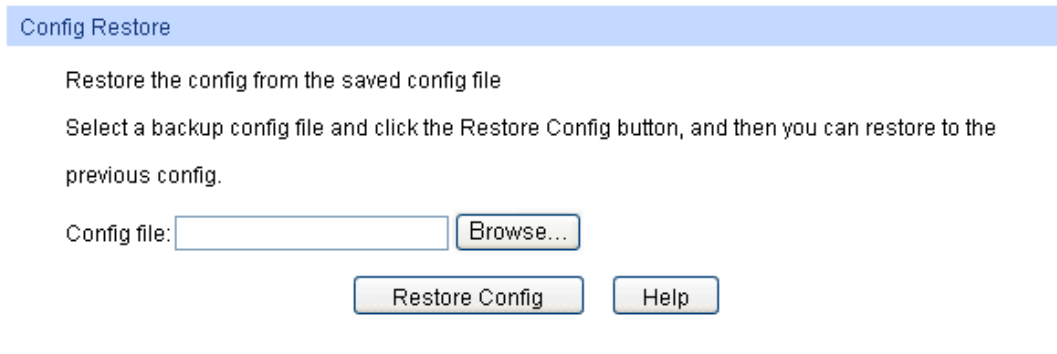

Config Restore

Restore the config from the saved config file

Select a backup config file and click the Restore Config button, and then you can restore to the previous config.

Config file:

Note:

It will take a long time to restore the config file. Please wait without any operation.

Figure 4-13 Config Restore

The following entries are displayed on this screen:

➤ **Config Restore**

Restore Config:

Click the **Restore Config** button to restore the backup configuration file. It will take effect after the switch automatically reboots.

**Note:**

1. It will take a few minutes to restore the configuration. Please wait without any operation.
2. To avoid any damage, please don't power down the switch while being restored.
3. After being restored, the current settings of the switch will be lost. Wrong uploaded configuration file may cause the switch unmanaged.

4.3.2 Config Backup

On this page you can download the current configuration and save it as a file to your computer for your future configuration restore.

Choose the menu **System**→**System Tools**→**Config Backup** to load the following page.

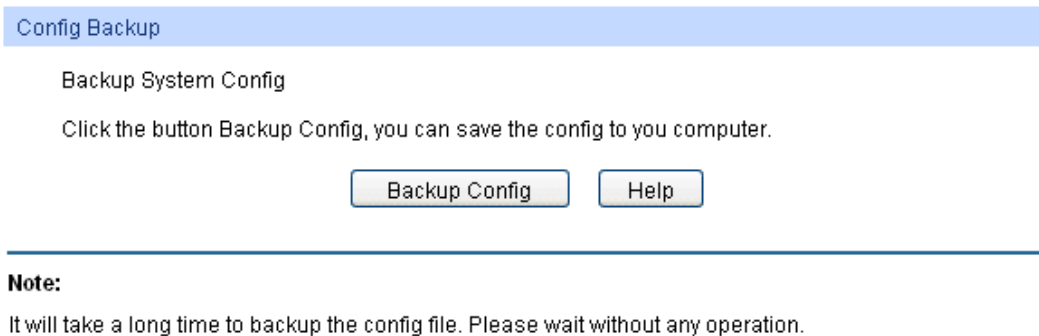



Figure 4-14 Config Backup

The following entries are displayed on this screen:

➤ **Config Backup**

Backup Config: Click the **Backup Config** button to save the current configuration as a file to your computer. You are suggested to take this measure before upgrading.

 **Note:**
It will take a few minutes to backup the configuration. Please wait without any operation.

4.3.3 Firmware Upgrade

The switch system can be upgraded via the Web management page. To upgrade the system is to get more functions and better performance. Go to <http://www.tp-link.com> to download the updated firmware.

Choose the menu **System**→**System Tools**→**Firmware Upgrade** to load the following page.

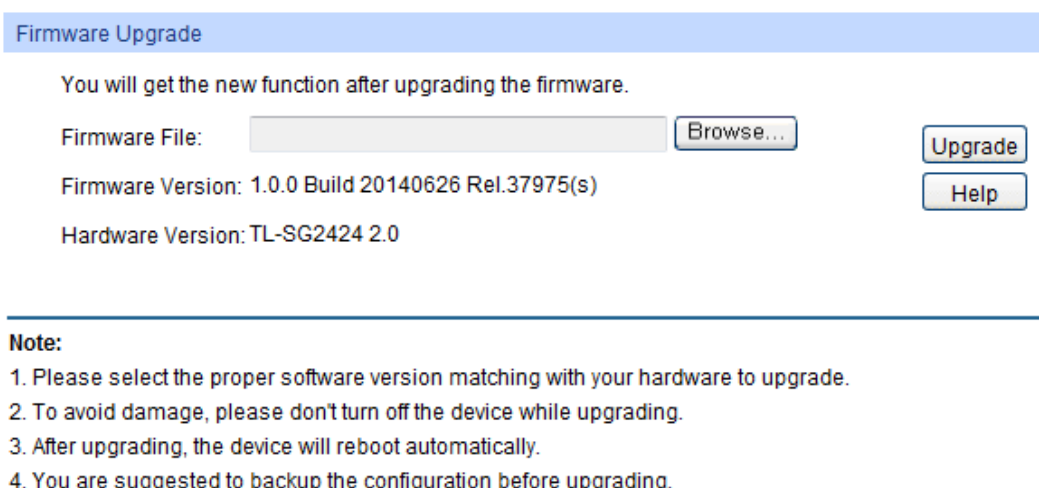



Figure 4-15 Firmware Upgrade

 **Note:**

1. Don't interrupt the upgrade.
2. Please select the proper software version matching with your hardware to upgrade.
3. To avoid damage, please don't turn off the device while upgrading.
4. After upgrading, the device will reboot automatically.
5. You are suggested to backup the configuration before upgrading.

4.3.4 System Reboot

On this page you can reboot the switch and return to the login page. Please save the current configuration before rebooting to avoid losing the configuration unsaved

Choose the menu **System**→**System Tools**→**System Reboot** to load the following page.

System Reboot

Save Config:

Reboot:

Note:
To avoid damage, please don't turn off the device while rebooting.

Figure 4-16 System Reboot



Note:

To avoid damage, please don't turn off the device while rebooting.

4.3.5 System Reset

On this page you can reset the switch to the default. All the settings will be cleared after the switch is reset.

Choose the menu **System**→**System Tools**→**System Reset** to load the following page.

System Reset

Reset:

Note:
The System Reset option will restore the configuration to default and your current settings will be lost.

Figure 4-17 System Reset



Note:

After the system is reset, the switch will be reset to the default and all the settings will be cleared.

4.4 Access Security

Access Security provides different security measures for the remote login so as to enhance the configuration management security. It can be implemented on **Access Control**, **SSL Config** and **SSH Config** pages.

4.4.1 Access Control

On this page you can control the users logging on to the Web management page to enhance the configuration management security. The definitions of Admin and Guest refer to [4.2 User Management](#).

Choose the menu **System**→**Access Security**→**Access Control** to load the following page.

Access Control Config

Control Mode:

IP Address: Mask:

MAC Address:

Port:

<input type="checkbox"/> 1	<input type="checkbox"/> 2	<input type="checkbox"/> 3	<input type="checkbox"/> 4	<input type="checkbox"/> 5	<input type="checkbox"/> 6	<input type="checkbox"/> 7	<input type="checkbox"/> 8
<input type="checkbox"/> 9	<input type="checkbox"/> 10	<input type="checkbox"/> 11	<input type="checkbox"/> 12	<input type="checkbox"/> 13	<input type="checkbox"/> 14	<input type="checkbox"/> 15	<input type="checkbox"/> 16
<input type="checkbox"/> 17	<input type="checkbox"/> 18	<input type="checkbox"/> 19	<input type="checkbox"/> 20	<input type="checkbox"/> 21	<input type="checkbox"/> 22	<input type="checkbox"/> 23	<input type="checkbox"/> 24

Session Config

Session Timeout: min (5-30)

Access User Number

Number Control: Enable Disable

Admin Number: (1-16)

Guest Number: (0-15)

Figure 4-18 Access Control

The following entries are displayed on this screen:

➤ **Access Control Config**

- Control Mode:** Select the control mode for users to log on to the Web management page.
- IP-based: Select this option to limit the IP-range of the users for login.
 - MAC-based: Select this option to limit the MAC Address of the users for login.
 - Port-based: Select this option to limit the ports for login.

IP Address & Mask These fields can be available for configuration only when IP-based mode is selected. Only the users within the IP-range you set here are allowed for login.

MAC Address: The field can be available for configuration only when MAC-based mode is selected. Only the user with this MAC Address you set here are allowed for login.

Port: The field can be available for configuration only when Port-based mode is selected. Only the users connected to these ports you set here are allowed for login.

➤ **Session Config**

Session Timeout: If you do nothing with the Web management page within the timeout time, the system will log out automatically. If you want to reconfigure, please login again.

➤ **Access User Number**

Number Control: Select Enable/Disable the Number Control function.

Admin Number: Enter the maximum number of the users logging on to the Web management page as Admin.

Guest Number: Enter the maximum number of the users logging on to the Web management page as Guest.

4.4.2 SSL Config

SSL (Secure Sockets Layer), a security protocol, is to provide a secure connection for the application layer protocol (e.g. HTTP) communication based on TCP. SSL is widely used to secure the data transmission between the Web browser and servers. It is mainly applied through ecommerce and online banking.

SSL mainly provides the following services:

1. Authenticate the users and the servers based on the certificates to ensure the data are transmitted to the correct users and servers;
2. Encrypt the data transmission to prevent the data being intercepted;
3. Maintain the integrality of the data to prevent the data being altered in the transmission.

Adopting asymmetrical encryption technology, SSL uses key pair to encrypt/decrypt information. A key pair refers to a public key (contained in the certificate) and its corresponding private key. By default the switch has a certificate (self-signed certificate) and a corresponding private key. The Certificate/Key Download function enables the user to replace the default key pair.

After SSL is effective, you can log on to the Web management page via <https://192.168.0.1>. For the first time you use HTTPS connection to log into the switch with the default certificate, you will be prompted that “The security certificate presented by this website was not issued by a trusted certificate authority” or “Certificate Errors”. Please add this certificate to trusted certificates or continue to this website.

The switch also supports HTTPS connection for IPv6. After configuring an IPv6 address (for example, 3001::1) for the switch, you can log on to the switch’s Web management page via [https://\[3001::1\]](https://[3001::1]).

On this page you can configure the SSL function.

Choose the menu **System**→**Access Security**→**SSL Config** to load the following page.

Global Config

SSL: Enable Disable

Certificate Download

Certificate File:

Key Download

Key File:

Note:

- 1.The SSL certificate and key downloaded will not take effect until the switch is rebooted.
- 2.The SSL certificate and key downloaded must match each other; otherwise the HTTPS connection will not work.

Figure 4-19 SSL Config

The following entries are displayed on this screen:

➤ **Global Config**

SSL: Select Enable/Disable the SSL function on the switch.

➤ **Certificate Download**

Certificate File: Select the desired certificate to download to the switch. The certificate must be BASE64 encoded.

➤ **Key Download**

Key File: Select the desired SSL Key to download to the switch. The key must be BASE64 encoded.



Note:

1. The SSL certificate and key downloaded must match each other; otherwise the HTTPS connection will not work.
2. The SSL certificate and key downloaded will not take effect until the switch is rebooted.
3. To establish a secured connection using https, please enter https:// into the URL field of the browser.
4. It may take more time for https connection than that for http connection, because https connection involves authentication, encryption and decryption etc.

4.4.3 SSH Config

As stipulated by IETF (Internet Engineering Task Force), SSH (Secure Shell) is a security protocol established on application and transport layers. SSH-encrypted-connection is similar to a telnet connection, but essentially the old telnet remote management method is not safe, because the password and data transmitted with plain-text can be easily intercepted. SSH can provide information security and powerful authentication when you log on to the switch remotely through

an insecure network environment. It can encrypt all the transmission data and prevent the information in a remote management being leaked.

Comprising server and client, SSH has two versions, V1 and V2 which are not compatible with each other. In the communication, SSH server and client can auto-negotiate the SSH version and the encryption algorithm. After getting a successful negotiation, the client sends authentication request to the server for login, and then the two can communicate with each other after successful authentication. This switch supports SSH server and you can log on to the switch via SSH connection using SSH client software.

SSH key can be downloaded into the switch. If the key is successfully downloaded, the certificate authentication will be preferred for SSH access to the switch.

Choose the menu **System**→**Access Security**→**SSH Config** to load the following page.

Global Config

SSH: Enable Disable

Protocol V1: Enable Disable

Protocol V2: Enable Disable

Idle Timeout: sec (1-120)

Max Connect: (1-5)

Key Download

Choose the SSH public key file to download into switch.

Key Type:

Key File:

Note:
It will take a long time to download the key file. Please wait without any operation.

Figure 4-20 SSH Config

The following entries are displayed on this screen:

➤ **Global Config**

- SSH:** Select Enable/Disable SSH function.
- Protocol V1:** Select Enable/Disable SSH V1 to be the supported protocol.
- Protocol V2:** Select Enable/Disable SSH V2 to be the supported protocol.
- Idle Timeout:** Specify the idle timeout time. The system will automatically release the connection when the time is up. The default time is 120 seconds.
- Max Connect:** Specify the maximum number of the connections to the SSH server. No new connection will be established when the number of the connections reaches the maximum number you set. The default value is 5.

➤ **Key Download**

Key Type: Select the type of SSH Key to download. The switch supports three types: SSH-1 RSA, SSH-2 RSA and SSH-2 DSA.

Key File: Select the desired key file to download.

Download: Click the **Download** button to download the desired key file to the switch.



Note:

1. Please ensure the key length of the downloaded file is in the range of 256 to 3072 bits.
2. After the Key File is downloaded, the user's original key of the same type will be replaced. The wrong uploaded file will result in the SSH access to the switch via Password authentication.

Application Example 1 for SSH:

➤ **Network Requirements**

1. Log on to the switch via password authentication using SSH and the SSH function is enabled on the switch.
2. PuTTY client software is recommended.

➤ **Configuration Procedure**

1. Open the software to log on to the interface of PuTTY. Enter the IP address of the switch into **Host Name** field; keep the default value 22 in the **Port** field; select **SSH** as the Connection type.

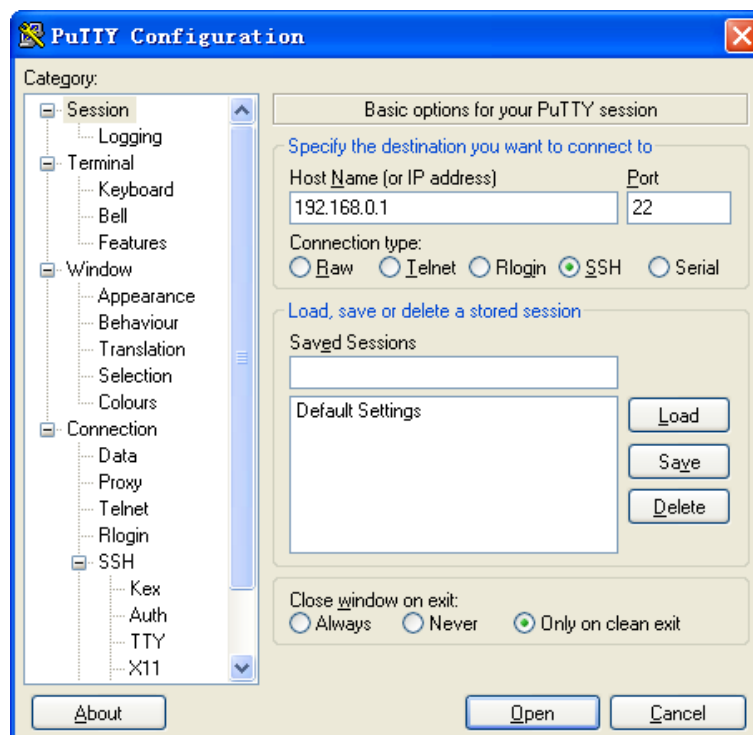

2. Click the **Open** button in the above figure to log on to the switch. Enter the login user name and password, and then you can continue to configure the switch.

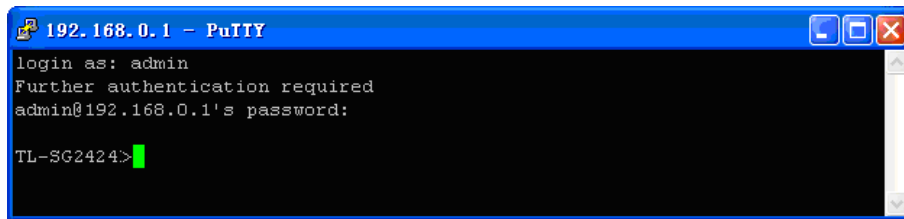

```
192.168.0.1 - PuTTY
login as: admin
Further authentication required
admin@192.168.0.1's password:
TL-SG2424>
```

Application Example 2 for SSH:

➤ Network Requirements

1. Log on to the switch via key authentication using SSH and the SSH function is enabled on the switch.
2. PuTTY client software is recommended.

➤ Configuration Procedure

1. Select the key type and key length, and generate SSH key.

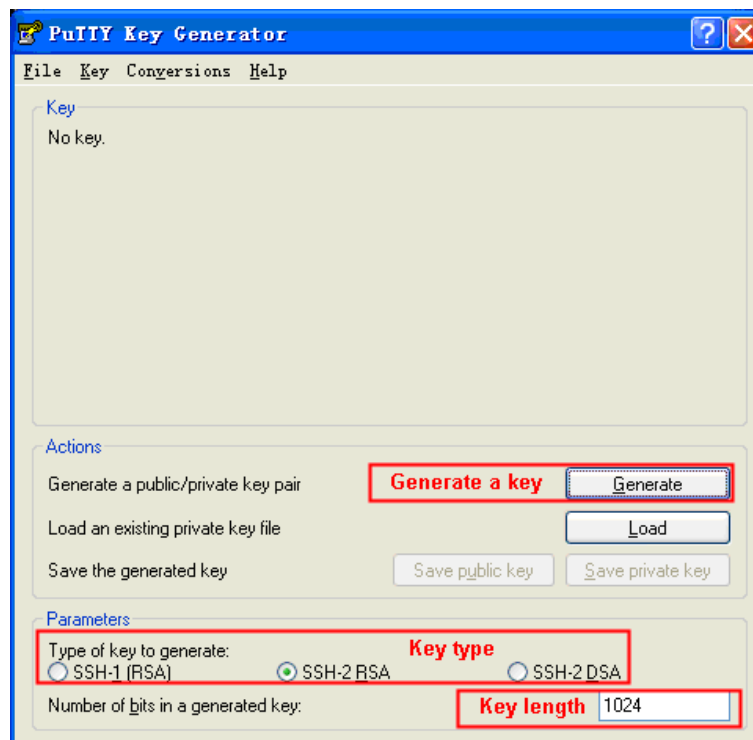

! Note:

1. The key length is in the range of 256 to 3072 bits.
2. During the key generation, randomly moving the mouse quickly can accelerate the key generation.

- After the key is successfully generated, please save the public key and private key to the computer.

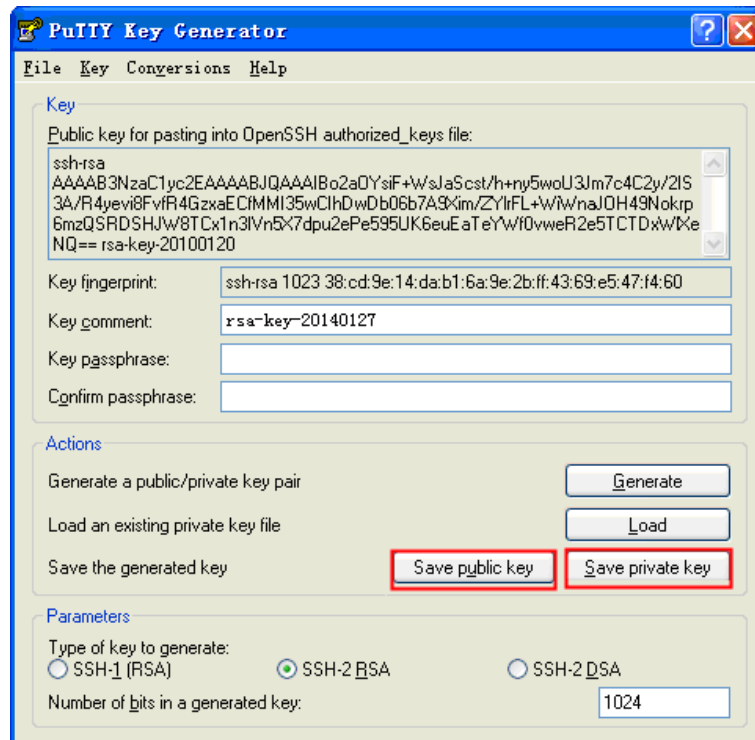

- On the Web management page of the switch, download the public key file saved in the computer to the switch.

Key Download

Choose the SSH public key file to download into switch.

Key Type:

Key File:

Note:

- The key type should accord with the type of the key file.
- The SSH key downloading cannot be interrupted.

4. After the public key and private key are downloaded, please log on to the interface of PuTTY and enter the IP address for login.

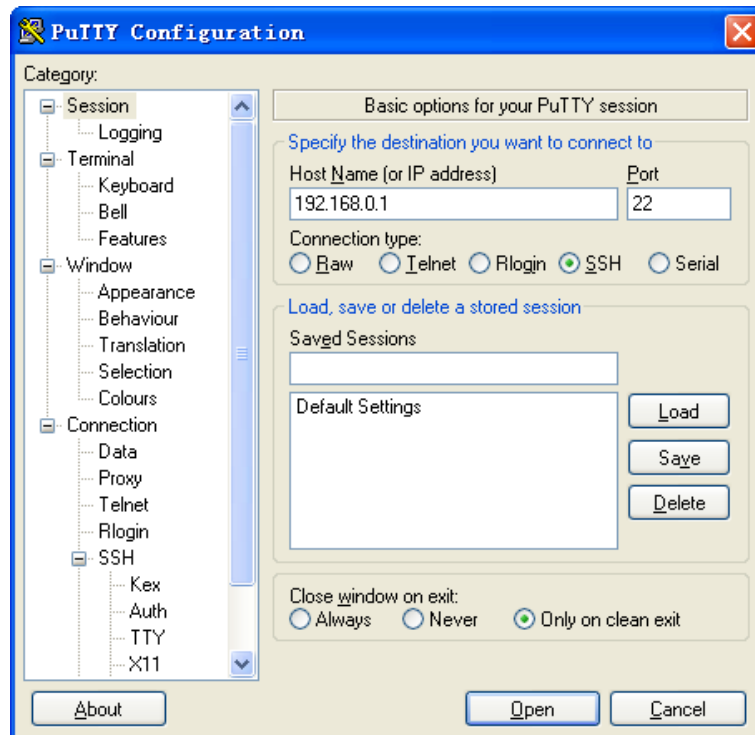

5. Click **Browse** to download the private key file to SSH client software and click **Open**.

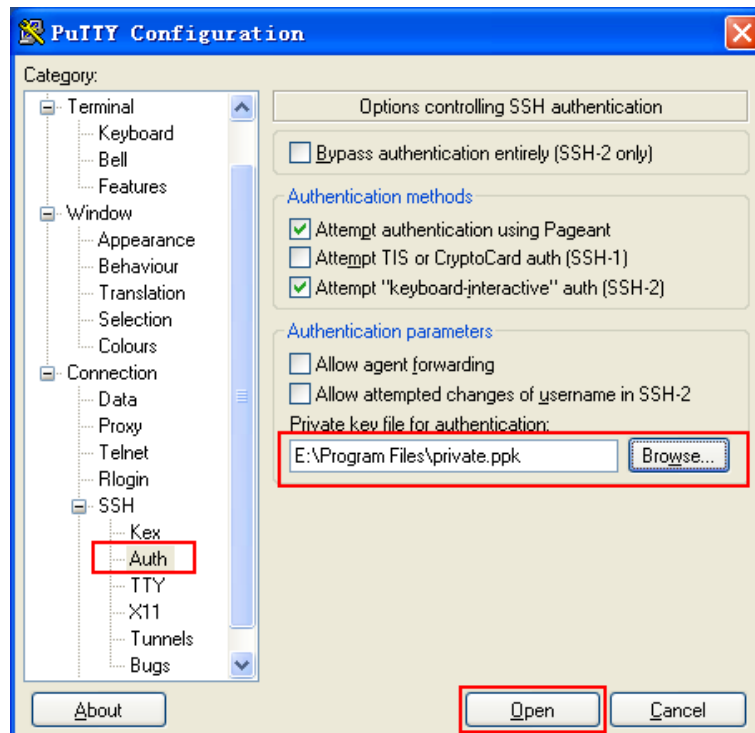

After successful authentication, please enter the login user name. If you log on to the switch without entering password, it indicates that the key has been successfully downloaded.

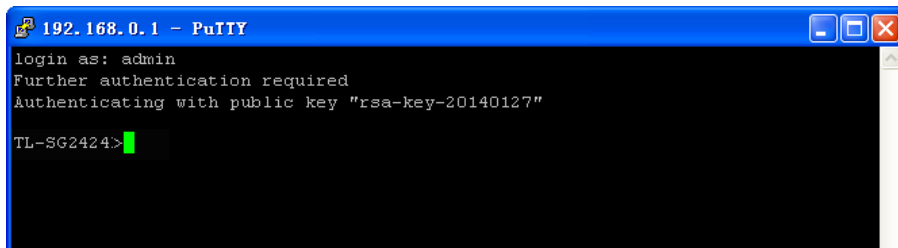
A screenshot of a PuTTY terminal window titled "192.168.0.1 - PuTTY". The terminal output shows the following text: "login as: admin", "Further authentication required", and "Authenticating with public key 'rsa-key-20140127'". Below this, the prompt "TL-SG2424>" is displayed with a green cursor. The window has standard Windows-style window controls (minimize, maximize, close) in the top right corner.

```
192.168.0.1 - PuTTY
login as: admin
Further authentication required
Authenticating with public key "rsa-key-20140127"
TL-SG2424>
```

[Return to CONTENTS](#)

Chapter 5 Switching

Switching module is used to configure the basic functions of the switch, including five submenus: **Port**, **LAG**, **Traffic Monitor**, **MAC Address** and **DHCP Filtering**.

5.1 Port

The Port function, allowing you to configure the basic features for the port, is implemented on the **Port Config**, **Port Mirror**, **Port Security**, **Port Isolation** and **Loopback Detection** pages.

5.1.1 Port Config

On this page, you can configure the basic parameters for the ports. When the port is disabled, the packets on the port will be discarded. Disabling the port which is vacant for a long time can reduce the power consumption effectively. And you can enable the port when it is in need.

The parameters will affect the working mode of the port, please set the parameters appropriate to your needs.

Choose the menu **Switching**→**Port**→**Port Config** to load the following page.

Select	Port	Description	Status	Speed and Duplex	Flow Control	LAG
<input type="checkbox"/>		<input type="text"/>	Disable	10MHD	Disable	
<input type="checkbox"/>	1		Enable	Auto	Disable	...
<input type="checkbox"/>	2		Enable	Auto	Disable	...
<input type="checkbox"/>	3		Enable	Auto	Disable	...
<input type="checkbox"/>	4		Enable	Auto	Disable	...
<input type="checkbox"/>	5		Enable	Auto	Disable	...
<input type="checkbox"/>	6		Enable	Auto	Disable	...
<input type="checkbox"/>	7		Enable	Auto	Disable	...
<input type="checkbox"/>	8		Enable	Auto	Disable	...
<input type="checkbox"/>	9		Enable	Auto	Disable	...
<input type="checkbox"/>	10		Enable	Auto	Disable	...
<input type="checkbox"/>	11		Enable	Auto	Disable	...
<input type="checkbox"/>	12		Enable	Auto	Disable	...
<input type="checkbox"/>	13		Enable	Auto	Disable	...
<input type="checkbox"/>	14		Enable	Auto	Disable	...
<input type="checkbox"/>	15		Enable	Auto	Disable	...

Note:

The Port Description should be not more than 16 characters.

Figure 5-1 Port Config

The following entries are displayed on this screen:

➤ **Port Config**

Port Select: Click the **Select** button to quick-select the corresponding port based on the port number you entered.

Select: Select the desired port for configuration. It is multi-optional.

Port: Displays the port number.

- Description:** Give a description to the port for identification.
- Status:** Allows you to Enable/Disable the port. When Enable is selected, the port can forward the packets normally.
- Speed and Duplex:** Select the Speed and Duplex mode for the port. The device connected to the switch should be in the same Speed and Duplex mode with the switch. When “Auto” is selected, the Speed and Duplex mode will be determined by auto-negotiation. For the SFP port, this switch does not support auto-negotiation.
- Flow Control:** Allows you to Enable/Disable the Flow Control feature. When Flow Control is enabled, the switch can synchronize the speed with its peer to avoid the packet loss caused by congestion.
- LAG:** Displays the LAG number which the port belongs to.



Note:

1. The switch cannot be managed through the disabled port. Please enable the port which is used to manage the switch.
2. The parameters of the port members in a LAG should be set as the same.
3. When using the SFP port with a 100M module or a gigabit module, you need to configure its corresponding **Speed and Duplex** mode. For 100M module, please select **100MFD** while select **1000MFD** for gigabit module. By default, the **Speed and Duplex** mode of SFP port is 1000MFD.

5.1.2 Port Mirror

Port Mirror, the packets obtaining technology, functions to forward copies of packets from one/multiple ports (mirrored port) to a specific port (mirroring port). Usually, the mirroring port is connected to a data diagnose device, which is used to analyze the mirrored packets for monitoring and troubleshooting the network.

Choose the menu **Switching**→**Port**→**Port Mirror** to load the following page.

Mirror Group List				
Group	Mirroring	Mode	Mirrored Port	Operation
1	0	Ingress	---	Edit
		Egress	---	
2	0	Ingress	---	Edit
		Egress	---	
3	0	Ingress	---	Edit
		Egress	---	
4	0	Ingress	---	Edit
		Egress	---	

[Help](#)

Figure 5-2 Mirror Group List

The following entries are displayed on this screen.

➤ **Mirror Group List**

- Group:** Displays the mirror group number.
- Mirroring:** Displays the mirroring port number.
- Mode:** Displays the mirror mode. The value will be "Ingress" or "Egress".
- Mirrored Port:** Displays the mirrored ports.
- Operation:** Click **Edit** to configure the mirror group.

Click **Edit** to display the following figure.

Mirror Group

Number:

Mirroring Port

Mirroring Port:

Mirrored Port

Select	Port	Ingress	Egress	LAG
<input type="checkbox"/>		<input type="text" value="Disable"/>	<input type="text" value="Disable"/>	
<input type="checkbox"/>	1	Disable	Disable	---
<input type="checkbox"/>	2	Disable	Disable	---
<input type="checkbox"/>	3	Disable	Disable	---
<input type="checkbox"/>	4	Disable	Disable	---
<input type="checkbox"/>	5	Disable	Disable	---
<input type="checkbox"/>	6	Disable	Disable	---
<input type="checkbox"/>	7	Disable	Disable	---
<input type="checkbox"/>	8	Disable	Disable	---
<input type="checkbox"/>	9	Disable	Disable	---
<input type="checkbox"/>	10	Disable	Disable	---
<input type="checkbox"/>	11	Disable	Disable	---
<input type="checkbox"/>	12	Disable	Disable	---

Apply Return Help

Figure 5-3 Port Mirror Config

The following entries are displayed on this screen:

➤ **Mirror Group**

Number: Select the mirror group number you want to configure.

➤ **Mirroring Port**

Mirroring Port: Select the mirroring port number.

➤ **Mirrored Port**

Port Select:	Click the Select button to quick-select the corresponding port based on the port number you entered.
Select:	Select the desired port as a mirrored port. It is multi-optional.
Port:	Displays the port number.
Ingress:	Select Enable/Disable the Ingress feature. When the Ingress is enabled, the incoming packets received by the mirrored port will be copied to the mirroring port.
Egress:	Select Enable/Disable the Egress feature. When the Egress is enabled, the outgoing packets sent by the mirrored port will be copied to the mirroring port.
LAG:	Displays the LAG number which the port belongs to. The LAG member cannot be selected as the mirrored port or mirroring port.



Note:

1. The LAG member cannot be selected as the mirrored port or mirroring port.
2. A port cannot be set as the mirrored port and the mirroring port simultaneously.
3. The Port Mirror function can span the multiple VLANs.

5.1.3 Port Security

MAC Address Table maintains the mapping relationship between the port and the MAC address of the connected device, which is the base of the packet forwarding. The capacity of MAC Address Table is fixed. MAC Address Attack is the attack method that the attacker takes to obtain the network information illegally. The attacker uses tools to generate the cheating MAC address and quickly occupy the MAC Address Table. When the MAC Address Table is full, the switch will broadcast the packets to all the ports. At this moment, the attacker can obtain the network information via various sniffers and attacks. When the MAC Address Table is full, the packets traffic will flood to all the ports, which results in overload, lower speed, packets drop and even breakdown of the system.

Port Security is to protect the switch from the malicious MAC Address Attack by limiting the maximum number of MAC addresses that can be learned on the port. The port with Port Security feature enabled will learn the MAC address dynamically. When the learned MAC address number reaches the maximum, the port will stop learning. Thereafter, the other devices with the MAC address unlearned cannot access to the network via this port.

Choose the menu **Switching**→**Port**→**Port Security** to load the following page.

Port Security						
Select	Port	Max Learned MAC	Learned Num	Learn Mode	Status	
<input type="checkbox"/>		<input type="text" value="64"/>		Dynamic	Disable	
<input type="checkbox"/>	1	64	0	Dynamic	Disable	
<input type="checkbox"/>	2	64	0	Dynamic	Disable	
<input type="checkbox"/>	3	64	0	Dynamic	Disable	
<input type="checkbox"/>	4	64	0	Dynamic	Disable	
<input type="checkbox"/>	5	64	0	Dynamic	Disable	
<input type="checkbox"/>	6	64	0	Dynamic	Disable	
<input type="checkbox"/>	7	64	0	Dynamic	Disable	
<input type="checkbox"/>	8	64	0	Dynamic	Disable	
<input type="checkbox"/>	9	64	0	Dynamic	Disable	
<input type="checkbox"/>	10	64	0	Dynamic	Disable	
<input type="checkbox"/>	11	64	0	Dynamic	Disable	
<input type="checkbox"/>	12	64	0	Dynamic	Disable	

Note:

The maximum number of MAC addresses learned from individual port can be set to 64.

Figure 5-4 Port Security

The following entries are displayed on this screen:

➤ **Port Security**

- Select:** Select the desired port for Port Security configuration. It is multi-optional.
- Port:** Displays the port number.
- Max Learned MAC:** Specify the maximum number of MAC addresses that can be learned on the port.
- Learned Num:** Displays the number of MAC addresses that have been learned on the port.
- Learn Mode:** Select the Learn Mode for the port.
- **Dynamic:** When Dynamic mode is selected, the learned MAC address will be deleted automatically after the aging time.
 - **Static:** When Static mode is selected, the learned MAC address will be out of the influence of the aging time and can only be deleted manually. The learned entries will be cleared after the switch is rebooted.
 - **Permanent:** When Permanent mode is selected, the learned MAC address will be out of the influence of the aging time and can only be deleted manually. The learned entries will be saved even the switch is rebooted.
- Status:** Select Enable/Disable the Port Security feature for the port.



Note:

1. The Port Security function is disabled for the LAG port member. Only the port is removed from the LAG, will the Port Security function be available for the port.
2. The Port Security function is disabled when the 802.1X function is enabled.

5.1.4 Port Isolation

Port Isolation provides a method of restricting traffic flow to improve the network security by forbidding the port to forward packets to the ports that are not on its forward portlist.

Choose the menu **Switching**→**Port**→**Port Isolation** to load the following page.

The screenshot shows two web pages. The top page is titled "Port Isolation Config" and features two dropdown menus for "From Port" and "To Port", both set to "1". Below these is a "Forward Portlist" section with a grid of checkboxes for ports 1 through 24. At the bottom of this page are "All", "Apply", and "Help" buttons. The bottom page is titled "Port Isolation List" and contains a table with two columns: "Port" and "Forward Portlist".

Port	Forward Portlist
1	1-24
2	1-24
3	1-24
4	1-24
5	1-24
6	1-24
7	1-24
8	1-24
9	1-24
10	1-24
11	1-24
12	1-24
13	1-24
14	1-24
15	1-24

Figure 5-5 Port Isolation

The following entries are displayed on this screen:

➤ **Port Isolation Config**

- From Port/To Port:** Select the port number in this range to set their forward list.
- Forward Portlist:** Select the port that to be forwarded to.

➤ **Port Isolation List**

- Port:** Displays the port number.
- Forward Portlist:** Displays the forward portlist.

5.1.5 Loopback Detection

With loopback detection feature enabled, the switch can detect loops using loopback detection packets. When a loop is detected, the switch will display an alert or further block the corresponding port according to the port configuration.

Choose the menu **Switching**→**Port**→**Loopback Detection** to load the following page.

Global Config

Loopback Detection Status: Enable Disable

Detection Interval: seconds(1-1000)

Automatic Recovery Time: detection times(1-100) Apply

Web Refresh Status: Enable Disable

Web Refresh Interval: seconds(3-100)

Port Config

Port Select

Select	Port	Status	Operation mode	Recovery mode	Loop status	Block status	LAG
<input type="checkbox"/>		Disable	Alert	Auto			
<input type="checkbox"/>	1	Disable	Alert	Auto	---	---	---
<input type="checkbox"/>	2	Disable	Alert	Auto	---	---	---
<input type="checkbox"/>	3	Disable	Alert	Auto	---	---	---
<input type="checkbox"/>	4	Disable	Alert	Auto	---	---	---
<input type="checkbox"/>	5	Disable	Alert	Auto	---	---	---
<input type="checkbox"/>	6	Disable	Alert	Auto	---	---	---
<input type="checkbox"/>	7	Disable	Alert	Auto	---	---	---
<input type="checkbox"/>	8	Disable	Alert	Auto	---	---	---
<input type="checkbox"/>	9	Disable	Alert	Auto	---	---	---
<input type="checkbox"/>	10	Disable	Alert	Auto	---	---	---
<input type="checkbox"/>	11	Disable	Alert	Auto	---	---	---
<input type="checkbox"/>	12	Disable	Alert	Auto	---	---	---
<input type="checkbox"/>	13	Disable	Alert	Auto	---	---	---
<input type="checkbox"/>	14	Disable	Alert	Auto	---	---	---
<input type="checkbox"/>	15	Disable	Alert	Auto	---	---	---

Apply Manual Recover Help

Figure 5-6 Loopback Detection Config

The following entries are displayed on this screen:

➤ **Global Config**

LoopbackDetection Status:

Here you can enable or disable Loopback Detection function globally.

Detection Interval:

Set a Loopback Detection interval between 1 and 1000 seconds. By default, it's 30 seconds.

Automatic Recovery Time:

Time after which the blocked port would automatically recover to normal status. It can be set as integral times of detection interval.

Web Refresh Status:

Here you can enable or disable web automatic refresh.

Web Refresh Interval:

Set a web refresh interval between 3 and 100 seconds. By default, it's 3 seconds.

➤ Port Config

Port Select:	Click the Select button to quick-select the corresponding port based on the port number you entered.
Select:	Select the desired port for Loopback Detection configuration. It is multi-optional.
Port:	Displays the port number.
Status:	Enable or disable Loopback Detection function for the port.
Operation Mode:	Select the mode how the switch processes the detected loops. <ul style="list-style-type: none">• Alert: When a loop is detected, display an alert.• Port based: When a loop is detected, display an alert and block the port.
Recovery Mode:	Select the mode how the blocked port recovers to normal status. <ul style="list-style-type: none">• Auto: Block status can be automatically removed after recovery time.• Manual: Block status only can be removed manually.
Loop Status:	Displays the port status whether a loopback is detected.
Block Status:	Displays the port status about block or unblock.
LAG:	Displays the LAG number the port belongs to.
Manual Recover:	Manually remove the block status of selected ports.



Note:

1. Recovery Mode is not selectable when Alert is chosen in Operation Mode.
2. Loopback Detection must coordinate with storm control.

5.2 LAG

LAG (Link Aggregation Group) is to combine a number of ports together to make a single high-bandwidth data path, so as to implement the traffic load sharing among the member ports in the group and to enhance the connection reliability.

For the member ports in an aggregation group, their basic configuration must be the same. The basic configuration includes **STP**, **QoS**, **VLAN**, **port attributes**, **MAC Address Learning mode** and other associated settings. More details are explained below:

- If the ports, which are enabled for the **802.1Q VLAN**, **STP**, **QoS** and **Port Configuration (Speed and Flow Control)**, are in a LAG, their configurations should be the same.
- The ports, which are enabled for the **half-duplex**, **Port Security**, **Port Mirror**, **MAC Address Filtering** and **802.1X Authentication**, cannot be added to the LAG.

If the LAG is needed, you are suggested to configure the LAG function here before configuring the other functions for the member ports.



Tips:

1. Calculate the bandwidth for a LAG: If a LAG consists of the four ports in the speed of 1000Mbps Full Duplex, the whole bandwidth of the LAG is up to 8000Mbps (2000Mbps * 4) because the bandwidth of each member port is 2000Mbps counting the up-linked speed of 1000Mbps and the down-linked speed of 1000Mbps.
2. The traffic load of the LAG will be balanced among the ports according to the Aggregate Arithmetic. If the connections of one or several ports are broken, the traffic of these ports will be transmitted on the normal ports, so as to guarantee the connection reliability.

The LAG function is implemented on the **LAG Table**, **Static LAG** and **LACP Config** configuration pages.

5.2.1 LAG Table

On this page, you can view the information of the current LAG of the switch.

Choose the menu **Switching**→**LAG**→**LAG Table** to load the following page.

Global Config

Hash Algorithm: SRC MAC+DST MAC

Select	Group Number	Description	Member	Operation
<input type="checkbox"/>	LAG1	Static LAG	5, 6, 7, 8	Edit Detail

Note:

1. The LAG created by LACP can't be deleted.

Figure 5-7 LAG Table

The following entries are displayed on this screen:

➤ **Global Config**

Hash Algorithm:

Select the applied scope of Aggregate Arithmetic, which results in choosing a port to transfer the packets.

- **SRC MAC + DST MAC:** When this option is selected, the Aggregate Arithmetic will apply to the source and destination MAC addresses of the packets.
- **SRC IP + DST IP:** When this option is selected, the Aggregate Arithmetic will apply to the source and destination IP addresses of the packets.

➤ **LAG Table**

Select:

Select the desired LAG. It is multi-optional.

Group Number:

Displays the LAG number here.

Description:

Displays the description of LAG.

Member:

Displays the LAG member.

Operation:

Allows you to view or modify the information for each LAG.

- Edit: Click to modify the settings of the LAG.
- Detail: Click to get the information of the LAG.

Click the **Detail** button for the detailed information of your selected LAG.

Detail Info	
Group Number:	LAG1
LAG Type:	Static
Port Status:	Enable
Rate:	Auto
Port mirror:	Disable
Ingress Bandwidth (bps):	--
Egress Bandwidth (bps):	--
Broadcast Control (bps):	--
Multicast Control (bps):	--
UL Control (bps):	--
QoS Priority:	CoS 0
Join VLAN:	1

Figure 5-8 Detailed Information

5.2.2 Static LAG

On this page, you can manually configure the LAG.

Choose the menu **Switching**→**LAG**→**Static LAG** to load the following page.

LAG Config

Group Number:

Description:

Member Port

<input type="checkbox"/> 1	<input type="checkbox"/> 2	<input type="checkbox"/> 3	<input type="checkbox"/> 4	<input type="checkbox"/> 5	<input type="checkbox"/> 6
<input type="checkbox"/> 7	<input type="checkbox"/> 8	<input type="checkbox"/> 9	<input type="checkbox"/> 10	<input type="checkbox"/> 11	<input type="checkbox"/> 12
<input type="checkbox"/> 13	<input type="checkbox"/> 14	<input type="checkbox"/> 15	<input type="checkbox"/> 16	<input type="checkbox"/> 17	<input type="checkbox"/> 18
<input type="checkbox"/> 19	<input type="checkbox"/> 20	<input type="checkbox"/> 21	<input type="checkbox"/> 22	<input type="checkbox"/> 23	<input type="checkbox"/> 24

Note:

1. LAG* denotes the Link Aggregation Group which the port belongs to.
2. It's not suggested to set 100M and 1000M ports in the same LAG.
3. The LAG created by LACP can't be modified.

Figure 5-9 Manually Config

The following entries are displayed on this screen:

➤ **LAG Config**

Group Number: Select a Group Number for the LAG.

Description: Displays the description of the LAG.

➤ **Member Port**

Member Port: Select the port as the LAG member. Clearing all the ports of the LAG will delete this LAG.



Tips:

1. The LAG can be deleted by clearing its all member ports.
2. A port can only be added to a LAG. If a port is the member of a LAG, the port number will be displayed in gray and cannot be selected.

5.2.3 LACP Config

LACP (Link Aggregation Control Protocol) is defined in IEEE802.3ad and enables the dynamic link aggregation and disaggregation by exchanging LACP packets with its partner. The switch can dynamically group similarly configured ports into a single logical link, which will highly extend the bandwidth and flexibly balance the load.

With the LACP feature enabled, the port will notify its partner of the system priority, system MAC, port priority, port number and operation key (operation key is determined by the physical properties of the port, upper layer protocol and admin key). The device with higher priority will lead the aggregation and disaggregation. System priority and system MAC decide the priority of the device. The smaller the system priority, the higher the priority of the device is. With the same system priority, the device owning the smaller system MAC has the higher priority. The device with the higher priority will choose the ports to be aggregated based on the port priority, port number and operation key. Only the ports with the same operation key can be selected into the same aggregation group. In an aggregation group, the port with smaller port priority will be considered as the preferred one. If the two port priorities are equal, the port with smaller port number is preferred. After an aggregation group is established, the selected ports can be aggregated together as one port to transmit packets.

On this page, you can configure the LACP feature of the switch.

Choose the menu **Switching**→**LAG**→**LACP Config** to load the following page.

Global Config

System Priority: (0 - 65535)

LACP Config

Port

Select	Port	Admin Key	Port Priority (0-65535)	Mode	Status	LAG
<input type="checkbox"/>		<input style="width: 40px;" type="text"/>	<input style="width: 60px;" type="text"/>	Passive ▾	Disable ▾	
<input type="checkbox"/>	1	1	32768	Passive	Disable	---
<input type="checkbox"/>	2	1	32768	Passive	Disable	---
<input type="checkbox"/>	3	1	32768	Passive	Disable	---
<input type="checkbox"/>	4	1	32768	Passive	Disable	---
<input type="checkbox"/>	5	1	32768	Passive	Disable	---
<input type="checkbox"/>	6	1	32768	Passive	Disable	---
<input type="checkbox"/>	7	1	32768	Passive	Disable	---
<input type="checkbox"/>	8	1	32768	Passive	Disable	---
<input type="checkbox"/>	9	1	32768	Passive	Disable	---
<input type="checkbox"/>	10	1	32768	Passive	Disable	---
<input type="checkbox"/>	11	1	32768	Passive	Disable	---
<input type="checkbox"/>	12	1	32768	Passive	Disable	---
<input type="checkbox"/>	13	1	32768	Passive	Disable	---
<input type="checkbox"/>	14	1	32768	Passive	Disable	---
<input type="checkbox"/>	15	1	32768	Passive	Disable	---

Note:

1. To avoid any broadcast storm when LACP takes effect, you are suggested to enable Spanning Tree function.
2. LACP function can't be enabled for the port already in a static link aggregation group.
3. The value of admin key can't be the same with the group number of any static link aggregation group in used and vice versa.

Figure 5-10 LACP Config

The following entries are displayed on this screen:

➤ **Global Config**

System Priority: Specify the system priority for the switch. The system priority and MAC address constitute the system identification (ID). A lower system priority value indicates a higher system priority. When exchanging information between systems, the system with higher priority determines which link aggregation a link belongs to, and the system with lower priority adds the proper links to the link aggregation according to the selection of its partner.

➤ **LACP Config**

Port Select: Click the **Select** button to quick-select the corresponding port based on the port number you entered.

Select: Select the desired port for LACP configuration. It is multi-optional.

Port: Displays the port number.

Admin Key: Specify an Admin Key for the port. The member ports in a dynamic aggregation group must have the same Admin Key.

- Port Priority:** Specify a Port Priority for the port. This value determines the priority of the port to be selected as the dynamic aggregation group member. The port with smaller Port Priority will be considered as the preferred one. If the two port priorities are equal; the port with smaller port number is preferred.
- Mode:** Specify LACP mode for your selected port.
- Status:** Enable/Disable the LACP feature for your selected port.
- LAG:** Displays the LAG number which the port belongs to.

5.3 Traffic Monitor

The Traffic Monitor function, monitoring the traffic of each port, is implemented on the **Traffic Summary** and **Traffic Statistics** pages.

5.3.1 Traffic Summary

Traffic Summary screen displays the traffic information of each port, which facilitates you to monitor the traffic and analyze the network abnormality.

Choose the menu **Switching**→**Traffic Monitor**→**Traffic Summary** to load the following page.

Auto Refresh

Auto Refresh: Enable Disable

Refresh Rate: sec (3-300) Apply

Traffic Summary

Port
Select

Port	Packets Rx	Packets Tx	Octets Rx	Octets Tx	Statistics
1	0	0	0	0	Statistics
2	4613	4386	680269	2072355	Statistics
3	0	0	0	0	Statistics
4	0	0	0	0	Statistics
5	0	0	0	0	Statistics
6	0	0	0	0	Statistics
7	0	0	0	0	Statistics
8	0	0	0	0	Statistics
9	0	0	0	0	Statistics
10	0	0	0	0	Statistics
11	0	0	0	0	Statistics
12	0	0	0	0	Statistics

Refresh
Clear
Help

Figure 5-11 Traffic Summary

The following entries are displayed on this screen:

➤ **Auto Refresh**

- Auto Refresh:** Allows you to Enable/Disable refreshing the Traffic Summary automatically.

Refresh Rate: Enter a value in seconds to specify the refresh interval.

➤ **Traffic Summary**

Port Select: Click the **Select** button to quick-select the corresponding port based on the port number you entered.

Port: Displays the port number.

Packets Rx: Displays the number of packets received on the port. The error packets are not counted in.

Packets Tx: Displays the number of packets transmitted on the port.

Octets Rx: Displays the number of octets received on the port. The error octets are counted in.

Octets Tx: Displays the number of octets transmitted on the port.

Statistics: Click the **Statistics** button to view the detailed traffic statistics of the port.

5.3.2 Traffic Statistics

Traffic Statistics screen displays the detailed traffic information of each port, which facilitates you to monitor the traffic and locate faults promptly.

Choose the menu **Switching**→**Traffic Monitor**→**Traffic Statistics** to load the following page.

Auto Refresh

Auto Refresh: Enable Disable

Refresh Rate: sec (3-300)

Statistics

Port

Received		Sent	
Broadcast	0	Broadcast	0
Multicast	0	Multicast	0
Unicast	0	Unicast	0
Alignment Errors	0	Collisions	0
UndersizePkts	0		
Pkts64Octets	0		
Pkts65to127Octets	0		
Pkts128to255Octets	0		
Pkts256to511Octets	0		
Pkts512to1023Octets	0		
PktsOver1023Octets	0		

Figure 5-12 Traffic Statistics

The following entries are displayed on this screen:

➤ **Auto Refresh**

Auto Refresh: Allows you to Enable/Disable refreshing the Traffic Summary automatically.

Refresh Rate: Enter a value in seconds to specify the refresh interval.

➤ **Statistics**

Port: Enter a port number and click the **Select** button to view the traffic statistics of the corresponding port.

Received: Displays the details of the packets received on the port.

Sent: Displays the details of the packets transmitted on the port.

Broadcast: Displays the number of good broadcast packets received or transmitted on the port. The error frames are not counted in.

Multicast: Displays the number of good multicast packets received or transmitted on the port. The error frames are not counted in.

Unicast: Displays the number of good unicast packets received or transmitted on the port. The error frames are not counted in.

Alignment Errors: For TL-SG2216/TL-SG2424/TL-SG2424P:
Displays the number of the received packets that have a bad Frame Check Sequence (FCS) with a non-integral octet (Alignment Error) and have a bad FCS with an integral octet (CRC Error). The length of the packet is between 64 bytes and 1518 bytes.

For TL-SG2452:

Displays the number of the received packets that have a bad Frame Check Sequence (FCS). The length of the packet is from 64 bytes to maximal bytes of the jumbo frame(usually 10240 bytes).

UndersizePkts: Displays the number of the received packets (excluding error packets) that are less than 64 bytes long.

Pkts64Octets: Displays the number of the received packets (including error packets) that are 64 bytes long.

Pkts65to127Octets: Displays the number of the received packets (including error packets) that are between 65 and 127 bytes long.

Pkts128to255Octets: Displays the number of the received packets (including error packets) that are between 128 and 255 bytes long.

Pkts256to511Octets: Displays the number of the received packets (including error packets) that are between 256 and 511 bytes long.

Pkts512to1023Octets: Displays the number of the received packets (including error packets) that are between 512 and 1023 bytes long.

PktsOver1023Octets: Displays the number of the received packets (including error packets) that are over 1023 bytes.

Collisions: Displays the number of collisions experienced by a port during packet transmissions.

5.4 MAC Address

The main function of the switch is forwarding the packets to the correct ports based on the destination MAC address of the packets. Address Table contains the port-based MAC address information, which is the base for the switch to forward packets quickly. The entries in the Address Table can be updated by auto-learning or configured manually. Most entries are generated and updated by auto-learning. In the stable networks, the static MAC address entries can facilitate the switch to reduce broadcast packets and enhance the efficiency of packets forwarding remarkably. The address filtering feature allows the switch to filter the undesired packets and forbid its forwarding so as to improve the network security.

The types and the features of the MAC Address Table are listed as the following:

Type	Configuration Way	Aging out	Being kept after reboot (if the configuration is saved)	Relationship between the bound MAC address and the port
Static Address Table	Manually configuring	No	Yes	The bound MAC address cannot be learned by the other ports in the same VLAN.
Dynamic Address Table	Automatically learning	Yes	No	The bound MAC address can be learned by the other ports in the same VLAN.
Filtering Address Table	Manually configuring	No	Yes	-

Table 5-1 Types and features of Address Table

This function includes four submenus: **Address Table**, **Static Address**, **Dynamic Address** and **Filtering Address**.

5.4.1 Address Table

On this page, you can view all the information of the Address Table.

Choose the menu **Switching**→**MAC Address**→**Address Table** to load the following page.

Search Option

MAC Address: (Format: 00-00-00-00-00-01)

VLAN ID: (1-4094)

Port: ▼

Type: All Static Dynamic Filtering

Address Table

MAC Address	VLAN ID	Port	Type	Aging Status
6C-62-6D-F5-9D-86	1	2	Dynamic	Aging

Total MAC Address: 1

Note:
The maximum of the displayed entries is 100 by default, please click the Search button to get the complete address entries.

Figure 5-13 Address Table

The following entries are displayed on this screen:

➤ **Search Option**

- MAC Address:** Enter the MAC address of your desired entry.
- VLAN ID:** Enter the VLAN ID of your desired entry.
- Port:** Select the corresponding port number of your desired entry.
- Type:** Select the type of your desired entry.
- **All:** This option allows the address table to display all the address entries.
 - **Static:** This option allows the address table to display the static address entries only.
 - **Dynamic:** This option allows the address table to display the dynamic address entries only.
 - **Filtering:** This option allows the address table to display the filtering address entries only.

➤ **Address Table**

- MAC Address:** Displays the MAC address learned by the switch.
- VLAN ID:** Displays the corresponding VLAN ID of the MAC address.
- Port:** Displays the corresponding Port number of the MAC address.
- Type:** Displays the Type of the MAC address.
- Aging Status:** Displays the Aging status of the MAC address.

5.4.2 Static Address

The static address table maintains the static address entries which can be added or removed manually, independent of the aging time. In the stable networks, the static MAC address entries can facilitate the switch to reduce broadcast packets and remarkably enhance the efficiency of packets forwarding without learning the address. The static MAC address learned by the port with **Port Security** enabled in the static learning mode will be displayed in the Static Address Table.

Choose the menu **Switching**→**MAC Address**→**Static Address** to load the following page.

Create Static Address

MAC Address: (Format: 00-00-00-00-00-01)

VLAN ID: (1-4094)

Port: ▼

Search Option

Search Option: ▼

Static Address Table

Select	MAC Address	VLAN ID	Port	Type	Aging Status
<input type="checkbox"/>			Port 1 ▼		

Total MAC Address: 0

Note:
The maximum of the displayed entries is 100 by default, please click the Search button to get the complete address entries.

Figure 5-14 Static Address

The following entries are displayed on this screen:

➤ **Create Static Address**

- MAC Address:** Enter the static MAC Address to be bound.
- VLAN ID:** Enter the corresponding VLAN ID of the MAC address.
- Port:** Select a port from the pull-down list to be bound.

➤ **Search Option**

- Search Option:** Select a Search Option from the pull-down list and click the **Search** button to find your desired entry in the Static Address Table.
 - **MAC:** Enter the MAC address of your desired entry.
 - **VLAN ID:** Enter the VLAN ID number of your desired entry.
 - **Port:** Enter the Port number of your desired entry.

➤ **Static Address Table**

- Select:** Select the entry to delete or modify the corresponding port number. It is multi-optional.
- MAC Address:** Displays the static MAC Address.
- VLAN ID:** Displays the corresponding VLAN ID of the MAC address.
- Port:** Displays the corresponding Port number of the MAC address. Here you can modify the port number to which the MAC address is bound. The new port should be in the same VLAN.
- Type:** Displays the Type of the MAC address.
- Aging Status:** Displays the Aging Status of the MAC address.

 **Note:**

1. If the corresponding port number of the MAC address is not correct, or the connected port (or the device) has been changed, the switch cannot forward the packets correctly. Please reset the static address entry appropriately.
2. If the MAC address of a device has been added to the Static Address Table, connecting the device to another port will cause its address not to be recognized dynamically by the switch. Therefore, please ensure the entries in the Static Address Table are correct and valid.
3. The MAC address in the Static Address Table cannot be added to the Filtering Address Table or bound to a port dynamically.

5.4.3 Dynamic Address

The dynamic address can be generated by the auto-learning mechanism of the switch. The Dynamic Address Table can update automatically by auto-learning or the MAC address aging out mechanism.

To fully utilize the MAC address table, which has a limited capacity, the switch adopts an aging mechanism for updating the table. That is, the switch removes the MAC address entries related to a network device if no packet is received from the device within the aging time.

On this page, you can configure the dynamic MAC address entry.

Choose the menu **Switching**→**MAC Address**→**Dynamic Address** to load the following page.

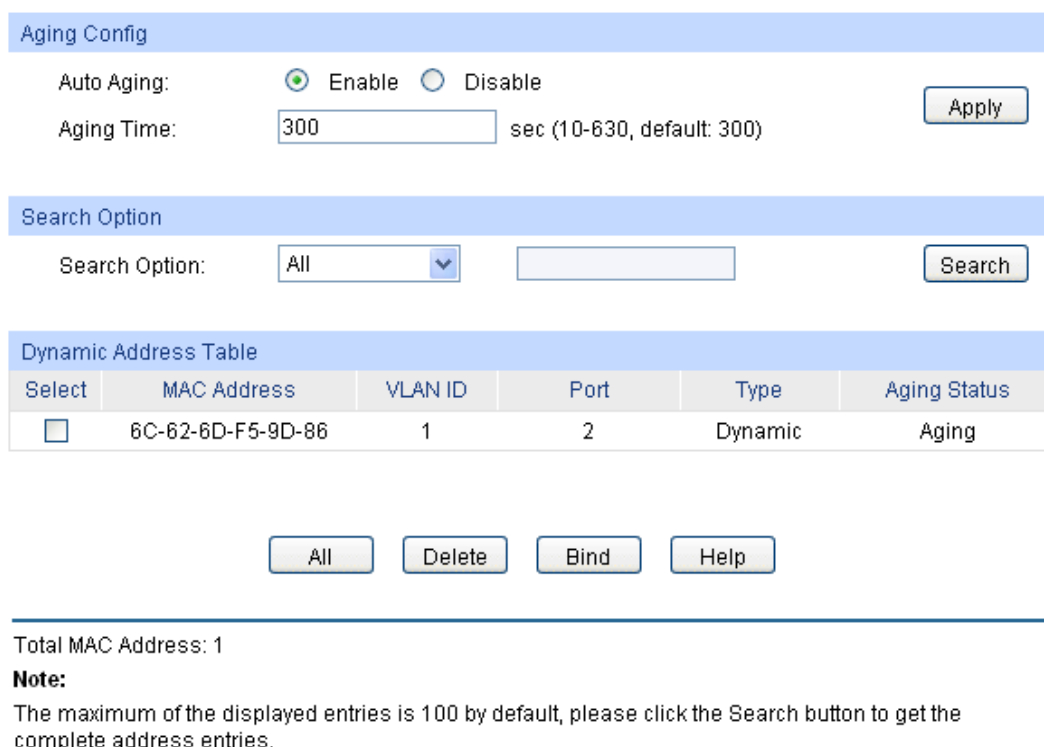

Aging Config

Auto Aging: Enable Disable

Aging Time: sec (10-630, default: 300)

Search Option

Search Option:

Dynamic Address Table

Select	MAC Address	VLAN ID	Port	Type	Aging Status
<input type="checkbox"/>	6C-62-6D-F5-9D-86	1	2	Dynamic	Aging

Total MAC Address: 1

Note:
The maximum of the displayed entries is 100 by default, please click the Search button to get the complete address entries.

Figure 5-15 Dynamic Address

The following entries are displayed on this screen:

➤ **Aging Config**

Auto Aging: Allows you to Enable/Disable the Auto Aging feature.

Aging Time: Enter the Aging Time for the dynamic address.

➤ Search Option

Search Option: Select a Search Option from the pull-down list and click the **Search** button to find your desired entry in the Dynamic Address Table.

- **MAC:** Enter the MAC address of your desired entry.
- **VLAN ID:** Enter the VLAN ID number of your desired entry.
- **Port:** Enter the Port number of your desired entry.
- **LAG ID:** Enter the LAG ID of your desired entry.

➤ Dynamic Address Table

Select: Select the entry to delete the dynamic address or to bind the MAC address to the corresponding port statically. It is multi-optional.

MAC Address: Displays the dynamic MAC Address.

VLAN ID: Displays the corresponding VLAN ID of the MAC address.

Port: Displays the corresponding port number of the MAC address.

Type: Displays the Type of the MAC address.

Aging Status: Displays the Aging Status of the MAC address.

Bind: Click the **Bind** button to bind the MAC address of your selected entry to the corresponding port statically.



Tips:

Setting aging time properly helps implement effective MAC address aging. The aging time that is too long or too short results in a decrease of the switch performance. If the aging time is too long, excessive invalid MAC address entries maintained by the switch may fill up the MAC address table. This prevents the MAC address table from updating with network changes in time. If the aging time is too short, the switch may remove valid MAC address entries. This decreases the forwarding performance of the switch. It is recommended to keep the default value.

5.4.4 Filtering Address

The filtering address is to forbid the undesired packets to be forwarded. The filtering address can be added or removed manually, independent of the aging time. The filtering MAC address allows the switch to filter the packets which includes this MAC address as the source address or destination address, so as to guarantee the network security. The filtering MAC address entries act on all the ports in the corresponding VLAN.

Choose the menu **Switching**→**MAC Address**→**Filtering Address** to load the following page.

Create Filtering Address

MAC Address: (Format: 00-00-00-00-00-01)

VLAN ID: (1-4094)

Search Option

Search Option:

Filtering Address Table

Select	MAC Address	VLAN ID	Port	Type	Aging Status
--------	-------------	---------	------	------	--------------

Total MAC Address: 0

Note:
The maximum of the displayed entries is 100 by default, please click the Search button to get the complete address entries.

Figure 5-16 Filtering Address

The following entries are displayed on this screen:

➤ **Create Filtering Address**

MAC Address: Enter the MAC Address to be filtered.

VLAN ID: Enter the corresponding VLAN ID of the MAC address.

➤ **Search Option**

Search Option: Select a Search Option from the pull-down list and click the **Search** button to find your desired entry in the Filtering Address Table.

- **MAC Address:** Enter the MAC address of your desired entry.
- **VLAN ID:** Enter the VLAN ID number of your desired entry.

➤ **Filtering Address Table**

Select: Select the entry to delete the corresponding filtering address. It is multi-optional.

MAC Address: Displays the filtering MAC Address.

VLAN ID: Displays the corresponding VLAN ID.

Port: Here the symbol "--" indicates no specified port.

Type: Displays the Type of the MAC address.

Aging Status: Displays the Aging Status of the MAC address.



Note:

1. The MAC address in the Filtering Address Table cannot be added to the Static Address Table or bound to a port dynamically.
2. This MAC address filtering function is not available if the 802.1X feature is enabled.

5.5 DHCP Filtering

Nowadays, the network is getting larger and more complicated. The amount of the PCs always exceeds that of the assigned IP addresses. The wireless network and the laptops are widely used and the locations of the PCs are always changed. Therefore, the corresponding IP address of the PC should be updated with a few configurations. DHCP (Dynamic Host Configuration Protocol) functions to solve the above mentioned problems.

However, during the working process of DHCP, generally there is no authentication mechanism between Server and Client. If there are several DHCP servers in the network, network confusion and security problem will happen. To protect the switch from being attacked by illegal DHCP servers, you can configure the desired ports as trusted ports and only the clients connected to the trusted ports can receive DHCP packets from DHCP servers. Here the DHCP Filtering function performs to monitor the process of hosts obtaining IP addresses from DHCP servers.

➤ DHCP Working Principle

DHCP works via the “Client/Server” communication mode. The Client applies to the Server for configuration. The Server assigns the configuration information, such as the IP address, to the Client, so as to reach a dynamic employ of the network source. A Server can assign IP address for several Clients, which is illustrated in the following figure.

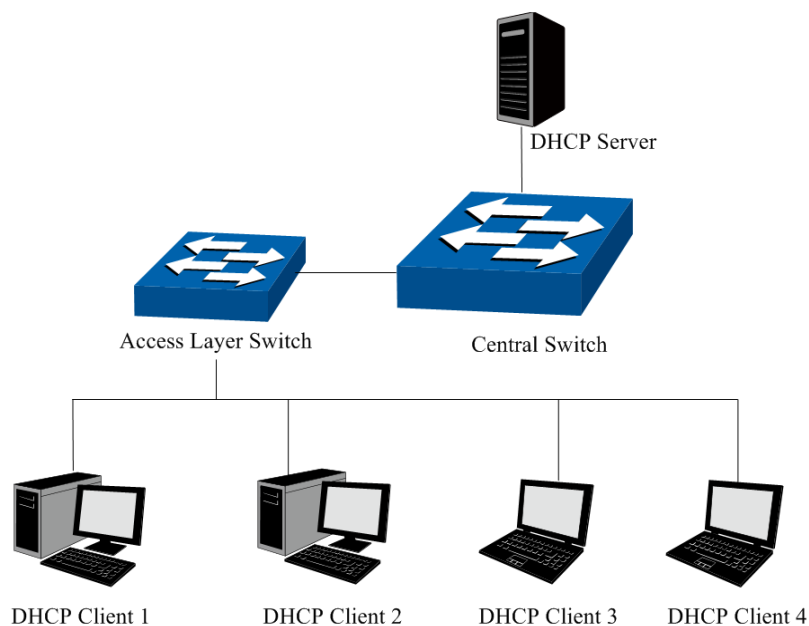

Figure 5-17 Network diagram of DHCP

For different DHCP clients, DHCP server provides three IP address assigning methods:

- (1) Manually assign the IP address: Allows the administrator to bind the static IP address to a specific client (e.g.: WWW Server) via the DHCP server.
- (2) Automatically assign the IP address: DHCP server assigns the IP address without an expiry time limitation to the clients.
- (3) Dynamically assign the IP address: DHCP server assigns the IP address with an expiry time. When the time for the IP address expired, the client should apply for a new one.

Most clients obtain IP addresses dynamically, which is illustrated in the following figure.

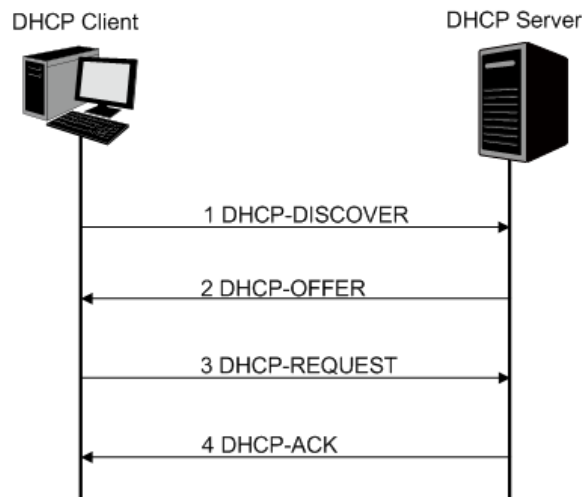

Figure 5-18 Interaction between a DHCP client and a DHCP server

- (1) **DHCP-DISCOVER Stage:** The Client broadcasts the DHCP-DISCOVER packet to find the DHCP server.
- (2) **DHCP-OFFER Stage:** Upon receiving the DHCP-DISCOVER packet, the DHCP server selects an IP address from the IP pool according to the assigning priority of the IP addresses and replies to the client with DHCP-OFFER packet carrying the IP address and other information.
- (3) **DHCP-REQUEST Stage:** In the situation that there are several DHCP servers sending the DHCP-OFFER packets, the client will only respond to the first received DHCP-OFFER packet and broadcast the DHCP-REQUEST packet which includes the assigned IP address of the DHCP-OFFER packet.
- (4) **DHCP-ACK Stage:** Since the DHCP-REQUEST packet is broadcasted, all DHCP servers on the network segment can receive it. However, only the requested server processes the request. If the DHCP server acknowledges assigning this IP address to the client, it will send the DHCP-ACK packet back to the client. Otherwise, the Server will send the DHCP-NAK packet to refuse assigning this IP address to the client.

➤ DHCP Cheating Attack

During the working process of DHCP, generally there is no authentication mechanism between Server and Client. If there are several DHCP servers in the network, network confusion and security problem will happen. The common cases incurring the illegal DHCP servers are the following two:

- (1) It's common that the illegal DHCP server is manually configured by the user by mistake.
- (2) Hacker exhausted the IP addresses of the normal DHCP server and then pretended to be a legal DHCP server to assign the IP addresses and the other parameters to Clients. For example, hacker used the pretended DHCP server to assign a modified DNS server address to users so as to induce the users to the evil financial website or electronic trading website and cheat the users of their accounts and passwords. The following figure illustrates the DHCP Cheating Attack implementation procedure.

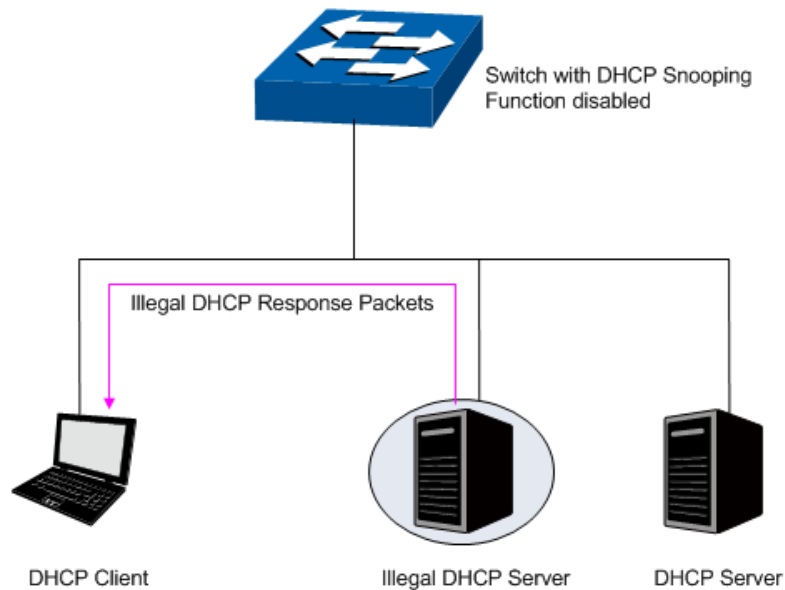

Figure 5-19 DHCP Cheating Attack Implementation Procedure

DHCP Filtering feature allows only the trusted ports to forward DHCP packets and thereby ensures that users get proper IP addresses. DHCP Filtering is to monitor the process of hosts obtaining the IP addresses from DHCP servers, and record the IP address, MAC address, VLAN and the connected Port number of the Host for automatic binding. DHCP Filtering feature prevents the network from the DHCP Server Cheating Attack by discarding the DHCP packets on the distrusted port, so as to enhance the network security.

Choose the menu **Switching** → **DHCP Filtering** to load the following page.

DHCP Filtering

DHCP Filtering: Enable Disable Apply

Trusted Port

<input type="checkbox"/> 1	<input type="checkbox"/> 2	<input type="checkbox"/> 3	<input type="checkbox"/> 4	<input type="checkbox"/> 5(LAG1)	<input type="checkbox"/> 6(LAG1)
<input type="checkbox"/> 7(LAG1)	<input type="checkbox"/> 8(LAG1)	<input type="checkbox"/> 9	<input type="checkbox"/> 10		

Apply
All
Clear
Help

Figure 5-20 DHCP Filtering

The following entries are displayed on this screen:

➤ **DHCP Filtering**

DHCP Filtering: Enable/Disable the DHCP Filtering function globally.

➤ **Trusted Port**

Here you can select the desired port(s) to be Trusted Port(s). Only the Trusted Port(s) can receive DHCP packets from DHCP Servers. Click **All** button to select all ports. Click **Clear** button to select none.

[Return to CONTENTS](#)

Chapter 6 VLAN

The traditional Ethernet is a data network communication technology based on CSMA/CD (Carrier Sense Multiple Access/Collision Detect) via shared communication medium. Through the traditional Ethernet, the overfull hosts in LAN will result in serious collision, flooding broadcasts, poor performance or even breakdown of the Internet. Though connecting the LANs through switches can avoid the serious collision, the flooding broadcasts cannot be prevented, which will occupy plenty of bandwidth resources, causing potential serious security problems.

A Virtual Local Area Network (VLAN) is a network topology configured according to a logical scheme rather than the physical layout. The VLAN technology is developed for switches to control broadcast in LANs. By creating VLANs in a physical LAN, you can divide the LAN into multiple logical LANs, each of which has a broadcast domain of its own. Hosts in the same VLAN communicate with one another as if they are in a LAN. However, hosts in different VLANs cannot communicate with one another directly. Therefore, broadcast packets are limited in a VLAN. Hosts in the same VLAN communicate with one another via Ethernet whereas hosts in different VLANs communicate with one another through the Internet devices such as router, the Layer 3 switch, etc. The following figure illustrates a VLAN implementation.

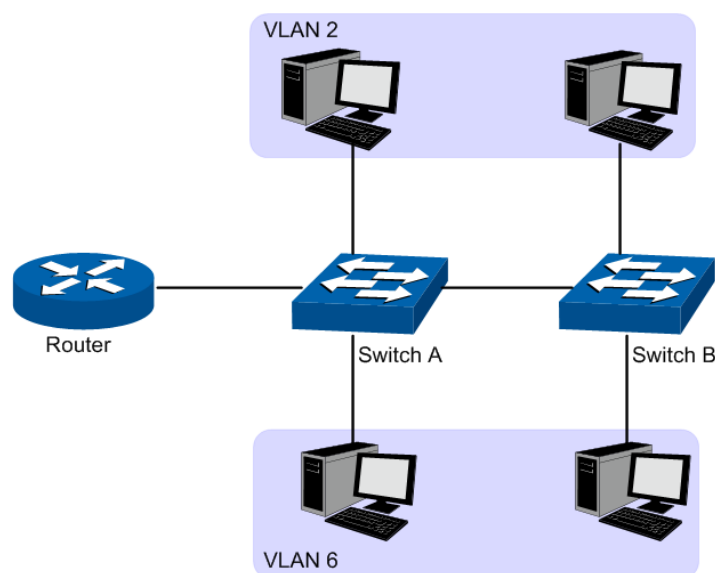

Figure 6-1 VLAN implementation

Compared with the traditional Ethernet, VLAN enjoys the following advantages.

- (1) Broadcasts are confined to VLANs. This decreases bandwidth utilization and improves network performance.
- (2) Network security is improved. VLANs cannot communicate with one another directly. That is, a host in a VLAN cannot access resources in another VLAN directly, unless routers or Layer 3 switches are used.
- (3) Network configuration workload for the host is reduced. VLAN can be used to group specific hosts. When the physical position of a host changes within the range of the VLAN, you do not need to change its network configuration.

A VLAN can span across multiple switches, or even routers. This enables hosts in a VLAN to be dispersed in a looser way. That is, hosts in a VLAN can belong to different physical network segments. This switch supports 802.1Q VLAN to classify VLANs. VLAN tags in the packets are necessary for the switch to identify packets of different VLANs.

6.1 802.1Q VLAN

VLAN tags in the packets are necessary for the switch to identify packets of different VLANs. The switch works at the data link layer in OSI model and it can identify the data link layer encapsulation of the packet only, so you can add the VLAN tag field into the data link layer encapsulation for identification.

In 1999, IEEE issues the IEEE 802.1Q protocol to standardize VLAN implementation, defining the structure of VLAN-tagged packets. IEEE 802.1Q protocol defines that a 4-byte VLAN tag is encapsulated after the destination MAC address and source MAC address to show the information about VLAN.

As shown in the following figure, a VLAN tag contains four fields, including TPID (Tag Protocol Identifier), Priority, CFI (Canonical Format Indicator), and VLAN ID.

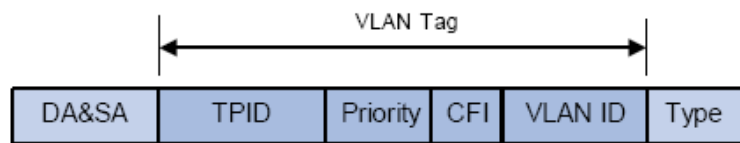

Figure 6-2 Format of VLAN Tag

- (1) **TPID:** TPID is a 16-bit field, indicating that this data frame is VLAN-tagged. By default, it is 0x8100 in this switch.
- (2) **Priority:** Priority is a 3-bit field, referring to 802.1p priority. Refer to section “QoS & QoS profile” for details.
- (3) **CFI:** CFI is a 1-bit field, indicating whether the MAC address is encapsulated in the standard format in different transmission media. This field is not described in detail in this chapter.
- (4) **VLAN ID:** VLAN ID is a 12-bit field, indicating the ID of the VLAN to which this packet belongs. It is in the range of 0 to 4,095. Generally, 0 and 4,095 is not used, so the field is in the range of 1 to 4,094.

VLAN ID identifies the VLAN to which a packet belongs. When the switch receives an un-VLAN-tagged packet, it will encapsulate a VLAN tag with the default VLAN ID of the inbound port for the packet, and the packet will be assigned to the default VLAN of the inbound port for transmission.

In this User Guide, the tagged packet refers to the packet with VLAN tag whereas the untagged packet refers to the packet without VLAN tag, and the priority-tagged packet refers to the packet with VLAN tag whose VLAN ID is 0.

➤ Link Types of ports

When creating the 802.1Q VLAN, you should set the link type for the port according to its connected device. The link types of port including the following two types: **Untagged** and **Tagged**.

- (1) **Untagged:** The untagged port can be added in multiple VLANs. If a VLAN-tagged packet arrives at a port and the VLAN ID in its VLAN tag does not match any of the VLAN the ingress port belongs to, this packet will be dropped. The packets forwarded by the untagged port are untagged.
- (2) **Tagged:** The tagged port can be added in multiple VLANs. If a VLAN-tagged packet arrives at a port and the VLAN ID in its VLAN tag does not match any of the VLAN the ingress port belongs to, this packet will be dropped. When the VLAN-tagged packets are forwarded by the Tagged port, its VLAN tag will not be changed.

➤ **PVID**

PVID (Port VLAN ID) is the default VID of the port. When the switch receives an un-VLAN-tagged packet, it will add a VLAN tag to the packet according to the PVID of its received port and forward the packets.

When creating VLANs, the PVID of each port, indicating the default VLAN to which the port belongs, is an important parameter with the following two purposes:

- (1) When the switch receives an un-VLAN-tagged packet, it will add a VLAN tag to the packet according to the PVID of its received port
- (2) PVID determines the default broadcast domain of the port, i.e. when the port receives UL packets or broadcast packets, the port will broadcast the packets in its default VLAN.

Different packets, tagged or untagged, will be processed in different ways, after being received by ports of different link types, which is illustrated in the following table.

Port Type	Receiving Packets		Forwarding Packets	
	Untagged Packets	Tagged Packets	Untagged Packets	Tagged Packets
Untagged	When untagged packets are received, the port will add the default VLAN tag, i.e. the PVID of the ingress port, to the packets.	If the VID of packet is allowed by the port, the packet will be received. If the VID of packet is forbidden by the port, the packet will be dropped.	The packet will be forwarded unchanged.	The packet will be forwarded after removing its VLAN tag
Tagged			The packet will be forwarded with the PVID of egress port as its VLAN tag.	The packet will be forwarded with its current VLAN tag.

Table 6-1 Relationship between Port Types and VLAN Packets Processing

IEEE 802.1Q VLAN function is implemented on the **VLAN Config** pages.

6.1.1 VLAN Config

On this page, you can configure the 802.1Q VLAN and its ports.

Choose the menu **VLAN**→**802.1Q VLAN**→**VLAN Config** to load the following page.

VLAN Create

VLAN ID: (2-4094)
 Name: (16 characters maximum)

VLAN Table

VLAN ID

Select	VLAN ID	Name	Untagged Ports	Tagged Ports	Operation
<input type="checkbox"/>	1	Default VLAN	1-24		Delete

VLAN Membership

VLAN ID		VLAN Name												
Port	1	2	3	4	5	6	7	8	9	10	11	12	13	14
Untagged	<input type="radio"/>	<input type="radio"/>	<input type="radio"/>	<input type="radio"/>	<input type="radio"/>	<input type="radio"/>	<input type="radio"/>	<input type="radio"/>	<input type="radio"/>	<input type="radio"/>	<input type="radio"/>	<input type="radio"/>	<input type="radio"/>	<input type="radio"/>
Tagged	<input type="radio"/>	<input type="radio"/>	<input type="radio"/>	<input type="radio"/>	<input type="radio"/>	<input type="radio"/>	<input type="radio"/>	<input type="radio"/>	<input type="radio"/>	<input type="radio"/>	<input type="radio"/>	<input type="radio"/>	<input type="radio"/>	<input type="radio"/>
NotMember	<input checked="" type="radio"/>	<input checked="" type="radio"/>	<input checked="" type="radio"/>	<input checked="" type="radio"/>	<input checked="" type="radio"/>	<input checked="" type="radio"/>	<input checked="" type="radio"/>	<input checked="" type="radio"/>	<input checked="" type="radio"/>	<input checked="" type="radio"/>	<input checked="" type="radio"/>	<input checked="" type="radio"/>	<input checked="" type="radio"/>	<input checked="" type="radio"/>
PVID	<input type="text" value="1"/>	<input type="text" value="1"/>	<input type="text" value="1"/>	<input type="text" value="1"/>	<input type="text" value="1"/>	<input type="text" value="1"/>	<input type="text" value="1"/>	<input type="text" value="1"/>	<input type="text" value="1"/>	<input type="text" value="1"/>	<input type="text" value="1"/>	<input type="text" value="1"/>	<input type="text" value="1"/>	<input type="text" value="1"/>
LAG	---	---	---	---	---	---	---	---	---	---	---	---	---	---
Port	15	16	17	18	19	20	21	22	23	24				
Untagged	<input type="radio"/>	<input type="radio"/>	<input type="radio"/>	<input type="radio"/>	<input type="radio"/>	<input type="radio"/>	<input type="radio"/>	<input type="radio"/>	<input type="radio"/>	<input type="radio"/>				
Tagged	<input type="radio"/>	<input type="radio"/>	<input type="radio"/>	<input type="radio"/>	<input type="radio"/>	<input type="radio"/>	<input type="radio"/>	<input type="radio"/>	<input type="radio"/>	<input type="radio"/>				
NotMember	<input checked="" type="radio"/>	<input checked="" type="radio"/>	<input checked="" type="radio"/>	<input checked="" type="radio"/>	<input checked="" type="radio"/>	<input checked="" type="radio"/>	<input checked="" type="radio"/>	<input checked="" type="radio"/>	<input checked="" type="radio"/>	<input checked="" type="radio"/>				
PVID	<input type="text" value="1"/>	<input type="text" value="1"/>	<input type="text" value="1"/>	<input type="text" value="1"/>	<input type="text" value="1"/>	<input type="text" value="1"/>	<input type="text" value="1"/>	<input type="text" value="1"/>	<input type="text" value="1"/>	<input type="text" value="1"/>				
LAG	---	---	---	---	---	---	---	---	---	---				

Figure 6-3 VLAN Table

To ensure the normal communication of the factory switch, the default VLAN of all ports is set to VLAN1.

The following entries are displayed on this screen:

➤ **VLAN Create**

VLAN ID: Enter the VLAN ID you want to create. It ranges from 2 to 4094.

Name: Give a name to the VLAN for identification.

➤ **VLAN Table**

VLAN ID Select: Click the **Select** button to quick-select the corresponding VLAN based on the VLAN ID you entered.

Select: Select the desired port for configuration.

VLAN ID: Displays the VLAN ID.

Name: Displays the name of the specific VLAN.

Untagged Ports: Show the untagged ports of the specific VLAN.

Tagged Ports: Show the tagged ports of the specific VLAN.

Operation: You can delete the specific VLAN when you click the word "Delete".

➤ **VLAN Membership**

- VLAN ID:** Displays the VLAN ID you choose.
- VLAN Name:** Here you can set the name of the VLAN you choose.
- Port:** Displays the port number.
- Untagged:** The port will be an untagged member of the specific VLAN if you select it.
- Tagged:** The port will be an tagged member of the specific VLAN if you select it.
- NotMember:** The port will not be a member of the specific VLAN if you select it.
- PVID:** Here you can change the PVID of the specific port.
- LAG:** Displays the LAG to which the port belongs to.

6.2 Application Example for 802.1Q VLAN

➤ **Network Requirements**

- Switch A is connecting to PC A and Server B;
- Switch B is connecting to PC B and Server A;
- PC A and Server A is in the same VLAN;
- PC B and Server B is in the same VLAN;
- PCs in the two VLANs cannot communicate with each other.

➤ **Network Diagram**

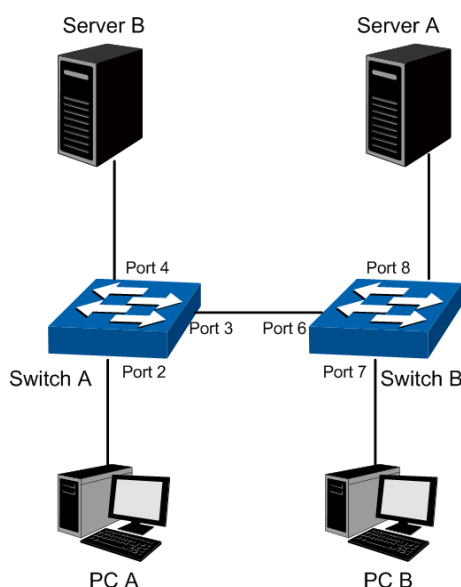

➤ **Configuration Procedure**

- Configure Switch A

Step	Operation	Description
1	Configure the Link Type of the ports	Required. On VLAN→802.1Q VLAN→VLAN Config page, configure the link type of Port 2, Port 3 and Port 4 as Untagged, Tagged and Untagged respectively

Step	Operation	Description
2	Create VLAN10	Required. On VLAN→802.1Q VLAN→VLAN Config page, create a VLAN with its VLAN ID as 10, owning Port 2 and Port 3.
3	Create VLAN20	Required. On VLAN→802.1Q VLAN→VLAN Config page, create a VLAN with its VLAN ID as 20, owning Port 3 and Port 4.

- Configure Switch B

Step	Operation	Description
1	Configure the Link Type of the ports	Required. On VLAN→802.1Q VLAN→VLAN Config page, configure the link type of Port 7, Port 6 and Port 8 as Untagged, Tagged and Untagged respectively.
2	Create VLAN10	Required. On VLAN→802.1Q VLAN→VLAN Config page, create a VLAN with its VLAN ID as 10, owning Port 6 and Port 8.
3	Create VLAN20	Required. On VLAN→802.1Q VLAN→VLAN Config page, create a VLAN with its VLAN ID as 20, owning Port 6 and Port 7.

[Return to CONTENTS](#)

Chapter 7 Spanning Tree

STP (Spanning Tree Protocol), subject to IEEE 802.1D standard, is to disbranch a ring network in the Data Link layer in a local network. Devices running STP discover loops in the network and block ports by exchanging information, in that way, a ring network can be disbranched to form a tree-topological ring-free network to prevent packets from being duplicated and forwarded endlessly in the network.

BPDU (Bridge Protocol Data Unit) is the protocol data that STP and RSTP use. Enough information is carried in BPDU to ensure the spanning tree generation. STP is to determine the topology of the network via transferring BPDUs between devices.

To implement spanning tree function, the switches in the network transfer BPDUs between each other to exchange information and all the switches supporting STP receive and process the received BPDUs. BPDUs carry the information that is needed for switches to figure out the spanning tree.

➤ STP Elements

Bridge ID (Bridge Identifier) : Indicates the value of the priority and MAC address of the bridge. Bridge ID can be configured and the switch with the lower bridge ID has the higher priority.

Root Bridge: Indicates the switch has the lowest bridge ID. Configure the best PC in the ring network as the root bridge to ensure best network performance and reliability.

Designated Bridge: Indicates the switch has the lowest path cost from the switch to the root bridge in each network segment. BPDUs are forwarded to the network segment through the designated bridge. The switch with the lowest bridge ID will be chosen as the designated bridge.

Root Path Cost: Indicates the sum of the path cost of the root port and the path cost of all the switches that packets pass through. The root path cost of the root bridge is 0.

Bridge Priority: The bridge priority can be set to a value in the range of 0~32768. The lower value priority has the higher priority. The switch with the higher priority has more chance to be chosen as the root bridge.

Root Port: Indicates the port that has the lowest path cost from this bridge to the Root Bridge and forwards packets to the root.

Designated Port: Indicates the port that forwards packets to a downstream network segment or switch.

Port Priority: The port priority can be set to a value in the range of 0~255. The lower value priority has the higher priority. The port with the higher priority has more chance to be chosen as the root port.

Path Cost: Indicates the parameter for choosing the link path by STP. By calculating the path cost, STP chooses the better links and blocks the redundant links so as to disbranch the ring-network to form a tree-topological ring-free network.

The following network diagram shows the sketch map of spanning tree. Switch A, B and C are connected together in order. After STP generation, switch A is chosen as a root bridge, the path from port 2 to port 6 is blocked.

- **Bridge**: Switch A is the root bridge in the whole network; switch B is the designated bridge of switch C.
- **Port**: Port 3 is the root port of switch B and port 5 is the root port of switch C; port 1 is the designated port of switch A and port 4 is the designated port of switch B; port 6 is the blocked port of switch C.

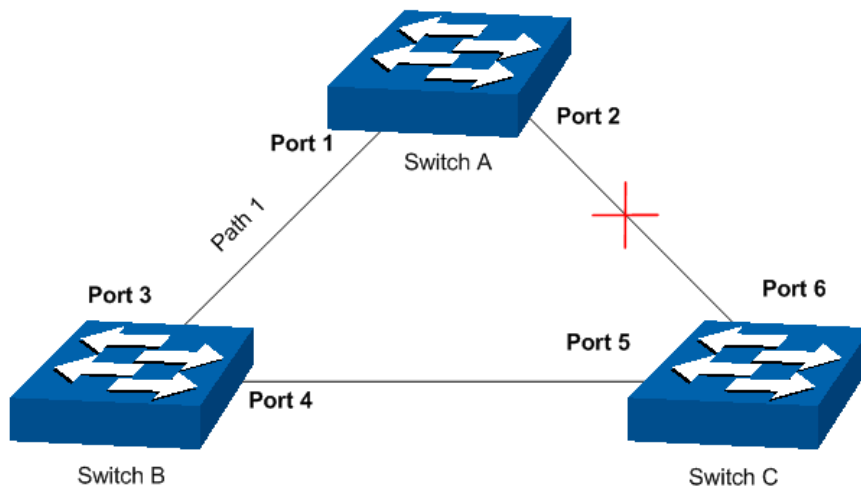

Figure 7-1 Basic STP diagram

➤ STP Timers

Hello Time:

Hello Time ranges from 1 to 10 seconds. It specifies the interval to send BPDU packets. It is used to test the links.

Max. Age:

Max. Age ranges from 6 to 40 seconds. It specifies the maximum time the switch can wait without receiving a BPDU before attempting to reconfigure.

Forward Delay:

Forward Delay ranges from 4 to 30 seconds. It specifies the time for the port to transit its state after the network topology is changed.

When the STP regeneration caused by network malfunction occurs, the STP structure will get some corresponding change. However, as the new configuration BPDUs cannot be spread in the whole network at once, the temporal loop will occur if the port transits its state immediately. Therefore, STP adopts a state transit mechanism, that is, the new root port and the designated port begins to forward data after twice forward delay, which ensures the new configuration BPDUs are spread in the whole network.

➤ BPDUs Comparing Principle in STP mode

Assuming two BPDUs: BPDU X and BPDU Y

If the root bridge ID of X is smaller than that of Y, X is superior to Y.

If the root bridge ID of X equals that of Y, but the root path cost of X is smaller than that of Y, X is superior to Y.

If the root bridge ID and the root path cost of X equal those of Y, but the bridge ID of X is smaller than that of Y, X is superior to Y.

If the root bridge ID, the root path cost and bridge ID of X equal those of Y, but the port ID of X is smaller than that of Y, X is superior to Y.

➤ STP Generation

- In the beginning

In the beginning, each switch regards itself as the root, and generates a configuration BPDU for each port on it as a root, with the root path cost being 0, the ID of the designated bridge being that of the switch, and the designated port being itself.

- Comparing BPDUs

Each switch sends out configuration BPDUs and receives a configuration BPDU on one of its ports from another switch. The following table shows the comparing operations.

Step	Operation
1	If the priority of the BPDU received on the port is lower than that of the BPDU if of the port itself, the switch discards the BPDU and does not change the BPDU of the port.
2	If the priority of the BPDU is higher than that of the BPDU of the port itself, the switch replaces the BPDU of the port with the received one and compares it with those of other ports on the switch to obtain the one with the highest priority.

Table 7-1 Comparing BPDUs

- Selecting the root bridge

The root bridge is selected by BPDU comparing. The switch with the smallest root ID is chosen as the root bridge.

- Selecting the root port and designate port

The operation is taken in the following way:

Step	Operation
1	For each switch (except the one chosen as the root bridge) in a network, the port that receives the BPDU with the highest priority is chosen as the root port of the switch.
2	Using the root port BPDU and the root path cost, the switch generates a designated port BPDU for each of its ports. <ul style="list-style-type: none"> • Root ID is replaced with that of the root port; • Root path is replaced with the sum of the root path cost of the root port and the path cost between this port and the root port; • The ID of the designated bridge is replaced with that of the switch; • The ID of the designated port is replaced with that of the port.
3	The switch compares the resulting BPDU with the BPDU of the desired port whose role you want to determine. <ul style="list-style-type: none"> • If the resulting BPDU takes the precedence over the BPDU of the port, the port is chosen as the designated port and the BPDU of this port is replaced with the resulting BPDU. The port regularly sends out the resulting BPDU; • If the BPDU of this port takes the precedence over the resulting BPDU, the BPDU of this port is not replaced and the port is blocked. The port only can receive BPDUs.

Table 7-2 Selecting root port and designated port



Tips:

In a STP with stable topology, only the root port and designated port can forward data, and the other ports are blocked. The blocked ports only can receive BPDUs.

RSTP (Rapid Spanning Tree Protocol), evolved from the 802.1D STP standard, enable Ethernet ports to transit their states rapidly. The premises for the port in the RSTP to transit its state rapidly are as follows.

- The condition for the root port to transit its port state rapidly: The old root port of the switch stops forwarding data and the designated port of the upstream switch begins to forward data.
- The condition for the designated port to transit its port state rapidly: The designated port is an edge port or connecting to a point-to-point link. If the designated port is an edge port, it can directly transit to forwarding state; if the designated port is connecting to a point-to-point link, it can transit to forwarding state after getting response from the downstream switch through handshake.

➤ **RSTP Elements**

Edge Port: Indicates the port connected directly to terminals.

P2P Link: Indicates the link between two switches directly connected.

MSTP (Multiple Spanning Tree Protocol), compatible with both STP and RSTP and subject to IEEE 802.1s standard, not only enables spanning trees to converge rapidly, but also enables packets of different VLANs to be forwarded along their respective paths so as to provide redundant links with a better load-balancing mechanism.

Features of MSTP:

- MSTP combines VLANs and spanning tree together via VLAN-to-instance mapping table. It binds several VLANs to an instance to save communication cost and network resources.
- MSTP divides a spanning tree network into several regions. Each region has several internal spanning trees, which are independent of each other.
- MSTP provides a load-balancing mechanism for the packets transmission in the VLAN.
- MSTP is compatible with both STP and RSTP.

➤ **MSTP Elements**

MST Region (Multiple Spanning Tree Region): An MST Region comprises switches with the same region configuration and VLAN-to-Instances mapping relationship.

IST (Internal Spanning Tree): An IST is a spanning tree in an MST.

CST (Common Spanning Tree): A CST is the spanning tree in a switched network that connects all MST regions in the network.

CIST (Common and Internal Spanning Tree): A CIST, comprising IST and CST, is the spanning tree in a switched network that connects all switches in the network.

The following figure shows the network diagram in MSTP.

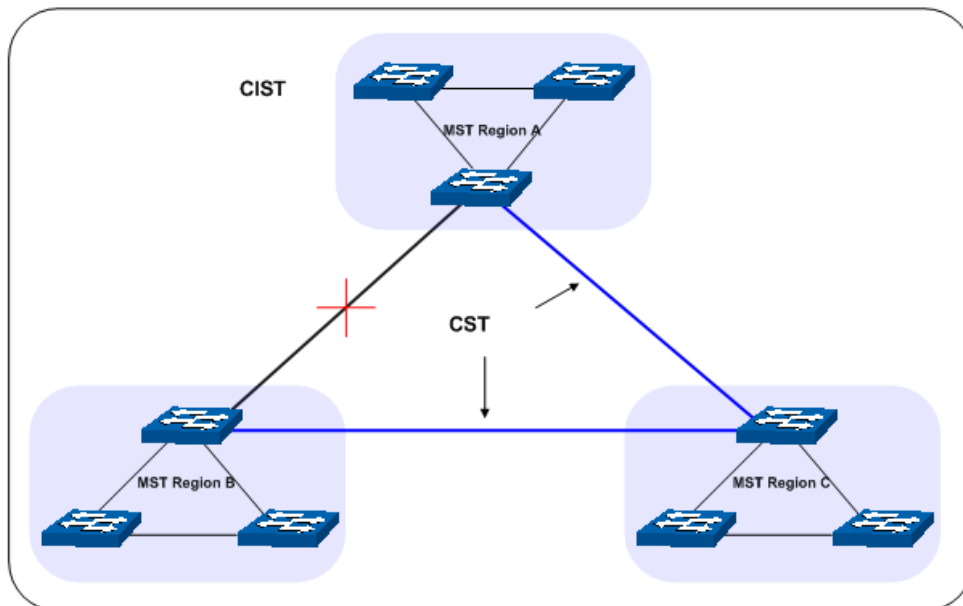

Figure 7-2 Basic MSTP diagram

➤ **MSTP**

MSTP divides a network into several MST regions. The CST is generated between these MST regions, and multiple spanning trees can be generated in each MST region. Each spanning tree is called an instance. As well as STP, MSTP uses BPDUs to generate spanning tree. The only difference is that the BPDUs for MSTP carry the MSTP configuration information on the switches.

➤ **Port States**

In an MSTP, ports can be in the following four states:

- Forwarding: In this status the port can receive/forward data, receive/send BPDUs as well as learn MAC address.
- Learning: In this status the port can receive/send BPDUs and learn MAC address.
- Blocking: In this status the port can only receive BPDUs.
- Disconnected: In this status the port is not participating in the STP.

➤ **Port Roles**

In an MSTP, the following roles exist:

- Root Port: Indicates the port that has the lowest path cost from this bridge to the Root Bridge and forwards packets to the root.
- Designated Port: Indicates the port that forwards packets to a downstream network segment or switch.
- Master Port: Indicates the port that connects a MST region to the common root. The path from the master port to the common root is the shortest path between this MST region and the common root.
- Alternate Port: Indicates the port that can be a backup port of a root or master port.
- Backup Port: Indicates the port that is the backup port of a designated port.
- Disabled: Indicates the port that is not participating in the STP.

The following diagram shows the different port roles.

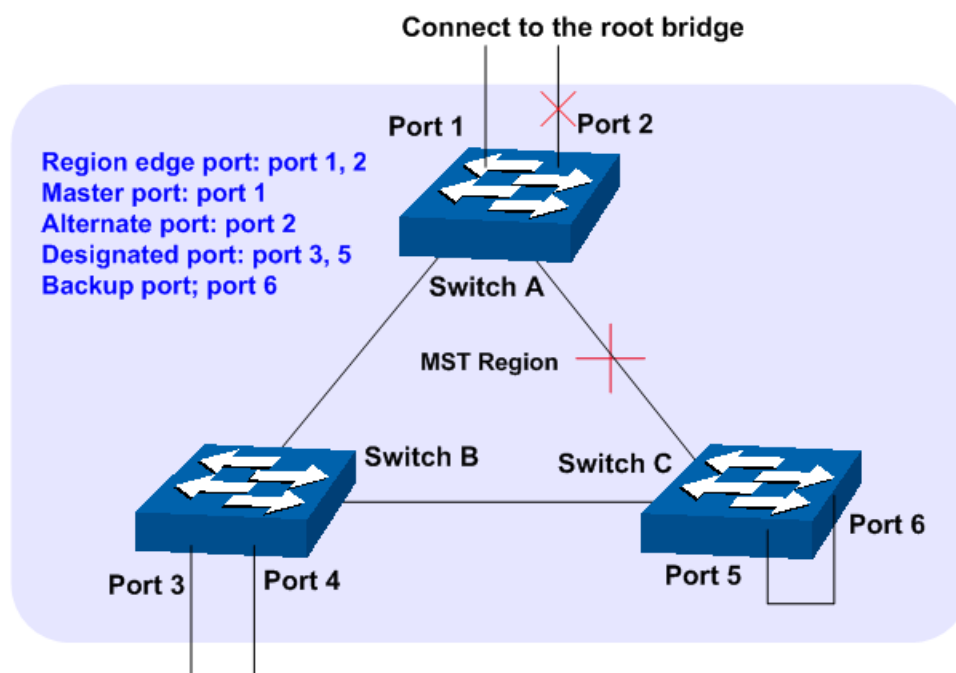

Figure 7-3 Port roles

The Spanning Tree module is mainly for spanning tree configuration of the switch, including four submenus: **STP Config**, **Port Config**, **MSTP Instance** and **STP Security**.

7.1 STP Config

The STP Config function, for global configuration of spanning trees on the switch, can be implemented on **STP Config** and **STP Summary** pages.

7.1.1 STP Config

Before configuring spanning trees, you should make clear the roles each switch plays in each spanning tree instance. Only one switch can be the root bridge in each spanning tree instance. On this page you can globally configure the spanning tree function and related parameters.

Choose the menu **Spanning Tree**→**STP Config**→**STP Config** to load the following page.

Global Config

STP: Enable Disable Apply

Version: STP v

Parameters Config

CIST Priority: 32768 (0-61440)

Hello Time: 2 sec (1-10)

Max Age: 20 sec (6-40) Apply

Forward Delay: 15 sec (4-30) Help

TxHoldCount: 5 pps (1-20)

Max Hops: 20 hop (1-40)

Figure 7-4 STP Config

The following entries are displayed on this screen:

➤ **Global Config**

STP: Select Enable/Disable STP function globally on the switch.

Version: Select the desired STP version on the switch.

- STP: Spanning Tree Protocol.
- RSTP: Rapid Spanning Tree Protocol.
- MSTP: Multiple Spanning Tree Protocol.

➤ **Parameters Config**

CIST Priority: Enter a value from 0 to 61440 to specify the priority of the switch for comparison in the CIST. CIST priority is an important criterion on determining the root bridge. In the same condition, the switch with the highest priority will be chosen as the root bridge. The lower value has the higher priority. The default value is 32768 and should be exact divisor of 4096.

Hello Time Enter a value from 1 to 10 in seconds to specify the interval to send BPDU packets. It is used to test the links. $2 * (\text{Hello Time} + 1) \leq \text{Max Age}$. The default value is 2 seconds.

Max Age: Enter a value from 6 to 40 in seconds to specify the maximum time the switch can wait without receiving a BPDU before attempting to reconfigure. The default value is 20 seconds.

Forward Delay: Enter a value from 4 to 30 in seconds to specify the time for the port to transit its state after the network topology is changed. $2 * (\text{Forward Delay} - 1) \geq \text{Max Age}$. The default value is 15 seconds.

TxHold Count: Enter a value from 1 to 20 to set the maximum number of BPDU packets transmitted per Hello Time interval. The default value is 5pps.

Max Hops: Enter a value from 1 to 40 to set the maximum number of hops that occur in a specific region before the BPDU is discarded. The default value is 20 hops.



Note:

1. The forward delay parameter and the network diameter are correlated. A too small forward delay parameter may result in temporary loops. A too large forward delay may cause a network unable to resume the normal state in time. The default value is recommended.
2. An adequate hello time parameter can enable the switch to discover the link failures occurred in the network without occupying too much network resources. A too large hello time parameter may result in normal links being regarded as invalid when packets drop occurred in the links, which in turn result in spanning tree being regenerated. A too small hello time parameter may result in duplicated configuration being sent frequently, which increases the network load of the switches and wastes network resources. The default value is recommended.
3. A too small max age parameter may result in the switches regenerating spanning trees frequently and cause network congestions to be falsely regarded as link problems. A too large max age parameter result in the switches unable to find the link problems in time, which in turn handicaps spanning trees being regenerated in time and makes the network less adaptive. The default value is recommended.

4. If the TxHold Count parameter is too large, the number of MSTP packets being sent in each hello time may be increased with occupying too much network resources. The default value is recommended.

7.1.2 STP Summary

On this page you can view the related parameters for Spanning Tree function.

Choose the menu **Spanning Tree**→**STP Config**→**STP Summary** to load the following page.

STP Summary	
STP Status:	Disable
STP Version:	---
Local Bridge:	---
Root Bridge:	---
External Path Cost:	---
Region Root:	---
Internal Path Cost:	---
Designated Bridge:	---
Root Port:	---
Latest TC Time:	---
TC Count:	0

MSTP Instance Summary	
Instance ID	1 ▾
Instance Status:	Disable
Local Bridge:	---
Region Root:	---
Internal Path Cost:	---
Designated Bridge:	---
Root Port:	---
Latest TC Time:	---
TC Count:	---

Figure 7-5 STP Summary

7.2 Port Config

On this page you can configure the parameters of the ports for CIST

Choose the menu **Spanning Tree**→**Port Config** to load the following page.

Select	Port	Status	Priority	ExtPath Cost	IntPath Cost	Edge Port	P2P Link	MCheck	STP Version	Port Role	Port Status	LAG
<input type="checkbox"/>		Disable				Disable	Auto	Unchange				
<input type="checkbox"/>	1	Disable	128	Auto	Auto	Disable	Auto	---	---	---	---	---
<input type="checkbox"/>	2	Disable	128	Auto	Auto	Disable	Auto	---	---	---	---	---
<input type="checkbox"/>	3	Disable	128	Auto	Auto	Disable	Auto	---	---	---	---	---
<input type="checkbox"/>	4	Disable	128	Auto	Auto	Disable	Auto	---	---	---	---	---
<input type="checkbox"/>	5	Disable	128	Auto	Auto	Disable	Auto	---	---	---	---	---
<input type="checkbox"/>	6	Disable	128	Auto	Auto	Disable	Auto	---	---	---	---	---
<input type="checkbox"/>	7	Disable	128	Auto	Auto	Disable	Auto	---	---	---	---	---
<input type="checkbox"/>	8	Disable	128	Auto	Auto	Disable	Auto	---	---	---	---	---
<input type="checkbox"/>	9	Disable	128	Auto	Auto	Disable	Auto	---	---	---	---	---
<input type="checkbox"/>	10	Disable	128	Auto	Auto	Disable	Auto	---	---	---	---	LAG1
<input type="checkbox"/>	11	Disable	128	Auto	Auto	Disable	Auto	---	---	---	---	LAG1
<input type="checkbox"/>	12	Disable	128	Auto	Auto	Disable	Auto	---	---	---	---	LAG1
<input type="checkbox"/>	13	Disable	128	Auto	Auto	Disable	Auto	---	---	---	---	LAG1
<input type="checkbox"/>	14	Disable	128	Auto	Auto	Disable	Auto	---	---	---	---	---
<input type="checkbox"/>	15	Disable	128	Auto	Auto	Disable	Auto	---	---	---	---	---

Note:

If the Path Cost of a port is set to 0, it will alter automatically according to the port's link speed.

Figure 7-6 Port Config

The following entries are displayed on this screen:

➤ **Port Config**

Port Select: Click the **Select** button to quick-select the corresponding port based on the port number you entered.

Select: Select the desired port for STP configuration. It is multi-optional.

Port: Displays the port number of the switch.

Status: Select Enable /Disable STP function for the desired port.

Priority: Enter a value from 0 to 240 divisible by 16. Port priority is an important criterion on determining if the port connected to this port will be chosen as the root port. The lower value has the higher priority.

ExtPath: ExtPath Cost is used to choose the path and calculate the path costs of ports in different MST regions. It is an important criterion on determining the root port. The lower value has the higher priority.

IntPath: IntPath Cost is used to choose the path and calculate the path costs of ports in an MST region. It is an important criterion on determining the root port. The lower value has the higher priority.

Edge Port: Select Enable/Disable Edge Port. The edge port can transit its state from blocking to forwarding rapidly without waiting for forward delay.

P2P Link: Select the P2P link status. If the two ports in the P2P link are root port or designated port, they can transit their states to forwarding rapidly to reduce the unnecessary forward delay.

- MCheck:** Select Enable to perform MCheck operation on the port. Unchange means no MCheck operation.
- STP Version:** Displays the STP version of the port.
- Port Role:** Displays the role of the port played in the STP Instance.
- Root Port: Indicates the port that has the lowest path cost from this bridge to the Root Bridge and forwards packets to the root.
 - Designated Port: Indicates the port that forwards packets to a downstream network segment or switch.
 - Master Port: Indicates the port that connects a MST region to the common root. The path from the master port to the common root is the shortest path between this MST region and the common root.
 - Alternate Port: Indicates the port that can be a backup port of a root or master port.
 - Backup Port: Indicates the port that is the backup port of a designated port.
 - Disabled: Indicates the port that is not participating in the STP.
- Port Status:** Displays the working status of the port.
- Forwarding: In this status the port can receive/forward data, receive/send BPDU packets as well as learn MAC address.
 - Learning: In this status the port can receive/send BPDU packets and learn MAC address.
 - Blocking: In this status the port can only receive BPDU packets.
 - Disconnected: In this status the port is not participating in the STP.
- LAG:** Displays the LAG number which the port belongs to.



Note:

1. Configure the ports connected directly to terminals as edge ports and enable the BPDU protection function as well. This not only enables these ports to transit to forwarding state rapidly but also secures your network.
2. All the links of ports in a LAG can be configured as point-to-point links.
3. When the link of a port is configured as a point-to-point link, the spanning tree instances owning this port are configured as point-to-point links. If the physical link of a port is not a point-to-point link and you forcibly configure the link as a point-to-point link, temporary loops may be incurred.

7.3 MSTP Instance

MSTP combines VLANs and spanning tree together via VLAN-to-instance mapping table (VLAN-to-spanning-tree mapping). By adding MSTP instances, it binds several VLANs to an instance to realize the load balance based on instances.

Only when the switches have the same MST region name, MST region revision and VLAN-to-Instance mapping table, the switches can be regarded as in the same MST region.

The MSTP Instance function can be implemented on **Region Config**, **Instance Config** and **Instance Port Config** pages.

7.3.1 Region Config

On this page you can configure the name and revision of the MST region

Choose the menu **Spanning Tree** → **MSTP Instance** → **Region Config** to load the following page.

Figure 7-7 Region Config

The following entries are displayed on this screen:

➤ **Region Config**

Region Name: Create a name for MST region identification using up to 32 characters.

Revision: Enter the revision from 0 to 65535 for MST region identification.

7.3.2 Instance Config

Instance Configuration, a property of MST region, is used to describe the VLAN to Instance mapping configuration. You can assign VLAN to different instances appropriate to your needs. Every instance is a VLAN group independent of other instances and CIST.

Choose the menu **Spanning Tree** → **MSTP Instance** → **Instance Config** to load the following page.

Select	Instance	Status	Priority	VLAN ID	
<input type="checkbox"/>			<input type="text"/>	<input type="text"/>	
<input type="checkbox"/>	1	Disable	32768		Clear
<input type="checkbox"/>	2	Disable	32768		Clear
<input type="checkbox"/>	3	Disable	32768		Clear
<input type="checkbox"/>	4	Disable	32768		Clear
<input type="checkbox"/>	5	Disable	32768		Clear
<input type="checkbox"/>	6	Disable	32768		Clear
<input type="checkbox"/>	7	Disable	32768		Clear
<input type="checkbox"/>	8	Disable	32768		Clear
	CIST	Enable	32768	1-4094,	

Note:

The format of input VLAN ID should be like '1, 3, 4-7, 11-30' in the range from 1 to 4094.

Figure 7-8 Instance Config

The following entries are displayed on this screen:

➤ **Instance Table**

Instance ID Select: Click the **Select** button to quick-select the corresponding Instance ID based on the ID number you entered.

Select: Select the desired Instance ID for configuration. It is multi-optional.

Instance: Displays Instance ID of the switch.

Status: Displays status of the instance.

Priority: Enter the priority of the switch in the instance. It is an important criterion on determining if the switch will be chosen as the root bridge in the specific instance.

VLAN ID: Enter the VLAN ID which belongs to the corresponding instance ID. After modification here, the previous VLAN ID will be cleared and mapped to the CIST.

Clear: Click the **Clear** button to clear up all VLAN IDs from the instance ID. The cleared VLAN ID will be automatically mapped to the CIST.

➤ **VLAN-Instance Mapping**

VLAN ID: Enter the desired VLAN ID. After modification here, the new VLAN ID will be added to the corresponding instance ID and the previous VLAN ID won't be replaced.

Instance ID: Enter the corresponding instance ID.

7.3.3 Instance Port Config

A port can play different roles in different spanning tree instance. On this page you can configure the parameters of the ports in different instance IDs as well as view status of the ports in the specified instance.

Choose the menu **Spanning Tree**→**MSTP Instance**→**Instance Port Config** to load the following page.

Select	Port	Priority	Path Cost	Port Role	Port Status	LAG
<input type="checkbox"/>						
<input type="checkbox"/>	1	128	Auto	---	---	---
<input type="checkbox"/>	2	128	Auto	---	---	---
<input type="checkbox"/>	3	128	Auto	---	---	---
<input type="checkbox"/>	4	128	Auto	---	---	---
<input type="checkbox"/>	5	128	Auto	---	---	---
<input type="checkbox"/>	6	128	Auto	---	---	---
<input type="checkbox"/>	7	128	Auto	---	---	---
<input type="checkbox"/>	8	128	Auto	---	---	---
<input type="checkbox"/>	9	128	Auto	---	---	---
<input type="checkbox"/>	10	128	Auto	---	---	LAG1
<input type="checkbox"/>	11	128	Auto	---	---	LAG1
<input type="checkbox"/>	12	128	Auto	---	---	LAG1
<input type="checkbox"/>	13	128	Auto	---	---	LAG1
<input type="checkbox"/>	14	128	Auto	---	---	---
<input type="checkbox"/>	15	128	Auto	---	---	---

Note:

If the Path Cost of a port is set to 0, it will alter automatically according to the port's link speed.

Figure 7-9 Instance Port Config

The following entries are displayed on this screen:

➤ **Port Config**

- Instance ID:** Select the desired instance ID for its port configuration.
- Port Select:** Click the **Select** button to quick-select the corresponding port based on the port number you entered.
- Select:** Select the desired port to specify its priority and path cost. It is multi-optional.
- Port:** Displays the port number of the switch.
- Priority:** Enter the priority of the port in the instance. It is an important criterion on determining if the port connected to this port will be chosen as the root port.
- Path Cost:** Path Cost is used to choose the path and calculate the path costs of ports in an MST region. It is an important criterion on determining the root port. The lower value has the higher priority.
- Port Role:** Displays the role of the port played in the MSTP Instance.
- Port Status:** Displays the working status of the port.
- LAG:** Displays the LAG number which the port belongs to.



Note:

The port status of one port in different spanning tree instances can be different.

Global configuration Procedure for Spanning Tree function:

Step	Operation	Description
1	Make clear roles the switches play in spanning tree instances: root bridge or designated bridge	Preparation.
2	Globally configure MSTP parameters	Required. Enable Spanning Tree function on the switch and configure MSTP parameters on Spanning Tree → STP Config → STP Config page.
3	Configure MSTP parameters for ports	Required. Configure MSTP parameters for ports on Spanning Tree → Port Config → Port Config page.
4	Configure the MST region	Required. Create MST region and configure the role the switch plays in the MST region on Spanning Tree → MSTP Instance → Region Config and Instance Config page.
5	Configure MSTP parameters for instance ports	Optional. Configure different instances in the MST region and configure MSTP parameters for instance ports on Spanning Tree → MSTP Instance → Instance Port Config page.

7.4 STP Security

Configuring protection function for devices can prevent devices from any malicious attack against STP features. The STP Security function can be implemented on **Port Protect** and **TC Protect** pages.

Port Protect function is to prevent the devices from any malicious attack against STP features.

7.4.1 Port Protect

On this page you can configure loop protect feature, root protect feature, TC protect feature, BPDU protect feature and BPDU filter feature for ports. You are suggested to enable corresponding protection feature for the qualified ports.

➤ Loop Protect

In a stable network, a switch maintains the states of ports by receiving and processing BPDU packets from the upstream switch. However, when link congestions or link failures occurred to the network, a down stream switch does not receive BPDU packets for certain period, which results in spanning trees being regenerated and roles of ports being reselected, and causes the blocked ports to transit to forwarding state. Therefore, loops may be incurred in the network.

The loop protect function can suppresses loops. With this function enabled, a port, regardless of the role it plays in instances, is always set to blocking state, when the port does not receive BPDU packets from the upstream switch and spanning trees are regenerated, and thereby loops can be prevented.

➤ Root Protect

A CIST and its secondary root bridges are usually located in the high-bandwidth core region. Wrong configuration or malicious attacks may result in configuration BPDU packets with higher priorities being received by the legal root bridge, which causes the current legal root bridge to lose

its position and network topology jitter to occur. In this case, flows that should travel along high-speed links may lead to low-speed links, and network congestion may occur.

To avoid this, MSTP provides root protect function. Ports with this function enabled can only be set as designated ports in all spanning tree instances. When a port of this type receives BPDU packets with higher priority, it transits its state to blocking state and stops forwarding packets (as if it is disconnected from the link). The port resumes the normal state if it does not receive any configuration BPDU packets with higher priorities for a period of two times of forward delay.

➤ **TC Protect**

A switch removes MAC address entries upon receiving TC-BPDU packets. If a user maliciously sends a large amount of TC-BPDU packets to a switch in a short period, the switch will be busy with removing MAC address entries, which may decrease the performance and stability of the network.

To prevent the switch from frequently removing MAC address entries, you can enable the TC protect function on the switch. With TC protect function enabled, if the account number of the received TC-BPDUs exceeds the maximum number you set in the TC threshold field, the switch will not perform the removing operation in the TC protect cycle. Such a mechanism prevents the switch from frequently removing MAC address entries.

➤ **BPDU Protect**

Ports of the switch directly connected to PCs or servers are configured as edge ports to rapidly transit their states. When these ports receive BPDUs, the system automatically configures these ports as non-edge ports and regenerates spanning trees, which may cause network topology jitter. Normally these ports do not receive BPDUs, but if a user maliciously attacks the switch by sending BPDUs, network topology jitter occurs.

To prevent this attack, MSTP provides BPDU protect function. With this function enabled on the switch, the switch shuts down the edge ports that receive BPDUs and reports these cases to the administrator. If a port is shut down, only the administrator can restore it.

➤ **BPDU Filter**

BPDU filter function is to prevent BPDUs flood in the STP network. If a switch receives malicious BPDUs, it forwards these BPDUs to the other switched in the network, which may result in spanning trees being continuously regenerated. In this case, the switch occupying too much CPU or the protocol status of BPDUs is wrong.

With BPDU filter function enabled, a port does not receive or forward BPDUs, but it sends out its own BPDUs. Such a mechanism prevents the switch from being attacked by BPDUs so as to guarantee generation the spanning trees correct.

Choose the menu **Spanning Tree**→**STP Security**→**Port Protect** to load the following page.

Select	Port	Loop Protect	Root Protect	TC Protect	BPDU Protect	BPDU Filter	LAG
<input type="checkbox"/>		Disable	Disable	Disable	Disable	Disable	
<input type="checkbox"/>	1	Disable	Disable	Disable	Disable	Disable	---
<input type="checkbox"/>	2	Disable	Disable	Disable	Disable	Disable	---
<input type="checkbox"/>	3	Disable	Disable	Disable	Disable	Disable	---
<input type="checkbox"/>	4	Disable	Disable	Disable	Disable	Disable	---
<input type="checkbox"/>	5	Disable	Disable	Disable	Disable	Disable	---
<input type="checkbox"/>	6	Disable	Disable	Disable	Disable	Disable	---
<input type="checkbox"/>	7	Disable	Disable	Disable	Disable	Disable	---
<input type="checkbox"/>	8	Disable	Disable	Disable	Disable	Disable	---
<input type="checkbox"/>	9	Disable	Disable	Disable	Disable	Disable	---
<input type="checkbox"/>	10	Disable	Disable	Disable	Disable	Disable	LAG1
<input type="checkbox"/>	11	Disable	Disable	Disable	Disable	Disable	LAG1
<input type="checkbox"/>	12	Disable	Disable	Disable	Disable	Disable	LAG1
<input type="checkbox"/>	13	Disable	Disable	Disable	Disable	Disable	LAG1
<input type="checkbox"/>	14	Disable	Disable	Disable	Disable	Disable	---
<input type="checkbox"/>	15	Disable	Disable	Disable	Disable	Disable	---

Figure 7-10 Port Protect

The following entries are displayed on this screen:

➤ **Port Protect**

- Port Select:** Click the **Select** button to quick-select the corresponding port based on the port number you entered.
- Select:** Select the desired port for port protect configuration. It is multi-optional.
- Port:** Displays the port number of the switch.
- Loop Protect:** Loop Protect is to prevent the loops in the network brought by recalculating STP because of link failures and network congestions.
- Root Protect:** Root Protect is to prevent wrong network topology change caused by the role change of the current legal root bridge.
- TC Protect:** TC Protect is to prevent the decrease of the performance and stability of the switch brought by continuously removing MAC address entries upon receiving TC-BPDUs in the STP network.
- BPDU Protect:** BPDU Protect is to prevent the edge port from being attacked by maliciously created BPDUs
- BPDU Filter:** BPDU Filter is to prevent BPDUs flood in the STP network.
- LAG:** Displays the LAG number which the port belongs to.

7.4.2 TC Protect

When TC Protect is enabled for the port on **Port Protect** page, the TC threshold and TC protect cycle need to be configured on this page.

Choose the menu **Spanning Tree**→**STP Security**→**TC Protect** to load the following page.

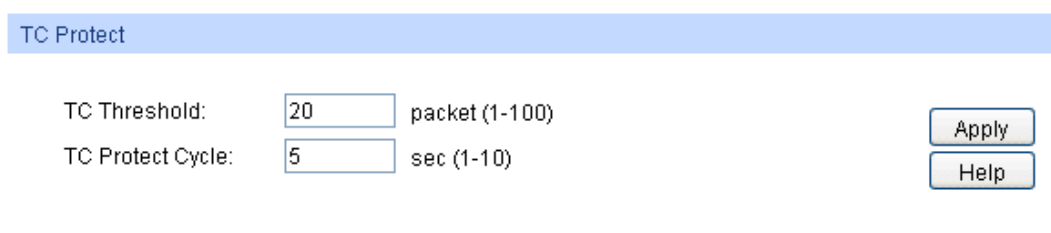

TC Protect

TC Threshold: packet (1-100)

TC Protect Cycle: sec (1-10)

Apply

Help

Figure 7-11 TC Protect

The following entries are displayed on this screen:

➤ TC Protect

TC Threshold: Enter a number from 1 to 100. It is the maximum number of the TC-BPDUs received by the switch in a TC Protect Cycle. The default value is 20.

TC Protect Cycle: Enter a value from 1 to 10 to specify the TC Protect Cycle. The default value is 5.

7.5 Application Example for STP Function

➤ Network Requirements

- Switch A, B, C, D and E all support MSTP function.
- A is the central switch.
- B and C are switches in the convergence layer. D, E and F are switches in the access layer.
- There are 6 VLANs labeled as VLAN101-VLAN106 in the network.
- All switches run MSTP and belong to the same MST region.
- The data in VLAN101, 103 and 105 are transmitted in the STP with B as the root bridge. The data in VLAN102, 104 and 106 are transmitted in the STP with C as the root bridge.

➤ **Network Diagram**

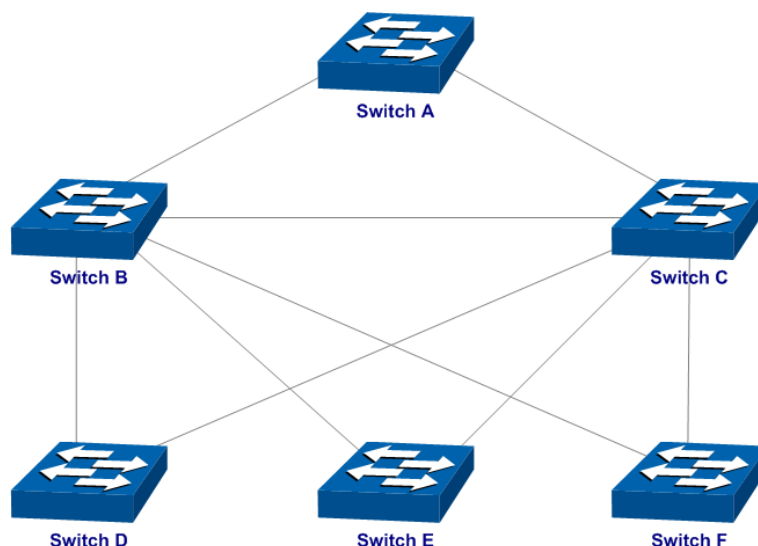

➤ **Configuration Procedure**

- Configure Switch A:

Step	Operation	Description
1	Configure ports	On VLAN→802.1Q VLAN page, configure the link type of the related ports as Tagged, and add the ports to VLAN101-VLAN106. The detailed instructions can be found in the section 802.1Q VLAN .
2	Enable STP function	On Spanning Tree→STP Config→STP Config page, enable STP function and select MSTP version. On Spanning Tree→STP Config→Port Config page, enable MSTP function for the port.
3	Configure the region name and the revision of MST region	On Spanning Tree→MSTP Instance→Region Config page, configure the region as TP-LINK and keep the default revision setting.
4	Configure VLAN-to-Instance mapping table of the MST region	On Spanning Tree→MSTP Instance→Instance Config page, configure VLAN-to-Instance mapping table. Map VLAN 101, 103 and 105 to Instance 1; map VLAN 102, 104 and 106 to Instance 2.

- Configure Switch B:

Step	Operation	Description
1	Configure ports	On VLAN→802.1Q VLAN page, configure the link type of the related ports as Tagged, and add the ports to VLAN101-VLAN106. The detailed instructions can be found in the section 802.1Q VLAN .

2	Enable STP function	On Spanning Tree → STP Config → STP Config page, enable STP function and select MSTP version. On Spanning Tree → STP Config → Port Config page, enable MSTP function for the port.
3	Configure the region name and the revision of MST region	On Spanning Tree → MSTP Instance → Region Config page, configure the region as TP-LINK and keep the default revision setting.
4	Configure VLAN-to-Instance mapping table of the MST region	On Spanning Tree → MSTP Instance → Instance Config page, configure VLAN-to-Instance mapping table. Map VLAN 101, 103 and 105 to Instance 1; map VLAN 102, 104 and 106 to Instance 2.
5	Configure switch B as the root bridge of Instance 1	On Spanning Tree → MSTP Instance → Instance Config page, configure the priority of Instance 1 to be 0.
6	Configure switch B as the designated bridge of Instance 2	On Spanning Tree → MSTP Instance → Instance Config page, configure the priority of Instance 2 to be 4096.

- Configure Switch C:

Step	Operation	Description
1	Configure ports	On VLAN → 802.1Q VLAN page, configure the link type of the related ports as Tagged, and add the ports to VLAN101-VLAN106. The detailed instructions can be found in the section 802.1Q VLAN .
2	Enable STP function	On Spanning Tree → STP Config → STP Config page, enable STP function and select MSTP version. On Spanning Tree → STP Config → Port Config page, enable MSTP function for the port.
3	Configure the region name and the revision of MST region	On Spanning Tree → MSTP Instance → Region Config page, configure the region as TP-LINK and keep the default revision setting.
4	Configure VLAN-to-Instance mapping table of the MST region	On Spanning Tree → MSTP Instance → Instance Config page, configure VLAN-to-Instance mapping table. Map VLAN101, 103 and 105 to Instance 1; map VLAN102, 104 and 106 to Instance 2.
5	Configure switch C as the root bridge of Instance 1	On Spanning Tree → MSTP Instance → Instance Config page, configure the priority of Instance 1 to be 4096.
6	Configure switch C as the root bridge of Instance 2	On Spanning Tree → MSTP Instance → Instance Config page, configure the priority of Instance 2 to be 0.

- Configure Switch D:

Step	Operation	Description
1	Configure ports	On VLAN→802.1Q VLAN page, configure the link type of the related ports as Tagged, and add the ports to VLAN101-VLAN106. The detailed instructions can be found in the section 802.1Q VLAN .
2	Enable STP function	On Spanning Tree→STP Config→STP Config page, enable STP function and select MSTP version. On Spanning Tree→STP Config→Port Config page, enable MSTP function for the port.
3	Configure the region name and the revision of MST region	On Spanning Tree→MSTP Instance→Region Config page, configure the region as TP-LINK and keep the default revision setting.
4	Configure VLAN-to-Instance mapping table of the MST region	On Spanning Tree→MSTP Instance→Instance Config page, configure VLAN-to-Instance mapping table. Map VLAN101, 103 and 105 to Instance 1; map VLAN102, 104 and 106 to Instance 2.

- The configuration procedure for switch E and F is the same with that for switch D.

➤ **The topology diagram of the two instances after the topology is stable**

- For Instance 1 (VLAN101, 103 and 105), the red paths in the following figure are connected links; the gray paths are the blocked links.

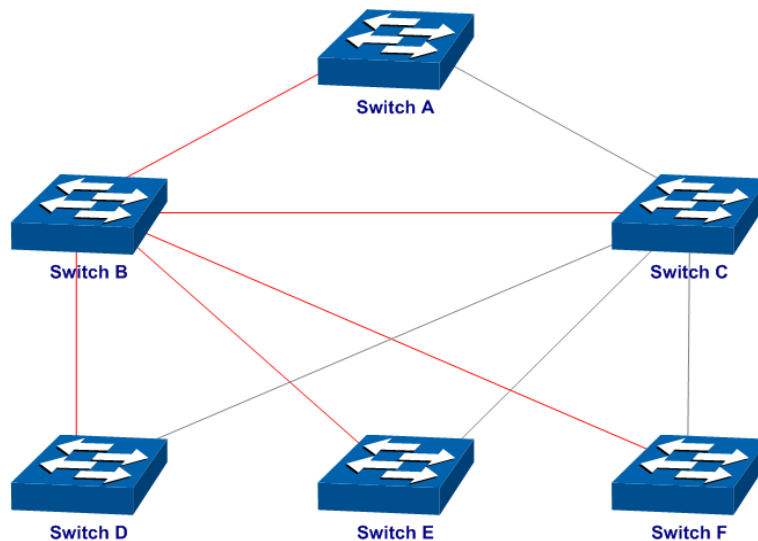

- For Instance 2 (VLAN102, 104 and 106), the blue paths in the following figure are connected links; the gray paths are the blocked links.

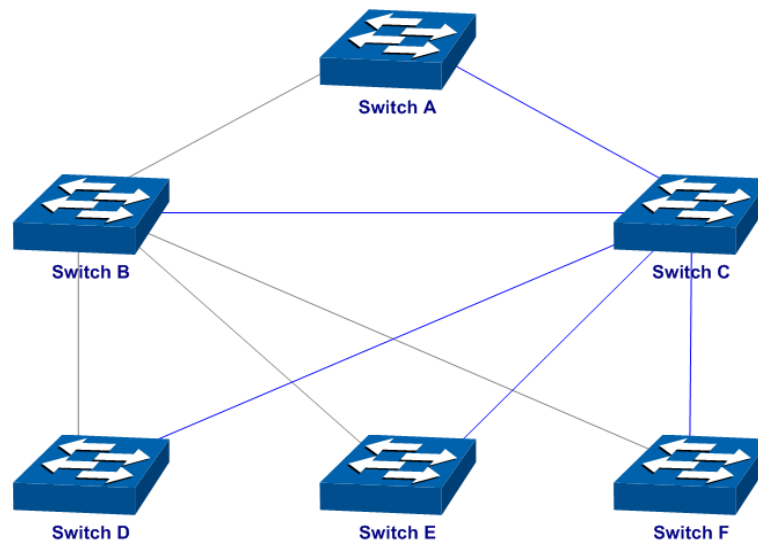

➤ **Suggestion for Configuration**

- Enable TC Protect function for all the ports of switches.
- Enable Root Protect function for all the ports of root bridges.
- Enable Loop Protect function for the non-edge ports.

Enable BPDU Protect function or BPDU Filter function for the edge ports which are connected to the PC and server.

[Return to CONTENTS](#)

Chapter 8 Multicast

➤ Multicast Overview

In the network, packets are sent in three modes: unicast, broadcast and multicast. In unicast, the source server sends separate copy information to each receiver. When a large number of users require this information, the server must send many pieces of information with the same content to the users. Therefore, large bandwidth will be occupied. In broadcast, the system transmits information to all users in a network. Any user in the network can receive the information, no matter the information is needed or not.

Point-to-multipoint multimedia business, such as video conferences and VoD (video-on-demand), plays an important part in the information transmission field. Suppose a point to multi-point service is required, unicast is suitable for networks with sparsely users, whereas broadcast is suitable for networks with densely distributed users. When the number of users requiring this information is not certain, unicast and broadcast deliver a low efficiency. Multicast solves this problem. It can deliver a high efficiency to send data in the point to multi-point service, which can save large bandwidth and reduce the network load. In multicast, the packets are transmitted in the following way as shown in Figure 8-1.

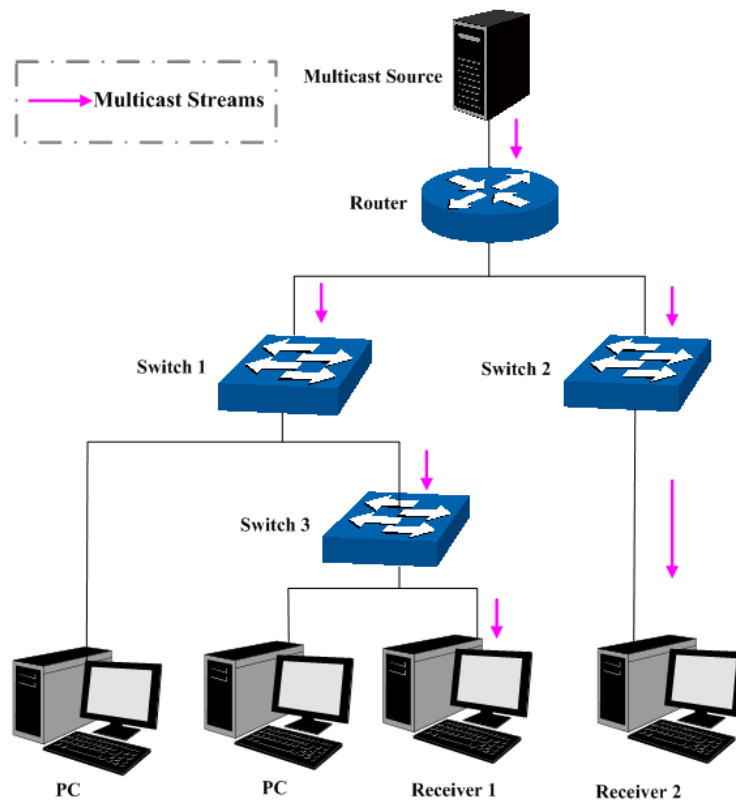

Figure 8-1 Information transmission in the multicast mode

Features of multicast:

1. The number of receivers is not certain. Usually point-to-multipoint transmission is needed;
2. Multiple users receiving the same information form a multicast group. The multicast information sender just need to send the information to the network device once;
3. Each user can join and leave the multicast group at any time;
4. Real time is highly demanded and certain packets drop is allowed.

➤ **IPv4 Multicast Address**

1. IPv4 Multicast IP Address:

As specified by IANA (Internet Assigned Numbers Authority), Class D IP addresses are used as destination addresses of multicast packets. The multicast IP addresses range from 224.0.0.0~239.255.255.255. The following table displays the range and description of several special multicast IP addresses.

Multicast IP address range	Description
224.0.0.0~224.0.0.255	Reserved multicast addresses for routing protocols and other network protocols
224.0.1.0~224.0.1.255	Addresses for video conferencing
239.0.0.0~239.255.255.255	Local management multicast addresses, which are used in the local network only

Table 8-1 Range of the special multicast IP

2. IPv4 Multicast MAC Address:

When a unicast packet is transmitted in an Ethernet network, the destination MAC address is the MAC address of the receiver. When a multicast packet is transmitted in an Ethernet network, the destination is not a receiver but a group with uncertain number of members, so a multicast MAC address, a logical MAC address, is needed to be used as the destination address.

As stipulated by IANA, the high-order 24 bits of a multicast MAC address begins with 01-00-5E while the low-order 23 bits of a multicast MAC address are the low-order 23 bits of the multicast IP address. The mapping relationship is described as Figure 8-2.

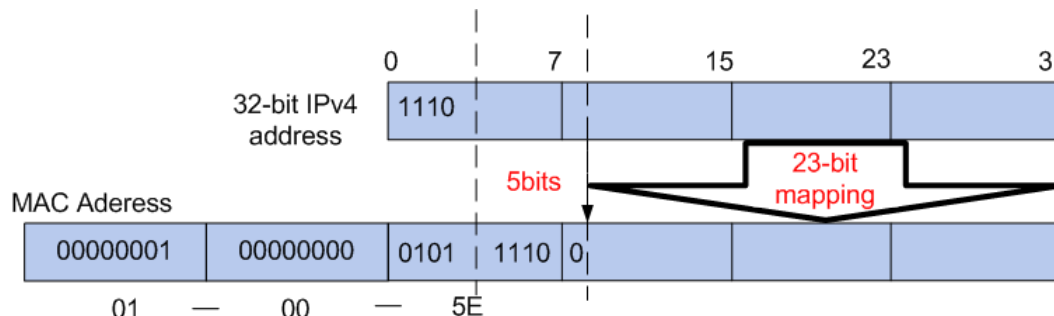

Figure 8-2 Mapping relationship between multicast IPv4 address and multicast MAC address

The high-order 4 bits of the IP multicast address are 1110, identifying the multicast group. Only 23 bits of the remaining low-order 28 bits are mapped to a multicast MAC address. In that way, 5 bits of the IP multicast address is not utilized. As a result, 32 IP multicast addresses are mapped to the same MAC addresses.

➤ **IPv6 Multicast Address**

1. IPv6 Multicast Address

An IPv6 multicast address is an identifier for a group of interfaces, and has the following format:

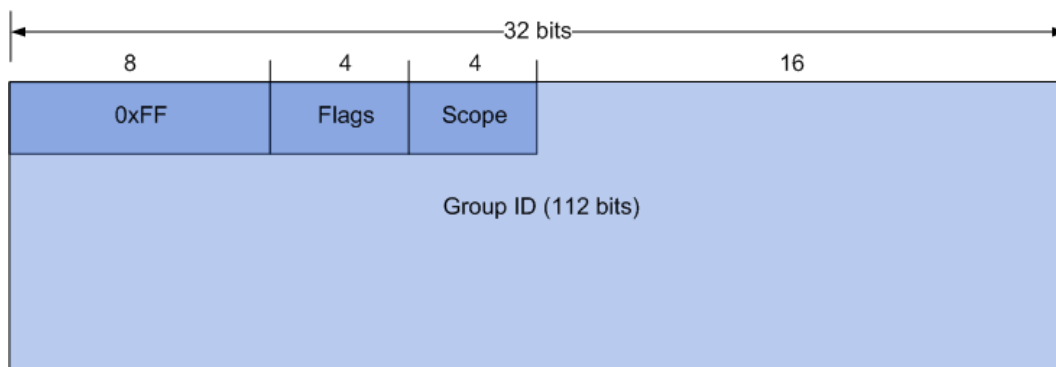

- 0XFF at the start of the address identifies the address as being a multicast address.
- Flags have 4 bits:



- (1) The high-order flag is reserved, and must be initialized to 0.
 - (2) R: Set to 0 to indicate this IPv6 multicast address does not contain an embedded RP address; set to 1 to indicate this IPv6 multicast address contains an embedded RP address. When this bit is set to 1, the P and T bits must also be set to 1.
 - (3) P: Set to 0 to indicate this IPv6 multicast address is not based on a unicast prefix; set to 1 to indicate this IPv6 multicast address is based on a unicast prefix. When this bit is set to 1, the T bit must also be set to 1.
 - (4) T: Set to 0 to indicate that this address is an IPv6 multicast address permanently assigned by the Internet Assigned Numbers Authority (IANA); set to 1 to indicate that this address is a transient, or dynamically assigned IPv6 multicast address.
- Scope is a 4-bit value used to limit the scope of the multicast group. The values are as follows:

Value	Indication
0、3、F	reserved
1	Interface-Local scope
2	Link-Local scope
4	Admin-Local scope
5	Site-Local scope
6、7、9~D	unassigned
8	Organization-local scope
E	Global scope

Table 8-2 Indications of the Scope

- Group ID: 112 bits, IPv6 multicast group identifier that uniquely identifies an IPv6 multicast group in the scope defined by the Scope field.

Reserved Multicast Addresses:

Address	Indication
FF01::1	All interface-local IPv6 nodes
FF02::1	All link-local IPv6 nodes
FF01::2	All interface-local IPv6 routers
FF02::2	All link-local IPv6 routers
FF05::2	All site-local IPv6 routers
FF0X::	X ranges from 0 to F. These multicast addresses are reserved and shall never be assigned to any multicast group.

Table 8-3 Reserved IPv6 Multicast Addresses

The solicited-node multicast address is a multicast group that corresponds to an IPv6 unicast or anycast address. It is usually used for obtaining the Layer 2 link-layer addresses of neighboring nodes within the local-link or applied in IPv6 Duplicate Address Detection. A node is required to join the associated Solicited-Node multicast addresses for all unicast and anycast addresses that have been configured for the node's interfaces.

IPv6 Solicited-Node Multicast Address Format:

FF02:0:0:0:0:1:FFXX:XXXX

The IPv6 solicited-node multicast address has the prefix FF02:0:0:0:0:1:FF00:0000/104 concatenated with the 24 low-order bits of a corresponding IPv6 unicast or anycast address.

2. IPv6 Multicast MAC Address

The high-order 16 bits of an IPv6 multicast MAC address begins with 0x3333 while the low-order 32 bits of an IPv6 multicast MAC address are the low-order 32 bits of the IPv6 multicast IP address. The mapping relationship is described as the following figure:

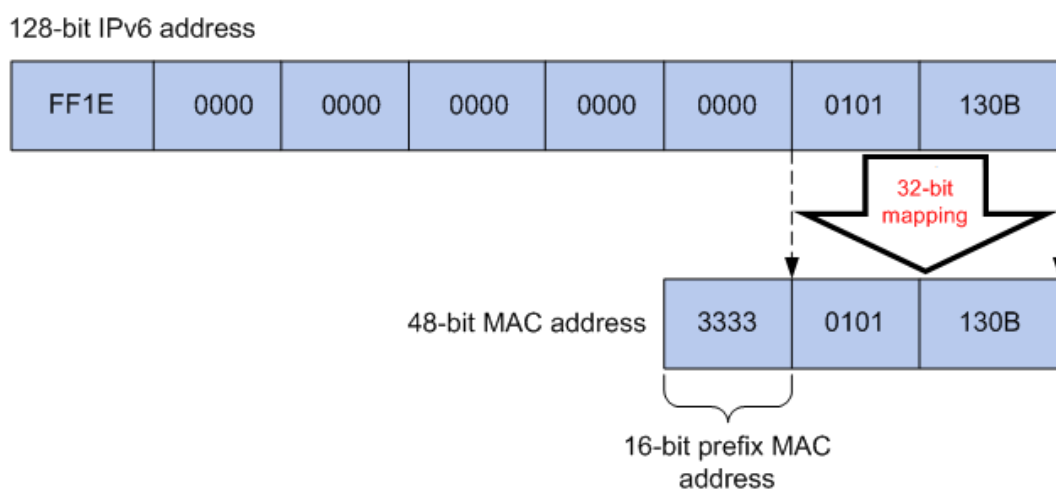

Figure 8-3 Mapping relationship between multicast IPv6 address and multicast IPv6 MAC address

The high-order 16 bits of the IP multicast address are 0x3333, identifying the IPv6 multicast group. The low-order 32 bits of the IPv6 multicast IP address are mapped to the multicast MAC address.

➤ **Multicast Address Table**

The switch is forwarding multicast packets based on the multicast address table. As the transmission of multicast packets cannot span the VLAN, the first part of the multicast address table is VLAN ID, based on which the received multicast packets are forwarded in the VLAN owning the receiving port. The multicast address table is not mapped to an egress port but a group port list. When forwarding a multicast packet, the switch looks up the multicast address table based on the destination multicast address of the multicast packet. If the corresponding entry cannot be found in the table, the switch will broadcast the packet in the VLAN owning the receiving port. If the corresponding entry can be found in the table, it indicates that the destination address should be a group port list, so the switch will deliver this multicast data to each port. The general format of the multicast address table is described as Figure 8-4 below.

VLAN ID	Multicast IP	Port
---------	--------------	------

Figure 8-4 Multicast Address Table

➤ **IGMP Snooping**

In the network, the hosts apply to the near router for joining (leaving) a multicast group by sending IGMP (Internet Group Management Protocol) messages. When the up-stream device forwards down the multicast data, the switch is responsible for sending them to the hosts. IGMP Snooping is a multicast control mechanism, which can be used on the switch for dynamic registration of the multicast group. The switch, running IGMP Snooping, manages and controls the multicast group via listening to and processing the IGMP messages transmitted between the hosts and the multicast router, thereby effectively prevents multicast groups being broadcasted in the network.

➤ **MLD Snooping**

Multicast Listener Discovery (MLD) snooping is applied for efficient distribution of IPv6 multicast data to clients and routers in a Layer 2 network. With MLD snooping, IPv6 multicast data is selectively forwarded to a list of ports that want to receive the data, instead of being flooded to all ports in a VLAN. The list is constructed and maintained by snooping IPv6 multicast control packets. MLD snooping performs a similar function in IPv6 as IGMP snooping in IPv4.

The Multicast module is mainly for multicast management configuration of the switch, including three submenus: **IGMP Snooping**, **MLD Snooping** and **Multicast Table**.

8.1 IGMP Snooping

➤ **IGMP Snooping Process**

The switch, running IGMP Snooping, listens to the IGMP messages transmitted between the host and the router, and tracks the IGMP messages and the registered port. When receiving IGMP report message, the switch adds the port to the multicast address table; when the switch listens to IGMP leave message from the host, the router sends the Group-Specific Query message of the port to check if other hosts need this multicast, if yes, the router will receive IGMP report message; if no, the router will receive no response from the hosts and the switch will remove the port from the multicast address table. The router regularly sends IGMP query messages. After receiving the IGMP query messages, the switch will remove the port from the multicast address table if the switch receives no IGMP report message from the host within a period of time.

➤ **IGMP Messages**

The switch, running IGMP Snooping, processes the IGMP messages of different types as follows.

1. IGMP Query Message

IGMP query message, sent by the router, falls into two types, IGMP general query message and IGMP group-specific-query message. The router regularly sends IGMP general message to query

if the multicast groups contain any member. When receiving IGMP leave message, the receiving port of the router will send IGMP group-specific-query message to the multicast group and the switch will forward IGMP group-specific-query message to check if other members in the multicast group of the port need this multicast.

When receiving IGMP general query message, the switch will forward them to all other ports in the VLAN owning the receiving port. The receiving port will be processed: if the receiving port is not a router port yet, it will be added to the router port list with its router port time specified; if the receiving port is already a router port, its router port time will be directly reset.

When receiving IGMP group-specific-query message, the switch will send the group-specific query message to the members of the multicast group being queried.

2. IGMP Report Message

IGMP report message is sent by the host when it applies for joining a multicast group or responses to the IGMP query message from the router.

When receiving IGMP report message, the switch will send the report message via the router port in the VLAN as well as analyze the message to get the address of the multicast group the host applies for joining. The receiving port will be processed: if the receiving port is a new member port, it will be added to the multicast address table with its member port time specified; if the receiving port is already a member port, its member port time will be directly reset.

3. IGMP Leave Message

The host, running IGMPv1, does not send IGMP leave message when leaving a multicast group, as a result, the switch cannot get the leave information of the host momentarily. However, after leaving the multicast group, the host does not send IGMP report message any more, so the switch will remove the port from the corresponding multicast address table when its member port time times out. The host, running IGMPv2 or IGMPv3, sends IGMP leave message when leaving a multicast group to inform the multicast router of its leaving.

When receiving IGMP leave message, the switch will forward IGMP group-specific-query message to check if other members in the multicast group of the port need this multicast and reset the member port time to the leave time. When the leave time times out, the switch will remove the port from the corresponding multicast group. If no other member is in the group after the port is removed, the switch will send IGMP leave message to the router and remove the whole multicast group.

➤ IGMP Snooping Fundamentals

1. Ports

Router Port: Indicates the switch port directly connected to the multicast router.

Member Port: Indicates a switch port connected to a multicast group member.

2. Timers

Router Port Time: Within the time, if the switch does not receive IGMP query message from the router port, it will consider this port is not a router port any more. The default value is 300 seconds.

Member Port Time: Within the time, if the switch does not receive IGMP report message from the member port, it will consider this port is not a member port any more. The default value is 260 seconds.

Leave Time: Indicates the interval between the switch receiving a leave message from a host and the switch removing the host from the multicast groups. The default value is 1 second.

The IGMP Snooping function can be implemented on the following pages: **Snooping Config**, **VLAN Config**, **Port Config**, **IP-Range**, **Multicast VLAN**, **Static Multicast IP** and **Packet Statistics**.

8.1.1 Snooping Config

To configure the IGMP Snooping on the switch, please firstly configure IGMP global configuration and related parameters on this page.

If the multicast address of the received multicast data is not in the multicast address table, the switch will broadcast the data in the VLAN. When Unknown Multicast Discard feature is enabled, the switch drops the received unknown multicast so as to save the bandwidth and enhance the process efficiency of the system. Please configure this feature appropriate to your needs.

Choose the menu **Multicast** → **IGMP Snooping** → **Snooping Config** to load the following page.

Global Config

IGMP Snooping: Enable Disable

Unknown Multicast: Forward Discard

IGMP Snooping Status

Description	Member
Enabled Port	
Enabled VLAN	

Note:

IGMP Snooping will take effect only when Global Config, Port Config and VLAN Config are all enabled.

Figure 8-5 Basic Config

The following entries are displayed on this screen:

➤ **Global Config**

IGMP Snooping: Select Enable/Disable IGMP Snooping function globally on the switch.

Unknown Multicast: Select the operation for the switch to process unknown multicast, Forward or Discard.

➤ **IGMP Snooping Status**

Description: Displays IGMP Snooping status.

Member: Displays the member of the corresponding status.

8.1.2 VLAN Config

Multicast groups established by IGMP Snooping are based on VLANs. On this page you can configure different IGMP parameters for different VLANs.

Choose the menu **Multicast**→**IGMP Snooping**→**VLAN Config** to load the following page.

VLAN Config

VLAN ID: (1-4094)

Router Port Time: sec (60-600, recommended: 300)

Member Port Time: sec (60-600, recommended: 260) Create

Leave Time: sec (1-30, recommended: 1)

Static Router Ports: (Format: 1-3,6,8)

VLAN Table

Select	VLAN ID	Router Port Time	Member Port Time	Leave Time	Router Port
<input type="checkbox"/>		<input type="text"/>	<input type="text"/>	<input type="text"/>	<input type="text"/>

Apply
Delete
Help

Note:

The settings here will be invalid when multicast VLAN is enabled.

Figure 8-6 VLAN Config

The following entries are displayed on this screen:

➤ **VLAN Config**

- VLAN ID:** Enter the VLAN ID to enable IGMP Snooping for the desired VLAN.
- Router Port Time:** Specify the aging time of the router port. Within this time, if the switch doesn't receive IGMP query message from the router port, it will consider this port is not a router port any more.
- Member Port Time:** Specify the aging time of the member port. Within this time, if the switch doesn't receive IGMP report message from the member port, it will consider this port is not a member port any more.
- Leave Time:** Specify the interval between the switch receiving a leave message from a host and the switch removing the host from the multicast groups.
- Static Router Ports:** Enter the static router port which is mainly used in the network with stable topology.

➤ **VLAN Table**

- VLAN ID Select:** Click the **Select** button to quick-select the corresponding VLAN ID based on the ID number you entered.
- Select:** Select the desired VLAN ID for configuration. It is multi-optional.
- VLAN ID:** Displays the VLAN ID.
- Router Port Time:** Displays the router port time of the VLAN.

Member Port Time: Displays the member port time of the VLAN.

Leave Time: Displays the leave time of the VLAN.

Router Port: Displays the router port of the VLAN.



Note:

The settings here will be invalid when multicast VLAN is enabled.

Configuration procedure:

Step	Operation	Description
1	Enable IGMP Snooping function	Required. Enable IGMP Snooping globally on the switch and for the port on Multicast→IGMP Snooping→Snooping Config and Port Config page.
2	Configure the multicast parameters for VLANs	Optional. Configure the multicast parameters for VLANs on Multicast→IGMP Snooping→VLAN Config page. If a VLAN has no multicast parameters configuration, it indicates the IGMP Snooping is not enabled in the VLAN, thus the multicast data in the VLAN will be broadcasted.

8.1.3 Port Config

On this page you can configure the IGMP feature for ports of the switch.

When the switch receives IGMP report message, it examines the multicast filtering IP ID configured on the access port to determine if the port can join the multicast group. If the multicast IP is not filtered, the switch will add the port to the forward port list of the multicast group. Otherwise, the switch will drop the IGMP report message. In that way, you can control the multicast groups that users can access.

Choose the menu **Multicast →IGMP Snooping →Port Config** to load the following page.

Select	Port	IGMP Snooping	Fast Leave	Filter	Action Mode	Bound IP-Range (ID)	Max Groups	LAG
<input type="checkbox"/>		Disable	Disable	Disable	Permit			
<input type="checkbox"/>	1	Disable	Disable	Disable	permit		256	---
<input type="checkbox"/>	2	Disable	Disable	Disable	permit		256	---
<input type="checkbox"/>	3	Disable	Disable	Disable	permit		256	---
<input type="checkbox"/>	4	Disable	Disable	Disable	permit		256	---
<input type="checkbox"/>	5	Disable	Disable	Disable	permit		256	---
<input type="checkbox"/>	6	Disable	Disable	Disable	permit		256	---
<input type="checkbox"/>	7	Disable	Disable	Disable	permit		256	---
<input type="checkbox"/>	8	Disable	Disable	Disable	permit		256	---
<input type="checkbox"/>	9	Disable	Disable	Disable	permit		256	---
<input type="checkbox"/>	10	Disable	Disable	Disable	permit		256	---
<input type="checkbox"/>	11	Disable	Disable	Disable	permit		256	---
<input type="checkbox"/>	12	Disable	Disable	Disable	permit		256	---

Note:

1. The port filter configuration here has no effect on static multicast IP.
2. Up to 15 IP-Ranges can be bound to one port. Please input the Bound IP-Range (ID) in the format like: 1,5,8.

Figure 8-7 Port Config

The following entries are displayed on this screen:

➤ **Port Config**

Port Select:	Click the Select button to quick-select the corresponding port based on the port number you entered.
Select:	Select the desired port for IGMP Snooping feature configuration. It is multi-optional.
Port:	Displays the port of the switch.
IGMP Snooping:	Select Enable/Disable IGMP Snooping for the desired port.
Fast Leave:	Select Enable/Disable Fast Leave feature for the desired port. If Fast Leave is enabled for a port, the switch will immediately remove this port from the multicast group upon receiving IGMP leave messages.
Filter:	Select Enable/Disable multicast filtering feature on the port.
Action Mode:	Select the action mode to process multicast packets when the multicast IP is in the filtering IP-range. <ul style="list-style-type: none">● Permit: Only the multicast packets whose multicast IP is in the IP-range will be processed.● Deny: Only the multicast packets whose multicast IP is not in the IP-range will be processed.
Bound IP-Range (ID):	Enter the IP-range ID the port will be bound to. The binding IP-range IDs of the port can be cleared by entering null value in this field and click Apply button to submit the configuration.
Max Groups:	Specify the maximum number of multicast groups to prevent some ports taking up too much bandwidth.
LAG:	Displays the LAG number which the port belongs to.



Note:

1. Fast Leave on the port is effective only when the host supports IGMPv2 or IGMPv3.
2. When both Fast Leave feature and Unknown Multicast Discard feature are enabled, the leaving of a user connected to a port owning multi-user will result in the other users intermitting the multicast business.
3. Multicast Filter feature can only have effect on the VLAN with IGMP Snooping enabled.
4. Multicast Filter feature has no effect on static multicast IP.
5. Up to 15 IP-Ranges can be bound to one port.

8.1.4 IP-Range

On this page you can figure the desired IP-ranges to be filtered.

Choose the menu **Multicast**→**IGMP Snooping**→**IP-Range** to load the following page.

The screenshot shows two parts of a web interface. The top part is titled 'Create IP-Range' and contains three input fields: 'IP-Range ID' (with a '(1-30)' constraint), 'Start Multicast IP' (with a '(Format: 225.0.0.1)' constraint), and 'End Multicast IP' (with a '(Format: 225.0.0.1)' constraint). A 'Create' button is located to the right of the second and third fields. The bottom part is titled 'IP-Range Table' and features a table with columns for 'Select', 'IP-Range ID', 'Start Multicast IP', and 'End Multicast IP'. A 'Select' button is positioned above the table, and 'Apply', 'Delete', and 'Help' buttons are located below it. At the bottom of the table area, it says 'Total IP-Range:0'.

Figure 8-8 Multicast Filter

The following entries are displayed on this screen:

➤ **Create IP-Range**

IP Range ID: Enter the IP-range ID.

Start Multicast IP: Enter start multicast IP of the IP-range you set.

End Multicast IP: Enter end multicast IP of the IP-range you set.

➤ **IP-Range Table**

IP-Range ID Select: Click the **Select** button to quick-select the corresponding IP-range ID based on the ID number you entered.

Select: Select the desired entry to delete or modify the corresponding IP-range. It is multi-optional.

IP-Range ID: Displays IP-range ID.

Start Multicast IP: Displays start multicast IP of the IP-range.

End Multicast IP: Displays end multicast IP of the IP-range.

8.1.5 Multicast VLAN

In old multicast transmission mode, when users in different VLANs apply for join the same multicast group, the multicast router will duplicate this multicast information and deliver each VLAN owning a receiver one copy. This mode wastes a lot of bandwidth.

The problem above can be solved by configuring a multicast VLAN. By adding switch ports to the multicast VLAN and enabling IGMP Snooping, you can make users in different VLANs share the same multicast VLAN. This saves the bandwidth since multicast streams are transmitted only within the multicast VLAN and also guarantees security because the multicast VLAN is isolated from user VLANs.

Before configuring a multicast VLAN, you should firstly configure a VLAN as multicast VLAN and add the corresponding ports to the VLAN on the **802.1Q VLAN** page. If the multicast VLAN is enabled, the multicast configuration for other VLANs on the **VLAN Config** page will be invalid, that is, the multicast streams will be transmitted only within the multicast VLAN.

Choose the menu **Multicast**→**IGMP Snooping**→**Multicast VLAN** to load the following page.

Multicast VLAN

Multicast VLAN: Enable Disable

VLAN ID: (2-4094)

Router Port Time: sec (60-600, recommended: 300)

Member Port Time: sec (60-600, recommended: 260)

Leave Time: sec (1-30, recommended: 1)

Router Ports: (Format: 1-3,6,8)

Note:

1. All IGMP packet will be processed in the Multicast VLAN after Multicast VLAN is created.
2. The Multicast VLAN won't take effect unless you first complete the configuration on the VLAN Config page.

Figure 8-9 Multicast VLAN

The following entries are displayed on this screen:

➤ **Multicast VLAN**

- Multicast VLAN:** Select Enable/Disable Multicast VLAN feature.
- VLAN ID:** Enter the VLAN ID of the multicast VLAN.
- Router Port Time:** Specify the aging time of the router port. Within this time, if the switch doesn't receive IGMP query message from the router port, it will consider this port is not a router port any more.
- Member Port Time:** Specify the aging time of the member port. Within this time, if the switch doesn't receive IGMP report message from the member port, it will consider this port is not a member port any more.
- Leave Time:** Specify the interval between the switch receiving a leave message from a host, and the switch removing the host from the multicast groups.
- Router Ports:** Enter the static router port which is mainly used in the network with stable topology.

 **Note:**

1. The router port should be in the multicast VLAN, otherwise the member ports cannot receive multicast streams.
2. The Multicast VLAN won't take effect unless you first complete the configuration for the corresponding VLAN owning the port on the **802.1Q VLAN** page.
3. It is recommended to choose GENERAL as the link type of the member ports in the multicast VLAN.

4. Configure the link type of the router port in the multicast VLAN as TRUNK or configure the egress rule as TAG and the link type as GENERAL otherwise all the member ports in the multicast VLAN cannot receive multicast streams.
5. After a multicast VLAN is created, all the IGMP packets will be processed only within the multicast VLAN.

Configuration procedure:

Step	Operation	Description
1	Enable IGMP Snooping function	Required. Enable IGMP Snooping globally on the switch and for the port on Multicast→IGMP Snooping→Snooping Config and Port Config page.
2	Create a multicast VLAN	Required. Create a multicast VLAN and add all the member ports and router ports to the VLAN on the VLAN→802.1Q VLAN page. <ul style="list-style-type: none"> • Configure the link type of the member ports as GENERAL. • Configure the link type of the router ports as TRUNK or configure the egress rule as tagged GENERAL.
3	Configure parameters for multicast VLAN	Optional. Enable and configure a multicast VLAN on the Multicast→IGMP Snooping→Multicast VLAN page. It is recommended to keep the default time parameters.
4	Look over the configuration	If it is successfully configured, the VLAN ID of the multicast VLAN will be displayed in the IGMP Snooping Status table on the Multicast→IGMP Snooping→Snooping Config page.

Application Example for Multicast VLAN:

➤ Network Requirements

Multicast source sends multicast streams via the router, and the streams are transmitted to user A and user B through the switch.

Router: Its WAN port is connected to the multicast source; its LAN port is connected to the switch. The multicast packets are transmitted in VLAN3.

Switch: Port 3 is connected to the router and the packets are transmitted in VLAN3; port 4 is connected to user A and the packets are transmitted in VLAN4; port 5 is connected to user B and the packets are transmitted in VLAN5.

User A: Connected to Port 4 of the switch.

User B: Connected to port 5 of the switch.

Configure a multicast VLAN, and user A and B receive multicast streams through the multicast VLAN.

➤ **Network Diagram**

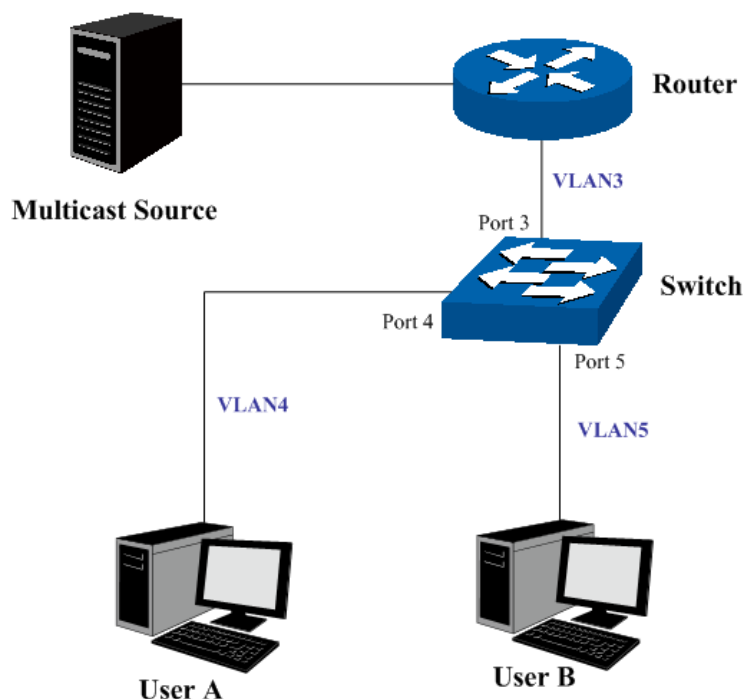

➤ **Configuration Procedure**

Step	Operation	Description
1	Create VLANs	Create three VLANs with the VLAN ID 3, 4 and 5 respectively, and specify the description of VLAN3 as Multicast VLAN on VLAN→802.1Q VLAN page.
2	Configure ports	On VLAN→802.1Q VLAN function pages. For port 3, configure its link type as GENERAL and its egress rule as TAG, and add it to VLAN3, VLAN4 and VLAN5. For port 4, configure its link type as GENERAL and its egress rule as UNTAG, and add it to VLAN3 and VLAN 4. For port 5, configure its link type as GENERAL and its egress rule as UNTAG, and add it to VLAN3 and VLAN 5.
3	Enable IGMP Snooping function	Enable IGMP Snooping function globally on Multicast→IGMP Snooping→Snooping Config page. Enable IGMP Snooping function for port 3, port4 and port 5 on Multicast→IGMP Snooping→Port Config page.
4	Enable Multicast VLAN	Enable Multicast VLAN, configure the VLAN ID of a multicast VLAN as 3 and keep the other parameters as default on Multicast→IGMP Snooping→Multicast VLAN page.
5	Check Multicast VLAN	3-5 and Multicast VLAN 3 will be displayed in the IGMP Snooping Status table on the Multicast→IGMP Snooping→Snooping Config page.

8.1.6 Static Multicast IP

Static Multicast IP table, isolated from dynamic multicast group and multicast filter, is not learned by IGMP Snooping. It can enhance the quality and security for information transmission in some fixed multicast groups.

Choose the menu **Multicast**→**IGMP Snooping**→**Static Multicast IP** to load the following page.

Create Static Multicast

Multicast IP: (Format: 225.0.0.1)

VLAN ID: (1-4094)

Forward Port: (Format: 1-3,6,8)

Search Option

Search Option:

Static Multicast IP Table

Select	Multicast IP	VLAN ID	Forward Port
<input type="button" value="All"/> <input type="button" value="Delete"/> <input type="button" value="Help"/>			

Total Static Multicast IP: 0

Figure 8-10 Static Multicast IP Table

The following entries are displayed on this screen:

➤ **Create Static Multicast**

Multicast IP: Enter static multicast IP address.

VLAN ID: Enter the VLAN ID of the multicast IP.

Forward Port: Enter the forward port of the multicast group.

➤ **Search Option**

Search Option: Select the rules for displaying multicast IP table to find the desired entries quickly.

- All: Displays all static multicast IP entries.
- Multicast IP: Enter the multicast IP address the desired entry must carry.
- VLAN ID: Enter the VLAN ID the desired entry must carry.
- Port: Enter the port number the desired entry must carry.

➤ **Static Multicast IP Table**

Select: Select the desired entry to delete the corresponding static multicast IP. It is multi-optional.

Multicast IP: Displays the multicast IP.

VLAN ID: Displays the VLAN ID of the multicast group.

Forward Port: Displays the forward port of the multicast group.

8.1.7 Packet Statistics

On this page you can view the multicast data traffic on each port of the switch, which facilitates you to monitor the IGMP messages in the network.

Choose the menu **Multicast**→**IGMP Snooping**→**Packet Statistics** to load the following page.

Auto Refresh

Auto Refresh: Enable Disable Apply

Refresh Period: sec (3-300)

IGMP Statistics

Port
Select

Port	Query Packet	Report Packet(V1)	Report Packet(V2)	Report Packet(V3)	Leave Packet	Error Packet
1	0	0	0	0	0	0
2	0	0	0	0	0	0
3	0	0	0	0	0	0
4	0	0	0	0	0	0
5	0	0	0	0	0	0
6	0	0	0	0	0	0
7	0	0	0	0	0	0
8	0	0	0	0	0	0
9	0	0	0	0	0	0
10	0	0	0	0	0	0
11	0	0	0	0	0	0
12	0	0	0	0	0	0

Refresh
Clear
Help

Figure 8-11 Packet Statistics

The following entries are displayed on this screen:

➤ **Auto Refresh**

Auto Refresh: Select Enable/Disable auto refresh feature.

Refresh Period: Enter the time from 3 to 300 in seconds to specify the auto refresh period.

➤ **IGMP Statistics**

Port Select: Click the **Select** button to quick-select the corresponding port based on the port number you entered.

Port: Displays the port number of the switch.

Query Packet: Displays the number of query packets the port received.

Report Packet (V1): Displays the number of IGMPv1 report packets the port received.

Report Packet (V2): Displays the number of IGMPv2 report packets the port received.

Report Packet (V3): Displays the number of IGMPv3 report packets the port received.

Leave Packet: Displays the number of leave packets the port received.

Error Packet: Displays the number of error packets the port received.

8.2 MLD Snooping

➤ MLD Snooping

Multicast Listener Discovery (MLD) snooping is applied for efficient distribution of IPv6 multicast data to clients and routers in a Layer 2 network. With MLD snooping, IPv6 multicast data is selectively forwarded to a list of ports that want to receive the data, instead of being flooded to all ports in a VLAN. The list is constructed and maintained by snooping IPv6 multicast control packets. MLD snooping performs a similar function in IPv6 as IGMP snooping in IPv4.

The switch, running MLD Snooping, listens to the MLD messages transmitted between the host and the router, and tracks the MLD messages and the registered port. When receiving MLD report message, the switch adds the port to the multicast address table; when the switch listens to MLD Done message from the host, the router sends the Multicast-Address-Specific Query message of the port to check if other hosts need this multicast, if yes, the switch will receive MLD report message; if no, the switch will receive no response from the hosts and the switch will remove the port from the multicast address table. The router regularly sends MLD query messages. After receiving the MLD query messages, the switch will remove the port from the multicast address table if the switch receives no MLD report message from the host within a period of time.

➤ MLD Snooping Fundamentals

1. MLD Messages

MLD Queries: MLD Queries include General Queries and Multicast-Address-Specific Queries (MASQs) and are sent out from the MLD router.

MLD Reports: When a host wants to join a multicast group or responds to the MLD queries, it will send out an MLD report.

MLD Done Messages: When a host wants to leave a multicast group, it will send out an MLD Done message to inform the IPv6 multicast routers of its leave.

2. Relevant Ports of the Switch

Router Port: Indicates the switch port that links toward the MLD router.

Member Port: Indicates the switch port that links toward the multicast members.

3. Timers

Router Port Aging Time: Within this time, if the switch does not receive MLD queries from the router port, it will delete this port from the router port list. The default value is 260 seconds.

Member Port Aging Time: Within this time, if the switch does not receive MLD reports from the member port, it will delete this port from the MLD multicast group. The default value is 260 seconds.

General Query Interval: The interval between the multicast router sends out general queries.

Last Listener Query Interval: The interval between the switch sends out MASQs.

Last Listener Query Count: The number of MASQs that the switch sends before aging out a multicast address when there is no MLD report response.

➤ **MLD Snooping Process**

1. General Query

The MLD router regularly sends MLD general queries to query if the multicast groups contain any members. When receiving MLD general queries, the switch will forward them to all other ports in the VLAN. The receiving port will be processed: if the receiving port is not a router port yet, it will be added to the router port list with its router port aging time specified; if the receiving port is already a router port, its router port aging time will be directly reset.

2. Membership Report

The host will send MLD report messages when it applies for joining a multicast group or responds to the MLD query message from the router.

When receiving MLD report message, the switch will forward the report message via the router port in the VLAN, and analyze the message to get the address of the multicast group the host applies for joining. If the multicast group does not exist, it will create the group entry. The receiving port will be processed: if the receiving port is a new member port, it will be added to the forward list of the multicast group with its member port aging time specified; if the receiving port is already a member port, its member port aging time will be directly reset.

3. Member Leave

The host will send MLD Done message when leaving a multicast group to inform the router of its leaving.

When Immediate Leave is not enabled in a VLAN and a Done message is received on a port of this VLAN, the switch will generate MASQs on this port to check if there are other members in this multicast group. The user can control when a port membership is removed for an exiting address in terms of the number and interval of MASQs. If there is no Report message received from this port during the switch maximum response time, the port on which the MASQ was sent is deleted from the multicast group. If the deleted port is the last member of the multicast group, the multicast group is also deleted. The switch will send Done message to the router ports of the VLAN.

In IPv6, Layer 2 switches can use Multicast Listener Discovery (MLD) Snooping to limit the flooding of multicast traffic by dynamically configuring Layer 2 interfaces so that IPv6 multicast data is selectively forwarded to a list of ports that want to receive the data. This list is constructed by snooping IPv6 multicast control packets.

The MLD Snooping function can be implemented on **Global Config**, **VLAN Config**, **Filter Config**, **Port Config**, **Static Multicast**, **Querier Config** and **Packet Statistics** pages.

8.2.1 Global Config

To configure the MLD Snooping on the switch, please firstly configure MLD global configuration and related parameters on this page.

Chose the menu **Multicast**→**MLD Snooping**→**Global Config** to load the following page.

Global Config

MLD Snooping:	<input type="radio"/> Enable	<input checked="" type="radio"/> Disable
Report Message Suppression:	<input checked="" type="radio"/> Enable	<input type="radio"/> Disable
Unknown Multicast Filter:	<input checked="" type="radio"/> Forward	<input type="radio"/> Discard
Router Port Aging Time:	<input type="text" value="260"/>	sec (1-1000)
Member Port Aging Time:	<input type="text" value="260"/>	sec (200-1000)
Last Listener Query Interval:	<input type="text" value="1"/>	sec (1-5)
Last Listener Query Count:	<input type="text" value="2"/>	(1-7)
Multicast VLAN:	<input type="radio"/> Enable	<input checked="" type="radio"/> Disable
Multicast VLAN ID:	<input type="text" value="1"/>	(1-4094)

Note:

1. When Unknown Multicast Filter is configured, the Unknown Multicast function in IGMP Snooping is also configured at the same time.
2. Multicast VLAN will take effect when the corresponding VLAN has been created in VLAN Config page.

Figure 8-12 Global Config

The following entries are displayed on this screen:

➤ **Global Config**

- | | |
|------------------------------------|--|
| MLD Snooping: | Enable or disable MLD Snooping function globally. |
| Report Message Suppression: | Enable or disable Report Message Suppression function globally. If this function is enabled, the first Report Message from the listener will forward to the router ports while the subsequent Report Message from the group will be suppressed to reduce the MLD traffic in the network. |
| Unknown Multicast Filter: | Choose to forward or drop unknown multicast data.
Unknown IPv6 multicast packets refer to those packets without corresponding forwarding entries in the IPv6 multicast table:
When unknown multicast filter is enabled, the switch will discard all received unknown IPv6 multicast packets;
When unknown multicast filter is disabled, all unknown IPv6 multicast packets are flooded in the ingress VLAN. |
| Router Port Aging Time: | Enter the global router port aging time. If the router port does not receive Query Message in the aging time, it will be aged. |

- Member Port Aging Time:** Enter the global member port aging time. If the member port does not receive Report Message in the aging time, it will be aged.
- Last Listener Query Interval:** Enter the Last Listener Query interval time. When the multicast group has no more member ports, it will send the Specific Query Message with this interval time to check whether there is another listener.
- Last Listener Query Count:** Enter the Last Listener Query numbers. When the multicast group has no more member ports, it will send this numbers of Specific Query Message to check whether there is another listener.
- Multicast VLAN:** Enable or disable multicast VLAN function. When multicast VLAN is enabled, all multicast data will forward in this VLAN if this port belongs to the VLAN.
- Multicast VLAN ID:** Enter the multicast VLAN ID.



Note:

1. When Unknown Multicast Filter is configured, the Unknown Multicast function in IGMP Snooping is also configured at the same time.
2. Configurations of the Router Port Aging Time and Member Port Aging Time in [8.2.2 VLAN Config](#) override their global configurations here.
3. Before creating a Multicast VLAN, you should enable the MLD snooping function in this VLAN in [8.2.2 VLAN Config](#).

Configuration Procedure of Multicast VLAN:

Step	Operation	Description
1	Create VLAN.	Required. On the VLAN →802.1Q VLAN →VLAN Config page, click the Create button to create a VLAN. Enter the VLAN ID and the description for the VLAN. Meanwhile, specify its member ports.
2	Enable MLD Snooping globally.	Required. On the Multicast →MLD Snooping →Global Config page, enable the MLD Snooping function globally.
3	Enable MLD Snooping in the VLAN.	Required. On the Multicast →MLD Snooping →VLAN Config page, specify the VLAN ID as the VLAN created in step 1.
4	Enable the Multicast VLAN.	Required. On the Multicast →MLD Snooping →Global Config page, enable the Multicast VLAN function and specify the Multicast VLAN ID as the VLAN specified in Step 1.

8.2.2 VLAN Config

On this page you can configure MLD Snooping function with each single VLAN. You need to create VLAN if you want to enable MLD Snooping function in this VLAN.

Choose the menu **Multicast**→**MLD Snooping**→**VLAN Config** to load the following page.

VLAN Config

VLAN ID: (1-4094)

Router Port Aging Time: sec (0-1000)

Member Port Aging Time: sec (0, 200-1000)

Immediate Leave: Enable Disable

Static Router Ports: (Format: 1-3,6,8)

VLAN Table

Select	VLAN ID	Router Port Aging Time	Member Port Aging Time	Immediate Leave	Static Router Ports	Dynamic Router Ports
<input type="checkbox"/>		<input type="text" value=""/>	<input type="text" value=""/>	Enable <input type="button" value="Select"/>	<input type="text" value=""/>	
<input type="checkbox"/>	1	300	400	Enable	2	---
<input type="checkbox"/>	4094	300	400	Disable	2,4,6,8,10,12,14,16,18,20,22,24	2,4,6,8,10,12,14,16,18,20,22,24

Total Configured VLANs: 2

Note:

1. The VLAN configuration will take effect when global MLD Snooping function is enabled and the corresponding VLAN is created.
2. When the router port aging time or member port aging time is set for a VLAN, this value overrides the value configured globally.
3. When the aging time is not configured (set to the default of 0 second), the global value is used.

Figure 8-13 VLAN Config

The following entries are displayed on this screen:

> Vlan Config

- VLAN ID:** Enter the VLAN ID you want to configure.
- Router Port Aging Time:** Enter the router port aging time for this VLAN. It will override the global configured aging time.
- Member Port Aging Time:** Enter the member port aging time for this VLAN. It will override the global configured aging time.
- Immediate Leave:** Enable or disable immediate leave function for this VLAN. If this function is enabled, the multicast group member port will be deleted immediately if Done Message receive, not sending Specific Query for listener checking.
- Static Router Ports:** Enter the static router ports for this VLAN. Static router ports will not be aged.

> Vlan Table

- Select:** Select the VLAN ID you want to change.
- VLAN ID:** Displays the VLAN ID.
- Router Port Aging Time:** Displays the router port aging time of this VLAN.
- Member Port Aging Time:** Displays the member port aging time of this VLAN.

- Immediate Leave:** Displays the immediate leave function of this VLAN. You should only use the Immediate-Leave feature when there is a single receiver present on every port in the VLAN. If the immediate leave function is enabled on a port with several listeners in the same IPv6 multicast group, these listeners will fail to receive the IPv6 multicast packets after one of them leave this group.
- Static Router Ports:** Displays the static router ports of this VLAN.
- Dynamic Router Ports:** Displays the dynamic router ports of this VLAN.



Note:

1. The MLD snooping function in a VLAN will take effect when global MLD Snooping function is enabled in [8.2.1 Global Config](#) and the VLAN is created in [Chapter 6 VLAN](#).
2. When the router port aging time or member port aging time is set for a VLAN, this value overrides the value configured globally in [8.2.1 Global Config](#).

8.2.3 Filter Config

When the switch receives MLD report messages, it examines the multicast filtering ID and filter mode configured on the access port to determine if the port can join the multicast group. If the port can join the multicast group, the switch will add the port to the forward ports list of the multicast group. Otherwise, the switch will drop the MLD report messages. In that way, you can control the multicast groups that users can join in.

Choose the menu **Multicast**→**MLD Snooping**→**Filter Config** to load the following page.

Figure 8-14 Filter Config

The following entries are displayed on this screen:

➤ **Filter Config**

- Filter ID:** Enter the Filter ID which identifies the filter.
- Start Multicast IP:** Enter the start of the IP range.
- End Multicast IP:** Enter the end of the IP range.

➤ **Filter List**

- Select:** Select the filter ID you want to change.
- Filter ID:** Displays the filter ID number.

Start Multicast IP: Displays the start of the IP range.

End Multicast IP: Displays the end of the IP range.



Note:

The max number of filter entries is 30.

8.2.4 Port Config

On this page you can configure MLD Snooping function with each single port.

Choose the menu **Multicast**→**MLD Snooping**→**Port Config** to load the following page.

Select	Port	Filter	Filter Mode	Filter IDs	Max Groups	LAG
<input type="checkbox"/>		Disable ▾	Accept ▾	<input type="text"/>	<input type="text"/>	
<input type="checkbox"/>	1	Disable	Accept	---	128	---
<input type="checkbox"/>	2	Disable	Accept	---	128	---
<input type="checkbox"/>	3	Disable	Accept	---	128	---
<input type="checkbox"/>	4	Disable	Accept	---	128	---
<input type="checkbox"/>	5	Disable	Accept	---	128	---
<input type="checkbox"/>	6	Disable	Accept	---	128	---
<input type="checkbox"/>	7	Disable	Accept	---	128	---
<input type="checkbox"/>	8	Disable	Accept	---	128	---
<input type="checkbox"/>	9	Disable	Accept	---	128	---
<input type="checkbox"/>	10	Disable	Accept	---	128	---
<input type="checkbox"/>	11	Disable	Accept	---	128	---
<input type="checkbox"/>	12	Disable	Accept	---	128	---

Note:

1. The port filter configuration here has no effect on static Multicast IP.
2. Up to 15 filters can be bound to one port. Please input the bound filter ID in the format like: 1,5,8.
3. If the Max Groups value is set less than the current value, some groups may be deleted to satisfy the restriction.

Figure 8-15 Port Config

The following entries are displayed on this screen:

➤ **Port Config**

Select: Select the port you want to configure.

Port: Displays the port number.

Filter: Choose to enable or disable filter function in this port.

Filter Mode: Choose the filter action mode. You can accept or refuse Report message with specific multicast groups specify by the filter IDs.

Filter IDs: Enter the filter IDs with this port. The filter IDs are configured in **Filer Config**. The format is 1,4,12.
The max number of filter entries on each port is 15.

Max Groups: Enter the maximum groups which the port can join as the member port. It ranges from 0 to 256.

LAG: Displays the LAG number.

**Note:**

If the Max Groups value is set less than the current value, some groups may be deleted to satisfy the restriction.

8.2.5 Static Multicast

On this page you can configure static multicast groups. The multicast groups configured here are not learned by MLD Snooping and independent of dynamic multicast groups and multicast filters. The static multicast member ports won't age out.

Choose the menu **Multicast**→**MLD Snooping**→**Static Multicast** to load the following page.

Static Multicast Config

VLAN ID: (1-4094)

Multicast IP: (Format FF03::C2D5:2313)

Member Ports: (Format 1-3,6,8)

Static Multicast List

VLAN ID

Select	VLAN ID	Multicast IP	Member Ports
<input type="checkbox"/>			<input type="text"/>

Total Static Multicast: 0

Figure 8-16 Static Multicast

The following entries are displayed on this screen:

➤ **Static Multicast Config**

- VLAN ID:** Enter the VLAN ID.
- Multicast IP:** Enter the multicast IP address.
- Member Ports:** Enter the member ports of the static multicast group.

➤ **Static Multicast List**

- Select:** Select the static multicast group you want to change.
- VLAN ID:** Displays the VLAN ID.
- Multicast IP:** Displays the multicast group IP address.
- Member Ports:** Displays the member ports of the static multicast group.

8.2.6 Querier Config

In an IPv6 multicast network that runs MLD, a Layer 3 multicast device works as an MLD querier to send out MLD queries and manage the multicast table. But MLD is not supported by the devices in Layer 2 network. MLD Snooping Querier can act as an MLD Router in Layer 2 network. It can help to create and maintain multicast forwarding table on the switch with the Query messages it generates.

Choose the menu **Multicast**→**MLD Snooping**→**Querier Config** to load the following page.

Querier Config

VLAN ID: (1-4094)

Maximum Response Time: sec (1-25)

Query Interval: sec (2-300)

Query Source IP: (Format: FE80::ABEC:12EA)

Querier List

Select	VLAN ID	Maximum Response Time	Query Interval	Query Source IP
<input type="checkbox"/>	<input type="text"/>	<input type="text"/>	<input type="text"/>	<input type="text"/>

Total Queriers: 0

Figure 8-17 Querier Config

The following entries are displayed on this screen:

➤ **Querier Config**

- VLAN ID:** Enter the VLAN ID which you want to start Querier.
- Maximum Response Time:** Enter the value of Maximum Response Time field of the Query message.
- Query Interval:** Enter the Query message interval time. The Querier will send General Query Message with this interval.
- Query Source IP:** Enter the Query Message source IP address. It is FE80::02FF:FFFF:FE00:0001 by default.

➤ **Querier List**

- Select:** Select the Querier you want to change.
- VLAN ID:** Displays the VLAN ID.
- Maximum Response Time:** Displays the value of Maximum Response Time field of the Query message.
- Query Interval:** Displays the Query message interval time.
- Query Source IP:** Displays the Query message source IP address.



Note:

The MLD Snooping Querier doesn't participate in the MLD Querier Election, but an MLD Snooping Querier will affect the MLD Querier Election in the IPv6 network running MLD because of its relatively smaller IP address.

8.2.7 Packet Statistics

On this page you can view the MLD packets the switch received. It helps you to monitor the MLD Snooping function.

Choose the menu **Multicast**→**MLD Snooping**→**Packet Statistics** to load the following page.

Auto Refresh

Auto Refresh: Enable Disable

Refresh Period: sec (3-300) Apply

MLD Packet Statistics

Port Select

Port	Received MLD Query	Received MLDv1 Report	Received MLDv2 Report	Received MLD Done	Send MLD Spec-Query	Error Packet
1	0	4	4	0	2	6
2	0	0	0	54	0	0
3	10	0	0	0	0	0
4	0	0	0	25	0	0
5	0	0	14	0	10	0
6	0	0	0	0	0	0
7	0	10	0	0	0	0
8	0	9	11	8	8	0
9	0	12	20	10	20	0
10	0	0	0	0	0	0
11	0	0	0	0	0	0
12	0	0	0	0	0	0

Refresh
Clear
Help

Figure 8-18 Packet Statistics

The following entries are displayed on this screen:

➤ **Auto Fresh**

Auto Fresh: Select Enable/Disable auto fresh feature.

Fresh Period: Enter the time from 3 to 300 seconds to specify the auto fresh period.

➤ **MLD Packet Statistics**

Received MLD Query : Displays the number of MLD Query packets the switch has received.

Received MLDv1 Report: Displays the number of MLDv1 Report packets which the switch has received.

Received MLDv2 Report: Displays the number of MLDv2 Report packets which the switch has received.

Received MLD Done: Displays the number of MLD Done packets which the switch has received.

Send MLD Spec-Query: Displays the number of MLD Specific Query packets which the switch has sent.

Error Packet: Displays the number of error packets which the switch has received.

8.3 Multicast Table

In a network, receivers can join different multicast groups appropriate to their needs. The switch forwards multicast streams based on IPv4/IPv6 multicast address table.

The **Multicast Table** function is implemented on the **IPv4 Multicast Table** and **IPv6 Multicast Table** pages.

8.3.1 IPv4 Multicast Table

On this page you can view the information of the multicast groups already on the switch. Multicast IP addresses range from 224.0.0.0 to 239.255.255.255. The range for receivers to join is from 224.0.1.0 to 239.255.255.255.

Choose the menu **Multicast**→**Multicast Table**→**IPv4 Multicast Table** to load the following page.

Search Option

Multicast IP: (Format: 225.0.0.1)

VLAN ID: (1-4094)

Port:

Type: All Static Dynamic

Multicast IP Table			
Multicast IP	VLAN ID	Forward Port	Type
<input type="button" value="Refresh"/> <input type="button" value="Help"/>			

Total Multicast IP: 0

Figure 8-19 IPv4 Multicast Table

The following entries are displayed on this screen:

➤ **Search Option**

- Multicast IP:** Enter the multicast IP address the desired entry must carry.
- VLAN ID:** Enter the VLAN ID the desired entry must carry.
- Port:** Select the port number the desired entry must carry.
- Type:** Select the type the desired entry must carry.
- All: Displays all multicast IP entries.
 - Static: Displays all static multicast IP entries.
 - Dynamic: Displays all dynamic multicast IP entries.

➤ **Multicast IP Table**

- Multicast IP:** Displays multicast IP address.
- VLAN ID:** Displays the VLAN ID of the multicast group.
- Forward Port:** Displays the forward port of the multicast group.
- Type:** Displays the type of the multicast IP.

8.3.2 IPv6 Multicast Table

This page displays the multicast groups which already on the switch.

Choose the menu **Multicast**→**Multicast Table**→**IPv6 Multicast Table** to load the following page.

Search Option

Multicast IP: (Format: FF03::AD45:3444)

VLAN ID: (1-4094)

Port:

Type: All Static Dynamic

Search

Multicast IP Table

Multicast IP	VLAN ID	Forward Ports	Type
--------------	---------	---------------	------

Refresh Help

Total Multicast IP: 0

Figure 8-20 IPv6 Multicast Table

The following entries are displayed on this screen:

➤ Search Option

Multicast IP: Enter the multicast IP address the desired entry must carry.

VLAN ID: Enter the VLAN ID the desired entry must carry.

Port: Select the port number the desired entry must carry.

Type: Select the type the desired entry must carry.

- All: Displays all multicast IP entries.
- Static: Displays all static multicast IP entries.
- Dynamic: Displays all dynamic multicast IP entries.

➤ Multicast IP Table

Multicast IP: Displays the multicast IP.

VLAN ID: Displays the VLAN ID.

Forward Ports: Displays the forward ports of the group.

Type: Displays the type of the group.



Note:

The max number of multicast entries is 256. The IPv4 multicast table and IPv6 multicast table share the total entry number of 256.

[Return to CONTENTS](#)

Chapter 9 QoS

QoS (Quality of Service) functions to provide different quality of service for various network applications and requirements and optimize the bandwidth resource distribution so as to provide a network service experience of a better quality.

➤ QoS

This switch classifies the ingress packets, maps the packets to different priority queues and then forwards the packets according to specified scheduling algorithms to implement QoS function.

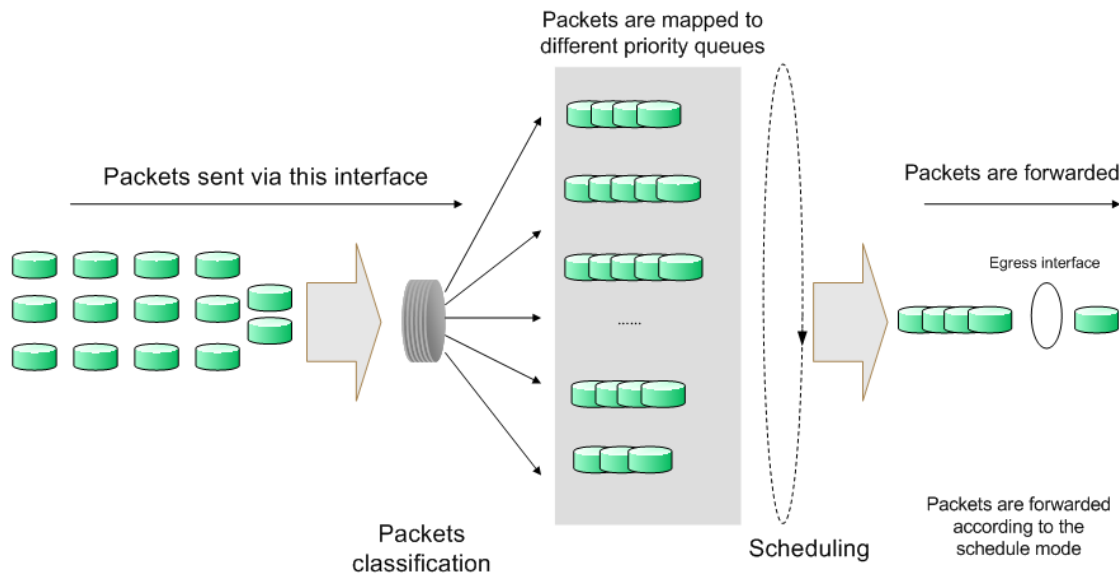

Figure 9-1 QoS function

- Traffic classification: Identifies packets conforming to certain characters according to certain rules.
- Map: The user can map the ingress packets to different priority queues based on the priority modes. This switch implements three priority modes based on port, on 802.1P and on DSCP.
- Queue scheduling algorithm: When the network is congested, the problem that many packets compete for resources must be solved, usually in the way of queue scheduling. The switch supports four schedule modes: SP, WRR, SP+WRR and Equ.

➤ Priority Mode

This switch implements three priority modes based on port, on 802.1P and on DSCP. By default, the priority mode based on port is enabled and the other two modes are optional.

1. Port Priority

Port priority is just a property of the port. After port priority is configured, the data stream will be mapped to the egress queues according to the CoS of the port and the mapping relationship between CoS and queues.

2. 802.1P Priority

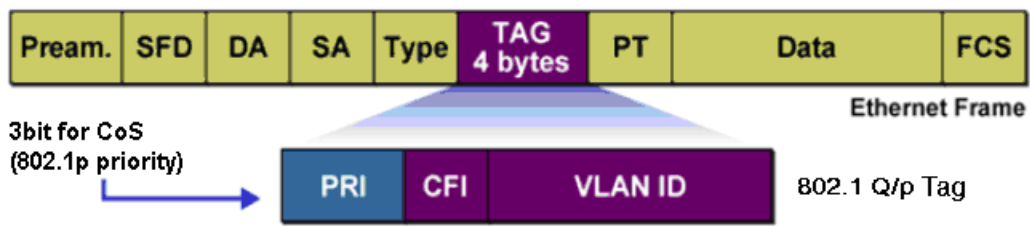

Figure 9-2 802.1Q frame

As shown in the figure above, each 802.1Q Tag has a Pri field, comprising 3 bits. The 3-bit priority field is 802.1p priority in the range of 0 to 7. 802.1P priority determines the priority of the packets based on the Pri value. On the Web management page of the switch, you can configure different priority tags mapping to the corresponding priority levels, and then the switch determine which packet is sent preferentially when forwarding packets. The switch processes untagged packets based on the default priority mode.

3. DSCP Priority

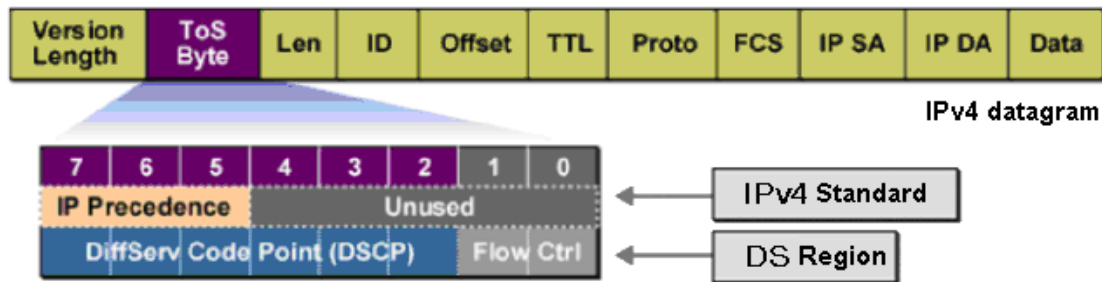

Figure 9-3 IP datagram

As shown in the figure above, the ToS (Type of Service) in an IP header contains 8 bits. The first three bits indicate IP precedence in the range of 0 to 7. RFC2474 re-defines the ToS field in the IP packet header, which is called the DS field. The first six bits (bit 0-bit 5) of the DS field indicate DSCP precedence in the range of 0 to 63. The last 2 bits (bit 6 and bit 7) are reserved. On the Web management page, you can configure different DS field mapping to the corresponding priority levels. Non-IP datagram with 802.1Q tag are mapped to different priority levels based on 802.1P priority mode; the untagged non-IP datagram are mapped based on port priority mode.

➤ Schedule Mode

When the network is congested, the problem that many packets compete for resources must be solved, usually in the way of queue scheduling. The switch implements four scheduling queues, TC0, TC1, TC2 and TC3. TC0 has the lowest priority while TC3 has the highest priority. The switch provides four schedule modes: SP, WRR, SP+WRR and Equ.

1. SP-Mode: Strict-Priority Mode. In this mode, the queue with higher priority will occupy the whole bandwidth. Packets in the queue with lower priority are sent only when the queue with higher priority is empty. The switch has four egress queues labeled as TC0, TC1, TC2 and TC3. In SP mode, their priorities increase in order. TC3 has the highest priority. The disadvantage of SP queue is that: if there are packets in the queues with higher priority for a long time in congestion, the packets in the queues with lower priority will be “starved to death” because they are not served.

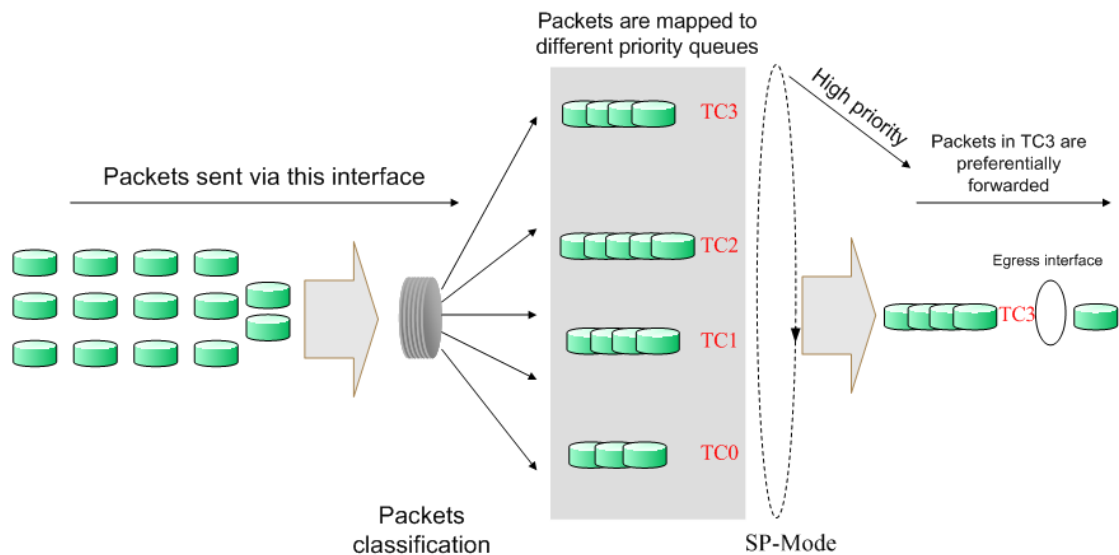

Figure 9-4 SP-Mode

2. **WRR-Mode: Weight Round Robin Mode.** In this mode, packets in all the queues are sent in order based on the weight value for each queue and every queue can be assured of a certain service time. The weight value indicates the occupied proportion of the resource. WRR queue overcomes the disadvantage of SP queue that the packets in the queues with lower priority cannot get service for a long time. In WRR mode, though the queues are scheduled in order, the service time for each queue is not fixed, that is to say, if a queue is empty, the next queue will be scheduled. In this way, the bandwidth resources are made full use of. The default weight value ratio of TC0, TC1, TC2 and TC3 is 1:2:4:8.

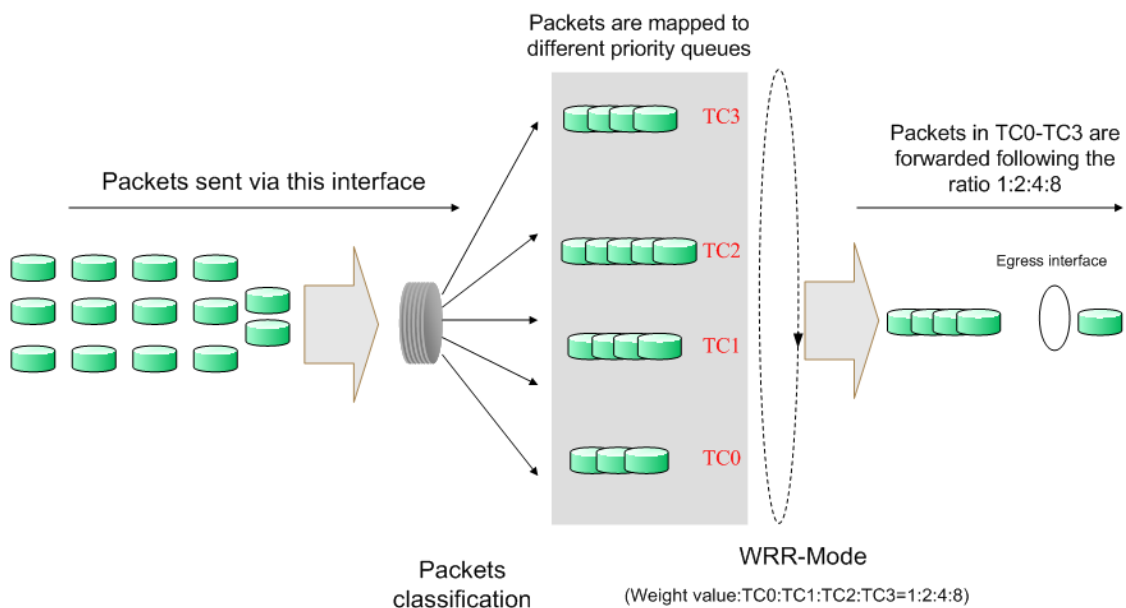

Figure 9-5 WRR-Mode

3. **SP+WRR-Mode: Strict-Priority + Weight Round Robin Mode.** In this mode, this switch provides two scheduling groups, SP group and WRR group. Queues in SP group and WRR group are scheduled strictly based on strict-priority mode while the queues inside WRR group follow the WRR mode. In SP+WRR mode, TC3 is in the SP group; TC0, TC1 and TC2 belong to the WRR group and the weight value ratio of TC0, TC1 and TC2 is 1:2:4. In this way, when scheduling queues, the switch allows TC3 to occupy the whole bandwidth following the SP mode and the TC0, TC1 and TC2 in the WRR group will take up the bandwidth according to their ratio 1:2:4.

4. Equ-Mode: Equal-Mode. In this mode, all the queues occupy the bandwidth equally. The weight value ratio of all the queues is 1:1:1:1.

The QoS module is mainly for traffic control and priority configuration, including three submenus: **DiffServ**, **Bandwidth Control** and **Voice VLAN**.

9.1 DiffServ

This switch classifies the ingress packets, maps the packets to different priority queues and then forwards the packets according to specified scheduling algorithms to implement QoS function.

This switch implements three priority modes based on port, on 802.1P and on DSCP, and supports four queue scheduling algorithms. The port priorities are labeled as CoS0, CoS1... CoS7.

The DiffServ function can be implemented on **Port Priority**, **802.1P/Cos mapping**, **DSCP Priority** and **Schedule Mode** pages.

9.1.1 Port Priority

On this page you can configure the port priority.

Choose the menu **QoS**→**DiffServ**→**Port Priority** to load the following page.

Port Priority Config				
Select	Port	Priority	LAG	
<input type="checkbox"/>		CoS 0		
<input type="checkbox"/>	1	CoS 0	---	
<input type="checkbox"/>	2	CoS 0	---	
<input type="checkbox"/>	3	CoS 0	---	
<input type="checkbox"/>	4	CoS 0	---	
<input type="checkbox"/>	5	CoS 0	---	
<input type="checkbox"/>	6	CoS 0	---	
<input type="checkbox"/>	7	CoS 0	---	
<input type="checkbox"/>	8	CoS 0	---	
<input type="checkbox"/>	9	CoS 0	---	
<input type="checkbox"/>	10	CoS 0	LAG1	

note:

Port priority is one property of the port. When the port priority is specified, the data will be classified into the egress queue based on the CoS value of the ingress port and the mapping relation between the CoS and TC in 802.1P.

Figure 9-6 Port Priority Config

The following entries are displayed on this screen:

➤ **Port Priority Config**

- Select:** Select the desired port to configure its priority. It is multi-optional.
- Port:** Displays the physical port number of the switch.
- Priority:** Specify the priority for the port.
- LAG:** Displays the LAG number which the port belongs to.

Configuration Procedure:

Step	Operation	Description
1	Select the port priority	Required. On QoS→DiffServ→Port Priority page, configure the port priority.
2	Configure the mapping relation between the CoS priority and TC	Required. On QoS→DiffServ→802.1P/Cos mapping page, configure the mapping relation between the Cos and TC.
3	Select a schedule mode	Required. On QoS→DiffServ→Schedule Mode page, select a schedule mode.

9.1.2 DSCP Priority

On this page you can configure DSCP priority. DSCP (DiffServ Code Point) is a new definition to IP ToS field given by IEEE. This field is used to divide IP datagram into 64 priorities. When DSCP Priority is enabled, IP datagram are mapped to different priority levels based on DSCP priority mode; non-IP datagram with 802.1Q tag are mapped to different priority levels based on 802.1P priority mode if 802.1P Priority mode is enabled; the untagged non-IP datagram are mapped based on port priority mode.

Choose the menu **QoS→DiffServ→DSCP Priority** to load the following page.

For TL-SG2216/TL-SG2424/TL-SG2424P:

DSCP Priority Config

DSCP Priority: Enable Disable Apply

Priority Level

DSCP: Priority:

DSCP	Priority	DSCP	Priority
0	CoS0	1	CoS0
2	CoS0	3	CoS0
4	CoS0	5	CoS0
6	CoS0	7	CoS0
8	CoS1	9	CoS1
10	CoS1	11	CoS1
12	CoS1	13	CoS1
14	CoS1	15	CoS1
16	CoS2	17	CoS2
18	CoS2	19	CoS2

Apply
Help

note:

If the DSCP mapped to priority is selected, IP datagram will be mapped to different priority levels based on the mapping relation between the CoS and TC in 802.1P.

Figure 9-7 DSCP Priority

The following entries are displayed on this screen:

➤ **DSCP Priority Config**

DSCP Priority: Select Enable or Disable DSCP Priority.

➤ **Priority Level**

DSCP: Indicates the priority determined by the DS region of IP datagram. It ranges from 0 to 63.

Priority Level: Indicates the 802.1P priority the packets with tag are mapped to. The priorities are labeled as CoS0 ~ CoS7.

Configuration Procedure:

Step	Operation	Description
1	Configure the mapping relation between the DSCP priority and 802.1P priority	Required. On QoS→DiffServ→DSCP Priority page, enable DSCP Priority and configure the mapping relation between the DSCP priority and CoS.
2	Configure the mapping relation between the CoS and the TC	Required. On QoS→DiffServ→802.1P/CoS mapping page, configure the mapping relation between the CoS and the TC.
3	Select a schedule mode	Required. On QoS→DiffServ→Schedule Mode page, select a schedule mode.

For TL-SG2452:

DSCP Priority Config

DSCP Priority: Enable Disable Apply

Priority Level

DSCP: Priority Level:

DSCP	Priority Level	DSCP	Priority Level
0	TC0	1	TC0
2	TC0	3	TC0
4	TC0	5	TC0
6	TC0	7	TC0
8	TC0	9	TC0
10	TC0	11	TC0
12	TC0	13	TC0
14	TC0	15	TC0
16	TC1	17	TC1
18	TC1	19	TC1

Apply Help

note:

Among the priority levels TC0,TC1...TC3, the bigger value, the higher priority.

Figure 9-8 DSCP Priority for TL-SG2452

The following entries are displayed on this screen:

➤ **DSCP Priority Config**

DSCP Priority: Select Enable or Disable DSCP Priority.

➤ **Priority Level**

DSCP: Indicates the priority determined by the DS region of IP datagram. It ranges from 0 to 63.

Priority Level: Indicates the 802.1P priority the packets with tag are mapped to. The priorities are labeled as TC0 ~ TC3.

Configuration Procedure:

Step	Operation	Description
1	Configure the mapping relation between the DSCP priority and 802.1P priority	Required. On QoS→DiffServ→DSCP Priority page, enable DSCP Priority and configure the mapping relation between the DSCP priority and TC.
2	Select a schedule mode	Required. On QoS→DiffServ→Schedule Mode page, select a schedule mode.

9.1.3 802.1P/CoS mapping

On this page you can configure the mapping relation between the 802.1P priority tag-id/CoS-id and the TC-id.

802.1P gives the Pri field in 802.1Q tag a recommended definition. This field, ranging from 0-7, is used to divide packets into 8 priorities. 802.1P Priority is enabled by default, so the packets with 802.1Q tag are mapped to different priority levels based on 802.1P priority mode but the untagged packets are mapped based on port priority mode. With the same value, the 802.1P priority tag and the CoS will be mapped to the same TC.

Choose the menu **QoS→DiffServ→802.1P/CoS mapping** to load the following page.

802.1P Priority Config

802.1P Priority: Enable Disable

Priority and CoS-mapping Config

Tag-id/CoS-id: Queue TC-id:

Tag-id/CoS-id	Queue TC-id	Tag-id/CoS-id	Queue TC-id
0	TC1	1	TC0
2	TC0	3	TC1
4	TC2	5	TC2
6	TC3	7	TC3

Figure 9-9 802.1P/CoS mapping

The following entries are displayed on this screen:

➤ **802.1P Priority Config**

802.1P Priority: Select Enable or Disable 802.1P Priority.

➤ Priority and CoS-mapping Config

Tag-id/Cos-id: Indicates the precedence level defined by IEEE802.1P and the CoS ID.

Queue TC-id: Indicates the priority level of egress queue the packets with tag and CoS-id are mapped to. The priority levels of egress queue are labeled as TC0, TC1, TC2 and TC3.



Note:

For TL-SG2216/TL-SG2424/TL-SG2424P, the 802.1P priority function is enabled by default and cannot be set as disabled.

Configuration Procedure:

Step	Operation	Description
1	Configure the mapping relation between the 802.1P priority Tag/CoS and the TC	Required. On QoS→DiffServ→802.1P/CoS mapping page, configure the mapping relation between the 802.1P priority Tag/CoS and the TC.
2	Select a schedule mode	Required. On QoS→DiffServ→Schedule Mode page,, select a schedule mode.

9.1.4 Schedule Mode

On this page you can select a schedule mode for the switch. When the network is congested, the problem that many packets compete for resources must be solved, usually in the way of queue scheduling. The switch will control the forwarding sequence of the packets according to the priority queues and scheduling algorithms you set. On this switch, the priority levels are labeled as TC0, TC1... TC3.

Choose the menu **QoS→DiffServ→Schedule Mode** to load the following page.

Schedule Mode Config

Schedule Mode: Equ-Mode

Apply

Help

Figure 9-10 Schedule Mode

The following entries are displayed on this screen:

➤ Schedule Mode Config

SP-Mode: Strict-Priority Mode. In this mode, the queue with higher priority will occupy the whole bandwidth. Packets in the queue with lower priority are sent only when the queue with higher priority is empty.

WRR-Mode: Weight Round Robin Mode. In this mode, packets in all the queues are sent in order based on the weight value for each queue. The weight value ratio of TC0, TC1, TC2 and TC3 is 1:2:4:8.

SP+WRR-Mode:

Strict-Priority + Weight Round Robin Mode. In this mode, this switch provides two scheduling groups, SP group and WRR group. Queues in SP group and WRR group are scheduled strictly based on strict-priority mode while the queues inside WRR group follow the WRR mode. In SP+WRR mode, TC3 is in the SP group; TC0, TC1 and TC2 belong to the WRR group and the weight value ratio of TC0, TC1 and TC2 is 1:2:4. In this way, when scheduling queues, the switch allows TC3 to occupy the whole bandwidth following the SP mode and the TC0, TC1 and TC2 in the WRR group will take up the bandwidth according to their ratio 1:2:4.

Equ-Mode:

Equal-Mode. In this mode, all the queues occupy the bandwidth equally. The weight value ratio of all the queues is 1:1:1:1.

9.2 Bandwidth Control

Bandwidth function, allowing you to control the traffic rate and broadcast flow on each port to ensure network in working order, can be implemented on **Rate Limit** and **Storm Control** pages.

9.2.1 Rate Limit

Rate limit functions to control the ingress/egress traffic rate on each port via configuring the available bandwidth of each port. In this way, the network bandwidth can be reasonably distributed and utilized.

Choose the menu **QoS**→**Bandwidth Control**→**Rate Limit** to load the following page.

Select	Port	Ingress Rate(Kbps)	Egress Rate(Kbps)	LAG
<input type="checkbox"/>		128	1024	
<input type="checkbox"/>	1	---	---	---
<input type="checkbox"/>	2	---	---	---
<input type="checkbox"/>	3	---	---	---
<input type="checkbox"/>	4	---	---	---
<input type="checkbox"/>	5	---	---	---
<input type="checkbox"/>	6	---	---	---
<input type="checkbox"/>	7	---	---	---
<input type="checkbox"/>	8	---	---	---
<input type="checkbox"/>	9	---	---	---
<input type="checkbox"/>	10	---	---	LAG1
<input type="checkbox"/>	11	---	---	LAG1
<input type="checkbox"/>	12	---	---	LAG1

Note:

1. For one port, you cannot enable the Storm Control and the Ingress rate control at the same time.
2. If you select "Manual" to set Ingress/Egress rate, the system will automatically select integral multiple of 64Kbps that closest to the rate you entered as the real Ingress/Egress rate.

Figure 9-11 Rate Limit

The following entries are displayed on this screen:

➤ **Rate Limit Config**

Port Select: Click the **Select** button to quick-select the corresponding port based on the port number you entered.

Select: Select the desired port for Rate configuration. It is multi-optional.

Port: Displays the port number of the switch.

Ingress Rate (bps): Configure the bandwidth for receiving packets on the port. You can select a rate from the dropdown list or select "Manual" to set Ingress rate, the system will automatically select integral multiple of 64Kbps that closest to the rate you entered as the real Ingress rate.

Egress Rate(bps): Configure the bandwidth for sending packets on the port. You can select a rate from the dropdown list or select "Manual" to set Egress rate, the system will automatically select integral multiple of 64Kbps that closest to the rate you entered as the real Egress rate.

LAG: Displays the LAG number which the port belongs to.



Note:

1. If you enable ingress rate limit feature for the storm control-enabled port, storm control feature will be disabled for this port.
2. When selecting "Manual" to set Ingress/Egress rate, the system will automatically select integral multiple of 64Kbps that closest to the rate you entered as the real Ingress/Egress rate. For example, if you enter 1000Kbps for egress rate, the system will automatically select 1024Kbps as the real Egress rate.
3. When egress rate limit feature is enabled for one or more ports, you are suggested to disable the flow control on each port to ensure the switch works normally.

9.2.2 Storm Control

Storm Control function allows the switch to filter broadcast, multicast and UL frame in the network. If the transmission rate of the three kind packets exceeds the set bandwidth, the packets will be automatically discarded to avoid network broadcast storm.

Choose the menu **QoS**→**Bandwidth Control**→**Storm Control** to load the following page.

For TL-SG2216/TL-SG2424/TL-SG2424P:

Select	Port	Broadcast Rate(bps)	Multicast Rate(bps)	UL-Frame Rate(bps)	LAG
<input checked="" type="checkbox"/>		128K	128K	128K	
<input type="checkbox"/>	1	---	---	---	
<input type="checkbox"/>	2	---	---	---	
<input type="checkbox"/>	3	---	---	---	
<input type="checkbox"/>	4	---	---	---	
<input type="checkbox"/>	5	---	---	---	
<input type="checkbox"/>	6	---	---	---	
<input type="checkbox"/>	7	---	---	---	
<input type="checkbox"/>	8	---	---	---	
<input type="checkbox"/>	9	---	---	---	
<input type="checkbox"/>	10	---	---	---	LAG1
<input type="checkbox"/>	11	---	---	---	LAG1
<input type="checkbox"/>	12	---	---	---	LAG1

Note:

For one port, you cannot enable the Storm Control and the Ingress rate control at the same time.

Figure 9-12 Storm Control

The following entries are displayed on this screen:

➤ **Storm Control Config**

Port Select:

Click the **Select** button to quick-select the corresponding port based on the port number you entered.

Select:

Select the desired port for Storm Control configuration. It is multi-optional.

Port:

Displays the port number of the switch.

Broadcast Rate (bps):

Select the bandwidth for receiving broadcast packets on the port. The packet traffic exceeding the bandwidth will be discarded. Select Disable to disable the storm control function for the port.

Multicast Rate (bps):

Select the bandwidth for receiving multicast packets on the port. The packet traffic exceeding the bandwidth will be discarded. Select Disable to disable the storm control function for the port.

UL-Frame Rate (bps):

Select the bandwidth for receiving UL-Frame on the port. The packet traffic exceeding the bandwidth will be discarded. Select Disable to disable the storm control function for the port.

LAG:

Displays the LAG number which the port belongs to.

Note:
If you enable storm control feature for the ingress rate limit-enabled port, ingress rate limit feature will be disabled for this port.

For TL-SG2452:

Select	Port	Broadcast	Multicast	UL-Frame	Rate(bps)	LAG
<input type="checkbox"/>		<input type="text"/>	<input type="text"/>	<input type="text"/>	128K	
<input type="checkbox"/>	1	Disable	Disable	Disable	---	---
<input type="checkbox"/>	2	Disable	Disable	Disable	---	---
<input type="checkbox"/>	3	Disable	Disable	Disable	---	---
<input type="checkbox"/>	4	Disable	Disable	Disable	---	---
<input type="checkbox"/>	5	Disable	Disable	Disable	---	---
<input type="checkbox"/>	6	Disable	Disable	Disable	---	---
<input type="checkbox"/>	7	Disable	Disable	Disable	---	---
<input type="checkbox"/>	8	Disable	Disable	Disable	---	---
<input type="checkbox"/>	9	Disable	Disable	Disable	---	---
<input type="checkbox"/>	10	Disable	Disable	Disable	---	---
<input type="checkbox"/>	11	Disable	Disable	Disable	---	---
<input type="checkbox"/>	12	Disable	Disable	Disable	---	---

Note:
For one port, you cannot enable the Storm Control and the Ingress rate control at the same time.

Figure 9-13 Storm Control

The following entries are displayed on this screen:

➤ **Storm Control Config**

Port Select:

Click the **Select** button to quick-select the corresponding port based on the port number you entered.

Select:

Select the desired port for Storm Control configuration. It is multi-optional.

Port:

Displays the port number of the switch.

Broadcast:

Enable/Disable broadcast control feature for the port.

Multicast:

Enable/Disable multicast control feature for the port.

UL-Frame:

Enable/Disable UL-Frame control feature for the port.

Rate (bps):

Select the bandwidth for receiving the specified packet on the port. The packet traffic exceeding the bandwidth will be discarded.

LAG:

Displays the LAG number which the port belongs to.

**Note:**

If you enable storm control feature for the ingress rate limit-enabled port, ingress rate limit feature will be disabled for this port.

9.3 Voice VLAN

Voice VLANs are configured specially for voice data stream. By configuring Voice VLANs and adding the ports with voice devices attached to voice VLANs, you can perform QoS-related configuration for voice data, ensuring the transmission priority of voice data stream and voice quality.

➤ OUI Address (Organizationally unique identifier address)

The switch can determine whether a received packet is a voice packet by checking its source MAC address. If the source MAC address of a packet complies with the OUI addresses configured by the system, the packet is determined as voice packet and transmitted in voice VLAN.

An OUI address is a unique identifier assigned by IEEE (Institute of Electrical and Electronics Engineers) to a device vendor. It comprises the first 24 bits of a MAC address. You can recognize which vendor a device belongs to according to the OUI address. The following table shows the OUI addresses of several manufacturers. The following OUI addresses are preset of the switch by default.

Number	OUI Address	Vendor
1	00-01-e3-00-00-00	Siemens phone
2	00-03-6b-00-00-00	Cisco phone
3	00-04-0d-00-00-00	Avaya phone
4	00-60-b9-00-00-00	Philips/NEC phone
5	00-d0-1e-00-00-00	Pingtel phone
6	00-e0-75-00-00-00	Polycom phone
7	00-e0-bb-00-00-00	3com phone

Table 9-1 OUI addresses on the switch

➤ Port Voice VLAN Mode

A voice VLAN can operate in two modes: automatic mode and manual mode.

Automatic Mode: In this mode, the switch automatically adds a port which receives voice packets to voice VLAN and determines the priority of the packets through learning the source MAC of the UNTAG packets sent from IP phone when it is powered on. The aging time of voice VLAN can be configured on the switch. If the switch does not receive any voice packet on the ingress port within the aging time, the switch will remove this port from voice VLAN. Voice ports are automatically added into or removed from voice VLAN.

Manual Mode: You need to manually add the port of IP phone to voice VLAN, and then the switch will assign ACL rules and configure the priority of the packets through learning the source MAC address of packets and matching OUI address.

In practice, the port voice VLAN mode is configured according to the type of packets sent out from voice device and the link type of the port. The following table shows the detailed information.

Port Voice VLAN Mode	Voice Stream Type	Link type of the port and processing mode
Automatic Mode	TAG voice stream	Untagged: Not supported.
		Tagged: Supported. The default VLAN of the port cannot be voice VLAN.
	UNTAG voice stream	Untagged: Supported.
		Tagged: Not supported.
Manual Mode	TAG voice stream	Untagged: Not supported.
		Tagged: Supported. The default VLAN of the port should not be voice VLAN.
	UNTAG voice stream	Untagged: Supported.
		Tagged: Not supported.

Table 9-2 Port voice VLAN mode and voice stream processing mode

➤ Security Mode of Voice VLAN

When voice VLAN is enabled for a port, you can configure its security mode to filter data stream. If security mode is enabled, the port just forwards voice packets, and discards other packets whose source MAC addresses do not match OUI addresses. If security mode is not enabled, the port forwards all the packets.

Security Mode	Packet Type	Processing Mode
Enable	UNTAG packet	When the source MAC address of the packet is the OUI address that can be identified, the packet can be transmitted in the voice VLAN. Otherwise, the packet will be discarded.
	Packet with voice VLAN TAG	
	Packet with other VLAN TAG	The processing mode for the device to deal with the packet is determined by whether the port permits the VLAN or not, independent of voice VLAN security mode.
Disable	UNTAG packet	Do not check the source MAC address of the packet and all the packets can be transmitted in the voice VLAN.
	Packet with voice VLAN TAG	
	Packet with other VLAN TAG	The processing mode for the device to deal with the packet is determined by whether the port permits the VLAN or not, independent of voice VLAN security mode.

Table 9-3 Security mode and packets processing mode



Note:

Don't transmit voice stream together with other business packets in the voice VLAN except for some special requirements.

The Voice VLAN function can be implemented on **Global Config**, **Port Config** and **OUI Config** pages.

9.3.1 Global Config

On this page, you can configure the global parameters of the voice VLAN, including VLAN ID and aging time.

Choose the menu **QoS**→**Voice VLAN**→**Global Config** to load the following page.

Global Config

Voice VLAN: Enable Disable

VLAN ID : (2-4094)

Aging Time: min (1-43200, default: 1440)

Priority: ▼

Apply

Help

Figure 9-14 Global Configuration

The following entries are displayed on this screen:

➤ **Global Config**

- Voice VLAN:** Select Enable/Disable Voice VLAN function.
- VLAN ID:** Enter the VLAN ID of the voice VLAN.
- Aging Time:** Specifies the living time of the member port in auto mode after the OUI address is aging out.
- Priority:** Select the priority of the port when sending voice data.

9.3.2 Port Config

Before the voice VLAN function is enabled, the parameters of the ports in the voice VLAN should be configured on this page.

Choose the menu **QoS**→**Voice VLAN**→**Port Config** to load the following page.

Port Config						
					Port <input type="text"/>	<input type="button" value="Select"/>
Select	Port	Port Mode	Security Mode	Member State	LAG	
<input type="checkbox"/>		<input type="text" value="Auto"/>	<input type="text" value="Disable"/>			
<input type="checkbox"/>	1	Auto	Disable	Inactive	---	
<input type="checkbox"/>	2	Auto	Disable	Inactive	---	
<input type="checkbox"/>	3	Auto	Disable	Inactive	---	
<input type="checkbox"/>	4	Auto	Disable	Inactive	---	
<input type="checkbox"/>	5	Auto	Disable	Inactive	---	
<input type="checkbox"/>	6	Auto	Disable	Inactive	---	
<input type="checkbox"/>	7	Auto	Disable	Inactive	---	
<input type="checkbox"/>	8	Auto	Disable	Inactive	---	
<input type="checkbox"/>	9	Auto	Disable	Inactive	---	
<input type="checkbox"/>	10	Auto	Disable	Inactive	---	

Figure 9-15 Port Config



Note:

To enable voice VLAN function for the LAG member port, please ensure its member state accords with its port mode.

If a port is a member port of voice VLAN, changing its port mode to be “Auto” will make the port leave the voice VLAN and will not join the voice VLAN automatically until it receives voice streams.

The following entries are displayed on this screen:

➤ **Port Config**

Port Select: Click the **Select** button to quick-select the corresponding port based on the port number you entered.

Select: Select the desired port for voice VLAN configuration. It is multi-optional.

Port: Displays the port number of the switch.

Port Mode: Select the mode for the port to join the voice VLAN.

- **Auto:** In this mode, the switch automatically adds a port to the voice VLAN or removes a port from the voice VLAN by checking whether the port receives voice data or not.
- **Manual:** In this mode, you can manually add a port to the voice VLAN or remove a port from the voice VLAN.

Security Mode: Configure the security mode for forwarding packets.

- **Disable:** All packets are forwarded.
- **Enable:** Only voice data are forwarded.

Member State: Displays the state of the port in the current voice VLAN.

LAG: Displays the LAG number which the port belongs to.

9.3.3 OUI Config

The switch supports OUI creation and adds the MAC address of the special voice device to the OUI table of the switch. The switch determines whether a received packet is a voice packet by checking its OUI address. The switch analyzes the received packets. If the packets recognized as voice packets, the access port will be automatically added to the Voice VLAN.

Choose the menu **QoS**→**Voice VLAN**→**OUI Config** to load the following page.

Create OUI

OUI: (Format: 00-00-00-00-00-01)

Mask: (Default: FF-FF-FF-00-00-00) Create

Description: (16 characters maximum)

OUI Table

Select	OUI	Mask	Description
<input type="checkbox"/>	00-01-e3-00-00-00	ff-ff-ff-00-00-00	Siemens Phone
<input type="checkbox"/>	00-03-6b-00-00-00	ff-ff-ff-00-00-00	Cisco Phone
<input type="checkbox"/>	00-04-0d-00-00-00	ff-ff-ff-00-00-00	Awaya Phone
<input type="checkbox"/>	00-60-b9-00-00-00	ff-ff-ff-00-00-00	Philips Phone
<input type="checkbox"/>	00-d0-1e-00-00-00	ff-ff-ff-00-00-00	Pingtel Phone
<input type="checkbox"/>	00-e0-75-00-00-00	ff-ff-ff-00-00-00	PolyCom Phone
<input type="checkbox"/>	00-e0-bb-00-00-00	ff-ff-ff-00-00-00	3Com Phone

All
Delete
Help

Figure 9-16 OUI Configuration

The following entries are displayed on this screen:

➤ **Create OUI**

OUI: Enter the OUI address of the voice device.

Mask: Enter the OUI address mask of the voice device.

Description: Give a description to the OUI for identification.

➤ **OUI Table**

Select: Select the desired entry to view the detailed information.

OUI: Displays the OUI address of the voice device.

Mask: Displays the OUI address mask of the voice device.

Description: Displays the description of the OUI.

Configuration Procedure of Voice VLAN:

Step	Operation	Description
1	Configure the link type of the port	Required. On VLAN → 802.1Q VLAN → VLAN Config page, configure the link type of ports of the voice device.
2	Create VLAN	Required. On VLAN → 802.1Q VLAN → VLAN Config page, click the Create button to create a VLAN.

Step	Operation	Description
3	Add OUI address	Optional. On QoS → Voice VLAN → OUI Config page, you can check whether the switch is supporting the OUI template or not. If not, please add the OUI address.
4	Configure the parameters of the ports in voice VLAN.	Required. On QoS → Voice VLAN → Port Config page, configure the parameters of the ports in voice VLAN.
5	Enable Voice VLAN	Required. On QoS → Voice VLAN → Global Config page, configure the global parameters of voice VLAN.

[Return to CONTENTS](#)

Chapter 10 ACL

10.1 ACL Config

An ACL may contain a number of rules, and each rule specifies a different package range. Packets are matched in match order. Once a rule is matched, the switch processes the matched packets taking the operation specified in the rule without considering the other rules, which can enhance the performance of the switch.

The ACL Config function can be implemented on **ACL Summary**, **ACL Create**, **MAC ACL**, **Standard-IP ACL** and **Extend-IP ACL** pages.

10.1.1 ACL Summary

On this page, you can view the current ACLs configured in the switch.

Choose the menu **ACL**→**ACL Config**→**ACL Summary** to load the following page.

The screenshot shows a web interface for ACL configuration. At the top, there is a light blue header bar labeled 'Search Options'. Below this header, there are three search criteria: 'Select a ACL:' with a dropdown menu, 'ACL Type:' with a radio button, and 'Rule Order:' with a radio button. To the right of these criteria is a 'Delete' button. Below the search options is another light blue header bar labeled 'Rule Table'. Below this header are three buttons: 'All', 'Delete', and 'Help'.

Figure 10-1 ACL Summary

The following entries are displayed on this screen:

➤ **Search Option**

- Select ACL:** Select the ACL you have created
- ACL Type:** Displays the type of the ACL you select.
- Rule Order:** Displays the rule order of the ACL you select.

➤ **Rule Table**

Display the rule table of the ACL you have selected. Here you can edit the rules, view the details of them, and move them up and down.

10.1.2 ACL Create

On this page you can create ACLs.

Choose the menu **ACL**→**ACL Config**→**ACL Create** to load the following page.

Create ACL

ACL ID:

0-99 MAC ACL
 100-199 Standard-IP ACL
 200-299 Extend-IP ACL

Rule Order:

Figure 10-2 ACL Create

The following entries are displayed on this screen:

➤ **Create ACL**

ACL ID: Enter ACL ID of the ACL you want to create.

Rule Order: User Config order is set to be match order in this ACL.

10.1.3 MAC ACL

MAC ACLs analyze and process packets based on a series of match conditions, which can be the source MAC addresses and destination MAC addresses carried in the packets.

Choose the menu **ACL**→**ACL Config**→**MAC ACL** to load the following page.

Create MAC-Rule

ACL ID:

Rule ID:

Operation:

S-MAC: Mask:

D-MAC: Mask:

Figure 10-3 Create MAC Rule

The following entries are displayed on this screen:

➤ **Create MAC ACL**

ACL ID: Select the desired MAC ACL for configuration.

Rule ID: Enter the rule ID.

- Operation:** Select the operation for the switch to process packets which match the rules.
- Permit: Forward packets.
 - Deny: Discard Packets.
- S-MAC:** Enter the source MAC address contained in the rule.
- D-MAC:** Enter the destination MAC address contained in the rule.
- MASK:** Enter MAC address mask. If it is set to 1, it must strictly match the address.

10.1.4 Standard-IP ACL

Standard-IP ACLs analyze and process data packets based on a series of match conditions, which can be the source IP addresses and destination IP addresses carried in the packets.

Choose the menu **ACL**→**ACL Config**→**Standard-IP ACL** to load the following page.

Figure 10-4 Create Standard-IP Rule

The following entries are displayed on this screen:

➤ **Create Standard-IP ACL**

- ACL ID:** Select the desired Standard-IP ACL for configuration.
- Rule ID:** Enter the rule ID.
- Operation:** Select the operation for the switch to process packets which match the rules.
- Permit: Forward packets.
 - Deny: Discard Packets.
- S-IP:** Enter the source IP address contained in the rule.
- D-IP:** Enter the destination IP address contained in the rule.
- Mask:** Enter IP address mask. If it is set to 1, it must strictly match the address.

10.1.5 Extend-IP ACL

Extend-IP ACLs analyze and process data packets based on a series of match conditions, which can be the source IP addresses, destination IP addresses, IP protocol and other information of this sort carried in the packets.

Choose the menu **ACL**→**ACL Config**→**Extend-IP ACL** to load the following page.

ACL ID: Extend-IP ACL

Rule ID:

Operation: Permit

S-IP: Mask:

D-IP: Mask:

IP Protocol: All

S-Port:

D-Port:

Create Help

Figure 10-5 Create Extend-IP Rule

The following entries are displayed on this screen:

➤ **Create Extend-IP ACL**

- ACL ID:** Select the desired Extend-IP ACL for configuration.
- Rule ID:** Enter the rule ID.
- Operation:** Select the operation for the switch to process packets which match the rules.
- Permit: Forward packets.
 - Deny: Discard Packets.
- S-IP:** Enter the source IP address contained in the rule.
- D-IP:** Enter the destination IP address contained in the rule.
- Mask:** Enter IP address mask. If it is set to 1, it must strictly match the address.
- IP Protocol:** Select IP protocol contained in the rule.
- S-Port:** Configure TCP/IP source port contained in the rule when TCP/UDP is selected from the pull-down list of IP Protocol.
- D-Port:** Configure TCP/IP destination port contained in the rule when TCP/UDP is selected from the pull-down list of IP Protocol.

10.2 Policy Config

A Policy is used to control the data packets those match the corresponding ACL rules by configuring ACLs and actions together for effect.

The Policy Config can be implemented on **Policy Summary**, **Police Create** and **Action Create** pages.

10.2.1 Policy Summary

On this page, you can view the ACL and the corresponding operations in the policy.

Choose the menu **ACL**→**Policy Config**→**Policy Summary** to load the following page.

The screenshot shows a web interface for policy management. At the top, there is a blue header bar labeled "Select Options". Below it, the text "Select a Policy:" is followed by a dropdown menu and a "Delete" button. Below this is another blue header bar labeled "Action Table". Underneath, there is a table with three columns: "Select", "Index", and "ACL ID". Below the table, there are three buttons: "All", "Delete", and "Help".

Figure 10-6 Policy Summary

The following entries are displayed on this screen:

➤ **Search Option**

Select Policy: Select name of the desired policy for view. If you want to delete the desired policy, please click the **Delete** button.

➤ **Action Table**

Select: Select the desired entry to delete the corresponding policy.

Index: Displays the index of the policy.

ACL ID: Displays the ID of the ACL contained in the policy.

10.2.2 Policy Create

On this page you can create the policy.

Choose the menu **ACL**→**Policy Config**→**Policy Create** to load the following page.

The screenshot shows a web interface for creating a policy. At the top, there is a blue header bar labeled "Create Policy". Below it, the text "Policy Name:" is followed by a text input field. To the right of the input field are two buttons: "Create" and "Help".

Figure 10-7 Create Policy

The following entries are displayed on this screen:

➤ **Create Policy**

Policy Name: Enter the name of the policy.

10.2.3 Action Create

On this page you can add ACLs for the policy.

Choose the menu **ACL**→**Policy Config**→**Action Create** to load the following page.

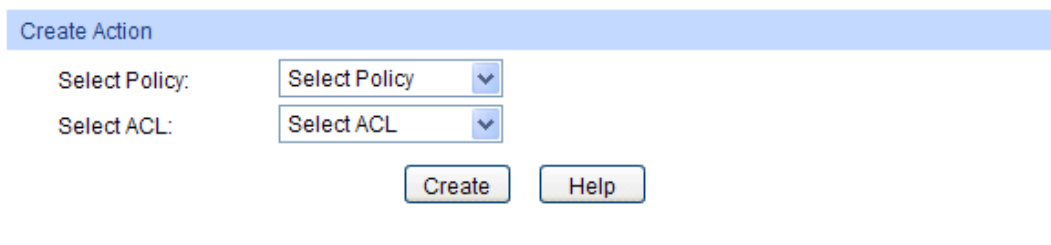

Figure 10-8 Action Create

The following entries are displayed on this screen:

➤ **Create Action**

Select Policy: Select the name of the policy.

Select ACL: Select the ACL for configuration in the policy.

10.3 Policy Binding

Policy Binding function can have the policy take its effect on a specific port/VLAN. The policy will take effect only when it is bound to a port/VLAN. In the same way, the port/VLAN will receive the data packets and process them based on the policy only when the policy is bound to the port/VLAN.

The Policy Binding can be implemented on **Binding Table**, **Port Binding** and **VLAN Binding** pages.

10.3.1 Binding Table

On this page view the policy bound to port/VLAN.

Choose the menu **ACL**→**Policy Binding**→**Binding Table** to load the following page.

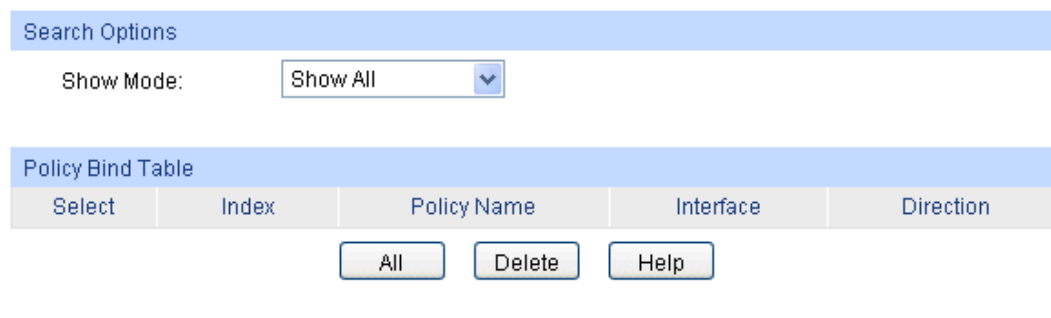

Figure 10-9 Binding Table

The following entries are displayed on this screen:

➤ **Search Option**

Show Mode: Select a show mode appropriate to your needs.

➤ **Policy Bind Table**

- Select:** Select the desired entry to delete the corresponding binding policy.
- Index:** Displays the index of the binding policy.
- Policy Name:** Displays the name of the binding policy.
- Interface:** Displays the port number or VLAN ID bound to the policy.
- Direction:** Displays the binding direction.

10.3.2 Port Binding

On this page you can bind a policy to a port.

Choose the menu **ACL**→**Policy Binding**→**Port Binding** to load the following page.

The screenshot shows two parts of a web interface. The top part is titled "Port-Bind Config" and contains a form with the following fields: "Policy Name:" with a dropdown menu showing "Select Policy", "Port:" with a text input field and a note "(Format:1-3,6,8)", and two buttons labeled "Bind" and "Help". The bottom part is titled "Port-Bind Table" and shows a table with four columns: "Index", "Policy Name", "Port", and "Direction".

Figure 10-10 Bind the policy to the port

The following entries are displayed on this screen:

➤ **Port-Bind Config**

- Policy Name:** Select the name of the policy you want to bind.
- Port:** Enter the number of the port you want to bind.

➤ **Port-Bind Table**

- Index:** Displays the index of the binding policy.
- Policy Name:** Displays the name of the binding policy.
- Port:** Displays the number of the port bound to the corresponding policy.
- Direction:** Displays the binding direction.



Note:

For TL-SG2216/TL-SG2424/TL-SG2424P, you can bind one policy to multiple interfaces; but for TL-SG2452, you can bind one policy to only one interface

10.3.3 VLAN Binding

On this page you can bind a policy to a VLAN.

Choose the menu **ACL**→**Policy Binding**→**VLAN Binding** to load the following page.

The screenshot shows two parts of a web interface. The top part is titled "VLAN-Bind Config" and contains two input fields: "Policy Name:" with a dropdown menu showing "Select Policy" and a "Bind" button; and "VLAN ID:" with a text input field and a "(Format:2-10,100)" label, along with a "Help" button. The bottom part is titled "VLAN-Bind Table" and shows a table with four columns: "Index", "Policy Name", "VLAN ID", and "Direction".

Figure 10-11 Bind the policy to the VLAN

The following entries are displayed on this screen:

➤ **VLAN-Bind Config**

Policy Name: Select the name of the policy you want to bind.

VLAN ID: Enter the ID of the VLAN you want to bind.

➤ **VLAN-Bind Table**

Index: Displays the index of the binding policy.

Policy Name: Displays the name of the binding policy.

VLAN ID: Displays the ID of the VLAN bound to the corresponding policy.

Direction: Displays the binding direction.

Configuration Procedure:

Step	Operation	Description
1	Configure ACL rules	Required. On ACL → ACL Config configuration pages, configure ACL rules to match packets.
2	Configure Policy	Required. On ACL → Policy Config configuration pages, configure the policy to control the data packets those match the corresponding ACL rules.
3	Bind the policy to the port/VLAN	Required. On ACL → Policy Binding configuration pages, bind the policy to the port/VLAN to make the policy effective on the corresponding port/VLAN.



Note:

For TL-SG2216/TL-SG2424/TL-SG2424P, you can bind one policy to multiple VLANs; but for TL-SG2452, you can bind one policy to only one VLAN

10.4 Application Example for ACL

> Network Requirements

1. The manager of the R&D department can access to the forum of the company and the Internet without any forbiddance. The MAC address of the manager is 00-64-A5-5D-12-C3.
2. The staff of the R&D department cannot access to the Internet but can visit the forum.
3. The staff of the marketing department can access to the Internet but cannot visit the forum.
4. The R&D department and marketing department cannot communicate with each other.

> Network Diagram

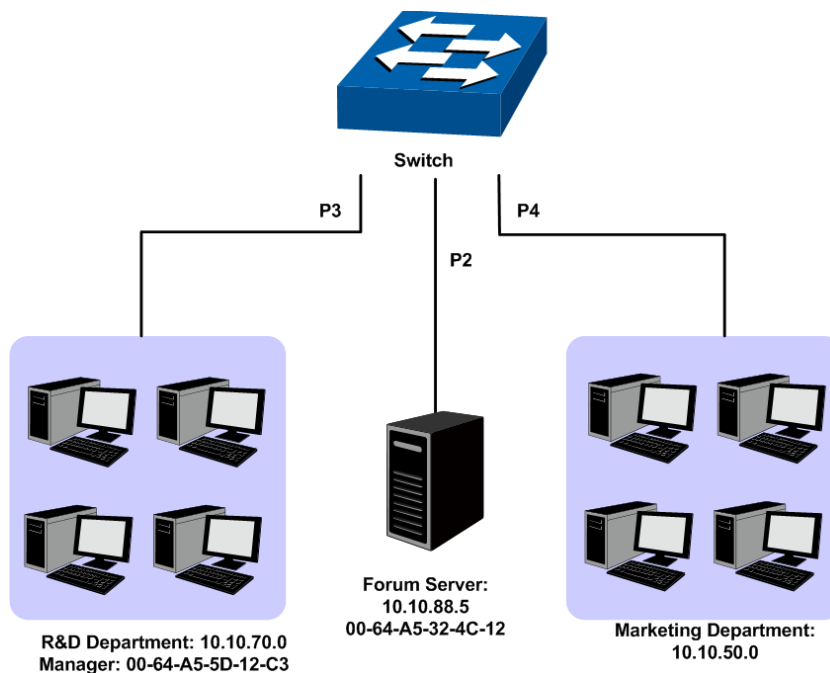

> Configuration Procedure

Step	Operation	Description
1	Configure for requirement 1	<p>On ACL→ACL Config→ACL Create page, create ACL 11.</p> <p>On ACL→ACL Config→MAC ACL page, select ACL 11, create Rule 1, configure the operation as Permit, configure the S-MAC as 00-64-A5-5D-12-C3 and mask as FF-FF-FF-FF-FF-FF.</p> <p>On ACL→Policy Config→Policy Create page, create a policy named manager.</p> <p>On ACL→Policy Config→Action Create page, add ACL 11 to Policy manager.</p> <p>On ACL→Policy Binding→Port Binding page, select Policy manager to bind to port 3.</p>

Step	Operation	Description
2	Configure for requirement 2 and 4	<p>On ACL→ACL Config→ACL Create page, create ACL 100.</p> <p>On ACL→ACL Config→Standard-IP ACL page, select ACL 100, create Rule 1, configure operation as Deny, configure S-IP as 10.10.70.0 and mask as 255.255.255.0, configure D-IP as 10.10.50.0 and mask as 255.255.255.0.</p> <p>On ACL→ACL Config→Standard-IP ACL page, select ACL 100, create Rule 2, configure operation as Deny, configure S-IP as 10.10.70.0 and mask as 255.255.255.0, configure D-IP as 10.10.88.5 and mask as 255.255.255.255.</p> <p>On ACL→ACL Config→Standard-IP ACL page, select ACL 100, create Rule 3, configure operation as Permit, configure S-IP as 10.10.70.0 and mask as 255.255.255.0, configure D-IP as 10.10.88.5 and mask as 255.255.255.255.</p> <p>On ACL→Policy Config→Policy Create page, create a policy named limit1.</p> <p>On ACL→Policy Config→Action Create page, add ACL 100 to Policy limit1.</p> <p>On ACL→Policy Binding→Port Binding page, select Policy limit1 to bind to port 3.</p>
3	Configure for requirement 3 and 4	<p>On ACL→ACL Config→ACL Create page, create ACL 101.</p> <p>On ACL→ACL Config→Standard-IP ACL page, select ACL 101, create Rule 4, configure operation as Deny, configure S-IP as 10.10.70.0 and mask as 255.255.255.0, configure D-IP as 10.10.50.0 and mask as 255.255.255.0.</p> <p>On ACL→ACL Config→Standard-IP ACL page, select ACL 101, create Rule 5, configure operation as Deny, configure S-IP as 10.10.70.0 and mask as 255.255.255.0, configure D-IP as 10.10.88.5 and mask as 255.255.255.255.</p> <p>On ACL→Policy Config→Policy Create page, create a policy named limit2.</p> <p>On ACL→Policy Config→Action Create page, add ACL 101 to Policy limit2.</p> <p>On ACL→Policy Binding→Port Binding page, select Policy limit2 to bind to port 4.</p>

[Return to CONTENTS](#)

Chapter 11 Network Security

Network Security module provides the protection measure for the network security, including one submenu: **802.1X**.

11.1 802.1X

The 802.1X protocol was developed by IEEE802 LAN/WAN committee to deal with the security issues of wireless LANs. It was then used in Ethernet as a common access control mechanism for LAN ports to solve mainly authentication and security problems.

802.1X is a port-based network access control protocol. It authenticates and controls devices requesting for access in terms of the ports of LAN access control devices. With the 802.1X protocol enabled, a supplicant can access the LAN only when it passes the authentication, whereas those failing to pass the authentication are denied when accessing the LAN.

➤ Architecture of 802.1X Authentication

802.1X adopts a client/server architecture with three entities: a supplicant system, an authenticator system, and an authentication server system, as shown in the following figure.

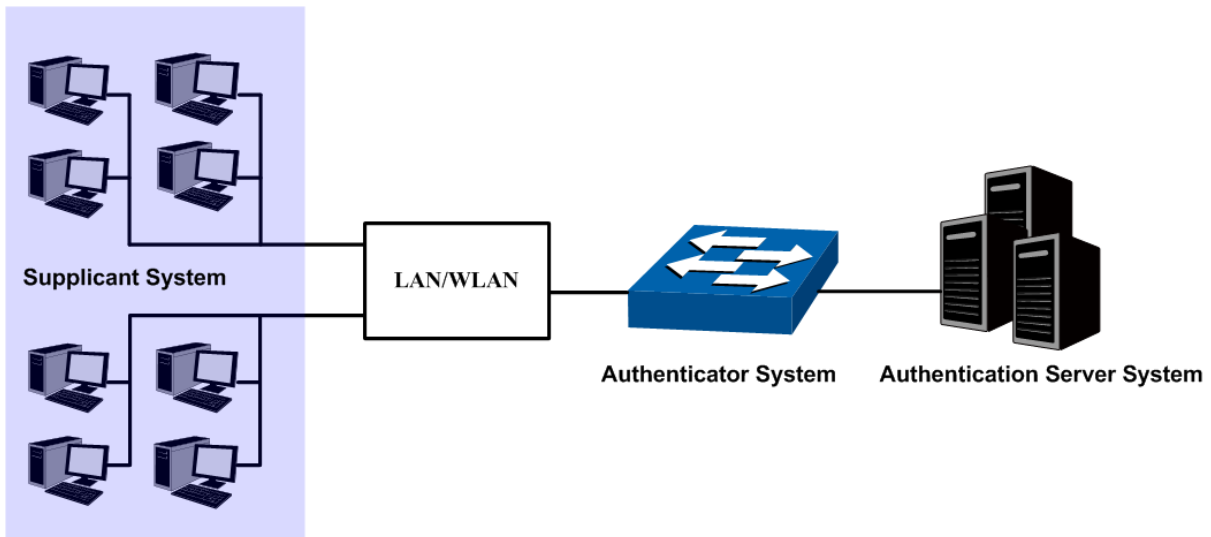

Figure 11-1 Architecture of 802.1X authentication

- (1) **Supplicant System:** The supplicant system is an entity in LAN and is authenticated by the authenticator system. The supplicant system is usually a common user terminal computer. An 802.1X authentication is initiated when a user launches client program on the supplicant system. Note that the client program must support the 802.1X authentication protocol.
- (2) **Authenticator System:** The authenticator system is usually an 802.1X-supported network device, such as this TP-LINK switch. It provides the physical or logical port for the supplicant system to access the LAN and authenticates the supplicant system.
- (3) **Authentication Server System:** The authentication server system is an entity that provides authentication service to the authenticator system. Normally in the form of a RADIUS server. Authentication Server can store user information and serve to perform authentication and authorization. To ensure a stable authentication system, an alternate authentication server can be specified. If the main authentication server is in trouble, the alternate authentication server can substitute it to provide normal authentication service.

➤ **The Mechanism of an 802.1X Authentication System**

IEEE 802.1X authentication system uses EAP (Extensible Authentication Protocol) to exchange information between the supplicant system and the authentication server.

- (1) EAP protocol packets transmitted between the supplicant system and the authenticator system are encapsulated as EAPOL packets.
- (2) EAP protocol packets transmitted between the authenticator system and the RADIUS server can either be encapsulated as EAPOR (EAP over RADIUS) packets or be terminated at authenticator system and the authenticator system then communicate with RADIUS servers through PAP (Password Authentication Protocol) or CHAP (Challenge Handshake Authentication Protocol) protocol packets.
- (3) When a supplicant system passes the authentication, the authentication server passes the information about the supplicant system to the authenticator system. The authenticator system in turn determines the state (authorized or unauthorized) of the controlled port according to the instructions (accept or reject) received from the RADIUS server.

➤ **802.1X Authentication Procedure**

An 802.1X authentication can be initiated by supplicant system or authenticator system. When the authenticator system detects an unauthenticated supplicant in LAN, it will initiate the 802.1X authentication by sending EAP-Request/Identity packets to the supplicant. The supplicant system can also launch an 802.1X client program to initiate an 802.1X authentication through the sending of an EAPOL-Start packet to the switch,

This TP-LINK switch can authenticate supplicant systems in EAP relay mode or EAP terminating mode. The following illustration of these two modes will take the 802.1X authentication procedure initiated by the supplicant system for example.

(1) EAP Relay Mode

This mode is defined in 802.1X. In this mode, EAP-packets are encapsulated in higher level protocol (such as EAPOR) packets to allow them successfully reach the authentication server. This mode normally requires the RADIUS server to support the two fields of EAP: the EAP-message field and the Message-authenticator field. This switch supports EAP-MD5 authentication way for the EAP relay mode. The following figure describes the basic EAP-MD5 authentication procedure.

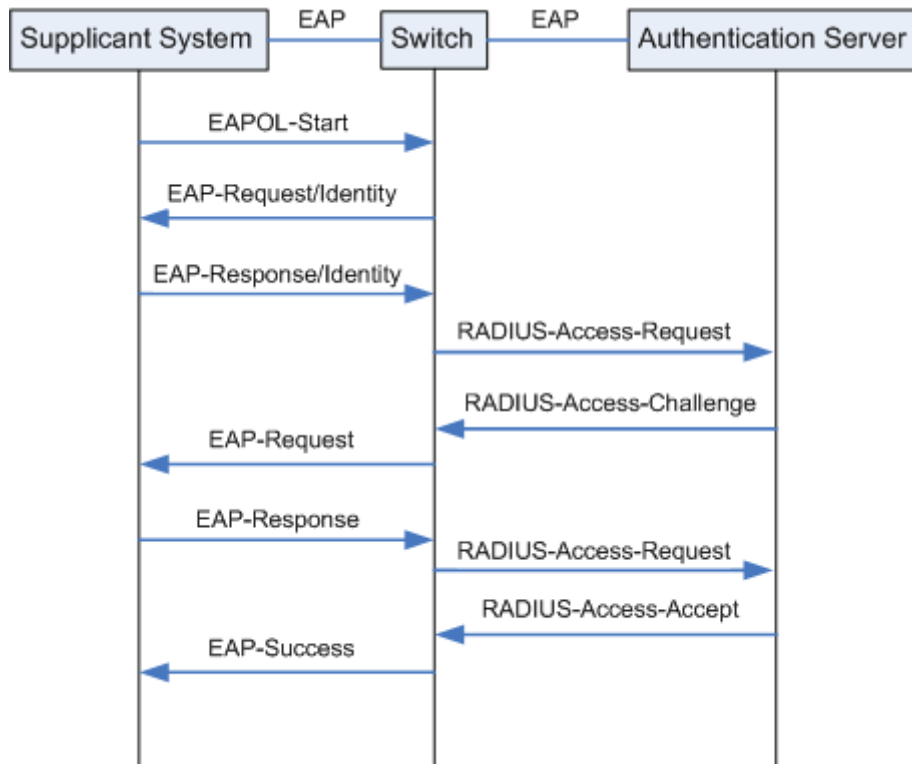

Figure 11-2 EAP-MD5 Authentication Procedure

1. A supplicant system launches an 802.1X client program via its registered user name and password to initiate an access request through the sending of an EAPOL-Start packet to the switch. The 802.1X client program then forwards the packet to the switch to start the authentication process.
2. Upon receiving the authentication request packet, the switch sends an EAP-Request/Identity packet to ask the 802.1X client program for the user name.
3. The 802.1X client program responds by sending an EAP-Response/Identity packet to the switch with the user name included. The switch then encapsulates the packet in a RADIUS Access-Request packet and forwards it to the RADIUS server.
4. Upon receiving the user name from the switch, the RADIUS server retrieves the user name, finds the corresponding password by matching the user name in its database, encrypts the password using a randomly-generated key, and sends the key to the switch through an RADIUS Access-Challenge packet. The switch then sends the key to the 802.1X client program.
5. Upon receiving the key (encapsulated in an EAP-Request/MD5 Challenge packet) from the switch, the client program encrypts the password of the supplicant system with the key and sends the encrypted password (contained in an EAP-Response/MD5 Challenge packet) to the RADIUS server through the switch. (The encryption is irreversible.)

6. The RADIUS server compares the received encrypted password (contained in a RADIUS Access-Request packet) with the locally-encrypted password. If the two match, it will then send feedbacks (through a RADIUS Access-Accept packet and an EAP-Success packet) to the switch to indicate that the supplicant system is authorized.
7. The switch changes the state of the corresponding port to accepted state to allow the supplicant system access the network. And then the switch will monitor the status of supplicant by sending hand-shake packets periodically. By default, the switch will force the supplicant to log off if it cannot get the response from the supplicant for two times.
8. The supplicant system can also terminate the authenticated state by sending EAPOL-Logoff packets to the switch. The switch then changes the port state from accepted to rejected.

(2) EAP Terminating Mode

In this mode, packet transmission is terminated at authenticator systems and the EAP packets are mapped into RADIUS packets. Authentication and accounting are accomplished through RADIUS protocol.

In this mode, PAP or CHAP is employed between the switch and the RADIUS server. This switch supports the PAP terminating mode. The authentication procedure of PAP is illustrated in the following figure.

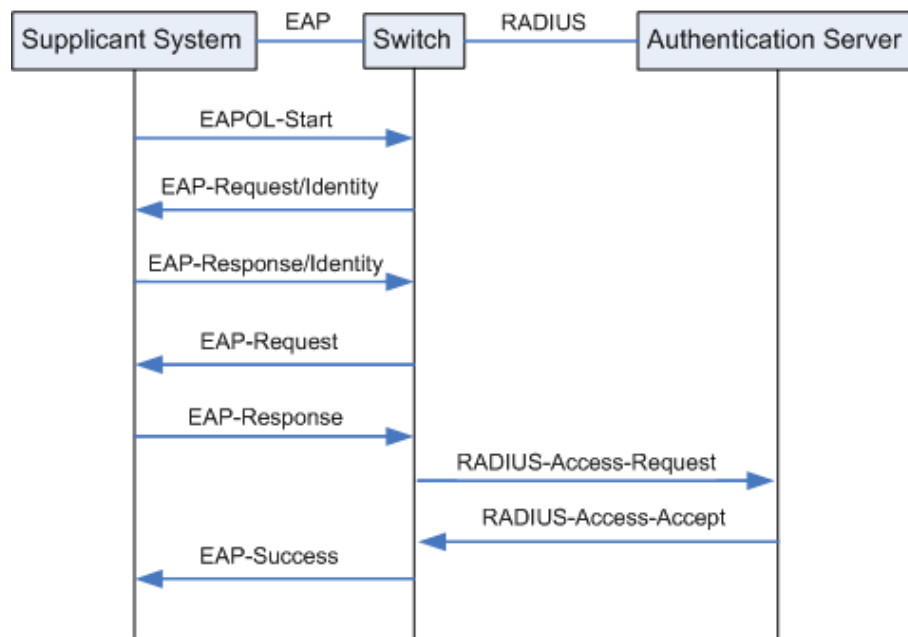

Figure 11-3 PAP Authentication Procedure

In PAP mode, the switch encrypts the password and sends the user name, the randomly-generated key, and the supplicant system-encrypted password to the RADIUS server for further authentication. Whereas the randomly-generated key in EAP-MD5 relay mode is generated by the authentication server, and the switch is responsible to encapsulate the authentication packet and forward it to the RADIUS server.

➤ **802.1X Timer**

In 802.1 x authentication, the following timers are used to ensure that the supplicant system, the switch, and the RADIUS server interact in an orderly way:

- (1) **Supplicant system timer (Supplicant Timeout):** This timer is triggered by the switch after the switch sends a request packet to a supplicant system. The switch will resend the request packet to the supplicant system if the supplicant system fails to respond in the specified timeout period.

- (2) **RADIUS server timer (Server Timeout):** This timer is triggered by the switch after the switch sends an authentication request packet to RADIUS server. The switch will resend the authentication request packet if the RADIUS server fails to respond in the specified timeout period.
- (3) **Quiet-period timer (Quiet Period):** This timer sets the quiet-period. When a supplicant system fails to pass the authentication, the switch quiets for the specified period before it processes another authentication request re-initiated by the supplicant system.

➤ **Guest VLAN**

Guest VLAN function enables the supplicants that do not pass the authentication to access the specific network resource.

By default, all the ports connected to the supplicants belong to a VLAN, i.e. Guest VLAN. Users belonging to the Guest VLAN can access the resources of the Guest VLAN without being authenticated. But they need to be authenticated before accessing external resources. After passing the authentication, the ports will be removed from the Guest VLAN and be allowed to access the other resources.

With the Guest VLAN function enabled, users can access the Guest VLAN to install 802.1X client program or upgrade their 802.1x clients without being authenticated. If there is no supplicant past the authentication on the port in a certain time, the switch will add the port to the Guest VLAN.

With 802.1X function enabled and Guest VLAN configured, after the maximum number retries have been made to send the EAP-Request/Identity packets and there are still ports that have not sent any response back, the switch will then add these ports into the Guest VLAN according to their link types. Only when the corresponding user passes the 802.1X authentication, the port will be removed from the Guest VLAN and added to the specified VLAN. In addition, the port will back to the Guest VLAN when its connected user logs off.

The **802.1X** function is implemented on the **Global Config**, **Port Config** and **Radius Server** pages.

11.1.1 Global Config

On this page, you can enable the 802.1X authentication function globally and control the authentication process by specifying the Authentication Method, Guest VLAN and various Timers.

Choose the menu **Network Security**→**802.1X**→**Global Config** to load the following page.

The image shows two screenshots of a web configuration interface. The top screenshot is titled "Global Config" and contains the following fields: "802.1X:" with radio buttons for "Enable" and "Disable" (the "Disable" option is selected); "Auth Method:" with a dropdown menu showing "EAP-MD5"; "Guest VLAN:" with radio buttons for "Enable" and "Disable" (the "Disable" option is selected); and "Guest VLAN ID:" with a text input field containing "0" and a range "(1-4094)". An "Apply" button is located to the right of the "Auth Method:" field. The bottom screenshot is titled "Authentication Config" and contains the following fields: "Quiet" with radio buttons for "Enable" and "Disable" (the "Disable" option is selected); "Quiet Period:" with a text input field containing "10" and a range "sec (1-999)"; "Retry Times:" with a text input field containing "3" and a range "(1-9)"; "Supplicant Timeout:" with a text input field containing "3" and a range "sec (1-9)"; and "Server Timeout:" with a text input field containing "3" and a range "sec (1-9)". "Apply" and "Help" buttons are located to the right of the "Retry Times:" and "Supplicant Timeout:" fields respectively.

Figure 11-4 Global Config

The following entries are displayed on this screen:

➤ Global Config

802.1X: Enable/Disable the 802.1X function.

Authentication Method: Select the Authentication Method from the pull-down list.

- **EAP-MD5:** IEEE 802.1X authentication system uses extensible authentication protocol (EAP) to exchange information between the switch and the client. EAP protocol packets with authentication data can be encapsulated in the advanced protocol (such as RADIUS) packets to be transmitted to the authentication server. [
- **PAP:** IEEE 802.1X authentication system uses extensible authentication protocol (EAP) to exchange information between the switch and the client. The transmission of EAP packets is terminated at the switch and the EAP packets are converted to the other protocol (such as RADIUS) packets for transmission.

Guest VLAN: Enable/Disable the Guest VLAN feature.

Guest VLAN ID: Enter your desired VLAN ID to enable the Guest VLAN feature. The supplicants in the Guest VLAN can access the specified network source.

➤ Authentication Config

Quiet: Enable/Disable the Quiet timer.

Quiet Period: Specify a value for Quiet Period. Once the supplicant failed to the 802.1X Authentication, then the switch will not respond to the authentication request from the same supplicant during the Quiet Period.

Retry Times: Specify the maximum transfer times of the repeated authentication request.

Supplicant Timeout: Specify the maximum time for the switch to wait for the response from supplicant before resending a request to the supplicant.

Server Timeout: Specify the maximum time for the switch to wait for the response from authentication server before resending a request to the authentication server.

11.1.2 Port Config

On this page, you can configure the 802.1X features for the ports based on the actual network. Choose the menu **Network Security**→**802.1X**→**Port Config** to load the following page.

Select	Port	Status	Guest VLAN	Control Mode	Control Type	Authorized	LAG
<input type="checkbox"/>		Disable	Disable	Auto	MAC Based		
<input type="checkbox"/>	1	Disable	Disable	Auto	MAC Based	Yes	---
<input type="checkbox"/>	2	Disable	Disable	Auto	MAC Based	Yes	---
<input type="checkbox"/>	3	Disable	Disable	Auto	MAC Based	Yes	---
<input type="checkbox"/>	4	Disable	Disable	Auto	MAC Based	Yes	---
<input type="checkbox"/>	5	Disable	Disable	Auto	MAC Based	Yes	---
<input type="checkbox"/>	6	Disable	Disable	Auto	MAC Based	Yes	---
<input type="checkbox"/>	7	Disable	Disable	Auto	MAC Based	Yes	---
<input type="checkbox"/>	8	Disable	Disable	Auto	MAC Based	Yes	---
<input type="checkbox"/>	9	Disable	Disable	Auto	MAC Based	Yes	---
<input type="checkbox"/>	10	Disable	Disable	Auto	MAC Based	Yes	---
<input type="checkbox"/>	11	Disable	Disable	Auto	MAC Based	Yes	---
<input type="checkbox"/>	12	Disable	Disable	Auto	MAC Based	Yes	---
<input type="checkbox"/>	13	Disable	Disable	Auto	MAC Based	Yes	---
<input type="checkbox"/>	14	Disable	Disable	Auto	MAC Based	Yes	---
<input type="checkbox"/>	15	Disable	Disable	Auto	MAC Based	Yes	---
<input type="checkbox"/>	16	Disable	Disable	Auto	MAC Based	Yes	---

Note:

802.1X can not be enabled for LAG member.

Figure 11-5 Port Config

The following entries are displayed on this screen:

➤ **Port Config**

Port Select: Click the **Select** button to quick-select the corresponding port based on the port number you entered.

Select: Select your desired port for configuration. It is multi-optional.

Port: Displays the port number.

- Status:** Select Enable/Disable the 802.1X authentication feature for the port.
- Guest VLAN:** Select Enable/Disable the Guest VLAN feature for the port.
- Control Mode:** Specify the Control Mode for the port.
- **Auto:** In this mode, the port will normally work only after passing the 802.1X Authentication.
 - **Force-Authorized:** In this mode, the port can work normally without passing the 802.1X Authentication.
 - **Force-Unauthorized:** In this mode, the port is forbidden working for its fixed unauthorized status.
- Control Type:** Specify the Control Type for the port.
- **MAC Based:** Any client connected to the port should pass the 802.1X Authentication for access.
 - **Port Based:** All the clients connected to the port can access the network on the condition that any one of the clients has passed the 802.1X Authentication.
- Authorized:** Displays the authentication status of the port.
- LAG:** Displays the LAG to which the port belongs to.

11.1.3 Radius Server

RADIUS (Remote Authentication Dial-In User Service) server provides the authentication service for the switch via the stored client information, such as the user name, password, etc, with the purpose to control the authentication and accounting status of the clients. On this page, you can configure the parameters of the authentication server.

Choose the menu **Network Security**→**802.1X**→**Radius Server** to load the following page.

Authentication Config

Primary IP:	<input type="text" value="0.0.0.0"/>	(Format: 192.168.0.1)	
Secondary IP:	<input type="text" value="0.0.0.0"/>	(Format: 192.168.0.1)	
Auth Port:	<input type="text" value="1812"/>	(1-65535)	<input type="button" value="Apply"/>
<input type="checkbox"/> Key Modify			
Auth Key:	<input type="text"/>		

Accounting Config

Accounting:	<input checked="" type="radio"/> Enable <input type="radio"/> Disable		
Primary IP:	<input type="text" value="0.0.0.0"/>	(Format: 192.168.0.1)	
Secondary IP:	<input type="text" value="0.0.0.0"/>	(Format: 192.168.0.1)	<input type="button" value="Apply"/>
Accounting Port:	<input type="text" value="1813"/>	(1-65535)	<input type="button" value="Help"/>
<input type="checkbox"/> Key Modify			
Accounting Key:	<input type="text"/>		

Figure 11-6 Radius Server

The following entries are displayed on this screen:

➤ **Authentication Config**

- Primary IP:** Enter the IP address of the authentication server.
- Secondary IP:** Enter the IP address of the alternate authentication server.
- Auth Port:** Set the UDP port of authentication server(s). The default port is 1812
- Key Modify:** Select to modify the authentication key.
- Auth Key:** Set the shared password for the switch and the authentication servers to exchange messages.

➤ **Accounting Config**

- Accounting:** Enable/Disable the accounting feature.
- Primary IP:** Enter the IP address of the accounting server.
- Secondary IP:** Enter the IP address of the alternate accounting server.
- Accounting Port:** Set the UDP port of accounting server(s). The default port is 1813.
- Key Modify:** Select to modify the accounting key.
- Accounting Key:** Set the shared password for the switch and the accounting servers to exchange messages.



Note:

1. The 802.1X function takes effect only when it is enabled globally on the switch and for the port.
2. The 802.1X function cannot be enabled for LAG member ports. That is, the port with 802.1X function enabled cannot be added to the LAG.
3. The 802.1X function should not be enabled for the port connected to the authentication server. In addition, the authentication parameters of the switch and the authentication server should be the same.

Configuration Procedure:

Step	Operation	Description
1	Connect an authentication server to the switch and do some configuration.	Required. Record the information of the client in the LAN to the authentication server and configure the corresponding authentication username and password for the client.
2	Install the 802.1X client software.	Required. For the client computers, you are required to install the 802.1X software TpSupplicant provided on the CD. For the installation guide, please refer to Appendix C: 802.1X Client Software .
3	Configure the 802.1X globally.	Required. By default, the global 802.1X function is disabled. On the Network Security → 802.1X → Global Config page, configure the 802.1X function globally.
4	Configure the parameters of the authentication server	Required. On the Network Security → 802.1X → Radius Server page, configure the parameters of the server.

Step	Operation	Description
5	Configure the 802.1X for the port.	Required. On the Network Security→802.1X→Port Config page, configure the 802.1X feature for the port of the switch based on the actual network.

[Return to CONTENTS](#)

Chapter 12 PoE



Note:

Only TL-SG2424P supports PoE function.

PoE (Power over Ethernet) technology describes a system to transmit electrical power along with data to remote devices over standard twisted-pair cable in an Ethernet network. It is especially useful for supplying power to IP telephones, wireless LAN access points, cameras and so on.

➤ Composition

A PoE system usually consists of PSE and PD.

PSE: Power sourcing equipment (PSE) is a device such as a switch that provides power on the Ethernet cable to the linked device.

PD: A powered device (PD) is a device accepting power from the PSE and thus consumes energy. PDs falls into two types, standard PDs and nonstandard PDs. Standard PDs refer to the powered devices that comply with IEEE 802.3af and IEEE 802.3at. Examples include wireless LAN access points, IP Phones, IP cameras, network hubs, embedded computers etc.

➤ Advantage

- Cheap cabling: The remote device such as cameras can be powered by PSE in no need of prolonging its power cord additionally and Ethernet cable is much cheaper than AC wire or power cord.
- Easy to connect: PoE uses only one Ethernet cable with no need of external power supply.
- Reliable: A powered device can be either powered by PSE using Ethernet cable or powered through the provided power adapter. It is very convenient to provide a backup power supply for the PDs.
- Flexibility: In compliance with IEEE 802.3af and IEEE 802.3at, global organizations can deploy PoE everywhere without concern for any local variance in AC power standards, outlets, plugs, or reliability.
- Wide use: It can be applied to wireless LAN access points, IP Phones, IP cameras, network hubs, embedded computers etc.

TL-SG2424P is a Power Sourcing Equipment (PSE). All the Auto-Negotiation RJ45 ports on the switch support Power over Ethernet (PoE) function, which can automatically detect and supply power for those powered devices (PDs) complying with IEEE 802.3af and IEEE 802.3at. The maximum power TL-SG2424P can supply is 180W and the maximum power each PoE port can supply is 30W.

PoE function can be configured in the two sections, **PoE Config** and **PoE Time-Range**.

12.1 PoE Config

All the RJ45 ports on the switch can be configured to supply power for the powered devices that comply with IEEE 802.3af and IEEE 802.3at. As the power every port or the system can provide is limited, some attributes should be set to make full use of the power and guarantee the adequate power to the linked PDs. When the power exceeds the maximum power limit or the power is inadequate to power the device, the switch may disconnect the power supply to the PD linked to the port with lower priority. When detecting a PD is unplugged, the switch will stop supplying the power to the PD.

PoE Config, mainly for PoE attributes configuration, is implemented on **PoE Config** and **PoE Profile** pages.

12.1.1 PoE Config

On this page, you can configure the parameters to implement PoE function.

Choose the menu **PoE**→**PoE Config**→**PoE Config** to load the following page.

Global Config

System Power Limit: w(1-180)

System Power Consumption: 0.0w

System Power Remain: 180.0w

Port Config

Port

Select	Port	PoE Status	PoE Priority	Power Limit (0.1w-30.0w)	Time Range	PoE Profile	Power(w)	Current(mA)	Voltage(V)	PD Class	Power Status
<input type="checkbox"/>		<input type="text"/>	<input type="text"/>	<input type="text"/>	<input type="text"/>	<input type="text"/>					
<input type="checkbox"/>	1	Enable	Low	Class 4	No Limit	---	---	---	---	---	OFF
<input type="checkbox"/>	2	Enable	Low	Class 4	No Limit	---	---	---	---	---	OFF
<input type="checkbox"/>	3	Enable	Low	Class 4	No Limit	---	---	---	---	---	OFF
<input type="checkbox"/>	4	Enable	Low	Class 4	No Limit	---	---	---	---	---	OFF
<input type="checkbox"/>	5	Enable	Low	Class 4	No Limit	---	---	---	---	---	OFF
<input type="checkbox"/>	6	Enable	Low	Class 4	No Limit	---	---	---	---	---	OFF
<input type="checkbox"/>	7	Enable	Low	Class 4	No Limit	---	---	---	---	---	OFF
<input type="checkbox"/>	8	Enable	Low	Class 4	No Limit	---	---	---	---	---	OFF
<input type="checkbox"/>	9	Enable	Low	Class 4	No Limit	---	---	---	---	---	OFF
<input type="checkbox"/>	10	Enable	Low	Class 4	No Limit	---	---	---	---	---	OFF
<input type="checkbox"/>	11	Enable	Low	Class 4	No Limit	---	---	---	---	---	OFF
<input type="checkbox"/>	12	Enable	Low	Class 4	No Limit	---	---	---	---	---	OFF
<input type="checkbox"/>	13	Enable	Low	Class 4	No Limit	---	---	---	---	---	OFF
<input type="checkbox"/>	14	Enable	Low	Class 4	No Limit	---	---	---	---	---	OFF
<input type="checkbox"/>	15	Enable	Low	Class 4	No Limit	---	---	---	---	---	OFF

Figure 12-1 PoE Config for TL-SG2424P

The following items are displayed on this screen:

➤ **Global Config**

- System Power Limit:** Specify the max power the PoE switch can supply.
- System Power Consumption:** Displays the PoE switch's real time system power consumption.
- System Power Remain:** Displays the PoE switch's real time remaining system power.

➤ **Port Config**

- Port Select:** Click the **Select** button to quick-select the corresponding entry based on the port number you entered.
- Select:** Select the desired port to configure its parameters.
- Port:** Displays the port number.
- PoE Status:** Select to disable/enable the PoE feature for the corresponding port. If set enable, the corresponding port can supply power to the linked PD (Powered Device).

- PoE Priority:** The priority levels include High, Middle and Low in descending order. When the supply power exceeds the system power limit, the PD linked to the port with lower priority will be disconnected.
- Power Limit (0.1w-30w):** Defines the max power the corresponding port can supply. Class1 represents 4w, Class2 represents 7w, Class3 represents 15.4w and Class4 represents 30w.
- Time Range:** Select the time range for the PoE port to supply power. If **No limit** is selected, the PoE port will supply power all the time.
- PoE Profile:** Select the profile you want to apply to the selected port. If a PoE Profile is selected, the three attributes including PoE Status, PoE Priority and Power Limit are not available.
- Power (W):** Displays the port's real time power supply.
- Current (mA):** Displays the port's real time current.
- Voltage (V):** Displays the port's real time voltage.
- PD Class:** Displays the class the linked PD (Powered Device) belongs to.
- Power Status:** Displays the port's real time power status.

12.1.2 PoE Profile

PoE (Power over Ethernet) Profile is a short cut for the configuration of the PoE port. You can create some profiles to be applied to the ports. In a profile, the PoE status, PoE priority and Power limit are configured.

Choose the menu **PoE**→**PoE Config**→**Profile Profile** to load the following page.

The screenshot shows a web-based configuration interface for PoE profiles. It is divided into two main sections. The top section, titled "Create PoE Profile", contains the following elements: a text input field for "Profile Name"; "PoE Status" with "Enable" selected (indicated by a green dot) and "Disable" as an option; "PoE Priority" set to "High" via a dropdown menu; "Power Limit" set to "Auto" via a dropdown menu; and a "Create" button. The bottom section, titled "PoE Profile", displays a table with the following columns: "Select", "Profile Name", "PoE Status", "PoE Priority", and "Power Limit (w)". Below the table are three buttons: "All", "Delete", and "Help".

Figure 12-2 Profile Config

The following items are displayed on this screen:

➤ Create PoE Profile

- Profile Name:** Enter the name of the profile.
- PoE Status:** Select to the enable/disable PoE feature for the corresponding port. If set enable, the port may supply power to the linked PD (Power Device).

PoE Priority: The priority levels include High, Middle and Low in descending order. When the supply power exceeds the system power limit, the PD linked to the port with lower priority will be disconnected.

Power Limit: Defines the max power the corresponding port can supply. Class1 represents 4w, Class2 represents 7w and Class3 represents 15.4w. (for)

Defines the max power the corresponding port can supply. Class1 represents 4w, Class2 represents 7w, Class3 represents 15.4w, and Class4 represents 30w. (for TL-SG2424P)

➤ **PoE Profile**

Select: Select the desired profile to delete.

Profile Name: Displays the name of the profile.

PoE Status: Displays the PoE status of the port in the profile.

PoE Priority: Displays the PoE priority of the port in the profile.

Power Limit: Displays the max power the port in the profile can supply.

12.2 PoE Time-Range

A time-range based PoE enables you to implement PoE power supply by differentiating the time-ranges. A time-range can be specified for each port. The port will not supply power when the specified time-range is configured and the system time is not within the time-range.

On this switch absolute time, week time and holiday can be configured. Configure an absolute time section in the form of “the start date to the end date” to make the port based on this time range supply power; configure a week time section to make the port supply based on this time range on the fixed days of the week; configure a holiday section and select **Exclude Holiday** to make the port based on this time range not supply power on some special days. In each time-range, four time-slices can be configured.

The Time-Range configuration can be implemented on **PoE Time-Range Summary**, **PoE Time-Range Create** and **PoE Holiday Config** pages.

12.2.1 Time-Range Summary

On this page you can view or delete the current time-ranges.

Choose the menu **PoE→PoE Time-Range→PoE Time-Range Summary** to load the following page.

Select	Index	Time-Range Name	Slice 1	Slice 2	Slice 3	Slice 4	Mode	Operation
<input type="checkbox"/>	1	11	---	---	---	---	Exclude Holiday	Edit Detail

Figure 12-3 Time-Range Table

The following items are displayed on this screen:

➤ **Time-Range Table**

Select: Select the desired entry to delete the corresponding time-range.

- Index:** Displays the index of the time-range.
- Time-Range Name:** Displays the name of the time-range.
- Slice:** Displays the time-slice of the time-range.
- Mode:** Displays the mode the time-range adopts.
- Operation:** Click **Edit** to modify this time-range and click **Detail** to display the complete information of this time-range.

12.2.2 PoE Time-Range Create

On this page you can create time-ranges.

Choose the menu **PoE**→**PoE Time-Range**→**PoE Time-Range Create** to load the following page.

Figure 12-4 Time-Range Create



Note:

To successfully configure time-ranges, please firstly specify time-slices and then time-ranges.

The following items are displayed on this screen:

➤ Create Time-Range

- Name:** Enter the name of the time-range for time identification.
- Exclude Holiday:** Select **Exclude Holiday**, and the port based on this time-range may not supply power when the system time is within the holiday
- Absolute:** Select Absolute to configure absolute time-range. The port based on this time-range will supply power based on this time-range when the system time is within the absolute time-range.
- Week:** Select Week to configure week time-range. The port based on this time-range will supply power based on this time-range when the system time is within the week time-range.

➤ Create Time-Slice

- Start Time:** Set the start time of the time-slice.
- End Time:** Set the end time of the time-slice.

➤ **Time-Slice Table**

- Index:** Displays the index of the time-slice.
- Start Time:** Displays the start time of the time-slice.
- End Time:** Displays the end time of the time-slice.
- Delete:** Click the **Delete** button to delete the corresponding time-slice.

12.2.3 PoE Holiday Config

Holiday mode is applied as a different secured access control policy from the week mode. On this page you can define holidays according to your work arrangement.

Choose the menu **PoE**→**PoE Time-Range**→**PoE Holiday Create** to load the following page.

Create Holiday

Start Date: 01 / 01

End Date: 01 / 01 Create

Holiday Name:

Holiday Table

Select	Index	Holiday Name	Start Date	End Date
<input type="checkbox"/>	1	NewYearDay	01/01	01/03
<input type="checkbox"/>	2	LaborDay	05/01	05/03

All Delete Help

Figure 12-5 Holiday Configuration

The following entries are displayed on this screen:

➤ **Create Holiday**

- Start Date:** Specify the start date of the holiday.
- End Date:** Specify the end date of the holiday.
- Holiday Name:** Enter the name of the holiday.

➤ **Holiday Table**

- Select:** Select the desired entry to delete the corresponding holiday.
- Index:** Displays the index of the holiday.
- Holiday Name:** Displays the name of the holiday.
- Start Date:** Displays the start date of the holiday.
- End Date:** Displays the end date of the holiday.

[Return to CONTENTS](#)

Chapter 13 SNMP

➤ SNMP Overview

SNMP (Simple Network Management Protocol) has gained the most extensive application on the UDP/IP networks. SNMP provides a management frame to monitor and maintain the network devices. It is used for automatically managing the various network devices no matter the physical differences of the devices. Currently, the most network management systems are based on SNMP.

SNMP is simply designed and convenient for use with no need of complex fulfillment procedures and too much network resources. With SNMP function enabled, network administrators can easily monitor the network performance, detect the malfunctions and configure the network devices. In the meantime, they can locate faults promptly and implement the fault diagnosis, capacity planning and report generating.

➤ SNMP Management Frame

SNMP management frame includes three network elements: SNMP Management Station, SNMP Agent and MIB (Management Information Base).

SNMP Management Station: SNMP Management Station is the workstation for running the SNMP client program, providing a friendly management interface for the administrator to manage the most network devices conveniently.

SNMP Agent: Agent is the server software operated on network devices with the responsibility of receiving and processing the request packets from SNMP Management Station. In the meanwhile, Agent will inform the SNMP Management Station of the events whenever the device status changes or the device encounters any abnormalities such as device reboot.

MIB: MIB is the set of the managed objects. MIB defines a few attributes of the managed objects, including the names, the access rights, and the data types. Every SNMP Agent has its own MIB. The SNMP Management station can read/write the MIB objects based on its management right.

SNMP Management Station is the manager of SNMP network while SNMP Agent is the managed object. The information between SNMP Management Station and SNMP Agent are exchanged through SNMP (Simple Network Management Protocol). The relationship among SNMP Management Station, SNMP Agent and MIB is illustrated in the following figure.

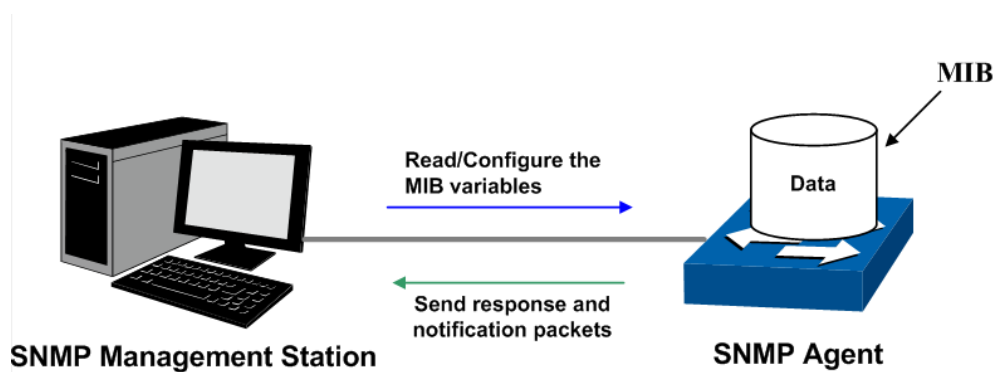

Figure 13-1 Relationship among SNMP Network Elements

➤ SNMP Versions

This switch supports SNMP v3, and is compatible with SNMP v1 and SNMP v2c. The SNMP versions adopted by SNMP Management Station and SNMP Agent should be the same. Otherwise, SNMP Management Station and SNMP Agent cannot communicate with each other

normally. You can select the management mode with proper security level according to your actual application requirement.

SNMP v1: SNMP v1 adopts Community Name authentication. The community name is used to define the relation between SNMP Management Station and SNMP Agent. The SNMP packets failing to pass community name authentication are discarded. The community name can limit access to SNMP Agent from SNMP NMS, functioning as a password.

SNMP v2c: SNMP v2c also adopts community name authentication. It is compatible with SNMP v1 while enlarges the function of SNMP v1.

SNMP v3: Based on SNMP v1 and SNMP v2c, SNMP v3 extremely enhances the security and manageability. It adopts VACM (View-based Access Control Model) and USM (User-Based Security Model) authentication. The user can configure the authentication and the encryption functions. The authentication function is to limit the access of the illegal user by authenticating the senders of packets. Meanwhile, the encryption function is used to encrypt the packets transmitted between SNMP Management Station and SNMP Agent so as to prevent any information being stolen. The multiple combinations of authentication function and encryption function can guarantee a more reliable communication between SNMP Management station and SNMP Agent.

➤ MIB Introduction

To uniquely identify the management objects of the device in SNMP messages, SNMP adopts the hierarchical architecture to identify the managed objects. It is like a tree, and each tree node represents a managed object, as shown in the following figure. Thus the object can be identified with the unique path starting from the root and indicated by a string of numbers. The number string is the Object Identifier of the managed object. In the following figure, the OID of the managed object B is {1.2.1.1}. While the OID of the managed object A is {1.2.1.1.5}.

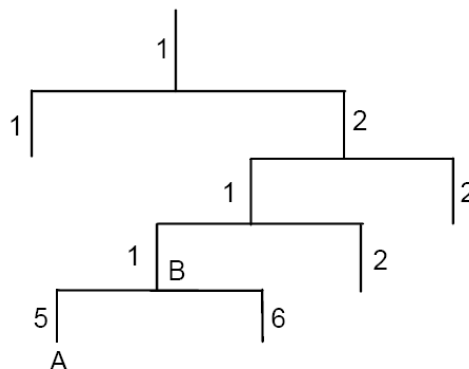

Figure 13-2 Architecture of the MIB tree

➤ SNMP Configuration Outline

1. Create View

The SNMP View is created for the SNMP Management Station to manage MIB objects. The managed object, uniquely identified by OID, can be set to under or out of the management of SNMP Management Station by configuring its view type (included/excluded). The OID of managed object can be found on the SNMP client program running on the SNMP Management Station.

2. Create SNMP Group

After creating the SNMP View, it's required to create a SNMP Group. The Group Name, Security Model and Security Level compose the identifier of the SNMP Group. The Groups with these three items the same are considered to be the same. You can configure SNMP Group to control the network access by providing the users in various groups with different management rights via the Read View, Write View and Notify View.

3. Create SNMP User

The User configured in a SNMP Group can manage the switch via the client program on management station. The specified User Name and the Auth/Privacy Password are used for SNMP Management Station to access the SNMP Agent, functioning as the password.

SNMP module is used to configure the SNMP function of the switch, including three submenus: **SNMP Config**, **Notification** and **RMON**.

13.1 SNMP Config

The **SNMP Config** can be implemented on the **Global Config**, **SNMP View**, **SNMP Group**, **SNMP User** and **SNMP Community** pages.

13.1.1 Global Config

To enable SNMP function, please configure the SNMP function globally on this page.

Choose the menu **SNMP**→**SNMP Config**→**Global Config** to load the following page.

Global Config

SNMP: Enable Disable

Local Engine

Local Engine ID: (10-64 Hex)

Remote Engine

Remote Engine ID: (0 or 10-64 Hex)

Note:

The total hexadecimal characters of Engine ID should be even.

Figure 13-3 Global Config

The following entries are displayed on this screen:

➤ **Global Config**

SNMP: Enable/Disable the SNMP function.

➤ **Local Engine**

Local Engine ID: Specify the switch's Engine ID for the remote clients. The Engine ID is a unique alphanumeric string used to identify the SNMP engine on the switch.

➤ **Remote Engine**

Remote Engine ID: Specify the Remote Engine ID for switch. The Engine ID is a unique alphanumeric string used to identify the SNMP engine on the remote device which receives traps and informs from switch.



Note:

The amount of Engine ID characters must be even.

13.1.2 SNMP View

The OID (Object Identifier) of the SNMP packets is used to describe the managed objects of the switch, and the MIB (Management Information Base) is the set of the OIDs. The SNMP View is created for the SNMP management station to manage MIB objects.

Choose the menu **SNMP**→**SNMP Config**→**SNMP View** to load the following page.

View Config

View Name: (16 characters maximum)

MIB Object ID: (61 characters maximum)

View Type: Include Exclude

View Table

Select	View Name	View Type	MIB Object ID
<input type="checkbox"/>	viewDefault	Include	1
<input type="checkbox"/>	viewDefault	Exclude	1.3.6.1.6.3.15
<input type="checkbox"/>	viewDefault	Exclude	1.3.6.1.6.3.16
<input type="checkbox"/>	viewDefault	Exclude	1.3.6.1.6.3.18

Figure 13-4 SNMP View

The following entries are displayed on this screen:

➤ View Config

View Name: Give a name to the View for identification. Each View can include several entries with the same name.

MIB Object ID: Enter the Object Identifier (OID) for the entry of View.

View Type: Select the type for the view entry.

- Include: The view entry can be managed by the SNMP management station.
- Exclude: The view entry cannot be managed by the SNMP management station.

➤ View Table

Select: Select the desired entry to delete the corresponding view. All the entries of a View will be deleted together.

View Name: Displays the name of the View entry.

View Type: Displays the type of the View entry.

MIB Object ID: Displays the OID of the View entry.

13.1.3 SNMP Group

On this page, you can configure SNMP Group to control the network access by providing the users in various groups with different management rights via the Read View, Write View and Notify View.

Choose the menu **SNMP**→**SNMP Config**→**SNMP Group** to load the following page.

Group Config

Group Name: (16 characters maximum)

Security Model:

Security Level:

Read View:

Write View:

Notify View:

Group Table

Select	Group Name	Security Model	Security Level	Read View	Write View	Notify View	Operation
--------	------------	----------------	----------------	-----------	------------	-------------	-----------

Note:

A group should contain a read view, and the default read view is viewDefault.

Figure 13-5 SNMP Group

The following entries are displayed on this screen:

➤ **Group Config**

Group Name:

Enter the SNMP Group name. The Group Name, Security Model and Security Level compose the identifier of the SNMP Group. The Groups with these three items the same are considered to be the same.

Security Model:

Select the Security Model for the SNMP Group.

- v1: SNMPv1 is defined for the group. In this model, the Community Name is used for authentication. SNMP v1 can be configured on the SNMP Community page directly.
- v2c: SNMPv2c is defined for the group. In this model, the Community Name is used for authentication. SNMP v2c can be configured on the SNMP Community page directly.
- v3: SNMPv3 is defined for the group. In this model, the USM mechanism is used for authentication. If SNMPv3 is enabled, the Security Level field is enabled for configuration.

Security Level:

Select the Security Level for the SNMP v3 Group.

- noAuthNoPriv: No authentication and no privacy security level is used.
- authNoPriv: Only the authentication security level is used.
- authPriv: Both the authentication and the privacy security levels are used.

Read View:

Select the View to be the Read View. The management access is restricted to read-only, and changes cannot be made to the assigned SNMP View.

Write View: Select the View to be the Write View. The management access is writing only and changes can be made to the assigned SNMP View. The View defined both as the Read View and the Write View can be read and modified.

Notify View: Select the View to be the Notify View. The management station can receive trap messages of the assigned SNMP view generated by the switch's SNMP agent.

➤ **Group Table**

Select: Select the desired entry to delete the corresponding group. It is multi-optional.

Group Name: Displays the Group Name here.

Security Model: Displays the Security Model of the group.

Security Level: Displays the Security Level of the group.

Read View: Displays the Read View name in the entry.

Write View: Displays the Write View name in the entry.

Notify View: Displays the Notify View name in the entry.

Operation: Click the **Edit** button to modify the Views in the entry and click the **Modify** button to apply.



Note:

Every Group should contain a Read View. The default Read View is viewDefault.

13.1.4 SNMP User

The User in a SNMP Group can manage the switch via the management station software. The User and its Group have the same security level and access right. You can configure the SNMP User on this page.

Choose the menu **SNMP**→**SNMP Config**→**SNMP User** to load the following page.

User Config

User Name:	<input type="text"/>	(16 characters maximum)		
User Type:	<input type="text" value="Local User"/>		Group Name:	<input type="text"/>
Security Model:	<input type="text" value="v1"/>		Security Level:	<input type="text" value="noAuthNoPriv"/>
Auth Mode:	<input type="text" value="None"/>		Auth Password:	<input type="text"/>
Privacy Mode:	<input type="text" value="None"/>		Privacy Password:	<input type="text"/>
				(16 characters maximum)

User Table

Select	User Name	User Type	Group Name	Security Model	Security Level	Auth Mode	Privacy Mode	Operation
<input type="button" value="All"/> <input type="button" value="Delete"/> <input type="button" value="Help"/>								

Note:

The security model and security level of the user should be the same with that of its group.

Figure 13-6 SNMP User

The following entries are displayed on this screen:

➤ **User Config**

- User Name:** Enter the User Name here.
- User Type:** Select the type for the User.
- Local User: Indicates that the user is connected to a local SNMP engine.
 - Remote User: Indicates that the user is connected to a remote SNMP engine.
- Group Name:** Select the Group Name of the User. The User is classified to the corresponding Group according to its Group Name, Security Model and Security Level.
- Security Model:** Select the Security Model for the User.
- Security Level:** Select the Security Level for the SNMP v3 User.
- Auth Mode:** Select the Authentication Mode for the SNMP v3 User.
- None: No authentication method is used.
 - MD5: The port authentication is performed via HMAC-MD5 algorithm.
 - SHA: The port authentication is performed via SHA (Secure Hash Algorithm). This authentication mode has a higher security than MD5 mode.
- Auth Password:** Enter the password for authentication.
- Privacy Mode:** Select the Privacy Mode for the SNMP v3 User.
- None: No privacy method is used.
 - DES: DES encryption method is used.
- Privacy Password:** Enter the Privacy Password.

➤ **User Table**

- Select:** Select the desired entry to delete the corresponding User. It is multi-optional.
- User Name:** Displays the name of the User.
- User Type:** Displays the User Type.
- Group Name:** Displays the Group Name of the User.
- Security Model:** Displays the Security Model of the User.
- Security Level:** Displays the Security Level of the User.
- Auth Mode:** Displays the Authentication Mode of the User.
- Privacy Mode:** Displays the Privacy Mode of the User.
- Operation:** Click the **Edit** button to modify the Group of the User and click the **Modify** button to apply.



Note:

The SNMP User and its Group should have the same Security Model and Security Level.

13.1.5 SNMP Community

SNMP v1 and SNMP v2c adopt community name authentication. The community name can limit access to the SNMP agent from SNMP network management station, functioning as a password. If SNMP v1 or SNMP v2c is employed, you can directly configure the SNMP Community on this page without configuring SNMP Group and User.

Choose the menu **SNMP**→**SNMP Config**→**SNMP Community** to load the following page.

Community Config

Community Name: (16 characters maximum)

Access:

MIB View:

Community Table

Select	Community Name	Access	MIB View	Operation
<input type="button" value="All"/> <input type="button" value="Delete"/> <input type="button" value="Help"/>				

Note:

The default MIB view of community is viewDefault.

Figure 13-7 SNMP Community

The following entries are displayed on this screen:

➤ **Community Config**

- Community Name:** Enter the Community Name here.
- Access:** Defines the access rights of the community.
- **read-only:** Management right of the Community is restricted to read-only, and changes cannot be made to the corresponding View.
 - **read-write:** Management right of the Community is read-write and changes can be made to the corresponding View.
- MIB View:** Select the MIB View for the community to access.

➤ **Community Table**

- Select:** Select the desired entry to delete the corresponding Community. It is multi-optional.
- Community Name:** Displays the Community Name here.
- Access:** Displays the right of the Community to access the View.
- MIB View:** Displays the Views which the Community can access.
- Operation:** Click the **Edit** button to modify the MIB View and the Access right of the Community, and then click the **Modify** button to apply.



Note:

The default MIB View of SNMP Community is viewDefault.

Configuration Procedure:

- If SNMPv3 is employed, please take the following steps:

Step	Operation	Description
1	Enable SNMP function globally.	Required. On the SNMP→SNMP Config→Global Config page, enable SNMP function globally.
2	Create SNMP View.	Required. On the SNMP→SNMP Config→SNMP View page, create SNMP View of the management agent. The default View Name is viewDefault and the default OID is 1.
3	Create SNMP Group.	Required. On the SNMP→SNMP Config→SNMP Group page, create SNMP Group for SNMPv3 and specify SNMP Views with various access levels for SNMP Group.
4	Create SNMP User.	Required. On the SNMP→SNMP Config→SNMP User page, create SNMP User in the Group and configure the auth/privacy mode and auth/privacy password for the User.

- If SNMPv1 or SNMPv2c is employed, please take the following steps:

Step	Operation	Description
1	Enable SNMP function globally.	Required. On the SNMP→SNMP Config→Global Config page, enable SNMP function globally.
2	Create SNMP View.	Required. On the SNMP→SNMP Config→SNMP View page, create SNMP View of the management agent. The default View Name is viewDefault and the default OID is 1.
3	Configure access level for the User.	<p>Required alternatively.</p> <ul style="list-style-type: none"> • Create SNMP Community directly. On the SNMP→SNMP Config→SNMP Community page, create SNMP Community based on SNMP v1 and SNMP v2c. • Create SNMP Group and SNMP User. Similar to the configuration way based on SNMPv3, you can create SNMP Group and SNMP User of SNMP v1/v2c. The User name can limit access to the SNMP agent from SNMP network management station, functioning as a community name. The users can manage the device via the Read View, Write View and Notify View defined in the SNMP Group.

13.2 Notification

With the Notification function enabled, the switch can initiatively report to the management station about the important events that occur on the Views (e.g., the managed device is rebooted), which allows the management station to monitor and process the events in time.

The notification information includes the following two types:

Trap: Trap is the information that the managed device initiatively sends to the Network management station without request.

Inform: Inform packet is sent to inform the management station and ask for the reply. The switch will resend the inform request if it doesn't get the response from the management station during the Timeout interval, and it will terminate resending the inform request if the resending times reach the specified Retry times. The Inform type, employed on SNMPv2c and SNMPv3, has a higher security than the Trap type.

On this page, you can configure the notification function of SNMP.

Choose the menu **SNMP**→**Notification**→**Notification** to load the following page.

Select	IP Address	IP Mode	UDP Port	User	Security Model	Security Level	Type	Timeout	Retry	Operation
--------	------------	---------	----------	------	----------------	----------------	------	---------	-------	-----------

Figure 13-8 Notification Config

The following entries are displayed on this screen:

➤ Create Notification

- IP Mode:** Select the IP Mode.
- IP Address:** Enter the IP Address of the management Host.
- UDP Port:** Enter the number of the UDP port used to send notifications. The UDP port functions with the IP address for the notification sending. The default is 162.
- User:** Enter the User name of the management station.
- Security Model:** Select the Security Model of the management station.
- Security Level:** Select the Security Level for the SNMP v3 User.
- **noAuthNoPriv:** No authentication and no privacy security level are used.
 - **authNoPriv:** Only the authentication security level is used.
 - **authPriv:** Both the authentication and the privacy security levels are used.

Type:	Select the type for the notifications. <ul style="list-style-type: none"> • Trap: Indicates traps are sent. • Inform: Indicates informs are sent. The Inform type has a higher security than the Trap type.
Retry:	Specify the amount of times the switch resends an inform request. The switch will resend the inform request if it doesn't get the response from the management station during the Timeout interval, and it will terminate resending the inform request if the resending times reach the specified Retry times.
Timeout:	Specify the maximum time for the switch to wait for the response from the management station before resending a request.
➤ Notification Table	
Select:	Select the desired entry to delete the corresponding management station.
IP Address:	Displays the IP Address of the management host.
UDP Port:	Displays the UDP port used to send notifications.
User:	Displays the User name of the management station.
Security Model:	Displays the Security Model of the management station.
Security Level:	Displays the Security Level for the SNMP v3 User.
Type:	Displays the type of the notifications.
Timeout:	Displays the maximum time for the switch to wait for the response from the management station before resending a request.
Retry:	Displays the amount of times the switch resends an inform request.
Operation:	Click the Edit button to modify the corresponding entry and click the Modify button to apply.

13.3 RMON

RMON (Remote Monitoring) based on SNMP (Simple Network Management Protocol) architecture, functions to monitor the network. RMON is currently a commonly used network management standard defined by Internet Engineering Task Force (IETF), which is mainly used to monitor the data traffic across a network segment or even the entire network so as to enable the network administrator to take the protection measures in time to avoid any network malfunction. In addition, RMON MIB records network statistics information of network performance and malfunction periodically, based on which the management station can monitor network at any time effectively. RMON is helpful for network administrator to manage the large-scale network since it reduces the communication traffic between management station and managed agent.

➤ RMON Group

This switch supports the following four RMON Groups defined on the RMON standard (RFC1757): History Group, Event Group, Statistic Group and Alarm Group.

RMON Group	Function
History Group	After a history group is configured, the switch collects and records network statistics information periodically, based on which the management station can monitor network effectively.
Event Group	Event Group is used to define RMON events. Alarms occur when an event is detected.
Statistic Group	Statistic Group is set to monitor the statistic of alarm variables on the specific ports.
Alarm Group	Alarm Group is configured to monitor the specific alarm variables. When the value of a monitored variable exceeds the threshold, an alarm event is generated, which triggers the switch to act in the set way.

The **RMON** Groups can be configured on the **History Control**, **Event Config** and **Alarm Config** pages.

13.3.1 History Control

On this page, you can configure the History Group for RMON.

Choose the menu **SNMP**→**RMON**→**History Control** to load the following page.

History Control Table					
Select	Index	Port	Interval (sec)	Owner	Status
<input type="checkbox"/>		Port 1			Disable
<input type="checkbox"/>	1	Port 1	1800	monitor	Disable
<input type="checkbox"/>	2	Port 2	1800	monitor	Disable
<input type="checkbox"/>	3	Port 3	1800	monitor	Disable
<input type="checkbox"/>	4	Port 4	1800	monitor	Disable
<input type="checkbox"/>	5	Port 5	1800	monitor	Disable
<input type="checkbox"/>	6	Port 6	1800	monitor	Disable
<input type="checkbox"/>	7	Port 7	1800	monitor	Disable
<input type="checkbox"/>	8	Port 8	1800	monitor	Disable
<input type="checkbox"/>	9	Port 9	1800	monitor	Disable
<input type="checkbox"/>	10	Port 10	1800	monitor	Disable
<input type="checkbox"/>	11	Port 11	1800	monitor	Disable
<input type="checkbox"/>	12	Port 12	1800	monitor	Disable

Figure 13-9 History Control

The following entries are displayed on this screen:

➤ **History Control Table**

- Select:** Select the desired entry for configuration.
- Index:** Displays the index number of the entry.
- Port:** Specify the port from which the history samples were taken.
- Interval:** Specify the interval to take samplings from the port.
- Owner:** Enter the name of the device or user that defined the entry.
- Status:** Select Enable/Disable the corresponding sampling entry.

13.3.2 Event Config

On this page, you can configure the RMON events.

Choose the menu **SNMP**→**RMON**→**Event Config** to load the following page.

Event Table						
Select	Index	User	Description	Type	Owner	Status
<input type="checkbox"/>		<input type="text"/>	<input type="text"/>	None <input type="button" value="v"/>	<input type="text"/>	Disable <input type="button" value="v"/>
<input type="checkbox"/>	1	public		None	monitor	Disable
<input type="checkbox"/>	2	public		None	monitor	Disable
<input type="checkbox"/>	3	public		None	monitor	Disable
<input type="checkbox"/>	4	public		None	monitor	Disable
<input type="checkbox"/>	5	public		None	monitor	Disable
<input type="checkbox"/>	6	public		None	monitor	Disable
<input type="checkbox"/>	7	public		None	monitor	Disable
<input type="checkbox"/>	8	public		None	monitor	Disable
<input type="checkbox"/>	9	public		None	monitor	Disable
<input type="checkbox"/>	10	public		None	monitor	Disable
<input type="checkbox"/>	11	public		None	monitor	Disable
<input type="checkbox"/>	12	public		None	monitor	Disable

Figure 13-10 Event Config

The following entries are displayed on this screen:

➤ **Event Table**

- Select:** Select the desired entry for configuration.
- Index:** Displays the index number of the entry.
- User:** Enter the name of the User or the community to which the event belongs.
- Description:** Give a description to the event for identification.
- Type:** Select the event type, which determines the act way of the network device in response to an event.
- None: No processing.
 - Log: Logging the event.
 - Notify: Sending trap messages to the management station.
 - Log&Notify: Logging the event and sending trap messages to the management station.
- Owner:** Enter the name of the device or user that defined the entry.
- Status:** Select Enable/Disable the corresponding event entry.

13.3.3 Alarm Config

On this page, you can configure Statistic Group and Alarm Group for RMON.

Choose the menu **SNMP**→**RMON**→**Alarm Config** to load the following page.

Alarm Table												
Select	Index	Variable	Port	Sample Type	Rising Threshold	Rising Event	Falling Threshold	Falling Event	Alarm Type	Interval (sec)	Owner	Status
<input type="checkbox"/>		DropEvents	Port 1	Absolute					All			Disable
<input type="checkbox"/>	1	DropEvents	Port 1	Absolute	100	1	100	1	All	1800	monitor	Disable
<input type="checkbox"/>	2	DropEvents	Port 1	Absolute	100	1	100	1	All	1800	monitor	Disable
<input type="checkbox"/>	3	DropEvents	Port 1	Absolute	100	1	100	1	All	1800	monitor	Disable
<input type="checkbox"/>	4	DropEvents	Port 1	Absolute	100	1	100	1	All	1800	monitor	Disable
<input type="checkbox"/>	5	DropEvents	Port 1	Absolute	100	1	100	1	All	1800	monitor	Disable
<input type="checkbox"/>	6	DropEvents	Port 1	Absolute	100	1	100	1	All	1800	monitor	Disable
<input type="checkbox"/>	7	DropEvents	Port 1	Absolute	100	1	100	1	All	1800	monitor	Disable
<input type="checkbox"/>	8	DropEvents	Port 1	Absolute	100	1	100	1	All	1800	monitor	Disable
<input type="checkbox"/>	9	DropEvents	Port 1	Absolute	100	1	100	1	All	1800	monitor	Disable
<input type="checkbox"/>	10	DropEvents	Port 1	Absolute	100	1	100	1	All	1800	monitor	Disable
<input type="checkbox"/>	11	DropEvents	Port 1	Absolute	100	1	100	1	All	1800	monitor	Disable
<input type="checkbox"/>	12	DropEvents	Port 1	Absolute	100	1	100	1	All	1800	monitor	Disable

Figure 13-11 Alarm Config

The following entries are displayed on this screen:

➤ **Alarm Table**

- Select:** Select the desired entry for configuration.
- Index:** Displays the index number of the entry.
- Variable:** Select the alarm variables from the pull-down list.
- Port:** Select the port on which the Alarm entry acts.
- Sample Type:** Specify the sampling method for the selected variable and comparing the value against the thresholds.
- **Absolute:** Compares the values directly with the thresholds at the end of the sampling interval.
 - **Delta:** Subtracts the last sampled value from the current value. The difference in the values is compared to the threshold.
- Rising Threshold:** Enter the rising counter value that triggers the Rising Threshold alarm.
- Rising Event:** Select the index of the corresponding event which will be triggered if the sampled value is larger than the Rising Threshold.
- Falling Threshold:** Enter the falling counter value that triggers the Falling Threshold alarm.
- Falling Event:** Select the index of the corresponding event which will be triggered if the sampled value is lower than the Falling Threshold.

Alarm Type:

Specify the type of the alarm.

- **All:** The alarm event will be triggered either the sampled value exceeds the Rising Threshold or is under the Falling Threshold.
- **Rising:** When the sampled value exceeds the Rising Threshold, an alarm event is triggered.
- **Falling:** When the sampled value is under the Falling Threshold, an alarm event is triggered.

Interval:

Enter the alarm interval time in seconds.

Owner:

Enter the name of the device or user that defined the entry.

Status:

Select Enable/Disable the corresponding alarm entry.

**Note:**

When alarm variables exceed the Threshold on the same direction continuously for several times, an alarm event will only be generated on the first time, that is, the Rising Alarm and Falling Alarm are triggered alternately for that the alarm following to Rising Alarm is certainly a Falling Alarm and vice versa.

[Return to CONTENTS](#)

Chapter 14 LLDP



Note:

Only TL-SG2424P supports LLDP function.

LLDP (Link Layer Discovery Protocol) is a Layer 2 protocol that is used for network devices to advertise their own device information periodically to neighbors on the same IEEE 802 local area network. The advertised information, including details such as device identification, capabilities and configuration settings, is represented in TLV (Type/Length/Value) format according to the IEEE 802.1ab standard, and these TLVs are encapsulated in LLDPDU (Link Layer Discovery Protocol Data Unit). The LLDPDU distributed via LLDP is stored by its recipients in a standard MIB (Management Information Base), making it possible for the information to be accessed by a Network Management System (NMS) using a management protocol such as the Simple Network Management Protocol (SNMP).

An IETF Standard MIB, as well as a number of vendor specific MIBs, have been created to describe a network's physical topology and associated systems within that topology. However, there is no standard protocol for populating these MIBs or communicating this information among stations on the IEEE 802 LAN. LLDP protocol specifies a set. The device running LLDP can automatically discover and learn about the neighbors, allowing for interoperability between the network devices of different vendors. This protocol allows two systems running different network layer protocols to learn about each other.

LLDP-MED (Link Layer Discovery Protocol for Media Endpoint Devices) is an extension of LLDP intended for managing endpoint devices such as Voice over IP phones and network switches. The LLDP-MED TLVs advertise information such as network policy, power via MDI, inventory management, and device location details.

The LLDP and LLDP-MED information can be used by SNMP applications to simplify troubleshooting, enhance network management, and maintain an accurate network topology.

➤ LLDPDU Format

Each LLDPDU includes an ordered sequence of three mandatory TLVs followed by one or more optional TLVs plus an End of LLDPDU TLV, as shown in the figure below. Chassis ID TLV, Port ID TLV, TTL TLV and End TLV are the four mandatory TLVs for a LLDPDU. Optional TLVs provide various details about the LLDP agent advertising them and they are selected by network management.

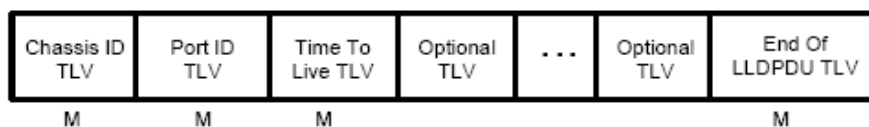

M - mandatory TLV - required for all LLDPDUs

The maximum length of the LLDPDU shall be the maximum information field length allowed by the particular transmission rate and protocol. In IEEE 802.3 MACs, for example, the maximum LLDPDU length is the maximum data field length for the basic, untagged MAC frame (1500 octets).

➤ LLDP Working Mechanism

1) LLDP Admin Status

The transmission and the reception of LLDPDUs can be separately enabled for every port, making it possible to configure an implementation to restrict the port either to transmit only or receive only,

or to allow the port to both transmit and receive LLDPDUs. Four LLDP admin statuses are supported by each port.

- Tx&Rx: the port can both transmit and receive LLDPDUs.
- Rx_Only: the port can receive LLDPDUs only.
- Tx_Only: the port can transmit LLDPDUs only.
- Disable: the port cannot transmit or receive LLDPDUs.

2) LLDPDU transmission mechanism

- If the ports are working in TxRx or Tx mode, they will advertise local information by sending LLDPDUs periodically.
- If there is a change in the local device, the change notification will be advertised. To prevent a series of successive LLDPDUs transmissions during a short period due to frequent changes in local device, a transmission delay timer is set by network management to ensure that there is a defined minimum time between successive LLDP frame transmissions.
- If the LLDP admin status of the port is changed from Disable/Rx to TxRx/Tx, the Fast Start Mechanism will be active, the transmit interval turns to be 1 second, several LLDPDUs will be sent out, and then the transmit interval comes back to the regular interval.

3) LLDPDU receipt mechanism

When a port is working in TxRx or Rx mode, the device will check the validity of the received LLDPDUs and the attached TLVs, save this neighbor information to the local device and then set the aging time of this information according to the TTL value of TTL (Time To Live) TLV. Once the TTL is 0, this neighbor information will be aged out immediately.

The aging time of the local information in the neighbor device is determined by TTL. Hold Multiplier is a multiplier on the Transmit Interval that determines the actual TTL value used in an LLDPDU. $TTL = Hold Multiplier * Transmit Interval$.

➤ TLV

TLV refers to Type/Length/Value and is contained in a LLDPDU. Type identifies what kind of information is being sent, Length indicates the length of information string in octets and Value is the actual information to be sent. The basic TLV Format is shown as follows:

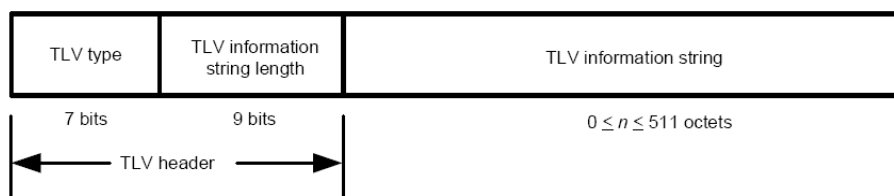

Each TLV is identified by a unique TLV type value that indicates the particular kind of information contained in the TLV.

The following table shows the details about the currently defined TLVs.

TLV type	TLV Name	Description	Usage in LLDPDU
0	End of LLDPDU	Mark the end of the TLV sequence in LLDPDUs. Any information following an End Of LLDPDU TLV shall be ignored.	Mandatory
1	Chassis ID	Identifies the Chassis address of the connected device.	Mandatory
2	Port ID	Identifies the specific port that transmitted the LLDP frame. When the device does not advertise MED TLV, this field displays the port name of the port; when the device advertises MED TLV, this field displays the MAC address of the port.	Mandatory
3	Time To Live	Indicates the number of seconds that the neighbor device is to regard the local information to be valid.	Mandatory
4	Port Description	Identifies the description string of the port.	Optional
5	System Name	Identifies the system name.	Optional
6	System Description	Identifies the system description.	Optional
7	System Capabilities	Identifies the main functions of the system and the functions enabled.	Optional
8	Management Address	Identifies the management IP address, the corresponding interface number and OID (Object Identifier). The management IP address is specified by the user.	Optional
127	Organizationally Specific	Allows different organizations, such as IEEE 802.1, IEEE 802.3, IETF, as well as individual software and equipment vendors, to define TLVs that advertise information to remote device.	Optional

Optional TLVs are grouped into two categories including basic management TLV and Organizationally-specific TLV.

1) Basic Management TLV

A set of TLVs considered to be basic to the management of the network stations are required for all LLDP implementations.

2) Organizationally Specific TLV

Different organizations have defined various TLVs. For instance, Port VLAN ID TLV, Port and Protocol VLAN ID TLV, VLAN Name TLV And Protocol Identity TLV are defined by IEEE 802.1, while MAC/PHY Configuration/Status TLV, Power Via MDI TLV, Link Aggregation TLV and Maximum Frame TLV are defined by IEEE 802.3. Some specific TLVs are for LLDP-MED protocol, such as LLDP-MED Capabilities TLV, Network Policy TLV, Extended Power-via-MDI TLV, Hardware Revision TLV and so on.

**Note:**

For detailed introduction of TLV, please refer to IEEE 802.1AB standard and ANSI/TIA-1057.

In TP-LINK switch, the following LLDP optional TLVs are supported.

TLV Type	Description
Port Description TLV	The Port Description TLV allows network management to advertise the IEEE 802 LAN station's port description.
System Capabilities TLV	The System Capabilities TLV identifies the primary functions of the system and whether or not these primary functions are enabled.
System Description TLV	The System Description TLV allows network management to advertise the system's description, which should include the full name and version identification of the system's hardware type, software operating system, and networking software.
System Name TLV	The System Name TLV allows network management to advertise the system's assigned name, which should be the system's fully qualified domain name.
Management Address TLV	The Management Address TLV identifies an address associated with the local LLDP agent that may be used to reach higher entities to assist discovery by network management.
Port VLAN ID TLV	The Port VLAN ID TLV allows a VLAN bridge port to advertise the port's VLAN identifier (PVID) that will be associated with untagged or priority tagged frames.
Port And Protocol VLAN ID TLV	The Port And Protocol VLAN ID TLV allows a bridge port to advertise a port and protocol VLAN ID.
VLAN Name TLV	The VLAN Name TLV allows an IEEE 802.1Q-compatible IEEE 802 LAN station to advertise the assigned name of any VLAN with which it is configured.
Link Aggregation TLV	The Link Aggregation TLV indicates whether the link is capable of being aggregated, whether the link is currently in an aggregation, and if in an aggregation, the port identification of the aggregation.
MAC/PHY Configuration/Status TLV	The MAC/PHY Configuration/Status TLV identifies: a)The duplex and bit-rate capability of the sending IEEE 802.3 LAN node that is connected to the physical medium; b)The current duplex and bit-rate settings of the sending IEEE 802.3 LAN node; c)Whether these settings are the result of auto-negotiation during link initiation or of manual set override action.
Max Frame Size TLV	The Maximum Frame Size TLV indicates the maximum frame size capability of the implemented MAC and PHY.
Power Via MDI TLV	The Power Via MDI TLV allows network management to advertise and discover the MDI power support capabilities of the sending IEEE 802.3 LAN station.

The LLDP module is mainly for LLDP function configuration of the switch, including three submenus: **Basic Config**, **Device Info**, **Device Statistics** and **LLDP-MED**.

14.1 Basic Config

LLDP is configured on the **Global Config** and **Port Config** pages.

14.1.1 Global Config

On this page you can configure the LLDP parameters of the device globally.

Choose the menu **LLDP**→**Basic Config**→**Global Config** to load the following page.

Global Config

LLDP: Enable Disable

Parameters Config

Transmit Interval: sec(5-32768)

Hold Multiplier: (2-10)

Transmit Delay: sec(1-8192)

Reinit Delay: sec(1-10)

Notification Interval: sec(5-3600)

Fast Start Times: (1-10)

Figure 14-1 LLDP Global Configuration

The following entries are displayed on this screen:

➤ **Global Config**

LLDP: Enable/disable LLDP function globally.

➤ **Parameters Config**

Transmit Interval: Enter the interval for the local device to transmit LLDPDU to its neighbors. The default value is 30.

Hold Multiplier: Enter a multiplier on the Transmit Interval. It determines the actual TTL (Time To Live) value used in an LLDPDU. $TTL = \text{Hold Multiplier} * \text{Transmit Interval}$. The default value is 4.

Transmit Delay: Enter a value from 1 to 8192 in seconds to specify the time for the local device to transmit LLDPDU to its neighbors after changes occur so as to prevent LLDPDU being sent frequently. The default value is 2.

Reinit Delay: This parameter indicates the amount of delay from when LLDP status becomes "disable" until re-initialization will be attempted. The default value is 3.

Notification Interval: Specify the interval of Trap message which will be sent from local device to network management system. The default value is 5.

Fast Start Times: When the port's LLDP state transforms from Disable (or Rx_Only) to Tx&Rx (or Tx_Only), the fast start mechanism will be enabled, that is, the transmit interval will be shortened to a second, and several LLDPDUs will be sent out (the number of LLDPDUs equals this parameter). The default value is 3.

14.1.2 Port Config

On this page you can configure all ports' LLDP parameters.

Choose the menu **LLDP**→**Basic Config**→**Port Config** to load the following page.

Select	Port	Admin Status	Notification Mode	Included TLVs
<input type="checkbox"/>		Disable	Disable	
<input type="checkbox"/>	1	Tx&Rx	Disable	Detail
<input type="checkbox"/>	2	Tx&Rx	Disable	Detail
<input type="checkbox"/>	3	Tx&Rx	Disable	Detail
<input type="checkbox"/>	4	Tx&Rx	Disable	Detail
<input type="checkbox"/>	5	Tx&Rx	Disable	Detail
<input type="checkbox"/>	6	Tx&Rx	Disable	Detail
<input type="checkbox"/>	7	Tx&Rx	Disable	Detail
<input type="checkbox"/>	8	Tx&Rx	Disable	Detail
<input type="checkbox"/>	9	Tx&Rx	Disable	Detail
<input type="checkbox"/>	10	Tx&Rx	Disable	Detail
<input type="checkbox"/>	11	Tx&Rx	Disable	Detail
<input type="checkbox"/>	12	Tx&Rx	Disable	Detail
<input type="checkbox"/>	13	Tx&Rx	Disable	Detail
<input type="checkbox"/>	14	Tx&Rx	Disable	Detail

Figure 14-2 LLDP Port Config

The following entries are displayed on this screen:

➤ LLDP Port Config

Port Select: Select the desired port to configure.

Admin Status: Select the port's LLDP operating mode:
 Tx&Rx: send and receive LLDP frames.
 Rx_Only: Only receive LLDP frames.
 Tx_Only: Only send LLDP frames.
 Disable: neither send nor receive LLDP frames.

Notification Mode: Allows you to enable or disable the ports' SNMP notification. If enabled, the local device will notify the trap event to SNMP server.

Included TLVs: Select TLVs to be included in outgoing LLDPDU.

Details:

Click the **Detail** button to display the included TLVs and select the desired TLVs.

Included TLVs		
<input checked="" type="checkbox"/> Port Description	<input checked="" type="checkbox"/> System Capabilities	<input checked="" type="checkbox"/> System Description
<input checked="" type="checkbox"/> System Name	<input checked="" type="checkbox"/> Management Address	<input checked="" type="checkbox"/> Port VLAN ID
<input checked="" type="checkbox"/> Port And Protocol VLAN ID	<input checked="" type="checkbox"/> VLAN Name	<input checked="" type="checkbox"/> Link Aggregation
<input checked="" type="checkbox"/> MAC/PHY Configuration/Status	<input checked="" type="checkbox"/> Max Frame Size	<input checked="" type="checkbox"/> Power Via MDI
<input checked="" type="checkbox"/> All		

14.2 Device Info

You can view the LLDP information of the local device and its neighbors on the **Local Info** and **Neighbor Info** pages respectively.

14.2.1 Local Info

On this page you can see all ports' configuration and system information.

Choose the menu **LLDP**→**Device Info**→**Local Info** to load the following page.

Auto Refresh	
Auto Refresh:	<input type="radio"/> Enable <input checked="" type="radio"/> Disable
Refresh Rate:	<input type="text" value=""/> sec(3-300)
<input type="button" value="Apply"/>	

Local Info	
Port	<input type="text" value="1"/> <input type="button" value="Select"/>
Local Interface:	1
Chassis ID Subtype:	Reserved
Chassis ID:	
Port ID Subtype:	Reserved
Port ID:	
TTL:	0
Port Description:	
System Name:	
System Description:	
System Capabilities Supported:	
System Capabilities Enabled:	
Management Address:	0.0.0.0

Figure 14-3 LLDP Local Information

The following entries are displayed on this screen:

➤ **Auto Refresh**

Auto Refresh: Enable/Disable the auto refresh function.

Refresh Rate: Specify the auto refresh rate.

➤ **Local Info**

Enter the desired port number and click **Select** to display the information of the corresponding port.

14.2.2 Neighbor Info

On this page you can get the information of the neighbors.

Choose the menu **LLDP**→**Device Info**→**Neighbor Info** to load the following page.

Auto Refresh

Auto Refresh: Enable Disable

Refresh Rate: sec(3-300)

Apply

Neighbor Info

Port Select

Local Port	System Name	Chassis ID	System Description	Neighbor Port	Information
------------	-------------	------------	--------------------	---------------	-------------

Refresh Help

Figure 14-4 LLDP Neighbor Information

The following entries are displayed on this screen:

➤ **Auto Refresh**

Auto Refresh: Enable/Disable the auto refresh function.

Refresh Rate: Specify the auto refresh rate.

➤ **Neighbor Info**

Port Select: Click the **Select** button to quick-select the corresponding port based on the port number you entered.

Local Port: Displays the local port number connecting to the neighbor device.

System Name: Displays the system name of the neighbor device.

Chassis ID: Displays the Chassis ID of the neighbor device.

System Description: Displays the system description of the neighbor device.

Neighbor Port: Displays the port number of the neighbor linking to local port.

Information: Click Information to display the detailed information of the neighbor device.

14.3 Device Statistics

You can view the LLDP statistics of the local device through this feature.

Choose the menu **LLDP**→**Device Statistics**→**Statistic Info** to load the following page.

Auto Refresh

Auto Refresh: Enable Disable

Refresh Rate: sec(3-300)

Global Statistics

Last Update	Total Inserts	Total Deletes	Total Drops	Total Ageouts
00:00:00:00	0	0	0	0

Neighbors Statistics

Port

Port	Transmit Total	Receive Total	Discards	Errors	Ageouts	TLV Discards	TLV Unknowns
1	0	0	0	0	0	0	0
2	0	0	0	0	0	0	0
3	0	0	0	0	0	0	0
4	0	0	0	0	0	0	0
5	0	0	0	0	0	0	0
6	0	0	0	0	0	0	0
7	0	0	0	0	0	0	0
8	0	0	0	0	0	0	0
9	0	0	0	0	0	0	0
10	0	0	0	0	0	0	0
11	0	0	0	0	0	0	0
12	0	0	0	0	0	0	0

Figure 14-5 LLDP Statistic Information

The following entries are displayed on this screen:

➤ **Auto Refresh**

Auto Refresh: Enable/Disable the auto refresh function.

Refresh Rate: Specify the auto refresh rate.

➤ **Global Statistics**

Last Update: Displays latest update time of the statistics.

Total Inserts: Displays the number of neighbors inserted till last update time.

Total Deletes: Displays the number of neighbors deleted by local device.

Total Drops: Displays the number of neighbors dropped by local device.

Total Ageouts: Displays the number of overtime neighbors in local device.

➤ **Neighbor Statistics**

Port Select: Click the **Select** button to quick-select the corresponding port based on the port number you entered.

Port: Displays local device's port number.

Transmit Total: Displays the number of LLDPDUs sent by this port.

Receive Total: Displays the number of LLDPDUs received by this port.

Discards: Displays the number of LLDPDUs discarded by this port.

Errors: Displays the number of error LLDPDUs received by this port.

Ageouts: Displays the number of overtime neighbors linking to this port.

TLV Discards: Displays the number of TLVs dropped by this port.

TLV Unknowns: Displays the number of unknown TLVs received by this port.

14.4 LLDP-MED

LLDP-MED is an extension of LLDP intended for managing endpoint devices such as Voice over IP phones and network switches. The LLDP-MED TLVs advertise information such as network policy, power via MDI, inventory management, and device location details.

➤ **Elements**

LLDP-MED Device: Refers to any device which implements this Standard.

LLDP-MED Device Type: LLDP-MED devices are comprised of two primary device types: Network Connectivity Devices and Endpoint Devices.

Network Connectivity Device: Refers to an LLDP-MED Device that provides access to the IEEE 802 based LAN infrastructure for LLDP-MED Endpoint Devices. Bridge is a Network Connectivity Device.

Endpoint Device: Refers to an LLDP-MED Device at the network edge, providing some aspects of IP communications service, based on IEEE 802 LAN technology. Endpoint Devices may be a member of any of the Endpoint Device Classes. Endpoint Devices are composed of three defined Classes: Class I, Class II and Class III.

Generic Endpoint Device (Class I): The most basic class of Endpoint Device.

Media Endpoint Device (Class II): The class of Endpoint Device that supports media stream capabilities.

Communication Device Endpoint (Class III): The class of Endpoint Device that directly supports end users of the IP communication system.

TLV	Description
Network Policy TLV	The Network Policy TLV allows both Network Connectivity Devices and Endpoints to advertise VLAN configuration and associated Layer 2 and Layer 3 attributes that apply for a set of specific applications on that port.

TLV	Description
Location Identification TLV	The Location Identification TLV provides for advertisement of location identifier information to Communication Endpoint Devices, based on configuration of the Network Connectivity Device it's connected to. You can set the Location Identification content in Location Identification Parameters. If Location Identification TLV is included and Location Identification Parameters isn't set, a default value is used in Location Identification TLV.
Extended Power-Via-MDI TLV	The Extended Power-Via-MDI TLV is intended to enable advanced power management between LLDP-MED Endpoint and Network Connectivity Devices, and it allows advertisement of fine grained power requirement details, Endpoint power priority, as well as both Endpoint and Network Connectivity Device power status.
Inventory TLV	The Inventory TLV set contains seven basic Inventory management TLVs, that is, Hardware Revision TLV, Firmware Revision TLV, Software Revision TLV, Serial Number TLV, Manufacturer Name TLV, Model Name TLV and Asset ID TLV. If support for any of the TLVs in the Inventory Management set is implemented, then support for all Inventory Management TLVs shall be implemented.

LLDP-MED is configured on the **Global Config**, **Port Config**, **Local Info** and **Neighbor Info** pages.

14.4.1 Global Config

On this page you can configure the LLDP-MED parameters of the device globally.

Choose the menu **LLDP**→**LLDP-MED**→**Global Config** to load the following page.

LLDP-MED Parameters Config

Fast Start Count: (1-10) Apply

Device Class: Network Connectivity Help

Figure 14-6 LLDP-MED Global Configuration

The following entries are displayed on this screen:

➤ **LLDP-MED Parameters Config**

Fast Start Count: When LLDP-MED fast start mechanism is activated, multiple LLDP-MED frames will be transmitted based on this parameter.

Device Class: LLDP-MED devices are comprised of two primary device types: Network Connectivity Devices and Endpoint Devices. In turn, Endpoint Devices are composed of three defined Classes: Class I, Class II and Class III. Bridge is a Network Connectivity Device.

14.4.2 Port Config

On this page you can configure all ports' LLDP-MED parameters.

Choose the menu **LLDP**→**LLDP-MED**→**Port Config** to load the following page.

Select	Port	LLDP-MED Status	Included TLVs
<input type="checkbox"/>		Disable	
<input type="checkbox"/>	1	Disable	Detail
<input type="checkbox"/>	2	Disable	Detail
<input type="checkbox"/>	3	Disable	Detail
<input type="checkbox"/>	4	Disable	Detail
<input type="checkbox"/>	5	Disable	Detail
<input type="checkbox"/>	6	Disable	Detail
<input type="checkbox"/>	7	Disable	Detail
<input type="checkbox"/>	8	Disable	Detail
<input type="checkbox"/>	9	Disable	Detail
<input type="checkbox"/>	10	Disable	Detail
<input type="checkbox"/>	11	Disable	Detail
<input type="checkbox"/>	12	Disable	Detail
<input type="checkbox"/>	13	Disable	Detail
<input type="checkbox"/>	14	Disable	Detail

Figure 14-7 LLDP-MED Port Configuration

The following entries are displayed on this screen:

➤ LLDP-MED Port Config

Port Select: Select the desired port to configure.

LLDP-MED Status: Configure the port's LLDP-MED status:

Enable: Enable the port's LLDP-MED status, and the port's Admin Status will be changed to Tx&Rx.

Disable: Disable the port's LLDP-MED status.

Included TLVs: Select TLVs to be included in outgoing LLDPDU.

Detail: Click the **Detail** button to display the included TLVs and select the desired TLVs.

Included TLVs

Network Policy
 Location Identification
 Extended Power-Via-MDI
 Inventory
 All

Location Identification Parameters

Emergency Number: Chars.(10-25)
 Civic Address

What:

Country Code:

Language:

Province/State:

County/Parish/District:

City/Township:

Street:

House Number:

Name:

Postal/Zip Code:

Room Number:

Post Office Box:

Additional Information:

➤ **Included TLVs**

Select TLVs to be included in outgoing LLDPDU.

➤ **Location Identification Parameters**

Configure the Location Identification TLV's content in outgoing LLDPDU of the port.

Emergency Number: Emergency number is Emergency Call Service ELIN identifier, which is used during emergency call setup to a traditional CAMA or ISDN trunk-based PSAP.

Civic Address: The Civic address is defined to reuse the relevant sub-fields of the DHCP option for Civic Address based Location Configuration Information as specified by IETF.

14.4.3 Local Info

On this page you can see all ports' LLDP-MED configuration.

Choose the menu **LLDP**→**LLDP-MED**→**Local Info** to load the following page.

Auto Refresh

Auto Refresh: Enable Disable Apply

Refresh Rate: sec(3-300)

LLDP-MED Local Info

Port Select

Local Interface:	1
Device Type:	Network Connectivity
Application Type:	Reserved
Unknown Policy Flag:	Yes
VLAN tagged:	No
Media Policy VLAN ID:	0
Media Policy Layer 2 Priority:	0
Media Policy DSCP:	0
Power Type:	PSE Device
Power Source:	Primary
Power Priority:	Unknown
Available Power Value:	0w

Refresh Help

Figure 14-8 LLDP-MED Local Information

The following entries are displayed on this screen:

➤ **Auto Refresh**

Auto Refresh: Enable/Disable the auto refresh function.

Refresh Rate: Specify the auto refresh rate.

➤ **Local Info**

Enter the desired port number and click **Select** to display the information of the corresponding port.

14.4.4 Neighbor Info

On this page you can get the LLDP-MED information of the neighbors.

Choose the menu **LLDP**→**LLDP-MED**→**Neighbor Info** to load the following page.

Auto Refresh

Auto Refresh: Enable Disable

Refresh Rate: sec(3-300)

LLDP-MED Neighbor Info

Port

Local Port	Device Type	Application Type	Location Data Format	Power Type	Information
------------	-------------	------------------	----------------------	------------	-------------

Figure 14-9 LLDP-MED Neighbor Information

The following entries are displayed on this screen:

➤ **Auto Refresh**

Auto Refresh: Enable/Disable the auto refresh function.

Refresh Rate: Specify the auto refresh rate.

➤ **Neighbor Info**

Port Select: Click the **Select** button to quick-select the corresponding port based on the port number you entered.

Local Port: Displays the local port number connecting to the neighbor device.

Device Type: Displays the device type of the neighbor.

Application Type: Displays the application type of the neighbor. Application Type indicates the primary function of the applications defined for the network policy.

Local Data Format: Displays the location identification of the neighbor.

Power Type: Displays the power type of the neighbor device, Power Sourcing Entity (PSE) or Powered Device (PD).

Information: Click the **Information** button to display the detailed information of the corresponding neighbor.

[Return to CONTENTS](#)

Chapter 15 Maintenance

Maintenance module, assembling the commonly used system tools to manage the switch, provides the convenient method to locate and solve the network problem.

- (1) System Monitor: Monitor the utilization status of the memory and the CPU of switch.
- (2) Log: View the configuration parameters of the switch and find out the errors via the Logs.
- (3) Device Diagnostics: Cable Test tests the connection status of the cable to locate and diagnoses the trouble spot of the network.
- (4) Network Diagnostics: Test whether the destination device is reachable and detect the route hops from the switch to the destination device.

15.1 System Monitor

System Monitor functions to display the utilization status of the memory and the CPU of switch via the data graph. The CPU utilization rate and the memory utilization rate should fluctuate stably around a specific value. If the CPU utilization rate or the memory utilization rate increases markedly, please detect whether the network is being attacked.

The **System Monitor** function is implemented on the **CPU Monitor** and **Memory Monitor** pages.

15.1.1 CPU Monitor

Choose the menu **Maintenance**→**System Monitor**→**CPU Monitor** to load the following page.

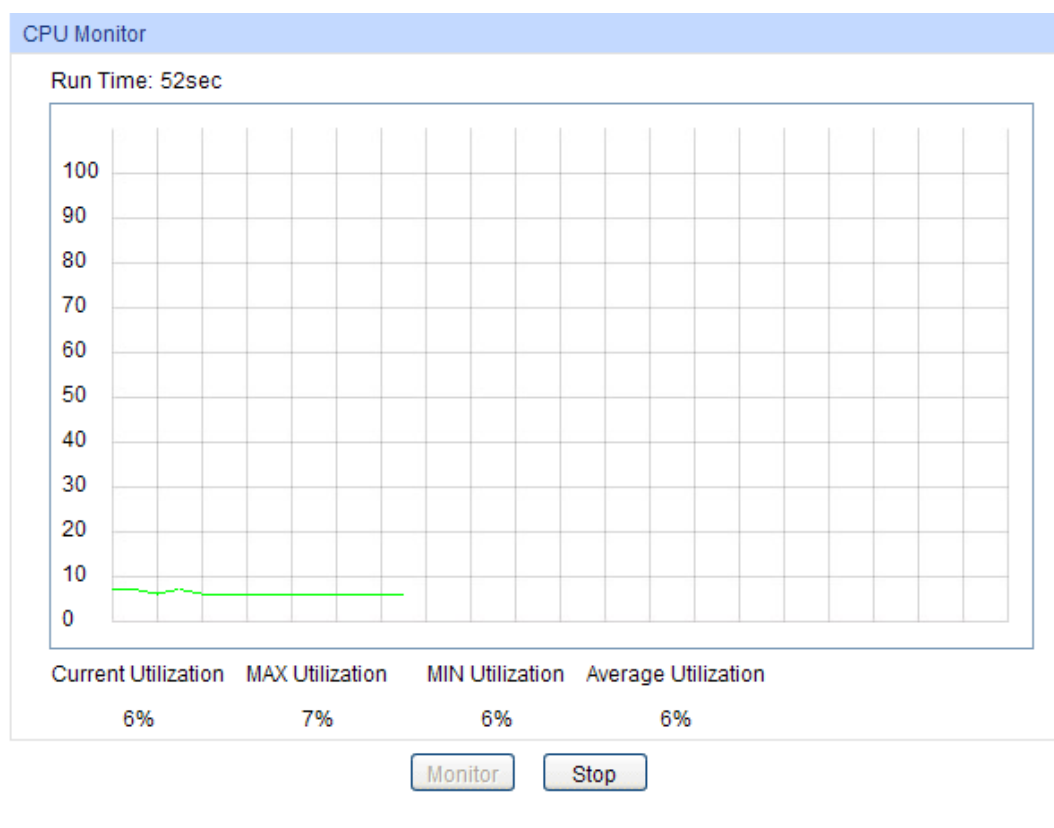

Figure 15-1 CPU Monitor

Click the **Monitor** button to enable the switch to monitor and display its CPU utilization rate every four seconds.

15.1.2 Memory Monitor

Choose the menu **Maintenance**→**System Monitor**→**Memory Monitor** to load the following page.

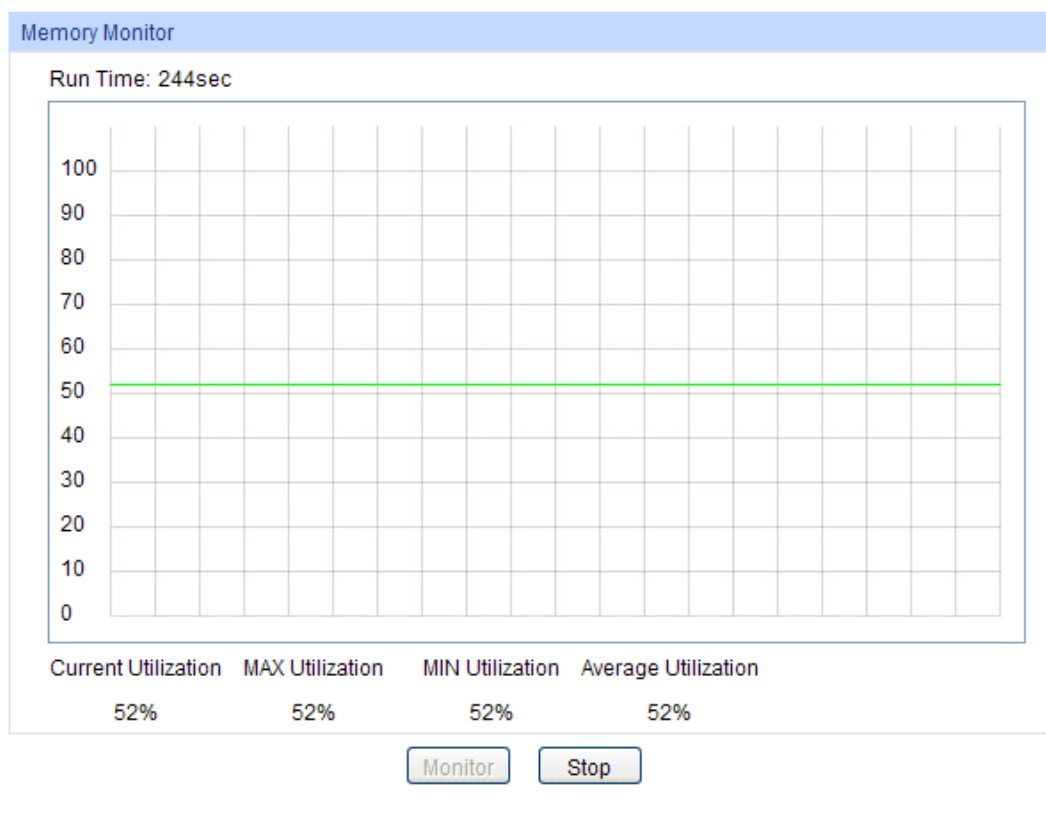

Figure 15-2 Memory Monitor

Click the **Monitor** button to enable the switch to monitor and display its Memory utilization rate every four seconds.

15.2 Log

The Log system of switch can record, classify and manage the system information effectively, providing powerful support for network administrator to monitor network operation and diagnose malfunction.

The Logs of switch are classified into the following eight levels.

Severity	Level	Description
emergencies	0	The system is unusable.
alerts	1	Action must be taken immediately.
critical	2	Critical conditions
errors	3	Error conditions
warnings	4	Warnings conditions
notifications	5	Normal but significant conditions
informational	6	Informational messages
debugging	7	Debug-level messages

Table 15-1 Log Level

The **Log** function is implemented on the **Log Table**, **Local Log**, **Remote Log** and **Backup Log** pages.

15.2.1 Log Table

The switch supports logs output to two directions, namely, log buffer and log file. The information in log buffer will be lost after the switch is rebooted or powered off whereas the information in log file will be kept effective even the switch is rebooted or powered off. Log Table displays the system log information in log buffer.

Choose the menu **Maintenance**→**Log**→**Log Table** to load the following page.

Log Info				
Index	Time	Module	Severity	Content
		All Module ▾	All Level ▾	
1	2012-04-29 16:16:10	LAG	level_6	Changed Link Aggregation Group 1, members: 10,11,12,13,0,0,0,0.
2	2012-04-29 16:15:54	LAG	level_6	Added new Link Aggregation Group 1, members: 10,11,12,13,0,0,0,0.
3	2012-04-29 15:56:28	Port	level_5	Mirror group 4 is delete!
4	2012-04-29 15:07:02	SNTP	level_5	Setting system time OK.
5	2006-01-01 08:00:15	SNMP	level_5	SNMP initialization OK.
6	2006-01-01 08:00:00	QoS	level_5	QoS module initialization OK.

Note:

1. There are 8 severity levels marked with value 0-7. The smaller value has the higher priority.
2. This page displays logs in the log buffer, and at most 512 logs are displayed.

Figure 15-3 Log Table

The following entries are displayed on this screen:

➤ **Log Info**

- Index:** Displays the index of the log information.
- Time:** Displays the time when the log event occurs. The log can get the correct time after you configure on the System ->System Info->System Time Web management page.
- Module:** Displays the module which the log information belongs to. You can select a module from the drop-down list to display the corresponding log information.
- Severity:** Displays the severity level of the log information. You can select a severity level to display the log information whose severity level value is the same or smaller.
- Content:** Displays the content of the log information.



Note:

1. The logs are classified into eight levels based on severity. The higher the information severity is, the lower the corresponding level is.
2. This page displays logs in the log buffer, and at most 512 logs are displayed.

15.2.2 Local Log

Local Log is the log information saved in switch. By default, all system logs are saved in log buffer and the logs with severities from level_0 to level_2 are saved in log file meanwhile. On this page, you can set the output channel for logs.

Choose the menu **Maintenance**→**Log**→**Local Log** to load the following page.

Local Log Config			
Select	Channel	Severity	Status
<input type="checkbox"/>		<input type="text" value="level_6"/>	<input type="text" value="Enable"/>
<input type="checkbox"/>	Log Buffer	level_6	Enable
<input type="checkbox"/>	Log File	level_2	Disable

Note:

1. Local log includes 2 channels: log buffer and log file.
2. There are 8 severity levels marked with values 0-7. The smaller value has the higher priority.

Figure 15-4 Local Log

The following entries are displayed on this screen:

➤ **Local Log Config**

- Select:** Select the desired entry to configure the corresponding local log.
- Channel:**
- Log buffer: Indicates the RAM for saving system log. The information in the log buffer is displayed on the Log Table page. It will be lost when the switch is restarted.
 - Log File: Indicates the flash sector for saving system log. The information in the log file will not be lost after the switch is restarted and can be exported on the Backup Log page.
- Severity:** Specify the severity level of the log information output to each channel. Only the log with the same or smaller severity level value will be output.
- Status:** Enable/Disable the channel.

15.2.3 Remote Log

Remote log feature enables the switch to send system logs to the Log Server. Log Server is to centralize the system logs from various devices for the administrator to monitor and manage the whole network.

Choose the menu **Maintenance**→**Log**→**Remote Log** to load the following page.

Log Host					
Select	Index	Host IP	UDP Port	Severity	Status
<input type="checkbox"/>		<input type="text"/>		<input type="text" value="level_6"/>	<input type="text" value="Disable"/>
<input type="checkbox"/>	1	0.0.0.0	514	level_6	Disable
<input type="checkbox"/>	2	0.0.0.0	514	level_6	Disable
<input type="checkbox"/>	3	0.0.0.0	514	level_6	Disable
<input type="checkbox"/>	4	0.0.0.0	514	level_6	Disable

Note:

- 1.Up to 4 log hosts are supported.
- 2.There are 8 severity levels marked with values 0-7. The smaller value has the higher priority.

Figure 15-5 Log Host

The following entries are displayed on this screen:

➤ **Log Host**

- Index:** Displays the index of the log host. The switch supports 4 log hosts.
- Host IP:** Configure the IP for the log host.
- UDP Port:** Displays the UDP port used for receiving/sending log information. Here we use the standard port 514.
- Severity:** Specify the severity level of the log information sent to each log host. Only the log with the same or smaller severity level value will be sent to the corresponding log host.
- Status:** Enable/Disable the log host.



Note:

The Log Server software is not provided. If necessary, please download it on the Internet.

15.2.4 Backup Log

Backup Log feature enables the system logs saved in the switch to be output as a file for device diagnosis and statistics analysis. When a critical error results in the breakdown of the system, you can export the logs to get some related important information about the error for device diagnosis after the switch is restarted.

Choose the menu **Maintenance**→**Log**→**Backup Log** to load the following page.

Backup Log

Click the button here to backup the log file:

Note:

It will take a few minutes to backup the log file. Please wait without any operation.

Figure 15-6 Backup Log

The following entry is displayed on this screen:

➤ **Backup Log**

Backup Log: Click the **Backup Log** button to save the log as a file to your computer.



Note:

It will take a few minutes to backup the log file. Please wait without any operation.

15.3 Device Diagnostics

This switch provides Cable Test for device diagnose.

15.3.1 Cable Test

Cable Test functions to test the connection status of the cable connected to the switch, which facilitates you to locate and diagnose the trouble spot of the network.

Choose the menu **Maintenance**→**Device Diagnostics**→**Cable Test** to load the following page.

Cable Test			
Port:	--	Unit: meter	
Pair	Status	Length	Error
Pair-A	--	--	--
Pair-B	--	--	--
Pair-C	--	--	--
Pair-D	--	--	--

Note:

1. The interval between two cable test for one port must be more than 3 seconds.
2. The result is more reasonable when the cable pair is in the open status.
3. The result is just for your information.

Figure 15-7 Cable Test

The following entries are displayed on this screen:

➤ **Cable Test**

Port: Select the port for cable testing.

Pair: Displays the Pair number.

Status: Displays the connection status of the cable connected to the port. The test results of the cable include normal, close, open or impedance.

Length: If the connection status is normal, here displays the length range of the cable.

Error: If the connection status is close, open or impedance, here displays the error length of the cable.



Note:

1. The Length displayed here is the length of pair cable not that of the physical cable.
2. The test result is just for your reference.

15.4 Network Diagnostics

This switch provides Ping test and Tracert test functions for network Diagnostics.

15.4.1 Ping

Ping test function, testing the connectivity between the switch and one node of the network, facilitates you to test the network connectivity and reachability of the host so as to locate the network malfunctions.

Choose the menu **Maintenance**→**Network Diagnostics**→**Ping** to load the following page.

The screenshot shows a web interface for configuring and executing a ping test. The top section, titled "Ping Config", contains four input fields: "Destination IP" (192.168.0.1), "Ping Times" (4), "Data Size" (64), and "Interval" (1000). To the right of these fields are two buttons: "Ping" and "Help". Below this is the "Ping Result" section, which displays the following information:

Ping Result	
Pinging 192.168.0.1 with 64 bytes of data :	
Reply from 192.168.0.1 :	bytes=64 time<16ms TTL=64
Reply from 192.168.0.1 :	bytes=64 time<16ms TTL=64
Reply from 192.168.0.1 :	bytes=64 time<16ms TTL=64
Reply from 192.168.0.1 :	bytes=64 time<16ms TTL=64
Ping statistics for 192.168.0.1:	
Packets: Sent = 4 , Received = 4 , Lost = 0 (0% loss)	
Approximate round trip times in milli-seconds:	
Minimum = 0ms , Maximum = 0ms , Average = 0ms	

Figure 15-8 Ping

The following entries are displayed on this screen:

➤ **Ping Config**

- Destination IP:** Enter the IP address of the destination node for Ping test. Both IPv4 and IPv6 are supported.
- Ping Times:** Enter the amount of times to send test data during Ping testing. The default value is recommended.
- Data Size:** Enter the size of the sending data during Ping testing. The default value is recommended.
- Interval:** Specify the interval to send ICMP request packets. The default value is recommended.

15.4.2 Tracert

Tracert test function is used to test the connectivity of the gateways during its journey from the source to destination of the test data. When malfunctions occur to the network, you can locate trouble spot of the network with this tracert test.

Choose the menu **Maintenance**→**Network Diagnostics**→**Tracert** to load the following page.

Tracert Config

Destination IP:

Max Hop: hop (1-30)

Tracert Result

Figure 15-9 Tracert

The following entries are displayed on this screen:

➤ **Tracert Config**

Destination IP: Enter the IP address of the destination device. Both IPv4 and IPv6 are supported.

Max Hop: Specify the maximum number of the route hops the test data can pass through.

[Return to CONTENTS](#)

Appendix A: Specifications

Standards	IEEE802.3 10Base-T Ethernet
	IEEE802.3u 100Base-TX/100Base-FX Fast Ethernet
	IEEE802.3ab 1000Base-T Gigabit Ethernet
	IEEE802.3z 1000Base-X Gigabit Ethernet
	IEEE802.3x Flow Control
	IEEE802.1p QoS
	IEEE802.1q VLAN
	IEEE802.1X Port-based Access Authentication
Transmission Rate	Ethernet: 10Mbps HD, 20Mbps FD
	Fast Ethernet: 100Mbps HD, 200Mbps FD
	Gigabit Ethernet: 2000Mbps FD
Transmission Medium	10Base-T: UTP/STP of Cat. 3 or above
	100Base-TX: UTP/STP of Cat. 5 or above
	100Base-FX: MMF or SMF SFP Module (Optional)
	1000Base-T: 4-pair UTP ($\leq 100m$) of Cat. 5, Cat. 5e, Cat.6 or above
	1000Base-X: MMF or SMF SFP Module (Optional)
LED	For TL-SG2216/TL-SG2424: Power, System, 1000Mbps, Link/Act
	For TL-SG2424P: Power, System, 10/100/1000Mbps Port LED, Speed, PoE, PoE Max
	For TL-SG2452: PWR, SYS, 10/100/1000Mbps
Transmission Method	Store and Forward
Packets Forwarding Rate	10BASE-T: 14881pps/port 100BASE-TX: 148810pps/port 1000Base-T: 1488095pps/port
Operating Environment	Operating Temperature: 0°C ~ 40°C
	Storage Temperature: -40°C ~ 70°C
	Operating Humidity: 10% ~ 90% RH Non-condensing
	Storage Humidity: 5% ~ 90% RH Non-condensing

[Return to CONTENTS](#)

Appendix B: Configuring the PCs

In this section, we'll introduce how to install and configure the TCP/IP correctly in Windows 2000 and TCP/IPv6 in WIN7. First make sure your Ethernet Adapter is working, refer to the adapter's manual if necessary.

1. In IPv4 network:

- 1) On the Windows taskbar, click the **Start** button, and then click **Control Panel**.
- 2) Click the **Network and Internet Connections** icon, and then click on the **Network Connections** tab in the appearing window.
- 3) Right click the icon that showed below, select Properties on the prompt page.

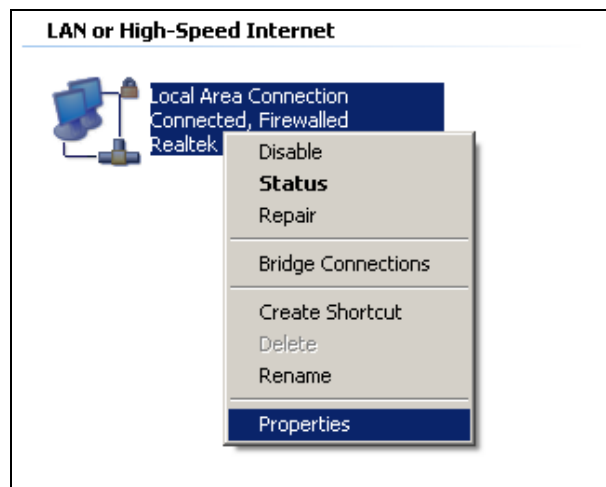

Figure B-1

- 4) In the prompt page that showed below, double click on the **Internet Protocol (TCP/IP)**.

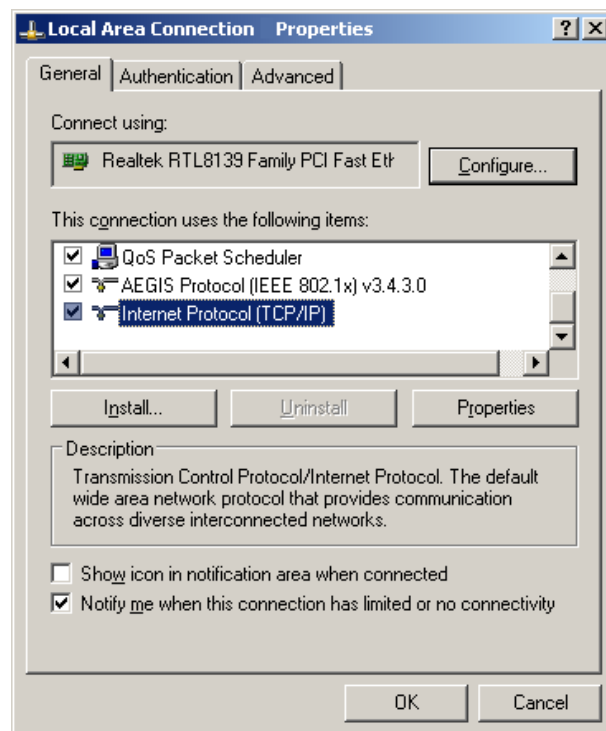

Figure B-2

- 5) The following **TCP/IP Properties** window will display and the **IP Address** tab is open on this window by default.

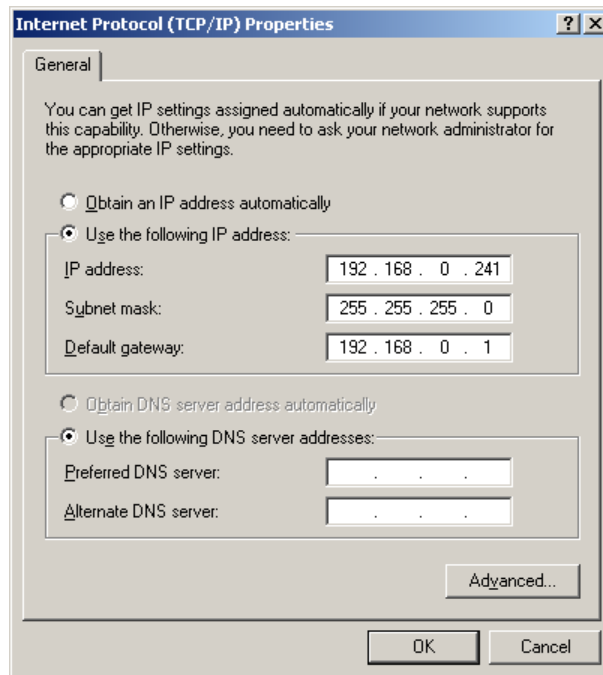

Figure B-3

- 6) Select Use the following IP address. And the following items will be available. If the switch's IP address is 192.168.0.1, specify IP address as 192.168.0.x (x is from 2 to 254), and the **Subnet mask** as 255.255.255.0.

2. In IPv6 network:

- 1) On the Windows taskbar, click the **Start** button, and then click **Control Panel**.
- 2) Click the **View network status and tasks** under the tab **Network and Internet**.

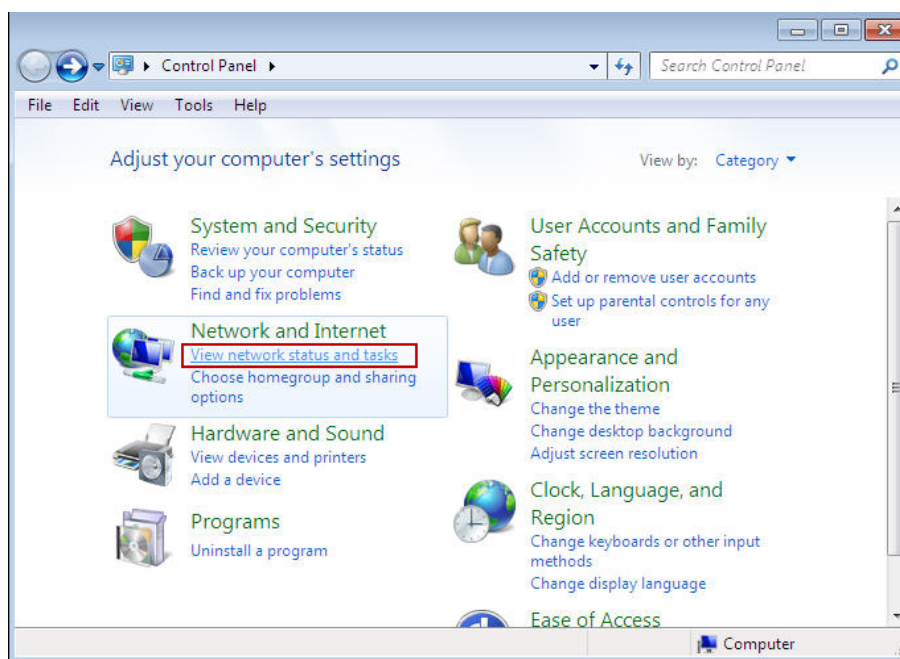

Figure B-4

- 3) Select **Local Network Connection** under the tab **View your active networks** on the prompt page.

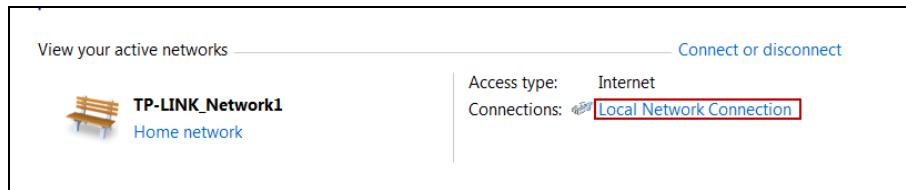

Figure B-5

- 4) In the prompt page that showed below, double click on the **Internet Protocol Version 6 (TCP/IPv6)**.

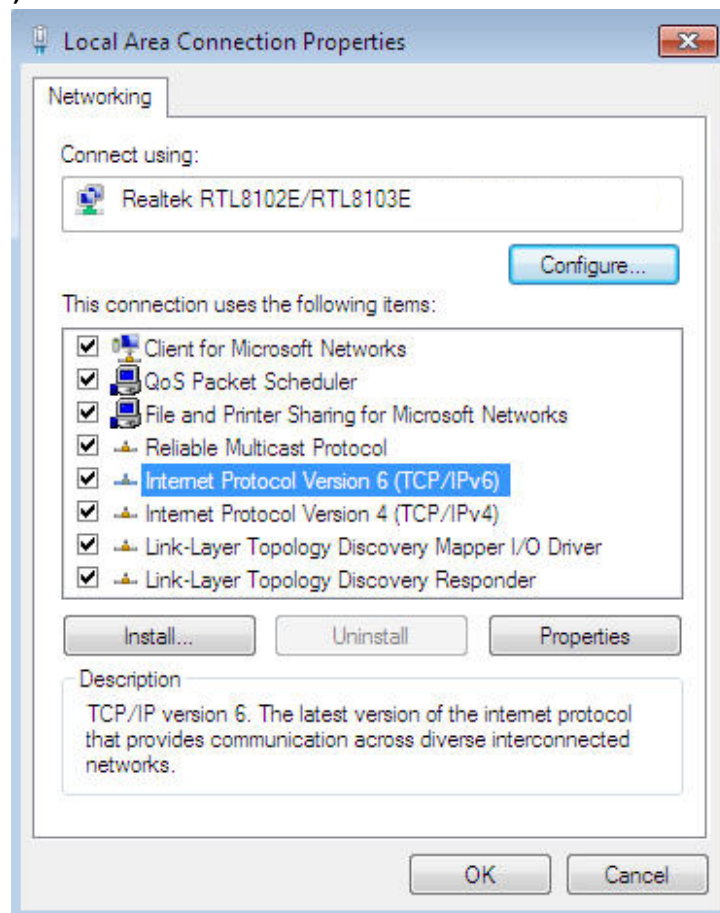

Figure B-6

- 5) The following TCP/IPv6 Properties window will display and the IP Address tab is open on this window by default.

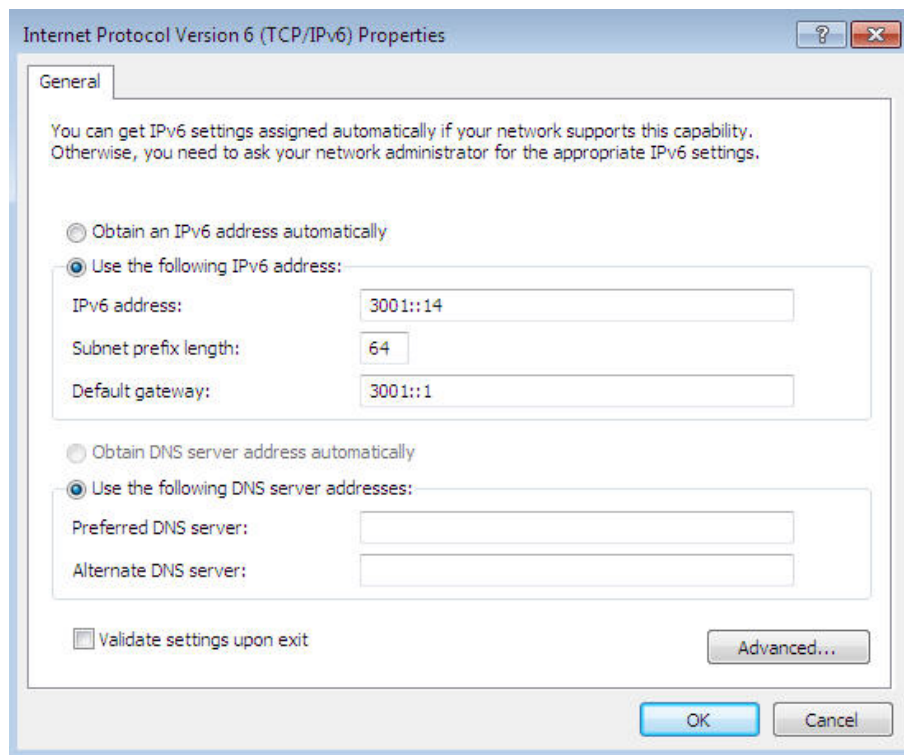

Figure B-7

- 6) Select **Use the following IPv6 address**. And the following items will be available. If the switch's IP address is 3001::1/64, specify IP address as 3001::14 for example , and the **Subnet prefix length** as 64.

Now:

Click **OK** to save your settings.

[Return to CONTENTS](#)

Appendix C: 802.1X Client Software

In 802.1X mechanism, the supplicant Client should be equipped with the corresponding client software complied with 802.1X protocol standard for 802.1X authentication. When the switch works as the authenticator system, please take the following instructions to install the TpSupplicant provided on the attached CD for the supplicant Client.

1. Installation Guide

- 1) Insert the provided CD into your CD-ROM drive. Open the file folder and double click the icon  to load the following figure. Choose the proper language and click **Next** to continue.

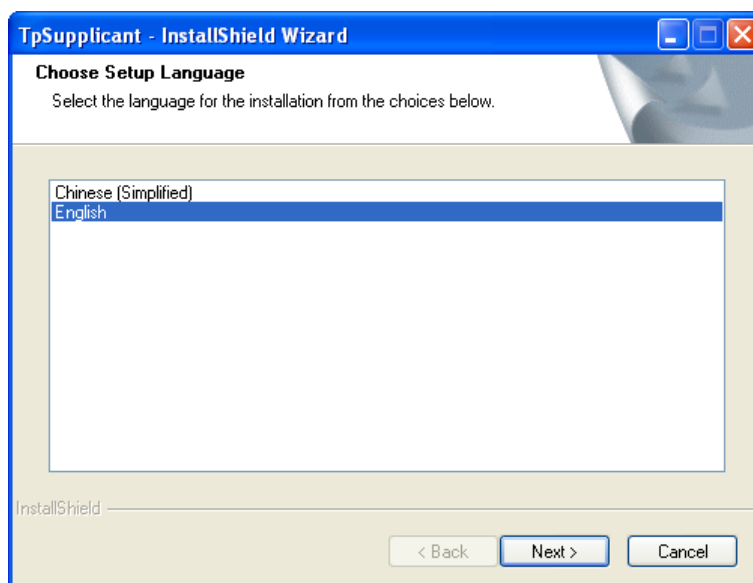

Figure C-1 Choose Setup Language

- 2) Please wait for the InstallShield Wizard preparing the setup shown as the following screen.

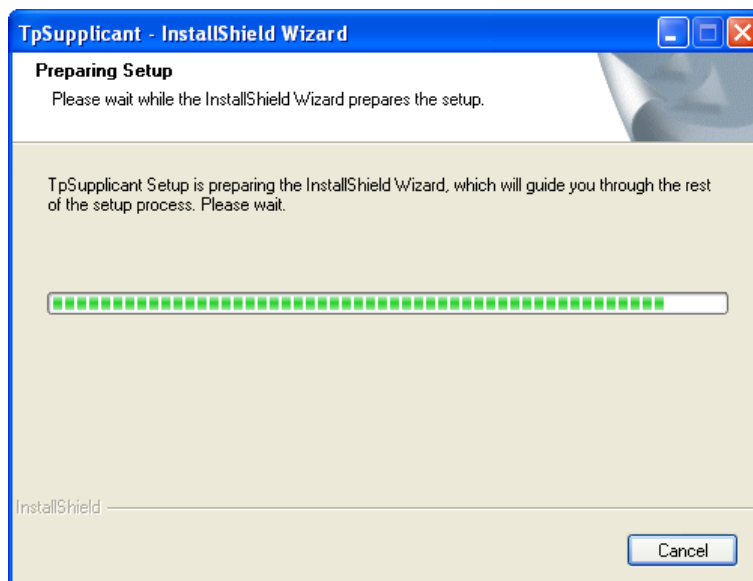

Figure C-2 Preparing Setup

- 3) Then the following screen will appear. Click **Next** to continue. If you want to stop the installation, click **Cancel**.

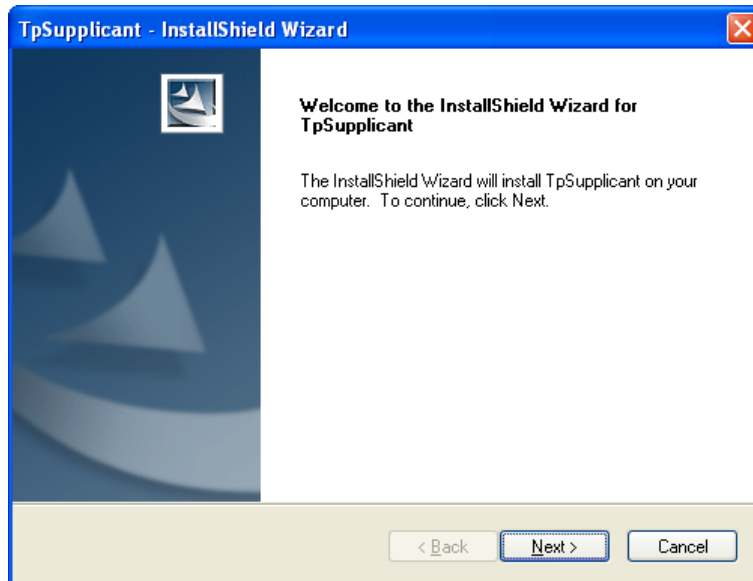

Figure C-3 Welcome to the InstallShield Wizard

- 4) To continue, choose the destination location for the installation files and click **Next** on the following screen.

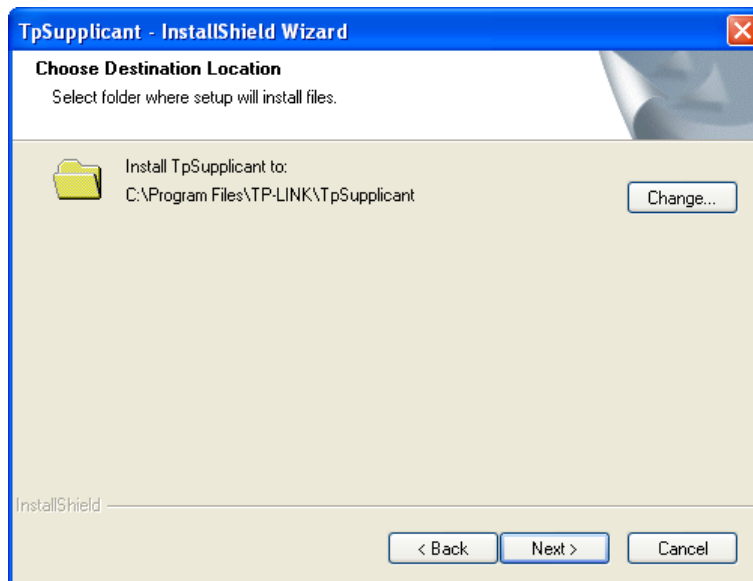

Figure C-4 Choose Destination Location

By default, the installation files are saved on the Program Files folder of system disk. Click the **Change** button to modify the destination location proper to your need.

- 5) Till now, The Wizard is ready to begin the installation. Click **Install** to start the installation on the following screen.

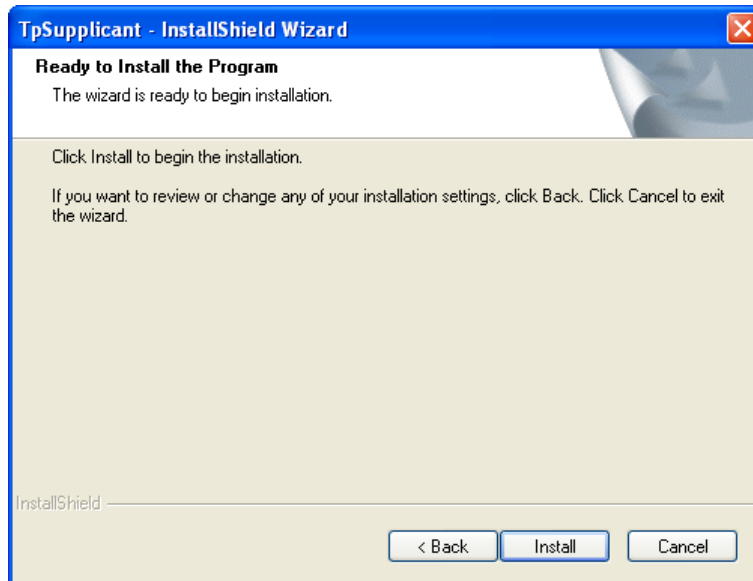

Figure C-5 Install the Program

- 6) The InstallShield Wizard is installing TpSupplicant shown as the following screen. Please wait.

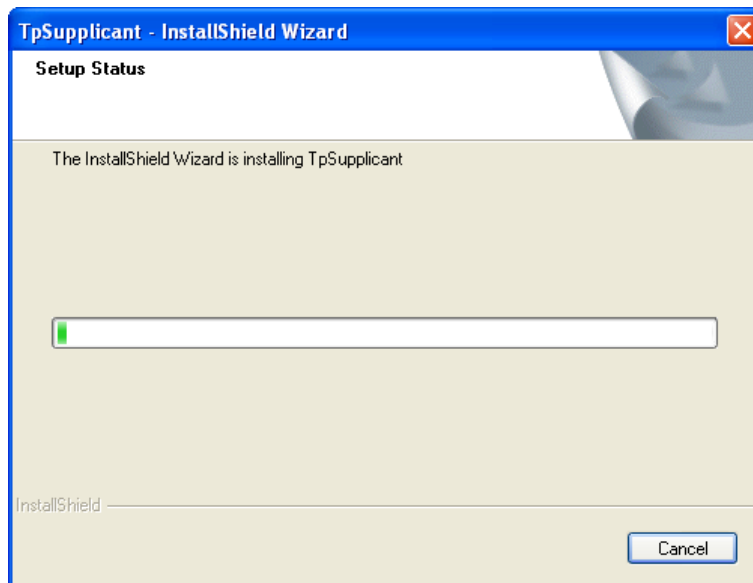

Figure C-6 Setup Status

7) On the following screen, click **Finish** to complete the installation.

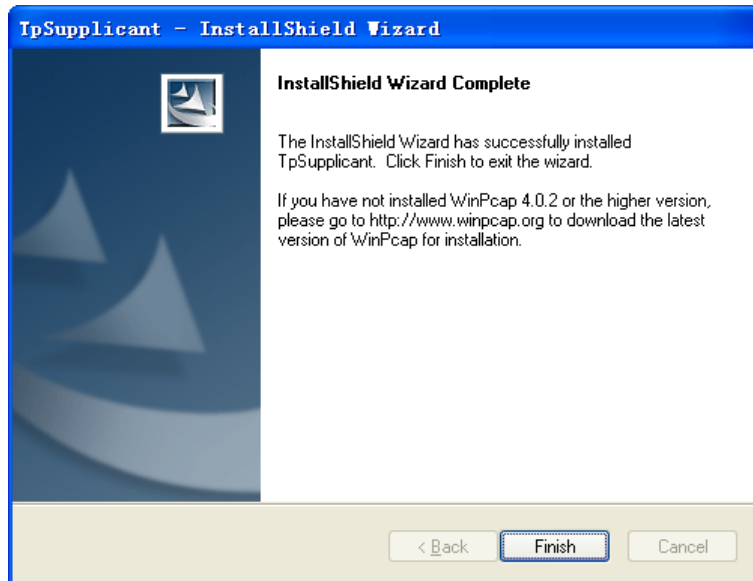

Figure C-7 InstallShield Wizard Complete

Note: Please pay attention to the tips on the above screen. If you have not installed WinPcap 4.0.2 or the higher version on your computer, the 802.1X Client Software TpSupplicant cannot work. It's recommended to go to <http://www.winpcap.org> to download the latest version of WinPcap for installation.

2. Uninstall Software

If you want to remove the TpSupplicant, please take the following steps:

- 1) On the Windows taskbar, click the **Start** button, point to **All Programs**→**TP-LINK**→**TpSupplicant**, and then click **Uninstall TP-LINK 802.1X**, shown as the following figure.

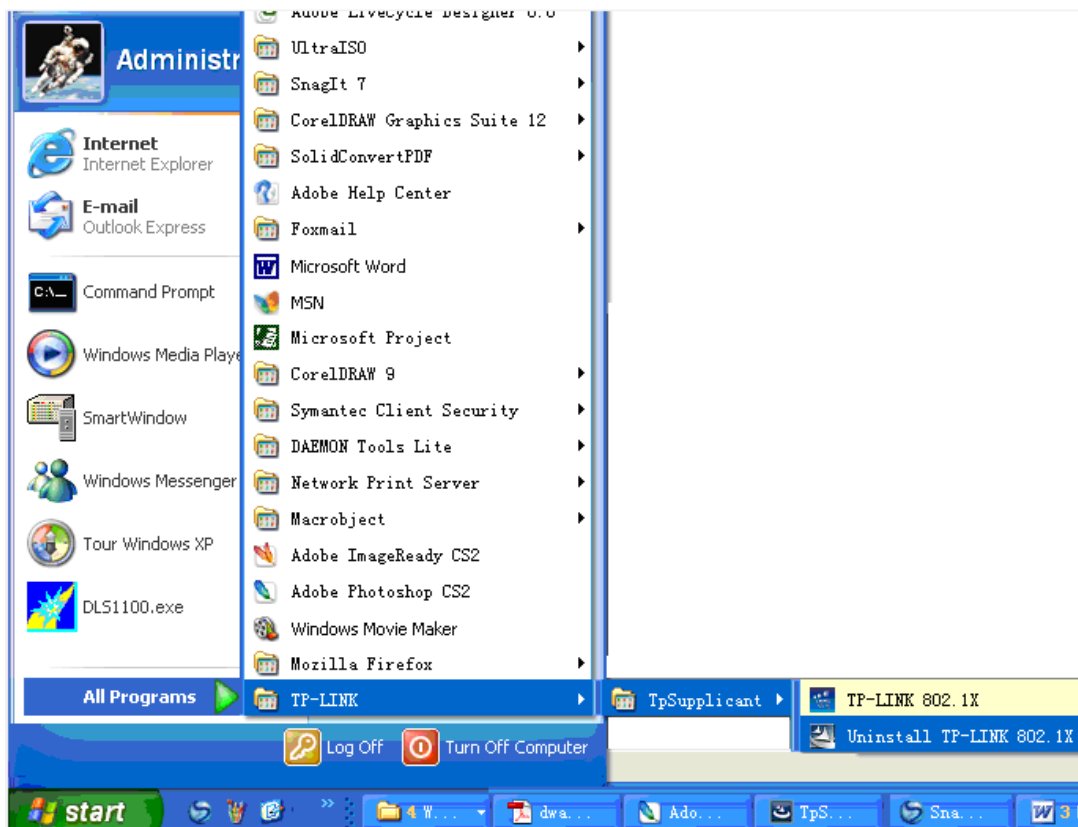

Figure C-8 Uninstall TP-LINK 802.1X

- 2) Then the following screen will appear. If you want to stop the remove process, click **Cancel**.

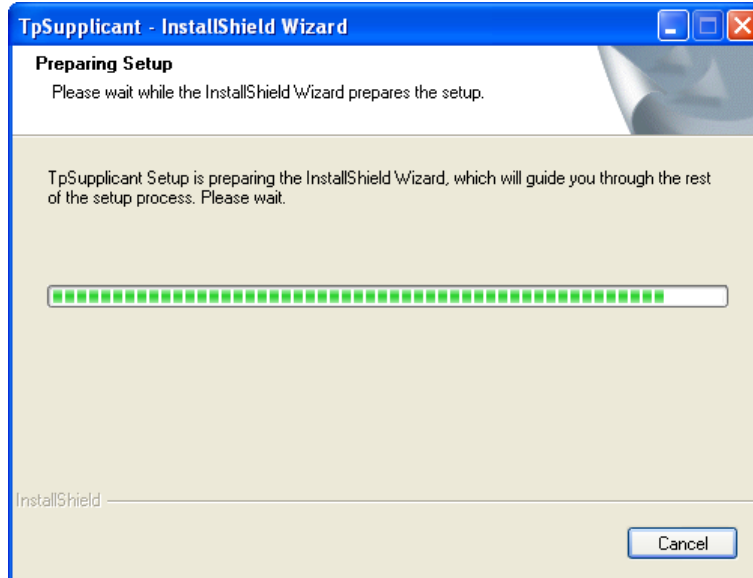

Figure C-9 Preparing Setup

- 3) On the continued screen, click **Yes** to remove the application from your PC.

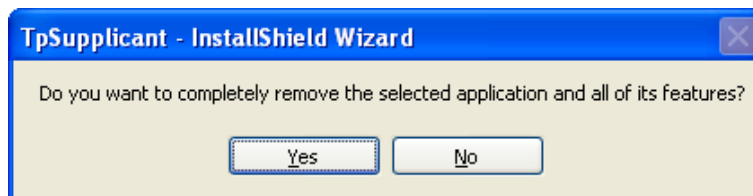

Figure C-10 Uninstall the Application

- 4) Click **Finish** to complete.

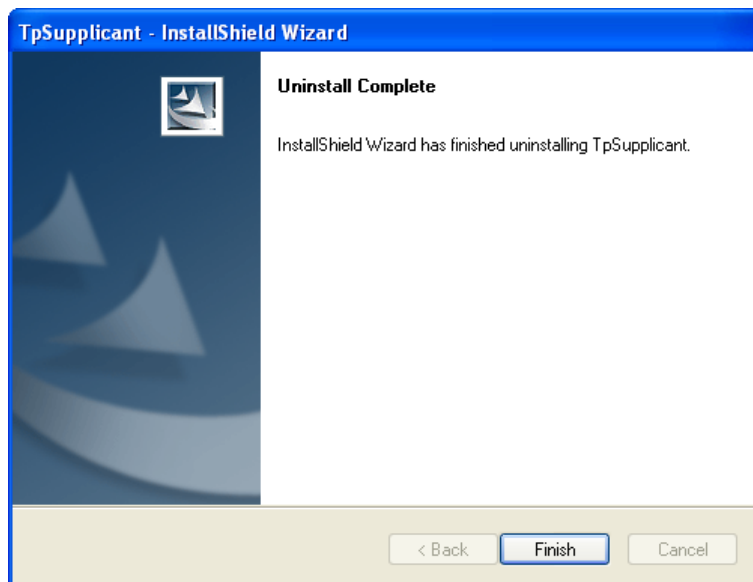

Figure C-11 Uninstall Complete

3. Configuration

- 1) After completing installation, double click the icon  to run the TP-LINK 802.1X Client Software. The following screen will appear.



Figure C-12 TP-LINK 802.1X Client

Enter the **Name** and the **Password** specified in the Authentication Server. The length of **Name** and **Password** should be less than 16 characters.

- 2) Click the **Properties** button on Figure C-12 to load the following screen for configuring the connection properties.

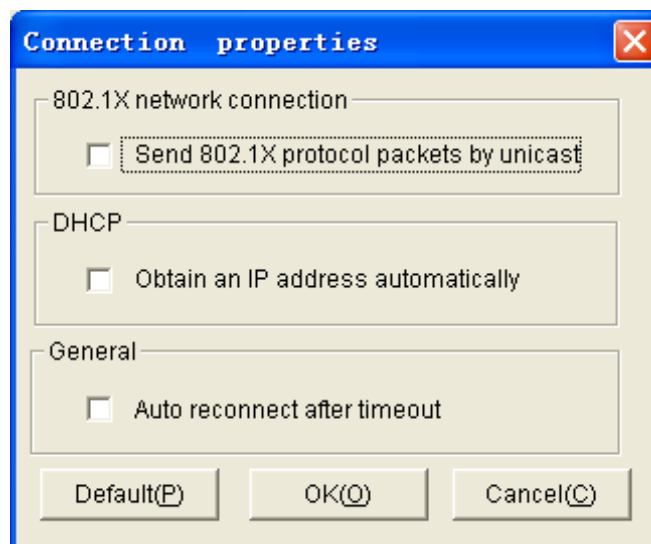

Figure C-13 Connection Properties

Send 802.1X protocol packets by Unicast: When this option is selected, the Client will send the EAPOL Start packets to the switch via multicast and send the 802.1X authentication packets via unicast.

Obtain an IP address automatically: Select this option if the Client automatically obtains the IP address from DHCP server. After passing the authentication, the Client can be assigned the IP address by DHCP server. The Client can access the network after getting the new IP address.

Auto reconnect after timeout: Select this option to allow the Client to automatically start the connection again when it does not receive the handshake reply packets from the switch within a period.

- 3) To continue, click **Connect** button after entering the **Name** and **Password** on Figure C-12. Then the following screen will appear to prompt that the Radius server is being searched.

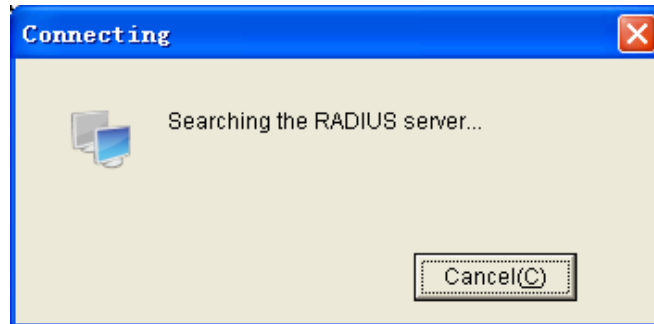

Figure C-14 Authentication Dialog

- 4) When passing the authentication, the following screen will appear.

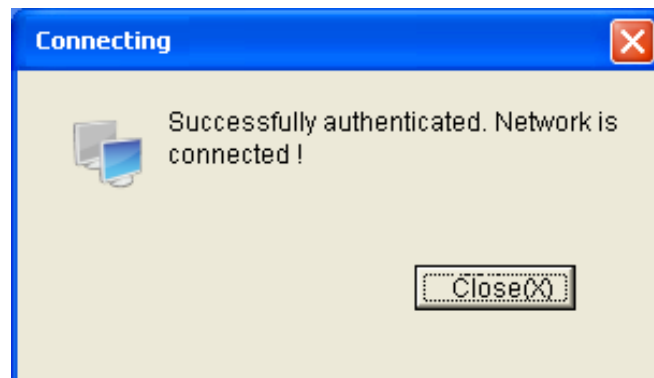



Figure C-15 Successfully Authenticated

- 5) Double click the icon  on the right corner of desktop, and then the following connection status screen will pop up.

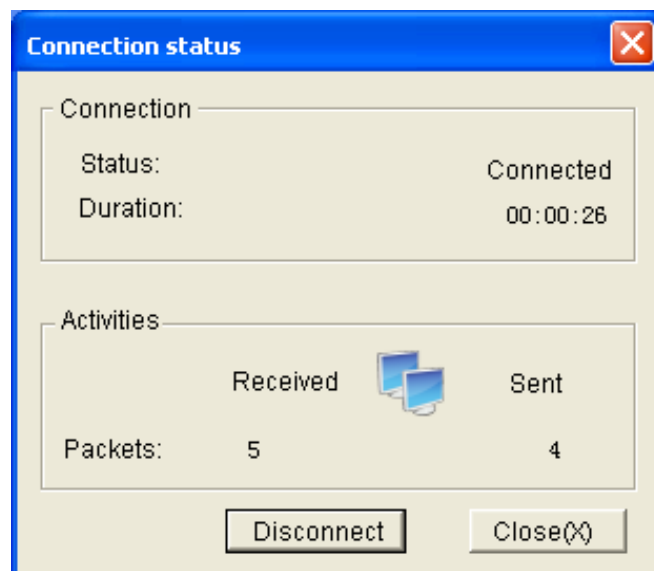
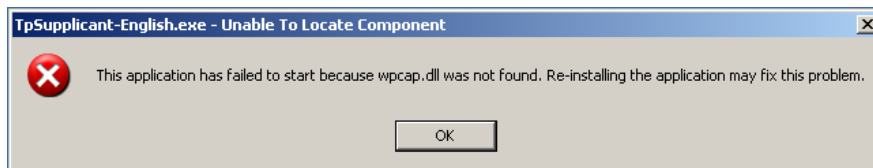

Figure C-16 Connection Status

4. FAQ:

Q1: Why does this error dialog box pop up when starting up the TP-LINK 802.1X Client Software?



A1: It's because the supported DLL file is missing. You are suggested to go to <http://www.winpcap.org> to download WinPcap 4.0.2 or the higher version for installation, and run the client software again.

Q2: Is this TP-LINK 802.1X Client Software compliable with the switches of the other manufacturers?

A2: No. This TP-LINK 802.1X Client Software is customized for TP-LINK switches.

Q3: Is it safe to set the password being automatically saved?

A3: Yes. The password saved in the configuration files is encrypted.

[Return to CONTENTS](#)

Appendix D: Glossary

Boot Protocol (BOOTP)

BOOTP is used to provide bootup information for network devices, including IP address information, the address of the TFTP server that contains the devices system files, and the name of the boot file.

Class of Service (CoS)

CoS is supported by prioritizing packets based on the required level of service, and then placing them in the appropriate output queue. Data is transmitted from the queues using weighted round-robin service to enforce priority service and prevent blockage of lower-level queues. Priority may be set according to the port default, the packet's priority bit (in the VLAN tag), TCP/UDP port number, or DSCP priority bit.

Differentiated Services Code Point (DSCP)

DSCP uses a six-bit tag to provide for up to 64 different forwarding behaviors. Based on network policies, different kinds of traffic can be marked for different kinds of forwarding. The DSCP bits are mapped to the Class of Service categories, and then into the output queues.

Domain Name Service (DNS)

A system used for translating host names for network nodes into IP addresses.

Dynamic Host Control Protocol (DHCP)

Provides a framework for passing configuration information to hosts on a TCP/IP network. DHCP is based on the Bootstrap Protocol (BOOTP), adding the capability of automatic allocation of reusable network addresses and additional configuration options.

Extensible Authentication Protocol over LAN (EAPOL)

EAPOL is a client authentication protocol used by this switch to verify the network access rights for any device that is plugged into the switch. A user name and password is requested by the switch, and then passed to an authentication server (e.g., RADIUS) for verification. EAPOL is implemented as part of the IEEE 802.1X Port Authentication standard.

IEEE 802.1D

Specifies a general method for the operation of MAC bridges, including the Spanning Tree Protocol.

IEEE 802.1Q

VLAN Tagging—Defines Ethernet frame tags which carry VLAN information. It allows switches to assign endstations to different virtual LANs, and defines a standard way for VLANs to communicate across switched networks.

IEEE 802.1p

An IEEE standard for providing quality of service (QoS) in Ethernet networks. The standard uses packet tags that define up to eight traffic classes and allows switches to transmit packets based on the tagged priority value.

IEEE 802.3ac

Defines frame extensions for VLAN tagging.

IEEE 802.3x

Defines Ethernet frame start/stop requests and timers used for flow control on full-duplex links. (Now incorporated in IEEE 802.3-2002)

Internet Group Management Protocol (IGMP)

A protocol through which hosts can register with their local router for multicast services. If there is more than one multicast switch/router on a given subnetwork, one of the devices is made the “querier” and assumes responsibility for keeping track of group membership.

IGMP Snooping

Listening to IGMP Query and IGMP Report packets transferred between IP Multicast routers and IP Multicast host groups to identify IP Multicast group members.

IGMP Query

On each subnetwork, one IGMP-capable device will act as the querier — that is, the device that asks all hosts to report on the IP multicast groups they wish to join or to which they already belong. The elected querier will be the device with the lowest IP address in the subnetwork.

IP Multicast Filtering

It is a feature to allow or deny the Client to add the specified multicast group.

Multicast Switching

A process whereby the switch filters incoming multicast frames for services for which no attached host has registered, or forwards them to all ports contained within the designated multicast group.

Layer 2

Data Link layer in the ISO 7-Layer Data Communications Protocol. This is related directly to the hardware interface for network devices and passes on traffic based on MAC addresses.

Link Aggregation

See Port Trunk.

Management Information Base (MIB)

An acronym for Management Information Base. It is a set of database objects that contains information about a specific device.

MD5 Message-Digest Algorithm

An algorithm that is used to create digital signatures. It is intended for use with 32 bit machines and is safer than the MD4 algorithm, which has been broken. MD5 is a one-way hash function, meaning that it takes a message and converts it into a fixed string of digits, also called a message digest.

Network Time Protocol (NTP)

NTP provides the mechanisms to synchronize time across the network. The time servers operate in a hierarchical-master-slave configuration in order to synchronize local clocks within the subnet and to national time standards via wire or radio.

Port Mirroring

A method whereby data on a target port is mirrored to a monitor port for troubleshooting with a logic analyzer or RMON probe. This allows data on the target port to be studied unobstructively.

Port Trunk

Defines a network link aggregation and trunking method which specifies how to create a single high-speed logical link that combines several lower-speed physical links.

Remote Authentication Dial-in User Service (RADIUS)

RADIUS is a logon authentication protocol that uses software running on a central server to control access to RADIUS-compliant devices on the network.

Remote Monitoring (RMON)

RMON provides comprehensive network monitoring capabilities. It eliminates the polling required in standard SNMP, and can set alarms on a variety of traffic conditions, including specific error types.

Rapid Spanning Tree Protocol (RSTP)

RSTP reduces the convergence time for network topology changes to about 10% of that required by the older IEEE 802.1D STP standard.

Simple Network Management Protocol (SNMP)

The application protocol in the Internet suite of protocols which offers network management services.

Simple Network Time Protocol (SNTP)

SNTP allows a device to set its internal clock based on periodic updates from a Network Time Protocol (NTP) server. Updates can be requested from a specific NTP server, or can be received via broadcasts sent by NTP servers.

Spanning Tree Algorithm (STA)

A technology that checks your network for any loops. A loop can often occur in complicated or backup linked network systems. Spanning Tree detects and directs data along the shortest available path, maximizing the performance and efficiency of the network.

Telnet

Defines a remote communication facility for interfacing to a terminal device over TCP/IP.

Transmission Control Protocol/Internet Protocol (TCP/IP)

Protocol suite that includes TCP as the primary transport protocol, and IP as the network layer protocol.

Trivial File Transfer Protocol (TFTP)

A TCP/IP protocol commonly used for software downloads.

User Datagram Protocol (UDP)

UDP provides a datagram mode for packet-switched communications. It uses IP as the underlying transport mechanism to provide access to IP-like services. UDP packets are delivered just like IP packets – connection-less datagrams that may be discarded before reaching their targets. UDP is useful when TCP would be too complex, too slow, or just unnecessary.

Virtual LAN (VLAN)

A Virtual LAN is a collection of network nodes that share the same collision domain regardless of their physical location or connection point in the network. A VLAN serves as a logical workgroup with no physical barriers, and allows users to share information and resources as though located on the same LAN.

[Return to CONTENTS](#)