

## Quick Installation Guide

AC1750 Wireless Dual Band Gigabit ADSL2+ Modem Router (Annex B)

Please select the appropriate setup wizard.

**CD Setup Wizard**  
For Windows users only

**Web-based Quick Setup Wizard**  
For users unable to run the Resource CD

MODEL NO. Archer D7b 

## Package Contents

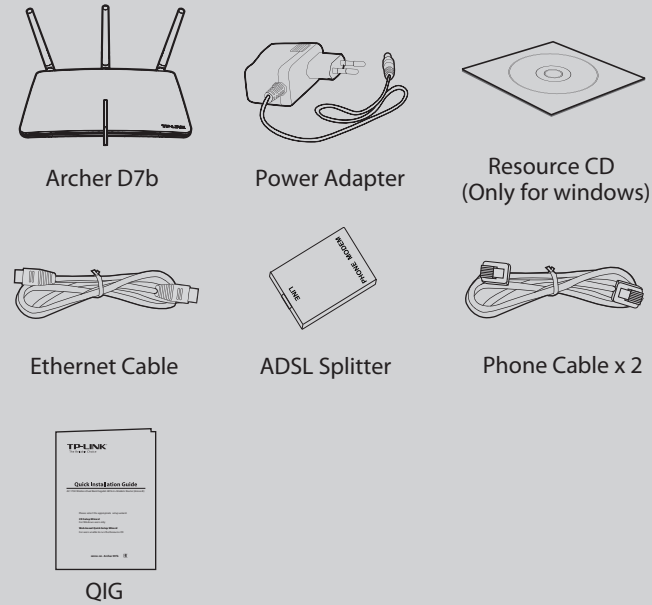

## Necessary Information

For a smoother setup, we suggest you consult your ISP for the following information first. The information will be necessary during the configuration stage.

VPI/VCI: \_\_\_\_\_ Connection Type: \_\_\_\_\_  
Encapsulation Type (Optional): \_\_\_\_\_

## CD Setup Wizard (For Windows users only)

**1** Insert the TP-LINK Resource CD into the CD-ROM drive.

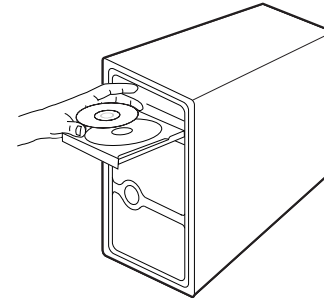

**2** Click **Start Setup**.



**3** Follow the pop-up flash video to connect your devices, then click  to continue.

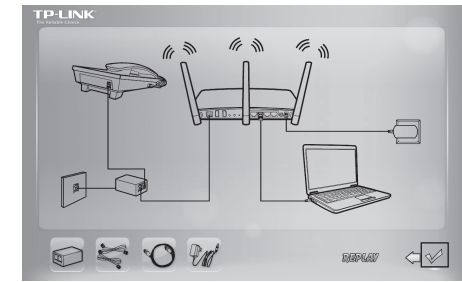

**4** Please check the LEDs (especially the ADSL LED). Then click **NEXT** and follow the step-by-step instructions until you complete the configuration.

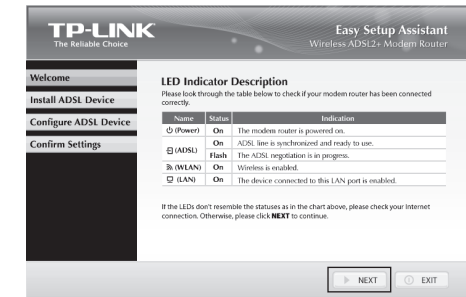

 For the advanced configurations, please refer to the User Guide on the Resource CD provided.

## Web-based Quick Setup Wizard (For users unable to run the Resource CD)

**1** Connect your devices step by step following the figure.

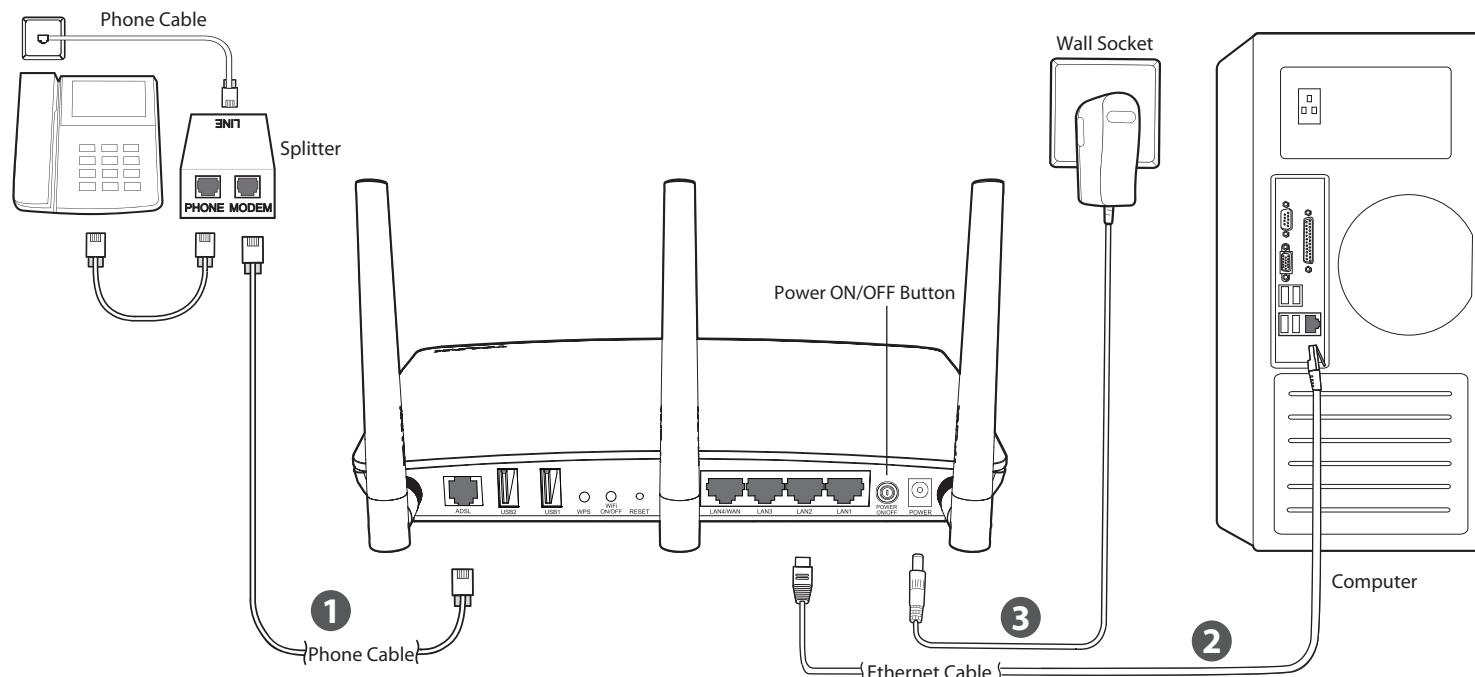

**2** Press the power **ON/OFF** button of your modem router and make sure the LEDs (especially the ADSL LED) display as shown below.

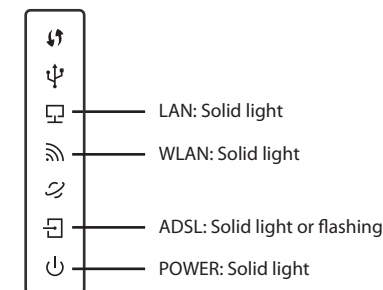

**3** Set your computer to **Obtain an IP address / DNS server address automatically**. For details, please refer to **T1 in Troubleshooting**.

**4** Open your browser and type in **http://tplinkmodem.net** in the address field, then press Enter. Create a new password and click **Save**, and then log into the Web-based management with the new password. Or click **Skip** and log in with the default password **admin**.

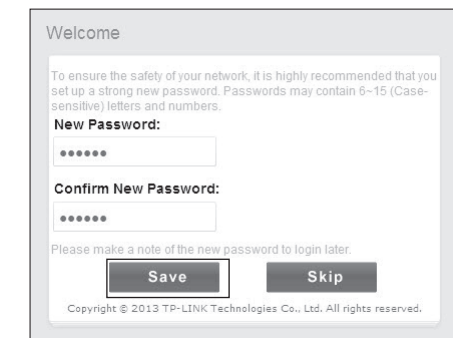

**5** Click **Quick Setup** in the main menu and then click **Next** to start the configuration.

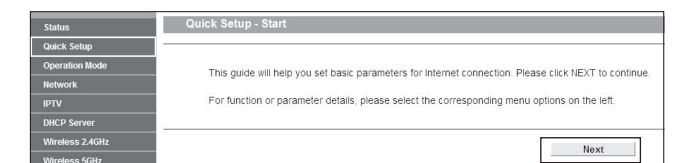

# Web-based Quick Setup Wizard (For users unable to run the Resource CD)

- 6 Select your **Region** and **Time Zone** from the drop-down list, and then click **Next**.

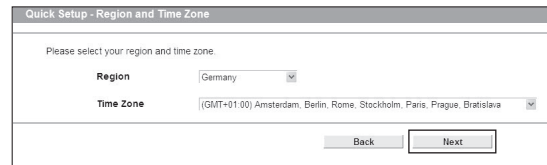

- 7 Select **Yes** to auto detect your connection type and then click **Next** to continue.

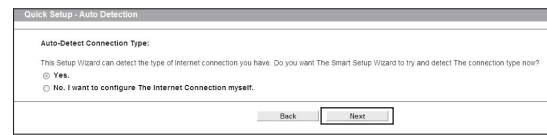

**Note** If the connection type can not be detected, please select **No...** to configure it manually.

- 8 Here we use **PPPoE** as an example. Enter the **Username** and **Password** provided by your ISP and then click **Next**.

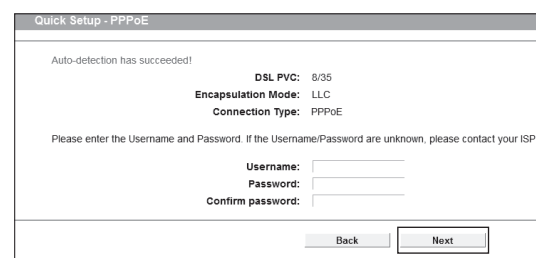

Record this information here:  
Username: \_\_\_\_\_  
Password: \_\_\_\_\_

- 9 You can rename your 2.4GHz wireless network and create your own password in this page. The default wireless name is TP-LINK\_2.4GHz\_XXXXXX; and the default wireless password, the same as the PIN code, is printed on the bottom label. Click **Next** to continue.



- 10 You can rename your 5GHz wireless network and create your own password in this page. The default wireless name is TP-LINK\_5GHz\_XXXXXX; and the default wireless password, the same as the PIN code, is printed on the bottom label. Click **Next** to continue.

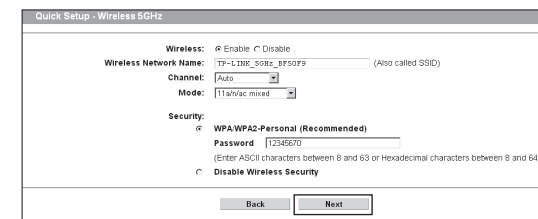

Record your wireless information here:  
2.4GHz SSID: \_\_\_\_\_  
2.4GHz Security Password: \_\_\_\_\_  
5GHz SSID: \_\_\_\_\_  
5GHz Security Password: \_\_\_\_\_

- 11 Please confirm all the parameters. Click **Back** to modify them or click **Save** to save your settings.

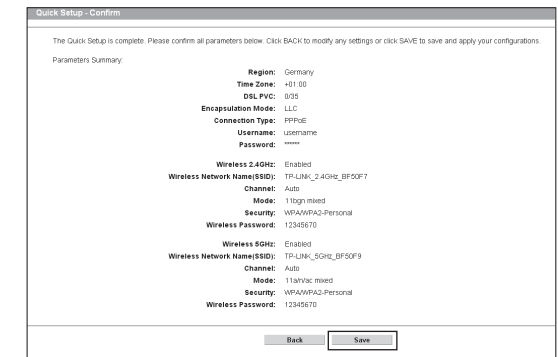

- 12 Quick Setup has completed. Click **Finish** to make your settings take effect.

The basic settings for your modem router are completed. Please open the web browser and try to log on to <http://www.tp-link.com> to test your Internet connection.

**Note** For the advanced configurations, please refer to the User Guide at <http://www.tp-link.com>.

## Troubleshooting

### T1. How can I set my computer to Obtain an IP address / DNS server address automatically?

#### For Mac OS X

- 1) Click the **Apple** icon on the upper left corner of the screen.
- 2) Go to **System Preferences -> Network**.
- 3) Select **Airport** on the left menu bar, and then click **Advanced** for wireless configuration; or select **Ethernet** for wired configuration.
- 4) In the **Configure IPv4** box under **TCP/IP**, select **Using DHCP**.
- 5) Click **Apply** to save the settings.

#### For Windows 7

- 1) Click **Start -> Control Panel -> Network and Internet -> View network status -> Change adapter settings**.
- 2) Right-click **Wireless Network Connection** (or Local Area Connection), and then click **Properties**.
- 3) Select **Internet Protocol Version 4 (TCP/IPv4)**, and then click **Properties**.
- 4) Select **Obtain an IP address automatically and Obtain DNS server address automatically**. Then click **OK**.

#### For Windows XP

- 1) Click **Start -> Control Panel -> Network and Internet Connections -> Network Connections**.
- 2) Right-click **Wireless Network Connection** (or Local Area Connection), and then click **Properties**.
- 3) Select **Internet Protocol (TCP/IP)**, and then click **Properties**.
- 4) Select **Obtain an IP address automatically and Obtain DNS server address automatically**. Then click **OK**.

#### For Windows 8

- 1) Move your mouse to the lower right corner and click the **Search** icon in the Popups.

- 2) Go to **Apps**, type **Control Panel** in the search box and press **Enter**.
- 3) Go to **Control Panel -> View network status and tasks > Change adapter settings**.
- 4) Right-click **Ethernet**, select **Properties**. Then double-click **Internet Protocol Version 4 (TCP/IPv4)**.
- 5) Select **Obtain an IP address automatically and Obtain DNS server address automatically**. Then click **OK**.

### T2. What can I do if I cannot access the Internet?

- 1) Check your cables and make sure they are all plugged in correctly, including the telephone line, Ethernet cables and power adapter.
- 2) Check to see if you can log on to the Web-based management page of the modem router. The default address of the Web-based management page is <http://tplinkmodem.net>. If you can, try the following steps. (If you can not, please refer to **T1** to configure TCP/IP Properties and then try to access the Internet again.)
- 3) Consult your ISP and make sure all the VPI/VCI, Connection Type, account username and password are correct. If they are not, please replace them with the correct settings and try again.
- 4) If you still cannot access the Internet, please restore your modem router to its factory default settings and reconfigure your modem router following the instructions in this QIG.
- 5) Please contact our Technical Support if the problem still exists.

### T3. How can I restore my modem router's configuration to its factory default settings?

Once the modem router is reset, the current settings will be lost and you will need to reconfigure the modem router. We strongly suggest you back up

the current settings before resetting the modem router. For more Backup information, please refer to 4.2.3.6 Backup & Restore on User Guide.

With the modem router powered on, use a pin to press and hold the **RESET** button on the rear panel for 8 to 10 seconds before releasing it.

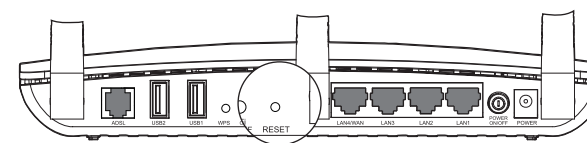

### T4. What can I do if I forget my password?

- 1) For default wireless password: Please refer to the "Wireless Password/PIN" labeled on the bottom of the modem router.
- 2) For the web management page password: Reset the modem router first and then use the default user name and password: **admin/admin**.

### T5. How can I configure the USB features?

Please refer to our Application Guides. They can be found on the resource CD, or on the web.

- 1) CD Access: Open the "Application Guide" folder on the Resource CD. The guides can be found inside this folder.
- 2) Web Access: <http://www.tp-link.com/app/usb>

**Note** For more details about Troubleshooting and Technical Support contact information, please log on to our Technical Support website: <http://www.tp-link.com/en/support>



## Technical Support

- For more troubleshooting help, go to <http://www.tp-link.com/en/support/faq>
- To download the latest Firmware, Driver, Utility and User Guide, go to <http://www.tp-link.com/en/support/download>
- For all other technical support, please contact us by using the following details:
  - Global**  
Tel: +86 755 2650 4400  
Fee: Depending on rate of different carriers, IDD.  
E-mail: [support@tp-link.com](mailto:support@tp-link.com)  
Service time: 24hrs, 7 days a week
  - USA / Canada**  
Toll Free: +1 866 225 8139  
E-mail: [support.usa@tp-link.com](mailto:support.usa@tp-link.com) (USA)  
[support.ca@tp-link.com](mailto:support.ca@tp-link.com) (Canada)  
Service time: 24hrs, 7 days a week
  - UK**  
Tel: +44 (0) 845 147 0017  
Fee: Landline: 1p-10.5p/min, depending on the time of day. Mobile: 15p-40p/min, depending on your mobile network.  
E-mail: [support.uk@tp-link.com](mailto:support.uk@tp-link.com)  
Service time: 24hrs, 7 days a week
  - Turkey**  
Tel: 0850 7244 488 (Turkish Service)  
Fee: Depending on rate of different carriers.  
E-mail: [support.tr@tp-link.com](mailto:support.tr@tp-link.com)  
Service time: 09:00 to 21:00, 7 days a week
  - Brazil**  
Toll Free: 0800 608 9799 (Portuguese Service)  
E-mail: [supporte.br@tp-link.com](mailto:supporte.br@tp-link.com)  
Service time: Monday to Friday, 09:00 to 20:00; Saturday, 09:00 to 15:00
  - Italy**  
Tel: +39 023 051 9020  
Fee: Depending on rate of different carriers.  
E-mail: [support.it@tp-link.com](mailto:support.it@tp-link.com)  
Service time: Monday to Friday, 09:00 to 13:00; 14:00 to 18:00
  - Indonesia**  
Tel: (+62) 021 6386 1936  
Fee: Depending on rate of different carriers.  
E-mail: [support.id@tp-link.com](mailto:support.id@tp-link.com)  
Service time: Monday to Friday, 09:00 to 18:00  
\*Except public holidays
  - Germany / Austria**  
Tel: +49 1805 875 465 (German Service)  
+49 1805 TPLINK  
+43 820 820 360  
Fee: Landline from Germany: 0.14EUR/min. Landline from Austria: 0.20EUR/min.  
E-mail: [support.de@tp-link.com](mailto:support.de@tp-link.com)  
Service Time: Monday to Friday, 09:00 to 12:30 and 1:30 to 18:00. GMT+1 or GMT+2 (DST in Germany)  
\* Except bank holidays in Hesse
  - Australia / New Zealand**  
Tel: NZ 0800 87 5465 (Toll Free)  
AU 1300 87 5465 (Depending on 1300 policy).  
E-mail: [support.au@tp-link.com](mailto:support.au@tp-link.com) (Australia)  
[support.nz@tp-link.com](mailto:support.nz@tp-link.com) (New Zealand)  
Service time: 24hrs, 7 days a week
  - Singapore**  
Tel: +65 6284 0493  
Fee: Depending on rate of different carriers.  
E-mail: [support.sg@tp-link.com](mailto:support.sg@tp-link.com)  
Service time: 24hrs, 7 days a week
  - Ukraine**  
Tel: 0800 505 508  
Fee: Free for Landline; Mobile: Depending on rate of different carriers  
E-mail: [support.ua@tp-link.com](mailto:support.ua@tp-link.com)  
Service time: Monday to Friday, 10:00 to 22:00
  - Malaysia**  
Toll Free: 1300 88 875 465  
E-mail: [support.my@tp-link.com](mailto:support.my@tp-link.com)  
Service time: 24hrs, 7 days a week
  - Poland**  
Tel: +48 (0) 801 080 618  
+48 223 606 363 (if calls from mobile phone)  
Fee: Depending on rate of different carriers.  
E-mail: [support.pl@tp-link.com](mailto:support.pl@tp-link.com)  
Service time: Monday to Friday, 09:00 to 17:00. GMT+1 or GMT+2 (DST)
  - Switzerland**  
Tel: +41 (0)848 800 998 (German Service)  
Fee: 4-8 Rp/min, depending on rate of different time  
E-mail: [support.ch@tp-link.com](mailto:support.ch@tp-link.com)  
Service time: Monday to Friday, 09:00 to 12:30 and 13:30 to 18:00. GMT+ 1 or GMT+ 2 (DST)
  - France**  
Tel: 0820 800 860 (French Service)  
Fee: 0.118 EUR/min from France  
Email: [support.fr@tp-link.com](mailto:support.fr@tp-link.com)  
Service time: Monday to Friday, 09:00 to 18:00  
\*Except French Bank holidays
  - Russian Federation**  
Tel: 8 (499) 754 5560 (Moscow NO.)  
8 (800) 250 5560 (Toll-free within RF)  
E-mail: [support.ru@tp-link.com](mailto:support.ru@tp-link.com)  
Service time: From 09:00 to 21:00 (Moscow time)  
\*Except weekends and holidays in RF