

Installation Guide

Load Balance Broadband Router
TL-R480T+

COPYRIGHT & TRADEMARKS

Specifications are subject to change without notice. **TP-LINK®** is a registered trademark of TP-LINK TECHNOLOGIES CO., LTD. Other brands and product names are trademarks of their respective holders.

No part of the specifications may be reproduced in any form or by any means or used to make any derivative such as translation, transformation, or adaptation without permission from TP-LINK TECHNOLOGIES CO., LTD. Copyright © 2013 TP-LINK TECHNOLOGIES CO., LTD. All rights reserved.

<http://www.tp-link.com>

FCC STATEMENT



This equipment has been tested and found to comply with the limits for a Class A digital device, pursuant to part 15 of the FCC Rules. These limits are designed to provide reasonable protection against harmful interference when the equipment is operated in a commercial environment. This equipment generates, uses, and can radiate radio frequency energy and, if not installed and used in accordance with the instruction manual, may cause harmful interference to radio communications. Operation of this equipment in a residential area is likely to cause harmful interference in which case the user will be required to correct the interference at his own expense.

This device complies with part 15 of the FCC Rules. Operation is subject to the following two conditions:

- 1) This device may not cause harmful interference.
- 2) This device must accept any interference received, including interference that may cause undesired operation.

Any changes or modifications not expressly approved by the party responsible for compliance could void the user's authority to operate the equipment.

CE Mark Warning



This is a class A product. In a domestic environment, this product may cause radio interference, in which case the user may be required to take adequate measures.

Related Document

The User Guide of this product is provided in the resource CD. To obtain the latest product information, please visit the Official Website:

<http://www.tp-link.com>

About this Installation Guide

This Installation Guide describes the hardware characteristics, installation methods and the points that should be attended to during installation. This Installation Guide is structured as follows:

Chapter 1 Introduction. This chapter describes the External Components of the router.

Chapter 2 Installation. This chapter illustrates how to install the router.

Chapter 3 Lightning Protection. This chapter illustrates how to prevent lightning damage.

Chapter 4 Connection. This chapter illustrates how to do the physical connection of the router.

Chapter 5 Configuration. This chapter illustrates how to login and set up the router.

Appendix A Troubleshooting.

Appendix B Hardware Specifications.

Appendix C Technical Support.

Audience



This Installation Guide is for:

Network Engineer

Network Administrator

Conventions

This Guide uses the specific formats to highlight special messages. The following table lists the notice icons that are used throughout this guide.

	Remind to be careful. A caution indicates a potential which may result in device damage.
	Remind to take notice. The note contains the helpful information for a better use of the product.

Contents

Chapter 1	Introduction	01
1.1	Product Overview	01
1.2	Appearance	01
Chapter 2	Installation	03
2.1	Package Contents	03
2.2	Safety Precautions	03
2.3	Installation Tools	05
2.4	Product Installation	06
Chapter 3	Lightning Protection	08
3.1	Cabling Reasonably	08
3.2	Connect to Ground	10
3.3	Equipotential Bonding	11
3.4	Use Lightning Arrester	12
Chapter 4	Connection	14
4.1	WAN Port	14
4.2	LAN Port	14
4.3	Console Port	14
4.4	Verify Installation	15
4.5	Power On	15
4.6	Initialization	15
Chapter 5	Configuration	16
5.1	Preparations	16
5.2	Login	16
Appendix A	Troubleshooting	20
Appendix B	Hardware Specifications	21
Appendix C	Technical Support	22

Chapter 1 Introduction

1.1 Product Overview

TL-R480T+ is a product designed for small business. It features three free changeable ports that can be set to either LAN or WAN, allowing the router to support up to four WAN ports to satisfy various Internet access requirements through one device. At the same time, network traffic is managed to ensure that data is properly distributed to each port. TP-LINK TL-R480T+ will provide you consistent network uptime and reliable Ethernet connectivity.

1.2 Appearance

■ Front Panel

The front panel of TL-R480T+ is shown as the following figure.

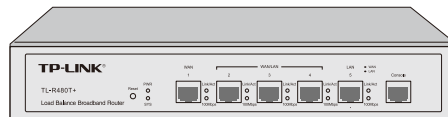

Figure 1-1 Front Panel

LEDs

LED	Status	Indication
PWR	On	The router is powered on
	Off	The router is powered off or power supply is abnormal
SYS	Flashing	The router works properly
	On/Off	The router works improperly
Link/Act	On (Green/Yellow)	There is a device linked to the corresponding port but not active (Green indicates the corresponding port is working as a LAN port, and yellow indicates WAN port)
	Flashing (Green/Yellow)	The corresponding port is transmitting or receiving data (Green indicates the corresponding port is working as a LAN port, and yellow indicates WAN port)
	Off	There is no device linked to the corresponding port
100Mbps	On (Green/Yellow)	The linked device is running at 100Mbps (Green indicates the corresponding port is working as a LAN port, and yellow indicates WAN port)
	Off	There is no device linked to the corresponding port or the port is running at 10Mbps

Interface Description

Interface	Description
WAN	The WAN port is designed to connect the router to the interface provided by ISP via the RJ45 cable
LAN	The LAN port is designed to connect the router to the local PCs or switches by the RJ45 cable
Console	The Console port is designed to connect with the serial port of a computer or terminal to check and monitor some simple system information of the router

Reset

With the router powered on, use a pin to press and hold the Reset button (about 5 seconds) until the SYS LED flashes quickly. Then release the button and wait for the router rebooting to its factory default settings.

■ Rear Panel

The rear panel of TL-R480T+ is shown as the following figure.

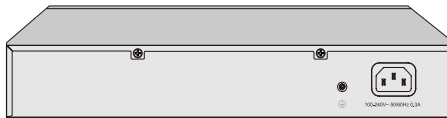

Figure 1-2 Rear Panel

Power Socket

Connect the female connector of the power cord here, and the male connector to the AC power outlet. Please make sure the voltage of the power supply meets the requirement of the input voltage.

Grounding Terminal

The router already comes with lightning protection mechanism. You can also ground the router through the PE (Protecting Earth) cable of AC cord or with Ground Cable. For detailed information, please refer to **Chapter 3 Lightning Protection**.



Caution: Please use the provided power cord.

Chapter 2 Installation

2.1 Package Contents

Make sure that the package contains the following items. If any of the listed items is damaged or missing, please contact your distributor.

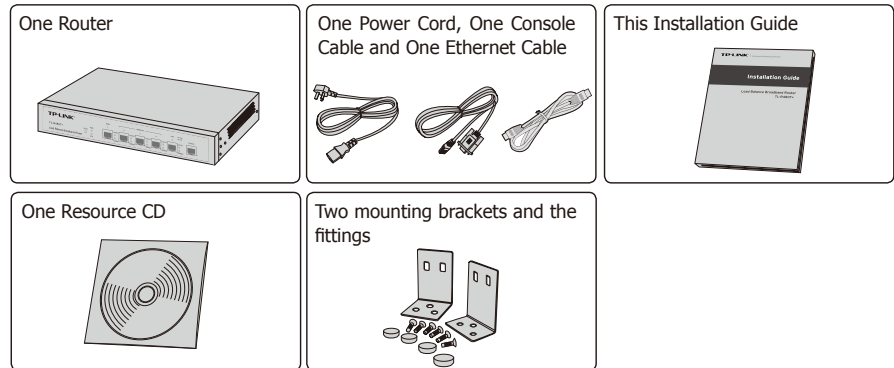

2.2 Safety Precautions

To avoid any device damage and bodily injury caused by improper use, please observe the following rules.

■ Safety Precautions

- Keep the power off during the installation.
- Wear an ESD-preventive wrist strap, and make sure that the wrist strap has a good skin contact and is well grounded.
- Use only the power cord provided with the router.
- Make sure that the supply voltage matches the specifications indicated on the rear panel of the router.
- Ensure the vent hole is well ventilated and unblocked.
- Do not open or remove the cover of the router.
- Before cleaning the device, cut off the power supply. Do not clean it by the waterish cloth, and never use any other liquid cleaning method.

■ Site Requirements

Temperature/Humidity



Please keep a proper temperature and humidity in the equipment room. Too high/low humidity may lead to bad insulation, electricity leakage, mechanical property changes and corrosions. Too high temperature may accelerate aging of the insulation materials and can thus significantly shorten the service life of the device. For normal temperature and humidity of the device, please check the following table.

Environment	Temperature	Humidity
Operating	0°C ~ 40°C	10% ~ 90%RH Non-condensing
Storage	-40°C ~ 70°C	5% ~ 90%RH Non-condensing

Cleanness



The dust accumulated on the router can be absorbed by static electricity and result in poor contact of metal contact points. Some measures have been taken for the device to prevent static electricity, but too strong static electricity can cause deadly damage to the electronic elements on the internal circuit board. To avoid the effect of static electricity on the operation of the router, please attach much importance to the following items:

- Dust the device regularly, and keep the indoor air clean.
- Keep the device well grounded and ensure static electricity has been transferred.

Electromagnetic Interference



Electronic elements including capacitance and inductance on the device can be affected by external interferences, such as conducted emission by capacitance coupling, inductance coupling, and impedance coupling. To decrease the interferences, please make sure to take the following measures:

- Use the power supply that can effectively filter interference from the power grid.
- Keep the device far from high-frequency, strong-current devices, such as radio transmitting station.
- Use electromagnetic shielding when necessary.

Lightning Protection



Extremely high voltage currents can be produced instantly when lightning occurs and the air in the electric discharge path can be instantly heated up to 20,000°C. As this instant current is strong enough to damage electronic devices, more effective lightning protection measures should be taken.

- Ensure the rack and device are well earthed.
- Make sure the power socket has a good contact with the ground.
- Keep a reasonable cabling system and avoid induced lightning.
- Use the signal SPD (Surge Protective Device) when wiring outdoor.



Note: For detailed lightning protection measures, please refer to **Chapter 3 Lightning Protection**.

Installation Site

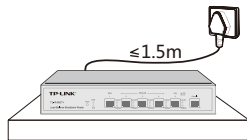

When installing the device on a rack or a flat workbench, please note the following items:

- The rack or workbench is flat and stable, and sturdy enough to support the weight of 5.5kg at least.
- The rack or workbench has a good ventilation system. The equipment room is well ventilated.
- The rack is well grounded. Keep the power socket less than 1.5 meters away from the device.

2.3 Installation Tools

- Phillips screwdriver
- ESD-preventive wrist wrap
- Cables



Note: These tools are not provided with our product. If needed, please self purchase them.

2.4 Product Installation

■ Desktop Installation

To install the device on the desktop, please follow the steps:

1. Set the device on a flat surface strong enough to support the entire weight of the device with all fittings.
2. Remove the adhesive backing papers from the rubber feet.
3. Turnover the device and attach the supplied rubber feet to the recessed areas on the bottom at each corner of the device.

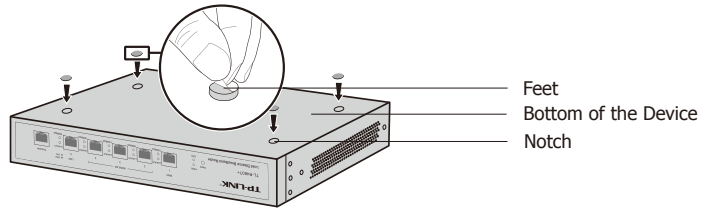

Figure 2-1 Desktop Installation

■ Rack Installation

To install the device in an EIA standard-sized, 19-inch rack, follow the instructions described below:

1. Check the grounding and stability of the rack.
2. Secure the supplied rack-mounting brackets to each side of the device with supplied screws, as illustrated in the following figure.

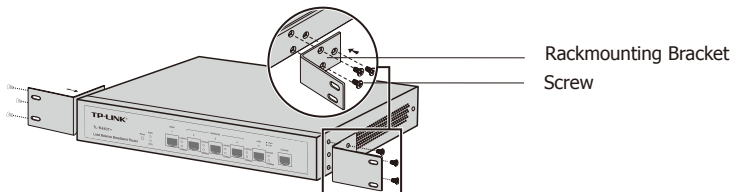

Figure 2-2 Bracket Installation

3. After the brackets are attached to the device, use suitable screws (not provided) to secure the brackets to the rack, as illustrated in the following figure.

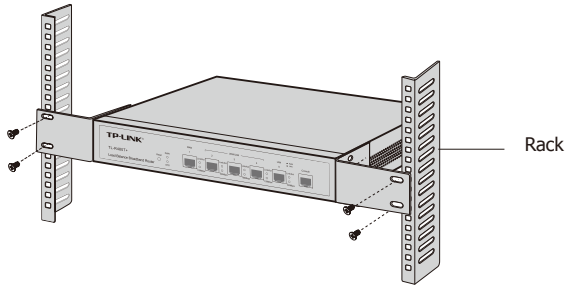

Figure 2-3 Rack Installation



Caution:

- Please set 5~10cm gaps around the device for air circulation.
- Please avoid any heavy thing placed on the device.
- Please mount devices in sequence from the bottom to top of the rack and ensure a certain clearance between devices for the purpose of heat dissipation.

Chapter 3 Lightning Protection

3.1 Cabling Reasonably

In the actual network environment, you may need cable outdoors and indoors, and the requirements for cabling outdoors and indoors are different. A reasonable cabling system can decrease the damage of induced lightning to devices.



Note: It's not recommended using Ethernet cables outdoors. When cabling outdoors, please use a signal lightning arrester.

■ Requirements for Cabling Outdoors

- Aerial cabling without safeguard is not allowed.

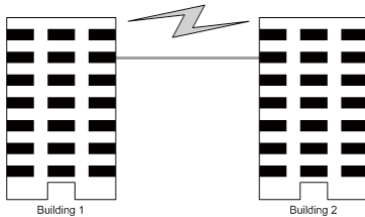

- It's not allowed cabling down the building to connect network devices in different floors.



- Outdoor cables should be buried and paved to the indoor through basement. A piece of steel wire should be paved underground along the pipe and connected to the lightning protection terminal of the building for shielding. Before connecting the cable to the device, install a signal lightning arrester on the corresponding port.
- When an aerial cable is set up, the cable should be through a metal pipe (15m long at least) before coming into the building. The two ends of this metal pipe should be grounded. Before connecting the cable to the device, install a signal lightning arrester on the corresponding port.
- It's not necessary to pave STP cables through pipes. The shielded layer of STP cable should be well grounded. Before connecting the cable to the device, install a signal lightning arrester on the corresponding port.

■ Requirements for Cabling Indoors

When cabling indoors, keep a certain distance away from the devices that may cause high-frequency interferences, such as down-conductor cable, powerline, power transformer and electromotor.

- The main cable should be paved in the metal raceway of the access shaft. When cabling, keep the loop area formed by the cable itself as small as possible.
- Requirements for the distance between Ethernet cable and other pipelines are shown in the table.

Other Pipelines	Ethernet Cable	
	Min Parallel Net Length L (mm)	Min Parallel-overlapping Net Height H (mm)
Down-conductor	1000	300
PE	50	20
Service pipe	150	20
Compressed air pipe	150	20
Thermal pipe (not wrapped)	500	500
Thermal pipe (wrapped)	300	300
Gas pipe	300	20

The two diagrams below demonstrate parallel net length and parallel-overlapping net height.

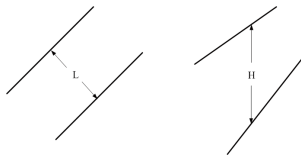

Note: The above minimum net length/height is required when metal raceway is not used. If any requirements cannot be met, you can add a steel tube or metal raceway for shielding.

- Requirements for the distance between Ethernet cable and high-power electric devices are in following tables.

Cable	Pave Way	Min Parallel Length (mm)
<2kVA powerline	Parallel cabling	130
	One is in the grounded metal raceway or metal pipe	70
	The both are in the grounded metal raceway or metal pipe	10

2~5kVA powerline	Parallel cabling	300
	One is in the grounded metal raceway or metal pipe	150
	The both are in the grounded metal raceway or metal pipe	80
>5kVA powerline	Parallel cabling	600
	One is in the grounded metal raceway or metal pipe	300
	The both are in the grounded metal raceway or metal pipe	150

Device	Min Distance (m)
Switch case	1.00
Transformer room	2.00
Elevator tower	2.00
Air-conditioner room	2.00

3.2 Connect to Ground

Connecting the device to ground is to quickly release the lightning over-voltage and over-current of the device, which is also a necessary measure to protect the body from electric shock.

In different environments, the device may be grounded differently. The following will instruct you to connect the device to the ground in two ways, connecting to the grounding bar or connecting to the ground via the power cord. Please connect the device to ground in the optimum way according to your specific operation environment.

■ Connecting to the Grounding Bar

If the device is installed in the Equipment Room, where a grounding bar is available, you are recommended to connect the device to the grounding bar as shown in the following figure.

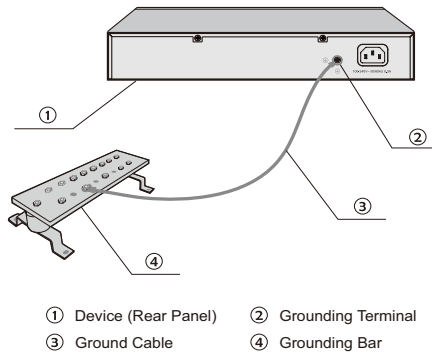

Figure 3-1 Connecting to the Grounding Bar



Note: The grounding bar and the ground cable are not provided with our product. If needed, please self purchase them.

■ Connecting to the Ground via the Power Supply

If the device is installed in the normal environment, the device can be grounded via the PE (Protecting Earth) cable of the AC power supply as shown in the following figure.

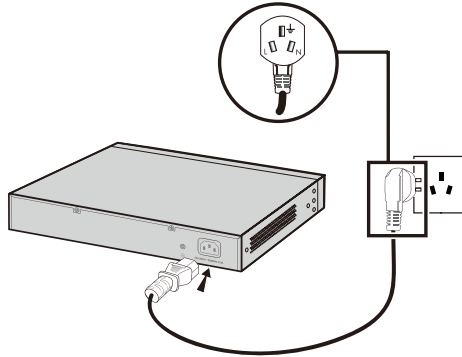

Figure 3-2 Connecting to the Ground



Note:

- The figure is to illustrate the application and principle. The power plug you get from the package and the socket in your situation will comply with the regulation in your country, so they may differ from the figure above.
- If you intend to connect the device to the ground via the PE (Protecting Earth) cable of AC power cord, please make sure the PE (Protecting Earth) cable in the electrical outlet is well grounded in advance.

3.3 Equipotential Bonding

Equipotential Bonding is the practice of intentionally electrically connecting all earthed systems to the same grounding grid or connecting the grounding grids of all the earthed systems together through the ground or overground metal so as to create an earthed equipotential zone. When lightning occurs, the high voltage produced by lightning current in all systems will meanwhile exist in their ground cables, and thus all ground cables have the same electrical potential and basically eliminate the electric strikes between the systems.

The figure bellow illustrates how to practice equipotential bonding in a network.

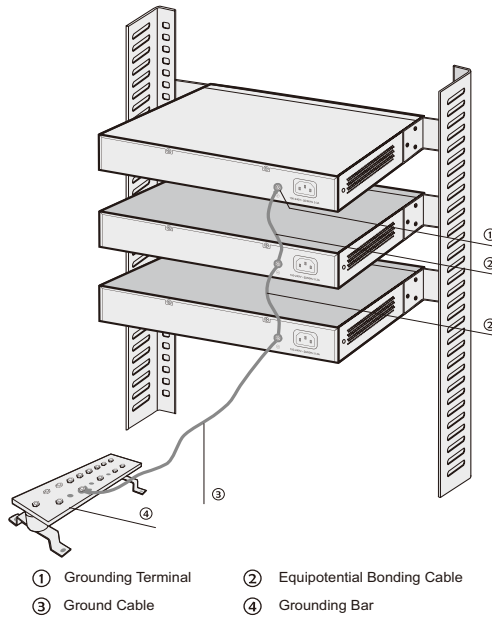

Figure 3-3 Equipotential Bonding

When equipotential bonding, please note that the cable should be copper wrapped Kelly with its area being 6mm^2 at least. The shorter cable the better, and use a grounding bar to establish an equipotential bonding point.



Note: The equipotential bonding cable is not provided with our product. If needed, please self purchase it.

3.4 Use Lightning Arrester

Power lightning arrester and signal lightning arrester are used for lighting protection.

Power lightning arrester is used for limiting the voltage surge due to a lightning. If an outdoor AC power cord should be directly connected to the device, please use a power lightning arrester.



Note: Power lightning arrester is not provided with our product. If needed, please self purchase it.

Signal lightning arrester is used to protect RJ45 ports of the device from lightning. When cabling outdoors, please install a signal lightning arrester before connecting the cable to the device.

When purchasing or using a signal lightning arrester, please observe the following rules:

- The port rate of the signal lightning arrester should match the rate of the desired port on the device. If it is not matched, this signal lightning arrester will not work. Purchase a standard lightning arrester.
- Install signal lightning arrester near the protected device and connect it to the ground via a shorter ground cable.

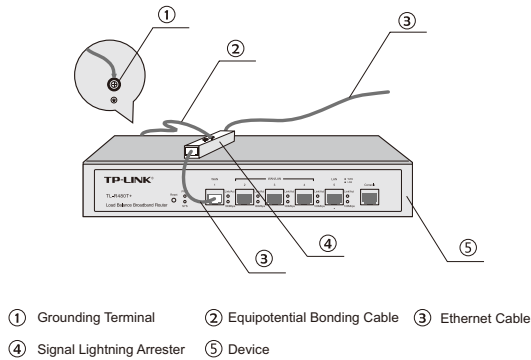

Figure 3-4 Equipotential Bonding



Note: Signal lightning arrester is not provided with our product. If needed, please self purchase it.

Chapter 4 Connection

4.1 WAN Port

Please connect the WAN port of the router to the interface provided by ISP via Ethernet cable.

4.2 LAN Port

Connect a LAN port of the router to the computer by RJ45 cable as the following figure shown.

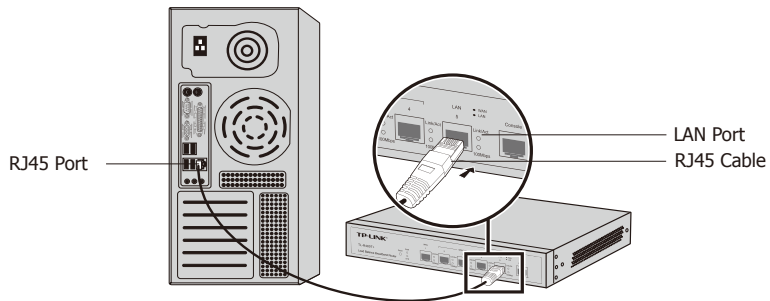

Figure 4-1 Connecting the LAN Port

4.3 Console Port

CLI (Command Line Interface) enables you to do some simple operations to the router, thus you can load the CLI after connecting the PCs or Terminals to the console port on the router via the provided cable. For TL-R480T+, you can check and monitor some simple system information of the router.

Connect the console port of the device with your computer by the console cable as the following figure shown.

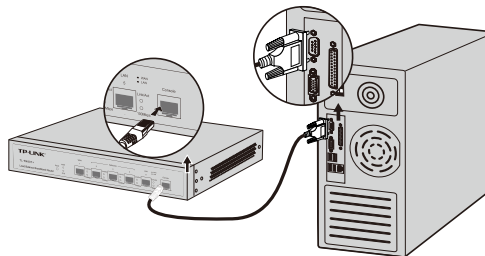

Figure 4-2 Connecting the Console Port

**Note:**

- The console port is the first port on the right of the front panel.
- Please keep the device power off when you plugging the console cable.
- Do not connect the console port with other ports by RJ45 cable.

4.4 Verify Installation

After completing the installation, please verify the following items:

- There are 5~10cm of clearance around the sides of the device for ventilation and the air flow is adequate.
- The voltage of the power supply meets the requirement of the input voltage of the device.
- The power socket, device and rack are well grounded.
- The device is correctly connected to other network devices.

4.5 Power On

Plug in the negative connector of the provided power cord into the power socket of the device, and the positive connector into a power outlet as the following figure shown.

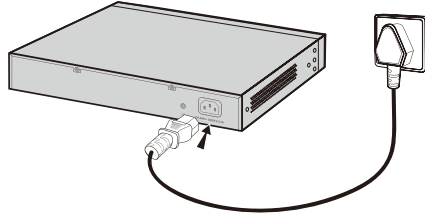

Figure 4-3 Connecting to Power Supply



Note: The figure is to illustrate the application and principle. The power plug you get from the package and the socket in your situation will comply with the regulation in your country, so they may differ from the figure above.

4.6 Initialization

After the device is powered on, it begins the Power-On Self-Test. A series of tests run automatically to ensure the device functions properly. During this time, its LED indicators will respond as follows:

- The Power LED lights on all the time.
- All LEDs except PWR LED flashes momentarily and then turns off.
- The SYS LED flashes every second continuously, which means the initialization is finished.

Chapter 5 Configuration

5.1 Preparations

1. Connect a PC to a LAN port of the router with a RJ45 cable properly.
2. Set the Internet Protocol (TCP/IP) properties of the PC with the "IP address" as 192.168.0.x ("x" is any number from 2 to 254), "Subnetmask" as 255.255.255.0 and "Default gateway" as 192.168.0.1. Shown in the following figure.

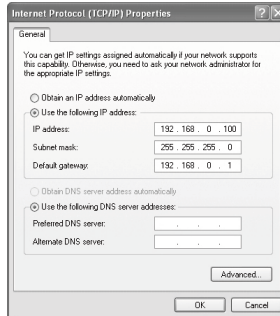

Figure 5-1 Internet Protocol (TCP/IP) Properties

5.2 Login

1. To access the GUI (Graphical User Interface) of the router, open a web browser and type the default management address <http://192.168.0.1> in the address field of the browser, then press the Enter key.

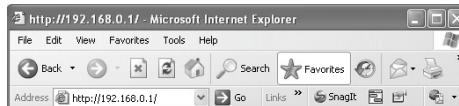

Figure 5-2 Web Browser

2. Enter "admin" for the default User name and Password, both in lower case letters. Then click the Login button or press the Enter key.



Copyright © 2012 TP-LINK TECHNOLOGIES CO., LTD. All Rights Reserved.

Figure 5-3 Login

3. After a successful login, the **Quick Setup** screen will pop up as the Figure 5-4 shown. If it does not prompt, you can click the **Quick Setup** on the left of the main menu. Then click **Next**.

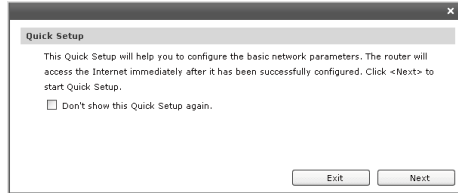

Figure 5-4 Quick Setup

4. Select the total number of WAN ports you prefer to use as the Figure 5-5 shown. Then click **Next** to load the **WAN Port** screen.

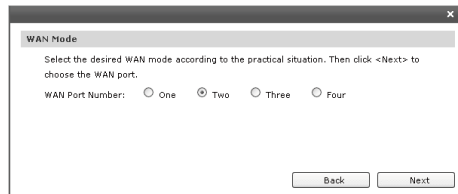

Figure 5-5 WAN Mode

5. Select the WAN port you want to use as the Figure 5-6 shown, and then click **Next** to load the **WAN Connection Type** screen.

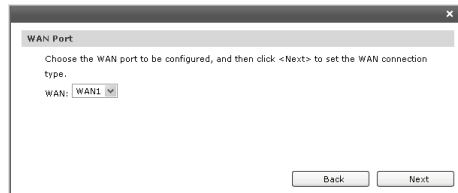

Figure 5-6 WAN Port

6. Select the connection type provided by your ISP (Internet Service Provider) as the Figure 5-7 shown. Three popular types are provided here. For other connection types, please refer to the **Network**→**WAN**.



Figure 5-7 WAN Connection Type

- 1)If you choose PPPoE, you will see the screen as the Figure 5-8 shown. Enter the Account Name and Password provided by your ISP.



Figure 5-8 WAN Connection Type - PPPoE

Click **Next** to dial up, and the process will take a few minutes. The process of configuring the network parameters is shown as Figure 5-9. If you close the screen during the process, the configuration will still be continued in the background.

These fields are case sensitive. If you have difficulty in this process, please contact your ISP.



Figure 5-9 WAN Connection Type – PPPoE Connecting

2)If your ISP assigns the IP address automatically, please choose the Dynamic IP connection type to obtain the parameters for WAN port automatically. The process for obtain the parameter may take a few minutes as Figure 5-10 shown. If you close the screen during the process, the configuration will still be continued in the background.

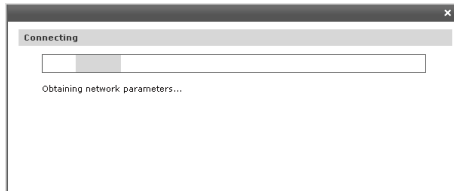

Figure 5-10 WAN Connection Type - Dynamic IP

3)If you choose Static IP, you should enter the detailed IP information provided by your ISP in Figure 5-11.

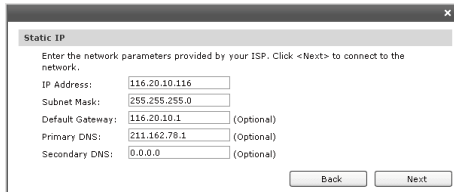

Figure 5-11 WAN Connection Type - Static IP

Then click **Next**. The process for configuring the network parameters is shown as Figure 5-12. If you close the screen during the process, the configuration will still be continued in the background.

If you have difficulty in this process, please contact your ISP.



Figure 5-12 WAN Connection Type - Static IP Connecting

7. After that, you will see the next screen. Click **Finish** to complete the quick installation or click **Continue** to configure other WAN ports.



Figure 5-13 Configuration Completed

8. After a successful login, the main page will appear as the following figure, and you can configure the function by clicking the setup menu on the left side of the screen.

TP-LINK

TL-R480T+

System Status

Device Info

Firmware Version: 5.0.0 Build 20120131 Rel.30950s
Hardware Version: TL-R480T+ v5.0

System Time

System Time: 2012-02-10 00:06:03 Wednesday
Running Time: 4 Min, 8 Sec

WAN

WAN1	Link Up	WAN2	Link Down
Primary Connection: Static IP	Dynamic IP	Primary Connection: Dynamic IP	Dynamic IP
Status: Connected	Dynamic IP	Status: Connecting...	Dynamic IP
IP Address: 116.20.10.116	0.0.0.0	IP Address: 0.0.0.0	0.0.0.0
Subnet Mask: 255.255.255.0	0.0.0.0	Subnet Mask: 0.0.0.0	0.0.0.0
Gateway: 116.20.10.1	0.0.0.0	Gateway: 0.0.0.0	0.0.0.0
MAC Address: 40-16-9F-61-BA-E9	40-16-9F-61-BA-E9	MAC Address: 40-16-9F-61-BA-EA	40-16-9F-61-BA-EA
Secondary Connection:	Secondary Connection:
Status:	Status:
IP Address:	IP Address:
Subnet Mask:	Subnet Mask:

WAN3 N/A

Primary Connection: Dynamic IP

Status: Disabled

IP Address: 0.0.0.0

Subnet Mask: 0.0.0.0

Gateway: 0.0.0.0

MAC Address: 40-16-9F-61-BA-EB

Secondary Connection: ...

Status: ...

IP Address: ...

Subnet Mask: ...

WAN4 N/A

Primary Connection: Dynamic IP

Status: Disabled

IP Address: 0.0.0.0

Subnet Mask: 0.0.0.0

Gateway: 0.0.0.0

MAC Address: 40-16-9F-61-BA-EC

Secondary Connection: ...

Status: ...

IP Address: ...

Subnet Mask: ...

LAN

Interface	IP Address	Subnet Mask	DHCP Server	MAC Address
LAN	192.168.0.1	255.255.255.0	Enabled	40-16-9F-61-BA-E8

CPU Usage

Core	Usage
Core0	1%

Copyright © 2012 TP-LINK TECHNOLOGIES CO., LTD. All Rights Reserved.

Refresh

Figure 5-14 Main Page of the Router

Appendix A Troubleshooting

Q1. What could I do if I forgot the username and password of the router?

You can restore the router to factory defaults, please refer to **1.2 Appearance** of this Installation Guide for detail. The default management address of the router is `http://192.168.0.1`, default username and password are both `admin`. All your current settings will be cleared after the router is restored. If you have backup configuration, please import it now.

Q2. Why does the PWR LED work abnormally?

The PWR LED should be lit up when the power system works normally. If the PWR LED worked abnormally, please check as follows:

1. Make sure that the power cable is connected properly, and the power contact is normal.
2. Make sure the voltage of the power supply meets the requirement of the input voltage of the router.

Q3. What could I do if I could not access the web-based configuration page?

You are recommended to check the following items:

1. Check every port LED on the router and make sure the cable is installed properly.
2. Try another port on the router and make sure the cable meets the requirement and works normally.
3. Turn off the power. After a while, turn on the power again.
4. Make sure the IP address of your PC is set within the subnet of the router.
5. If you still cannot access the configuration page, please restore the router to its factory defaults. Then the IP address should be set as `192.168.0.x` ("x" is any number from 2 to 254) and Subnet Mask as `255.255.255.0`.

Q4. Why does the page display abnormally?

Please check as follows:

1. Update your browser or replace it with another browser, and try again.
2. If the pop-up is blocked, please lower the security level of the browser.

Appendix B Hardware Specifications

Item	Content
Standards and Protocol	IEEE 802.3, IEEE 802.3u, TCP/ IP, DHCP, ICMP, NAT, PPPoE, SNTP, HTTP, DNS
Transmission Medium	10Base-T: UTP/STP of Cat. 3 or above 100Base-TX: UTP/STP of Cat. 5 or above
LEDs	PWR, SYS, Link/Act, 100Mbps
Operating Temperature	0°C~40°C
Storage Temperature	-40°C~70°C
Operating Humidity	10%~90%RH Non-condensing
Storage Humidity	5%~90%RH Non-condensing
Size (L × W × H)	294mm × 180mm × 44mm

Appendix C Technical Support

- For more help, please go to: <http://www.tp-link.com/en/support/faq>
- To download the latest Firmware, Driver, Utility and User Guide, please go to: <http://www.tp-link.com/en/support/download>
- For all other technical support, please contact us by using the following details:

Global	Tel: +86 755 2650 4400 Fee: Depending on rate of different carriers, IDD. E-mail: support@tp-link.com Service time: 24hrs, 7 days a week
Singapore	Tel: +65 6284 0493 Fee: Depending on rate of different carriers. E-mail: support.sg@tp-link.com Service time: 24hrs, 7 days a week
UK	Tel: +44 (0) 845 147 0017 Fee: Landline: 1p-10.5p/min, depending on the time of day. Mobile: 15p-40p/min, depending on your mobile network. E-mail: support.uk@tp-link.com Service time: 24hrs, 7 days a week
USA/Canada	Toll Free: +1 866 225 8139 E-mail: support.usa@tp-link.com (USA) support.ca@tp-link.com (Canada) Service time: 24hrs, 7 days a week
Australia/New Zealand	Tel: NZ 0800 87 5465 (Toll Free) AU 1300 87 5465 (Depending on 1300 policy.) E-mail: support.au@tp-link.com (Australia) support.nz@tp-link.com (New Zealand) Service time: 24hrs, 7 days a week
Malaysia	Toll Free: 1300 88 875 465 Email: support.my@tp-link.com Service time: 24hrs, 7 days a week
Turkey	Tel: 0850 7244 488 (Turkish Service) Fee: Depending on rate of different carriers. E-mail: support.tr@tp-link.com Service time: 09:00 to 21:00, 7 days a week
Italy	Tel: +39 023 051 9020 Fee: Depending on rate of different carriers. E-mail: support.it@tp-link.com Service time: Monday to Friday, 09:00 to 13:00; 14:00 to 18:00
Ukraine	Tel: 0800 505 508 Fee: Free for Landline; Mobile: Depending on rate of different carriers E-mail: support.ua@tp-link.com Service time: Monday to Friday, 10:00 to 22:00
Brazil	Toll Free: 0800 608 9799 (Portuguese Service) E-mail: suporte.br@tp-link.com Service time: Monday to Friday, 09:00 to 20:00; Saturday, 09:00 to 15:00

Poland	<p>Tel: +48 (0) 801 080 618 +48 223 606 363 (if calls from mobile phone) Fee: Depending on rate of different carriers. E-mail: support.pl@tp-link.com Service time: Monday to Friday, 09:00 to 17:00. GMT+1 or GMT+2 (DST)</p>
France	<p>Tel: 0820 800 860 (French service) Fee: 0.118 EUR/min from France Email: support.fr@tp-link.com Service time: Monday to Friday, 09:00 to 18:00 *Except French Bank holidays</p>
Russian Federation	<p>Tel: 8 (499) 754 5560 (Moscow NO.) 8 (800) 250 5560 (Toll-free within RF) E-mail: support.ru@tp-link.com Service time: From 09:00 to 21:00 (Moscow time) *Except weekends and holidays in RF</p>
Indonesia	<p>Tel: (+62) 021 6386 1936 Fee: Depending on rate of different carriers. E-mail: support.id@tp-link.com Service time: Sunday to Friday, 09:00 to 12:00, 13:00 to 18:00 *Except public holidays</p>
Germany/Austria	<p>Tel: +49 1805 875 465 (German Service) +49 1805 TPLINK +43 820 820 360 Fee: Landline from Germany: 0.14EUR/min. Landline from Austria: 0.20EUR/min. E-mail: support.de@tp-link.com Service time: Monday to Friday, 09:00 to 12:30 and 13:30 to 18:00. GMT+1 or GMT+2 (DST in Germany) *Except bank holidays in Hesse</p>
Switzerland	<p>Tel: +41 (0) 848 800 998 (German Service) Fee: 4-8 Rp/min, depending on rate of different time. E-mail: support.ch@tp-link.com Service time: Monday to Friday, 09:00 to 12:30 and 13:30 to 18:00. GMT+1 or GMT+2 (DST)</p>

TP-LINK[®]
The Reliable Choice

Website: <http://www.tp-link.com> E-mail: support@tp-link.com

7106504438 REV3.0.0