

TABLE OF CONTENTS

COPYRIGHT	3
1. INTRODUCTION.....	4
PRODUCT OVERVIEW	4
COMPONENTS AND FEATURES	4
HARDWARE INSTALLATION.....	5
NETWORK ENVIRONMENT.....	6
WIRED NETWORK WITH PRINT SERVER:.....	6
2. PRINT SERVER INSTALLATION	7
PREPARATION.....	7
CONFIGURATION SOLUTION TABLE	7
3. SOFTWARE INSTALLATION.....	9
INSTALLING THE PSADMIN AND PRINT SERVER'S DRIVER	9
USING PSADMIN.....	18
WIZARD.....	19
MANUAL SETUP	21
REFRESH.....	23
MULTIPLE PRINT QUEUES CONFIGURATION	24
UNINSTALLING THE PSADMIN ON WINDOWS PC.....	24
4. INTERNET PRINTER CONNECTION AND HP WEB JETADMIN	26
IPP OVERVIEW	26
HP WEB JETADMIN OVERVIEW.....	28
INSTALLING HP WEB JETADMIN.....	29
REMOVING HP WEB JETADMIN UTILITY	29
5. CONFIGURATION FROM EMBEDDED WEB SERVER.....	30
OVERVIEW.....	30
USING EMBEDDED WEB SERVER	30
SETUP MENU	37
INSTALLING PRINT SERVER ON NETWARE 4.x/5.x.....	42
SETTING UP A MACINTOSH COMPUTER	44
6. NETWORK PRINT MONITOR	48
PREPARATION.....	48
TCP/IP PROTOCOL INSTALLATION.....	49
IPX/SPX-COMPATIBLE PROTOCOL INSTALLATION	49
NETBEUI PROTOCOL INSTALLATION	50
WINDOWS 95/98/ME/NT/2000/XP/2003 MANUAL INSTALLATION PROCEDURE.....	50
UNINSTALLING NETWORK PRINT PORT ON WINDOWS 95/98/ME/NT/2000/XP/2003	52
7. TCP/IP LPR PORT PRINTING INSTALLATION	53
BASIC TCP/IP INSTALLATION OVERVIEW	53
ASSIGNING AN IP ADDRESS.....	53
WINDOWS NT LPR PORT PRINTING INSTALLATION	53
WINDOWS 2000/XP/2003 STANDARD TCP/IP PORT PRINTING INSTALLATION	55
UNIX INSTALLATION	58

8. UPGRADING PRINT SERVER	63
OVERVIEW.....	63
UPGRADING THE PRINT SERVER FROM PSADMIN	63
UPGRADING THE PRINT SERVER FROM WINDOWS NT/2000/XP/2003 (THROUGH TCP/IP).....	63
UPGRADING THE PRINT SERVER FROM UNIX (THROUGH TCP/IP).....	64
UPGRADING THE PRINT SERVER FROM BROWSER	64
9. TROUBLESHOOTING	66
GENERAL TROUBLESHOOTING OVERVIEW.....	66
POWER RELATED PROBLEMS.....	66
PRINT PORT RELATED PROBLEMS.....	66
WINDOWS 95/98/ME/NT/2000/XP/2003 TROUBLESHOOTING	67
MOVING THE PRINT SERVER TO A NEW SEGMENT.....	68
MOVING YOUR COMPUTER TO A NEW SEGMENT	69
NOVELL NETWARE TROUBLESHOOTING	69
TCP/IP TROUBLESHOOTING	69
APPENDIX:.....	72
FREQUENTLY ASKED QUESTIONS	77
ADDITIONAL INSTALLATION INSTRUCTIONS	79

Trademarks

NetWare is a registered trademark of Novell Inc and Windows 95/98/Me and Windows NT/2000/XP/2003/Vista are registered trademarks of Microsoft Corp. All other brands and product names are trademarks of their respective companies.

Copyright

No part of this publication may be reproduced in any form or by any means or used to make any derivative (such as translation, transformation or adaptation) without the express written consent of the manufacturer as stipulated by the United States Copyright Act of 1976.

FCC Warning

This equipment has been tested and found to comply with the limits for a Class B digital device, pursuant to subpart J of Part 15 of the FCC Rules. These limits are designed to provide reasonable protection against harmful interference when the equipment is operated in a commercial environment. This equipment generates, uses, and can radiate radio frequency energy and, if not installed and used in accordance with the instruction manual, may cause harmful interference to radio communications. Operation of this equipment in a residential area is likely to cause harmful interference in which the user will be required to correct the interference at their own expense.

All contents are subject to change without prior notice.



Part No. PS110U-V1.0

1. Introduction

Product Overview

The external print servers enhance capability by letting you place your printers at convenient locations directly on the Ethernet network, and by increasing network printer performance and management. Please note that the print server does not support printing with host-based printers, e.g. CAPT, GDI, PPA.

Network Management

The print servers support the Simple Network Management Protocol (SNMP), which remote printer management and a warning. A standard SNMP agent is permanent on these print servers. Any standard SNMP-based application can be used to access and manage these print servers.

Network configuration

The print servers provide an embedded web server that can be accessed via a proper web browser. We also subsidiary Windows-based PSAdmin utility which help administrator to setup print server environment.

Components and Features

1-USB Port Print Server

- 1 USB2.0 port
- Fast Ethernet network port: RJ-45 for 10Base-T or 100Base-TX
- 1 LED to indicate Status(Orange), 2 LED's to indicate 10M(Orange) and 100M(Green) link lights
- 1 LED to indicate USB port: Green for USB2.0, Orange for USB1.1
- One Setup CD for Windows 95/98/Me/NT/2000/XP/2003, User's Guide
- One external AC power adapter
- One Quick Installation Guide
- Built-in Reset Button

LED Indicators

LED	State	Indication
Status	Blinking for POST (Orange)	When power switched on, the Status indicator will flash five times, and then on.
100Mbps	On (Green)	LAN Port has a valid network connection at 100Mbps.
10Mbps	On (Orange)	LAN Port has a valid network connection at 10Mbps.
USB	On (Green)	Connect with USB2.0 printer
	On (Orange)	Connect with USB1.1 printer

Before you start, you should prepare the following items:

- One Windows-based computer with print server setup CD
- One printer with a USB port
- One USB printer cable

Hardware Installation

To install the print servers, you need to complete these steps:

- Confirm that your printer USB port works well.
- Connect the print server to the network and printer, and plug in the print server.

Follow these instructions to install the print servers, please refer to any peripheral you are connecting to the print server:

1. Turn off the printer's power.
2. Connect the print server to your printer with the USB cable.
3. Turn the printer's power on.
4. Plug the AC power adapter into the power connector on the print server.
5. Wait 10 seconds until all the LEDs have stopped flashing.

Note: The **Status** LED should be flash **five** times when POST. If not, please contact your local dealer for repair or replacement.

Wall-mount Information

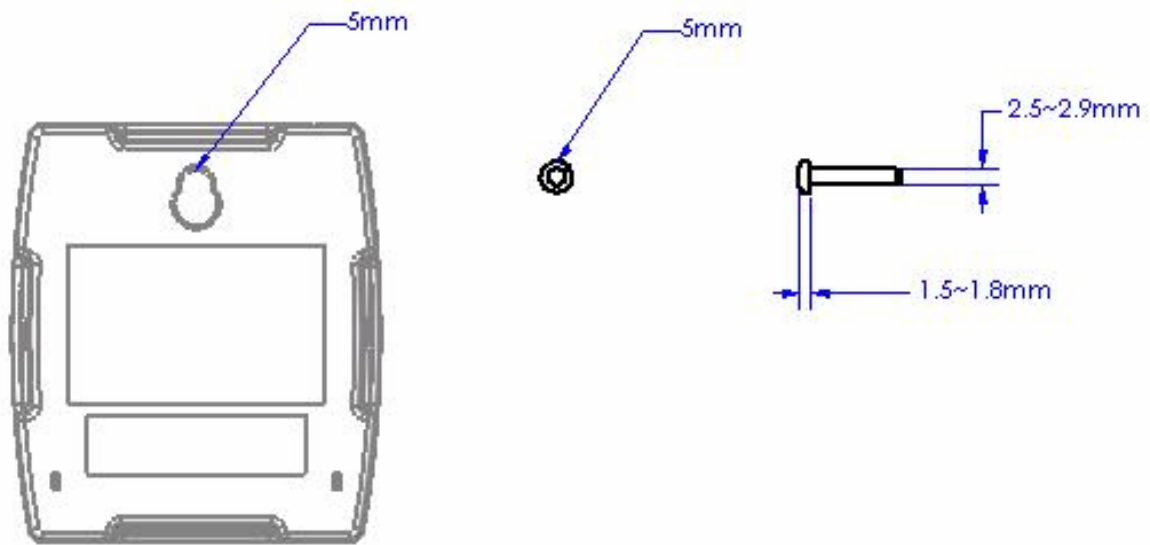

Note: We are not responsible for damages incurred by insecure wall-mounting hardware.

Network Environment

Wired Network with Print Server:

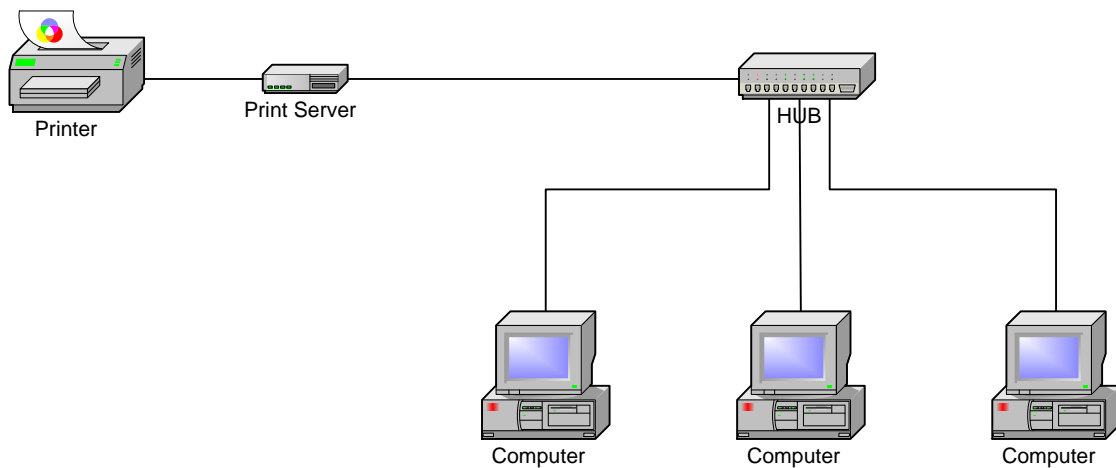

2. Print Server Installation

Preparation

To meet users' network printing needs in today's heterogeneous and multiple protocol networking environments, the print server supports industrial standard protocols, including TCP/IP, IPX/SPX, NetBEUI and AppleTalk. This means that the print server supports the most popular network operating systems today, including NetWare, Windows 95/98/Me/NT/2000/XP/2003, UNIX systems and Macintosh computer. As such, there might be several ways to deploy the print server on your network.

Supported Networks

Print server supports a variety of network protocols, including TCP/IP, IPX/SPX, NetBEUI and AppleTalk. In addition, we provide software for network configuration on the following networks:

- Novell NetWare 3.12, 4.x, 5.x (Bindery and NDS)
- Microsoft Windows 95/98/Me
- Microsoft Windows NT/2000/XP/2003
- Apple EtherTalk
- UNIX /Linux system
- Internet (via Internet Printer Connection software)

Configuration Solution Table

Setup Operating System	Function	Remarks
PSAdmin utility / Setup Wizard		
Windows 95/98/Me Windows NT/2000/XP/2003	Install a single network on a peer-to-peer or client-server network	Easy printer installation runs from print server setup CD
Embedded Web server		
Windows 95/98/Me Windows NT/2000/XP/2003 Mac OS, Linux...	Remote setup print server from private LAN	Follow standard browse, e.g. IE or Netscape
HP Web JetAdmin		
Windows	Remote	Print server solution for continual management of

NT/2000/XP/2003	management of print server, include alert and consumables	multiple printers- anywhere on your LAN
Internet Printing Protocol		
Windows NT/2000/XP/2003	Printing via the internet to Internet Printing Protocol-enabled print server	Allows saving distribution of HQ hardcopy document over Internet, replacing fax, mail

Comment

Configuration solution Table has many installations way to setup Windows 95/98/Me, Windows NT/2000/XP/2003, NetWare, UNIX / Linux system and Mac computer. Firstly, we introduce PSAdmin utility, HP Web JetAdmin program and Internet Printing Protocol solution. Then we will discuss Embedded Web Server Installation with print server.

3. Software Installation

The PSAdmin is a proprietary Windows-based management program that can assist you in configuring and managing your print server in NetWare environments. The program can be installed from the setup CD of print server.

Installing the PSAdmin and Print Server's Driver

1. To enable network communication with print server, your computer must have a proper IP address, e.g. 192.168.0.100 (the print server's default IP is 192.168.0.10)
2. Insert the setup CD into your CD-drive, and the following message appears:



3. Choose **Setup Wizard** to install the print server and configure the connected printer.

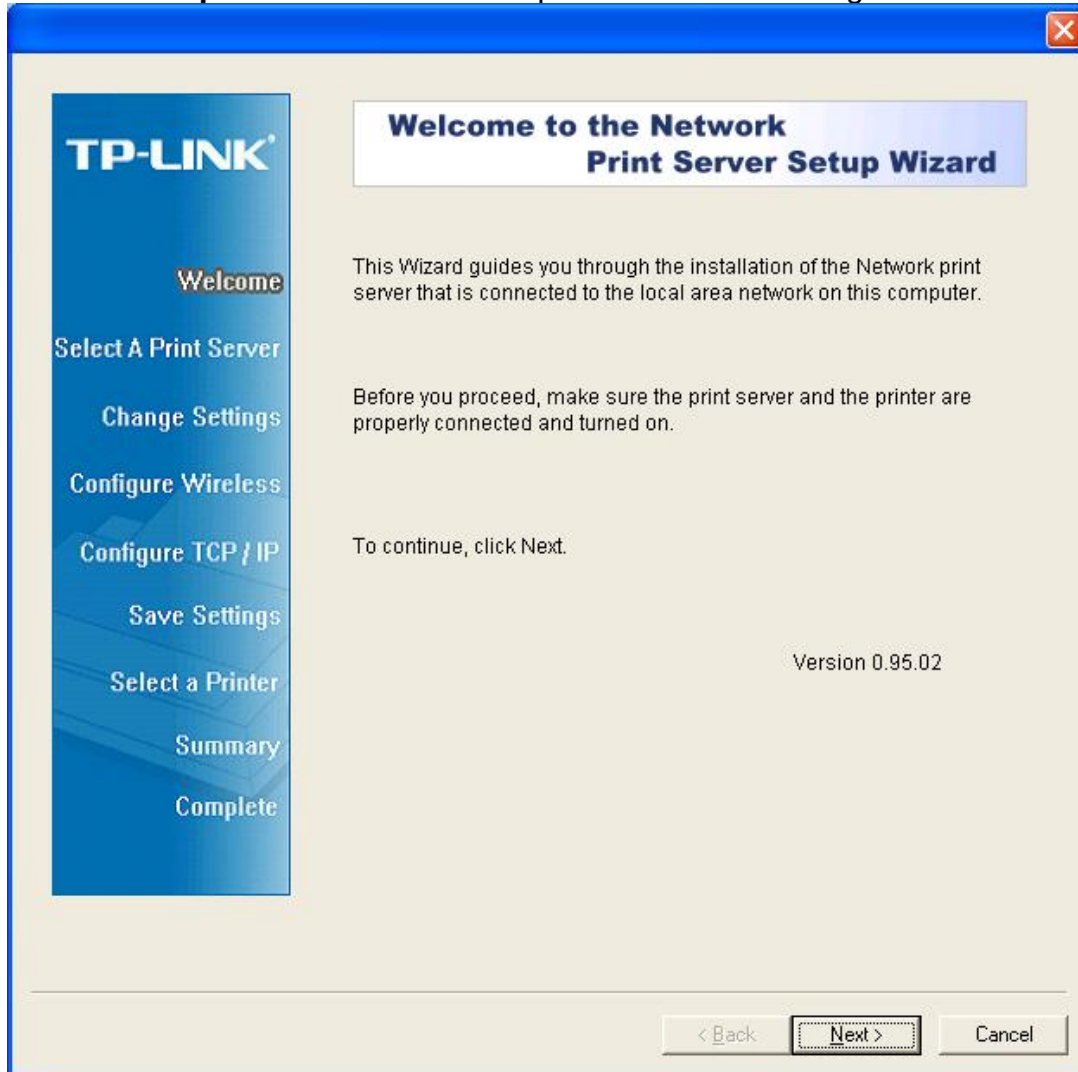

Note:

The setup CD will install the **print server's driver**, **PSAdmin** and **Setup Wizard** into your computer. The default installation directory will be **C:\Program files\Network Print Monitor**.

4. Click **Next**, the wizard will automatically discover the print server.
5. From the **Select A Print Sever** screen, select the print server that you want to configure and click **Next**.

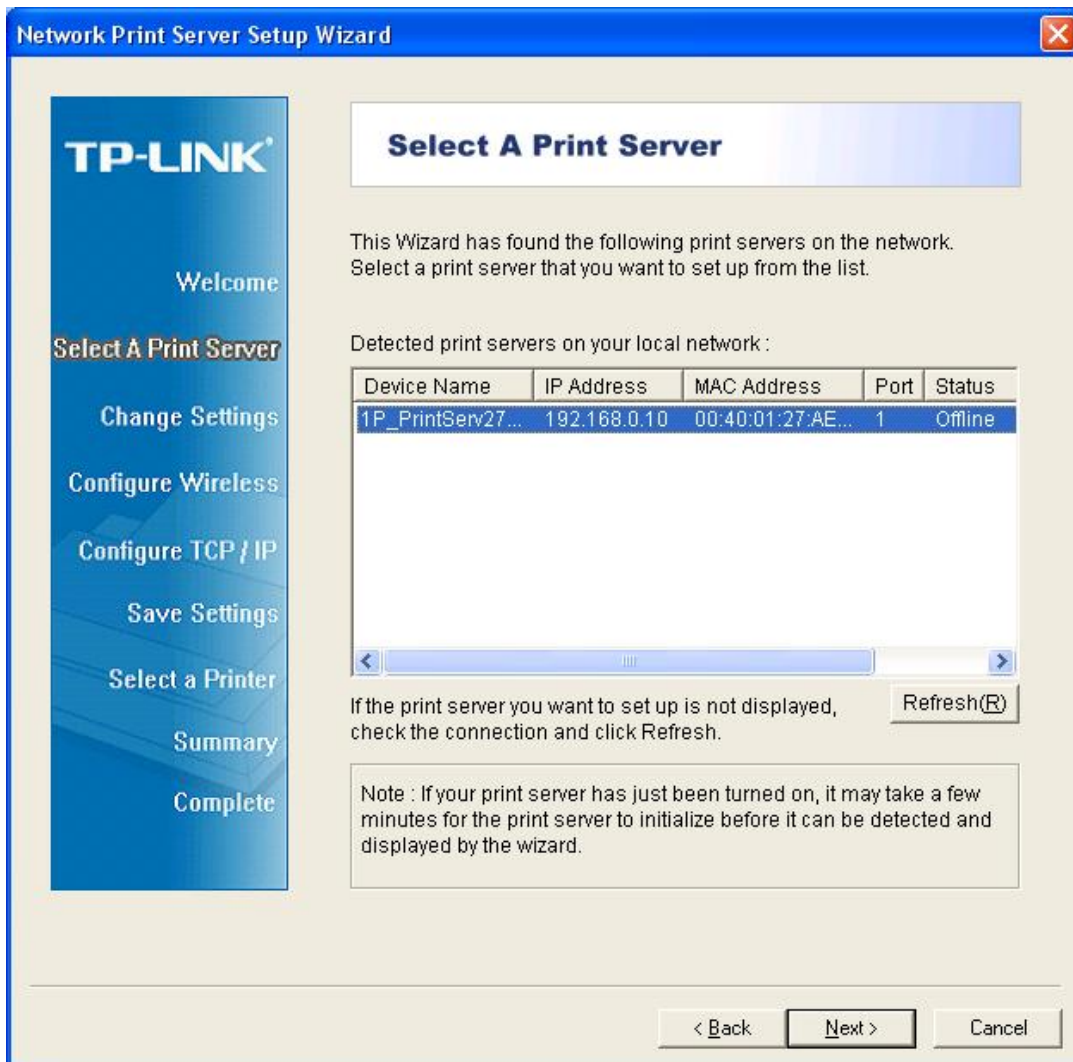

6. On the **Change Settings** screen, select **No** or **Yes**:

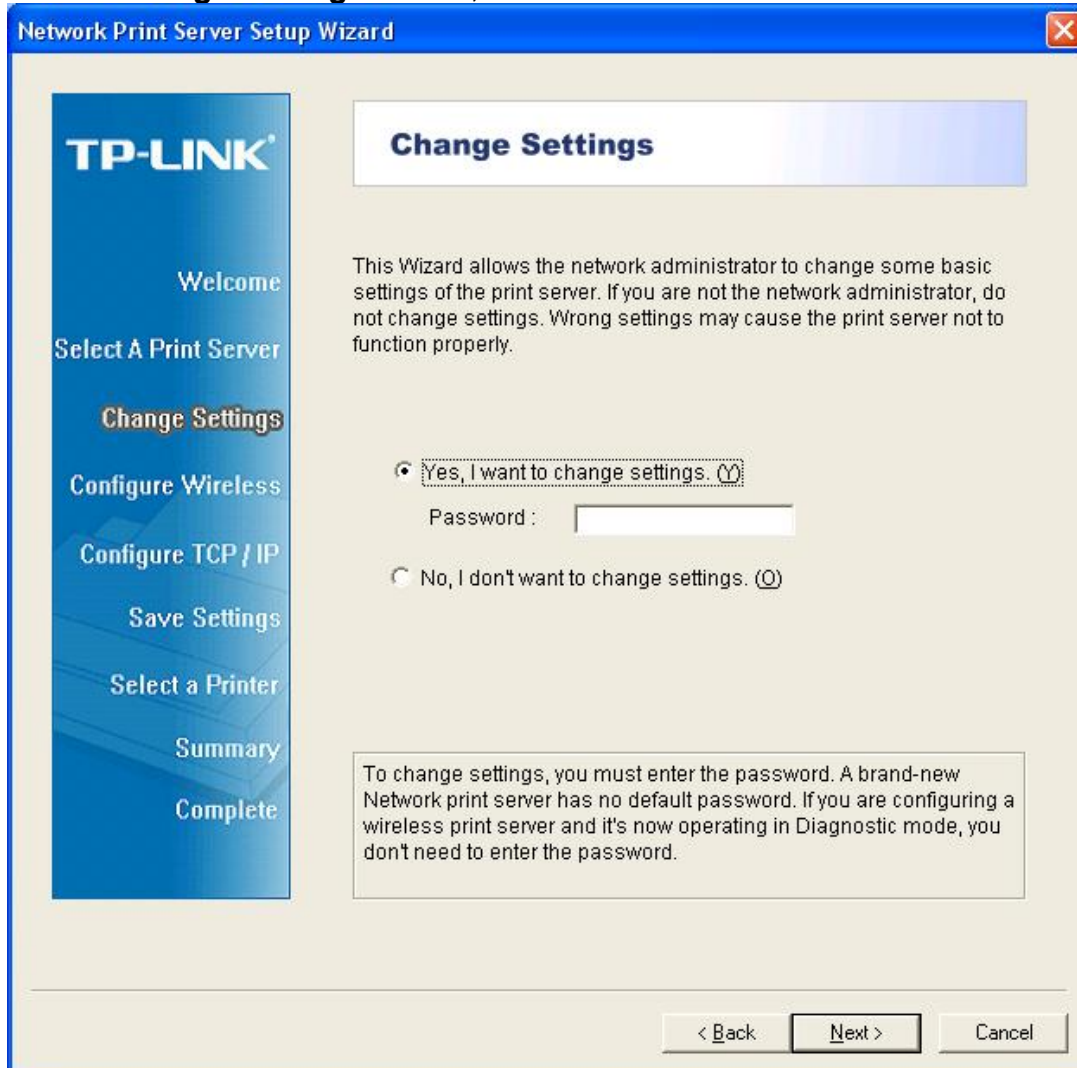

Click **No** if you want the print server to keep using the default IP address and keep the default settings:

- IP address: 192.168.0.10
- Subnet Mask: 255.255.255.0

Click **Yes** if you want change IP address to the print server, and then click **Next**.

Note:

The IP address of print server must be within the same subnet as your network adapter.

7. In the setup wizard, select an already configured printer from the list, click **Next**, **Next** and then **Finish** to complete the installation.
or

Select **Add New Printer** if the print server is connected to a printer that hasn't been installed before and does not appear in the list.

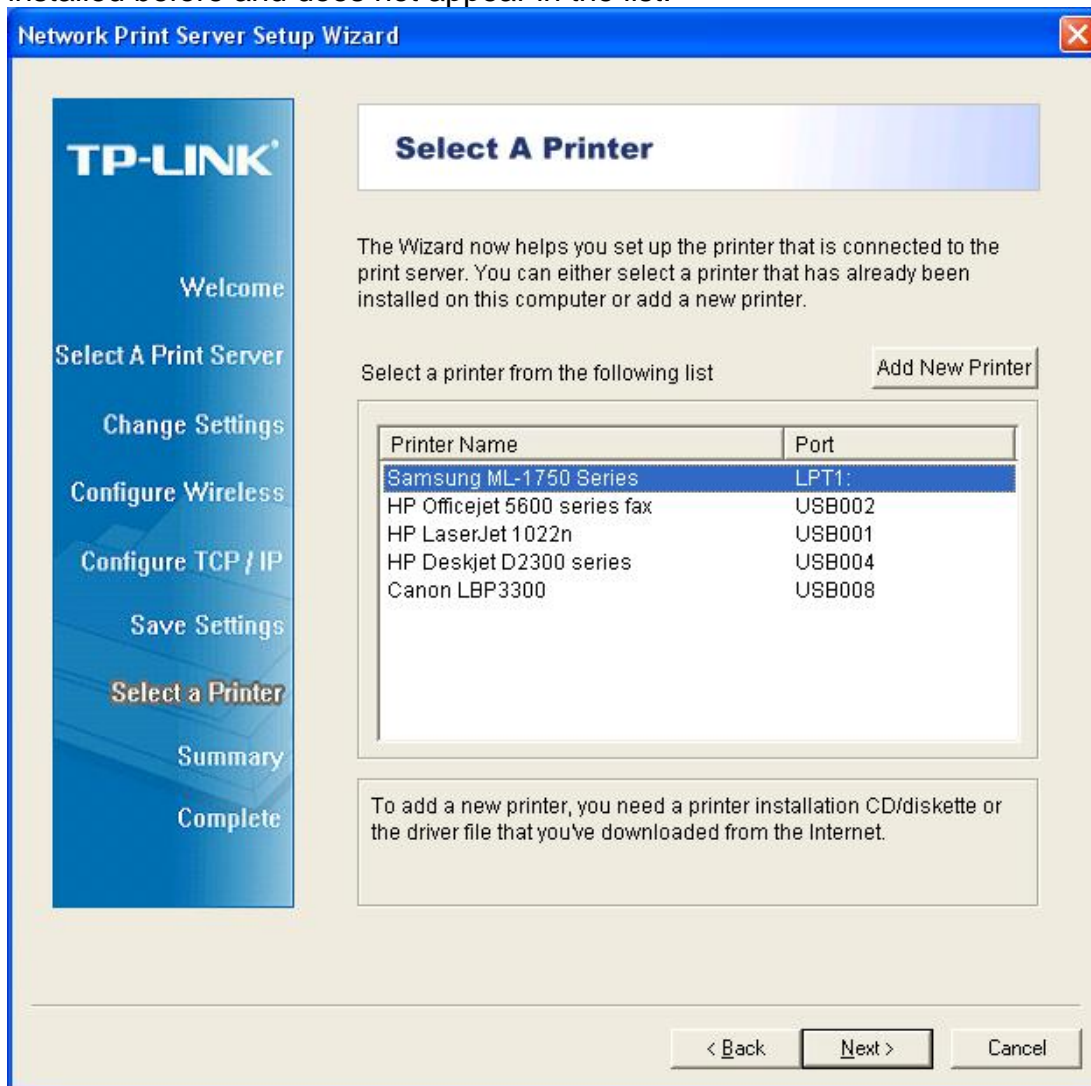

8. Click **Add New Printer** to launch **Windows Add Printer Wizard**.



9. Click **Next** and select **Local Printer**, make sure the **Automatically detect and install my Plug and Play printer** check box is **NOT** checked. Then click **Next**.

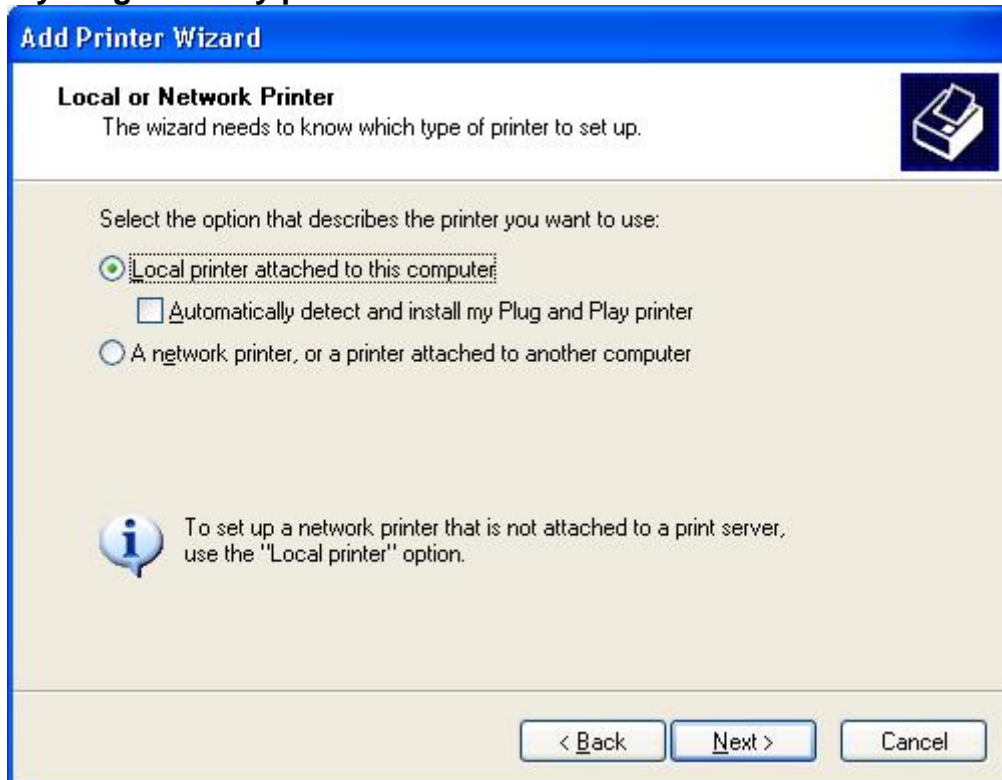

10. Make sure the **Use the following port** radio-button is clicked and select **LPT1: (recommended Printer Port)** from the pull-down list. Then click **Next**.

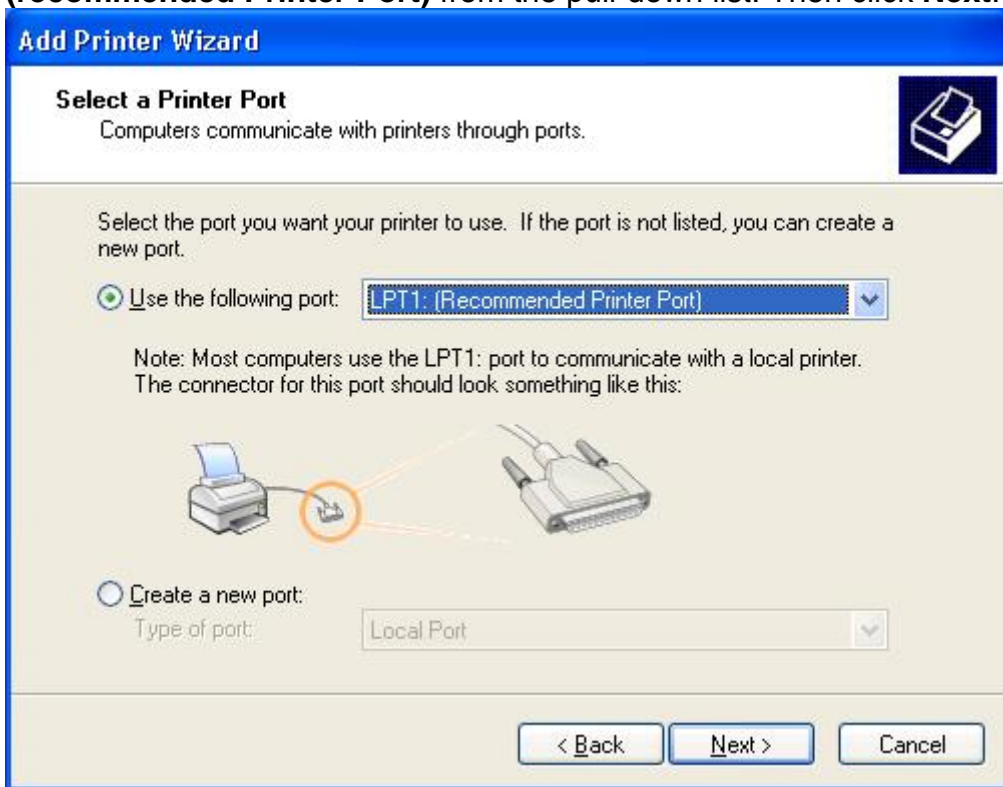

11. Select **Manufacturer** and **Printer** from the lists of printer's driver. Then click **Next**.

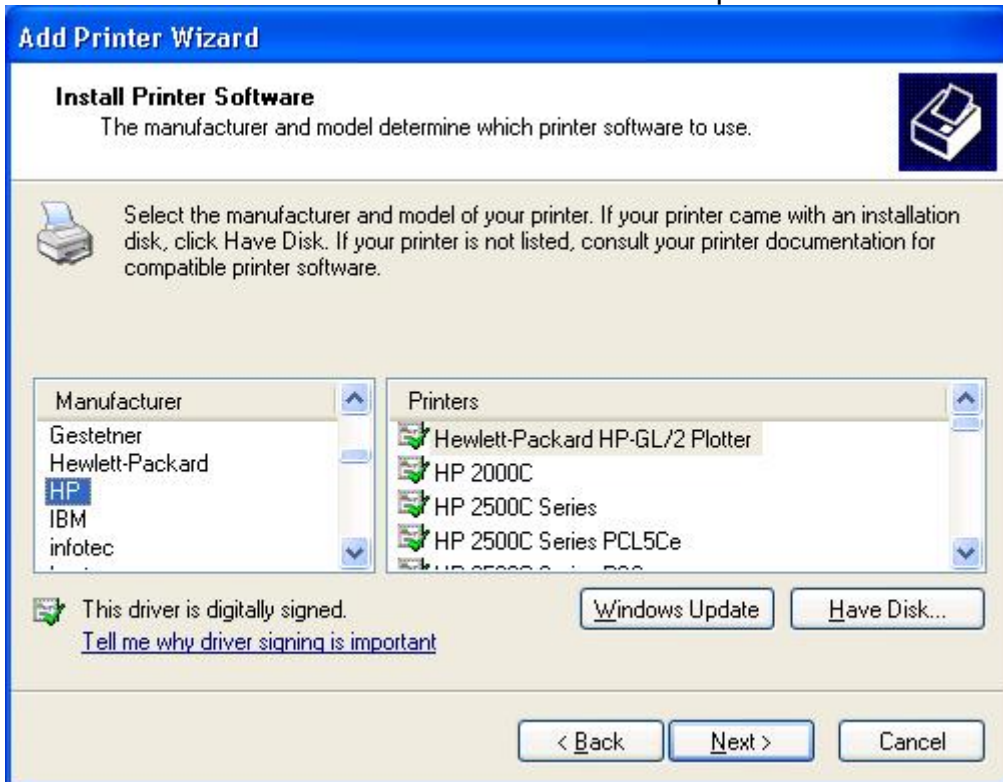

12. If you already have the printer's driver installed, you will be asked whether to keep it or to replace it. Click **Next**. Supply a name for the printer and choose whether you want to make it your default printer. Then click **Next**.
13. Then, choose whether you want to share the printer with other network user, print a test page (please select **No.**), etc. Select the appropriate radio-button and click **Next** and **Finish**.
14. In the setup wizard, finish the installation by highlighting the installed printer in the **Select a Printer** list and click **Next, NEXT -> Finish**.

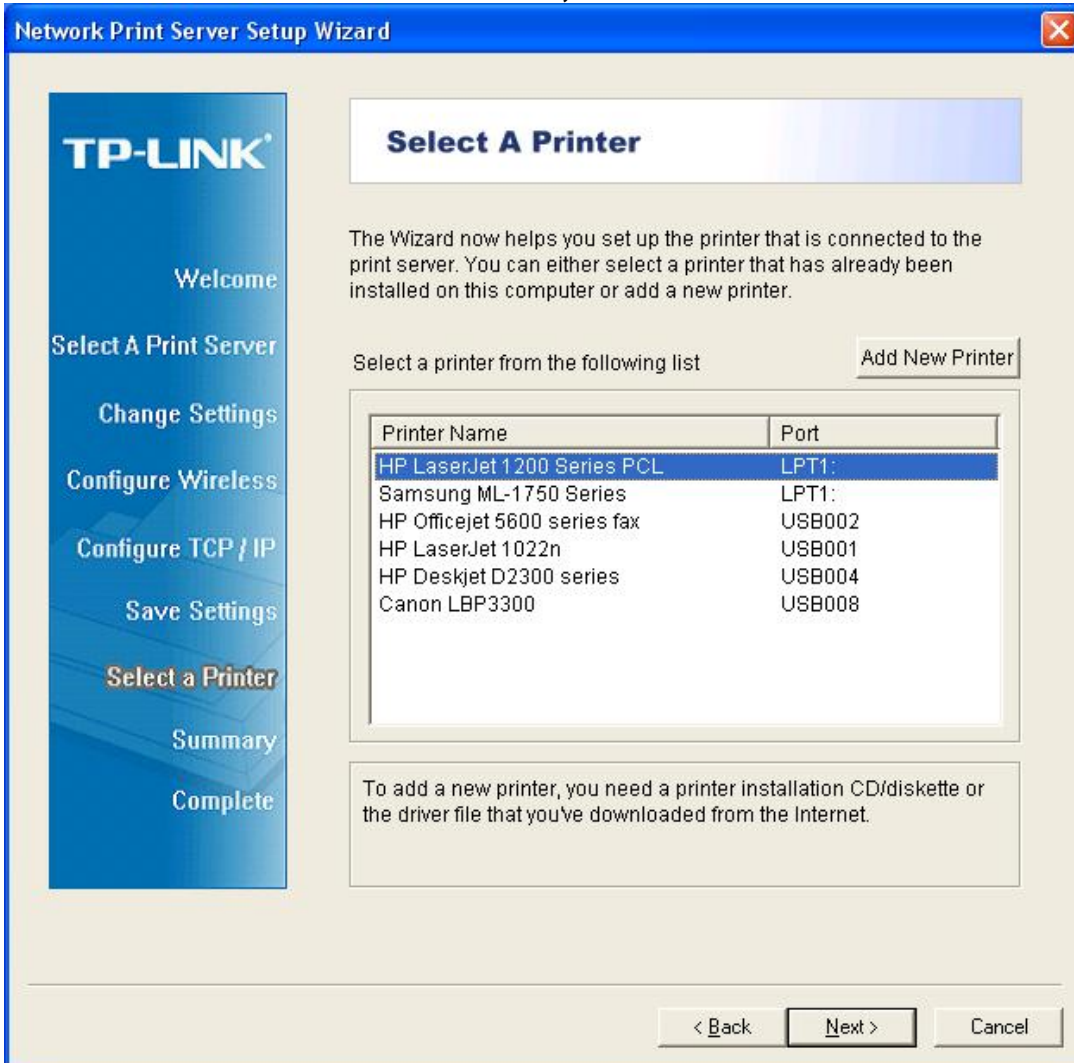

15. From Windows system, go to **start -> Printers and Faxes** and highlight your newly installed printer.

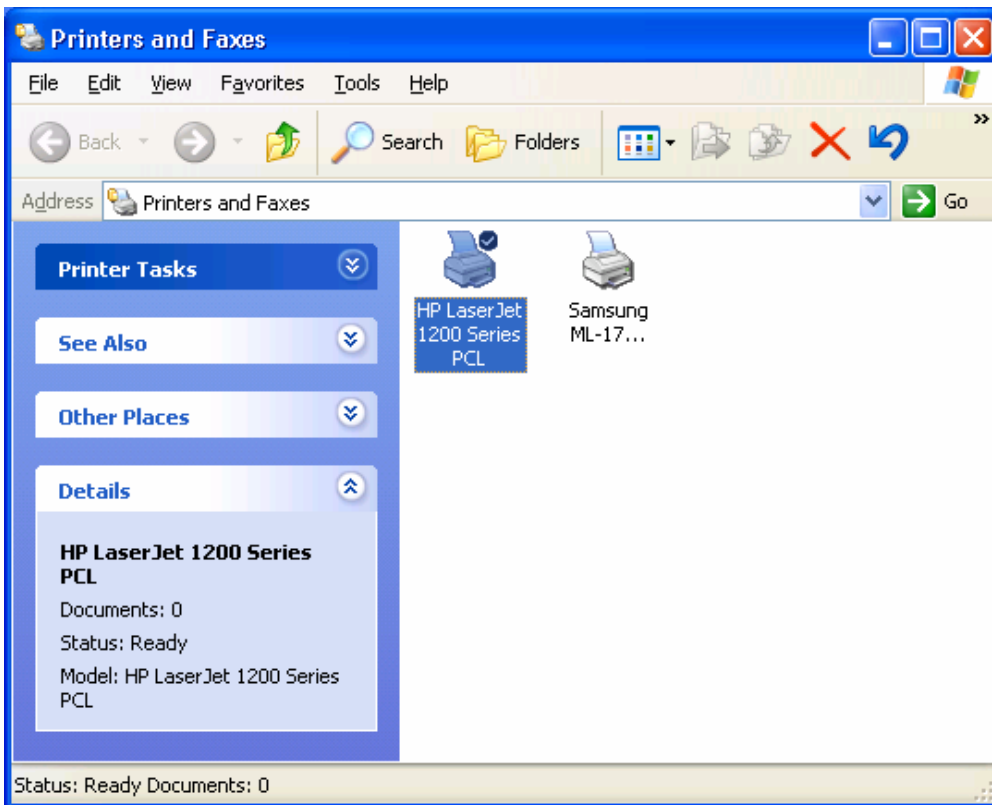

16. Right-click, select **Properties** -> **Ports** and verify that the print server's port appears.

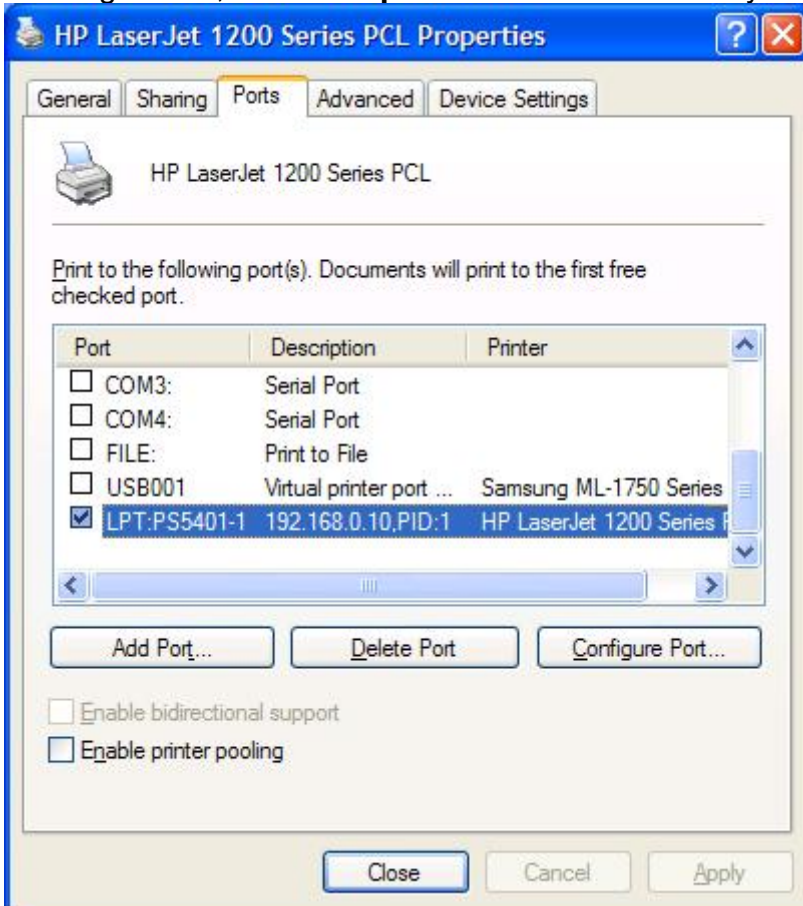

17. Go to **General**; click **Print Test Page** to verify the configuration.

18. Done.

Note:

If you want to install more print servers, start setup wizard from your Windows Start menu: **start -> All Programs -> Network Print Server -> PSWizard** and repeat the installation procedure.

Using PSAdmin

After the software of setup CD is successfully installed, starts PSAdmin utility from your Windows Start menu: **start -> All Programs -> Network Print Server -> PSAdmin**. The screen will then appear as follow picture.

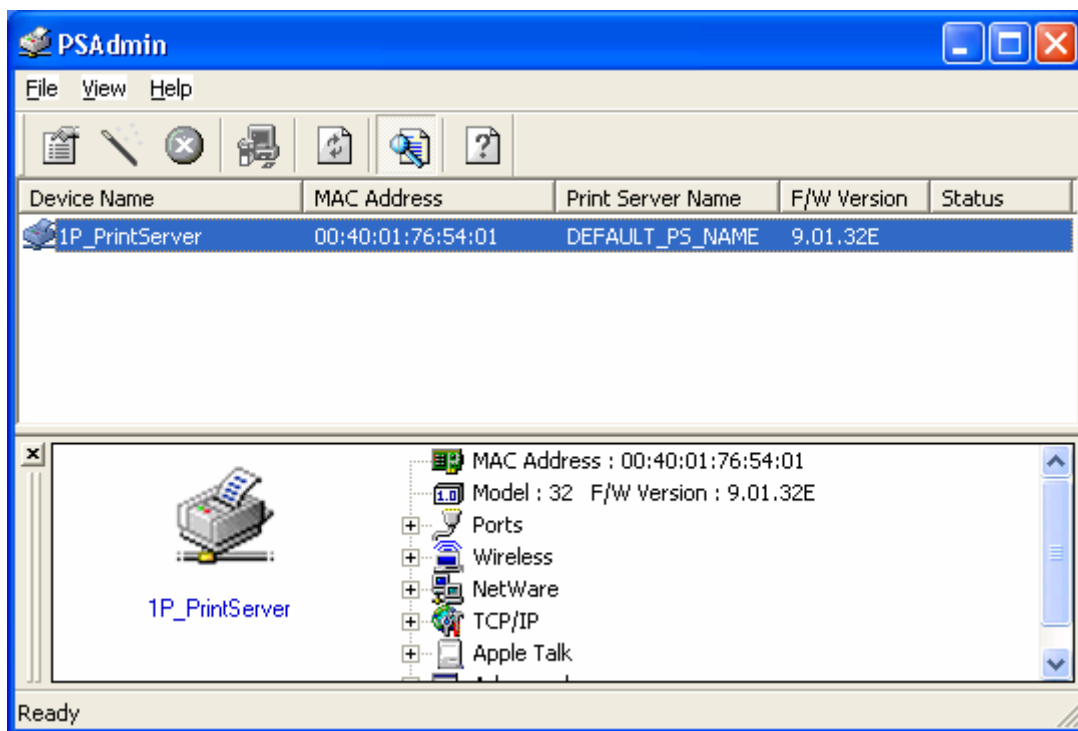

All print server(s) feature Novell NetWare function on the LAN will be displayed along with their respective device name, MAC Address, print server name, firmware version, and status. The terms are defined as follows:

Device Name: The name of the print server hardware used for identification purposes.

MAC Address: The Ethernet address of the print server.

Print server Name: The print server to which the device is attached.

Version: The firmware version of the print server.

Status: To come up a Printer's status presently.

Wizard

Wizard is a configuration program that can assist you in setting up the necessary parameters for your print server device to function. Setup a print server by using Wizard.

TCP/IP Wizard

1. Click **Wizard** button just like a picture  .and select **TCP/IP Wizard**.

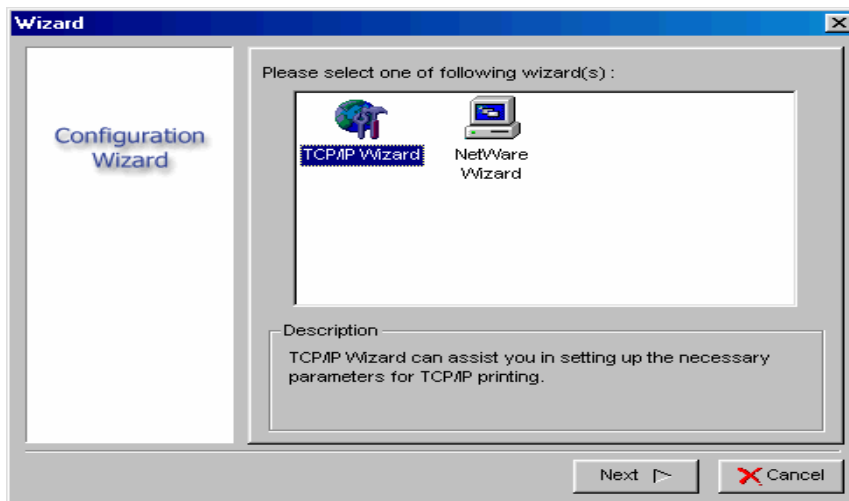

2. Select "**Obtain an IP address from DHCP server**". If there is a DHCP server on your network. This option allows the print server to obtain IP-related settings automatically from your DHCP server. This setting, by default, is disabled. If you would like to manually specify an IP address to the device, please skip to the following step.
3. In the **IP Address** option, type an IP address for the print server. The IP address must meet the IP addressing requirements of the network segment.

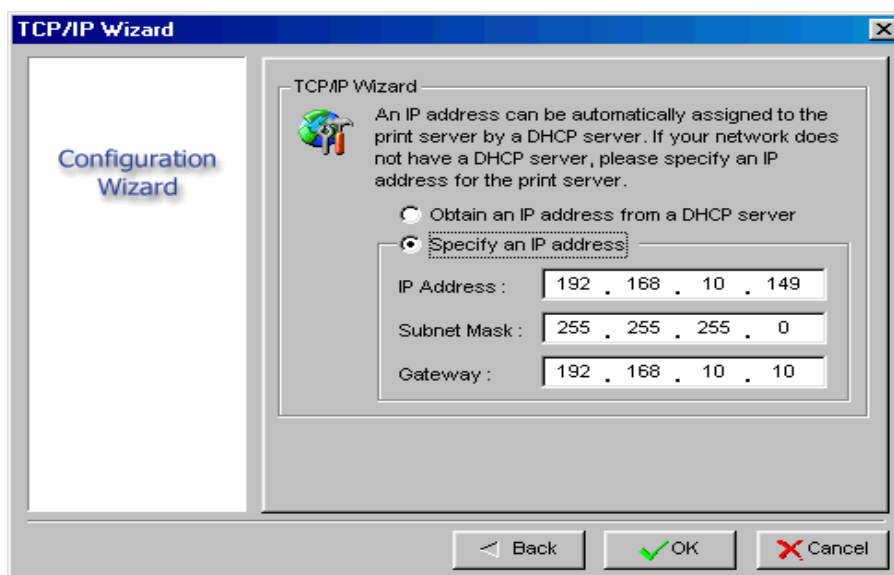

- 4 (Optional) In the **Subnet Mask** option, type the Subnet Mask your LAN or network segment is currently configured to use.
- 5 (Optional) In the **Gateway** field, type the IP address of gateway.
- 6 When done, click **OK** button. The program will save the above settings into the print server.
- 7 Done

NetWare Wizard

1. Log into your NetWare file server as a Supervisor (Admin.) or equivalent.
2. Click **Wizard** button just like a picture .and select **NetWare Wizard**, as follow picture.

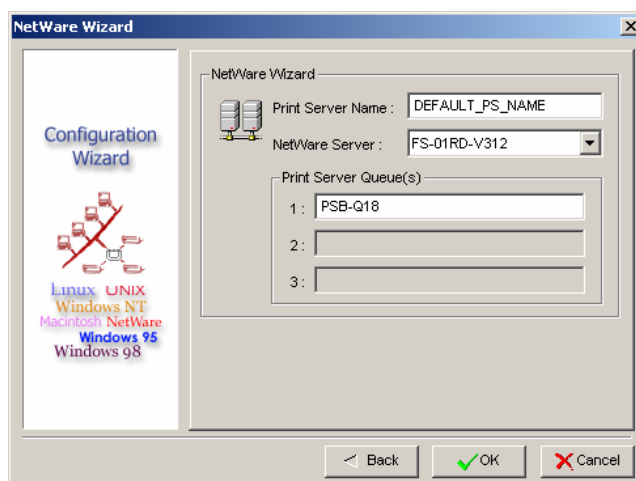

3. Select the NetWare File Server to which the print server device will be attached.
4. Type in a Print server.
5. Type in a Print Queue Names.

Note: Each print queue corresponds to each print port of the print server.

6. Click **OK**.
7. Done.
8. From your NetWare client computer, such as Windows 95/98/Me, create a printer that is connected (redirected) to one of the NetWare print queues serviced by the print server.

Manual Setup

Manual Setup is a configuration program designed for more experienced users of NetWare. To setup the print server by using Manual Setup follow the steps:

1. Run PCONSOLE in NetWare 3.x or NetWare 4.x and create the necessary parameters (Refer to your Novell NetWare print server/Services manual for details).
2. Log into your NetWare file server as a Supervisor (Admin.) or equivalent. From your Windows 95/98/Me, run PSAdmin.
3. Select the print server that you wish to configure.
4. Click **Properties** in the tool bar and the following screen will appear, **Properties** button just like a picture , as follow picture.

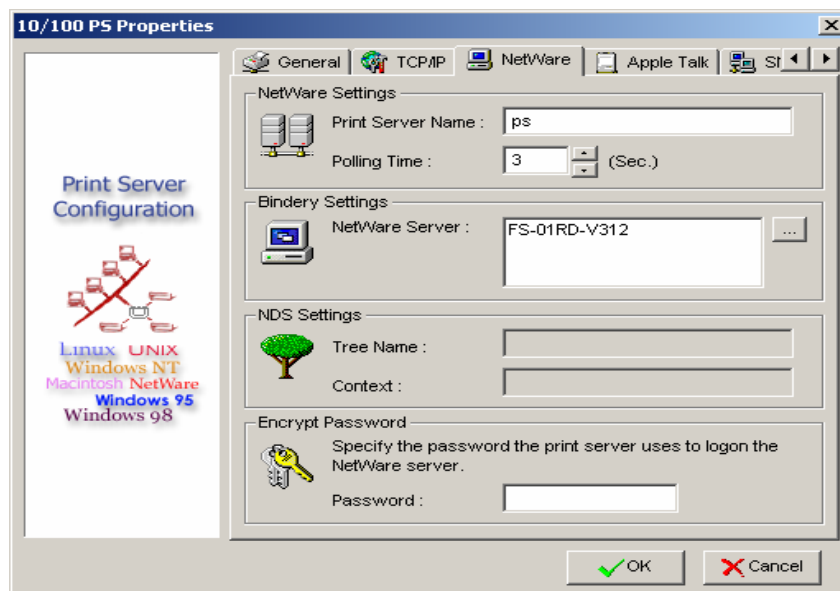

5. Select **NetWare** and type in the Print server that created during PCONSOLE.
6. (Optional) In **Bindery Settings**, Select NetWare file server(s) that print server can do Bindery mode.
7. (Optional) In **NDS Settings**, Select NetWare file server(s), NetWare 4.x or later that print server can do NDS mode.
8. Click **OK**. From your NetWare client computer, such as Windows 95/98/Me, create a printer that is connected (redirected) to one of the NetWare print queues serviced by the print server.

Properties –TCP/IP Options

The TCP/IP options allow you to modify the print server's TCP/IP settings. Each option is detailed as follows.

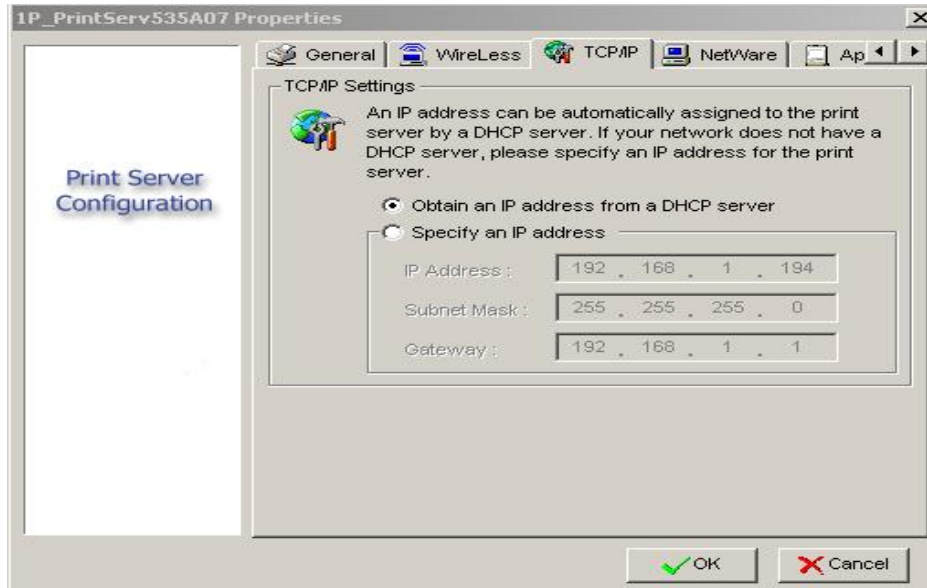

Obtain an IP address from a DHCP server:

This option enables or disables the DHCP feature of the print server. When this option is enabled, the print server will obtain an IP address automatically from the DHCP server on your LAN. **The default value is “Disable”.**

Note: 1. Once this option is enabled, the following IP address, Subnet Mask, Gateway will be grayed out and are not available for editing.

2. While the print server supports DHCP, we strongly recommend you manually specify a **fixed** IP address to the print server.

Specify an IP address:

IP Address: This option shows the print server's current IP address maybe obtained from your DHCP server or manually specified. This option also allows you to manually specify an IP address to the print server, if DHCP option is disabled.

Subnet Mask: This option shows the print server's current subnet mask maybe obtained from the DHCP server or manually specified. This option also lets you manually specify a subnet mask to the print server, if DHCP option is disabled. **This value is optional.**

Gateway: This option shows the print server's current gateway address maybe obtained from the DHCP server or manually specified. The option also allows you to manually specify the IP address of the gateway to the print server, if DHCP option is disabled. **This value is optional**

Upgrade

Upgrade allows the user to upgrade the print server device. In order to upgrade the unit please perform the steps as follows:

1. Click **Upgrade** button just like a picture , as shown as follow picture

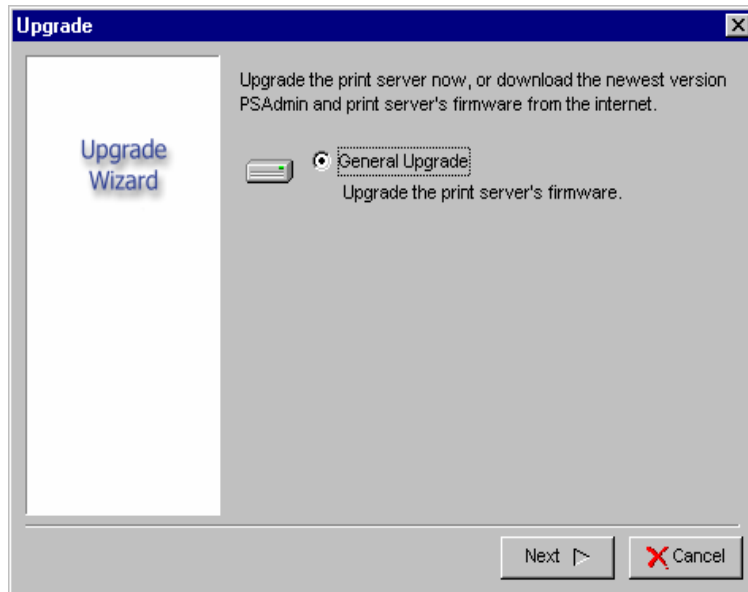

2. select **General Upgrade**. Make sure that the upgrade file is located in the same directory as PSAdmin.

Reset

1. Click **Reset** button just like a picture .
2. Reset allows the user to reset the print server device in order to establish a new connection or for new settings to take effect.

Refresh

1. Click **Refresh** button just like a picture .
2. Refresh searches the network for all attached print server(s).

Note: Configure the print speed in the **Advanced** label, must match the printer's speed which connect to the print server. Undependable configuration will cause printer to abnormal printing.

Multiple Print Queues Configuration

To configure the print server to service multiple print queues, please follow the instructions listed below:

1. Log into your NetWare file server as a Supervisor (Admin.) or equivalent.
2. Run the **PSAdmin** from your Windows.
3. Select the print server and to be configured.
4. Click the **Wizard** icon in the tool bar.
5. Type in a Print server and a Print Queue Name (For more detailed information about **Wizard**, please refer to the "Wizard" section in this chapter).
6. Run the NetWare's PCONSOLE and create additional print queues.
7. Select the Print server name you specify in Step 5.
8. Select the "**Print server Configuration**" option and select the "**Queue Serviced by Printer**" option (*For NetWare 4.x's PCONSOLE, please select "Printers" option and select "Printer 0" instead*).
9. Select the "**Printer 0**" and press the [Insert] key to add the print queues you create in Step 6 into the list (*For NetWare 4.x's PCONSOLE, please select "Print queues assigned" option instead*).
10. Reset the print server by clicking the "**Reset**" icon from the PSAdmin. Done.

Note: Please refer to NetWare's Print server/Services manuals for detailed PCONSOLE commands.

Uninstalling the PSAdmin on Windows PC

To help users easily remove all installed software components of the PSAdmin from their Windows PC, and the PSAdmin software comes with un-installation wizard program that can automatically remove the software components from their Windows PC systems in minutes. Please follow the directions listed below to proceed with the un-installation procedure. After the PSAdmin is removed, the print server is no longer accessible via the PSAdmin. You have to re-install the PSAdmin on your system in order to access the print server again.

Procedure:

1. Click **Start**, point to **Settings**, and select **Control Panel**.
2. Double click the **Add/Remove Programs** icon.

3. Click **Change or Remove Programs** tab.
4. Select **Network Print Monitor for Windows 95/98/NT/2000/XP/2003** and click **Change/Remove** button.
5. The un-installation wizard program will be launched.
6. Follow the directions on the screen to complete the un-installation procedure.

4. Internet Printer Connection and HP Web JetAdmin

IPP Overview

Print server(s) support the Internet Printing Protocol (IPP). Using the appropriate software on your system, you can create an IPP print path from your system as Windows PC over the Internet.

Note: For incoming print path requests, the network administrator have to configure the firewall to accept incoming IPP requests.

Windows NT/2000/XP/2003

For Windows NT/2000/XP/2003, you can use a supported Web Browser, for example, Netscape or IE to view the embedded web server on the print server. Contact your administrator to get the IP address or URL of the printer and browse to the print server's web page.

For example, to install Windows 2000 by IPP service you must follow below information:

1. Click **Start** button.
2. Select **Settings**, and then select "**Printers**" option.
3. Click **Add Printer** icon. Appear welcome to the add printer wizard, Click **Next**.
4. Select **Network printer** option, and then click "**Next**".
5. Select **Connect to a printer on the Internet or on your intranet** option, appear as follow picture.

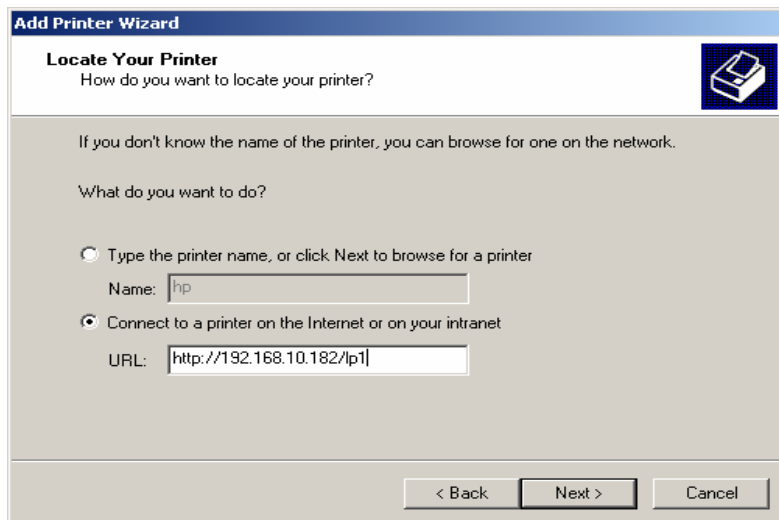

6. In URL's box, input print server's IP address, for example, `http://192.168.10.182/lp1`. Then Click **Next**.

** One port should be the port name as lp1.

7. It will check print server to connect to HP printer, if not, it will appear as follow picture. Then Click **OK**.

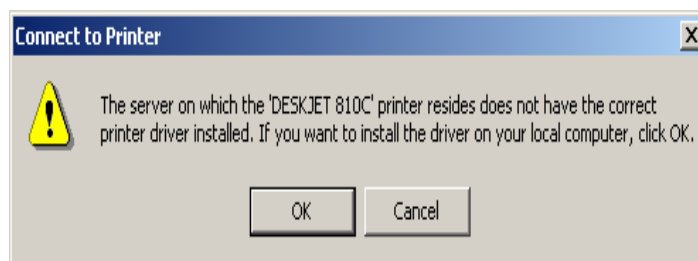

8. Select the appropriate printer manufacturer and printer type and click "**Next**", appear as follow picture.

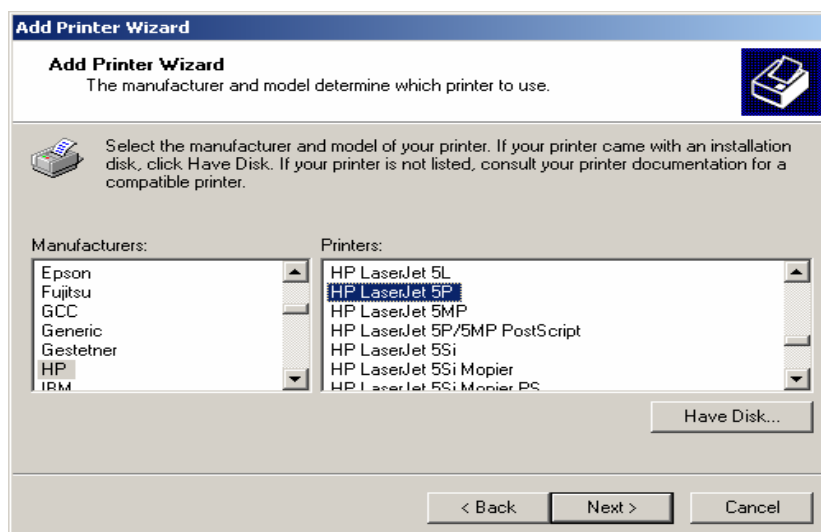

9.If you want your Windows-based programs to use this printer as the default printer, please select “Yes”, and Click **Next**. It will appear as follow picture

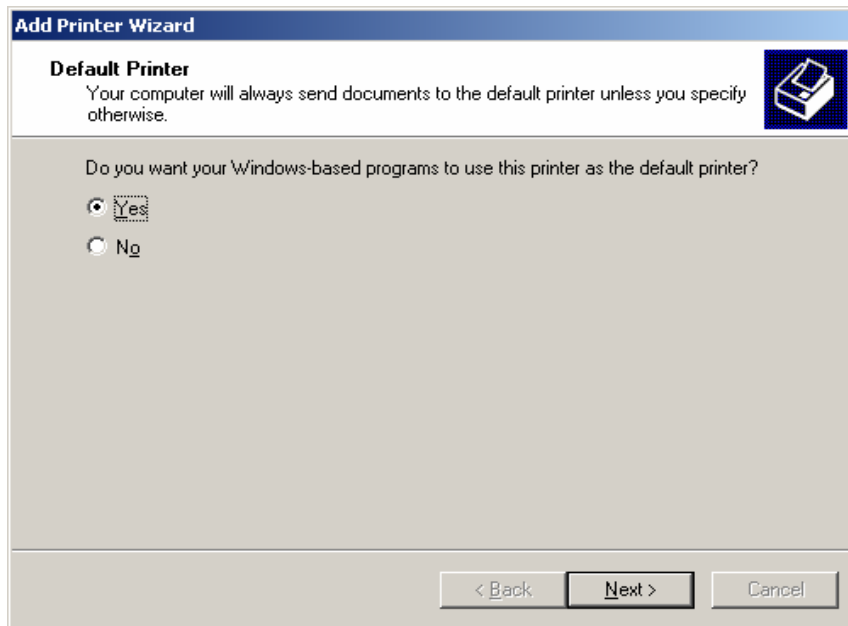

19. Click Finish button.

20. Done.

HP Web JetAdmin Overview

HP Web JetAdmin allows you to use a Web browser to revise, view, manage and diagnose devices connected to the print server or any standard printer MIB devices.

For more information about a procedure or Windows in the HP Web JetAdmin software, see about HP’s relation document.

System Requirements

HP Web JetAdmin software runs on Microsoft Windows NT, HP-UX, Solaris, Red Hat Linux and SuSE Linux system. For information on supported operating systems and browser versions, we recommend IE or Netscape version 4 or higher. Please access HP Customer Care Online at <http://www.hp.com/go/webjetadmin>.

Note: When installed on a supported host server, HP Web JetAdmin can be accessed from any client through a supported Web browser by browsing to the HP Web JetAdmin host.

Installing HP Web JetAdmin

Before installing the HP Web JetAdmin software, you must have domain administrator or root privileges:

Download the installation files from HP Customer Care Online at

<http://www.hp.com/go/webjetadmin/>.

Follow the instructions on the screen to install the HP Web JetAdmin software.

Note: Installation instructions are also contained in the HP Web JetAdmin install file.

Confirming Installation and Supply Access

- Confirming that the HP Web JetAdmin software is correctly installed by navigating to it with your browser as shown in the following. For example, `http:// server domain port/` where server domain is the host name of your web server and port is the port number assigned during installation.
- Supply users access to HP Web JetAdmin software by adding a link to your web server's home page that is addressed to HP Web JetAdmin's URL. For example:
<http://server.domain:port/>

Configuring and Modifying a Device

Using your browser, navigate to HP Web JetAdmin's URL. For example:

`http://server.domain:port/`

Follow the instructions on the appropriate home page to configure or modify your printer.

Note: You can also substitute the server domain with TCP/IP address.

Removing HP Web JetAdmin Utility

To remove HP Web JetAdmin software from your web server, use the uninstall program provided with the software package.

5. Configuration from Embedded Web Server

Overview

The Print Server contains an embedded web server that can be accessed through a supported web browser on a LAN, for example, IE 4.0, Netscape 4.0 or above is recommended.

The embedded web server provides access to configuration and management pages for the print server and the connected peripheral device.

Using Embedded Web Server

Before you can use the embedded web server, the print server must be configured with an IP address. There are many ways to configure the print server's IP address. For example, the Windows-based of PSAdmin utility can easily set an IP address with the print server, please see the Properties – TCP/IP options of chapter 3.

After an IP address is established on the print server, perform the following step:

Status Menu

Once you have finished the IP address configuration with print server. You should be use web browser to view and management the print server. The status menu of the print server helps administrator control the print server's System, Printer, NetWare, TCP/IP, SNMP and AppleTalk of status for the time being.

Preparation

Enter the print server's IP address in the Address field of your Web browser. Press Enter. Then the print server page will appear. From here you can configure all print server settings.

Please follow this information in the status menu of the print server:

System Status

1. Click **Status**, it then appears the sub-menu.
2. Click **System**, it then as shown in the following picture.

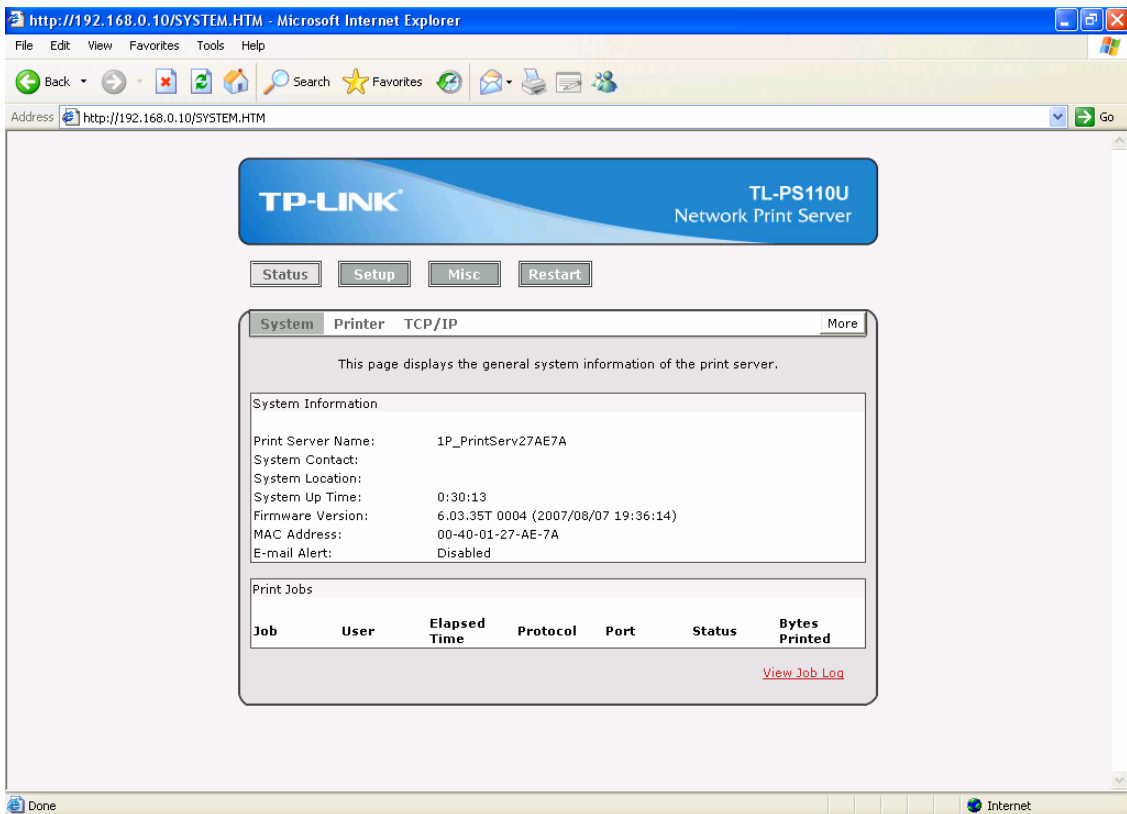

Print Server Name: This option allows you to view device name of the print server. To correct the print server's device name.

System Contact: This option allows you to view contact name of the print server. To check the print server's contact name who in charge of this device.

System Location: This option allows you to view Location name of the print server. To confirm the print server's location name where the print server is located in the office's LAN.

System Up Time: This option allows you to view uptime of the print server. When you start the print server, it will compute the print server from start time to power off time.

Firmware Version: This option allows you to view firmware version of the print server. To verify the print server's firmware version is newer in this time.

MAC Address: This option allows you to view Node ID of the print server. The Node ID is unique from any print server.

Email Alert: This option allows you to view the status of Email Alert feature.

Print Jobs: This option allows you to view all the print jobs sent by any network user.

Refresh

Job	User	Elapsed Time	Protocol	Port	Status	Bytes Printed
3	EWME-C	0min 2sec	IPX/NetBEUI	1	Completed	17614
2	Administrator	0min 0sec	LPR	1	Completed	118864
1	EWME-C	0min 2sec	UDP	1	Completed	18443

Close

Printer Status

1. Click **Status**, it then appears the sub-menu.
2. Click **Printer**, it then as shown in the following picture.

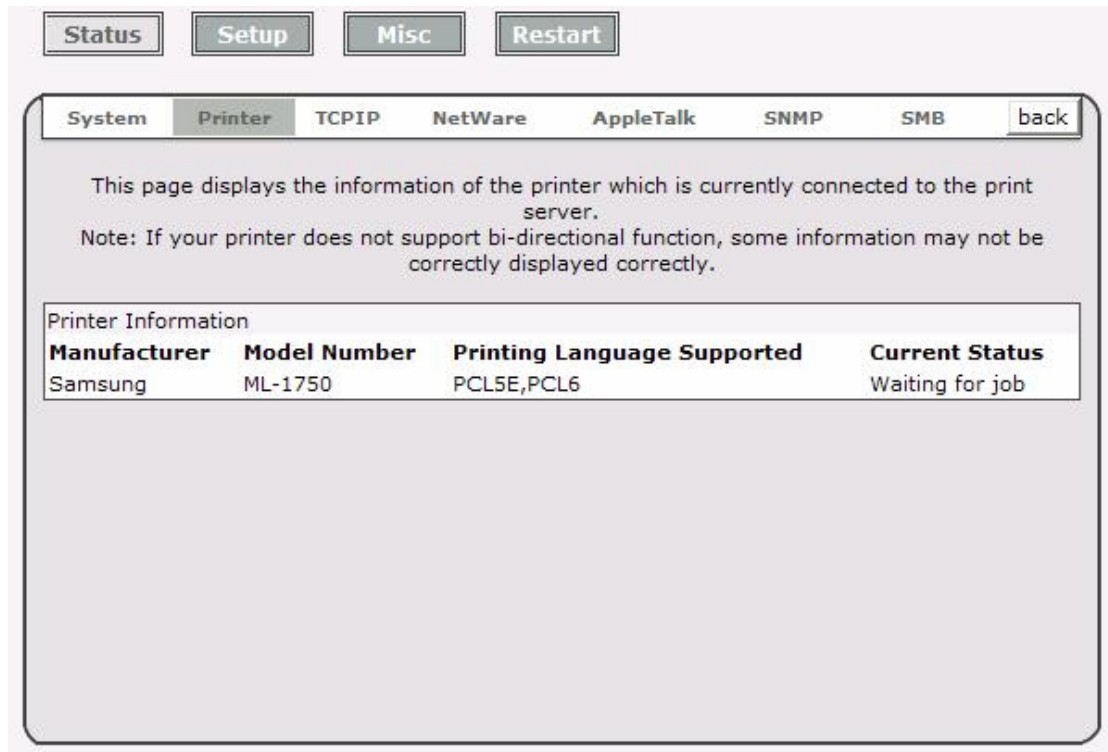

Manufacturer: This option allows you to view manufacturer of the printer. When the printer connected with the print server, it will be show in the manufacture box.

Model Number: This option allows you to view model of the printer. When the printer connected with the print server, it will be show in the model box.

Printing Language Supported: This option allows you to view command to set the printer. When the printer connected with the print server, it will be show in the command box.

Current Status: This option allows you to view status of the printer. When the printer connected with the print server, it will be show in the status box. For Example, Waiting for job. It is means the printer already to printing.

TCP/IP Status

1. Click **Status**, it then appears the sub-menu.
2. Click **TCP/IP**, it then as shown in the following picture.

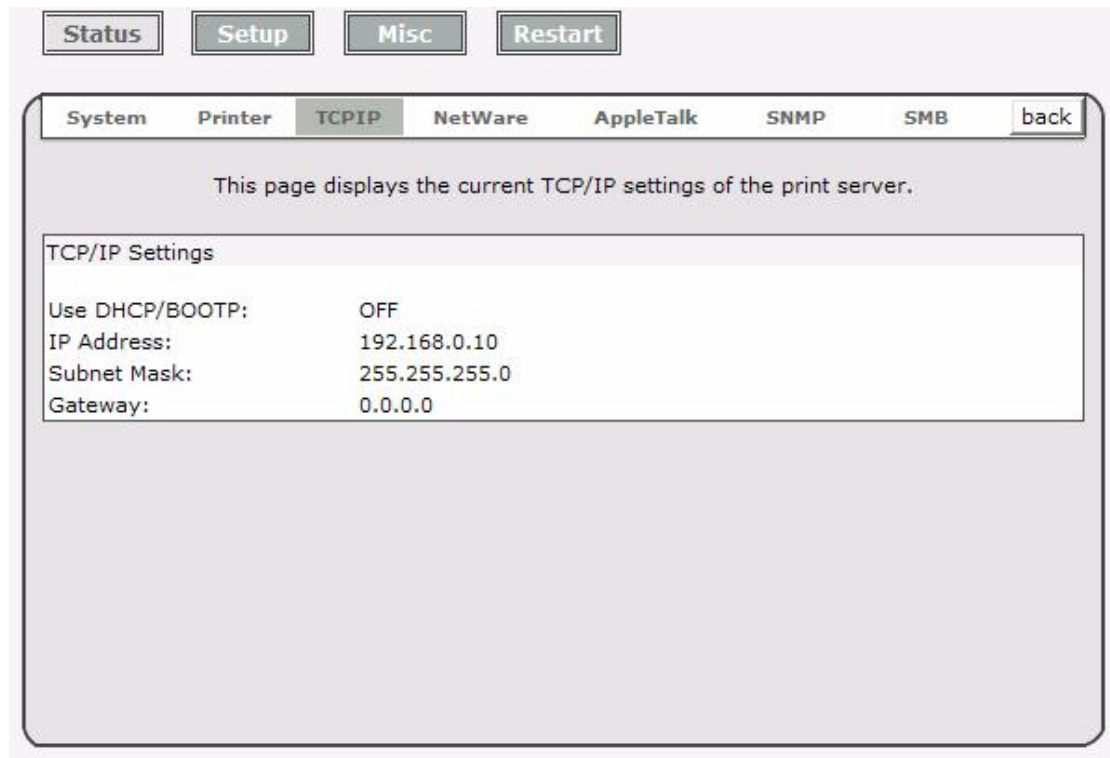

Use DHCP/BOOTP: This option allows you to view DHCP/ BOOTP status. If there is a DHCP/BOOTP server on your network, this option allows the print server to obtain IP-related settings automatically from your DHCP server.

IP Address: This option allows you to view IP address from the print server. The IP address must meet the IP addressing requirements of the network segment. (default: 192.168.0.10)

Subnet Mask: This option allows you to view subnet mask from the print server.

Gateway's IP: This option allows you to view gateway from the print server.

Netware Status:

1. Click **Status**, it then appears the sub-menu.
2. Click **Netware** it then as shown in the following picture.

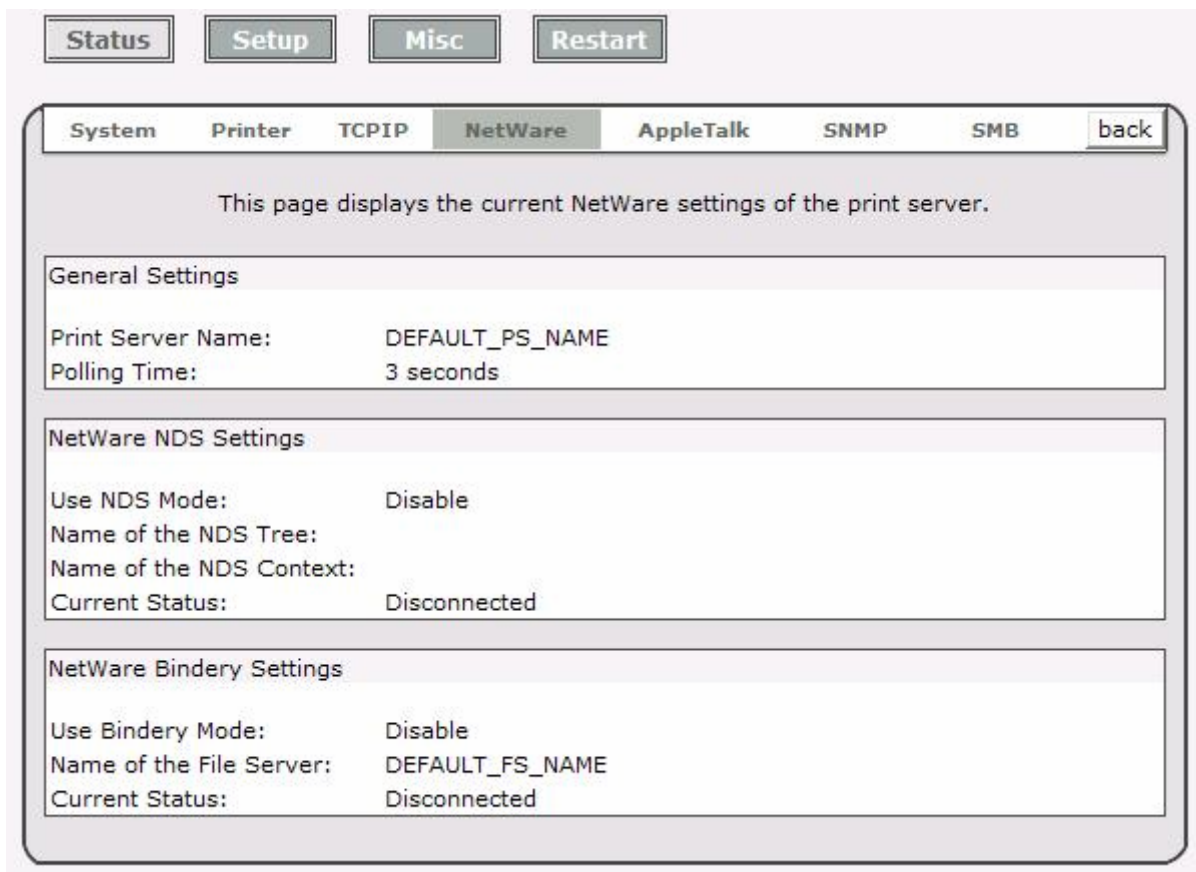

General Settings:

Print Server Name: This option allows you to view print server's name would be configured by PSAdmin utility.

Polling Time: This option allows you to view polling time from the print server. This function is search for NetWare Server by per time.

NetWare NDS Setting:

Use NDS Mode: Enable or Disable.

Name of the NDS Tree.

Name of the NDS Content.

Current Status: Connect or Disconnect.

NetWare Bindery Setting:

Use Bindery Mode: Enable or Disable.

Name of the File Server:

Current Status: Connect or Disconnect.

AppleTalk Status

1. Click **Status**, it then appears the sub-menu.
2. Click **AppleTalk**, it then as shown in the following picture.

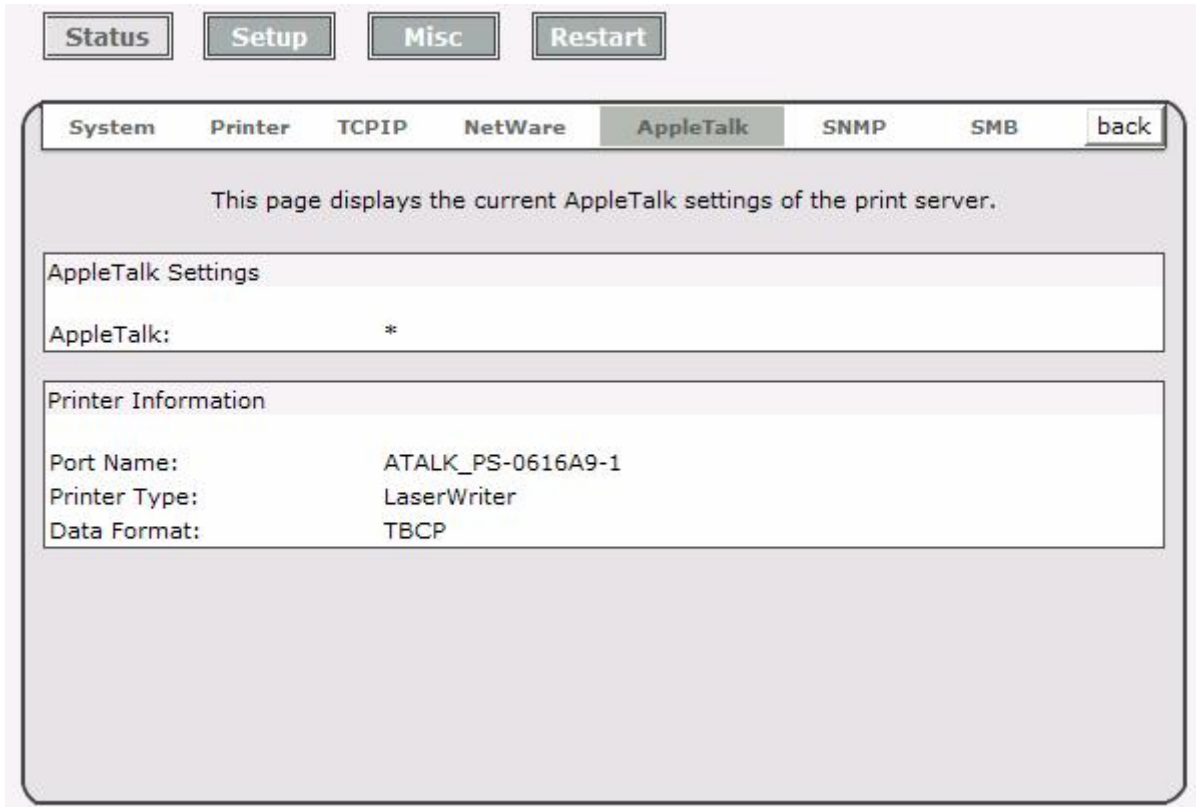

AppleTalk Settings: If no any zone exists, the print server itself displays the zone name as an asterisk (*) in the current **AppleTalk Status** of the print server in the web browser.

Port Name: <**ATALK_PS**>-xxxxxx-1, where xxxxxx represents the last six digits of the print server's Node ID.

Printer Type: This option allows you to view printer type from the print server. If you are using a PostScript printer you can select the LaserWriter 8 icon from your Mac computer.

Data Format: This option allows you to view data format from the print server. If you are using a PostScript printer you can select **ASCII**, **TBCP** or **BCP** format from web configuration.

SNMP Status

1. Click **Status**, it then appears the sub-menu.
2. Click **SNMP**, it then as shown in the following picture.

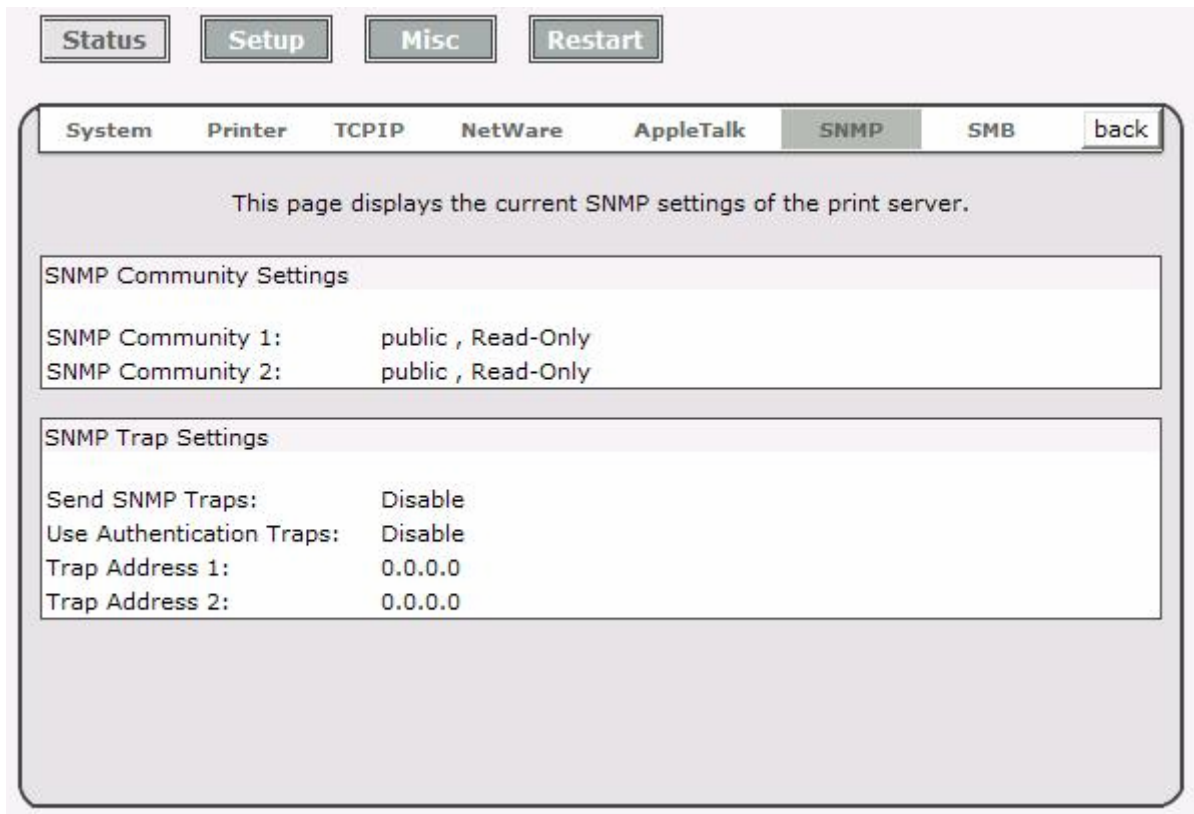

SNMP Communities: This option allows you to view SNMP communities from the print server. There are two communities that control message from the network management of the print server.

SNMP Traps: This option allows you to view SNMP traps from the print server.

SMB Status

3. Click **Status**, it then appears the sub-menu.

4. Click **SMB**, it then as shown in the following picture.

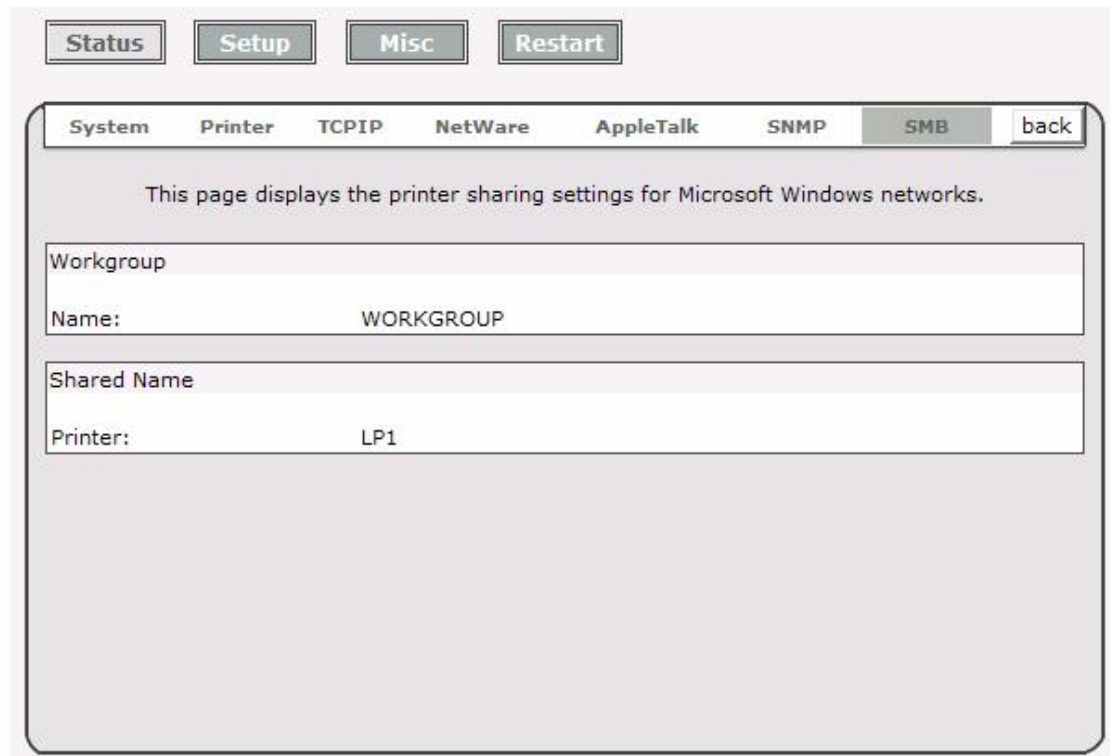

Workgroup Name: This option allows you to view the SMB Workgroup Name from the print server. It must match the SMB workgroup name of your Windows-based computer

Shared Name: This option allows you to view the Shared Name from the print server.

Setup Menu

Meanwhile, you have finished the IP address configuration with print server. You should use web browser to configure the print server. The setup menu of the print server helps administrator to setup the print server's System, Printer, NetWare, TCP/IP, SNMP and AppleTalk.

Preparation

Enter the IP address of the print server as the URL, default: 192.168.0.10. Then the print server's home page will appear in content of the web browser. Please follow this information in the setup menu of the print server:

System Setup

1. Click **Setup**, it then appears the sub-menu.
2. Click **System**, it then as shown in the following picture.

The screenshot shows a web configuration interface for a print server. At the top, there are four buttons: Status, Setup, Misc, and Restart. Below these is a navigation bar with tabs for System, TCPIP, NetWare, AppleTalk, SNMP, and SMB, and a 'back' button. The main content area is titled 'System' and contains the following sections:

- Mail Alert Settings:**
 - Email Alert: Disabled (dropdown menu)
 - SMTP Server IP Address: 0.0.0.0 (text input)
 - Administrator E-mail Address: (empty text input)
- System Settings:**
 - Print Server Name: 1P_PrintServ0616A9 (text input)
 - System Contact: (empty text input)
 - System Location: (empty text input)
- Administrator's Password:**
 - Password: (empty text input)
 - Re-type Password: (empty text input)

At the bottom of the form is a 'Save & Restart' button.

Email Alert: This option allows you to Enable/Disable the Email Alert support.

SMTP Server IP Address: This option allows you to input the IP address of your Email SMTP server.

Administrator E-mail Address: This option allows you to input your Email address that you want to receive the notification by Email.

Print Server Name: This option allows you to input device name of the print server. To correct the print server's device name.

System Contact: This option allows you to input contact name of the print server. To check the print server's contact name who in charge of this device.

System Location: This option allows you to input Location name of the print server. To confirm the print server's location name where the print server is located in the office's LAN.

Password: This option allows you to input setup password of the print server. When you select setup menu of web configuration from the print server, it then as shown in the following picture.

Re-type Password.

- **User Name:** You must be input the default administration user name, **admin** as login user name.
- **Password:** The default password is empty. After setup password is completed from the print server, you shouldn't forget this password.

TCP/IP Setup:

1. Click **Setup**, it then appears the sub-menu.
2. Click **TCP/IP**, it then as shown in the following picture.

DHCP/BOOTP: This option allows you to select DHCP/ BOOTP option. If there is a DHCP/BOOTP server on your network. This option allows the print server to obtain IP-related settings automatically from your DHCP server.

IP Address: This option allows you to input IP address from the print server. The IP address must meet the IP addressing requirements of the network segment.

Note:

On the TCP/IP Setup screen, specify a fixed IP address is highly recommended.

Subnet Mask: This option allows you to input subnet mask from the print server. The IP address must meet the IP addressing requirements of the network segment.

Gateway: This option allows you to input gateway from the print server. This IP address of gateway must meet the router or gateway to go across of the network segment.

Rendezvous Settings: Enable/Disable the Rendezvous support for Mac OS 10.

SMB Workgroup/Shared Name Setting: This option allows you to change the SMB name of print server to support the SMB printing on Windows 2000 and above.

NetWare Setup

1. Log into your NetWare file server as a Supervisor (Admin.) or equivalent.
2. Select NetWare and type in the Print server that created during PCONSOLE. Select the NetWare File Server to which the print server device will be attached.
3. Click **Setup**, it then appears the sub-menu.
4. Click **NetWare**, it then as shown in the following picture.

This setup page allows you to configure the NetWare function of the print server.

General Settings

Printer Server Name:

Polling Time: seconds (min: 3, max: 29 seconds)

Logon Password:

NetWare NDS Settings

Use NDS Mode: ▾

Name of the NDS Tree: ▾

Name of the NDS Context:

NetWare Bindery Settings

Use Bindery Mode: ▾

Name of the File Server:

Print Server Name: This option allows you to input print server name which configured by PSAdmin utility or PCOMSOLE program.

Polling Time: The time interval in which the print server unit polls the file server for servicing of print queues.

Logon Password: This option allows you to input encrypted password from the print server. The print server login to NetWare server that administrator set password from selected print server.

Use NDS Mode: To Enable NDS Mode, if you want to setup NDS environment. To select **Tree Name** of NetWare then input context name in the **Context** box.

Bindery Mode: To Enable Bindery Mode, if you want to setup Bindery environment. To select **File Server Name** of NetWare.

Installing Print Server on NetWare 4.x/5.x

Due to its architecture and functionality, the print server must work under NetWare 4.x/5.x NDS Bindery Emulation. When you install the NetWare file server for the first time, by default, the installation program will automatically set up the **Bindery Emulation** function for you by adding "SET BINDERY CONTEXT =" in the AUTOEXEC.NCF file. By default, the bindery context will only be set on your organization (O) object.

If you have ever modified this line, or if you have ever added any organization units (OU) to your NDS tree after the NetWare system was installed, please read the following section before you install the print server.

For the purpose of illustration, we assume the NDS tree structure is as follows:

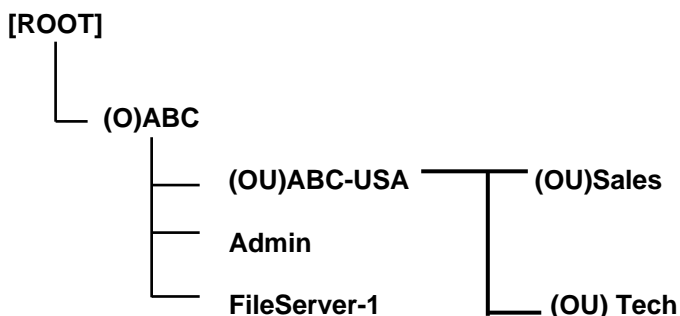

Installation Procedure

1. At your file server console, type "load install".
2. Select "NCF files options".
3. Select "Edit AUTOEXEC.NCF file".
4. Add or Modify the "SET BINDERY CONTEXT =" line to include the NDS organization (O) and all organization unit (OU) objects where users are located. For example: SET BINDERY CONTEXT = O=ABC; OU=SALES.OU=ABC-USA.O=ABC; OU=TECH.OU=ABC-USA.O=ABC ;
5. When done, save the new **AUTOEXEC.NCF** file. Please restart your NetWare file server in order for new settings to take effect immediately.
6. Next, please refer to "Auto Setup" section in this chapter to finish installing your print server.
7. Log into your NetWare file server as a Supervisor (Admin.) or equivalent *via a Bindery connection*.
8. Run NetWare's PCONSOLE and add users to the "Queue Users" list.
9. From your NetWare client computer, such as Windows 95/98/Me, create a printer that is connected (redirected) to the NetWare print queue serviced by the print server.

Note: Please refer to NetWare's Print Server/Services manuals for detailed PCONSOLE commands.

AppleTalk Setup

The print server can print jobs submitted from Macintosh workstations connected to an Ethernet using AppleTalk protocol. The basic configuration is for the print server in an AppleTalk environment is performed simply by opening the **Chooser** window and selecting a printer that is connected to the print server.

1. Click **Setup**, it appears the sub-menu.
2. Click **AppleTalk**, it as shown in the following picture.

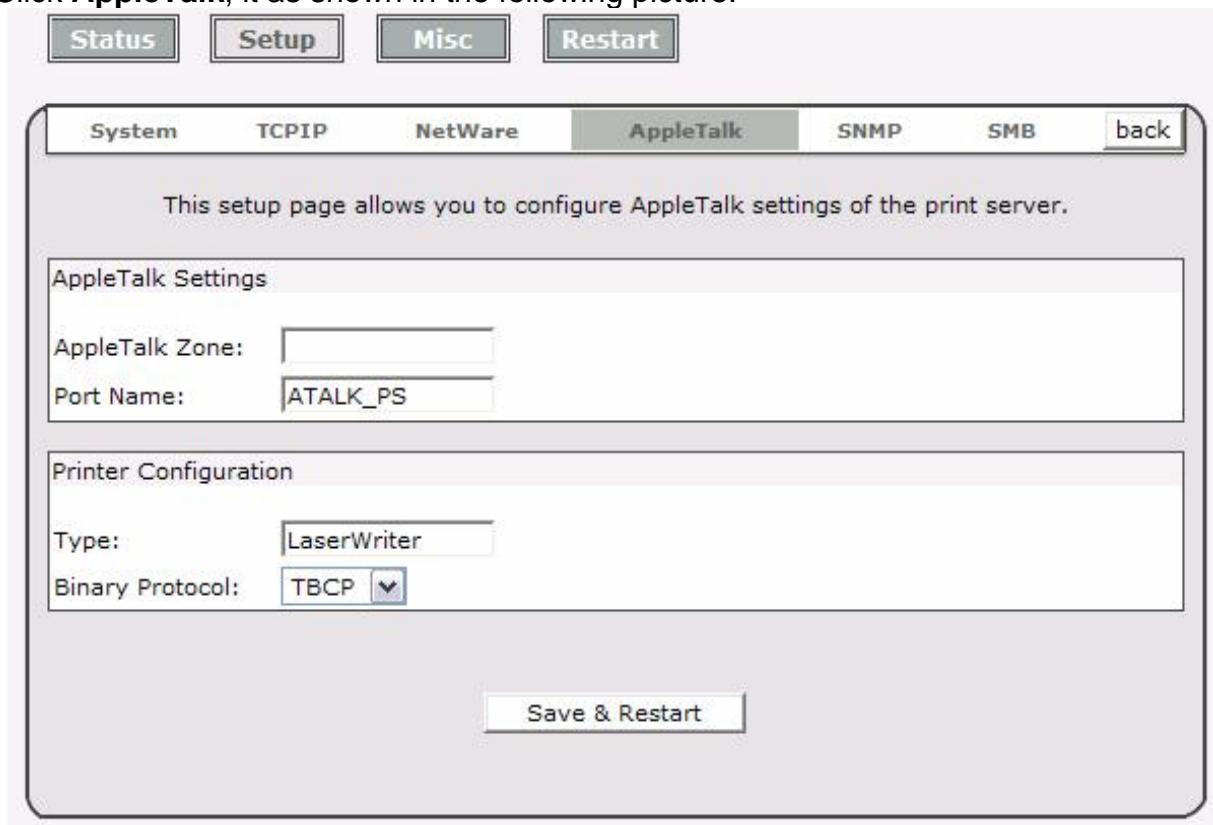

The screenshot shows a web browser window with a navigation bar at the top containing buttons for 'Status', 'Setup', 'Misc', and 'Restart'. Below this is a sub-menu with tabs for 'System', 'TCPIP', 'NetWare', 'AppleTalk' (which is selected and highlighted), 'SNMP', 'SMB', and a 'back' button. The main content area contains the following text and form fields:

This setup page allows you to configure AppleTalk settings of the print server.

AppleTalk Settings

AppleTalk Zone:

Port Name:

Printer Configuration

Type:

Binary Protocol:

3. **Zone Name:** In this option, type an AppleTalk Zone name that you want the print server to belong to or leave it in default (*This enables the print server automatically search and link itself to the default zone that is set on the AppleTalk router, if found*). We also assume that at least an AppleTalk Zone exists on the network. If no any zone exists, the print server itself displays the zone name as an asterisk (*) in the current **AppleTalk Status** of the print server in the web browser.
4. **Port Name:** In this option, type a name for identification purpose or just leave it in default (**recommended**).

Note: The default print server's Chooser name is as shown as follows:

<**ATALK_PS**>-xxxxxx-1, where xxxxxx represents the last six digits of the device's Node ID. For example: ATALK_PS-40EEED-1. You may also change the <**ATALK_PS**> to a name you like for identification purpose in this option. The print server will append the last six digits to the name you specify.

5. **Printer Type:** In this option, the **LaserWriter** of printer type by default (**recommended**).

6.**Data Format:** In this option, data format includes **ASCII**, **TBCP** and **BCP**.

Setting Up a Macintosh Computer

1. At a Macintosh computer, from the **Apple** menu, select **Chooser**.
2. The **Chooser** window then displays an Apple Zone list. Select the Zone name that you specified when configuring the PRINT SERVER.

Note: If you select a Zone that the PRINT SERVER doesn't belong to, as you specified in the previous section, no print server will be displayed in the Step 4.

3. If you are using a PostScript printer you can select the **LaserWriter 8** icon.
4. The **Chooser** window then displays PRINT SERVER (s) featuring the support for AppleTalk protocol, along with its default *Chooser Name* in the right-hand **Select A PostScript Printer** dialog box.

Note: 1.You may change the default Chooser name and Zone name of a PRINT SERVER by using your web browser before proceeding with this installation. Please see the previous section in this chapter for details.

2. If you use **Mac OS 8.x or 9.x**, please make sure your printer support **PostScript**.

5. Click **Setup...** button and choose the **PPD** file matching your printer, and click **OK**. If your printer does not appear in the PPD file list, please contact your printer vendor. You may also use the **Generic PPD** if you do not need any printer specific features.
6. Close the **Chooser** Windows.
7. Done.

SNMP Setup

TCP/IP networks use a standard management protocol called *Simple Network Management Protocol* (SNMP). SNMP is widely used in the industry as a solution for remote network management and monitoring of networking devices. SNMP actually includes a protocol, a database structure specification, and a set of database objects. The database objects are contained in a standard database called *Management Information Base* (MIB) that is stored on the networking device called *SNMP agent*. The print server's SNMP implementation runs in a TCP/IP environment.

A host on the network running Network Management System (NMS) software can access the print server device by reading and writing the MIB objects stored in the device. The Network Management Systems are available from many third-party vendors, such as Hewlett-Packard's OpenView.

When accessing (traversing) MIB objects in the print server using NMS software called *SNMP manager*, you need to provide a *community name* in each SNMP request for authentication purpose. The print server supports up to two community names. The default community name is *public* (case-sensitive), with *Read Only* access right in default.

When an unusual condition or activity occurs, the SNMP agent alerts the SNMP manager through *SNMP traps*. Following list summaries SNMP trap messages that the print server will send out.

Activities/SNMP Trap Messages	Description
Link Up or Link Down	When the network interface on the print server fails, a link down trap message is generated; if the network interface comes back to life, a link up trap message is sent.
Cold Start or Warm Start	When the print server restarts, the cold start or warm start trap message is generated.
Authentication Failure	When the print server received a SNMP request with a community name that does not match the community name the print server is configured with (stored in the print server's memory), an authentication failure trap message is generated.

In the print server's SNMP implementation, the following MIB objects are available for updating.

MIB Object Names	Description
system.sysContact	Indicates the network administrator's name.
system.sysName	Indicates the print server's name for identification.
system.sysLocation	Indicates the location of the print server.
snmp.snmpEnableAuthenTraps	

Enables or disables the function of sending SNMP Authentication Failure trap message to the network administrator, if the community name within a SNMP request is not correct.

Users can set up print server's SNMP functions by using their browsers.

1. Click **Setup**, it then appears the sub-menu.
2. Click **SNMP**, it then as shown in the following picture.

The screenshot shows a web-based configuration interface for a print server. At the top, there are four buttons: 'Status', 'Setup', 'Misc', and 'Restart'. Below these is a sub-menu with tabs for 'System', 'TCP/IP', 'NetWare', 'AppleTalk', 'SNMP', and 'SMB', with a 'back' button on the right. The 'SNMP' tab is currently selected. The main content area contains the following settings:

This setup page allows you to configure SNMP settings of the print server.

SNMP Community Settings

Support HP WebJetAdmin : ▾

SNMP Community Name 1:

Privilege: ▾

SNMP Community Name 2:

Privilege: ▾

SNMP Trap Settings

Send SNMP Traps: ▾

Use Authentication Traps: ▾

Trap Address 1:

Trap Address 2:

SNMP Community: The print server supports up to two community names. The default community name is *public* (case-sensitive), with *Read Only* access right in default.

Support HP WebJetAdmin: This option allows user determine to disable/enable the Support HP WebJetAdmin.

SNMP Traps: Enable the function of sending SNMP Authentication Failure trap message to the network administrator, if the community name within a SNMP request is not correct.

SMB Setup

The print server supports the SMB (Server Message Block) protocol, user can send the print jobs through Network Neighborhood without installing print server's driver.

1. Click **Setup**, it appears the sub-menu.
2. Click **SMB**, it as shown in the following picture.

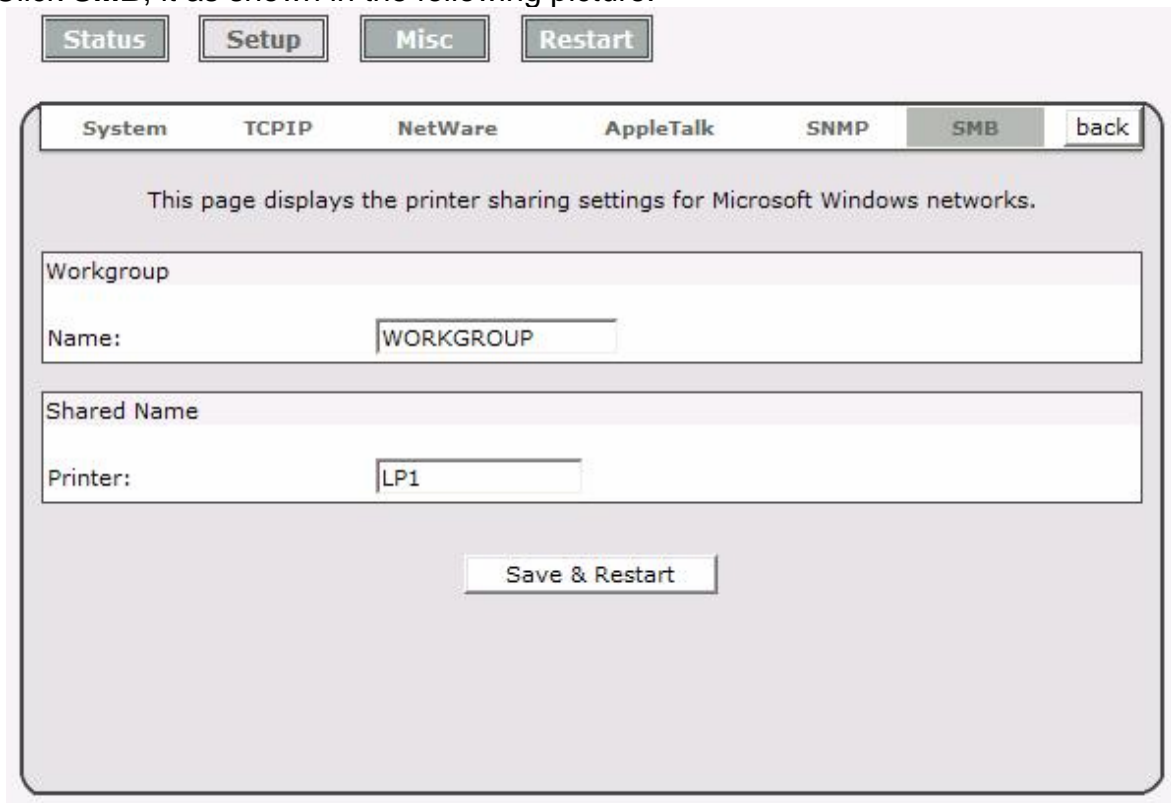

The screenshot shows a web-based configuration interface for SMB settings. At the top, there are four buttons: "Status", "Setup", "Misc", and "Restart". Below these is a navigation bar with tabs for "System", "TCPIP", "NetWare", "AppleTalk", "SNMP", "SMB", and "back". The "SMB" tab is selected. The main content area contains the following text: "This page displays the printer sharing settings for Microsoft Windows networks." Below this, there are two sections: "Workgroup" and "Shared Name". The "Workgroup" section has a "Name:" label and a text input field containing "WORKGROUP". The "Shared Name" section has a "Printer:" label and a text input field containing "LP1". At the bottom of the form is a "Save & Restart" button.

3. **Workgroup Name:** This option allows you to assign a workgroup name to print server on the Network Neighborhood. Windows uses it to identify the print server on the Network.
4. **Shared Name:** This option allows you to assign a name to print server's port.

6. Network Print Monitor

Preparation

The print server supports **TCP/IP**, **IPX/SPX** and **NetBEUI** protocols under Windows 95/98/Me. Please make sure that the following steps have been completed before proceeding with installation under Windows PC.

Select A Desired Protocol

TCP/IP

- The TCP/IP Protocol must be installed. For further information, please read “*TCP/IP Protocol Installation*” section in this chapter.

Note: If TCP/IP protocol is chosen, please refer to “Assigning an IP Address to the print server” section later in this chapter.

IPX/SPX

The IPX/SPX-compatible Protocol must be installed. For further information, please read “*IPX/SPX-compatible Protocol Installation*” section in this chapter.

NetBEUI

The NetBEUI protocol must be installed. For further information, please read “*NetBEUI Protocol Installation*” section in this chapter.

TCP/IP Protocol Installation

1. Click **Start**, point to **Settings** and select **Control Panel**.
2. Double click the **Network** icon.
3. If the **TCP/IP Protocol** is not already installed, click **Add**.
4. Select **Protocol** and click **Add**.
5. Select **Microsoft** from the Manufacturers list.
6. Select **TCP/IP Protocol** from the Network Protocols list.
7. Specify an IP address, Subnet Mask, and Gateway address or specific “Obtain IP address automatically”, if a DHCP server is available on the LAN.
8. **Restart the computer.**
9. Done.

Note: Using TCP/IP protocol to access the print server requires well-configured TCP/IP settings. If you are not familiar with these settings, please consult your network administrator for details or ask for help.

IPX/SPX-compatible Protocol Installation

1. Click **Start**, point to **Settings**, and select **Control Panel**.
2. Double click the **Network** icon.
3. If the **IPX/SPX-compatible Protocol** is not already installed, click **Add**.
4. Select **Protocol** and click **Add**.
5. Select **Microsoft** from the Manufacturers list.
6. Select **IPX/SPX-compatible Protocol** from the Network Protocols list and follow the instructions on the screen.
7. **Restart the computer.**
8. Done.

NetBEUI Protocol Installation

1. Click **Start**, point to **Settings**, and select **Control Panel**.
2. Double click the **Network** icon.
3. If the **NetBEUI** is not already installed, click **Add**.
4. Select **Protocol** and click **Add**.
5. Select **Microsoft** from the *Manufacturers* list.
6. Select **NetBEUI** from the *Network Protocols* box and follow the instructions on the screen.
7. **Restart your computer** for new settings to take effect.
8. Done.

Note: For more detailed information, please refer to your Microsoft Windows 9X/ME/NT/2000/XP/2003 manuals.

Windows 95/98/Me/NT/2000/XP/2003 manual Installation Procedure

Please perform the steps as follows to ensure a smooth installation:

1. Run **Setup** from the print server's NetWare, Win 95/98/Me/NT/2000/XP/2003 Setup diskette
2. The **Network Print Monitor for Windows 95/98/Me Setup** will then appear. Click **Next**.
3. A message reading, "Setup is complete. You may add the Network Print Port by using the PSAdmin" will appear. Click **OK**.
4. Click **Start**, point to **Settings**, and select **Printers**.
5. Double-click the **Add Printer** icon.
6. Select **Local Printer** and click **Next**.
7. Select the appropriate printer manufacturer and printer type and click **Next**.
8. Select **LPT1** and click **Next**.
9. Type in the **Printer Name** and click **Next**.

10. A message reading, “After your printer is installed, Windows can print a test page so you can confirm that the printer is set up properly.” Select **No** and click **Finish**.
11. Double-click the newly created **Printer Name** icon.
12. Select **Printer** and **Properties**.
13. Click **Details** tab and select **Add Port**.
14. In the **Add Port** dialog box, select **Other**, as shown in the following picture.

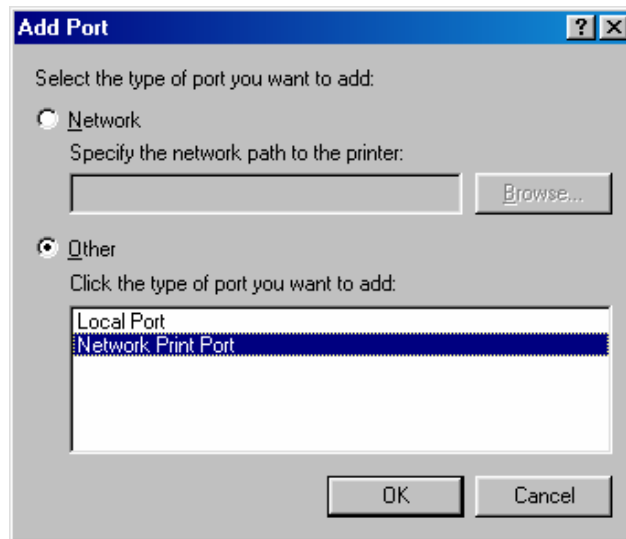

15. Select the **Network Print Port** and click **OK**.
16. The Add Port box will then appear, along with the print server’s Node ID (*The last 6 digits of the Node ID, located on the back of the print server unit*). Select one printer server port from the list, which is now connected to (one of) your printer(s), as shown in the following picture.

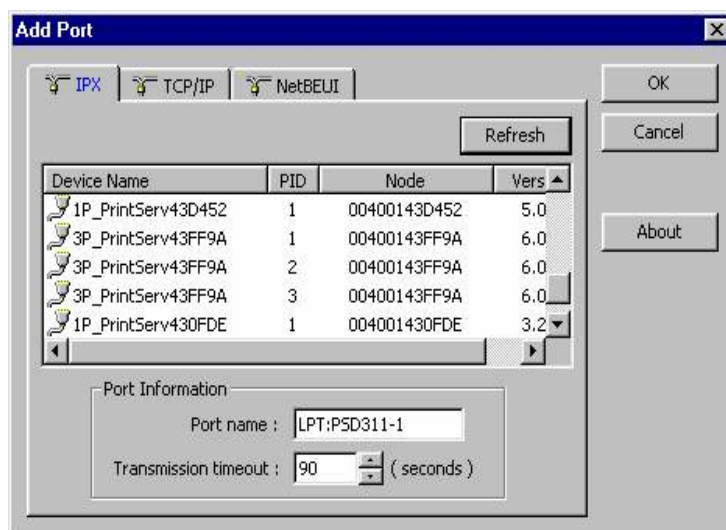

- By default, the computer will first search for the print server(s) on the network by using the IPX/SPX protocol.
- If the IPX/SPX protocol is installed, the print server will be displayed along with its Node ID, as shown in Node column. (*The last 6 digits of the Node ID, located on the back of the print server unit*). Select one of the print server's ports from the list.
- If the IPX/SPX protocol is *not* installed, no print server will be shown in the display box. Then please select TCP/IP or NetBEUI alternatively.
- It starts again to search for the print server on the network by using the protocol you specify in the step above. When finished, the print server will be displayed along with the its Node ID, as shown in the following picture. (*The last 6 digits of the Node ID, located on the back of the print server unit*). Select one of the print server's ports from the list.

Uninstalling Network Print Port on Windows 95/98/Me/NT/2000/XP/2003

To provide users an easiest way to remove all of the Network Print Port components from Windows 95/98/Me, the Network Print Port software comes with un-installation wizard program to help users remove the software components from their Windows 95/98/Me/NT/2000/XP/2003 systems in minutes. Please follow the directions listed below to proceed with the un-installation procedure.

After the Network Print Port is removed, the print server is no longer accessible via the Network Print Port. You have to re-install the Network Print Port on your system in order to access the print server again.

Procedure:

1. Click **Start**, point to **Settings**, and select **Control Panel**.
2. Double click the **Add/Remove Programs** icon.
3. Click **Add/Remove** tab.
4. Select **Network Print Monitor for Windows 95/98/Me** and click **Add/Remove** button.
5. The un-installation wizard program will be launched.
6. Follow the directions on the screen to complete the un-installation procedure.

Note: We recommend you *restart* your computer after un-installation is finished.

7. TCP/IP LPR Port Printing Installation

Basic TCP/IP Installation Overview

When installing your print server in a TCP/IP environment, IP addresses are essential as a basic means of communications. It is therefore necessary to first assign an IP address to your print server unit. After assigning an IP address, the print server can be configured accordingly.

Assigning an IP Address

The first step to install a print server on a TCP/IP network is to assign the print server an IP address and other related TCP/IP settings before the print server can function. You can select the following two methods to specify an IP address the print server. Each method will be detailed in the following section.

1. Use the **Network Print Monitor** utility.
2. Manually specify (using DOS commands or UNIX text-mode commands. This applies to Windows NT/2000/XP/2003 and UNIX systems).

Note: The **Network Print Monitor** can only search for the print server(s) over the same network segment the Windows NT/2000/XP/2003/UNIX computer is located. You would like to install a print server on a different network segment.

DHCP

The print server supports DHCP feature, allowing the print server to obtain an IP address and related TCP/IP settings automatically from a DHCP server. While the print server supports DHCP, we strongly recommend you manually specify a **fixed** IP address to the print server. By default, the print server's DHCP function is disabled.

Windows NT LPR Port Printing Installation

1. Click **Start**, point to **Settings**, and select **Printer**.
2. Run **Add Printer**.
3. The Add Printer Wizard screen will appear, Select **My Computer** and click **Next**.
4. Click **Add Port**.

- From the Printer Ports box as shown in the following picture, select the **LPR Port**.

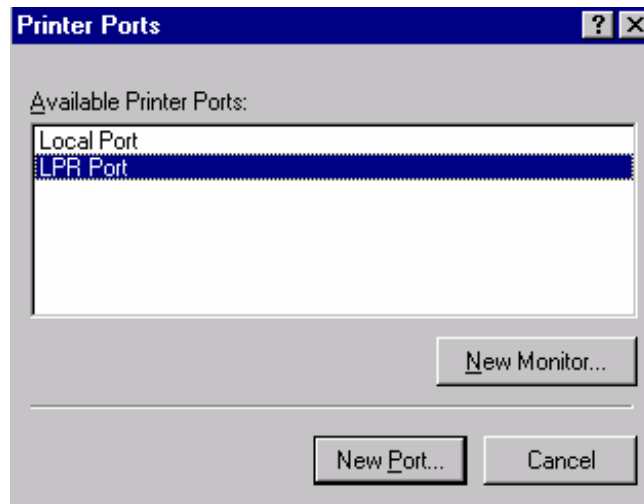

- The Add LPR compatible printers box will then appear as shown in the following picture. Type in the IP address assigned to the print server in the **Name or address of server providing lpd** box.

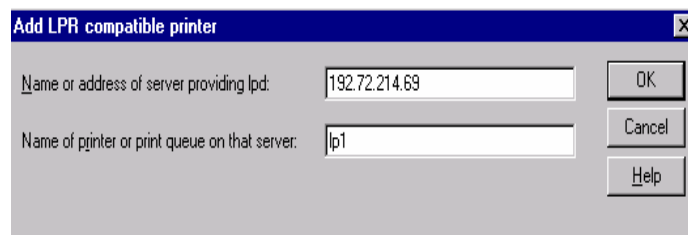

- In the **Name of printer or print queue on that server** box, type in a printer name, for example, lp1. Click **OK**.
- In the Printer Ports box, select **Close**.
- Click **Next**.
- Select the appropriate printer manufacturer and printer type list and click **Next**.
- Select **Shared**. Type in a new **Share Name** or leave it in default and click **Next**.
- A message reading, "After your printer is installed, Windows can print a test page so you can confirm that the printer is set up properly.", Select **Yes (Recommended)** and click **Finish**.
- Done.

Windows 2000/XP/2003 Standard TCP/IP Port Printing Installation

1. Click **Start**, point to **Settings**, and select **Printer**.
2. Run **Add Printer**, Click **Next**.
3. The Add Printer Wizard screen will appear, Select **Local Printer** and click **Next**.
4. From the type of **Create a new port** box as shown in the following picture, select the **Standard TCP/IP Port**, Click **Next** and **Next**.

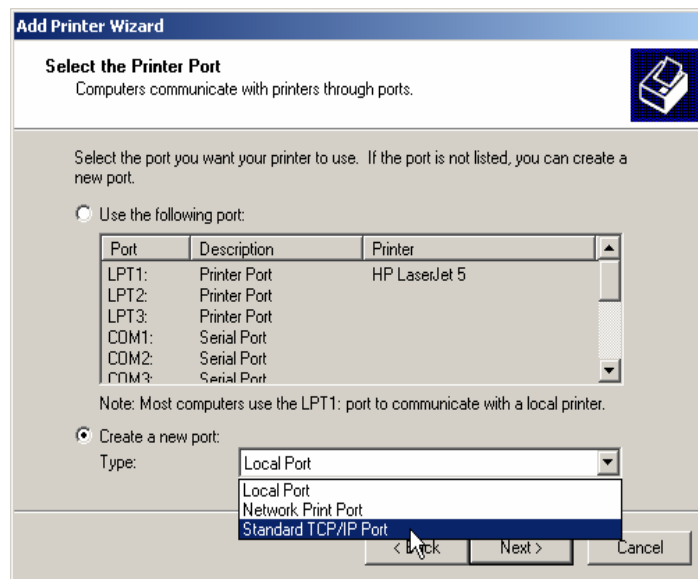

5. The Add Standard TCP/IP Printer Port Wizard box will then appear as shown the picture as below, and type in the IP address assigned to the print server in the **Printer Name or IP Address** box, Click **Next**.

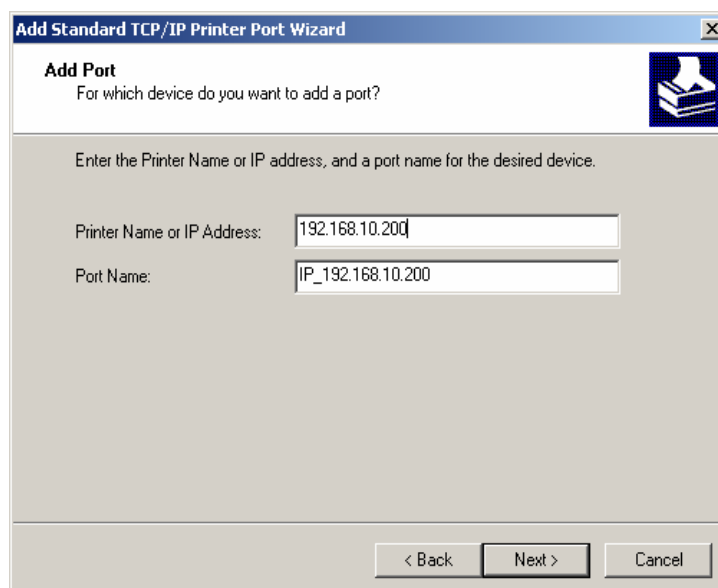

6. In the **Add Standard TCP/IP Printer Port Wizard** box as shown in the following picture, Select **Custom**, Click **Settings** button, and click **Next**.

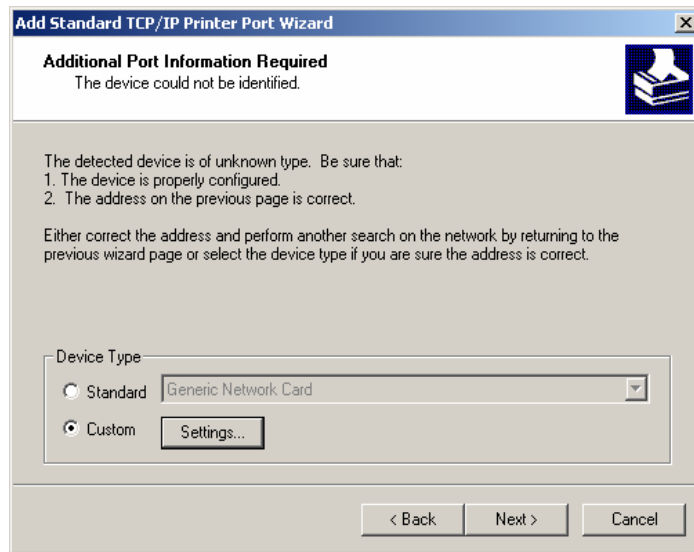

7. In the **Configure Standard TCP/IP Port Monitor** box as shown in the following picture, select **LPR** form Protocol, type in a queue name, for example, **lp1**.
8. Click **OK**, and **Next**.

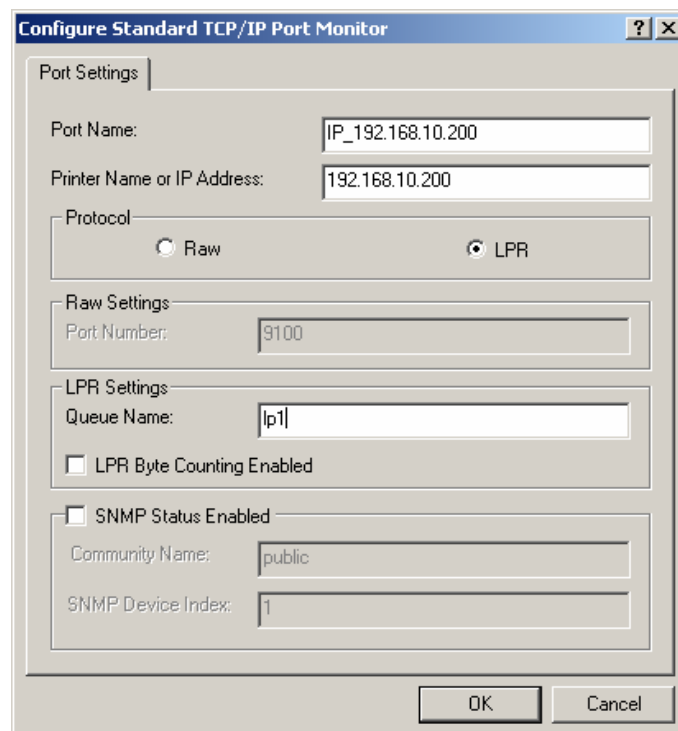

Note: Please **DO NOT** type any other name than **lp1** in this step.

9. Click **Finish**.

10. Select the appropriate printer manufacturer and printer type list and click **Next**.
11. Type in a new **Printer name** or leave it in default, and click **Next** button.
12. A message reading, "To confirm that the printer is installed properly, you can print a test page". Select **Yes (Recommended)** and click **Finish**.
13. Done.

UNIX Installation

After the static IP address is assigned, the Print Server is ready to be configured. For some UNIX/Linux systems, we include the detailed installation procedures below. If you can't find the installation procedure corresponding to your UNIX system, please refer to your UNIX manuals for details about configuring your UNIX for the "**remote printing system**".

SCO UNIX 8.0.0 (Caldera Open Unix 8.0.0)

1. Select "**SCO Admin**".
2. Select "**Printer Setup Manager**".
3. Enter **/Printer / Add TCP / IP Printer...**
4. **Name**: Input a name you like. For example: Test.
Protocol Type: Choose "lpd (BSD)".
Make/Model: Select the printer model. For example: EPSON LQ570.
Printer Connection Type: Choose "On Remote Server".
Remote System: Input the IP address of the printer server. For example: 192.168.1.250.
Remote Printer: lp1 or lp2 or lp3. (fixed)
If the printer connected to the first print server port, please choose **lp1**.
If the printer connected to the second print server port, please choose **lp2**.
If the printer connected to the third print server port, please choose **lp3**.
5. Click "**OK**".
6. Enter **/Printer / Make Default**.

System V Release 4 Unix

1. For example: the print server has a static IP address: 192.168.1.100
2. Input "**lpsystem -tbsd 192.168.1.100**".
3. Input "**lpadmin -pa1 -s 192.168.1.100!lp1**". lp1 for the first print server port.
4. Input "**accept a1**".
5. Input "**enable a1**".

Redhat Linux 9

The Print Server can work under any Linux-based systems, including Slackware, RedHat, etc, without any problems.

Basically, the Linux's printing system is based on BSD system. Although many commercial Linux systems are available in the market and their commands will vary slightly, depending upon which version is used, the functionality of the Linux-based variants is exactly the same. Following are the outlined procedures (**recommended for all users**) on Red Hat Linux 7.2/7.3 or later with *X-Window* system installed.

1. Make sure that the TCP/IP is well configured on your RedHat system, including network interface card's driver and IP-related settings say, IP address, subnet mask, and gateway IP).
2. Log in **root**.
3. Assign Print Server an IP address. At shell mode:
 - c.1. `arp -s <the IP address you want to assign to the Print Server> < Print Server 's Node ID>`
 - c.2. Execute `tftp < Print Server 's IP> get config.txt` and quit tftp.
 - c.3. Edit the config.txt and modify the IP address, subnet mask, and gateway IP. When done, save the config.txt.
 - c.4. Execute `tftp <Print Server 's IP> put config.txt` and quit tftp.
4. Start X-windows by typing **startx** at the shell mode.
5. Open **Printer Configuration**.

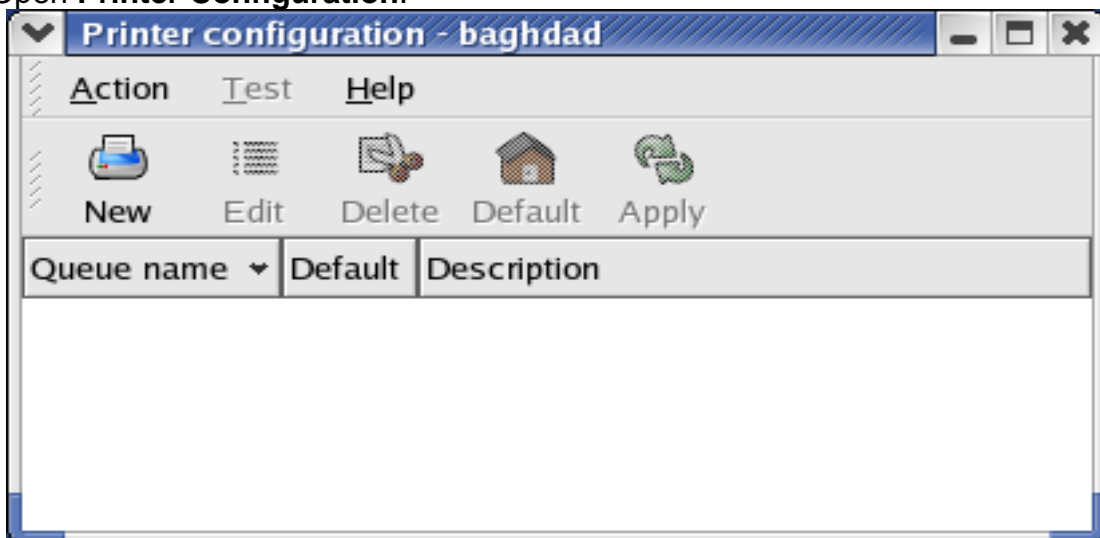

6. Click **New** button.

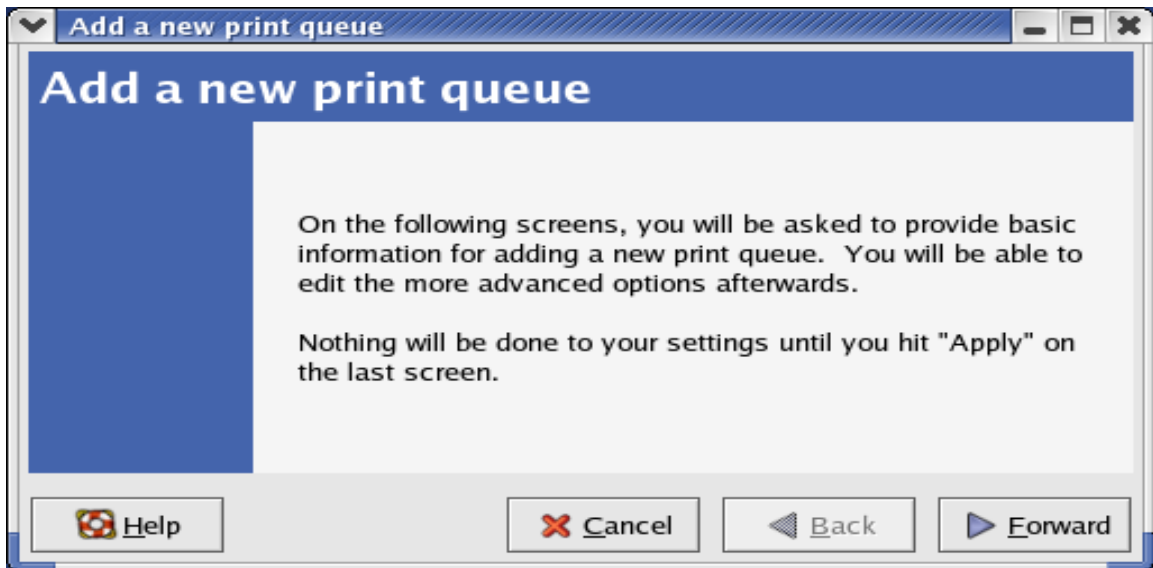

7. Click **Forward** button.

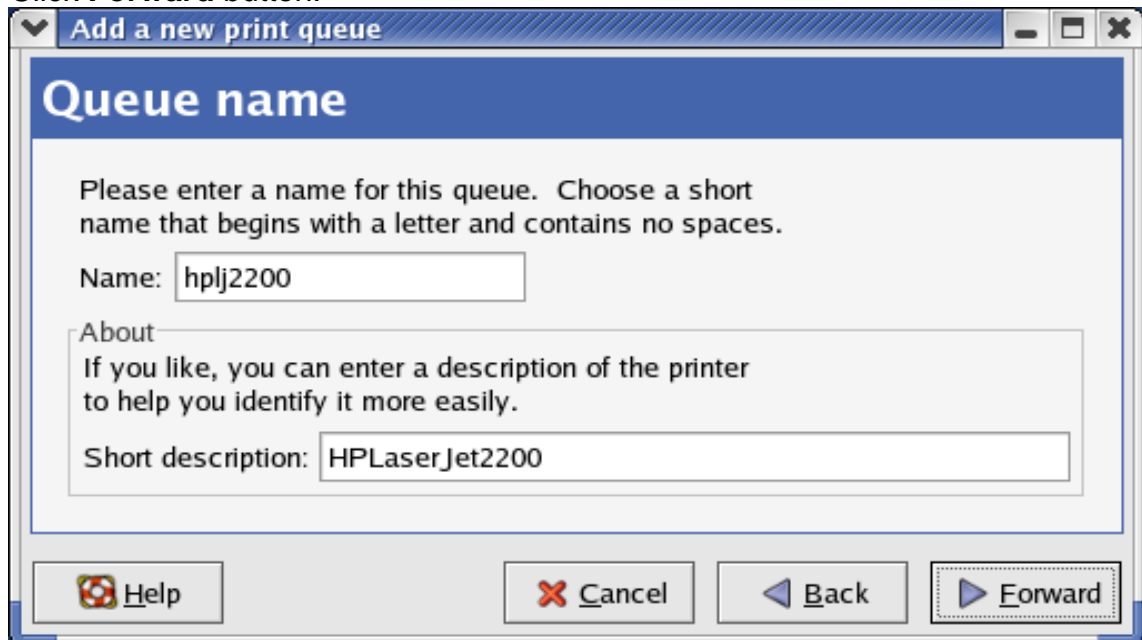

8. In the **Name** field, type a user-defined name, click **Forward**.

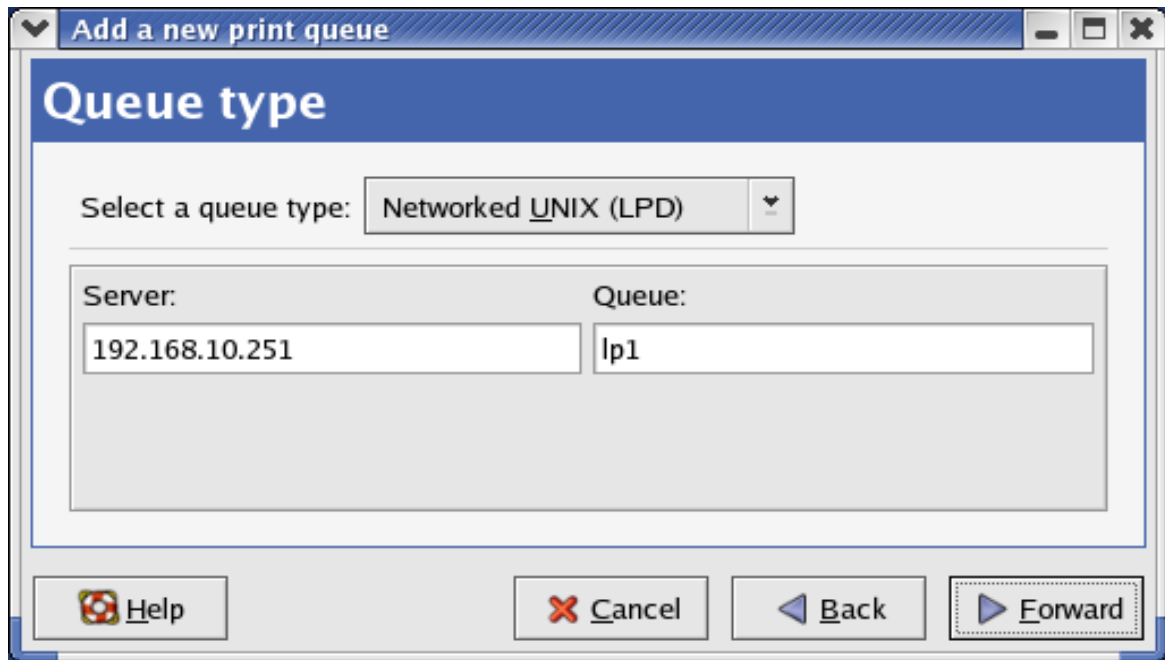

9. In the **Queue Type** field, choose **Networked UNIX**.
10. In the **Server** field, type the IP address of print server
11. In the **Queue** field, type a print server's port name, which connect to the printer. For example: lp1.
12. Click **Forward** button.
13. In the **Printer** field, choose **Postscript Printer**.

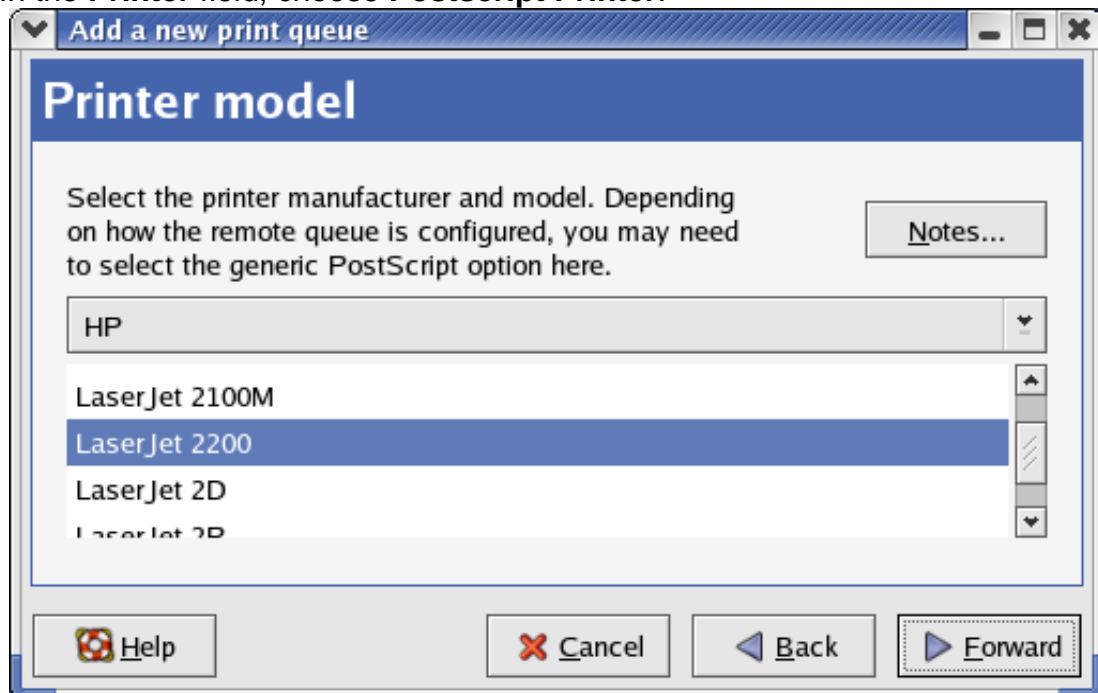

14. Choose the model of printer and click **Forward**.

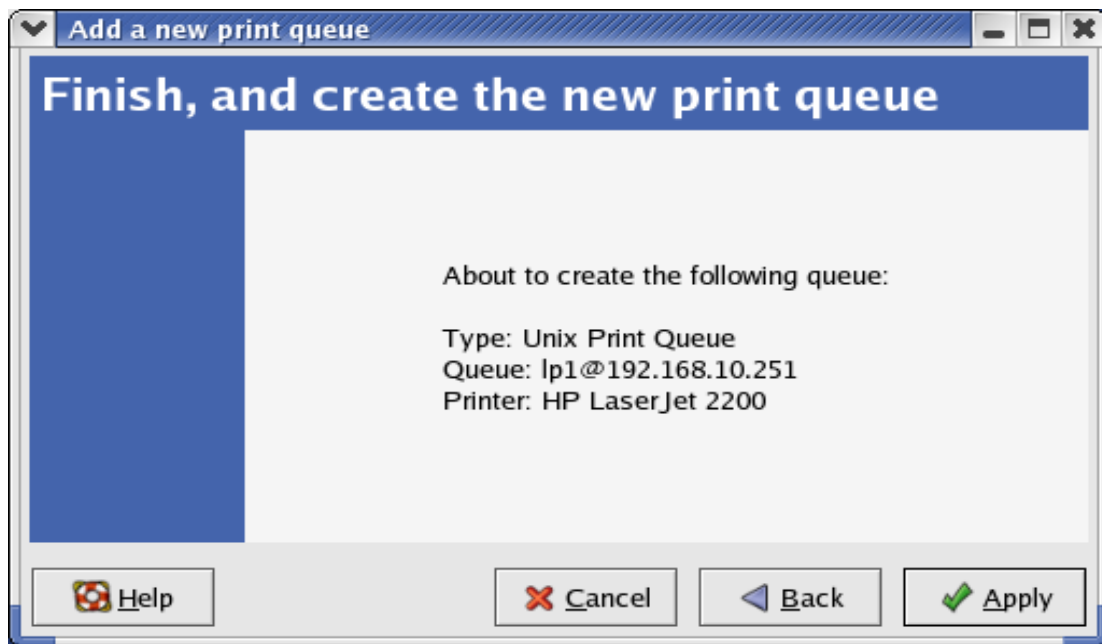

15. Done.

8. Upgrading Print Server

Overview

Upgrading print server will allow you to upgrade its firmware inside the print server while the newer software version of the print server is available from your local dealer. Depending on the different systems users might use, this chapter is divided into several Sections; please refer to the following lists for your systems.

1. *Upgrading the print server from PSAdmin*
2. *Upgrading the print server from Windows NT/2000/XP/2003*
3. *Upgrading the print server from UNIX system*
4. *Upgrading the print server from WEB browser*

Note: 1. Before you proceed to upgrade the print server, please ensure that the necessary binary file is located on your current working directory.
2. Before upgrading the print server, ensure that it is not printing jobs. You have to wait until the print job is finished before you can proceed.
3. Be careful not to interrupt the file transfer. If the transfer is interrupted, the print server may have to be re-initialized by your dealer.

Upgrading the print server from PSAdmin

1. Log into your NetWare file server as a Supervisor (Admin.) or equivalent.
2. Ensure binary file is located in the PSAdmin directory.
3. Run **PSAdmin** from your Windows PC.
4. Click the **Upgrade** icon on tool bar.

Upgrading the print server from Windows NT/2000/XP/2003 (Through TCP/IP)

1. Ensure binary file is located in your current working directory.
2. At NT/2000/XP/2003's DOS prompt, and type "**tftp -i <print server's IP address> put mpsXX.bin**".

3. Wait for the transfer successful message.
4. Done.

Upgrading the print server from UNIX (Through TCP/IP)

1. Log in as root
2. Ensure binary file is located in your current working directory.
3. Type “**tftp <print server’s IP address>**”.
4. At tftp prompt, type “**get upgrade**”.
5. Change to binary mode.
6. At tftp prompt, type “**put mpsXX.bin**”.
7. Wait for the file transfer to complete.
8. Quit from tftp.
9. Done.

Upgrading the print server from Browser

1. Ensure binary file is located in your current working directory.
2. Enter the IP address of the print server as the URL.
3. Click **Misc**, and then choose **Firmware Upgrade**, it then as shown in the following picture.



4. Click **Browse...** and select the firmware file.
5. Click **Upgrade**.
6. Done.

9. Troubleshooting

General Troubleshooting Overview

The most common problems, which cause the print server to perform improperly, are covered in this chapter. If a problem still exists after reading this chapter, please contact your dealer for technical support.

LED Light Indicators

The print server is equipped with LED lights to assist in diagnosing problems that are the result of the network and/or the print server hardware itself.

Status (Orange)

When the print server unit is powered on, the **Status** LED will flash five times as part of the unit's **Power On Self Test (POST)**. This indicates that the print server hardware is properly configured.

Note: Make sure that the LED flashes five times (**POST**) upon connecting the power. If the unit does not flash five times, contact your dealer for a replacement or repair.

LAN (Green: 100Mbps; Orange: 10Mbps)

USB (Green: USB2.0; Orange: USB1.1)

Print server is being connected with USB printer.

Power Related Problems

The print server requires an external AC power adapter in order for it to function. If you have a power problem, check to see whether the power cord or its connectors are damaged. More importantly, check to see that the AC power adapter included with the print server matches the AC voltage in your country or area. Using an incorrect AC adapter will damage your print server.

Print Port Related Problems

Printing data failure may be caused by a loose connection of the print server to the USB port of the printer. Check to see if any of the pins on the USB connector are damaged. In addition,

check the cable connection. If the pins are damaged, contact your dealer for a replacement connector.

Windows 95/98/Me/NT/2000/XP/2003 Troubleshooting

Multi-Segment LAN Environment Installation (through the Network Print Port)

If your print server and Windows 95/98/Me/NT/2000/XP/2003 are located on two different segments, and your Windows NT server is used as the router/gateway you will need to implement the following procedures in order for your print server to function properly:

- Add the RIP for NWLink IPX/SPX compatible transport. See *RIP for NWLink IPX/SPX compatible transport Installation Procedure* later in this section.
- Add the frame type 802.2 for both Ethernet adapters. See *Multi-Segment Frame Type 802.2 Installation* later in this section.

RIP for NWLink IPX/SPX compatible transport Installation Procedure

1. From your Windows NT server that is used as a router, select **Start** from the bottom left hand corner of the screen.
2. Select **Settings**.
3. Select **Control Panel**.
4. Double-click the **Network** icon.
5. Select **Services**.
6. Select **Add**.
7. In the Select Network Service box, select the **RIP for NWLink IPX/SPX compatible transport**. Click **OK**.
8. Follows the directions on the screen.
9. Done.

Multi-Segment Frame Type 802.2 Installation

1. From your Windows NT server that is used as a router, select **Start** from the bottom left hand corner of the screen.
2. Point to **Settings**, and select **Control Panel**.
3. Double-click the **Network** icon.
4. Select **Protocols**. Select the **NWLink IPX/SPX Compatible Transport**.
5. Select **Properties**.
6. Select your (first) network interface card and select **Manual Frame Type Detection**.
7. Click **Add**.
8. In the **Frame Type** field, select **Ethernet 802.2**.
9. In the **Network Number** field, type in an unique 8-digit hexadecimal network number. For example: 12345ABC.
10. Select **Add**.
11. Repeat the Steps 8-12 for the other Ethernet adapter.
12. **Restart the computer**.
13. Done.

Moving the print server to A New Segment

If the print server is moved from one network segment to another after the initial installation, through the Network Print Port, the print server must be reconfigured on the original Windows NT server or on each Windows 95/98 computer using this print server in order for the print server's driver on each computer to re-establish a new connection.

Print Server Reconfiguration Procedure on Windows 95/98/Me

1. Click **Start** on the bottom left hand corner of the screen.
2. Select **Settings** and select **Printers**.
3. Select your printer connected to the print server, and right-click the printer icon. Select **Properties**.
4. Click **Details** tab.
5. Click **Port Settings** as shown in the picture below. The print server will be displayed on the next print server's configuration screen.

Find your original print server according to its Port Name or other distinguished name and click this print server.

6. Click **OK** and it returns to the printer's Properties page.
7. Click **OK**.
8. Done.

Print server Reconfiguration Procedure on Windows NT

1. Click **Start** on the bottom left hand corner of the screen.
2. Select **Settings** and select **Printers**.
3. Select your printer connected to the print server, and right-click the printer icon. Select **Properties**.
4. Click Ports tab.
5. Click **Configure Port**. The print server will be shown on the next screen.
6. Find your original print server according to its Port Name or other distinguished name and click this print server.
7. Click **OK** and it returns to the printer's Properties page.
8. Click **OK**.
9. Done!

Moving Your Computer to A New Segment

If you are using the print server through the Network Print Port on your NT or Windows 95/98/Me computer and your computer is going to be moved onto another segment, you have to reconfigure the print server on your computer to use your print server. However, this situation is like moving the print server to a new segment. Please refer to the *"Moving the print server to a new segment"* section for more detailed reconfiguration instructions.

Novell NetWare Troubleshooting

Many printing problems can be traced back to incorrect or incomplete print server installations. *It is always wise to check the installation configurations first.*

In some cases, if necessary, delete the print server, print queue(s) or other setting(s). Next recreate the necessary parameters or reconfigure the print server by running the PSAdmin.

TCP/IP Troubleshooting

When you are configuring a new print server on your NT/UNIX server through LPR Port printing under TCP/IP protocol, you might encounter the following problem in your initial installation steps:

" I can do the "arp" command. However, when I am going to ping or tftp the print server, it always shows Request timed out. I have checked the print server's power and it exactly passed the POST. Besides, the network cabling is OK. As such, I can't do tftp command to get and put the print server's configuration file and save its IP address permanently. I can't, therefore, continue installing the print server."

Regarding this problem, there are three possible causes:

A. The print server's Node ID you specified in the "arp" command is not correct.

If this is the case, please ensure the Node ID field in the corresponding entry of the print server's IP address in NT's ARP cache table is correct by typing the following command at NT's DOS prompt. "arp -a"

If the Node ID shown on the screen doesn't match the print server's Node ID, please follow the instructions below to reset the entry.

1. At NT's DOS prompt, type "arp -d <print server's IP address>" to delete the current entry.
2. Type "arp -s <print server's IP> <print server's Node ID>" to specify a new ARP entry.
3. Refer to Chapter 7 for the detailed instructions to complete the installation.

B. The print server's IP address is duplicated or is as same as another computer's IP address on the network.

If this is the case, please consult your network administrator to obtain an unused IP address for your print server.

C. The print server is on one segment and your Windows NT server is on the other segment.

(This troubleshooting guide will also apply to a multiple-segmented network while installing the print server)

For example, assuming the print server is on Segment A, NT server is on Segment B, and there is a gateway computer between Segment A and Segment B. The network might be a complete TCP/IP network, or a hybrid of TCP/IP and IPX/SPX network.

If this is the case, you have to adopt the following steps, depending on which platform the gateway computer is.

a. If the gateway computer is a NT/UNIX server:

You have to do the same "arp" command to specify an entry on the NT/UNIX computer as a gateway in order for it to forward your subsequent "ping" or/and "tftp" commands to the print server.

b. If the gateway computer is a Novell NetWare file server:

1. Due to the presence of this NetWare file server, the IPX/SPX protocol might be used on your network. Therefore, we strongly suggest you run the **PSAdmin** from any client computer and select "**Manual Setup**" to specify the print server's IP address (For more detailed information about Manual Setup, please refer to Chapter 3).

2. If the solution described above is not applicable, you have to follow the instructions below to set up the print server's IP address.

For the purpose of explanation, we assume the NT server is on Segment A and its IP address is 192.72.214.66 (subnet mask: 255.255.255.224), the print server is going to be installed on Segment B, with IP address, for example, 192.72.214.100.

1. Find an unused IP address on Segment A for temporary use in the following steps, for example, 192.72.214.68.

2. Connect your print server to Segment A as a networked node.

3. On your NT server, type, for example, "arp -s 192.72.214.68 00-40-01-3F-02-AB". Please note, in this arp command you have to type 192.72.214.68 on purpose. Do not type this IP address as 192.72.214.100.

4. Type "tftp 192.722.214.68 get config.txt". The configuration file will then be retrieved and transferred to your NT server.

5. Type "edit config.txt" to modify this configuration file.

6. In your editor, modify "**BoxIPAddress**" field from "0.0.0.0" to "192.72.214.100". **Leave other options as default and do not change their values.** When done, save this new file and quit from your editor. **Please note, in this step you must specify an IP address which is valid on Segment B, such as 192.72.214.100 in this example, rather than 192.72.214.68.**
7. Type, for example, "tftp 192.72.214.68 put config.txt" to save this new configuration back to print server.
8. Move the print server back to the Segment B.
9. Done!

Appendix:

SMB Printing with Windows XP

1. Enable the SMB settings from the print server's WEB configuration. Assume your computers use the "**WORKGROUP**" as the SMB workgroup name in Windows. Please assign the same SMB name to your print server. If print server uses the different SMB name from computers', the SMB printing won't active.

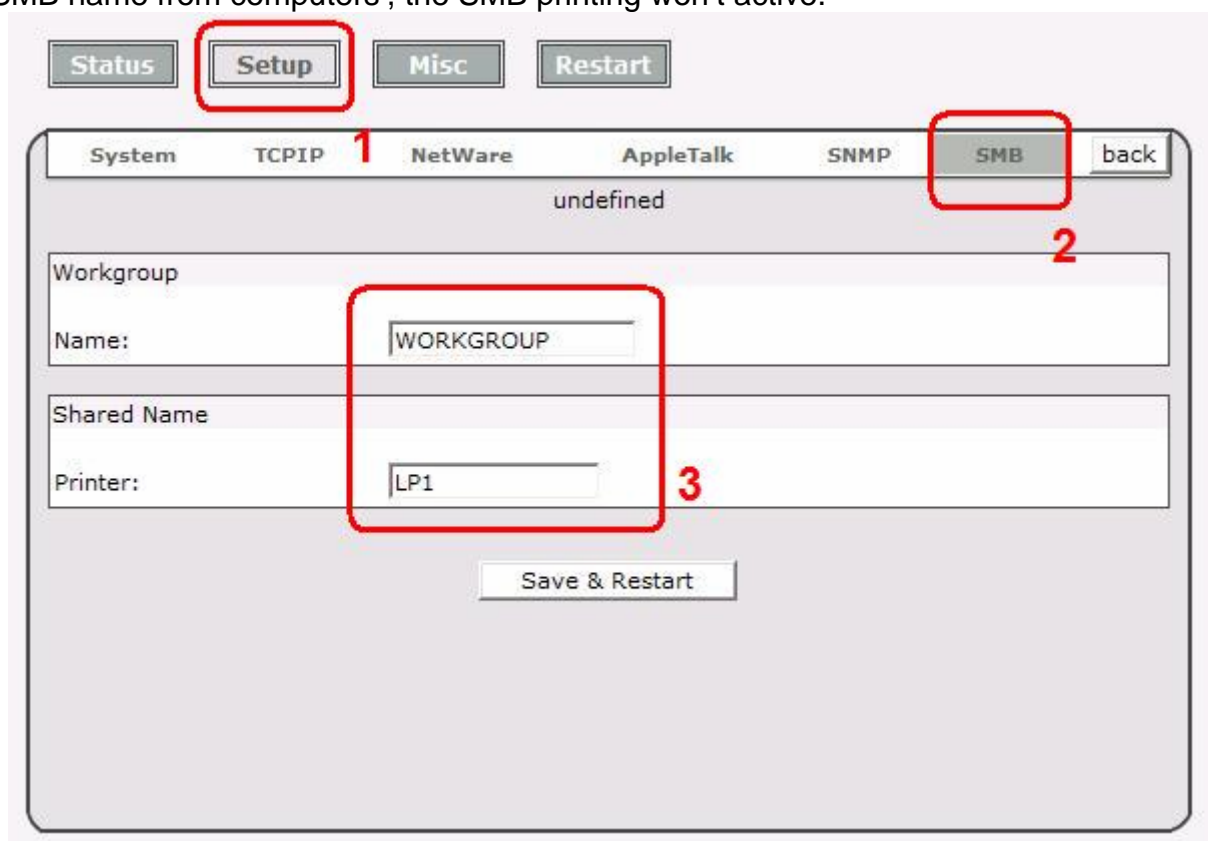

2. Now you can find the print server from the SMB workgroup of Windows. Then, double click it.

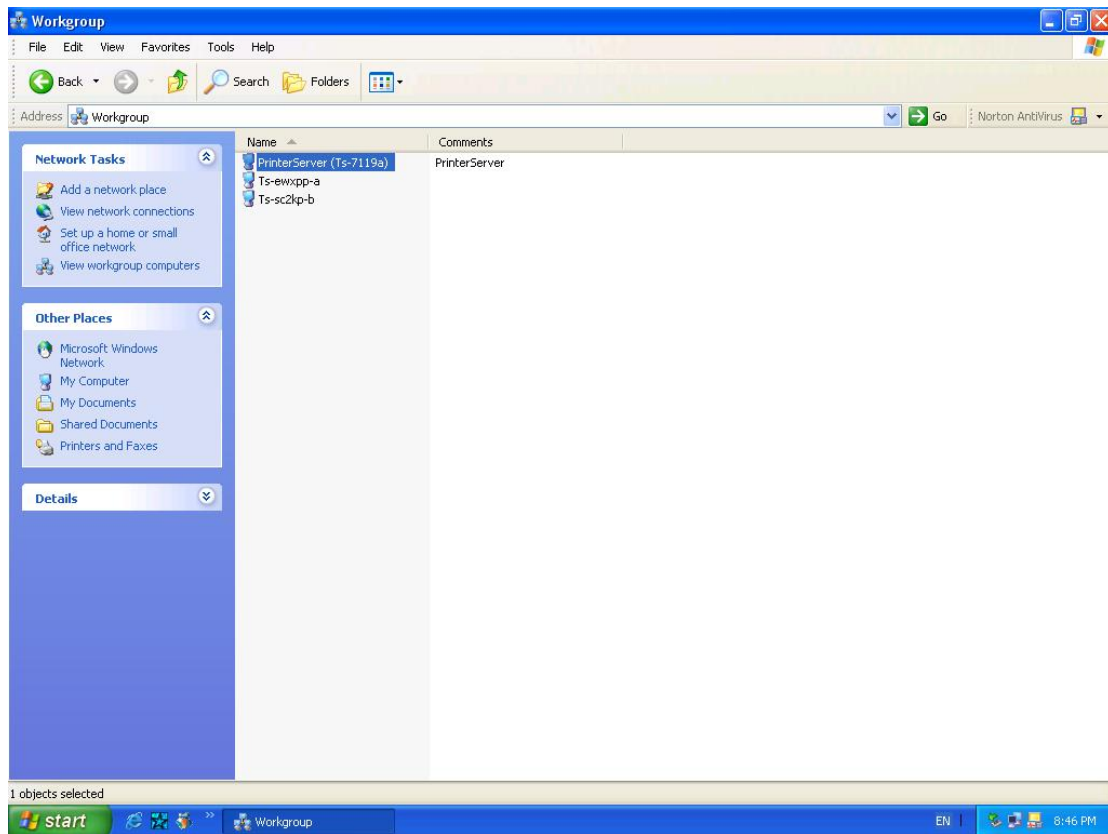

3. Double click it again.

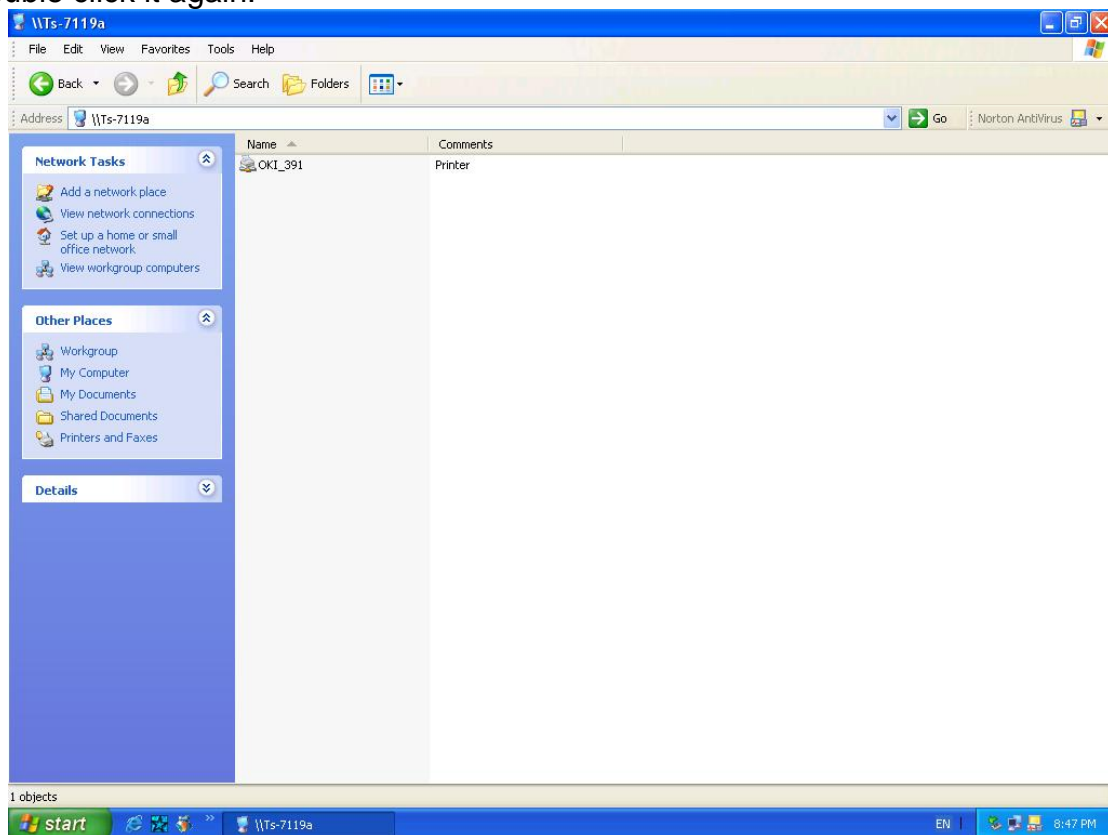

4. Now you have to install the printer's driver.

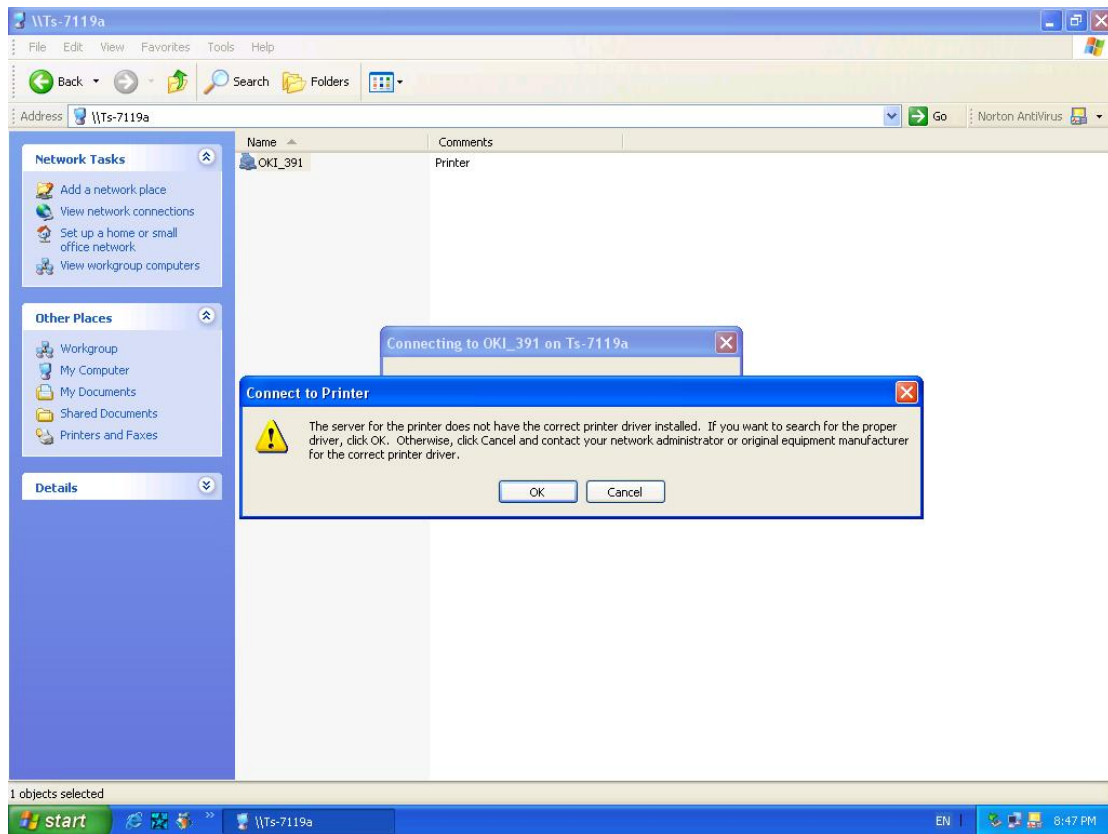

5. Choose it from the “Add Printer Wizard”.

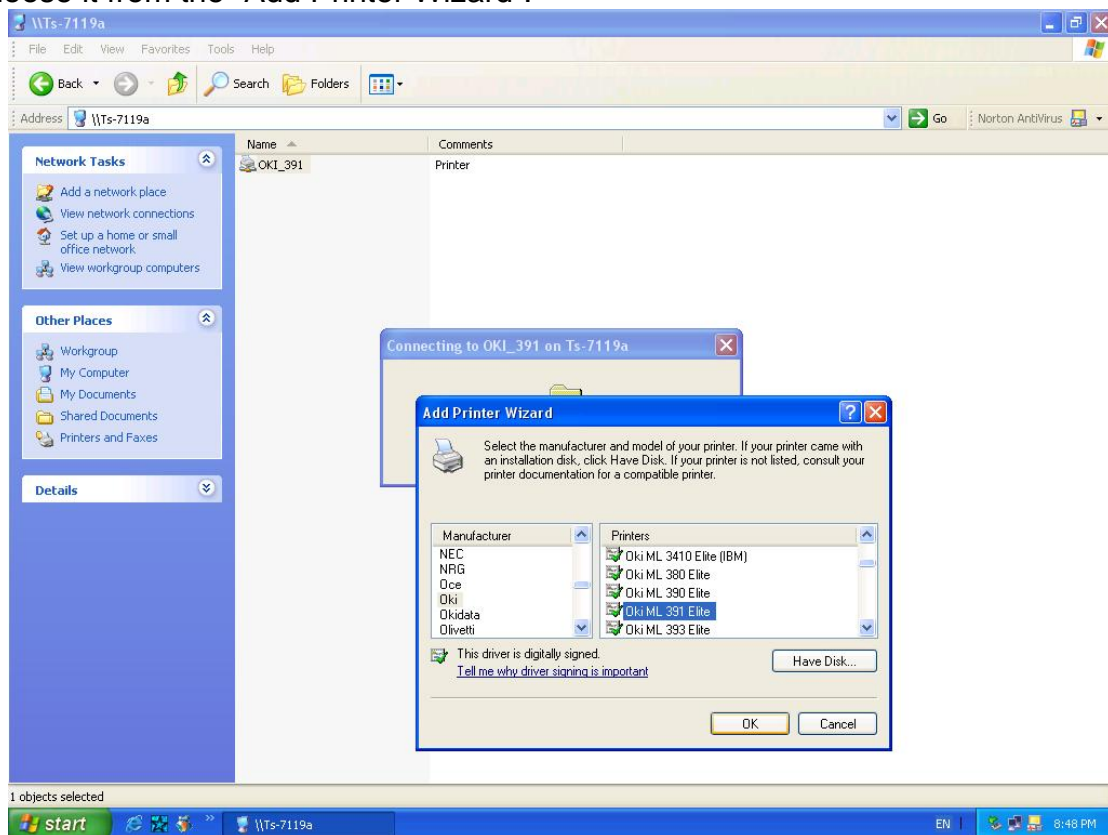

6. Install printer successfully.

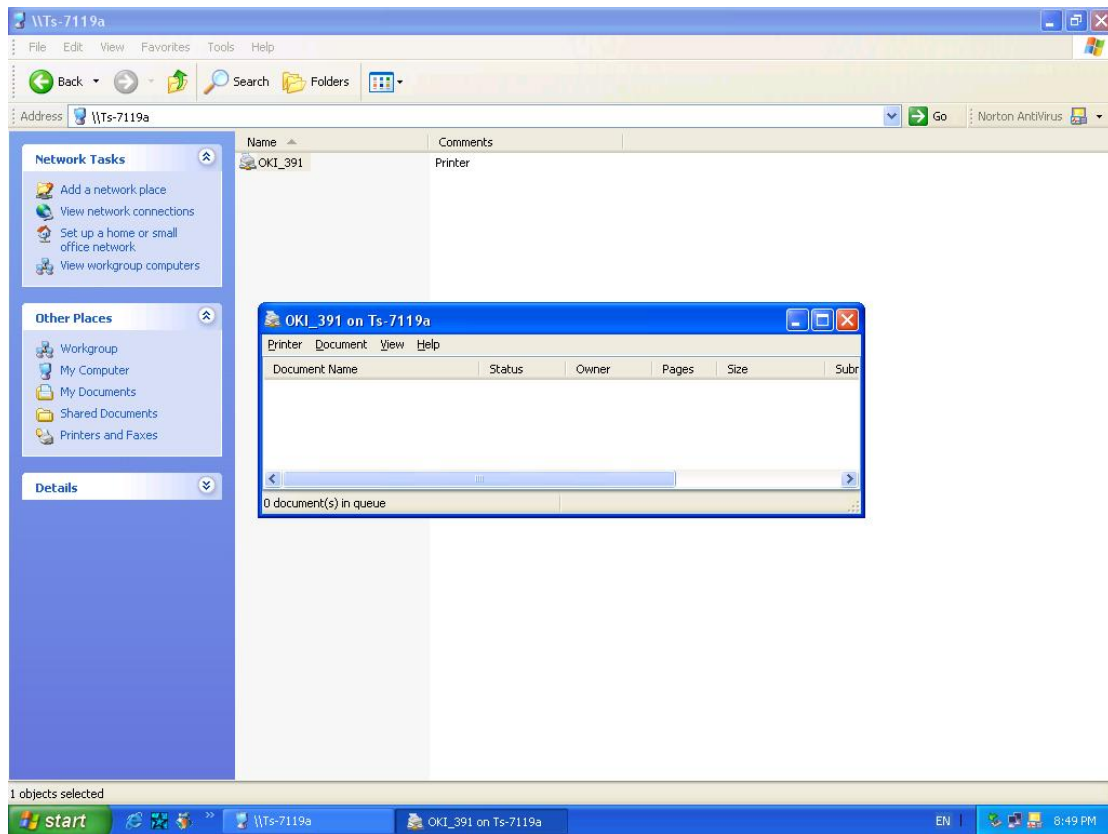

7. Now, you can find your printer's icon and you can use the SMB printing mode.

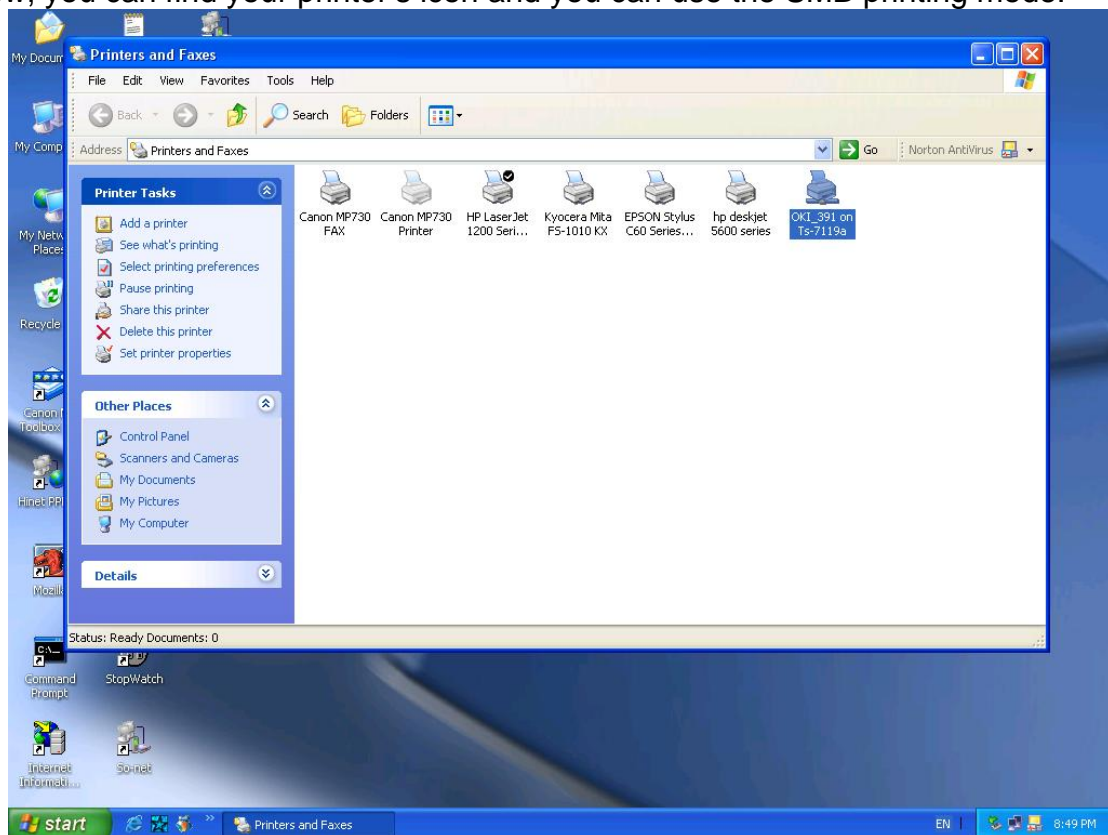

Reset Button

Reboot the Print server:

1. Verify the power of print server is turned on.
2. Press the reset button once, and then release it.

WARNING: This will restart the print server and stop all on-going and pending print jobs!

Perform a Factory Default:

1. Disconnect the external power adapter.
2. Hold down the reset button.
3. Reconnect the external reset button. Wait about 5~6 seconds.
4. Release the reset button.
5. The print server will restart.

WARNING: This will erase all settings of print server to default and should be performed with caution!

Frequently Asked Questions

Question A

Print jobs are sent to the print queue successfully, but fail to be sent to the printer.

Possible explanations

1. The Print server Name/Print Queue configuration in PCONSOLE is incorrect.
2. The Print server name specified and stored in the print server memory doesn't match the same one set in PCONSOLE.
3. The network cable or power adapter connected to the print server is loose or disconnected.
4. The printer is off-line, jammed or out of paper.

Solutions

1. Check all the information in PCONSOLE.
2. Check all the information of the print server by running PSAdmin.
3. Check to see that if the network cabling and power adapter are properly connected.
4. Recheck the print server connection by running the PSAdmin. It should read "Connected."

Question B

Print jobs start printing, but print very slowly or print unknown characters.

Possible explanation and solution

A printer driver is missing or is incompatible with that printer. Using a print driver that is not specific for the printer can cause printing errors. Install the proper printer driver. If these printer drivers are not available to you, please contact your printer manufacturer.

Question C

The upgrading process indication bar stops and does not seem to proceed again while upgrading the print server.

Possible Explanation

There might be a network problem. This causes the upgrading procedure to fail.

Solutions

1. Check the network cabling, especially from the workstation running the PSAdmin to the print server unit.
2. Run the PSAdmin and upgrade the print server again.

Question D

The Status LED light keeps blinking after POST.

Possible explanation and solution

The last upgrade process was not completed. The print server must be upgraded again by using the PSAdmin. Please see Chapter 3 for details.

Question E

The PSAdmin reports “Create Print server Error”, “Create Printer Error”, or “Create Print Queue Error” while using Auto Setup.

Possible Explanation

The print server name, the printer name, or the print queue name you specified in the **Auto Setup** dialogue box contains a space.

Solution

Check to see if there is a space in the print server name, the printer name, or the queue name. Type in a new name without a space between two characters or replace a space by a dash (-) or an underscore (_).

Question F

The PSAdmin reports “Print server Already Exists”, “Printer Already Exists”, or “Print Queue Already Exists” after specifying the print server name, or the print queue name in Auto Setup.

Possible Explanation

A same print server name or queue names exists in the specific NetWare file server as the one you specified in the **Auto Setup** dialogue box.

Solution

Specify a new print server name or queue name in the **Auto Setup**.

Question G

The setup Wizard can't find print server.

Possible Explanation

The Personal Firewall installed in your computer blocks the connection.

Solution

Please disable the Personal Firewall or adjust the security level to lower.

Additional Installation Instructions

Panasonic KX-P6100/6300/6500

If you are using a Panasonic KX-P6100/6300/6500 laser printer with the print server through the **Network Print Port** under Windows 95/98, please redirect the printer named "***Panasonic KX-P6100 PCL***" or "***Panasonic KX-P6300 PCL***", or "***Panasonic KX-P6500 PCL***" to the print server through the **Network Print Port**.

DO NOT redirect the printer named "Panasonic KX-P6100 GDI", "Panasonic KX-P6300 GDI", or "Panasonic KX-P6500 GDI" to the print server.

Please note that the print server doesn't support printing with host-based printers, e.g. CAPT, GDI, and PPA printers. Furthermore, the print server doesn't support any non-printing functions of MFP (Multiple Function Printer).