



# User Guide

Jetstream Smart Switches

T1500G-8T(TL-SG2008)/T1500-28PCT (TL-SL2428P)

TL-SG2210MP/TL-SG2210P

1910012728 REV3.2.0

January 2020

# CONTENTS

## About This Guide

|                        |   |
|------------------------|---|
| Intended Readers ..... | 1 |
| Conventions.....       | 1 |
| More Information ..... | 2 |

## Accessing the Switch

|   |    |
|---|----|
| Overview .....  | 4  |
| Web Interface Access.....                               | 5  |
| Login.....  | 5  |
| Save Config Function.....                               | 6  |
| Disable the Web Server .....                            | 7  |
| Change the Switch's IP Address and Default Gateway..... | 7  |
| Command Line Interface Access .....                     | 9  |
| Console Login (only for switch with console port).....  | 9  |
| Telnet Login.....                                       | 11 |
| SSH Login.....  | 12 |
| Disable Telnet Login .....                              | 16 |
| Disable SSH Login.....                                  | 17 |
| Copy running-config startup-config.....                 | 17 |
| Change the Switch's IP Address and Default Gateway..... | 18 |

## Managing System

|   |    |
|---|----|
| System.....                                     | 20 |
| Overview.....                                   | 20 |
| Supported Features.....                         | 20 |
| System Info Configurations .....                | 22 |
| Using the GUI .....                             | 22 |
| Viewing the System Summary.....                 | 22 |
| Configuring the Device Description.....         | 26 |
| Configuring the System Time .....               | 27 |
| Configuring the Daylight Saving Time.....       | 28 |
| Configuring LED (Only for Certain Devices)..... | 29 |
| Configuring the System IP .....                 | 30 |
| Configuring the System IPv6.....                | 31 |

|   |           |
|---|-----------|
| Using the CLI.....  | 33        |
| Viewing the System Summary.....                           | 33        |
| Configuring the Device Description.....                   | 34        |
| Configuring the System Time.....                          | 36        |
| Configuring the Daylight Saving Time.....                 | 38        |
| Configuring LED (Only for Certain Devices).....           | 40        |
| Configuring the System IP.....                            | 40        |
| Configuring System IPv6 Parameters.....                   | 41        |
| <b>User Management Configurations.....</b>                | <b>44</b> |
| Using the GUI.....  | 44        |
| Creating Accounts.....                                    | 44        |
| Configuring Enable Password.....                          | 45        |
| Using the CLI.....  | 46        |
| Creating Accounts.....                                    | 46        |
| Configuring Enable Password.....                          | 48        |
| <b>System Tools Configurations.....</b>                   | <b>50</b> |
| Using the GUI.....  | 50        |
| Configuring the Boot File.....                            | 50        |
| Restoring the Configuration of the Switch.....            | 52        |
| Backing up the Configuration File.....                    | 52        |
| Upgrading the Firmware.....                               | 53        |
| Rebooting the switch.....                                 | 54        |
| Resetting the Switch.....                                 | 55        |
| Using the CLI.....  | 55        |
| Configuring the Boot File.....                            | 55        |
| Restoring the Configuration of the Switch.....            | 57        |
| Backing up the Configuration File.....                    | 57        |
| Upgrading the Firmware.....                               | 58        |
| Rebooting the Switch.....                                 | 58        |
| Resetting the Switch.....                                 | 60        |
| <b>EEE Configuration.....</b>                             | <b>61</b> |
| Using the CLI.....  | 61        |
| <b>PoE Configurations (Only for Certain Devices).....</b> | <b>63</b> |
| Using the GUI.....  | 64        |
| Configuring the PoE Parameters Manually.....              | 64        |
| Configuring the PoE Parameters Using the Profile.....     | 67        |
| Using the CLI.....  | 70        |
| Configuring the PoE Parameters Manually.....              | 70        |

|   |           |
|---|-----------|
| Configuring the PoE Parameters Using the Profile..... | 72        |
| <b>SDM Template Configuration.....</b>                | <b>75</b> |
| Using the GUI .....                                   | 75        |
| Using the CLI.....                                    | 76        |
| <b>Time Range Configuration.....</b>                  | <b>78</b> |
| Using the GUI .....                                   | 78        |
| Adding Time Range Entries .....                       | 78        |
| Configuring Holiday .....                             | 80        |
| Using the CLI.....                                    | 81        |
| Adding Time Range Entries.....                        | 81        |
| Configuring Holiday .....                             | 82        |
| <b>Example for PoE Configurations .....</b>           | <b>84</b> |
| Network Requirements.....                             | 84        |
| Configuring Scheme.....                               | 84        |
| Using the GUI .....                                   | 84        |
| Using the CLI.....                                    | 87        |
| <b>Appendix: Default Parameters.....</b>              | <b>88</b> |

## **Managing Physical Interfaces**

|   |            |
|---|------------|
| <b>Physical Interface .....</b>               | <b>92</b>  |
| Overview.....                                 | 92         |
| Supported Features.....                       | 92         |
| <b>Basic Parameters Configurations.....</b>   | <b>93</b>  |
| Using the GUI .....                           | 93         |
| Using the CLI.....                            | 94         |
| <b>Port Isolation Configurations .....</b>    | <b>97</b>  |
| Using the GUI .....                           | 97         |
| Using the CLI.....                            | 98         |
| <b>Loopback Detection Configuration .....</b> | <b>100</b> |
| Using the GUI .....                           | 100        |
| Using the CLI.....                            | 102        |
| <b>Configuration Examples .....</b>           | <b>104</b> |
| Example for Port Isolation.....               | 104        |
| Network Requirements .....                    | 104        |
| Configuration Scheme.....                     | 104        |
| Using the GUI.....                            | 104        |
| Using the CLI .....                           | 106        |



|  |            |
|--|------------|
| Example for Loopback Detection.....      | 107        |
| Network Requirements .....               | 107        |
| Configuration Scheme.....                | 107        |
| Using the GUI.....                       | 108        |
| Using the CLI .....                      | 109        |
| <b>Appendix: Default Parameters.....</b> | <b>110</b> |

## **Configuring LAG**

|  |            |
|--|------------|
| <b>LAG.....</b>                            | <b>112</b> |
| Overview.....                              | 112        |
| Supported Features .....                   | 112        |
| <b>LAG Configuration .....</b>             | <b>113</b> |
| Using the GUI .....                        | 114        |
| Configuring Load-balancing Algorithm ..... | 114        |
| Configuring Static LAG or LACP.....        | 115        |
| Using the CLI.....                         | 117        |
| Configuring Load-balancing Algorithm ..... | 117        |
| Configuring Static LAG or LACP.....        | 118        |
| <b>Configuration Example .....</b>         | <b>122</b> |
| Network Requirements.....                  | 122        |
| Configuration Scheme .....                 | 122        |
| Using the GUI .....                        | 123        |
| Using the CLI.....                         | 124        |
| <b>Appendix: Default Parameters.....</b>   | <b>126</b> |

## **Managing MAC Address Table**

|  |            |
|--|------------|
| <b>MAC Address Table .....</b>                           | <b>128</b> |
| Overview.....  | 128        |
| Supported Features .....                                 | 128        |
| <b>MAC Address Configurations .....</b>                  | <b>129</b> |
| Using the GUI .....                                      | 129        |
| Adding Static MAC Address Entries .....                  | 129        |
| Modifying the Aging Time of Dynamic Address Entries..... | 131        |
| Adding MAC Filtering Address Entries.....                | 132        |
| Viewing Address Table Entries.....                       | 132        |
| Using the CLI.....                                       | 133        |
| Adding Static MAC Address Entries .....                  | 133        |

|  |            |
|--|------------|
| Modifying the Aging Time of Dynamic Address Entries..... | 134        |
| Adding MAC Filtering Address Entries.....                | 135        |
| <b>Appendix: Default Parameters.....</b>                 | <b>137</b> |

## **Configuring 802.1Q VLAN**

|  |            |
|--|------------|
| <b>Overview .....</b>                                | <b>139</b> |
| <b>802.1Q VLAN Configuration.....</b>                | <b>140</b> |
| Using the GUI.....                                   | 141        |
| Configuring the VLAN.....                            | 141        |
| Configuring the Port Parameters for 802.1Q VLAN..... | 142        |
| Using the CLI.....                                   | 143        |
| Creating a VLAN .....                                | 143        |
| Adding the Port to the Specified VLAN.....           | 144        |
| Configuring the Port.....                            | 145        |
| <b>Configuration Example .....</b>                   | <b>147</b> |
| Network Requirements.....                            | 147        |
| Configuration Scheme .....                           | 147        |
| Network Topology.....                                | 148        |
| Using the GUI .....                                  | 148        |
| Using the CLI.....                                   | 151        |
| <b>Appendix: Default Parameters .....</b>            | <b>154</b> |

## **Configuring MAC VLAN**

|  |            |
|--|------------|
| <b>Overview .....</b>                    | <b>156</b> |
| <b>MAC VLAN Configuration.....</b>       | <b>157</b> |
| Using the GUI.....                       | 157        |
| Configuring 802.1Q VLAN .....            | 157        |
| Binding the MAC Address to the VLAN..... | 157        |
| Enabling MAC VLAN for the Port.....      | 158        |
| Using the CLI.....                       | 159        |
| Configuring 802.1Q VLAN .....            | 159        |
| Binding the MAC Address to the VLAN..... | 159        |
| Enabling MAC VLAN for the Port.....      | 160        |
| <b>Configuration Example .....</b>       | <b>161</b> |
| Network Requirements.....                | 161        |
| Configuration Scheme .....               | 161        |
| Using the GUI .....                      | 162        |

|                                   |     |
|-----------------------------------|-----|
| Using the CLI.....                | 167 |
| Appendix: Default Parameters..... | 171 |

## Configuring Protocol VLAN

|                                   |     |
|-----------------------------------|-----|
| Overview .....                    | 173 |
| Protocol VLAN Configuration.....  | 174 |
| Using the GUI .....               | 174 |
| Configuring 802.1Q VLAN .....     | 174 |
| Creating Protocol Template .....  | 175 |
| Configuring Protocol VLAN.....    | 176 |
| Using the CLI.....                | 177 |
| Configuring 802.1Q VLAN .....     | 177 |
| Creating a Protocol Template..... | 177 |
| Configuring Protocol VLAN.....    | 178 |
| Configuration Example .....       | 181 |
| Network Requirements.....         | 181 |
| Configuration Scheme .....        | 181 |
| Using the GUI .....               | 183 |
| Using the CLI.....                | 188 |
| Appendix: Default Parameters..... | 193 |

## Configuring GVRP

|                                   |     |
|-----------------------------------|-----|
| Overview .....                    | 195 |
| GVRP Configuration.....           | 196 |
| Using the GUI .....               | 197 |
| Using the CLI.....                | 198 |
| Configuration Example .....       | 201 |
| Network Requirements.....         | 201 |
| Configuration Scheme .....        | 201 |
| Using the GUI .....               | 202 |
| Using the CLI.....                | 206 |
| Appendix: Default Parameters..... | 210 |

## Configuring Layer 2 Multicast

|                         |     |
|-------------------------|-----|
| Layer 2 Multicast.....  | 212 |
| Overview.....           | 212 |
| Supported Features..... | 214 |

|  |            |
|--|------------|
| <b>IGMP Snooping Configuration</b> .....               | <b>215</b> |
| Using the GUI .....                                    | 215        |
| Configuring IGMP Snooping Globally .....               | 215        |
| Configuring IGMP Snooping for VLANs .....              | 216        |
| Configuring IGMP Snooping for Ports.....               | 220        |
| Configuring Hosts to Statically Join a Group .....     | 220        |
| Using the CLI .....                                    | 221        |
| Configuring IGMP Snooping Globally .....               | 221        |
| Configuring IGMP Snooping for VLANs .....              | 223        |
| Configuring IGMP Snooping for Ports.....               | 228        |
| Configuring Hosts to Statically Join a Group .....     | 229        |
| <b>MLD Snooping Configuration</b> .....                | <b>231</b> |
| Using the GUI .....                                    | 231        |
| Configuring MLD Snooping Globally.....                 | 231        |
| Configuring MLD Snooping for VLANs.....                | 232        |
| Configuring MLD Snooping for Ports .....               | 235        |
| Configuring Hosts to Statically Join a Group .....     | 236        |
| Using the CLI .....                                    | 236        |
| Configuring MLD Snooping Globally.....                 | 236        |
| Configuring MLD Snooping for VLANs.....                | 237        |
| Configuring MLD Snooping for Ports .....               | 242        |
| Configuring Hosts to Statically Join a Group .....     | 243        |
| <b>MVR Configuration</b> .....                         | <b>245</b> |
| Using the GUI .....                                    | 245        |
| Configuring 802.1Q VLANs.....                          | 245        |
| Configuring MVR Globally.....                          | 246        |
| Adding Multicast Groups to MVR.....                    | 247        |
| Configuring MVR for the Port .....                     | 248        |
| (Optional) Adding Ports to MVR Groups Statically ..... | 249        |
| Using the CLI .....                                    | 250        |
| Configuring 802.1Q VLANs.....                          | 250        |
| Configuring MVR Globally.....                          | 250        |
| Configuring MVR for the Ports .....                    | 252        |
| <b>Multicast Filtering Configuration</b> .....         | <b>255</b> |
| Using the GUI .....                                    | 255        |
| Creating the Multicast Profile.....                    | 255        |
| Configure Multicast Filtering for Ports .....          | 257        |
| Using the CLI .....                                    | 258        |

|   |            |
|---|------------|
| Creating the Multicast Profile.....                           | 258        |
| Binding the Profile to Ports.....                             | 261        |
| <b>Viewing Multicast Snooping Information.....</b>            | <b>265</b> |
| Using the GUI.....  | 265        |
| Viewing IPv4 Multicast Table.....                             | 265        |
| Viewing IPv4 Multicast Statistics on Each Port.....           | 266        |
| Viewing IPv6 Multicast Table.....                             | 267        |
| Viewing IPv6 Multicast Statistics on Each Port.....           | 268        |
| Using the CLI.....  | 269        |
| Viewing IPv4 Multicast Snooping Information.....              | 269        |
| Viewing IPv6 Multicast Snooping Configurations.....           | 269        |
| <b>Configuration Examples.....</b>                            | <b>270</b> |
| Example for Configuring Basic IGMP Snooping.....              | 270        |
| Network Requirements.....                                     | 270        |
| Configuration Scheme.....                                     | 270        |
| Using the GUI.....  | 271        |
| Using the CLI.....  | 273        |
| Example for Configuring MVR.....                              | 275        |
| Network Requirements.....                                     | 275        |
| Network Topology.....   | 275        |
| Configuration Scheme.....                                     | 276        |
| Using the GUI.....  | 276        |
| Using the CLI.....  | 279        |
| Example for Configuring Unknown Multicast and Fast Leave..... | 282        |
| Network Requirement.....                                      | 282        |
| Configuration Scheme.....                                     | 283        |
| Using the GUI.....  | 283        |
| Using the CLI.....  | 285        |
| Example for Configuring Multicast Filtering.....              | 286        |
| Network Requirements.....                                     | 286        |
| Configuration Scheme.....                                     | 286        |
| Network Topology.....   | 287        |
| Using the GUI.....  | 287        |
| Using the CLI.....  | 291        |
| <b>Appendix: Default Parameters.....</b>                      | <b>294</b> |
| Default Parameters for IGMP Snooping.....                     | 294        |
| Default Parameters for MLD Snooping.....                      | 295        |
| Default Parameters for MVR.....                               | 296        |

|   |     |
|---|-----|
| Default Parameters for Multicast Filtering..... | 296 |
|---|-----|

## **Configuring Spanning Tree**

|   |            |
|---|------------|
| <b>Spanning Tree.....</b>                     | <b>298</b> |
| Overview.....                                 | 298        |
| Basic Concepts.....                           | 298        |
| STP/RSTP Concepts.....                        | 298        |
| MSTP Concepts.....                            | 302        |
| STP Security.....                             | 303        |
| <b>STP/RSTP Configurations.....</b>           | <b>306</b> |
| Using the GUI.....                            | 306        |
| Configuring STP/RSTP Parameters on Ports..... | 306        |
| Configuring STP/RSTP Globally.....            | 308        |
| Verifying the STP/RSTP Configurations.....    | 310        |
| Using the CLI.....                            | 312        |
| Configuring STP/RSTP Parameters on Ports..... | 312        |
| Configuring Global STP/RSTP Parameters.....   | 314        |
| Enabling STP/RSTP Globally.....               | 316        |
| <b>MSTP Configurations.....</b>               | <b>318</b> |
| Using the GUI.....                            | 318        |
| Configuring Parameters on Ports in CIST.....  | 318        |
| Configuring the MSTP Region.....              | 321        |
| Configuring MSTP Globally.....                | 325        |
| Verifying the MSTP Configurations.....        | 327        |
| Using the CLI.....                            | 328        |
| Configuring Parameters on Ports in CIST.....  | 328        |
| Configuring the MSTP Region.....              | 331        |
| Configuring Global MSTP Parameters.....       | 334        |
| Enabling Spanning Tree Globally.....          | 336        |
| <b>STP Security Configurations.....</b>       | <b>338</b> |
| Using the GUI.....                            | 338        |
| Using the CLI.....                            | 339        |
| Configuring the STP Security.....             | 339        |
| <b>Configuration Example for MSTP.....</b>    | <b>342</b> |
| Network Requirements.....                     | 342        |
| Configuration Scheme.....                     | 342        |
| Using the GUI.....                            | 343        |

|  |            |
|--|------------|
| Using the CLI.....                       | 350        |
| <b>Appendix: Default Parameters.....</b> | <b>357</b> |

## **Configuring LLDP**

|  |            |
|--|------------|
| <b>LLDP.....</b>                         | <b>360</b> |
| Overview.....                            | 360        |
| Supported Features.....                  | 360        |
| <b>LLDP Configurations .....</b>         | <b>361</b> |
| Using the GUI .....                      | 361        |
| Configuring LLDP Globally.....           | 361        |
| Configuring LLDP For the Port .....      | 363        |
| Using the CLI.....                       | 364        |
| Global Config.....                       | 364        |
| Port Config.....                         | 366        |
| <b>LLDP-MED Configurations.....</b>      | <b>369</b> |
| Using the GUI .....                      | 369        |
| Configuring LLDP Globally .....          | 369        |
| Configuring LLDP-MED Globally .....      | 369        |
| Configuring LLDP-MED for Ports.....      | 370        |
| Using the CLI.....                       | 372        |
| Global Config.....                       | 372        |
| Port Config.....                         | 373        |
| <b>Viewing LLDP Settings.....</b>        | <b>376</b> |
| Using GUI.....                           | 376        |
| Viewing LLDP Device Info .....           | 376        |
| Viewing LLDP Statistics .....            | 380        |
| Using CLI .....                          | 381        |
| <b>Viewing LLDP-MED Settings .....</b>   | <b>382</b> |
| Using GUI.....                           | 382        |
| Using CLI .....                          | 385        |
| <b>Configuration Example .....</b>       | <b>386</b> |
| Network Requirements.....                | 386        |
| Network Topology.....                    | 386        |
| Configuration Scheme .....               | 386        |
| Using the GUI .....                      | 386        |
| Using CLI .....                          | 387        |
| <b>Appendix: Default Parameters.....</b> | <b>394</b> |

## Configuring DHCP Service

|   |            |
|---|------------|
| <b>DHCP</b> .....                                   | <b>396</b> |
| Overview .....                                      | 396        |
| Supported Features .....                            | 396        |
| <b>DHCP Relay Configuration</b> .....               | <b>400</b> |
| Using the GUI .....                                 | 400        |
| Enabling DHCP Relay and Configuring Option 82 ..... | 400        |
| Configuring DHCP VLAN Relay .....                   | 402        |
| Using the CLI .....                                 | 403        |
| Enabling DHCP Relay .....                           | 403        |
| (Optional) Configuring Option 82 .....              | 404        |
| Configuring DHCP VLAN Relay .....                   | 406        |
| <b>DHCP L2 Relay Configuration</b> .....            | <b>408</b> |
| Using the GUI .....                                 | 408        |
| Enabling DHCP L2 Relay .....                        | 408        |
| Configuring Option 82 for Ports .....               | 409        |
| Using the CLI .....                                 | 410        |
| Enabling DHCP L2 Relay .....                        | 410        |
| Configuring Option 82 for Ports .....               | 411        |
| <b>Configuration Examples</b> .....                 | <b>414</b> |
| Example for DHCP VLAN Relay .....                   | 414        |
| Network Requirements .....                          | 414        |
| Configuration Scheme .....                          | 414        |
| Using the GUI .....                                 | 415        |
| Using the CLI .....                                 | 418        |
| Example for Option 82 in DHCP Relay .....           | 420        |
| Network Requirements .....                          | 420        |
| Configuration Scheme .....                          | 421        |
| Configuring the DHCP Relay Switch .....             | 422        |
| Configuring the DHCP Server .....                   | 425        |
| Example for DHCP L2 Relay .....                     | 426        |
| Network Requirements .....                          | 426        |
| Configuration Scheme .....                          | 427        |
| Configuring the DHCP Relay Switch .....             | 428        |
| Configuring the DHCP Server .....                   | 430        |
| <b>Appendix: Default Parameters</b> .....           | <b>433</b> |



## Configuring QoS

|  |            |
|--|------------|
| <b>QoS</b> .....                             | <b>436</b> |
| Overview.....                                | 436        |
| Supported Features.....                      | 436        |
| <b>Class of Service Configuration</b> .....  | <b>438</b> |
| Using the GUI.....                           | 439        |
| Configuring Port Priority.....               | 439        |
| Configuring 802.1p Priority.....             | 441        |
| Configuring DSCP Priority.....               | 443        |
| Specifying the Scheduler Settings.....       | 446        |
| Using CLI.....                               | 447        |
| Configuring Port Priority.....               | 447        |
| Configuring 802.1p Priority.....             | 449        |
| Configuring DSCP Priority.....               | 452        |
| Specifying the Scheduler Settings.....       | 456        |
| <b>Bandwidth Control Configuration</b> ..... | <b>459</b> |
| Using the GUI.....                           | 459        |
| Configuring Rate Limit.....                  | 459        |
| Configuring Storm Control.....               | 460        |
| Using the CLI.....                           | 461        |
| Configuring Rate Limit.....                  | 461        |
| Configuring Storm Control.....               | 462        |
| <b>Voice VLAN Configuration</b> .....        | <b>465</b> |
| Using the GUI.....                           | 465        |
| Configuring OUI Addresses.....               | 465        |
| Configuring Voice VLAN Globally.....         | 466        |
| Adding Ports to Voice VLAN.....              | 467        |
| Using the CLI.....                           | 468        |
| <b>Auto VoIP Configuration</b> .....         | <b>471</b> |
| Using the GUI.....                           | 471        |
| Using the CLI.....                           | 472        |
| <b>Configuration Examples</b> .....          | <b>476</b> |
| Example for Class of Service.....            | 476        |
| Network Requirements.....                    | 476        |
| Configuration Scheme.....                    | 476        |
| Using the GUI.....                           | 477        |
| Using the CLI.....                           | 479        |

|   |            |
|---|------------|
| Example for Voice VLAN .....              | 481        |
| Network Requirements .....                | 481        |
| Configuration Scheme .....                | 482        |
| Using the GUI .....                       | 482        |
| Using the CLI .....                       | 486        |
| Example for Auto VoIP .....               | 489        |
| Network Requirements .....                | 489        |
| Configuration Scheme .....                | 490        |
| Using the GUI .....                       | 490        |
| Using the CLI .....                       | 495        |
| <b>Appendix: Default Parameters .....</b> | <b>500</b> |

## **Configuring Access Security**

|  |            |
|--|------------|
| <b>Access Security .....</b>                 | <b>505</b> |
| Overview .....                               | 505        |
| Supported Features .....                     | 505        |
| <b>Access Security Configurations .....</b>  | <b>506</b> |
| Using the GUI .....                          | 506        |
| Configuring the Access Control Feature ..... | 506        |
| Configuring the HTTP Function .....          | 509        |
| Configuring the HTTPS Function .....         | 511        |
| Configuring the SSH Feature .....            | 514        |
| Configuring the Telnet Function .....        | 515        |
| Using the CLI .....                          | 516        |
| Configuring the Access Control Feature ..... | 516        |
| Configuring the HTTP Function .....          | 517        |
| Configuring the HTTPS Function .....         | 519        |
| Configuring the SSH Feature .....            | 522        |
| Configuring the Telnet Function .....        | 524        |
| <b>Appendix: Default Parameters .....</b>    | <b>525</b> |

## **Configuring AAA**

|                                 |            |
|---------------------------------|------------|
| <b>Overview .....</b>           | <b>528</b> |
| <b>AAA Configuration .....</b>  | <b>529</b> |
| Using the GUI .....             | 530        |
| Adding Servers .....            | 530        |
| Configuring Server Groups ..... | 532        |

|  |            |
|--|------------|
| Configuring the Method List.....                   | 532        |
| Configuring the AAA Application List.....          | 534        |
| Configuring Login Account and Enable Password..... | 534        |
| Using the CLI.....                                 | 535        |
| Adding Servers.....                                | 535        |
| Configuring Server Groups.....                     | 538        |
| Configuring the Method List.....                   | 539        |
| Configuring the AAA Application List.....          | 540        |
| Configuring Login Account and Enable Password..... | 543        |
| <b>Configuration Example .....</b>                 | <b>546</b> |
| Network Requirements.....                          | 546        |
| Configuration Scheme .....                         | 546        |
| Using the GUI.....                                 | 547        |
| Using the CLI.....                                 | 549        |
| <b>Appendix: Default Parameters.....</b>           | <b>552</b> |

## **Configuring 802.1x**

|  |            |
|--|------------|
| <b>Overview .....</b>                    | <b>555</b> |
| <b>802.1x Configuration.....</b>         | <b>556</b> |
| Using the GUI.....                       | 556        |
| Configuring the RADIUS Server.....       | 556        |
| Configuring 802.1x Globally.....         | 559        |
| Configuring 802.1x on Ports.....         | 560        |
| View the Authenticator State.....        | 562        |
| Using the CLI.....                       | 563        |
| Configuring the RADIUS Server.....       | 563        |
| Configuring 802.1x Globally.....         | 565        |
| Configuring 802.1x on Ports.....         | 567        |
| Viewing Authenticator State.....         | 569        |
| <b>Configuration Example .....</b>       | <b>571</b> |
| Network Requirements.....                | 571        |
| Configuration Scheme .....               | 571        |
| Network Topology.....                    | 571        |
| Using the GUI.....                       | 572        |
| Using the CLI.....                       | 574        |
| <b>Appendix: Default Parameters.....</b> | <b>577</b> |

## Configuring Port Security

|                                    |     |
|------------------------------------|-----|
| Overview .....                     | 579 |
| Port Security Configuration .....  | 580 |
| Using the GUI .....                | 580 |
| Using the CLI .....                | 581 |
| Appendix: Default Parameters ..... | 584 |

## Configuring ACL

|                                     |     |
|-------------------------------------|-----|
| Overview .....                      | 586 |
| ACL Configuration .....             | 587 |
| Using the GUI .....                 | 587 |
| Configuring Time Range .....        | 587 |
| Creating an ACL .....               | 587 |
| Configuring ACL Rules .....         | 588 |
| Configuring MAC ACL Rule .....      | 588 |
| Configuring IP ACL Rule .....       | 592 |
| Configuring Combined ACL Rule ..... | 596 |
| Configuring the IPv6 ACL Rule ..... | 601 |
| Configuring ACL Binding .....       | 605 |
| Using the CLI .....                 | 606 |
| Configuring Time Range .....        | 606 |
| Configuring ACL .....               | 606 |
| Configuring Policy .....            | 615 |
| Configuring ACL Binding .....       | 617 |
| Viewing ACL Counting .....          | 618 |
| Configuration Example for ACL ..... | 619 |
| Network Requirements .....          | 619 |
| Configuration Scheme .....          | 619 |
| Using the GUI .....                 | 620 |
| Using the CLI .....                 | 626 |
| Appendix: Default Parameters .....  | 628 |

## Configuring IPv4 IMPB

|                                    |     |
|------------------------------------|-----|
| IPv4 IMPB .....                    | 631 |
| Overview .....                     | 631 |
| Supported Features .....           | 631 |
| IP-MAC Binding Configuration ..... | 632 |

|   |            |
|---|------------|
| Using the GUI .....                         | 632        |
| Binding Entries Manually .....              | 632        |
| Binding Entries via ARP Scanning.....       | 633        |
| Binding Entries via DHCP Snooping.....      | 635        |
| Viewing the Binding Entries.....            | 637        |
| Using the CLI.....                          | 638        |
| Binding Entries Manually .....              | 638        |
| Binding Entries via DHCP Snooping.....      | 640        |
| Viewing Binding Entries .....               | 641        |
| <b>ARP Detection Configuration.....</b>     | <b>642</b> |
| Using the GUI .....                         | 642        |
| Adding IP-MAC Binding Entries .....         | 642        |
| Enabling ARP Detection .....                | 642        |
| Configuring ARP Detection on Ports .....    | 643        |
| Viewing ARP Statistics .....                | 644        |
| Using the CLI.....                          | 645        |
| Adding IP-MAC Binding Entries .....         | 645        |
| Enabling ARP Detection .....                | 645        |
| Configuring ARP Detection on Ports .....    | 646        |
| Viewing ARP Statistics.....                 | 648        |
| <b>IPv4 Source Guard Configuration.....</b> | <b>649</b> |
| Using the GUI .....                         | 649        |
| Adding IP-MAC Binding Entries .....         | 649        |
| Configuring IPv4 Source Guard .....         | 649        |
| Using the CLI.....                          | 650        |
| Adding IP-MAC Binding Entries .....         | 650        |
| Configuring IPv4 Source Guard .....         | 650        |
| <b>Configuration Examples.....</b>          | <b>652</b> |
| Example for ARP Detection .....             | 652        |
| Network Requirements .....                  | 652        |
| Configuration Scheme.....                   | 652        |
| Using the GUI.....                          | 653        |
| Using the CLI .....                         | 655        |
| Example for IP Source Guard.....            | 657        |
| Network Requirements .....                  | 657        |
| Configuration Scheme.....                   | 657        |
| Using the GUI.....                          | 658        |
| Using the CLI .....                         | 659        |

|   |            |
|---|------------|
| Appendix: Default Parameters.....           | 661        |
| <br>  |            |
| <b>Configuring IPv6 IMPB</b>                |            |
| <b>IPv6 IMPB .....</b>                      | <b>664</b> |
| Overview.....                               | 664        |
| Supported Features.....                     | 664        |
| <b>IPv6-MAC Binding Configuration.....</b>  | <b>666</b> |
| Using the GUI .....                         | 666        |
| Binding Entries Manually .....              | 666        |
| Binding Entries via ND Snooping.....        | 667        |
| Binding Entries via DHCPv6 Snooping.....    | 669        |
| Viewing the Binding Entries.....            | 670        |
| Using the CLI.....                          | 671        |
| Binding Entries Manually .....              | 671        |
| Binding Entries via ND Snooping.....        | 673        |
| Binding Entries via DHCPv6 Snooping.....    | 674        |
| Viewing Binding Entries .....               | 675        |
| <b>ND Detection Configuration .....</b>     | <b>676</b> |
| Using the GUI .....                         | 676        |
| Adding IPv6-MAC Binding Entries.....        | 676        |
| Enabling ND Detection.....                  | 676        |
| Configuring ND Detection on Ports.....      | 677        |
| Viewing ND Statistics.....                  | 677        |
| Using the CLI.....                          | 678        |
| Adding IPv6-MAC Binding Entries.....        | 678        |
| Enabling ND Detection.....                  | 678        |
| Configuring ND Detection on Ports.....      | 679        |
| Viewing ND Statistics.....                  | 680        |
| <b>IPv6 Source Guard Configuration.....</b> | <b>681</b> |
| Using the GUI .....                         | 681        |
| Adding IPv6-MAC Binding Entries.....        | 681        |
| Configuring IPv6 Source Guard .....         | 681        |
| Using the CLI.....                          | 682        |
| Adding IPv6-MAC Binding Entries.....        | 682        |
| Configuring IPv6 Source Guard .....         | 682        |
| <b>Configuration Examples .....</b>         | <b>684</b> |
| Example for ND Detection.....               | 684        |

|   |            |
|---|------------|
| Network Requirements .....                | 684        |
| Configuration Scheme .....                | 684        |
| Using the GUI .....                       | 685        |
| Using the CLI .....                       | 687        |
| Example for IPv6 Source Guard .....       | 688        |
| Network Requirements .....                | 688        |
| Configuration Scheme .....                | 689        |
| Using the GUI .....                       | 689        |
| Using the CLI .....                       | 691        |
| <b>Appendix: Default Parameters .....</b> | <b>692</b> |

## **Configuring DHCP Filter**

|  |            |
|--|------------|
| <b>DHCP Filter .....</b>                             | <b>695</b> |
| Overview .....                                       | 695        |
| Supported Features .....                             | 695        |
| <b>DHCPv4 Filter Configuration .....</b>             | <b>697</b> |
| Using the GUI .....                                  | 697        |
| Configuring the Basic DHCPv4 Filter Parameters ..... | 697        |
| Configuring Legal DHCPv4 Servers .....               | 698        |
| Using the CLI .....                                  | 699        |
| Configuring the Basic DHCPv4 Filter Parameters ..... | 699        |
| Configuring Legal DHCPv4 Servers .....               | 701        |
| <b>DHCPv6 Filter Configuration .....</b>             | <b>703</b> |
| Using the GUI .....                                  | 703        |
| Configuring the Basic DHCPv6 Filter Parameters ..... | 703        |
| Configuring Legal DHCPv6 Servers .....               | 704        |
| Using the CLI .....                                  | 705        |
| Configuring the Basic DHCPv6 Filter Parameters ..... | 705        |
| Configuring Legal DHCPv6 Servers .....               | 706        |
| <b>Configuration Examples .....</b>                  | <b>708</b> |
| Example for DHCPv4 Filter .....                      | 708        |
| Network Requirements .....                           | 708        |
| Configuration Scheme .....                           | 708        |
| Using the GUI .....                                  | 709        |
| Using the CLI .....                                  | 710        |
| Example for DHCPv6 Filter .....                      | 711        |
| Network Requirements .....                           | 711        |

|                                   |     |
|-----------------------------------|-----|
| Configuration Scheme.....         | 712 |
| Using the GUI.....                | 712 |
| Using the CLI.....                | 714 |
| Appendix: Default Parameters..... | 716 |

## Configuring DoS Defend

|                                   |     |
|-----------------------------------|-----|
| Overview.....                     | 718 |
| DoS Defend Configuration.....     | 719 |
| Using the GUI.....                | 719 |
| Using the CLI.....                | 720 |
| Appendix: Default Parameters..... | 723 |

## Monitoring the System

|                            |     |
|----------------------------|-----|
| Overview.....              | 725 |
| Monitoring the CPU.....    | 726 |
| Using the GUI.....         | 726 |
| Using the CLI.....         | 726 |
| Monitoring the Memory..... | 728 |
| Using the GUI.....         | 728 |
| Using the CLI.....         | 728 |

## Monitoring Traffic

|                                   |     |
|-----------------------------------|-----|
| Traffic Monitor.....              | 731 |
| Using the GUI.....                | 731 |
| Using the CLI.....                | 735 |
| Appendix: Default Parameters..... | 736 |

## Mirroring Traffic

|                                   |     |
|-----------------------------------|-----|
| Mirroring.....                    | 738 |
| Using the GUI.....                | 738 |
| Using the CLI.....                | 740 |
| Configuration Examples.....       | 742 |
| Network Requirements.....         | 742 |
| Configuration Scheme.....         | 742 |
| Using the GUI.....                | 742 |
| Using the CLI.....                | 743 |
| Appendix: Default Parameters..... | 745 |



## Configuring DLDP

|                                    |     |
|------------------------------------|-----|
| Overview .....                     | 747 |
| DLDP Configuration .....           | 748 |
| Using the GUI .....                | 748 |
| Using the CLI .....                | 750 |
| Appendix: Default Parameters ..... | 752 |

## Configuring SNMP & RMON

|   |     |
|---|-----|
| SNMP .....  | 754 |
| Overview .....                                    | 754 |
| Basic Concepts .....                              | 754 |
| SNMP Configurations .....                         | 758 |
| Using the GUI .....                               | 758 |
| Enabling SNMP .....                               | 758 |
| Creating an SNMP View .....                       | 759 |
| Creating SNMP Communities (For SNMP v1/v2c) ..... | 760 |
| Creating an SNMP Group (For SNMP v3) .....        | 761 |
| Creating SNMP Users (For SNMP v3) .....           | 762 |
| Using the CLI .....                               | 763 |
| Enabling SNMP .....                               | 763 |
| Creating an SNMP View .....                       | 765 |
| Creating SNMP Communities (For SNMP v1/v2c) ..... | 766 |
| Creating an SNMP Group (For SNMPv3) .....         | 767 |
| Creating SNMP Users (For SNMPv3) .....            | 769 |
| Notification Configurations .....                 | 771 |
| Using the GUI .....                               | 771 |
| Configuring the Information of NMS Hosts .....    | 771 |
| Enabling SNMP Traps .....                         | 773 |
| Using the CLI .....                               | 775 |
| Configuring the NMS Host .....                    | 775 |
| Enabling SNMP Traps .....                         | 777 |
| RMON .....  | 784 |
| RMON Configurations .....                         | 785 |
| Using the GUI .....                               | 785 |
| Configuring the Statistics Group .....            | 785 |
| Configuring History Group .....                   | 786 |
| Configuring Event Group .....                     | 787 |

|  |            |
|--|------------|
| Configuring Alarm Group.....             | 788        |
| Using the CLI.....                       | 790        |
| Configuring Statistics.....              | 790        |
| Configuring History.....                 | 792        |
| Configuring Event.....                   | 793        |
| Configuring Alarm.....                   | 794        |
| <b>Configuration Example.....</b>        | <b>797</b> |
| Network Requirements.....                | 797        |
| Configuration Scheme.....                | 798        |
| Using the GUI.....                       | 798        |
| Using the CLI.....                       | 803        |
| <b>Appendix: Default Parameters.....</b> | <b>809</b> |

## **Diagnosing the Device & Network**

|   |            |
|---|------------|
| <b>Diagnosing the Device.....</b>         | <b>814</b> |
| Using the GUI.....                        | 814        |
| Using the CLI.....                        | 815        |
| <b>Diagnosing the Network.....</b>        | <b>816</b> |
| Using the GUI.....                        | 816        |
| Troubleshooting with Ping Testing.....    | 816        |
| Troubleshooting with Tracert Testing..... | 817        |
| Using the CLI.....                        | 818        |
| Configuring the Ping Test.....            | 818        |
| Configuring the Tracert Test.....         | 819        |
| <b>Appendix: Default Parameters.....</b>  | <b>820</b> |

## **Configuring System Logs**

|  |            |
|--|------------|
| <b>Overview.....</b>                   | <b>822</b> |
| <b>System Logs Configurations.....</b> | <b>823</b> |
| Using the GUI.....                     | 824        |
| Configuring the Local Logs.....        | 824        |
| Configuring the Remote Logs.....       | 824        |
| Backing up the Logs.....               | 825        |
| Viewing the Log Table.....             | 826        |
| Using the CLI.....                     | 827        |
| Configuring the Local Logs.....        | 827        |
| Configuring the Remote Logs.....       | 828        |

|  |            |
|--|------------|
| <b>Configuration Example .....</b>       | <b>830</b> |
| Network Requirements.....                | 830        |
| Configuration Scheme .....               | 830        |
| Using the GUI .....                      | 830        |
| Using the CLI .....                      | 831        |
| <b>Appendix: Default Parameters.....</b> | <b>832</b> |

# About This Guide

This User Guide provides information for managing Jetstream Smart Switches. Please read this guide carefully before operation.

## Intended Readers

This Guide is intended for network managers familiar with IT concepts and network terminologies.

## Conventions

When using this guide, notice that features available in JetStream Smart Switches may vary by model and software version. Availability of JetStream Smart Switches may also vary by region or ISP. All images, steps, and descriptions in this guide are only examples and may not reflect your actual experience.

Some models featured in this guide may be unavailable in your country or region. For local sales information, visit <https://www.tp-link.com>.

PoE budget calculations are based on laboratory testing. Actual PoE power budget is not guaranteed and will vary as a result of client limitations and environmental factors.

The information in this document is subject to change without notice. Every effort has been made in the preparation of this document to ensure accuracy of the contents, but all statements, information, and recommendations in this document do not constitute the warranty of any kind, express or implied. Users must take full responsibility for their application of any products.

In this Guide, the following conventions are used:

The symbol  stands for Note. Notes contains suggestions or references that helps you make better use of your device.

- For GUI:

**Menu Name > Submenu Name > Tab page** indicates the menu structure. **SYSTEM > System Info > System Summary** means the System Summary page under the System Info menu option that is located under the System menu.

**Bold font** indicates a button, a toolbar icon, menu or menu item.

- For CLI:

|                  |   |
|------------------|---|
| <b>Bold Font</b> | An unalterable keyword.<br>For example: <b>show logging</b> |
|------------------|---|

|                    |  |
|--------------------|--|
| Normal Font        | A constant (several options are enumerated and only one can be selected).<br>For example: <b>no bandwidth</b> {all   ingress   egress} |
| { }                | Items in braces { } are required.  |
| [ ]                | Items in square brackets [ ] are optional.   |
|                    | Alternative items are grouped in braces and separated by vertical bars  .<br>For example: <b>speed</b> {10   100   1000}               |
| <i>Italic Font</i> | A variable (an actual value must be assigned).<br>For example: <b>bridge aging-time</b> <i>aging-time</i>                              |

Common combination:

|             |  |
|-------------|--|
| { [ ] [ ] } | A least one item in the square brackets must be selected.<br>For example: <b>bandwidth</b> {[ <b>ingress</b> <i>ingress-rate</i> ] [ <b>egress</b> <i>egress-rate</i> ]}   |
|             | This command can be used on three occasions:<br><b>bandwidth ingress</b> <i>ingress-rate</i> is used to restrict ingress bandwidth.<br><b>bandwidth egress</b> <i>egress-rate</i> is used to restrict egress bandwidth.<br><b>bandwidth ingress</b> <i>ingress-rate</i> <b>egress</b> <i>egress-rate</i> is used to restrict ingress and egress bandwidth. |

## More Information

- The latest software and documentations can be found at Download Center at <https://www.tp-link.com/support>.
- The Installation Guide (IG) can be found where you find this guide or inside the package of the switch.
- Specifications can be found on the product page at <https://www.tp-link.com>.
- To ask questions, find answers, and communicate with TP-Link users or engineers, please visit <https://community.tp-link.com> to join TP-Link Community.
- Our Technical Support contact information can be found at the Contact Technical Support page at <https://www.tp-link.com/support>.

# Part 1

## Accessing the Switch

### CHAPTERS

1. Overview
2. Web Interface Access
3. Command Line Interface Access

# 1 Overview

You can access and manage the switch using the GUI (Graphical User Interface, also called web interface in this text) or using the CLI (Command Line Interface). There are equivalent functions in the web interface and the command line interface, while web configuration is easier and more visual than the CLI configuration. You can choose the method according to their available applications and preference.

# 2 Web Interface Access

You can access the switch's web interface through the web-based authentication. The switch uses two built-in web servers, HTTP server and HTTPS server, for user authentication.

The following example shows how to login via the HTTP server.

## 2.1 Login

To manage your switch through a web browser in the host PC:

- 1) Make sure that the route between the host PC and the switch is available.
- 2) Launch a web browser. The supported web browsers include, but are not limited to, the following types:
  - IE 8.0, 9.0, 10.0, 11.0
  - Firefox 26.0, 27.0
  - Chrome 32.0, 33.0
- 3) Enter the switch's IP address in the web browser's address bar. The switch's default IP address is 192.168.0.1.

Figure 2-1 Enter the switch's IP address in the browser

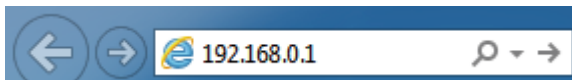

- 4) Enter the username and password in the pop-up login window. Use **admin** for both username and password in lower case letters.

Figure 2-2 Login authentication

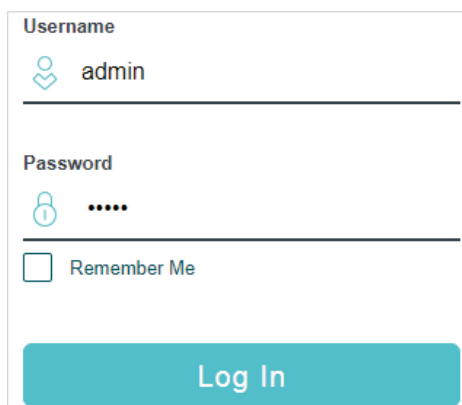
A screenshot of a login authentication form. The form has a white background and a thin border. It contains the following elements: a 'Username' label, a text input field with 'admin' entered, a 'Password' label, a password input field with masked characters '.....', a 'Remember Me' checkbox, and a teal 'Log In' button at the bottom.

### Note:

The first time you log in, change the password to better protect your network and devices.



- The typical web interface displays below. You can view the switch’s running status and configure the switch on this interface.

Figure 2-3 Web interface

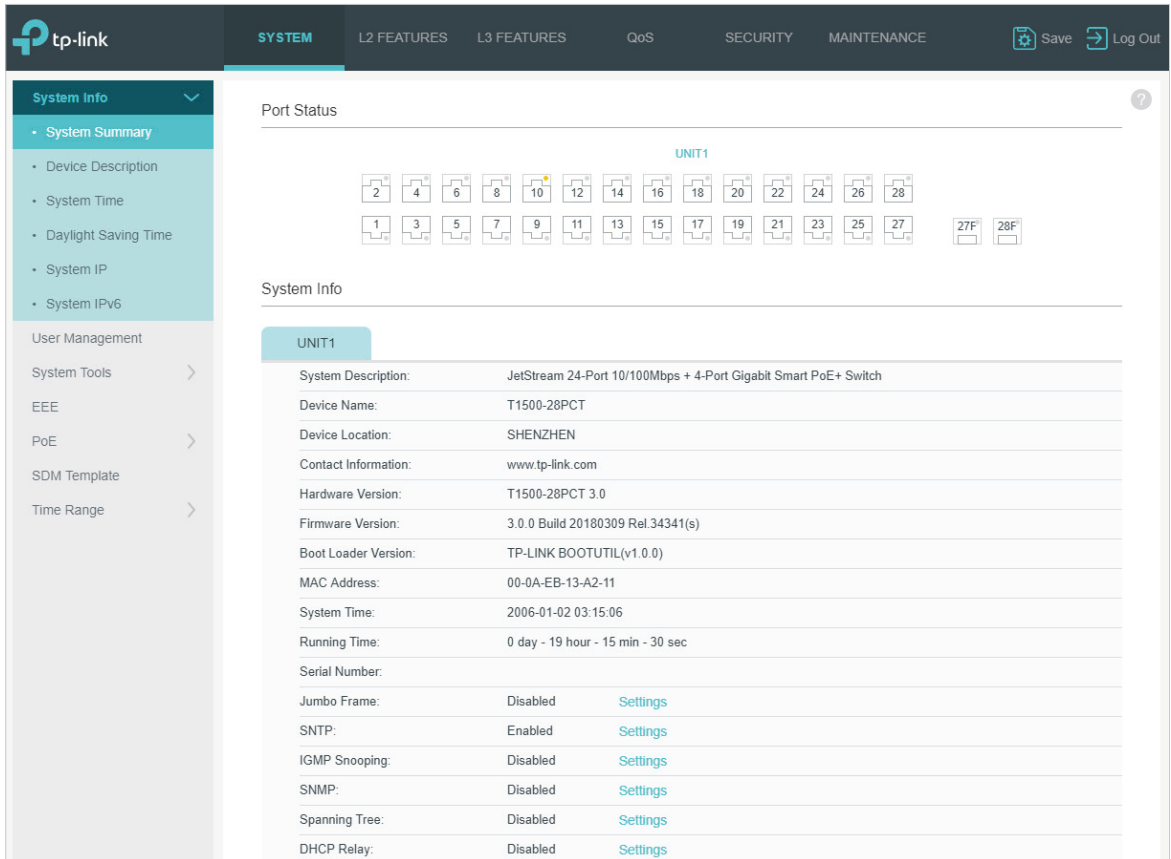

## 2.2 Save Config Function

The switch’s configuration files fall into two types: the running configuration file and the start-up configuration file.

After you perform configurations on the sub-interfaces and click **Apply**, the modifications will be saved in the running configuration file. The configurations will be lost when the switch reboots.

If you need to keep the configurations after the switch reboots, please use the **Save** function on the main interface to save the configurations in the start-up configuration file.

Figure 2-4 Save the Configuration

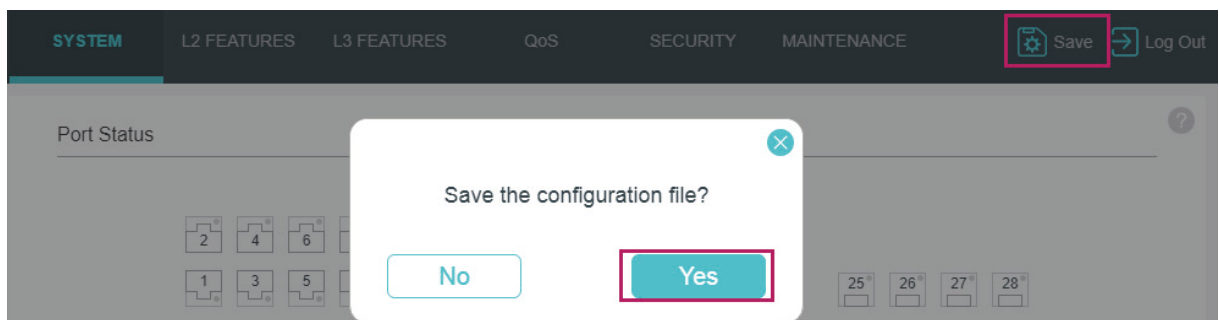

## 2.3 Disable the Web Server

You can shut down the HTTP server and HTTPS server to block any access to the web interface.

Go to **SECURITY > Access Security > HTTP Config**, disable the HTTP server and click **Apply**.

Figure 2-5 Shut down HTTP server

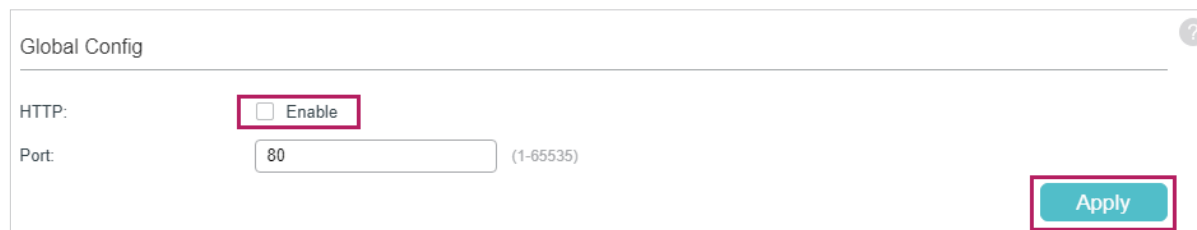

Global Config

HTTP:  Enable

Port:  (1-65535)

Apply

Go to **SECURITY > Access Security > HTTPS Config**, disable the HTTPS server and click **Apply**.

Figure 2-6 Disbale the HTTPS Server



Global Config

HTTPS:  Enable

SSL Version 3:  Enable

TLS Version 1:  Enable

Port:  (1-65535)

Apply

## 2.4 Change the Switch's IP Address and Default Gateway

If you want to access the switch, you can configure the system IP address of the switch. If you want the switch to accss a network, you can configure the default gateway of the switch. Only the computers in the management VLAN can access the management interface of the switch. By default, VLAN 1 owning all the ports is the management VLAN and you can access the switch via any port. By default, the system IP address is **192.168.0.1**, and the switch has no default gateway. The following example shows how to change the system IP address and default gateway of the switch,

- 1) Go to **SYSTEM > System Info > System IP**. Specify the management VLAN ID. Specify the IP address mode as **Static**. Enter the new IP address, subnet mask and default gateway. Make sure that the route between the host PC and the switch's new IP address is available. Click **Apply**.

Figure 2-7 Change the switch's IP address and default gateway

System IP Config

|                     |  |
|---------------------|--|
| MAC Address:        | 00-0A-EB-13-A2-11  |
| Management VLAN ID: | <input type="text" value="1"/> (1-4094)  |
| IP Address Mode:    | <input checked="" type="radio"/> Static <input type="radio"/> DHCP <input type="radio"/> BOOTP |
| IP Address:         | <input type="text" value="192.168.0.150"/> (Format: 192.168.0.1)                               |
| Subnet Mask:        | <input type="text" value="255.255.255.0"/> (Format: 255.255.255.0)                             |
| Default Gateway:    | <input type="text" value="192.168.0.100"/> (Format: 192.168.0.1)                               |

- 2) Enter the new IP address in the web browser to access the switch.
- 3) Click  Save to save the settings.

# 3 Command Line Interface Access

Users can access the switch's command line interface through the console (only for switch with console port), Telnet or SSH connection, and manage the switch with the command lines.

Console connection requires the host PC connecting to the switch's console port directly, while Telnet and SSH connection support both local and remote access.

The following table shows the typical applications used in the CLI access.

Table 3-1 Method list

| Method  | Using Port                        | Typical Applications |
|---------|-----------------------------------|----------------------|
| Console | Console port (connected directly) | Hyper Terminal       |
| Telnet  | RJ-45 port                        | CMD                  |
| SSH     | RJ-45 port                        | Putty                |

## 3.1 Console Login (only for switch with console port)

Follow these steps to log in to the switch via the Console port:

- 1) Connect the PC or terminal to the Console port on the switch with the serial cable.
- 2) Start the terminal emulation program (such as the Hyper Terminal) on the PC and configure the terminal emulation program as follows:
  - Baud Rate: 38400bps
  - Data Bits: 8
  - Parity: None
  - Stop Bits: 1
  - Flow Control: None
- 3) Type the User name and Password in the Hyper Terminal window. The default value for both of them is **admin**. Press **Enter** in the main window and **Switch>** will appear, indicating that you have successfully logged in to the switch and you can use the CLI now.

Figure 3-1 CLI Main Window

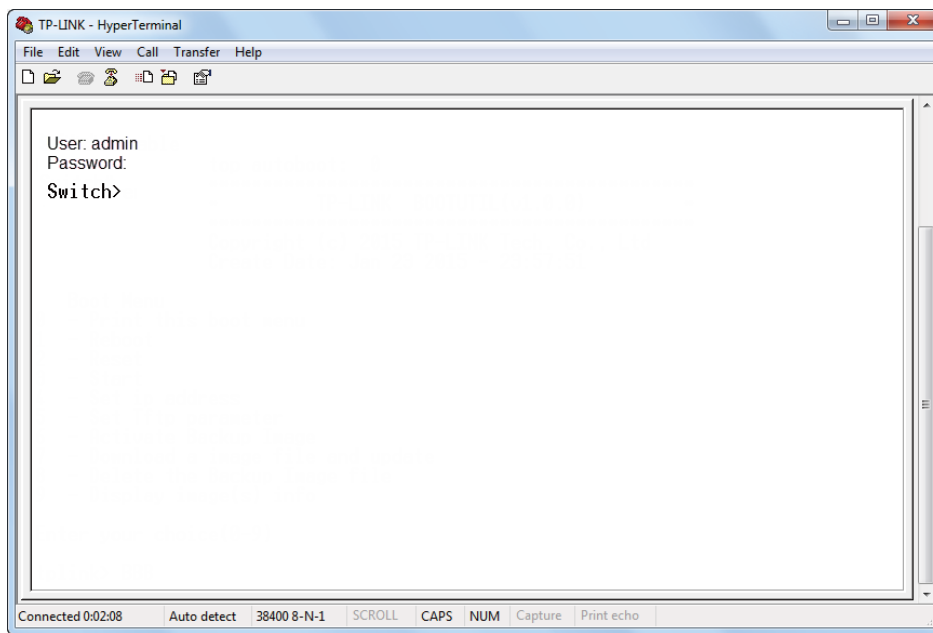

 **Note:**

The first time you log in, change the password to better protect your network and devices.

- 4) Enter **enable** to enter the User EXEC Mode to further configure the switch.

Figure 3-2 User EXEC Mode

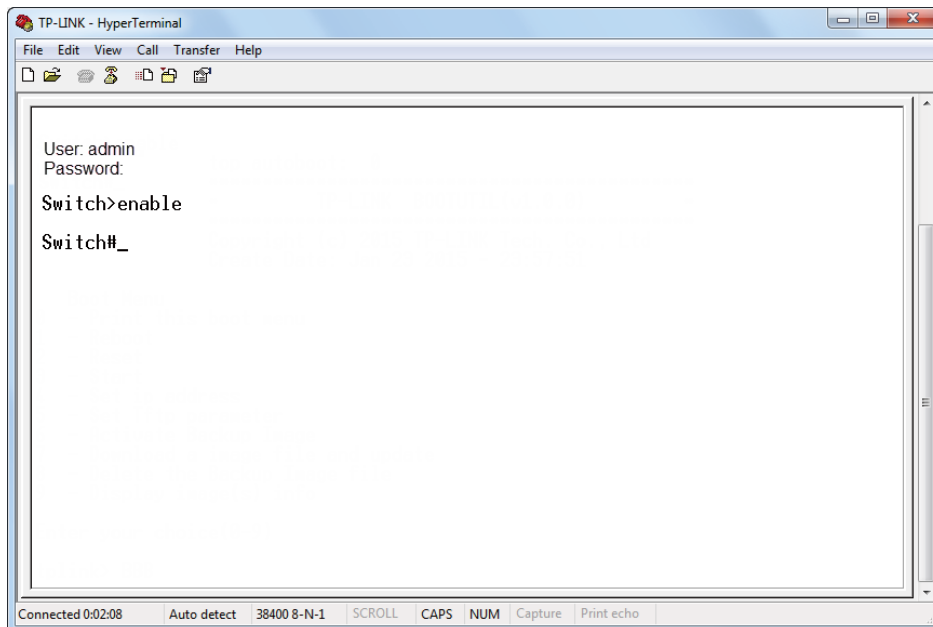

 **Note:**

In Windows XP, go to **Start > All Programs > Accessories > Communications > Hyper Terminal** to open the Hyper Terminal and configure the above settings to log in to the switch.

## 3.2 Telnet Login

The switch supports Login Local Mode for authentication by default.

Login Local Mode: Username and password are required, which are both **admin** by default.

The following steps show how to manage the switch via the Login Local Mode:

- 1) Make sure the switch and the PC are in the same LAN (Local Area Network). Click **Start** and type in **cmd** in the Search bar and press **Enter**.

Figure 3-3 Open the cmd Window

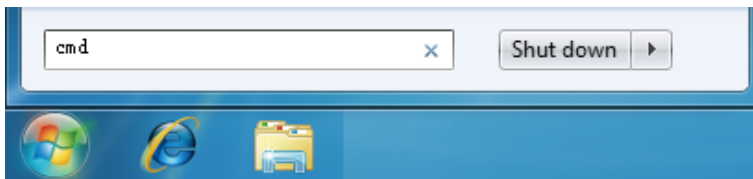

- 2) Type in **telnet 192.168.0.1** in the cmd window and press **Enter**.

Figure 3-4 Log In to the Switch

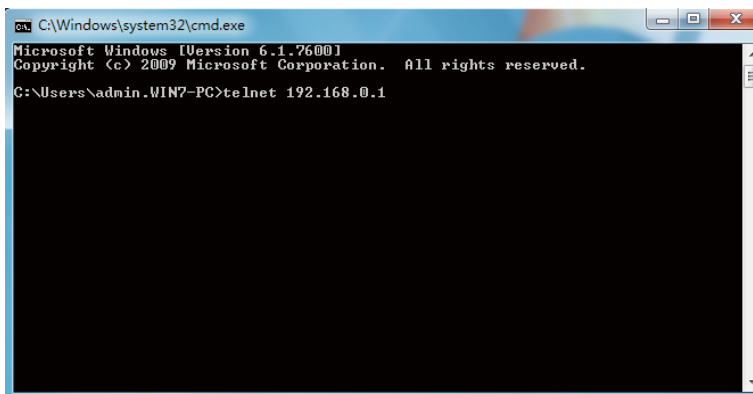

- 3) Type in the login username and password (both **admin** by default). Press **Enter** and you will enter User EXEC Mode.

Figure 3-5 Enter User EXEC Mode

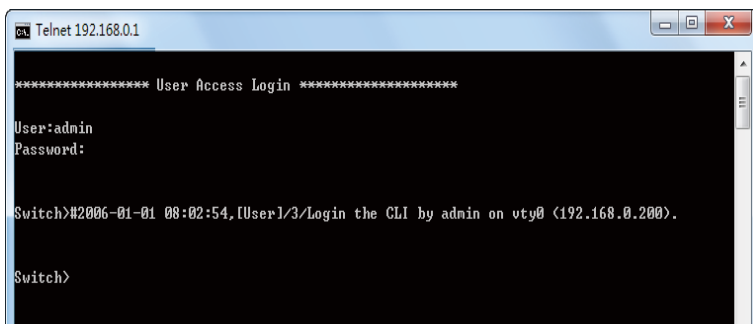

### Note:

The first time you log in, change the password to better protect your network and devices.

- 4) Type in **enable** command and you will enter Privileged EXEC Mode. By default no password is needed. Later you can set a password for users who want to access the Privileged EXEC Mode.

Figure 3-6 Enter Privileged EXEC Mode

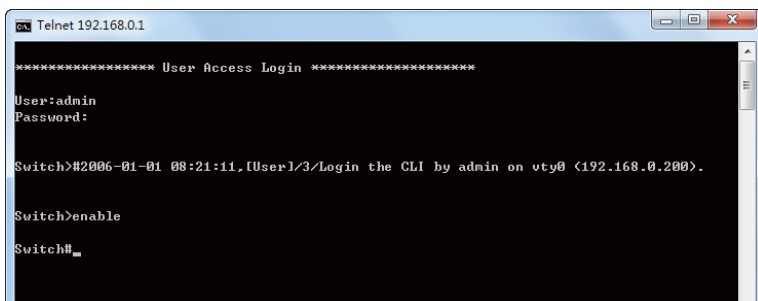

```
Telnet 192.168.0.1
***** User Access Login *****
User:admin
Password:
Switch>#2006-01-01 08:21:11,[User]/3/Login the CLI by admin on vty0 (192.168.0.200).
Switch>enable
Switch#_
```

Now you can manage your switch with CLI commands through Telnet connection.

### 3.3 SSH Login

SSH login supports the following two modes: Password Authentication Mode and Key Authentication Mode. You can choose one according to your needs:

- Password Authentication Mode: Username and password are required, which are both **admin** by default.
- Key Authentication Mode (Recommended): A public key for the switch and a private key for the client software (PuTTY) are required. You can generate the public key and the private key through the PuTTY Key Generator.

Before logging in via SSH, follow the steps below to enable SSH on the terminal emulation program:

Figure 3-7 Enable SSH

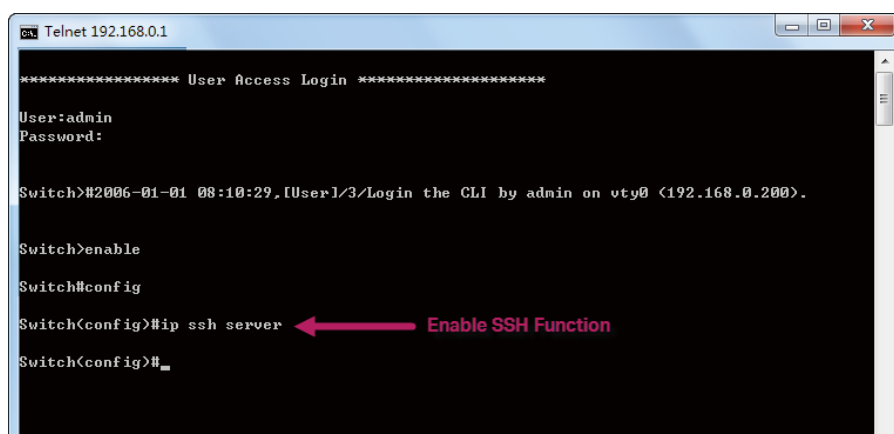

```
Telnet 192.168.0.1
***** User Access Login *****
User:admin
Password:
Switch>#2006-01-01 08:10:29,[User]/3/Login the CLI by admin on vty0 (192.168.0.200).
Switch>enable
Switch#config
Switch(config)#ip ssh server ← Enable SSH Function
Switch(config)#_
```

## Password Authentication Mode

- 1) Open PuTTY and go to the Session page. Enter the IP address of the switch in the **Host Name** field and keep the default value 22 in the **Port** field; select **SSH** as the Connection type. Click **Open**.

Figure 3-8 Configurations in PuTTY

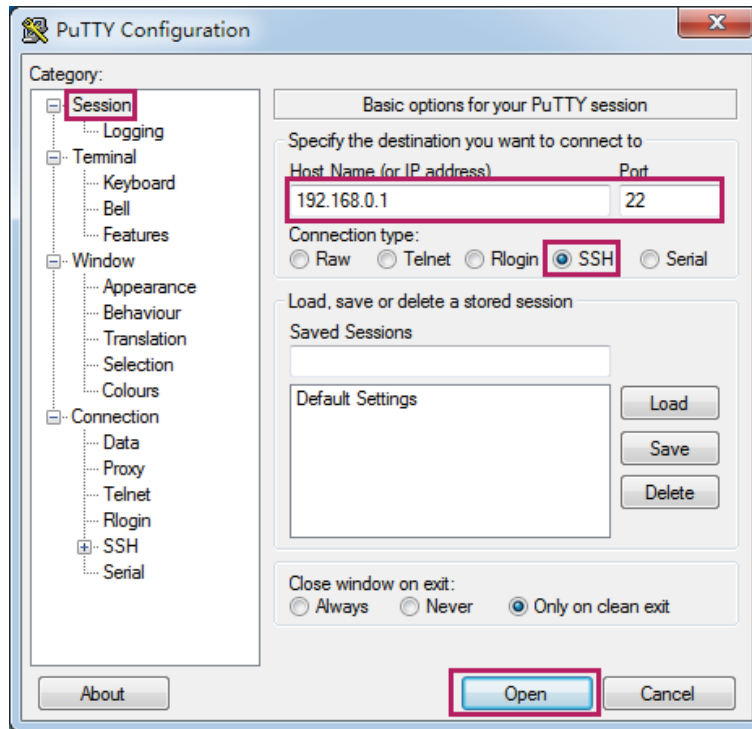

- 2) Enter the login username and password to log in to the switch, and you can continue to configure the switch.

Figure 3-9 Log In to the Switch

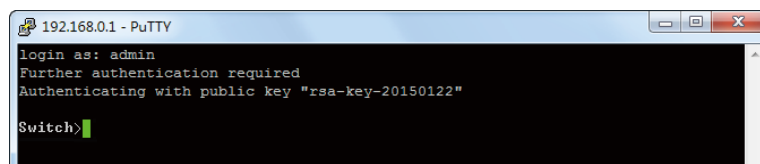

### Note:

The first time you log in, change the password to better protect your network and devices.

## Key Authentication Mode

- 1) Open the PuTTY Key Generator. In the Parameters section, select the key type and enter the key length. In the **Actions** section, click **Generate** to generate a public/private key pair. In the following figure, an SSH-2 RSA key pair is generated, and the length of each key is 1024 bits.



Figure 3-10 Generate a Public/Private Key Pair

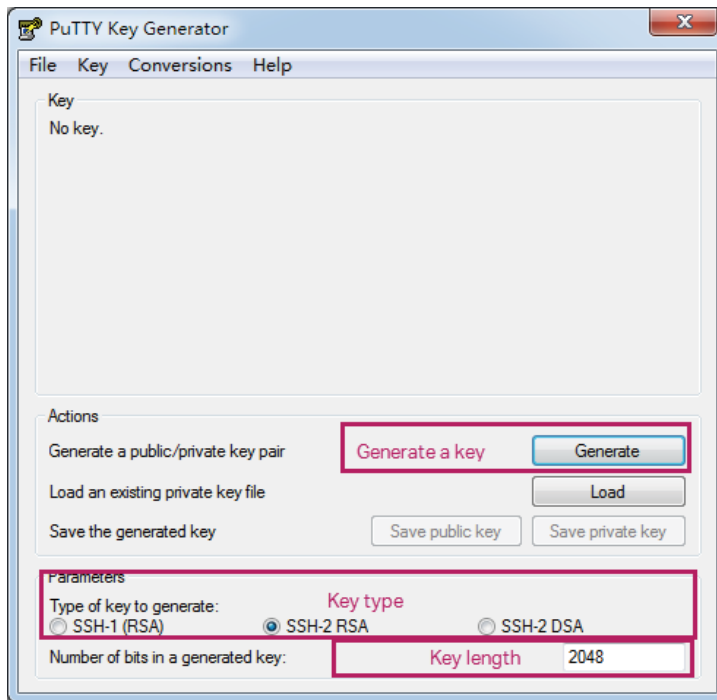

**Note:**

- The key length should be between 512 and 3072 bits.
- You can accelerate the key generation process by moving the mouse quickly and randomly in the Key section.

- 2) After the keys are successfully generated, click **Save public key** to save the public key to a TFTP server; click **Save private key** to save the private key to the host PC.

Figure 3-11 Save the Generated Keys



- 3) On Hyper Terminal, download the public key file from the TFTP server to the switch as shown in the following figure:

Figure 3-12 Download the Public Key to the Switch

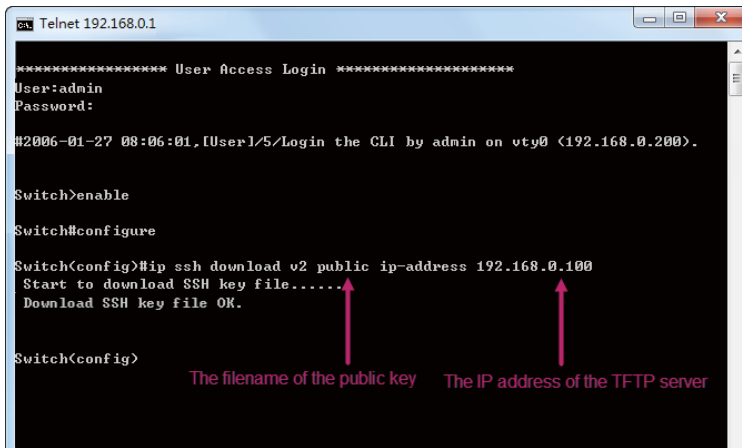

**Note:**

- The key type should accord with the type of the key file. In the above CLI, v1 corresponds to SSH-1 (RSA), and v2 corresponds to SSH-2 RSA and SSH-2 DSA.
- The key downloading process cannot be interrupted.

- 4) After the public key is downloaded, open PuTTY and go to the **Session** page. Enter the IP address of the switch and select **SSH** as the Connection type (keep the default value in the Port field).

Figure 3-13 Configure the Host Name and Connection Type

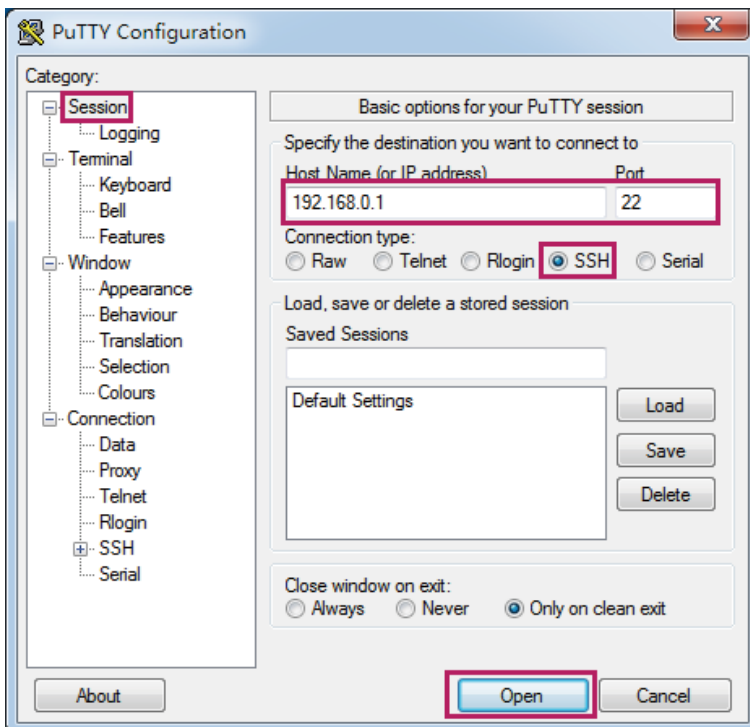

- 5) Go to **Connection > SSH > Auth**. Click **Browse** to download the private key file to PuTTY. Click **Open** to start the connection and negotiation.

Figure 3-14 Download the Private Key to PuTTY

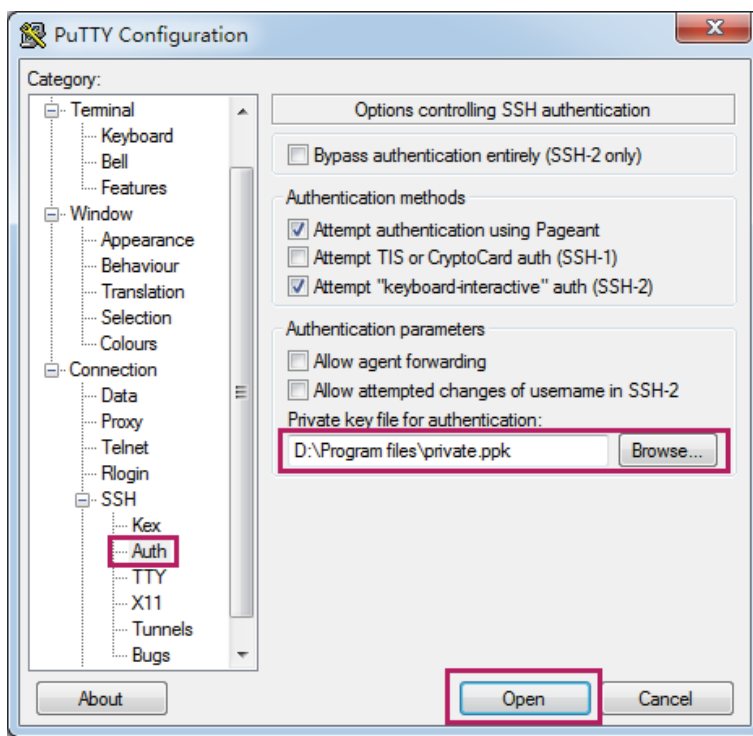

- 6) After negotiation is completed, enter the username to log in. If you can log in without entering the password, the key authentication completed successfully.

Figure 3-15 Log In to the Switch

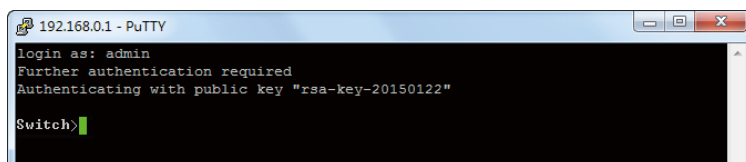

**Note:**

The first time you log in, change the password to better protect your network and devices.

### 3.4 Disable Telnet Login

You can shut down the Telnet function to block any Telnet access to the CLI interface.

- Using the GUI:

Go to **SECURITY > Access Security > Telnet Config**, disable the Telnet function and click **Apply**.

Figure 3-16 Disable Telnet login

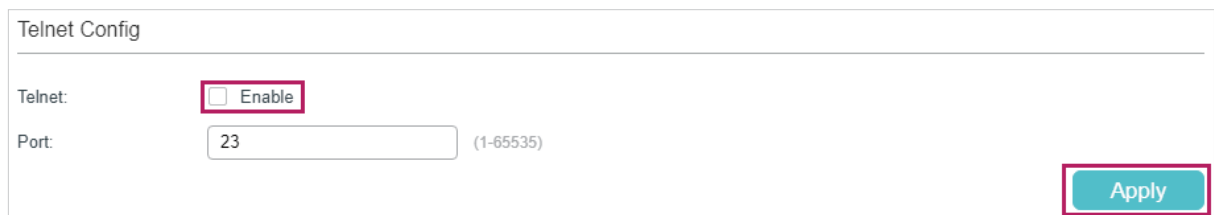

Telnet Config

Telnet:  Enable

Port:  (1-65535)

Apply

- Using the CLI:

```
Switch#configure
```

```
Switch(config)#telnet disable
```

## 3.5 Disable SSH Login

You can shut down the SSH server to block any SSH access to the CLI interface.

- Using the GUI:

Go to **SECURITY > Access Security > SSH Config**, disable the SSH server and click **Apply**.

Figure 3-17 Shut down SSH server



Global Config

SSH:  Enable

Protocol V1:  Enable

Protocol V2:  Enable

Idle Timeout:  seconds (1-120)

Maximum Connections:  (1-5)

Port:  (1-65535)

Apply

- Using the CLI:

```
Switch#configure
```

```
Switch(config)#no ip ssh server
```

## 3.6 Copy running-config startup-config

The switch's configuration files fall into two types: the running configuration file and the start-up configuration file.

After you enter each command line, the modifications will be saved in the running configuration file. The configurations will be lost when the switch reboots.

If you need to keep the configurations after the switch reboots, please use the command **copy running-config startup-config** to save the configurations in the start-up configuration file.

```
Switch(config)#end
```

```
Switch#copy running-config startup-config
```

### 3.7 Change the Switch's IP Address and Default Gateway

If you want to access the switch, you can configure the system IP address of the switch. If you want the switch to access a network, you can configure the default gateway of the switch. Only the computers in the management VLAN can access the management interface of the switch. By default, VLAN 1 owning all the ports is the management VLAN and you can access the switch via any port. By default, the system IP address is **192.168.0.1**, and the switch has no default gateway. The following example shows how to configure the switch's IP address as **192.168.0.10/24** and configure the default gateway as **192.168.0.100**.

```
Switch#configure
```

```
Switch(config)#interface vlan 1
```

```
Switch(config-if)#ip address 192.168.0.10 255.255.255.0 gateway 192.168.0.100
```

The connection will be interrupted and you should telnet to the switch's new IP address **192.168.0.10**.

```
C:\Users\Administrator>telnet 192.168.0.10
```

```
User:admin
```

```
Password:admin
```

```
Switch>enable
```

```
Switch#copy running-config startup-config
```

# Part 2

## Managing System

### CHAPTERS

1. System
2. System Info Configurations
3. User Management Configurations
4. System Tools Configurations
5. EEE Configuration
6. PoE Configurations (Only for Certain Devices)
7. SDM Template Configuration
8. Time Range Configuration
9. Example for PoE Configurations
10. Appendix: Default Parameters

# 1 System

## 1.1 Overview

In System module, you can view the system information and configure the system parameters and features of the switch.

## 1.2 Supported Features

### System Info

You can view the switch's port status and system information, and configure the device description, system time, daylight saving time, and system IP/IPv6.

### User Management

You can manage the user accounts for login to the switch. There are multiple user types which have different access levels, and you can create different user accounts according to your need.

### System Tools

You can configure the boot file of the switch, backup and restore the configurations, update the firmware, reset the switch, and reboot the switch.

### EEE

EEE (Energy Efficient Ethernet) is used to save power consumption of the switch during periods of low data activity. You can simply enable this feature on ports to allow power reduction.

### PoE

---

 Note:

Only T1500-28PCT, TL-SG2210MP and TL-SG2210P support the PoE feature.

---

Power over Ethernet (PoE) is a remote power supply function. With this function, the switch can supply power to the connected devices over twisted-pair cable.

Some devices such as IP phones, access points (APs) and cameras may be located far away from the AC power source in actual use. PoE can provide power for these devices without requiring to deploy power cables. This allows a single cable to provide both data connection and electric power to devices.

IEEE 802.3af and 802.3at are both PoE standards. The standard process of PoE power supply contains powered-device discovery, power administration, disconnect detection and optional power-device power classification.

- PSE

Power sourcing equipment (PSE) is a device that provides power for PDs on the Ethernet, for example, the PoE switch. PSE can detect the PDs and determine the device power requirements.

- PD

Powered device (PD) is a device receiving power from the PSE, for example, IP phones and access points. According to whether PDs comply with IEEE standard, they can be classified into standard PDs and non-standard PDs. Only standard PDs can be powered via TP-Link PoE switches.

### **SDM Template**

SDM (Switch Database Management) Template is used to prioritize hardware resources for certain features. The switch provides three templates which allocate different hardware resources for different usage, and you can choose one according to your need.

### **Time Range**

With this feature, you can configure a time range. You can use the time range when you configure other features like ACL.



# 2 System Info Configurations

With system information configurations, you can:

- View the System Summary
- Configure the Device Description
- Configure the System Time
- Configure the Daylight Saving Time
- Configuring LED (Only for Certain Devices)
- Configure the System IP
- Configure the System IPv6

## 2.1 Using the GUI

### 2.1.1 Viewing the System Summary

Choose the menu **SYSTEM > System Info > System Summary** to load the System Summary page. You can view the port status and system information of the switch.



#### Viewing the Port Status



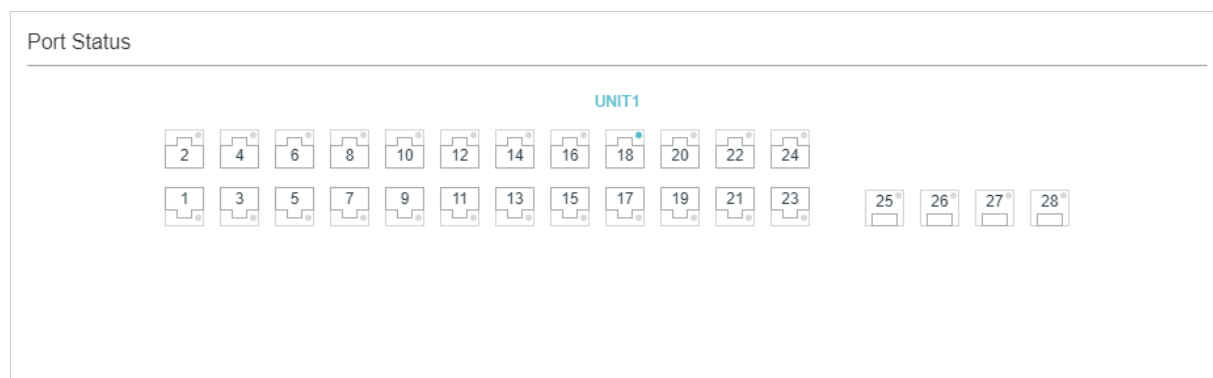

In the **Port Status** section, you can view the status and bandwidth utilization of each port.

Figure 2-1 Viewing the System Summary



The following table introduces the meaning of each port status:

| Port Status   | Indication   |
|---|--|
|  | Indicates that the corresponding 1000Mbps port is not connected to a device. |
|  | Indicates that the corresponding 1000Mbps port is at the speed of 1000Mbps.  |

|   |  |
|---|--|
|  | Indicates that the corresponding 1000Mbps port is at the speed of 10Mbps or 100Mbps. |
|  | Indicates that the corresponding SFP port is not connected to a device.              |
|  | Indicates the SFP port is at the speed of 1000Mbps.                                  |
|  | Indicates the SFP port is at the speed of 100Mbps.                                   |

You can move your cursor to a port to view the detailed information of the port.

Figure 2-2 Port Information

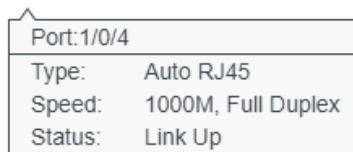

| Port Information | Indication  |
|------------------|---|
| Port             | Displays the port number.   |
| Type             | Displays the type of the port.                                      |
| Speed            | Displays the maximum transmission rate and duplex mode of the port. |
| Status           | Displays the connection status of the port.                         |

You can click a port to view the bandwidth utilization on this port.

Figure 2-3 Bnadwidth Utilization

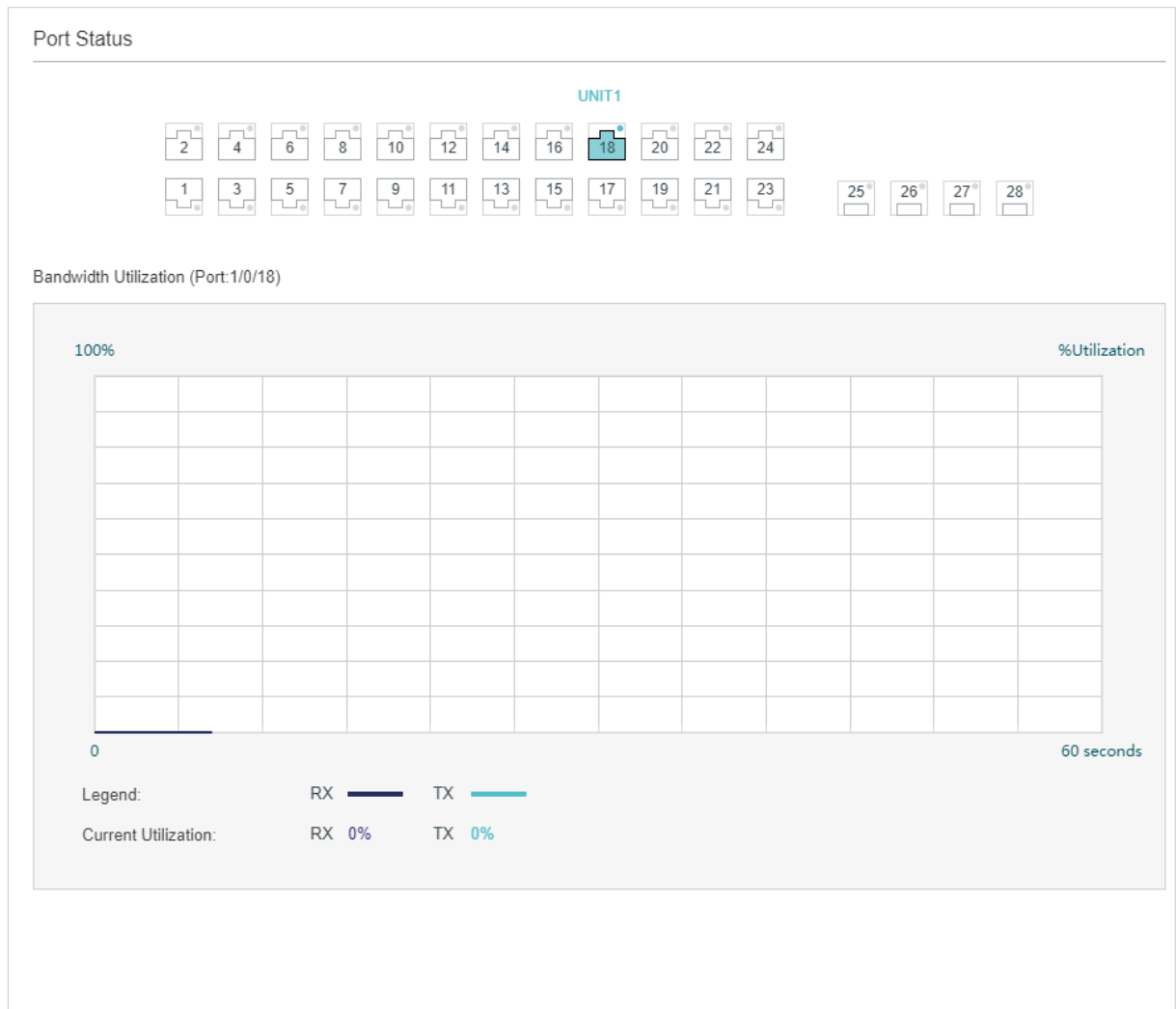

**RX** Displays the bandwidth utilization of receiving packets on this port.

**TX** Displays the bandwidth utilization of sending packets on this port.

## Viewing the System Information

In the **System Info** section, you can view the system information of the switch.

Figure 2-4 System Information

| System Info          |   |
|----------------------|---|
| <b>UNIT1</b>         |   |
| System Description:  | JetStream 24-Port 10/100Mbps + 4-Port Gigabit Smart PoE+ Switch |
| Device Name:         | T1500-28PCT   |
| Device Location:     | SHENZHEN  |
| Contact Information: | www.tp-link.com   |
| Hardware Version:    | T1500-28PCT 3.0   |
| Firmware Version:    | 3.0.0 Build 20180309 Rel.34341(s)                               |
| Boot Loader Version: | TP-LINK BOOTUTIL(v1.0.0)  |
| MAC Address:         | 00-0A-EB-13-A2-11   |
| System Time:         | 2006-01-08 06:06:07   |
| Running Time:        | 6 day - 22 hour - 6 min - 31 sec                                |
| Serial Number:       |   |
| Jumbo Frame:         | Disabled <a href="#">Settings</a>                               |
| SNTP:                | Enabled <a href="#">Settings</a>                                |
| IGMP Snooping:       | Disabled <a href="#">Settings</a>                               |
| SNMP:                | Disabled <a href="#">Settings</a>                               |
| Spanning Tree:       | Disabled <a href="#">Settings</a>                               |
| DHCP Relay:          | Disabled <a href="#">Settings</a>                               |
| 802.1X:              | Disabled <a href="#">Settings</a>                               |
| HTTP Server:         | Enabled <a href="#">Settings</a>                                |
| Telnet:              | Enabled <a href="#">Settings</a>                                |
| SSH:                 | Disabled <a href="#">Settings</a>                               |

### System Description

Displays the system description of the switch.

### Device Name

Displays the name of the switch. You can edit it on the Device Description page.

### Device Location

Displays the location of the switch. You can edit it on the Device Description page.

### Contact Information

Displays the contact information of the switch. You can edit it on the Device Description page.

### Hardware Version

Displays the hardware version of the switch.

### Firmware Version

Displays the firmware version of the switch.

### Boot Loader Version

Displays the boot loader version of the switch.

|               |  |
|---------------|--|
| MAC Address   | Displays the MAC address of the switch.  |
| System Time   | Displays the system time of the switch.  |
| Running Time  | Displays the running time of the switch.   |
| Serial Number | Displays the serial number of the switch.  |
| Jumbo Frame   | Displays whether Jumbo Frame is enabled. You can click <b>Settings</b> to jump to the Jumbo Frame configuration page.                      |
| SNTP          | Displays whether the switch gets system time from NTP Server. You can click <b>Settings</b> to jump to the System Time configuration page. |
| IGMP Snooping | Displays whether IGMP Snooping is enabled. You can click <b>Settings</b> to jump to the IGMP Snooping configuration page.                  |
| SNMP          | Displays whether SNMP is enabled. You can click <b>Settings</b> to jump to the SNMP configuration page.                                    |
| Spanning Tree | Displays whether Spanning Tree is enabled. You can click <b>Settings</b> to jump to the Spanning Tree configuration page.                  |
| DHCP Relay    | Displays whether DHCP Relay is enabled. You can click <b>Settings</b> to jump to the DHCP Relay configuration page.                        |
| 802.1x        | Displays whether Jumbo Frame is enabled. You can click <b>Settings</b> to jump to the Jumbo Frame configuration page.                      |
| HTTP Server   | Displays whether HTTP server is enabled. You can click <b>Settings</b> to jump to the HTTP configuration page.                             |
| Telnet        | Displays whether Telnet is enabled. You can click <b>Settings</b> to jump to the Telnet configuration page.                                |
| SSH           | Displays whether SSH is enabled. You can click <b>Settings</b> to jump to the SSH configuration page.                                      |

### 2.1.2 Configuring the Device Description

Choose the menu **SYSTEM > System Info > Device Description** to load the following page.

Figure 2-5 Configuring the Device Description

Device Description

---

Device Name:  (1-32 characters)

Device Location:  (1-32 characters)

System Contact:  (1-32 characters)

1) In the **Device Description** section, configure the following parameters.

|                 |                                   |
|-----------------|-----------------------------------|
| Device Name     | Specify a name for the switch.    |
| Device Location | Enter the location of the switch. |
| System Contact  | Enter the contact information.    |

2) Click **Apply**.

### 2.1.3 Configuring the System Time

Choose the menu **SYSTEM > System Info > System Time** to load the following page.

Figure 2-6 Configuring the System Time

**Time Info**

---

Current System Time: Sunday, January 8, 2006 06:12:09

Current Time Source: Manual

**Time Config**

---

Configure Manually
  Get Time from NTP Server
  Synchronize with PC's Clock

Time Zone: (GMT+08:00) Beijing, Urumqi, Hong Kong, Taipei ▼

Primary NTP Server: 133.100.9.2 (Format: 192.168.0.1 or 2001::1)

Secondary NTP Server: 139.78.100.163 (Format: 192.168.0.1 or 2001::1)

Update Rate: 12 hours (1-24)

**Apply**

In the **Time Info** section, you can view the current time information of the switch.

|                     |   |
|---------------------|---|
| Current System Time | Displays the current date and time of the switch. |
| Current Time Source | Displays how the switch gets the current time.    |

In the **Time Config** section, follow these steps to configure the system time:

1) Choose one method to set the system time and specify the related parameters.

|        |  |
|--------|--|
| Manual | Set the system time manually.                |
|        | <b>Date:</b> Specify the date of the system. |
|        | <b>Time:</b> Specify the time of the system. |

|   |   |
|---|---|
| <p><b>Get Time from NTP Server</b></p>    | <p>Get the system time from an NTP server. Make sure the NTP server is accessible on your network. If the NTP server is on the internet, connect the switch to the internet first.</p> <p><b>Time Zone:</b> Select your local time zone.</p> <p><b>Primary Server:</b> Enter the IP Address of the primary NTP server.</p> <p><b>Secondary Server:</b> Enter the IP Address of the secondary NTP server. Once the primary NTP server is down, the EAP can get the system time from the secondary NTP server.</p> <p><b>Update Rate:</b> Specify the interval the switch fetching time from NTP server, which ranges from 1 to 24 hours.</p> |
| <p><b>Synchronize with PC's Clock</b></p> | <p>Synchronize the system time with the clock of your currently logged-in host.</p>   |

2) Click **Apply**.

### 2.1.4 Configuring the Daylight Saving Time

Choose the menu **SYSTEM > System Info > Daylight Saving Time** to load the following page.

Figure 2-7 Configuring the Daylight Saving Time

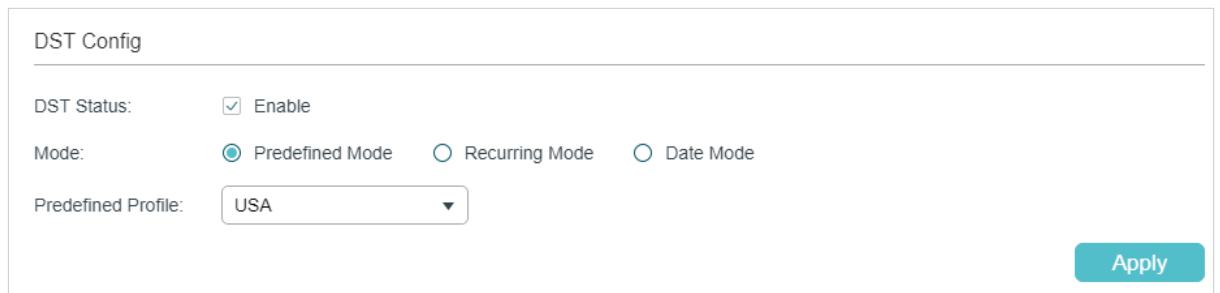

Follow these steps to configure Daylight Saving Time:

- 1) In the **DST Config** section, enable the Daylight Saving Time function.
- 2) Choose one method to set the Daylight Saving Time and specify the related parameters.

|                               |   |
|-------------------------------|---|
| <p><b>Predefined Mode</b></p> | <p>If you select <b>Predefined Mode</b>, choose a predefined DST schedule for the switch.</p> <p><b>USA:</b> Select the Daylight Saving Time of the USA. It is from 2: 00 a.m. on the Second Sunday in March to 2:00 a.m. on the First Sunday in November.</p> <p><b>Australia:</b> Select the Daylight Saving Time of Australia. It is from 2:00 a.m. on the First Sunday in October to 3:00 a.m. on the First Sunday in April.</p> <p><b>Europe:</b> Select the Daylight Saving Time of Europe. It is from 1: 00 a.m. on the Last Sunday in March to 1:00 a.m. on the Last Sunday in October.</p> <p><b>New Zealand:</b> Select the Daylight Saving Time of New Zealand. It is from 2: 00 a.m. on the Last Sunday in September to 3:00 a.m. on the First Sunday in April.</p> |
|-------------------------------|---|

**Recurring Mode** If you select **Recurring Mode**, specify a cycle time range for the Daylight Saving Time of the switch. This configuration will be used every year.

**Offset:** Specify the time to set the clock forward by.

**Start Time:** Specify the start time of Daylight Saving Time. The interval between start time and end time should be more than 1 day and less than 1 year(365 days).

**End Time:** Specify the end time of Daylight Saving Time. The interval between start time and end time should be more than 1 day and less than 1 year (365 days).

**Date Mode** If you select **Date Mode**, specify an absolute time range for the Daylight Saving Time of the switch. This configuration will be used only one time.

**Offset:** Specify the time to set the clock forward by.

**Start Time:** Specify the start time of Daylight Saving Time. The interval between start time and end time should be more than 1 day and less than 1 year(365 days).

**End Time:** Specify the end time of Daylight Saving Time. The interval between start time and end time should be more than 1 day and less than 1 year (365 days).

3) Click **Apply**.

## 2.1.5 Configuring LED (Only for Certain Devices)

### Note:

Only TL-SG2210P supports LED On/Off.

Choose the menu **System > LED On/Off** to load the following page. Choose the LED status and click **Apply**.

Figure 2-8 Configuring LED On/Off



LED On/Off Config

LED:  On  Off

Apply



## 2.1.6 Configuring the System IP

Choose the menu **SYSTEM > System Info > System IP** to load the following page.

Figure 2-9 Configuring the Sysrtem IP Parameters

**System IP Config**

---

MAC Address: 00-0A-EB-13-A2-11

Management VLAN ID:  (1-4094)

IP Address Mode:  Static  DHCP  BOOTP

IP Address:  (Format: 192.168.0.1)

Subnet Mask:  (Format: 255.255.255.0)

Default Gateway:  (Format: 192.168.0.1)

Follow these steps to configure the System IP:

1) Configure the corresponding parameters for the system IP

|                           |  |
|---------------------------|--|
| <b>Management VLAN ID</b> | Specify the management VLAN of the switch. Only the computers in the management VLAN can access the management interface of the switch. By default, VLAN 1 owning all the ports is the management VLAN and you can access the switch via any port.   |
| <b>IP Address Mode</b>    | Specify the IP address assignment mode of the interface.<br><br><b>Static:</b> Assign an IP address to the management interface.<br><br><b>DHCP:</b> Assign an IP address to the management interface through the DHCP server.<br><br><b>BOOTP:</b> Assign an IP address to the management interface through the BOOTP server. |
| <b>DHCP Option 12</b>     | If you select the IP Address Mode as DHCP, configure the Option 12 here.<br><br>DHCP Option 12 is used to specify the client's name.   |
| <b>IP Address</b>         | Specify the IP address of the management interface if you select the IP Address Mode as Static.  |
| <b>Subnet Mask</b>        | Specify the subnet mask of the management interface if you select the IP Address Mode as Static.   |
| <b>Default Gateway</b>    | Specify the default gateway of the management interface if you select the IP Address Mode as Static. The default gateway is the IP address to which the packet should be sent next.  |

2) Click **Apply**.

## 2.1.7 Configuring the System IPv6

Choose the menu **SYSTEM > System Info > System IPv6** to load the following page.

Figure 2-10 Configuring the System IPv6 Parameters

**System IPv6 Config**

---

Management VLAN ID: VLAN1

IPv6 Enable:  Enable

Link-local Address Mode:  Manual  Auto

Link-local Address:  (Format: fe80::1)

Status: Normal

Enable global address auto configuration via RA message

Enable global address auto configuration via DHCPv6 Server

[Apply](#)

---

**Global Address Config**

[+](#) Add [-](#) Delete

| <input type="checkbox"/>  | Index | Global Address | Prefix Length | Type | Preferred Lifetime | Valid Lifetime | Status |
|---------------------------|-------|----------------|---------------|------|--------------------|----------------|--------|
| No entries in this table. |       |                |               |      |                    |                |        |
| Total: 0                  |       |                |               |      |                    |                |        |

- 1) In the **System IPv6 Config** section, enable IPv6 feature for the interface and configure the corresponding parameters . Then click **Apply**.

|                                |   |
|--------------------------------|---|
| <b>Management VLAN ID</b>      | Displays the Management VLAN ID. Only the computers in the management VLAN can access the management interface of the switch. By default, VLAN 1 owning all the ports is the management VLAN and you can access the switch via any port.                        |
| <b>IPv6 Enable</b>             | Enable the IPv6 feature of the management interface.  |
| <b>Link-local Address Mode</b> | <p>Select the link-local address configuration mode.</p> <p><b>Manual:</b> With this option selected, you can assign a link-local address manually.</p> <p><b>Auto:</b> With this option selected, the switch generates a link-local address automatically.</p> |
| <b>Link-local Address</b>      | Enter a link-local address if you choose "Manual" as the Link-Local Address Mode.   |

|               |   |
|---------------|---|
| <b>Status</b> | <p>Displays the status of the link-local address. An IPv6 address cannot be used before pass the DAD (Duplicate Address Detection), which is used to detect the address conflicts. In the DAD process, the IPv6 address may in three different status:</p> <p><b>Normal:</b> Indicates that the link-local address passes the DAD and can be used normally.</p> <p><b>Try:</b> Indicates that the link-local address is in the progress of DAD and cannot be used right now.</p> <p><b>Repeat:</b> Indicates that the link-local address is duplicated, this address is already used by another node and cannot be used by the interface.</p> |
|---------------|---|

2) Configure IPv6 global address of the interface via following three ways:

**Via RA Message:**

|  |   |
|--|---|
| <p>Enable global address auto configuration via RA message</p> | <p>With this option enabled, the interface automatically generates a global address and other information according to the address prefix and other configuration parameters from the received RA (Router Advertisement) message.</p> |
|--|---|

**Via DHCPv6 Server:**

|   |   |
|---|---|
| <p>Enable global address auto configuration via DHCPv6 Server</p> | <p>With this option enabled, the switch will try to obtain the global address from the DHCPv6 Server.</p> |
|---|---|

**Manually:**

In the **Global Address Config** section, click  **Add** to manually assign an IPv6 global address to the interface.

**Global Address**

Address Format:  EUI-64  Not EUI-64

Global Address:  (Format:3001::1)

Prefix Length:  (1-64)

Cancel
Create

|                       |  |
|-----------------------|--|
| <b>Address Format</b> | <p>Select the global address format according to your needs.</p> <p><b>EUI-64:</b> Indicates that you only need to specify an address prefix, then the system will create a global address automatically.</p> <p><b>Not EUI-64:</b> Indicates that you have to specify an intact global address.</p> |
| <b>Global Address</b> | <p>When EUI-64 is selected, please input the address prefix here, otherwise, please input an intact IPv6 address here.</p>   |

|               |  |
|---------------|--|
| Prefix Length | Configure the prefix length of the global address. |
|---------------|--|

3) View the global address entry in the **Global Address Config** section.

|                |                                    |
|----------------|------------------------------------|
| Global Address | View or modify the global address. |
|----------------|------------------------------------|

|               |   |
|---------------|---|
| Prefix Length | View or modify the prefix length of the global address. |
|---------------|---|

|      |   |
|------|---|
| Type | <p>Displays the configuration mode of the global address.</p> <p><b>Manual:</b> Indicates that the corresponding address is configured manually.</p> <p><b>Auto:</b> Indicates that the corresponding address is created automatically using the RA message or obtained from the DHCPv6 Server.</p> |
|------|---|

|                    |   |
|--------------------|---|
| Preferred Lifetime | <p>Displays the preferred lifetime of the global address.</p> <p>Preferred lifetime is the length of time that a valid IPv6 address is preferred. When the preferred time expires, the address becomes deprecated but still can be used, and you need to switch to another address.</p> |
|--------------------|---|

|                |  |
|----------------|--|
| Valid Lifetime | <p>Displays the valid lifetime of the global address.</p> <p>Valid lifetime is the length of time that an IPv6 address is in the valid state. When the valid lifetime expires, the address become invalid and can be no longer usable.</p> |
|----------------|--|

|        |   |
|--------|---|
| Status | <p>Displays the status of the link-local address. An IPv6 address cannot be used before pass the DAD (Duplicate Address Detection), which is used to detect the address conflicts. In the DAD process, the IPv6 address may in three different status:</p> <p><b>Normal:</b> Indicates that the global address passes the DAD and can be normally used.</p> <p><b>Try:</b> Indicates that the global address is in the progress of DAD and cannot be used right now.</p> <p><b>Repeat:</b> Indicates that the global address is duplicated, this address is already used by another node. This address cannot be used by the interface.</p> |
|--------|---|

## 2.2 Using the CLI

### 2.2.1 Viewing the System Summary

On privileged EXEC mode or any other configuration mode, you can use the following commands to view the system information of the switch:

```
show interface status [ fastEthernet port | gigabitEthernet port | ten-gigabitEthernet port ]
```

View status of the interface.

*port*: Enter the number of the Ethernet port.

**show system-info**

View the system information including System Description, Device Name, Device Location, System Contact, Hardware Version, Firmware Version, System Time, Run Time and so on.

The following example shows how to view the interface status and the system information of the switch.

**Switch#show interface status**

| Port    | Status   | Speed | Duplex | FlowCtrl | Jumbo   | Active-Medium |
|---------|----------|-------|--------|----------|---------|---------------|
| -----   | -----    | ----- | -----  | -----    | -----   | -----         |
| Gi1/0/1 | LinkDown | N/A   | N/A    | N/A      | Disable | Copper        |
| Gi1/0/2 | LinkDown | N/A   | N/A    | N/A      | Disable | Copper        |
| Gi1/0/3 | LinkUp   | 1000M | Full   | Disable  | Disable | Copper        |
| ...     |          |       |        |          |         |               |

**Switch#show system-info**

System Description - JetStream 48-Port Gigabit Smart Switch with 4 SFP Slots  
 System Name - T1500-28PCT  
 System Location - SHENZHEN  
 Contact Information - www.tp-link.com  
 Hardware Version - T1500-28PCT 3.0  
 Software Version - 3.0.0 Build 20171129 Rel.38400(s)  
 Bootloader Version - TP-LINK BOOTUTIL(v1.0.0)  
 Mac Address - 00-0A-EB-13-23-A0  
 Serial Number -  
 System Time - 2017-12-12 11:23:32  
 Running Time - 1 day - 2 hour - 33 min - 42 sec

## 2.2.2 Configuring the Device Description

Follow these steps to configure the device description:

- Step 1 **configure**  
Enter global configuration mode.

---

**Step 2**     **hostname [ hostname ]**

Specify the system name of the switch.

*hostname*: Enter the device name. The length of the name ranges from 1 to 32 characters. By default, it is the model name of the switch.

---

**Step 3**     **location [ location ]**

Specify the system location of the switch.

*location*: Enter the device location. It should consist of no more than 32 characters. By default, it is "SHENZHEN".

---

**Step 4**     **contact-info [ contact-info ]**

Specify the system contact Information.

*contact-info*: Enter the contact information. It should consist of no more than 32 characters. By default, it is "www.tp-link.com".

---

**Step 5**     **show system-info**

Verify the system information including system Description, Device Name, Device Location, System Contact, Hardware Version, Firmware Version, System Time, Run Time and so on.

---

**Step 6**     **end**

Return to privileged EXEC mode.

---

**Step 7**     **copy running-config startup-config**

Save the settings in the configuration file.

---

The following example shows how to set the device name as Switch\_A, set the location as BEIJING and set the contact information as <https://www.tp-link.com>.

**Switch#configure****Switch(config)#hostname** Switch\_A**Switch(config)#location** BEIJING**Switch(config)#contact-info** <https://www.tp-link.com>**Switch(config)#show system-info**

System Description - JetStream 24-Port Gigabit L2 Managed Switch with 4 SFP Slots

System Name - Switch\_A

System Location - BEIJING

Contact Information - <https://www.tp-link.com>

...

**Switch(config)#end****Switch#copy running-config startup-config**

## 2.2.3 Configuring the System Time

Follow these steps to configure the system time:

 **Note:**

The mode of Synchronize with PC's Clock does not support CLI command.

**Step 1**     **configure**

Enter global configuration mode.

**Step 2**     Use the following command to set the system time manually:

**system-time manual time**

Configure the system time manually.

*time*: Specify the date and time manually in the format of MM/DD/YYYY-HH:MM:SS. The valid value of the year ranges from 2000 to 2037.

Use the following command to set the system time by getting time from the NTP server. Ensure the NTP server is accessible. If the NTP server is on the internet, connect the switch to the internet first.

**system-time ntp { timezone } { ntp-server } { backup-ntp-server } { fetching-rate }**

*timezone*: Enter your local time-zone, which ranges from UTC-12:00 to UTC+13:00.

The detailed information of each time-zone are displayed as follows:

UTC-12:00 — TimeZone for International Date Line West.

UTC-11:00 — TimeZone for Coordinated Universal Time-11.

UTC-10:00 — TimeZone for Hawaii.

UTC-09:00 — TimeZone for Alaska.

UTC-08:00 — TimeZone for Pacific Time (US Canada).

UTC-07:00 — TimeZone for Mountain Time (US Canada).

UTC-06:00 — TimeZone for Central Time (US Canada).

UTC-05:00 — TimeZone for Eastern Time (US Canada).

UTC-04:30 — TimeZone for Caracas.

UTC-04:00 — TimeZone for Atlantic Time (Canada).

UTC-03:30 — TimeZone for Newfoundland.

UTC-03:00 — TimeZone for Buenos Aires, Salvador, Brasilia.

UTC-02:00 — TimeZone for Mid-Atlantic.

UTC-01:00 — TimeZone for Azores, Cape Verde Is.

UTC — TimeZone for Dublin, Edinburgh, Lisbon, London.

UTC+01:00 — TimeZone for Amsterdam, Berlin, Bern, Rome, Stockholm, Vienna.

UTC+02:00 — TimeZone for Cairo, Athens, Bucharest, Amman, Beirut, Jerusalem.

UTC+03:00 — TimeZone for Kuwait, Riyadh, Baghdad.

UTC+03:30 — TimeZone for Tehran.

UTC+04:00 — TimeZone for Moscow, St.Petersburg, Volgograd, Tbilisi, Port Louis.

UTC+04:30 — TimeZone for Kabul.

UTC+05:00 — TimeZone for Islamabad, Karachi, Tashkent.

UTC+05:30 — TimeZone for Chennai, Kolkata, Mumbai, New Delhi.

UTC+05:45 — TimeZone for Kathmandu.

UTC+06:00 — TimeZone for Dhaka, Astana, Ekaterinburg.

UTC+06:30 — TimeZone for Yangon (Rangoon).

UTC+07:00 — TimeZone for Novosibirsk, Bangkok, Hanoi, Jakarta.

UTC+08:00 — TimeZone for Beijing, Chongqing, Hong Kong, Urumqi, Singapore.

UTC+09:00 — TimeZone for Seoul, Irkutsk, Osaka, Sapporo, Tokyo.

UTC+09:30 — TimeZone for Darwin, Adelaide.

UTC+10:00 — TimeZone for Canberra, Melbourne, Sydney, Brisbane.

UTC+11:00 — TimeZone for Solomon Is., New Caledonia, Vladivostok.

UTC+12:00 — TimeZone for Fiji, Magadan, Auckland, Wellington.

UTC+13:00 — TimeZone for Nuku'alofa, Samoa.

*ntp-server*: Specify the IP address of the primary NTP server.

*backup-ntp-server*: Specify the IP address of the backup NTP server.

*fetching-rate*: Specify the interval fetching time from the NTP server.

Step 3 Use the following command to verify the system time information.

**show system-time**

Verify the system time information.

Use the following command to verify the NTP mode configuration information.

**show system-time ntp**

Verify the system time information of NTP mode.

Step 4 **end**  
Return to privileged EXEC mode.

Step 5 **copy running-config startup-config**  
Save the settings in the configuration file.

The following example shows how to set the system time by Get Time from NTP Server and set the time zone as UTC+08:00, set the NTP server as 133.100.9.2, set the backup NTP server as 139.78.100.163 and set the update rate as 11.

**Switch#configure**

**Switch(config)#system-time ntp UTC+08:00 133.100.9.2 139.78.100.163 11**

**Switch(config)#show system-time ntp**

Time zone : UTC+08:00

Prefered NTP server: 133.100.9.2



Backup NTP server: 139.78.100.163

Last successful NTP server: 133.100.9.2

Update Rate: 11 hour(s)

**Switch(config)#end**

**Switch#copy running-config startup-config**

## 2.2.4 Configuring the Daylight Saving Time

Follow these steps to configure the Daylight Saving Time:

---

### Step 1 **configure**

Enter global configuration mode.

---

### Step 2 Use the following command to select a predefined Daylight Saving Time configuration:

**system-time dst predefined [ USA | Australia | Europe | New-Zealand ]**

Specify the Daylight Saving Time using a predefined schedule.

**USA | Australia | Europe | New-Zealand:** Select one mode of Daylight Saving Time.

**USA:** 02:00 a.m. on the Second Sunday in March ~ 02:00 a.m. on the First Sunday in November.

**Australia:** 02:00 a.m. on the First Sunday in October ~ 03:00 a.m. on the First Sunday in April.

**Europe:** 01:00 a.m. on the Last Sunday in March ~ 01:00 a.m. on the Last Sunday in October.

**New Zealand:** 02:00 a.m. on the Last Sunday in September ~ 03:00 a.m. on the First Sunday in April.

Use the following command to set the Daylight Saving Time in recurring mode:

**system-time dst recurring { sweek } { sday } { smonth } { stime } { eweek } { eday } { emonth } { etime } [ offset ]**

Specify the Daylight Saving Time in Recuring mode.

**sweek:** Enter the start week of Daylight Saving Time. There are 5 values showing as follows: first, second, third, fourth, last.

**sday:** Enter the start day of Daylight Saving Time. There are 7 values showing as follows: Sun, Mon, Tue, Wed, Thu, Fri, Sat.

**smonth:** Enter the start month of Daylight Saving Time. There are 12 values showing as follows: Jan, Feb, Mar, Apr, May, Jun, Jul, Aug, Sep, Oct, Nov, Dec.

**stime:** Enter the start time of Daylight Saving Time, in the format of HH:MM.

**ewweek:** Enter the end week of Daylight Saving Time. There are 5 values showing as follows: first, second, third, fourth, last.

**eday:** Enter the end day of Daylight Saving Time. There are 7 values showing as follows: Sun, Mon, Tue, Wed, Thu, Fri, Sat.

**emonth:** Enter the end month of Daylight Saving Time. There are 12 values showing as follows: Jan, Feb, Mar, Apr, May, Jun, Jul, Aug, Sep, Oct, Nov, Dec.

**etime:** Enter the end time of Daylight Saving Time, in the format of HH:MM.

**offset:** Enter the offset of Daylight Saving Time. The default value is 60.

---

Use the following command to set the Daylight Saving Time in date mode:

```
system-time dst date { smonth } { sday } { stime } { syear } { emonth } { eday } { etime } { eyear } [ offset ]
```

Specify the Daylight Saving Time in Date mode.

**smonth:** Enter the start month of Daylight Saving Time. There are 12 values showing as follows: Jan, Feb, Mar, Apr, May, Jun, Jul, Aug, Sep, Oct, Nov, Dec.

**sday:** Enter the start day of Daylight Saving Time, which ranges from 1 to 31.

**stime:** Enter the start time of Daylight Saving Time, in the format of HH:MM.

**syear:** Enter the start year of Daylight Saving Time.

**emonth:** Enter the end month of Daylight Saving Time. There are 12 values showing as follows: Jan, Feb, Mar, Apr, May, Jun, Jul, Aug, Sep, Oct, Nov, Dec.

**eday:** Enter the end day of Daylight Saving Time, which ranges from 1 to 31.

**etime:** Enter the end time of Daylight Saving Time, in the format of HH:MM.

**eyear:** Enter the end year of Daylight Saving Time.

**offset:** Enter the offset of Daylight Saving Time. The default value is 60.

---

Step 3    **show system-time dst**  
Verify the DST information of the switch.

---

Step 4    **end**  
Return to privileged EXEC mode.

---

Step 5    **copy running-config startup-config**  
Save the settings in the configuration file.

---

The following example shows how to set the Daylight Saving Time by Date Mode. Set the start time as 01:00 August 1st, 2017, set the end time as 01:00 September 1st, 2017 and set the offset as 50.

**Switch#configure**

**Switch(config)#system-time dst date Aug 1 01:00 2017 Sep 1 01:00 2017 50**

**Switch(config)#show system-time dst**

DST starts at 01:00:00 on Aug 1 2017

DST ends at 01:00:00 on Sep 1 2017

DST offset is 50 minutes

DST configuration is one-off

**Switch(config)#end**

**Switch#copy running-config startup-config**

## 2.2.5 Configuring LED (Only for Certain Devices)

### Note:

Only TL-SG2210P supports LED On/Off.

Follow these steps to configure the LED status:

- |        |   |
|--------|---|
| Step 1 | <b>configure</b><br>Enter global configuration mode.  |
| Step 2 | <b>service led {on   off}</b><br>Configure the LED status. By default, the LEDs are on.<br><b>on   off:</b> Turn on or turn off the LEDs. |

## 2.2.6 Configuring the System IP

Follow these steps to configure the System IP parameters.

- |        |  |
|--------|--|
| Step 1 | <b>configure</b><br>Enter global configuration mode.   |
| Step 2 | <b>ip management-vlan {vlan-id}</b><br>Configure the management VLAN of the switch. Only the computers in the management VLAN can access the management interface of the switch.   |
| Step 3 | <b>interface vlan {vlan-id}</b><br>Enter the Interface VLAN Mode.<br><br><i>vlan-id:</i> The management VLAN ID.   |
| Step 4 | Automatically assign an IP Address and default gateway for the management interface via DHCP or BOOTP:<br><b>ip address-alloc {dhcp   bootp }</b><br>Specify the IP Address assignment mode of the management interface.<br><b>dhcp:</b> Specify the management interface to obtain an IPv4 address from the DHCP Server.<br><b>bootp:</b> Specify the management interface to obtain an IPv4 address from the BOOTP Server.<br><br>Manually assign an IP Address and default gateway for the management interface:<br><b>ip address {ip-addr } { mask } gateway { default-gateway }</b><br>Configure the IP address and default gateway for the management interface manually.<br><b>ip-addr:</b> Specify the IP address of the management interface.<br><b>mask:</b> Specify the subnet mask of the management interface.<br><b>default gateway:</b> Specify the default gateway of the management interface if you select the IP Address Mode as Static. The default gateway is the IP address to which the packet should be sent next. |

|        |   |
|--------|---|
| Step 5 | <b>show interface vlan { vlan-id }</b><br><i>vlan-id</i> : The management VLAN ID.<br><br>Verify the summary information of the management interface. |
| Step 6 | <b>end</b><br><br>Return to privileged EXEC mode.   |
| Step 7 | <b>copy running-config startup-config</b><br><br>Save the settings in the configuration file.   |

The following example shows how to configure the switch's IP address as **192.168.0.10/24** and configure the default gateway as **192.168.0.100**.

**Switch#configure**

**Switch(config)#interface vlan 1**

**Switch(config-if)#ip address 192.168.0.10 255.255.255.0 gateway 192.168.0.100**

The connection will be interrupted and you should telnet to the switch's new IP address **192.168.0.10**.

**C:\Users\Administrator>telnet 192.168.0.10**

**User:admin**

**Password:admin**

**Switch>enable**

**Switch#show interface vlan 1**

**Switch#copy running-config startup-config**

## 2.2.7 Configuring System IPv6 Parameters

Follow these steps to configure the system IPv6 parameters.

|        |  |
|--------|--|
| Step 1 | <b>configure</b><br><br>Enter global configuration mode.   |
| Step 2 | <b>ip management-vlan { vlan-id }</b><br><br>Configure the management VLAN of the switch. Only the computers in the management VLAN can access the management interface of the switch. |
| Step 3 | <b>interface vlan { vlan-id }</b><br><br>Enter the Interface VLAN Mode.<br><br><i>vlan-id</i> : The management VLAN ID.  |

---

|        |   |
|--------|---|
| Step 4 | <b>ipv6 enable</b><br>Enable the IPv6 feature on the management interface.  |
| Step 5 | Configure the IPv6 link-local address for the management interface:<br><br>Manually configure the ipv6 link-local address for the management interface:<br><b>ipv6 address ipv6-addr link-local</b><br><i>ipv6-addr</i> : Specify the link-local address of the interface. It should be a standardized IPv6 address with the prefix fe80::/10, otherwise this command will be invalid.<br><br>Automatically configure the ipv6 link-local address for the management interface:<br><b>ipv6 address autoconfig</b>   |
| Step 6 | Configure the IPv6 global address for the management interface:<br><br>Automatically configure the interface's global IPv6 address via RA message:<br><b>ipv6 address ra</b><br>Configure the interface's global IPv6 address according to the address prefix and other configuration parameters from its received RA (Router Advertisement) message.<br><br>Automatically configure the interface's global IPv6 address via DHCPv6 server:<br><b>ipv6 address dhcp</b><br>Enable the DHCPv6 Client function. When this function is enabled, the Layer 3 interface will try to obtain the IPv6 address from DHCPv6 server.<br><br>Manually configure the interface's global IPv6 address:<br><b>ipv6 address ipv6-addr</b><br><i>ipv6-addr</i> : The Global IPv6 address with network prefix, for example 3ffe::1/64.<br><b>ipv6 address ipv6-addr eui-64</b><br>Specify a global IPv6 address with an extended unique identifier (EUI) in the low-order 64 bits of the IPv6 address. Specify only the network prefix; the last 64 bits are automatically computed from the switch MAC address. This enables IPv6 processing on the interface.<br><br>Manually configure the IPv6 gateway address:<br><b>ipv6 gateway ipv6-addr</b><br>Specify an IPv6 gateway address manually, for example 2001::1. |
| Step 7 | <b>show ipv6 interface</b><br>Verify the configured ipv6 information of the interface.  |
| Step 8 | <b>end</b><br>Return to privileged EXEC mode.   |
| Step 9 | <b>copy running-config startup-config</b><br>Save the settings in the configuration file.   |

---

The following example shows how to enable the IPv6 function and configure the IPv6 parameters of the management interface:

**Switch#configure**

**Switch(config)#interface vlan 1**

**Switch(config-if)#ipv6 enable**

**Switch(config-if)#ipv6 address autoconfig**

**Switch(config-if)#ipv6 address dhcp**

**Switch(config-if)#show ipv6 interface**

Vlan2 is up, line protocol is up

IPv6 is enable, Link-Local Address: fe80::20a:ebff:fe13:237b[NOR]

Global Address RA: Disable

Global Address DHCPv6: Enable

Global unicast address(es): ff02::1:ff13:237b

Joined group address(es): ff02::1

ICMP error messages limited to one every 1000 milliseconds

ICMP redirects are enable

MTU is 1500 bytes

ND DAD is enable, number of DAD attempts: 1

ND retrans timer is 1000 milliseconds

ND reachable time is 30000 milliseconds

**Switch(config-if)#end**

**Switch#copy running-config startup-config**

# 3 User Management Configurations

With User Management, you can create and manage the user accounts for login to the switch.

## 3.1 Using the GUI

There are four types of user accounts with different access levels: Admin, Operator, Power User and User.



- There is a default Admin account which cannot be deleted. The default username and password of this account are both admin. You can also create more Admin accounts.
- If you create Operator, Power User or User accounts, you need go to the AAA section to create an Enable Password. If needed, these types of users can use the Enable Password to change their access level to Admin.

### 3.1.1 Creating Accounts

Choose the menu **SYSTEM > User Management > User Config** to load the following page.

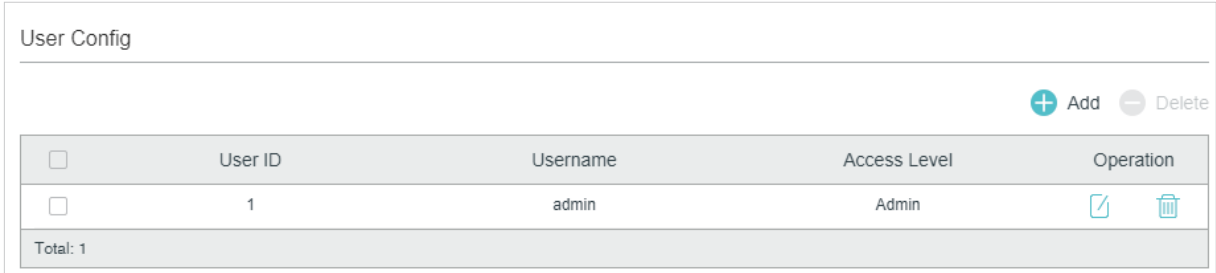
Figure 3-1 User Config Page



| <input type="checkbox"/> | User ID | Username | Access Level | Operation   |
|--------------------------|---------|----------|--------------|---|
| <input type="checkbox"/> | 1       | admin    | Admin        |   |

Total: 1

By default, there is a default Admin account in the table. You can click  to edit this Admin account but you cannot delete it.

You can create new user accounts. Click  Add and the following window will pop up.

Figure 3-2 Adding Account

Follow these steps to create a new user account.

1) Configure the following parameters:

|                         |  |
|-------------------------|--|
| <b>Username</b>         | Specify a username for the account. It contains 16 characters at most, composed of digits, English letters and symbols. No spaces, question marks and double quotation marks are allowed.  |
| <b>Access Level</b>     | Select the access level. There are four options provided:<br><br><b>Admin:</b> Admin can edit, modify and view all the settings of different functions.<br><br><b>Operator:</b> Operator can edit, modify and view most of the settings of different functions.<br><br><b>Power User:</b> Power User can edit, modify and view some of the settings of different functions.<br><br><b>User:</b> User can only view the settings without the right to edit or modify. |
| <b>Password</b>         | Specify a password for the account. It contains 6–31 alphanumeric characters (case-sensitive) and symbols. No spaces are allowed.  |
| <b>Confirm Password</b> | Retype the password.   |

2) Click **Create**.

### 3.1.2 Configuring Enable Password

Choose the menu **SECURITY > AAA > Global Config** to load the following page.

Figure 3-3 Configure Enable Password



Follow these steps to configure Enable Password:

- 1) Select **Set Password** and specify the enable password in the **Password** field. It should be a string with 31 characters at most, which can contain only English letters (case sensitive) digits and 17 kinds of special characters. The special characters are **!\$%()'\*,-./\_{}.**
- 2) Click **Apply**.

*Tips:*

The logged-in users can enter the Enable Password on this page to get the administrative privileges.

## 3.2 Using the CLI

There are four types of user accounts with different access levels: Admin, Operator, Power User and User.

- There is a default Admin account which cannot be deleted. The default username and password of this account are both admin. You can also create more Admin accounts.
- If you create Operator, Power User or User accounts, you need go to the AAA section to create an Enable Password. If needed, these types of users can use the Enable Password to change their access level to Admin.

### 3.2.1 Creating Accounts

Follow these steps to create an account:

- 
- |        |                                  |
|--------|----------------------------------|
| Step 1 | <b>configure</b>                 |
|        | Enter global configuration mode. |
-

---

Step 2 Use the following command to create an account unencrypted or symmetric encrypted.

**user name** *name* { **privilege** admin | operator | power\_user | user } **password** { [ 0 ] *password* | 7 *encrypted-password* }

*name*: Enter a user name for users' login. It contains 16 characters at most, composed of digits, English letters and symbols. No spaces, question marks and double quotation marks are allowed.

**admin | operator | power\_user | user**: Specify the access level for the user. Admin can edit, modify and view all the settings of different functions. Operator can edit, modify and view mostly the settings of different functions. Power User can edit, modify and view some the settings of different functions. User only can view the settings without the right to edit and modify.

**0**: Specify the encryption type. 0 indicates that the password you entered is unencrypted, and the password is saved to the configuration file unencrypted. By default, the encryption type is 0.

*password*: Enter a password for users' login. It contains 6–31 alphanumeric characters (case-sensitive) and symbols. No spaces are allowed.

**7**: Specify the encryption type. 7 indicates that the password you entered is symmetric encrypted, and the password is saved to the configuration file symmetric encrypted.

*encrypted-password*: Enter a symmetric encrypted password with fixed length, which you can copy from another switch's configuration file. After the encrypted password is configured, you should use the corresponding unencrypted password to reenter this mode.

Use the following command to create an account MD5 encrypted.

**user name** *name* { **privilege** admin | operator | power\_user | user } **secret** { [ 0 ] *password* | 5 *encrypted-password* }

Create an account whose access level is Admin.

*name*: Enter a user name for users' login. It contains 16 characters at most, composed of digits, English letters and symbols. No spaces, question marks and double quotation marks are allowed.

**admin | operator | power\_user | user**: Specify the access level for the user. Admin can edit, modify and view all the settings of different functions. Operator can edit, modify and view mostly the settings of different functions. Power User can edit, modify and view some the settings of different functions. User only can view the settings without the right to edit and modify.

**0**: Specify the encryption type. 0 indicates that the password you entered is unencrypted, but the password is saved to the configuration file MD5 encrypted. By default, the encryption type is 0.

*password*: Enter a password for users' login. It contains 6–31 alphanumeric characters (case-sensitive) and symbols. No spaces are allowed.

**5**: Specify the encryption type. 5 indicates that the password you entered is MD5 encrypted, and the password is saved to the configuration file MD5 encrypted.

*encrypted-password*: Enter a MD5 encrypted password with fixed length, which you can copy from another switch's configuration file.

---

Step 3 **show user account-list**

Verify the information of the current users.

---

- 
- Step 4     **end**  
Return to privileged EXEC mode.
- 
- Step 5     **copy running-config startup-config**  
Save the settings in the configuration file.
- 

## 3.2.2 Configuring Enable Password

Follow these steps to create an account of other type:

- 
- Step 1     **configure**  
Enter global configuration mode.
- 
- Step 2     Use the following command to create an enable password unencrypted or symmetric encrypted.
- enable admin password { [ 0 ] password | 7 encrypted-password }**
- Create an Enable Password. It can change the users' access level to Admin. By default, it is empty.
- 0:** Specify the encryption type. 0 indicates that the password you entered is unencrypted, and the password is saved to the configuration file unencrypted. By default, the encryption type is 0.
- password:** It is a string with 31 characters at most, which can contain only English letters (case-sensitive), digits and 17 kinds of special characters. The special characters are `!$%()*,-./[]_{}.`
- 7:** Specify the encryption type. 7 indicates that the password you entered is symmetric encrypted, and the password is saved to the configuration file symmetric encrypted.
- encrypted-password:** Enter a symmetric encrypted password with fixed length, which you can copy from another switch's configuration file. After the encrypted password is configured, you should use the corresponding unencrypted password to reenter this mode.
- Use the following command to create an enable password unencrypted or MD5 encrypted.
- enable admin secret { [ 0 ] password | 5 encrypted-password }**
- Create an Enable Password. It can change the users' access level to Admin. By default, it is empty.
- 0:** Specify the encryption type. 0 indicates that the password you entered is unencrypted, but the password is saved to the configuration file MD5 encrypted. By default, the encryption type is 0.
- password:** It is a string with 31 characters at most, which can contain only English letters (case-sensitive), digits and 17 kinds of special characters. The special characters are `!$%()*,-./[]_{}.`
- 5:** Specify the encryption type. 5 indicates that the password you entered is MD5 encrypted, and the password is saved to the configuration file MD5 encrypted.
- encrypted-password:** Enter a MD5 encrypted password with fixed length, which you can copy from another switch's configuration file. After the encrypted password is configured, you should use the corresponding unencrypted password to reenter this mode.
- 
- Step 3     **show user account-list**  
Verify the information of the current users.
-

---

Step 4     **end**  
Return to privileged EXEC mode.

---

Step 5     **copy running-config startup-config**  
Save the settings in the configuration file.

---

*Tips:*

The logged-in users can enter the enable-admin command and the Enable Password to get the administrative privileges.

The following example shows how to create a user with the access level of Operator, set the username as user1 and password as 123, and set the enable password as abc123.

**Switch#configure**

**Switch(config)#user name user1 privilege operator password 123**

**Switch(config)#enable admin password abc123**

**Switch(config)#show user account-list**

| Index | User-Name | User-Type |
|-------|-----------|-----------|
| ----- | -----     | -----     |
| 1     | user1     | Operator  |
| 2     | admin     | Admin     |

**Switch(config)#end**

**Switch#copy running-config startup-config**

# 4 System Tools Configurations

With System Tools, you can:

- Configure the boot file
- Restore the configuration of the switch
- Back up the configuration file
- Upgrade the firmware
- Reboot the switch
- Reset the switch

## 4.1 Using the GUI

### 4.1.1 Configuring the Boot File

Choose the menu **SYSTEM > System Tools > Boot Config** to load the following page.

Figure 4-1 Configuring the Boot File

Boot Config

| <input checked="" type="checkbox"/> | Unit | Current Startup Image | Next Startup Image | Backup Image      | Current Startup Config | Next Startup Config                   | Backup Config                        |
|-------------------------------------|------|-----------------------|--------------------|-------------------|------------------------|---------------------------------------|--------------------------------------|
| <input checked="" type="checkbox"/> | 1    | Image_1.bin           | Image_1.bin        | Image_2.bin       | Config_1.cfg           | Config_1.cfg                          | Config_2.cfg                         |
| Total: 1                            |      |                       |                    | 1 entry selected. |                        | <input type="button" value="Cancel"/> | <input type="button" value="Apply"/> |

Image Table

UNIT1

▼ Current Startup Image

Image Name: image1.bin

Software Version: 3.0.0

Flash Version: 1.3.0

▼ Next Startup Image

Image Name: image1.bin

Software Version: 3.0.0

Flash Version: 1.3.0

▼ Backup Image

Image Name: image2.bin

Software Version: 3.0.0

Flash Version: 1.3.0

Follow these steps to configure the boot file:

- 1) In the **Boot Table** section, select one or more units and configure the relevant parameters.

|                        |   |
|------------------------|---|
| Unit                   | Displays the number of the unit.  |
| Current Startup Image  | Displays the current startup image.   |
| Next Startup Image     | Select the next startup image. When the switch is powered on, it will try to start up with the next startup image. The next startup image and backup image should not be the same.  |
| Backup Image           | Select the backup image. When the switch fails to start up with the next startup image, it will try to start up with the backup image. The next startup and backup image should not be the same.                                  |
| Current Startup Config | Displays the current startup configuration.   |
| Next Startup Config    | Specify the next startup configuration. When the switch is powered on, it will try to start up with the next startup configuration. The next startup configuration and backup configuration should not be the same.               |
| Backup Config          | Specify the backup configuration. When the switch fails to start up with the next startup configuration, it will try to start up with the backup configuration. The next startup and backup configuration should not be the same. |

- 2) Click **Apply**.

In the **Image Table**, you can view the information of the current startup image, next startup image and backup image. The displayed information is as follows:

|                  |   |
|------------------|---|
| Image Name       | Displays the name of the image.             |
| Software Version | Displays the software version of the image. |
| Flash Version    | Displays the flash version of the image.    |

## 4.1.2 Restoring the Configuration of the Switch

Choose the menu **SYSTEM > System Tools > Restore Config** to load the following page.

Figure 4-2 Restoring the Configuration of the Switch

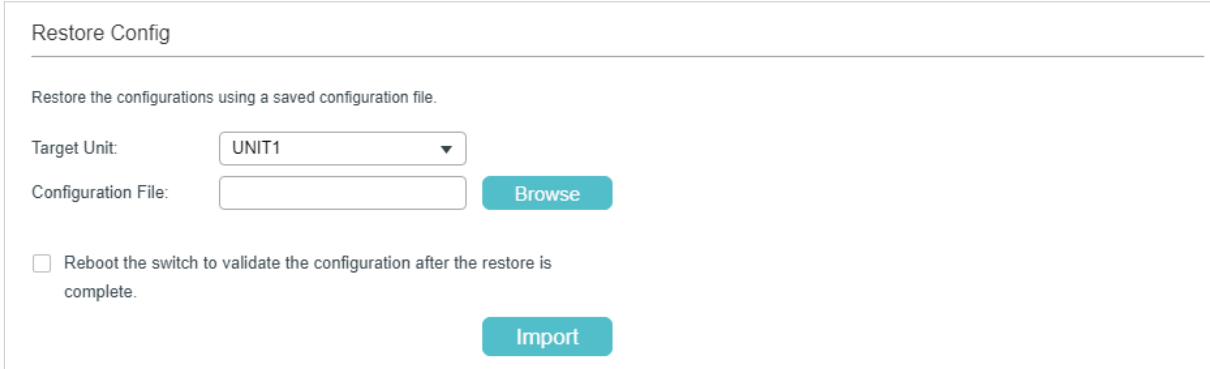

Follow these steps to restore the current configuration of the switch:

- 1) In the **Restore Config** section, select the unit to be restored.
- 2) Click **Browse** and select the desired configuration file to be imported.
- 3) Choose whether to reboot the switch after restoring is completed. Only after the switch is rebooted will the imported configuration take effect.
- 4) Click **Import** to import the configuration file.

 **Note:**

It will take some time to restore the configuration. Please wait without any operation.

## 4.1.3 Backing up the Configuration File

Choose the menu **SYSTEM > System Tools > Backup Config** to load the following page.

Figure 4-3 Backing up the Configuration File

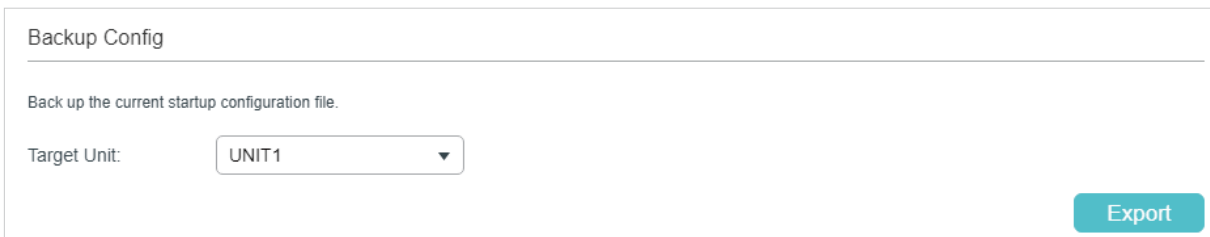

In the **Config Backup** section, select one unit and click **Export** to export the configuration file.

 **Note:**

It will take some time to export the configuration. Please wait without any operation.

## 4.1.4 Upgrading the Firmware

Choose the menu **SYSTEM > System Tools > Firmware Upgrade** to load the following page.

Figure 4-4 Upgrading the Firmware

**Firmware Upgrade**

---

You can upgrade the firmware of the switch using the new upgrade file.

Firmware Version: 3.0.0 Build 20171011 Rel.72184(s)  
 Hardware Version: T1500-28PCT 3.0  
 Image Name: Backup Image  
 Firmware File:  Browse

Reboot the switch using the backup image after upgrading is completed.

Upgrade

You can view the current firmware information on this page:

|                         |   |
|-------------------------|---|
| <b>Firmware Version</b> | Displays the current firmware version of the system.                                    |
| <b>Hardware Version</b> | Displays the current hardware version of the system.                                    |
| <b>Image Name</b>       | Displays the image to upgrade. The operation will only affect the image displayed here. |

Follow these steps to upgrade the firmware of the switch:

- 1) Click **Browse** and select the proper firmware upgrade file.
- 2) Choose whether to reboot the switch after upgrading is completed. Only after the switch is rebooted will the new firmware take effect.
- 3) Click **Upgrade** to upgrade the system.

 **Note:**

- It will take some time to upgrade the switch. Please wait without any operation.
- It is recommended to backup your configuration before upgrading.



## 4.1.5 Rebooting the switch

There are two methods to reboot the switch: manually reboot the switch and configure reboot schedule to automatically reboot the switch.

### Manually Rebooting the Switch

Choose the menu **SYSTEM > System Tools > System Reboot > System Reboot** to load the following page.

Figure 4-5 Manually Rebooting the Switch

The screenshot shows the 'System Reboot' configuration page. At the top, it says 'System Reboot'. Below that, there is a 'Target Unit:' label followed by a dropdown menu currently showing 'All Unit'. Underneath the dropdown is a checkbox labeled 'Save the current configuration before reboot' which is currently unchecked. In the bottom right corner, there is a blue button labeled 'Reboot'.

Follow these steps to reboot the switch:

- 1) In the **System Reboot** section, select the desired unit.
- 2) Choose whether to save the current configuration before reboot.
- 3) Click **Reboot**.

### Configuring Reboot Schedule

Choose the menu **SYSTEM > System Tools > System Reboot > Reboot Schedule** to load the following page.

Figure 4-6 Configuring the Reboot Schedule

The screenshot shows the 'Reboot Schedule Config' page. At the top, it says 'Reboot Schedule Config'. Below that, there is a 'Reboot Schedule:' label followed by a checked checkbox labeled 'Enable'. Underneath, there are two radio button options: 'Time Interval:' (selected) with a text input field containing '360' and the text 'minutes (1-43200)' to its right, and 'Special Time:' (unselected) with four dropdown menus for 'Month' (January), 'Day' (1), 'Year' (2000), and 'Time (HH:MM)'. Below these options is a checkbox labeled 'Save the current configuration before reboot' which is unchecked. In the bottom right corner, there is a blue button labeled 'Apply'.

Follow these steps to configure the reboot schedule:

- 1) Enable Reboot Schedule, and select one time schedule for the switch to reboot.

**Time Interval** Specify a period of time. The switch will reboot after this period. Valid values are from 1 to 43200 minutes.

To make this schedule recur, you need to click  **Save** to save current configuration or enable the option **Save the current configuration before reboot**.

|                     |   |
|---------------------|---|
| <b>Special Time</b> | Specify the date and time for the switch to reboot.<br><br><b>Month/Day/Year:</b> Specify the date for the switch to reboot.<br><br><b>Time (HH:MM):</b> Specify the time for the switch to reboot, in the format of HH:MM. |
|---------------------|---|

- 2) Choose whether to save the current configuration before the reboot.
- 3) Click **Apply**.

## 4.1.6 Resetting the Switch

Choose the menu **SYSTEM > System Tools > System Reset** to load the following page.

Figure 4-7 Resetting the Switch

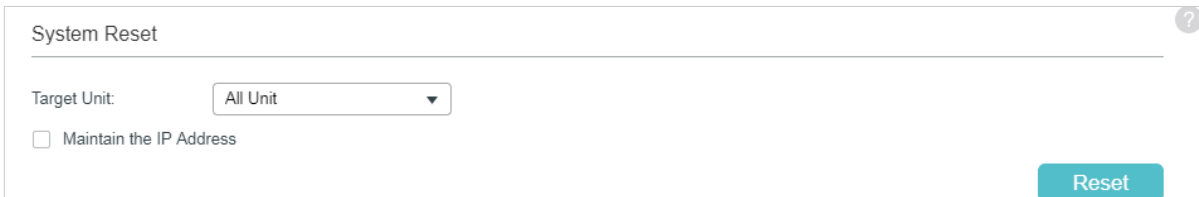

Follow these steps to reset the switch:

- 1) In the **System Reset** section, select the desired unit.
- 2) Choose whether to maintain the IP address of selected unit when resetting.
- 3) Click **Reset**.

After reset, all configurations of the switch will be reset to the factory defaults.

## 4.2 Using the CLI

### 4.2.1 Configuring the Boot File

Follow these steps to configure the boot file:

|        |  |
|--------|--|
| Step 1 | <b>configure</b><br>Enter global configuration mode.   |
| Step 2 | <b>boot application filename { image1   image2 } { startup   backup }</b><br>Specify the configuration of the boot file. By default, image1.bin is the startup image and image2.bin is the backup image.<br><br><b>image1   image2:</b> Select the image file to be configured.<br><b>startup   backup:</b> Select the property of the image file. |

- 
- Step 3     **boot config filename { config1 | config2 } { startup | backup }**  
 Specify the configuration of the boot file. By default, config1.cfg is the startup configuration file and config2.cfg is the backup configuration file.
- config1 | config2:** Select the configuration file to be configured.  
**startup | backup:** Specify the property of the configuration file.
- 
- Step 4     **show boot**  
 Verify the boot configuration of the system.
- 
- Step 5     **end**  
 Return to privileged EXEC mode.
- 
- Step 6     **copy running-config startup-config**  
 Save the settings in the configuration file.
- 

The following example shows how to set the next startup image as image1, the backup image as image2, the next startup configuration file as config1 and the backup configuration file as config2.

### Switch#configure

**Switch(config)#boot application filename image1 startup**

**Switch(config)#boot application filename image2 backup**

**Switch(config)#boot config filename config1 startup**

**Switch(config)#boot config filename config2 backup**

### Switch(config)#show boot

Boot config:

Current Startup Image     - image2.bin

Next Startup Image       - image1.bin

Backup Image             - image2.bin

Current Startup Config   - config2.cfg

Next Startup Config      - config1.cfg

Backup Config            - config2.cfg

### Switch(config)#end

### Switch#copy running-config startup-config

## 4.2.2 Restoring the Configuration of the Switch

Follow these steps to restore the configuration of the switch:

Step 1     **enable**

Enter privileged mode.

Step 2     **copy tftp startup-config ip-address *ip-addr* filename *name***

Download the configuration file to the switch from TFTP server.

*ip-addr*: Specify the IP address of the TFTP server. Both IPv4 and IPv6 addresses are supported.

*name*: Specify the name of the configuration file to be downloaded.

 **Note:**

It will take some time to restore the configuration. Please wait without any operation.

The following example shows how to restore the configuration file named file1 from the TFTP server with IP address 192.168.0.100.

**Switch>enable**

**Switch#copy tftp startup-config ip-address 192.168.0.100 filename file1**

Start to load user config file...

Operation OK! Now rebooting system...

## 4.2.3 Backing up the Configuration File

Follow these steps to back up the current configuration of the switch in a file:

Step 1     **enable**

Enter privileged mode.

Step 2     **copy startup-config tftp ip-address *ip-addr* filename *name***

Back up the configuration file to TFTP server.

*ip-addr*: Specify the IP address of the TFTP server. Both IPv4 and IPv6 addresses are supported.

*name*: Specify the name of the configuration file to be saved.

The following example shows how to backup the configuration file named file2 to TFTP server with IP address 192.168.0.100.

**Switch>enable**

**Switch#copy startup-config tftp ip-address 192.168.0.100 filename file2**

Start to backup user config file...

Backup user config file OK.

## 4.2.4 Upgrading the Firmware

Follow these steps to upgrade the firmware:

---

Step 1     **enable**

Enter privileged mode.

---

Step 2     **firmware upgrade tftp ip-address ip-addr filename name**

Upgrade the switch's backup image via TFTP server. To boot up with the new firmware, you need to choose to reboot the switch with the backup image.

*ip-addr*: Specify the IP address of the TFTP server. Both IPv4 and IPv6 addresses are supported.

*name*: Specify the name of the desired firmware file.

---

Step 3     Enter Y to continue and then enter Y to reboot the switch with the backup image.

---

The following example shows how to upgrade the firmware using the configuration file named file3.bin. The TFTP server is 190.168.0.100.

**Switch>enable**

**Switch#firmware upgrade tftp ip-address 192.168.0.100 filename file3.bin**

It will only upgrade the backup image. Continue? (Y/N):Y

Operation OK!

Reboot with the backup image? (Y/N): Y

## 4.2.5 Rebooting the Switch

### Manually Rebooting the Switch

Follow these steps to reboot the switch:

---

Step 1     **enable**

Enter privileged mode.

---

Step 2     **reboot**

Reboot the switch.

---

### Configuring Reboot Schedule

Follow these steps to configure the reboot schedule:

---

Step 1     **configure**

Enter global configuration mode.

---

---

Step 2 Use the following command to set the interval of reboot:

**reboot-schedule in interval [ save\_before\_reboot ]**

(Optional) Specify the reboot schedule.

*interval*: Specify a period of time. The switch will reboot after this period. The valid values are from 1 to 43200 minutes.

**save\_before\_reboot**: Save the configuration file before the switch reboots. To make this schedule recur, you can add this part to the command.

Use the following command to set the special time of reboot:

**reboot-schedule at time [ date ] [ save\_before\_reboot ]**

(Optional) Specify the reboot schedule.

*time*: Specify the time for the switch to reboot, in the format of HH:MM.

*date*: Specify the date for the switch to reboot, in the format of DD/MM/YYYY. The date should be within 30 days.

**save\_before\_reboot**: Save the configuration file before the switch reboots.

If no date is specified, the switch will reboot according to the time you have set. If the time you set is later than the time that this command is executed, the switch will reboot later the same day; otherwise the switch will reboot the next day.

---

Step 3 **end**  
Return to privileged EXEC mode.

---

Step 4 **copy running-config startup-config**  
Save the settings in the configuration file.

---

The following example shows how to set the switch to reboot at 12:00 on 15/08/2017.

**Switch#configure**

**Switch(config)#reboot-schedule at 12:00 15/08/2017 save\_before\_reboot**

Reboot system at 15/08/2017 12:00. Continue? (Y/N): Y

Reboot Schedule Settings

-----

Reboot schedule at 2017-08-15 12:00 (in 25582 minutes)

Save before reboot: Yes

**Switch(config)#end**

**Switch#copy running-config startup-config**

## 4.2.6 Resetting the Switch

Follow these steps to reset the switch:

---

Step 1     **enable**

Enter privileged mode.

---

Step 2     **reset [ except-ip ]**

Reset the switch, and all configurations of the switch will be reset to the factory defaults.

**except-ip:** To maintain the IP address when resetting the switch, add this part to the command

---

Follow these steps to disable the reset function of console port or reset button:

---

Step 1     **configure**

Enter global configuration mode.

---

Step 2     **service reset-disable**

Disable the reset function of console port or reset button. By default, the reset function is enabled.

Note: use the **no service reset-disable** command to enable the reset function of console port.

---

# 5 EEE Configuration

Choose the menu **SYSTEM** > **EEE** to load the following page.

Figure 5-1 Configuring EEE

The screenshot shows the 'EEE Config' web interface. It has two tabs: 'UNIT1' (selected) and 'LAGS'. Below the tabs is a table with columns for 'Port' and 'Status'. The first row, '1/0/1', is selected with a checked checkbox and has a 'Disabled' status. The other rows, from '1/0/2' to '1/0/10', have unchecked checkboxes and 'Disabled' status. At the bottom, there is a summary bar showing 'Total: 28' and '1 entry selected.', along with 'Cancel' and 'Apply' buttons.

| Port                                      | Status   |
|---|----------|
| <input checked="" type="checkbox"/> 1/0/1 | Disabled |
| <input type="checkbox"/> 1/0/2            | Disabled |
| <input type="checkbox"/> 1/0/3            | Disabled |
| <input type="checkbox"/> 1/0/4            | Disabled |
| <input type="checkbox"/> 1/0/5            | Disabled |
| <input type="checkbox"/> 1/0/6            | Disabled |
| <input type="checkbox"/> 1/0/7            | Disabled |
| <input type="checkbox"/> 1/0/8            | Disabled |
| <input type="checkbox"/> 1/0/9            | Disabled |
| <input type="checkbox"/> 1/0/10           | Disabled |

Total: 28      1 entry selected.      Cancel      Apply

Follow these steps to configure EEE:

- 1) In the **EEE Config** section, select one or more ports to be configured.
- 2) Enable or disable EEE on the selected port(s).
- 3) Click **Apply**.

## 5.1 Using the CLI

Follow these steps to configure EEE:

|        |  |
|--------|--|
| Step 1 | <b>configure</b><br>Enter global configuration mode.   |
| Step 2 | <b>interface { fastEthernet port   range fastEthernet port-list   gigabitEthernet port   range gigabitEthernet port-list   ten-gigabitEthernet port   range ten-gigabitEthernet port-list }</b><br>Enter interface configuration mode. |
| Step 3 | <b>eee</b><br>Enable EEE on the port.  |



---

Step 4     **end**  
Return to privileged EXEC mode.

---

Step 5     **copy running-config startup-config**  
Save the settings in the configuration file.

---

The following example shows how to enable the EEE feature on port 1/0/1.

**Switch#config**

**Switch(config)#interface gigabitEthernet 1/0/1**

**Switch(config-if)#eee**

**Switch(config-if)#show interface eee**

Port     EEE status

Gi1/0/1   Enable

Gi1/0/2   Disable

...

**Switch(config-if)#end**

**Switch#copy running-config startup-config**

# 6 PoE Configurations (Only for Certain Devices)

---

 Note:

Only T1500-28PCT, TL-SG2210MP and TL-SG2210P support the PoE feature.

---

With the PoE feature, you can:

- Configure the PoE parameters manually
- Configure the PoE parameters using the profile

You can configure the PoE parameters one by one via configuring the PoE parameters manually. You can also set a profile with the desired parameters and bind the profile to the corresponding ports to quickly configure the PoE parameters.

## 6.1 Using the GUI

### 6.1.1 Configuring the PoE Parameters Manually

Choose the menu **SYSTEM > PoE > PoE Config** to load the following page.

Figure 6-1 Configuring PoE Parameters Manually

PoE Config

| Unit     | System Power Limit (W) | System Power Consumption (W) | System Power Remain (W) | Operation |
|----------|------------------------|------------------------------|-------------------------|-----------|
| Unit1    | 384.0                  | 0.0                          | 384.0                   |           |
| Total: 1 |                        |                              |                         |           |

Port Config

UNIT1

| <input type="checkbox"/>            | Port | PoE Status | PoE Priority | Power Limit | Power Limit Value<br>(0.1-30.0 W) | Time Range | PoE Profile | Power (W) | Current |
|-------------------------------------|------|------------|--------------|-------------|-----------------------------------|------------|-------------|-----------|---------|
| <input checked="" type="checkbox"/> | 1    | Enabled    | Low          | Class4      | 30                                | No Limit   | None        | 0         |         |
| <input type="checkbox"/>            | 2    | Enabled    | Low          | Class4      | 30                                | No Limit   | None        | 0         |         |
| <input type="checkbox"/>            | 3    | Enabled    | Low          | Class4      | 30                                | No Limit   | None        | 0         |         |
| <input type="checkbox"/>            | 4    | Enabled    | Low          | Class4      | 30                                | No Limit   | None        | 0         |         |
| <input type="checkbox"/>            | 5    | Enabled    | Low          | Class4      | 30                                | No Limit   | None        | 0         |         |
| <input type="checkbox"/>            | 6    | Enabled    | Low          | Class4      | 30                                | No Limit   | None        | 0         |         |
| <input type="checkbox"/>            | 7    | Enabled    | Low          | Class4      | 30                                | No Limit   | None        | 0         |         |
| <input type="checkbox"/>            | 8    | Enabled    | Low          | Class4      | 30                                | No Limit   | None        | 0         |         |
| <input type="checkbox"/>            | 9    | Enabled    | Low          | Class4      | 30                                | No Limit   | None        | 0         |         |
| <input type="checkbox"/>            | 10   | Enabled    | Low          | Class4      | 30                                | No Limit   | None        | 0         |         |

Total: 24 1 entry selected.

Cancel
Apply

Follow these steps to configure the basic PoE parameters:

- 1) In the **PoE Config** section, you can view the current PoE parameters.

|                                     |  |
|-------------------------------------|--|
| <b>System Power Limit (W)</b>       | Displays the maximum power the PoE switch can supply.              |
| <b>System Power Consumption (W)</b> | Displays the real-time system power consumption of the PoE switch. |
| <b>System Power Remain (W)</b>      | Displays the real-time system remaining power of the PoE switch.   |

In addition, you can click and configure the System Power Limit. Click **Apply**.

Figure 6-2 Configuring System Power Limit

PoE Config

Unit: 1

System Power Limit:  W (1-58)

Cancel
Save

|                           |  |
|---------------------------|--|
| <b>Unit</b>               | Displays the unit number.                            |
| <b>System Power Limit</b> | Specify the maximum power the PoE switch can supply. |

2) In the **Port Config** section, select the port you want to configure and specify the parameters. Click **Apply**.

|                                       |   |
|---------------------------------------|---|
| <b>PoE Status</b>                     | Enable or disable the PoE function for the corresponding port. The port can supply power to the PD when its status is enable.   |
| <b>PoE Priority</b>                   | Select the priority level for the corresponding port. When the supply power exceeds the system power limit, the switch will power off PDs on low-priority ports to ensure stable running of other PDs.  |
| <b>Power Limit</b>                    | <p>Specify the maximum power the corresponding port can supply. The following options are provided:</p> <p><b>Auto:</b> The switch will allocate a value as the maximum power that the port can supply automatically.</p> <p><b>Class1:</b> The maximum power that the port can supply is 4 W.</p> <p><b>Class2:</b> The maximum power that the port can supply is 7 W.</p> <p><b>Class3:</b> The maximum power that the port can supply is 15.4 W.</p> <p><b>Class4:</b> The maximum power that the port can supply is 30 W.</p> <p><b>Manual:</b> You can enter a value manually.</p> |
| <b>Power Limit Value (0.1–30.0 W)</b> | <p>If you select <b>Manual</b> as Power Limit mode, specify a maximum power supply value in this field.</p> <p>If you select <b>Class1</b> to <b>Class4</b> as Power Limit mode, you can view the maximum power supply value in this field.</p>   |
| <b>Time Range</b>                     | Select a time range, then the port will supply power only during the time range. For how to create a time range, refer to <a href="#">Time Range Configuration</a> .  |
| <b>PoE Profile</b>                    | A quick configuration method for the corresponding ports. If one profile is selected, you will not be able to modify PoE status, PoE priority or power limit manually. For how to create a profile, refer to <a href="#">Configuring the PoE Parameters Using the Profile</a> .   |

---

|              |  |
|--------------|--|
| Power (W)    | Displays the port's real-time power supply.  |
| Current (mA) | Displays the port's real-time current.       |
| Voltage (V)  | Displays the port's real-time voltage.       |
| PD Class     | Displays the class the linked PD belongs to. |
| Power Status | Displays the port's real-time power status.  |

---

## 6.1.2 Configuring the PoE Parameters Using the Profile

### ■ Creating a PoE Profile

Choose the menu **SYSTEM > PoE > PoE Profile** and click  **Add** to load the following page.

Figure 6-3 Creating a PoE Profile

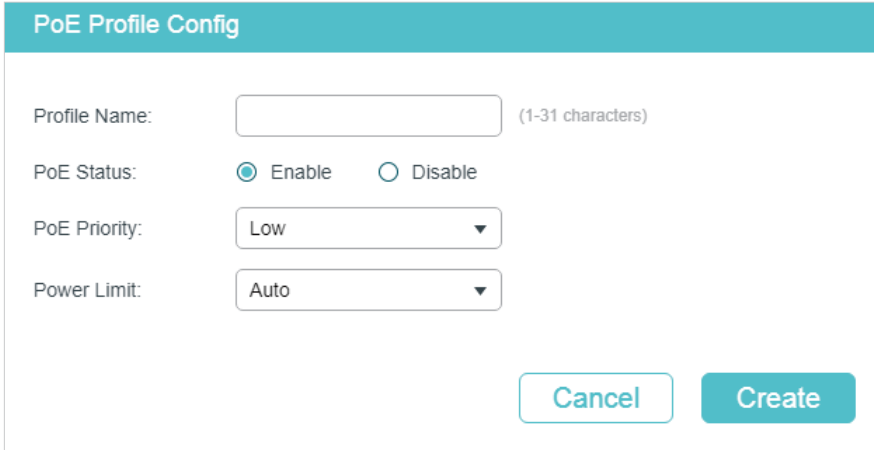

Follow these steps to create a PoE profile:

- 1) In the **Create PoE Profile** section, specify the desired configurations of the profile.

|                     |  |
|---------------------|--|
| <b>Profile Name</b> | Specify a name for the PoE profile.  |
| <b>PoE Status</b>   | Specify the PoE status for the PoE profile.  |
| <b>PoE Priority</b> | Specify the priority level for the PoE profile. The following options are provided: <b>High</b> , <b>Middle</b> and <b>Low</b> . When the supply power exceeds the system power limit, the switch will power off PDs on low-priority ports to ensure stable running of other PDs.  |
| <b>Power Limit</b>  | Specify the maximum power the port can supply for the PoE profile. The following options are provided:<br><br><b>Auto:</b> The switch will allocate a value as the maximum power that the port can supply automatically.<br><br><b>Class1 (4 W):</b> The maximum power that the port can supply is 4 W.<br><br><b>Class2 (7 W):</b> The maximum power that the port can supply is 7 W.<br><br><b>Class3 (15.4 W):</b> The maximum power that the port can supply is 15.4 W.<br><br><b>Class4 (30 W):</b> The maximum power that the port can supply is 30 W.<br><br><b>Manual:</b> Enter a value manually. |

- 2) Click **Create**.

■ Binding the Profile to the Corresponding Ports

Choose the menu **SYSTEM > PoE > PoE Config** to load the following page.

Figure 6-4 Binding the Profile to the Corresponding Ports

PoE Config

| Unit     | System Power Limit (W) | System Power Consumption (W) | System Power Remain (W) | Operation |
|----------|------------------------|------------------------------|-------------------------|-----------|
| Unit1    | 384.0                  | 0.0                          | 384.0                   |           |
| Total: 1 |                        |                              |                         |           |

Port Config

UNIT1

| <input type="checkbox"/>            | Port | PoE Status | PoE Priority | Power Limit | Power Limit Value<br>(0.1-30.0 W) | Time Range | PoE Profile | Power (W) | Current |
|-------------------------------------|------|------------|--------------|-------------|-----------------------------------|------------|-------------|-----------|---------|
| <input checked="" type="checkbox"/> | 1    | Enabled    | Low          | Class4      | 30                                | No Limit   | None        | 0         |         |
| <input type="checkbox"/>            | 2    | Enabled    | Low          | Class4      | 30                                | No Limit   | None        | 0         |         |
| <input type="checkbox"/>            | 3    | Enabled    | Low          | Class4      | 30                                | No Limit   | None        | 0         |         |
| <input type="checkbox"/>            | 4    | Enabled    | Low          | Class4      | 30                                | No Limit   | None        | 0         |         |
| <input type="checkbox"/>            | 5    | Enabled    | Low          | Class4      | 30                                | No Limit   | None        | 0         |         |
| <input type="checkbox"/>            | 6    | Enabled    | Low          | Class4      | 30                                | No Limit   | None        | 0         |         |
| <input type="checkbox"/>            | 7    | Enabled    | Low          | Class4      | 30                                | No Limit   | None        | 0         |         |
| <input type="checkbox"/>            | 8    | Enabled    | Low          | Class4      | 30                                | No Limit   | None        | 0         |         |
| <input type="checkbox"/>            | 9    | Enabled    | Low          | Class4      | 30                                | No Limit   | None        | 0         |         |
| <input type="checkbox"/>            | 10   | Enabled    | Low          | Class4      | 30                                | No Limit   | None        | 0         |         |

Total: 24
1 entry selected.

Cancel
Apply

Follow these steps to bind the profile to the corresponding ports:

- 1) In the **PoE Config** section, you can view the current PoE parameters.

|                                     |  |
|-------------------------------------|--|
| <b>System Power Limit (W)</b>       | Displays the maximum power the PoE switch can supply.              |
| <b>System Power Consumption (W)</b> | Displays the real-time system power consumption of the PoE switch. |
| <b>System Power Remain (W)</b>      | Displays the real-time system remaining power of the PoE switch.   |

In addition, you can click and configure the System Power Limit. Click **Apply**.

Figure 6-5 Configuring System Power Limit

PoE Config

Unit: 1

System Power Limit:  W (1-58)

Cancel
Save

|                           |  |
|---------------------------|--|
| <b>Unit</b>               | Displays the unit number.                            |
| <b>System Power Limit</b> | Specify the maximum power the PoE switch can supply. |

- 2) In the **Port Config** section, select one or more ports and configure the following two parameters: Time Range and PoE Profile. Click **Apply** and the PoE parameters of the selected PoE Profile, such as PoE Status and PoE Priority, will be displayed in the table.

|                                       |  |
|---------------------------------------|--|
| <b>PoE Status</b>                     | Displays the PoE function for the corresponding port. The port can supply power to the PD when its status is enable.   |
| <b>PoE Priority</b>                   | Displays the priority level for the corresponding port. When the supply power exceeds the system power limit, the switch will power off PDs on low-priority ports to ensure stable running of other PDs. |
| <b>Power Limit</b>                    | Displays the maximum power the corresponding port can supply.  |
| <b>Power Limit Value (0.1–30.0 W)</b> | Displays the power limit value.  |
| <b>Time Range</b>                     | Select a time range, then the port will supply power only during the time range. For how to create a time range, refer to <a href="#">Time Range Configuration</a> .                                     |
| <b>PoE Profile</b>                    | Select the PoE profile for the desired port. If one profile is selected, you will not be able to modify PoE status, PoE priority or power limit manually.  |
| <b>Power (W)</b>                      | Displays the port's real-time power supply.  |
| <b>Current (mA)</b>                   | Displays the port's real-time current.   |
| <b>Voltage (V)</b>                    | Displays the port's real-time voltage.   |
| <b>PD Class</b>                       | Displays the class the linked PD belongs to.   |
| <b>Power Status</b>                   | Displays the port's real-time power status.  |



## 6.2 Using the CLI

### 6.2.1 Configuring the PoE Parameters Manually

Follow these steps to configure the basic PoE parameters:

|        |  |
|--------|--|
| Step 1 | <p><b>configure</b></p> <p>Enter global configuration mode.</p>  |
| Step 2 | <p><b>power inline consumption <i>power-limit</i></b></p> <p>Specify the maximum power the PoE switch can supply globally.</p> <p><i>power-limit</i>: Specify the maximum power the PoE switch can supply.</p> <p>For T1500-28PCT, the valid value ranges from 1 to 192 W. By default, the value is 192.</p> <p>For TL-SG2210MP, the valid value ranges from 1 to 150 W. By default, the value is 150.</p> <p>For TL-SG2210P, the valid value ranges from 1 to 58 W. By default, the value is 58.</p>  |
| Step 3 | <p><b>interface { fastEthernet <i>port</i>   range fastEthernet <i>port-list</i>   gigabitEthernet <i>port</i>   range gigabitEthernet <i>port-list</i>   ten-gigabitEthernet <i>port</i>   range ten-gigabitEthernet <i>port-list</i> }</b></p> <p>Enter Interface Configuration mode.</p> <p><i>port</i>: Specify the Ethernet port number, for example 1/0/1.</p> <p><i>port-list</i>: Specify the list of Ethernet ports, for example 1/0/1-3, 1/0/5.</p>  |
| Step 4 | <p><b>power inline supply { enable   disable }</b></p> <p>Specify the PoE status for the corresponding port.</p> <p><b>enable   disable</b>: Enable or disable the PoE function. By default, it is enable.</p>   |
| Step 5 | <p><b>power inline priority { low   middle   high }</b></p> <p>Specify the PoE priority for the corresponding port.</p> <p><b>low   middle   high</b>: Select the priority level for the corresponding port. When the supply power exceeds the system power limit, the switch will power off PDs on low-priority ports to ensure stable running of other PDs. The default setting is low.</p>  |
| Step 6 | <p><b>power inline consumption { <i>power-limit</i>   auto   class1   class2   class3   class4 }</b></p> <p>Specify the maximum power the corresponding port can supply.</p> <p><i>power-limit</i>   auto   class1   class2   class3   class4: Select or enter the maximum power the corresponding port can supply. The following options are provided: Auto represents that the switch will allocate the maximum power that the port can supply automatically. Class1 represents 4 W, Class2 represents 7 W, Class3 represents 15.4 W and Class4 represents 30 W, or you can enter a value manually. The value ranges from 1 to 300. It is in the unit of 0.1 watt. For instance, if you want to configure the maximum power as 5 W, you should enter 50. By default, it is Class4.</p> |
| Step 7 | <p><b>time-range <i>name</i></b></p> <p>Specify a time range for the port. Then the port will supply power only during the time range. For how to create a time range, refer to <a href="#">Time Range Configuration</a>.</p> <p><i>name</i>: Specify the name of the time range.</p>  |

- 
- Step 8     **show power inline**  
Verify the global PoE information of the system.
- 
- Step 9     **show power inline configuration interface [ fastEthernet { port | port-list } | gigabitEthernet { port | port-list } | ten-gigabitEthernet { port | port-list } ]**  
Verify the PoE configuration of the corresponding port.  
*port*: Specify the Ethernet port number, for example 1/0/1.  
*port-list*: Specify the list of Ethernet ports, in the format of 1/0/1-3, 1/0/5.
- 
- Step 10    **show power inline information interface [ fastEthernet { port | port-list } | gigabitEthernet { port | port-list } | ten-gigabitEthernet { port | port-list } ]**  
Verify the real-time PoE status of the corresponding port.  
*port*: Specify the Ethernet port number, for example 1/0/1.  
*port-list*: Specify the list of Ethernet ports, in the format of 1/0/1-3, 1/0/5.
- 
- Step 11    **end**  
Return to privileged EXEC mode.
- 
- Step 12    **copy running-config startup-config**  
Save the settings in the configuration file.
- 

The following example shows how to set the system power limit as 160 W. Set the priority as middle and set the power limit as class3 for the port 1/0/5.

### Switch#configure

Switch(config)#power inline consumption 160

Switch(config)#interface gigabitEthernet 1/0/5

Switch(config-if)#power inline supply enable

Switch(config-if)#power inline priority middle

Switch(config-if)#power inline consumption class3

Switch(config-if)#show power inline

System Power Limit: 160.0w

System Power Consumption: 0.0w

System Power Remain: 160.0w

Switch(config-if)#show power inline configuration interface gigabitEthernet 1/0/5

| Interface | PoE-Status | PoE-Prio | Power-Limit(w) | Time-Range | PoE-Profile |
|-----------|------------|----------|----------------|------------|-------------|
| -----     | -----      | -----    | -----          | -----      | -----       |
| Gi1/0/5   | Enable     | Middle   | Class3         | No Limit   | None        |

**Switch(config-if)#show power inline information interface gigabitEthernet 1/0/5**

| Interface | Power(w) | Current(mA) | Voltage(v) | PD-Class | Power-Status |
|-----------|----------|-------------|------------|----------|--------------|
| -----     | -----    | -----       | -----      | -----    | -----        |
| Gi1/0/5   | 1.3      | 26          | 53.5       | Class 2  | ON           |

**Switch(config-if)#end****Switch#copy running-config startup-config**

## 6.2.2 Configuring the PoE Parameters Using the Profile

Follow these steps to configure the PoE profile:

**Step 1      configure**

Enter global configuration mode.

**Step 2      power inline consumption power-limit**

Specify the maximum power the PoE switch can supply globally.

*power-limit*: Specify the maximum power the PoE switch can supply.

For T1500-28PCT, the valid value ranges from 1 to 192 W. By default, the value is 192.

For TL-SG2210MP, the valid value ranges from 1 to 150 W. By default, the value is 150.

For TL-SG2210P, the valid value ranges from 1 to 58 W. By default, the value is 58.

**Step 3      power profile name [ supply { enable | disable } [ priority { low | middle | high } [ consumption { power-limit | auto | class1 | class2 | class3 | class4 } ] ] ]**

Create a PoE profile for the switch. In a profile, the PoE status, PoE priority and power limit are configured. You can bind a profile to the corresponding port to quickly configure the PoE function.

*name*: Specify a name for the PoE profile. It ranges from 1 to 16 characters. If the name contains spaces, enclose the name in double quotes.

*enable | disable*: Specify the PoE status for the profile. By default, it is enable.

*low | middle | high*: Select the priority level for the profile. When the supply power exceeds the system power limit, the switch will power off PDs on low-priority ports to ensure stable running of other PDs.

*power-limit | auto | class1 | class2 | class3 | class4*: Select or enter the maximum power the corresponding port can supply. The following options are provided: Auto represents that the switch will assign a value of maximum power automatically. Class1 represents 4 W, Class2 represents 7 W, Class3 represents 15.4 W and Class4 represents 30 W or you can enter a value manually. The value ranges from 1 to 300. It is in the unit of 0.1 watt. For instance, if you want to configure the maximum power as 5 W, you should enter 50.

|         |  |
|---------|--|
| Step 4  | <p><b>interface { fastEthernet port   range fastEthernet port-list   gigabitEthernet port   range gigabitEthernet port-list   ten-gigabitEthernet port   range ten-gigabitEthernet port-list }</b></p> <p>Enter Interface Configuration mode.</p> <p><i>port</i>: Specify the Ethernet port number, for example 1/0/1.</p> <p><i>port-list</i>: Specify the list of Ethernet ports, for example 1/0/1-3, 1/0/5.</p>    |
| Step 5  | <p><b>power inline profile name</b></p> <p>Bind a PoE profile to the desired port. If one profile is selected, you will not be able to modify PoE status, PoE priority or power limit manually.</p> <p><i>name</i>: Specify the name of the PoE profile. If the name contains spaces, enclose the name in double quotes.</p>   |
| Step 6  | <p><b>time-range name</b></p> <p>Specify a time range for the port. Then the port will supply power only during the time range. For how to create a time range, refer to <a href="#">Time Range Configuration</a>.</p> <p><i>name</i>: Specify the name of the time range.</p>   |
| Step 7  | <p><b>show power profile</b></p> <p>Verify the defined PoE profile.</p>  |
| Step 8  | <p><b>show power inline configuration interface [ fastEthernet { port   port-list }   gigabitEthernet { port   port-list }   ten-gigabitEthernet { port   port-list } ]</b></p> <p>Verify the PoE configuration of the corresponding port.</p> <p><i>port</i>: Specify the Ethernet port number, for example 1/0/1.</p> <p><i>port-list</i>: Specify the list of Ethernet ports, in the format of 1/0/1-3, 1/0/5.</p>  |
| Step 9  | <p><b>show power inline information interface [ fastEthernet { port   port-list }   gigabitEthernet { port   port-list }   ten-gigabitEthernet { port   port-list } ]</b></p> <p>Verify the real-time PoE status of the corresponding port.</p> <p><i>port</i>: Specify the Ethernet port number, for example 1/0/1.</p> <p><i>port-list</i>: Specify the list of Ethernet ports, in the format of 1/0/1-3, 1/0/5.</p> |
| Step 10 | <p><b>end</b></p> <p>Return to privileged EXEC mode.</p>   |
| Step 11 | <p><b>copy running-config startup-config</b></p> <p>Save the settings in the configuration file.</p>   |

The following example shows how to create a profile named profile1 and bind the profile to the port 1/0/6.

**Switch#configure**

**Switch(config)#power profile profile1 supply enable priority middle consumption class2**

**Switch(config)#show power profile**

| Index | Name     | Status | Priority | Power-Limit(w) |
|-------|----------|--------|----------|----------------|
| 1     | profile1 | Enable | Middle   | Class2         |

**Switch(config)#interface gigabitEthernet 1/0/6**

**Switch(config-if)#power inline profile profile1**

**Switch(config-if)#show power inline configuration interface gigabitEthernet 1/0/6**

| Interface | PoE-Status | PoE-Prio | Power-Limit(w) | Time-Range | PoE-Profile |
|-----------|------------|----------|----------------|------------|-------------|
| Gi1/0/6   | Enable     | Middle   | Class2         | No Limit   | profile1    |

**Switch(config-if)#end**

**Switch#copy running-config startup-config**

# 7 SDM Template Configuration

## 7.1 Using the GUI

Choose the menu **SYSTEM > SDM Template** to load the following page.

Figure 7-1 Configuring SDM Template

**SDM Template Config**

---

Current Template: Default

Next Template: Default

Select Next Template:  ▼

[Apply](#)

---

**SDM Template Table**

| SDM Template | IP ACL Rules | MAC ACL Rules | Combined ACL Rules | IPv6 ACL Rules | IPv4 Source Guard Entries | IPv6 Source Guard Entries |
|--------------|--------------|---------------|--------------------|----------------|---------------------------|---------------------------|
| Default      | 100          | 80            | 50                 | 0              | 253                       | 0                         |
| EnterpriseV4 | 120          | 84            | 50                 | 0              | 253                       | 0                         |
| EnterpriseV6 | 32           | 32            | 0                  | 120            | 0                         | 183                       |
| Total: 3     |              |               |                    |                |                           |                           |

In **SDM Template Config** section, select one template and click **Apply**. The setting will be effective after the switch is rebooted.

|                             |  |
|-----------------------------|--|
| <b>Current Template</b>     | Displays the template currently in effect.   |
| <b>Next Template</b>        | Displays the template that will be effective after the reboot.   |
| <b>Select Next Template</b> | Select the template that will be effective after the next reboot.<br><br><b>Default:</b> Select the template of default. It gives balance to the IP ACL rules and MAC ACL rules.<br><br><b>EnterpriseV4:</b> Select the template of enterpriseV4. It maximizes system resources for IP ACL rules and MAC ACL rules.<br><br><b>EnterpriseV6:</b> Select the template of enterpriseV6. It allocates resources to IPv6 ACL rules. |

The Template Table displays the resources allocation of each template.

|                     |  |
|---------------------|--|
| <b>SDM Template</b> | Displays the name of the templates.  |
| <b>IP ACL Rules</b> | Displays the number of IP ACL Rules including Layer 3 ACL Rules and Layer 4 ACL Rules. |

|                           |   |
|---------------------------|---|
| MAC ACL Rules             | Displays the number of Layer 2 ACL Rules.         |
| Combined ACL Rules        | Displays the number of combined ACL rules.        |
| IPv6 ACL Rules            | Displays the number of IPv6 ACL rules.            |
| IPv4 Source Guard Entries | Displays the number of IPv4 source guard entries. |
| IPv6 Source Guard Entries | Displays the number of IPv6 source guard entries. |

## 7.2 Using the CLI

Follow these steps to configure the SDM template:

|        |  |
|--------|--|
| Step 1 | <b>configure</b><br>Enter global configuration mode.   |
| Step 2 | <b>show sdm prefer { used   default   enterpriseV4   enterpriseV6 }</b><br>View the template table. It will help you determine which template is suitable for your network.<br><br><b>used:</b> Displays the resource allocation of the current template.<br><br><b>default:</b> Displays the resource allocation of the default template.<br><br><b>enterpriseV4:</b> Displays the resource allocation of the enterpriseV4 template.<br><br><b>enterpriseV6:</b> Displays the resource allocation of the enterpriseV6 template. |
| Step 3 | <b>sdm prefer { default   enterpriseV4   enterpriseV6 }</b><br>Select the template that will be effective after the switch is rebooted.<br><br><b>default:</b> Select the template of default. It gives balance to the IP ACL rules and MAC ACL rules.<br><br><b>enterpriseV4:</b> Select the template of enterpriseV4. It maximizes system resources for IP ACL rules and MAC ACL rules.<br><br><b>enterpriseV6:</b> Select the template of enterpriseV4. It allocates resources to IPv6 ACL rules.                             |
| Step 4 | <b>end</b><br>Return to privileged EXEC mode.  |
| Step 5 | <b>copy running-config startup-config</b><br>Save the settings in the configuration file.  |

The following example shows how to set the SDM template as enterpriseV4.

**Switch#config**

**Switch(config)#show sdm prefer enterpriseV4**

"enterpriseV4" template:

number of IP ACL Rules : 120

number of MAC ACL Rules : 84

number of Combined ACL Rules : 50

number of IPV6 ACL Rules : 0

number of IPV4 Source Guard Entries : 253

number of IPV6 Source Guard Entries : 0

**Switch(config)#sdm prefer enterpriseV4**

Switch to "enterpriseV4" template.

Changes to the running SDM preferences have been stored, but cannot take effect until reboot the switch.

**Switch(config)#end**

**Switch#copy running-config startup-config**



# 8 Time Range Configuration

To complete Time Range configuration, follow these steps:

- 1) Add time range entries.
- 2) Configure Holiday time range.

## 8.1 Using the GUI

### 8.1.1 Adding Time Range Entries

Choose the menu **SYSTEM > Time Range > Time Range Config** and click  Add to load the following page.

Figure 8-1 Configuring Time Range

Time-Range Config



---

Name:  (1-16 characters)

Holiday:  Exclude  Include

---

Period Time Config

 Add  Delete

| <input type="checkbox"/>  | Index | Date | Day | Time | Operation |
|---------------------------|-------|------|-----|------|-----------|
| No entries in this table. |       |      |     |      |           |

Total: 0

Discard
Create

Follow these steps to add time range entries:

- 1) In the **Time-Range Config** section, specify a name for the entry and select the Holiday mode.

|                |   |
|----------------|---|
| <b>Name</b>    | Specify a name for the entry.   |
| <b>Holiday</b> | Select to include or exclude the holiday in the time range.<br><br><b>Exclude:</b> The time range will not take effect on holiday.<br><br><b>Include:</b> The time range will not be affected by holiday.<br><br>To configure Holiday, refer to <a href="#">Configuring Holiday</a> . |

2) In the **Period Time Config** section, click  **Add** and the following window will pop up.

Figure 8-2 Adding Period Time

**Period Time Config**

---

**Date**

From      Month:       Day:       Year:

To          Month:       Day:       Year:

---

**Time**

From:  (Format: HH:MM)

To:  (Format: HH:MM)

---

**Day of Week**

Mon     Tue     Wed     Thu     Fri     Sat     Sun

Configure the following parameters and click **Create**:

|                    |   |
|--------------------|---|
| <b>Date</b>        | Specify the start date and end date of this time range. |
| <b>Time</b>        | Specify the start time and end time of a day.           |
| <b>Day of Week</b> | Select days of a week as the period of this time range. |

3) Similarly, you can add more entries of period time according to your needs. The final period time is the sum of all the periods in the table. Click **Create**.

Figure 8-3 View Configuration Result

**Time-Range Config**

---

Name:  (1-16 characters)

Holiday:  Exclude  Include

---

**Period Time Config**

+ Add - Delete

| <input type="checkbox"/> | Index | Date                               | Day                     | Time          | Operation   |
|--------------------------|-------|------------------------------------|-------------------------|---------------|---|
| <input type="checkbox"/> | 1     | January 1, 2017 - November 1, 2017 | Mon, Tue, Wed, Thu, Fri | 08:00 - 20:00 | <input type="checkbox"/> <input type="checkbox"/> |
| Total: 1                 |       |                                    |                         |               |   |

Discard
Create

### 8.1.2 Configuring Holiday

Choose the menu **SYSTEM > Time Range > Holiday Config** and click + Add to load the following page.

Figure 8-4 Configuring Holiday

**Holiday Config**

---

Holiday Name:  (1-31 characters)

Start Date

Month:  Day:

End Date

Month:  Day:

Cancel
Create

Configure the following parameters and click **Create** to add a Holiday entry.

|                     |   |
|---------------------|---|
| <b>Holiday Name</b> | Specify a name for the entry.                     |
| <b>Start Date</b>   | Specify the start date of the Holiday time range. |
| <b>End Date</b>     | Specify the end date of the Holiday time range.   |

Similarly, you can add more Holiday entries. The final Holiday time range is the sum of all the entries.

## 8.2 Using the CLI

### 8.2.1 Adding Time Range Entries

Follow these steps to add time range entries:

---

|        |  |
|--------|--|
| Step 1 | <b>configure</b><br>Enter global configuration mode.   |
| Step 2 | <b>time-range name</b><br>Create a time-range entry.<br><br><i>name</i> : Specify a name for the entry.  |
| Step 3 | <b>holiday { exclude   include }</b><br>Include or exclude the holiday in the time range.<br><br><i>exclude</i> : The time range will not take effect on holiday.<br><br><i>include</i> : The time range will not be affected by holiday.<br><br>To configure Holiday, refer to <a href="#">Configuring Holiday</a> .  |
| Step 4 | <b>absolute from start-date to end-date</b><br>Specify the start date and end date of this time range.<br><br><i>start-date</i> : Specify the start date in the format MM/DD/YYYY.<br><br><i>end-date</i> : Specify the end date in the format MM/DD/YYYY.   |
| Step 5 | <b>periodic { [start start-time ] [ end end-time ] [day-of-the-week week-day ] }</b><br>Specify days of a week as the period of this time range.<br><br><i>start-time</i> : Specify the start end time of a day in the format HH:MM.<br><br><i>end-time</i> : Specify the end time and end time of a day in the format HH:MM.<br><br><i>week-day</i> : Specify the days of week in the format of 1-3, 7. The numbers 1-7 respectively represent Monday, Tuesday, Wednesday, Thursday, Friday, Saturday and Sunday. |
| Step 6 | <b>show time-range</b><br>View the configuration of Time Range.  |
| Step 7 | <b>end</b><br>Return to privileged EXEC mode.  |
| Step 8 | <b>copy running-config startup-config</b><br>Save the settings in the configuration file.  |

---

The following example shows how to create a time range entry and set the name as time1, holiday mode as exclude, absolute time as 10/01/2017 to 10/31/2017 and periodic time as 8:00 to 20:00 on every Monday and Tuesday:

**Switch#config**

**Switch(config)#time-range** time1

**Switch(config-time-range)#holiday** exclude

**Switch(config-time-range)#absolute** from 10/01/2017 to 10/31/2017

**Switch(config-time-range)#periodic** start 08:00 end 20:00 **day-of-the-week** 1,2

**Switch(config-time-range)#show** time-range

Time-range entry: 12 (Inactive)

Time-range entry: time1 (Inactive)

holiday: exclude

number of time slice: 1

01 - 10/01/2017 to 10/31/2017

- 08:00 to 20:00 on 1,2

**Switch(config-time-range)#end**

**Switch#copy** running-config startup-config

## 8.2.2 Configuring Holiday

Follow these steps to configure Holiday time range:

- 
- |        |   |
|--------|---|
| Step 1 | <p><b>configure</b></p> <p>Enter global configuration mode.</p> |
|--------|---|
- 
- |        |   |
|--------|---|
| Step 2 | <p><b>holiday</b> <i>name</i> <b>start-date</b> <i>start-date</i> <b>end-date</b> <i>end-date</i></p> <p>Create a holiday entry.</p> <p><i>name</i>: Specify a name for the entry.</p> <p><i>start-date</i> : Specify the start date in the format MM/DD.</p> <p><i>end-date</i>: Specify the end date in the format MM/DD.</p> |
|--------|---|
- 
- |        |  |
|--------|--|
| Step 3 | <p><b>show holiday</b></p> <p>View the configuration of Holiday.</p> |
|--------|--|
- 
- |        |  |
|--------|--|
| Step 4 | <p><b>end</b></p> <p>Return to privileged EXEC mode.</p> |
|--------|--|
-

---

**Step 8** **copy running-config startup-config**

Save the settings in the configuration file.

---

The following example shows how to create a holiday entry and set the entry name as holiday1 and set start date and end date as 07/01 and 09/01:

**Switch#config****Switch(config)#holiday** holiday1 **start-date** 07/01 **end-date** 09/01**Switch(config)#show holiday**

| Index | Holiday Name | Start-End   |
|-------|--------------|-------------|
| ----- | -----        | -----       |
| 1     | holiday1     | 07.01-09.01 |

**Switch(config)#end****Switch#copy running-config startup-config**

# 9 Example for PoE Configurations

## 9.1 Network Requirements

The network topology of a company is shown as below. Camera1 and Camera2 work for the security of the company and cannot be power off all the time. AP1 and AP2 provide the internet service and only work in the office time.

Figure 9-1 Network Topology

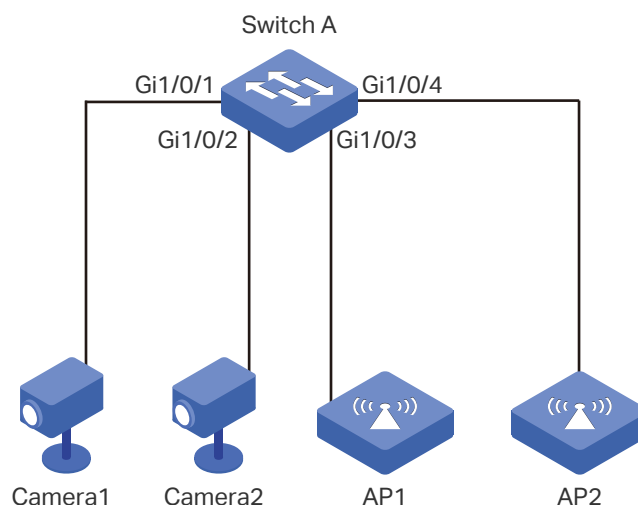

## 9.2 Configuring Scheme

To implement this requirement, you can set a PoE time-range as the office time, for example, from 08:30 to 18:00 on work days. Then apply the settings to port 1/0/3 and 1/0/4. Port 1/0/1 and port 1/0/2 need to supply power all the time, so the time range configurations can be left as the default settings here.

## 9.3 Using the GUI

The configurations of port 1/0/4 is similar with the configurations of port 1/0/3. Here we take port 1/0/3 for example.

- 1) Choose the menu **SYSTEM > Time Range > Time Range Create** and click  Add to load the following page.

Figure 9-2 Creating Time Range

**Time-Range Config**

---

Name:  (1-16 characters)

Holiday:  Exclude  Include

**Period Time Config**

+ Add - Delete

| <input type="checkbox"/>  | Index | Date | Day | Time | Operation |
|---------------------------|-------|------|-----|------|-----------|
| No entries in this table. |       |      |     |      |           |
| Total: 0                  |       |      |     |      |           |

Discard
Create

- 2) Click + **Add** and the following window will pop up. Set **Date**, **Time** and **Day** of Week as the following figure shows. Click **Create**.

Figure 9-3 Creating a Periodic Time

**Period Time Config**

---

**Date**

From: 
 Month:  Day:  Year:

To: 
 Month:  Day:  Year:

**Time**

From: 08:30 (Format: HH:MM)

To: 18:00 (Format: HH:MM)

**Day of Week**

Mon
  Tue
  Wed
  Thu
  Fri
  Sat
  Sun

Cancel
Create



- Specify a name for the time range. Click **Create**.

Figure 9-4 Configuring Time Range

**Time-Range Config**

Name:  (1-16 characters)

Holiday:  Exclude  Include

---

**Period Time Config**

+ Add - Delete

| <input type="checkbox"/> | Index | Date                              | Day                     | Time          | Operation |
|--------------------------|-------|-----------------------------------|-------------------------|---------------|-----------|
| <input type="checkbox"/> | 0     | January 1, 2017 - January 1, 2018 | Mon, Tue, Wed, Thu, Fri | 08:30 - 18:00 |           |
| Total: 0                 |       |                                   |                         |               |           |

- Choose the menu **SYSTEM > PoE > PoE Config** to load the following page. Select port 1/0/3 and set the **Time Range** as OfficeTime. Click **Apply**.

Figure 9-5 Configure the Port

**PoE Config**

| Unit     | System Power Limit (W) | System Power Consumption (W) | System Power Remain (W) | Operation |
|----------|------------------------|------------------------------|-------------------------|-----------|
| Unit1    | 192.0                  | 0.0                          | 192.0                   |           |
| Total: 1 |                        |                              |                         |           |

---

**Port Config**

UNIT1

| <input type="checkbox"/>            | Port | PoE Status | PoE Priority | Power Limit | Power Limit Value (0.1-30.0 W) | Time Range | PoE Profile | Power (W) | Current |
|-------------------------------------|------|------------|--------------|-------------|--------------------------------|------------|-------------|-----------|---------|
| <input type="checkbox"/>            | 1    | Enabled    | Low          | Class4      | 30                             | No Limit   | None        | 0         |         |
| <input type="checkbox"/>            | 2    | Enabled    | Low          | Class4      | 30                             | No Limit   | None        | 0         |         |
| <input checked="" type="checkbox"/> | 3    | Enabled    | Low          | Class4      | 30                             | OfficeTime | None        | 0         |         |
| <input type="checkbox"/>            | 4    | Enabled    | Low          | Class4      | 30                             | No Limit   | None        | 0         |         |
| <input type="checkbox"/>            | 5    | Enabled    | Low          | Class4      | 30                             | No Limit   | None        | 0         |         |
| <input type="checkbox"/>            | 6    | Enabled    | Low          | Class4      | 30                             | No Limit   | None        | 0         |         |
| <input type="checkbox"/>            | 7    | Enabled    | Low          | Class4      | 30                             | No Limit   | None        | 0         |         |
| <input type="checkbox"/>            | 8    | Enabled    | Low          | Class4      | 30                             | No Limit   | None        | 0         |         |
| <input type="checkbox"/>            | 9    | Enabled    | Low          | Class4      | 30                             | No Limit   | None        | 0         |         |
| <input type="checkbox"/>            | 10   | Enabled    | Low          | Class4      | 30                             | No Limit   | None        | 0         |         |

Total: 24 1 entry selected.

- Click Save to save the settings.

## 9.4 Using the CLI

The configurations of Port1/0/4 is similar with the configuration of port 1/0/3. Here we take port 1/0/3 for example.

- 1) Create a time-range.

```
Switch_A#config
```

```
Switch_A(config)#time-range office-time
```

```
Switch_A(config-time-range)#holiday exclude
```

```
Switch_A(config-time-range)#absolute from 01/01/2017 to 01/01/2018
```

```
Switch_A(config-time-range)#periodic start 08:30 end 18:00 day-of-the-week 1-5
```

```
Switch_A(config-time-range)#exit
```

- 2) Enable the PoE function on the port 1/0/3. Specify the basic parameters for the port 1/0/3 and bind the time-range office-time to the port.

```
Switch_A(config)#interface gigabitEthernet 1/0/3
```

```
Switch_A(config-if)#power inline supply enable
```

```
Switch_A(config-if)#power inline time-range office-time
```

```
Switch_A(config-if)#end
```

```
Switch_A#copy running-config startup-config
```

### Verify the Configuration

Verify the configuration of the time-range:

```
Switch_A#show time-range
```

```
Time-range entry: office-time (Active)
```

```
holiday: exclude
```

```
number of time slice: 1
```

```
01 - 01/01/2017 to 01/01/2018
```

```
- 08:00 to 18:00 on 1,2,3,4,5
```

Verify the configuration of the PoE basic parameters:

```
Switch_A#show power inline configuration interface gigabitEthernet 1/0/3
```

```
-----  -----  -----  -----  -----  -----
Gi1/0/3  Enable    Low     Class4   office-time  None
```

# 10 Appendix: Default Parameters

Default settings of System Info are listed in the following tables.

Table 10-1 Default Settings of Device Description Configuration

| Parameter       | Default Setting               |
|-----------------|-------------------------------|
| Device Name     | The model name of the switch. |
| Device Location | SHENZHEN                      |
| System Contact  | www.tp-link.com               |

Table 10-2 Default Settings of System Time Configuration

| Parameter   | Default Setting |
|-------------|-----------------|
| Time Source | Manual          |

Table 10-3 Default Settings of Daylight Saving Time Configuration

| Parameter  | Default Setting |
|------------|-----------------|
| DST status | Disabled        |

Default settings of User Management are listed in the following table.

Table 10-4 Default Settings of User Configuration

| Parameter    | Default Setting |
|--------------|-----------------|
| User Name    | admin           |
| Password     | admin           |
| Access Level | Admin           |

Default settings of System Tools are listed in the following table.

Table 10-5 Default Settings of Boot Configuration

| Parameter              | Default Setting |
|------------------------|-----------------|
| Current Startup Image  | image1.bin      |
| Next Startup Image     | image1.bin      |
| Backup Image           | image2.bin      |
| Current Startup Config | config1.cfg     |
| Next Startup Config    | config1.cfg     |

| Parameter     | Default Setting |
|---------------|-----------------|
| Backup Config | config2.cfg     |

Default setting of EEE is listed in the following table.

Table 10-6 Default Settings of EEE Configuration

| Parameter | Default Setting |
|-----------|-----------------|
| Status    | Disabled        |

(For T1500-28PCT / TL-SG2210MP / TL-SG2210P) Default settings of PoE is listed in the following table.

Table 10-7 Default Settings of PoE Configuration

| Parameter                  | Default Setting   |
|----------------------------|---|
| PoE Config                 |   |
| System Power Limit         | 192.0 W (For T1500-28PCT)<br>150.0 W (For TL-SG2210MP)<br>58.0 W (For TL-SG2210P) |
| Port Config                |   |
| PoE Status                 | Enabled   |
| PoE Priority               | Low   |
| Power Limit (0.1 W-30.0 W) | Class 4   |
| Time Range                 | No Limit  |
| PoE Profile                | None  |
| Profile Config             |   |
| Profile Name               | None  |
| PoE Status                 | Enabled   |
| PoE Priority               | Low   |
| Power Limit                | Auto  |

Default settings of SDM Template are listed in the following table.

Table 10-8 Default Settings of SDM Template Configuration

| Parameter           | Default Setting |
|---------------------|-----------------|
| Current Template ID | Default         |
| Next Template ID    | Default         |

Default settings of Time Range are listed in the following table.

Table 10-9 Default Settings of Time Range Configuration

| Parameter | Default Setting |
|-----------|-----------------|
| Holiday   | Include         |

# Part 3

## Managing Physical Interfaces

### CHAPTERS

1. Physical Interface
2. Basic Parameters Configurations
3. Port Isolation Configurations
4. Loopback Detection Configuration
5. Configuration Examples
6. Appendix: Default Parameters

# 1 Physical Interface

## 1.1 Overview

Interfaces are used to exchange data and interact with interfaces of other network devices. Interfaces are classified into physical interfaces and layer 3 interfaces.

- Physical interfaces are the ports on the switch panel. They forward packets based on MAC address table.
- Layer 3 interfaces are used to forward IPv4 and IPv6 packets using static or dynamic routing protocols. You can use Layer 3 interfaces for IP routing and inter-VLAN routing.

This chapter introduces the configurations for physical interfaces.

## 1.2 Supported Features

The switch supports the following features about physical interfaces:

### Basic Parameters

You can configure port status, speed mode, duplex mode, flow control and other basic parameters for ports.

### Port Isolation

You can use this feature to restrict a specific port to send packets to only the ports in the forwarding port list that you configure.

### Loopback Detection

This function allows the switch to detect loops in the network. When a loop is detected on a port or VLAN, the switch will display an alert on the management interface and block the corresponding port or VLAN according to your configurations.

# 2 Basic Parameters Configurations

## 2.1 Using the GUI

Choose the menu **L2 FEATURES > Switching > Port > Port Config** to load the following page.

Figure 2-1 Configuring Basic Parameters

The screenshot shows the 'Port Config' interface. At the top, there is a 'Jumbo' configuration field with a text input containing '1518' and a label 'bytes (1518-9216)'. To the right of this field is a blue 'Apply' button. Below this is a tabbed interface with 'UNIT1' selected and 'LAGS' as an alternative. Underneath is a table with columns: Port, Type, Description, Status, Speed, Duplex, Flow Control, and LAG. The first row (1/0/1) is selected with a checkmark. The table lists ports 1/0/1 through 1/0/10, all of type 'Copper' and status 'Enabled'. At the bottom of the table, it says 'Total: 28' and '1 entry selected.' There are 'Cancel' and 'Apply' buttons at the bottom right.

| Port                                      | Type   | Description | Status  | Speed | Duplex | Flow Control | LAG |
|---|--------|-------------|---------|-------|--------|--------------|-----|
| <input checked="" type="checkbox"/> 1/0/1 | Copper |             | Enabled | Auto  | Auto   | Disabled     | --  |
| <input type="checkbox"/> 1/0/2            | Copper |             | Enabled | Auto  | Auto   | Disabled     | --  |
| <input type="checkbox"/> 1/0/3            | Copper |             | Enabled | Auto  | Auto   | Disabled     | --  |
| <input type="checkbox"/> 1/0/4            | Copper |             | Enabled | Auto  | Auto   | Disabled     | --  |
| <input type="checkbox"/> 1/0/5            | Copper |             | Enabled | Auto  | Auto   | Disabled     | --  |
| <input type="checkbox"/> 1/0/6            | Copper |             | Enabled | Auto  | Auto   | Disabled     | --  |
| <input type="checkbox"/> 1/0/7            | Copper |             | Enabled | Auto  | Auto   | Disabled     | --  |
| <input type="checkbox"/> 1/0/8            | Copper |             | Enabled | Auto  | Auto   | Disabled     | --  |
| <input type="checkbox"/> 1/0/9            | Copper |             | Enabled | Auto  | Auto   | Disabled     | --  |
| <input type="checkbox"/> 1/0/10           | Copper |             | Enabled | Auto  | Auto   | Disabled     | --  |

Follow these steps to configure basic parameters for the ports:

- 1) Configure the MTU size of jumbo frames for all ports, then click **Apply**.

### Jumbo

Configure the size of jumbo frames. By default, it is 1518 bytes.

Generally, the MTU (Maximum Transmission Unit) size of a normal frame is 1518 bytes. If you want the switch supports to transmit frames of which the MTU size is greater than 1518 bytes, you can configure the MTU size manually here.

- 2) Select one or more ports to configure the basic parameters. Then click **Apply**.

### UNIT/LAGS

Click the **UNIT** number to configure physical ports. Click **LAGS** to configure LAGs.

### Type

Displays the port type. **Copper** indicates an Ethernet port, and **Fiber** indicates an SFP port.



|              |   |
|--------------|---|
| Description  | (Optional) Enter a description for the port.  |
| Status       | With this option enabled, the port forwards packets normally. Otherwise, the port cannot work. By default, it is enabled.   |
| Speed        | Select the appropriate speed mode for the port. When <b>Auto</b> is selected, the port automatically negotiates speed mode with the neighbor device. The default setting is <b>Auto</b> . It is recommended to select <b>Auto</b> if both ends of the link support auto-negotiation.  |
| Duplex       | Select the appropriate duplex mode for the port. There are three options: <b>Half</b> , <b>Full</b> and <b>Auto</b> . The default setting is <b>Auto</b> .<br><br><b>Half:</b> The port can send and receive packets, but only one-way at a time.<br><br><b>Full:</b> The port can send and receive packets simultaneously.<br><br><b>Auto:</b> The port automatically negotiates duplex mode with the peer device. |
| Flow Control | With this option enabled, when the switch gets overloaded it will send a PAUSE frame to notify the peer device to stop sending data for a specified period of time, thus avoiding the packet loss caused by congestion. By default, it is disabled.   |

 **Note:**

We recommend that you set the ports on both ends of a link as the same speed and duplex mode.

## 2.2 Using the CLI

Follow these steps to set basic parameters for the ports.

|        |   |
|--------|---|
| Step 1 | <b>configure</b><br>Enter global configuration mode.  |
| Step 2 | <b>jumbo-size size</b><br><br>Change the MTU (Maximum Transmission Unit) size to support jumbo frames. The default MTU size for frames received and sent on all ports is 1518 bytes. To transmit jumbo frames, you can manually configure MTU size of frames up to 9216 bytes.<br><br><b>size:</b> Configure the MTU size of jumbo frames. The value ranges from 1518 to 9216bytes. |
| Step 3 | <b>interface { fastEthernet port   range fastEthernet port-list   gigabitEthernet port   range gigabitEthernet port-list   ten-gigabitEthernet port   ten-range gigabitEthernet port-list   port-channel port-channel   range port-channel port-channel-list }</b><br>Enter interface configuration mode.   |

|        |   |
|--------|---|
| Step 4 | <p>Configure basic parameters for the port:</p> <p><b>description</b> <i>string</i></p> <p>Give a port description for identification.</p> <p><i>string</i>: Content of a port description, ranging from 1 to 16 characters.</p> <p><b>shutdown</b><br/><b>no shutdown</b></p> <p>Use <b>shutdown</b> to disable the port, and use <b>no shutdown</b> to enable the port. When the status is enabled, the port can forward packets normally, otherwise it will discard the received packets. By default, all ports are enabled.</p> <p><b>speed</b> { 10   100   1000   10000   auto }</p> <p>Set the appropriate speed mode for the port.</p> <p>10   100   1000   10000   auto: Speed mode of the port. The options are subject to your actual product. The device connected to the port should be in the same speed and duplex mode with the port. When auto is selected, the speed mode will be determined by auto-negotiation.</p> <p><b>duplex</b> { auto   full   half }</p> <p>Set the appropriate duplex mode for the port.</p> <p>auto   full   half: Duplex mode of the port. The device connected to the port should be in the same speed and duplex mode with the port. When auto is selected, the duplex mode will be determined by auto-negotiation.</p> <p><b>flow-control</b></p> <p>Enable the switch to synchronize the data transmission speed with the peer device, avoiding the packet loss caused by congestion. By default, it is disabled.</p> |
| Step 5 | <p><b>show interface configuration</b> [ <i>fastEthernet port</i>   <i>gigabitEthernet port</i>     <i>ten-gigabitEthernet port</i>   <i>port-channel port-channel-id</i> ]</p> <p>Verify the configuration of the port or LAG.</p>   |
| Step 6 | <p><b>end</b></p> <p>Return to privileged EXEC mode.</p>  |
| Step 7 | <p><b>copy running-config startup-config</b></p> <p>Save the settings in the configuration file.</p>  |

The following example shows how to implement the basic configurations of port1/0/1, including setting a description for the port, configuring the jumbo frame, making the port automatically negotiate speed and duplex with the neighboring port, and enabling the flow-control:

**Switch#configure**

**Switch#jumbo-size** 9216

**Switch(config)#interface** gigabitEthernet 1/0/1

**Switch(config-if)#no shutdown**

```
Switch(config-if)#description router connection
```

```
Switch(config-if)#speed auto
```

```
Switch(config-if)#duplex auto
```

```
Switch(config-if)#flow-control
```

```
Switch(config-if)#show interface configuration gigabitEthernet 1/0/1
```

| Port    | State  | Speed | Duplex | FlowCtrl | Description       |
|---------|--------|-------|--------|----------|-------------------|
| -----   | -----  | ----- | -----  | -----    | -----             |
| Gi1/0/1 | Enable | Auto  | Auto   | Enable   | router connection |

```
Switch(config-if)#show jumbo-size
```

```
Global jumbo size : 9216
```

```
Switch(config-if)#end
```

```
Switch#copy running-config startup-config
```

# 3 Port Isolation Configurations

## 3.1 Using the GUI

Port Isolation is used to limit the data transmitted by a port. The isolated port can only send packets to the ports specified in its Forwarding Port List.

Choose the menu **L2 FEATURES > Switching > Port > Port Isolation** to load the following page.

Figure 3-1 Port Isolation List

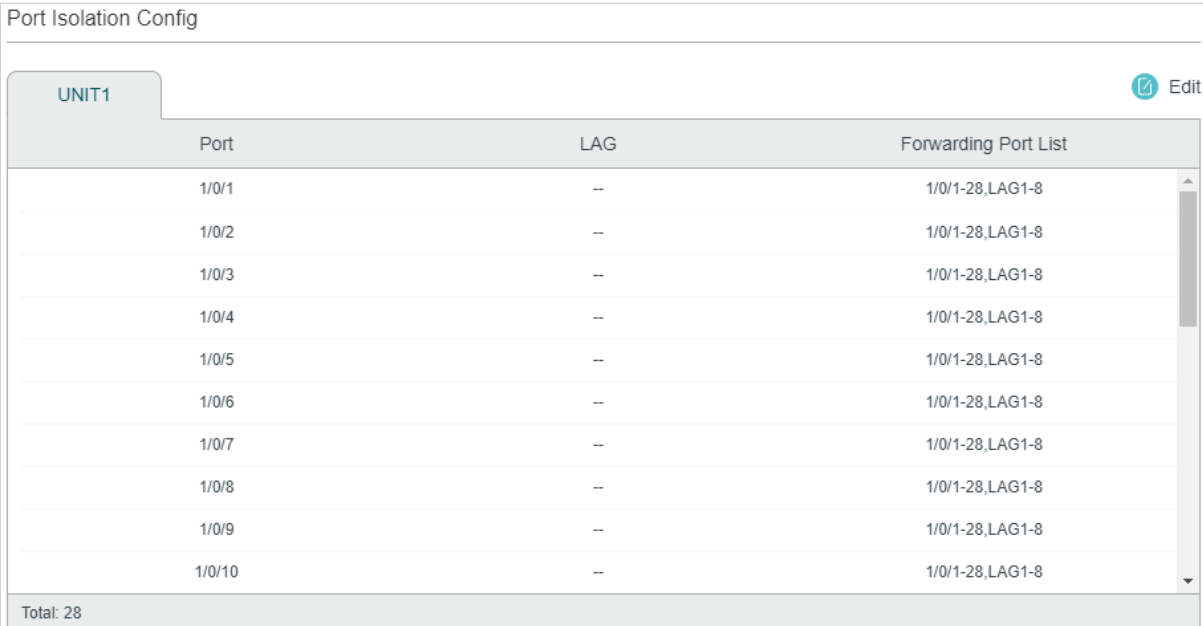

The screenshot shows the 'Port Isolation Config' page for 'UNIT1'. It features a table with columns for 'Port', 'LAG', and 'Forwarding Port List'. The table lists ports 1/0/1 through 1/0/10, all with a LAG of '--' and a Forwarding Port List of '1/0/1-28,LAG1-8'. An 'Edit' button is visible in the top right corner. A 'Total: 28' indicator is at the bottom left of the table area.

| Port   | LAG | Forwarding Port List |
|--------|-----|----------------------|
| 1/0/1  | --  | 1/0/1-28,LAG1-8      |
| 1/0/2  | --  | 1/0/1-28,LAG1-8      |
| 1/0/3  | --  | 1/0/1-28,LAG1-8      |
| 1/0/4  | --  | 1/0/1-28,LAG1-8      |
| 1/0/5  | --  | 1/0/1-28,LAG1-8      |
| 1/0/6  | --  | 1/0/1-28,LAG1-8      |
| 1/0/7  | --  | 1/0/1-28,LAG1-8      |
| 1/0/8  | --  | 1/0/1-28,LAG1-8      |
| 1/0/9  | --  | 1/0/1-28,LAG1-8      |
| 1/0/10 | --  | 1/0/1-28,LAG1-8      |

The above page displays the port isolation list. Click  **Edit** to configure Port Isolation on the following page.

Figure 3-2 Port Isolation



Follow these steps to configure Port Isolation:

- 1) In the **Port** section, select one or multiple ports to be isolated.
- 2) In the **Forwarding Port List** section, select the forwarding ports or LAGs which the isolated ports can only communicate with. It is multi-optional.
- 3) Click **Apply**.

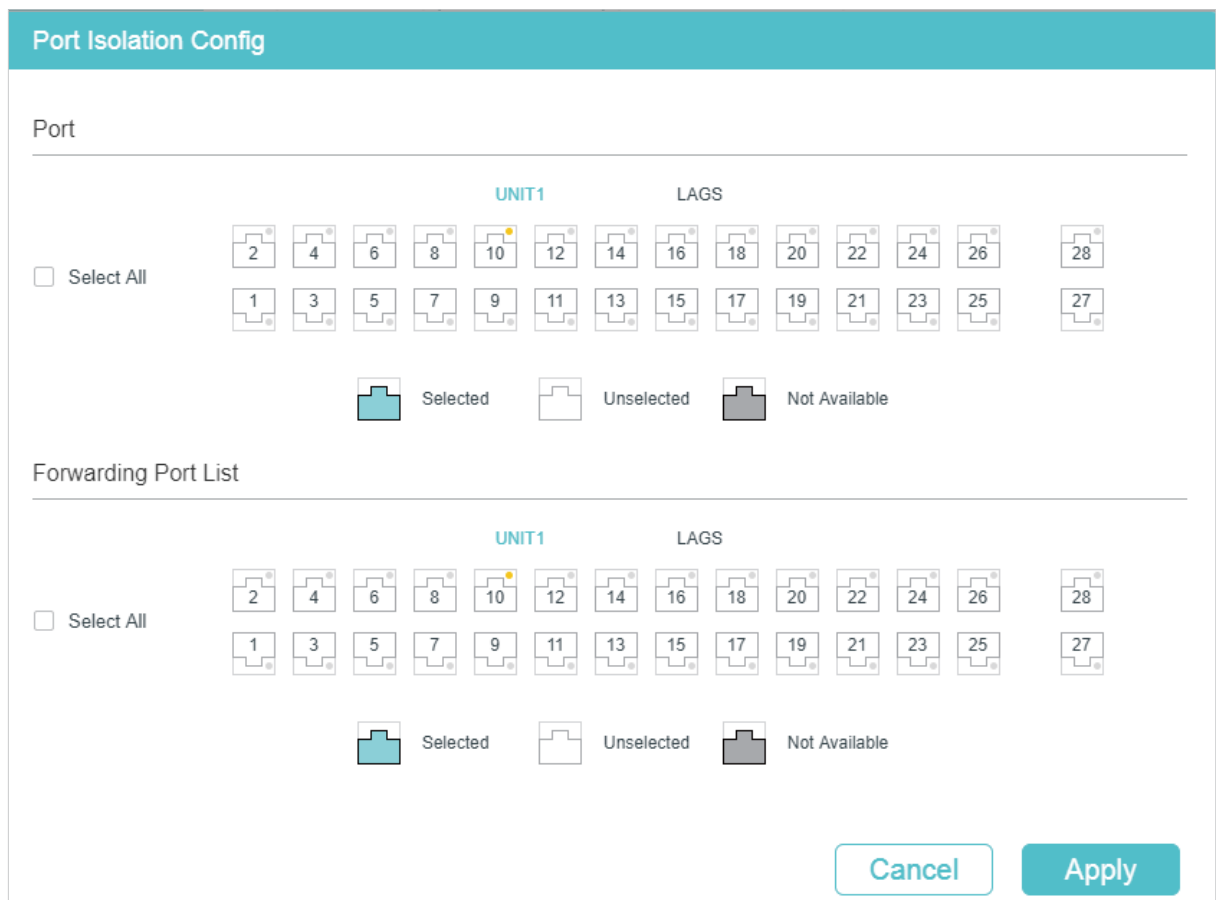
### 3.2 Using the CLI

Follow these steps to configure Port Isolation:

|        |   |
|--------|---|
| Step 1 | <p><b>configure</b><br/>Enter global configuration mode.</p>  |
| Step 2 | <p><b>interface { fastEthernet port   range fastEthernet port-list   gigabitEthernet port   range gigabitEthernet port-list   ten-gigabitEthernet port   ten-range gigabitEthernet port-list   port-channel port-channel   range port-channel port-channel-list }</b><br/>Specify the port to be isolated and enter interface configuration mode.</p> |

|        |  |
|--------|--|
| Step 3 | <p><b>port isolation { [fa-forward-list fa-forward-list] [gi-forward-list gi-forward-list] [te-forward-list te-forward-list] [po-forward-list po-forward-list ] }</b></p> <p>Add ports or LAGs to the forwarding port list of the isolated port. It is multi-optional.</p> <p><i>fa-forward-list / gi-forward-list / te-forward-list</i>: Specify the forwarding Ethernet ports.</p> <p><i>po-forward-list</i>: Specify the forwarding LAGs.</p> |
| Step 4 | <p><b>show port isolation interface { fastEthernet port   gigabitEthernet port   ten-gigabitEthernet port   port-channel port-channel }</b></p> <p>Verify the Port Isolation configuration of the specified port.</p>  |
| Step 5 | <p><b>end</b></p> <p>Return to privileged EXEC mode.</p>   |
| Step 6 | <p><b>copy running-config startup-config</b></p> <p>Save the settings in the configuration file.</p>   |

The following example shows how to add ports 1/0/1-3 and LAG 4 to the forwarding list of port 1/0/5:

**Switch#configure**

**Switch(config)#interface gigabitEthernet 1/0/5**

**Switch(config-if)#port isolation gi-forward-list 1/0/1-3 po-forward-list 4**

**Switch(config-if)#show port isolation interface gigabitEthernet 1/0/5**

| Port    | LAG | Forward-List  |
|---------|-----|---------------|
| ----    | --- | -----         |
| Gi1/0/5 | N/A | Gi1/0/1-3,Po4 |

**Switch(config-if)#end**

**Switch#copy running-config startup-config**

# 4 Loopback Detection Configuration

## 4.1 Using the GUI

To avoid broadcast storm, we recommend that you enable storm control before loopback detection is enabled. For detailed introductions about storm control, refer to [Configuring QoS](#).

Choose the menu **L2 FEATURES > Switching > Port > Loopback Detection** to load the following page.

Figure 4-1 Configuring Loopback Detection

**Loopback Detection**

Loopback Detection Status:  Enable

Detection Interval:  seconds (1-1000)

Auto-recovery Time:  seconds (2-100,000)

Web Refresh Status:  Enable

Web Refresh Interval:  seconds (3-100)

**Apply**

---

**Port Config**

UNIT1 | LAGS Recovery

| <input type="checkbox"/>            | Port   | Status   | Operation Mode | Recovery Mode | Loop Status | Block Status | Block VLAN | LAG |
|-------------------------------------|--------|----------|----------------|---------------|-------------|--------------|------------|-----|
| <input checked="" type="checkbox"/> | 1/0/1  | Disabled | Alert          | Auto          | --          | --           | --         | --  |
| <input type="checkbox"/>            | 1/0/2  | Disabled | Alert          | Auto          | --          | --           | --         | --  |
| <input type="checkbox"/>            | 1/0/3  | Disabled | Alert          | Auto          | --          | --           | --         | --  |
| <input type="checkbox"/>            | 1/0/4  | Disabled | Alert          | Auto          | --          | --           | --         | --  |
| <input type="checkbox"/>            | 1/0/5  | Disabled | Alert          | Auto          | --          | --           | --         | --  |
| <input type="checkbox"/>            | 1/0/6  | Disabled | Alert          | Auto          | --          | --           | --         | --  |
| <input type="checkbox"/>            | 1/0/7  | Disabled | Alert          | Auto          | --          | --           | --         | --  |
| <input type="checkbox"/>            | 1/0/8  | Disabled | Alert          | Auto          | --          | --           | --         | --  |
| <input type="checkbox"/>            | 1/0/9  | Disabled | Alert          | Auto          | --          | --           | --         | --  |
| <input type="checkbox"/>            | 1/0/10 | Disabled | Alert          | Auto          | --          | --           | --         | --  |

Total: 28 1 entry selected. **Cancel** **Apply**

Follow these steps to configure loopback detection:

- 1) In the **Loopback Detection** section, enable loopback detection and configure the global parameters. Then click **Apply**.

|                           |   |
|---------------------------|---|
| Loopback Detection Status | Enable loopback detection globally.   |
| Detection Interval        | Set the interval of sending loopback detection packets in seconds.<br>The valid value ranges from 1 to 1000 and the default value is 30.  |
| Auto-recovery Time        | Set the recovery time globally. The blocked port in Auto Recovery mode will automatically be recovered to normal status after the Auto-recovery Time expires. The value ranges from 2 to 100,000 in seconds, and the default value is 90. |
| Web Refresh Status        | With this option enabled, the switch will refresh the web timely. By default, it is disabled.   |
| Web Refresh Interval      | If you enabled web refresh status, set the refresh interval in seconds between 3 and 100. The default value is 6.   |

- 2) In the **Port Config** section, select one or more ports to configure the loopback detection parameters. Then click **Apply**.

|                |  |
|----------------|--|
| Status         | Enable loopback detection for the port.  |
| Operation Mode | Select the operation mode when a loopback is detected on the port:<br><br><b>Alert:</b> The Loop Status will display whether there is a loop detected on the corresponding port. It is the default setting.<br><br><b>Port Based:</b> In addition to displaying alerts, the switch will block the port on which the loop is detected.<br><br><b>VLAN-Based:</b> If a loop is detected in a VLAN on that port, in addition to displaying alerts, the switch will block that VLAN. The traffic of the other VLANs can still be normally forwarded by the port. |
| Recovery Mode  | If you select <b>Port Based</b> or <b>VLAN-Based</b> as the operation mode, you also need to configure the recovery mode for the blocked port:<br><br><b>Auto:</b> The blocked port will automatically be recovered to normal status after the automatic recovery time expires. It is the default setting.<br><br><b>Manual:</b> You need to manually release the blocked port. Click <b>Recovery</b> to release the selected port.  |

- 3) (Optional) View the loopback detection information.

|              |  |
|--------------|--|
| Loop Status  | Displays whether a loop is detected on the port. |
| Block Status | Displays whether the port is blocked.            |
| Block VLAN   | Displays the blocked VLANs.                      |



## 4.2 Using the CLI

Follow these steps to configure loopback detection:

|        |  |
|--------|--|
| Step 1 | <b>configure</b><br>Enter global configuration mode.   |
| Step 2 | <b>loopback-detection</b><br>Enable the loopback detection feature globally. By default, it is disabled.   |
| Step 3 | <b>loopback-detection interval <i>interval-time</i></b><br>Set the interval of sending loopback detection packets which is used to detect the loops in the network.<br><i>interval-time</i> : The interval of sending loopback detection packets. The valid values are from 1 to 1000 seconds. By default, the value is 30 seconds.  |
| Step 4 | <b>loopback-detection recovery-time <i>recovery-time</i></b><br>Set the auto-recovery time, after which the blocked port in Auto Recovery mode can automatically be recovered to normal status.<br><i>recovery-time</i> : Specify the detection interval, ranging from 2 to 100,000 seconds. The default value is 90.  |
| Step 5 | <b>interface { fastEthernet <i>port</i>   range fastEthernet <i>port-list</i>   gigabitEthernet <i>port</i>   range gigabitEthernet <i>port-list</i>   ten-gigabitEthernet <i>port</i>   ten-range gigabitEthernet <i>port-list</i>   port-channel <i>port-channel</i>   range port-channel <i>port-channel-list</i> }</b><br>Enter interface configuration mode.  |
| Step 6 | <b>loopback-detection</b><br>Enable loopback detection for the port. By default, it is disabled.   |
| Step 7 | <b>loopback-detection config process-mode { alert   port-based   vlan-based } recovery-mode { auto   manual }</b><br>Set the process mode when a loopback is detected on the port. There are three modes:<br><b>alert</b> : The switch will only display alerts when a loopback is detected. It is the default setting.<br><b>port-based</b> : In addition to displaying alerts, the switch will block the port on which the loop is detected.<br><b>vlan-based</b> : In addition to displaying alerts, the switch will block the VLAN of the port in which the loop is detected.<br>Set the recovery mode for the blocked port. There are two modes:<br><b>auto</b> : After the recovery time expires, the blocked port will automatically recover to normal status and restart to detect loops in the network.<br><b>manual</b> : The blocked port can only be released manually. You can use the command 'loopback-detection recover' to recover the blocked port to normal status. |
| Step 9 | <b>show loopback-detection global</b><br>Verify the global configuration of Loopback Detection.  |

|         |  |
|---------|--|
| Step 10 | <b>show loopback-detection interface { fastEthernet port   gigabitEthernet port   ten-gigabitEthernet port   port-channel port-channel }</b><br>Verify the Loopback Detection configuration of the specified port. |
| Step 11 | <b>end</b><br>Return to privileged EXEC mode.  |
| Step 12 | <b>copy running-config startup-config</b><br>Save the settings in the configuration file.  |

The following example shows how to enable loopback detection globally (keep the default parameters):

```

Switch#configure
Switch(config)#loopback-detection
Switch(config)#show loopback-detection global
Loopback detection global status : enable
Loopback detection interval : 30s
Loopback detection recovery time : 3 intervals
Switch(config-if)#end
Switch#copy running-config startup-config

```

The following example shows how to enable loopback detection of port 1/0/3 and set the process mode as alert and recovery mode as auto:

```

Switch#configure
Switch(config)#interface gigabitEthernet 1/0/3
Switch(config-if)#loopback-detection
Switch(config-if)#loopback-detection config process-mode alert recovery-mode auto
Switch(config-if)#show loopback-detection interface gigabitEthernet 1/0/3

```

| Port    | Enable | Process Mode | Recovery Mode | Loopback | Block | LAG  |
|---------|--------|--------------|---------------|----------|-------|------|
| ----    | -----  | -----        | -----         | -----    | ----  | ---- |
| Gi1/0/3 | enable | alert        | auto          | N/A      | N/A   | N/A  |

```

Switch(config-if)#end
Switch#copy running-config startup-config

```

# 5 Configuration Examples

## 5.1 Example for Port Isolation

### 5.1.1 Network Requirements

As shown below, three hosts and a server are connected to the switch and all belong to VLAN 10. Without changing the VLAN configuration, Host A is not allowed to communicate with the other hosts except the server, even if the MAC address or IP address of Host A is changed.

Figure 5-1 Network Topology

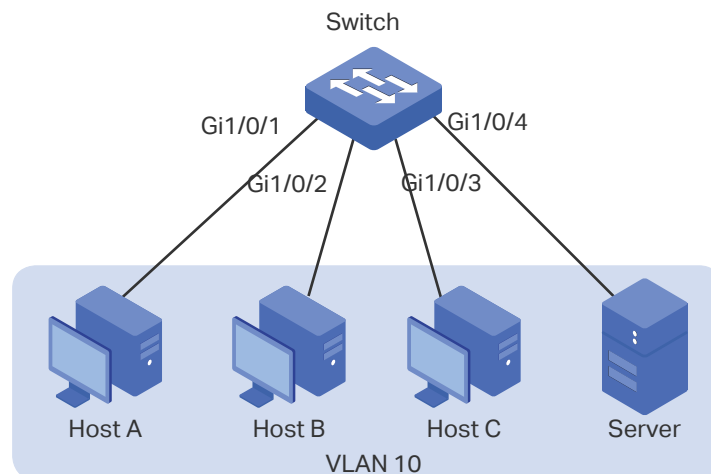

### 5.1.2 Configuration Scheme

You can configure port isolation to implement the requirement. Set port 1/0/4 as the only forwarding port for port 1/0/1, thus forbidding Host A to forward packets to the other hosts.

Since communications are bidirectional, if you want Host A and the server to communicate normally, you also need to add port 1/0/1 as the forwarding port for port 1/0/4.

Demonstrated with TL-SG2210P, the following sections provide configuration procedure in two ways: using the GUI and using the CLI.

### 5.1.3 Using the GUI

- 1) Choose the menu **L2 FEATURES > Switching > Port > Port Isolation** to load the following page. It displays the port isolation list.

Figure 5-2 Port Isolation List

| Port Isolation Config                         |     |                      |  |
|---|-----|----------------------|--|
| UNIT1 <span style="float: right;">Edit</span> |     |                      |  |
| Port  | LAG | Forwarding Port List |  |
| 1/0/1   | --  | 1/0/1-28,LAG1-8      |  |
| 1/0/2   | --  | 1/0/1-28,LAG1-8      |  |
| 1/0/3   | --  | 1/0/1-28,LAG1-8      |  |
| 1/0/4   | --  | 1/0/1-28,LAG1-8      |  |
| 1/0/5   | --  | 1/0/1-28,LAG1-8      |  |
| 1/0/6   | --  | 1/0/1-28,LAG1-8      |  |
| 1/0/7   | --  | 1/0/1-28,LAG1-8      |  |
| 1/0/8   | --  | 1/0/1-28,LAG1-8      |  |
| 1/0/9   | --  | 1/0/1-28,LAG1-8      |  |
| 1/0/10  | --  | 1/0/1-28,LAG1-8      |  |

Total: 28

- 2) Click **Edit** on the above page to load the following page. Select port 1/0/1 as the port to be isolated, and select port 1/0/4 as the forwarding port. Click **Apply**.

Figure 5-3 Port Isolation Configuration

Port Isolation Config

Port

UNIT1
LAGS

Select All

2

4

6

8

10

12

14

16

18

20

22

24

26

28

1

3

5

7

9

11

13

15

17

19

21

23

25

27

Selected

Unselected

Not Available

Forwarding Port List

UNIT1
LAGS

Select All

2

4

6

8

10

12

14

16

18

20

22

24

26

28

1

3

5

7

9

11

13

15

17

19

21

23

25

27

Selected

Unselected

Not Available

Cancel

Apply

- 3) Select port 1/0/4 as the port to be isolated, and select port 1/0/1 as the forwarding port. Click **Apply**.

Figure 5-4 Port Isolation Configuration

**Port Isolation Config**

Port

Select All

UNIT1 LAGS

2 4 6 8 10 12 14 16 18 20 22 24 26 28

1 3 5 7 9 11 13 15 17 19 21 23 25 27

Selected Unselected Not Available

Forwarding Port List

Select All

UNIT1 LAGS

2 4 6 8 10 12 14 16 18 20 22 24 26 28

1 3 5 7 9 11 13 15 17 19 21 23 25 27

Selected Unselected Not Available

Cancel Apply

4) Click  Save to save the settings.

### 5.1.4 Using the CLI

```
Switch#configure
Switch(config)#interface gigabitEthernet 1/0/1
Switch(config-if)#port isolation gi-forward-list 1/0/4
Switch(config-if)#exit
Switch(config)#interface gigabitEthernet 1/0/4
Switch(config-if)#port isolation gi-forward-list 1/0/1
Switch(config-if)#end
Switch#copy running-config startup-config
```

#### Verify the Configuration

```
Switch#show port isolation interface
```

| Port    | LAG | Forward-List      |
|---------|-----|-------------------|
| ----    | --- | -----             |
| Gi1/0/1 | N/A | Gi1/0/4           |
| Gi1/0/2 | N/A | Gi1/0/1-28,Po1-14 |
| Gi1/0/3 | N/A | Gi1/0/1-28,Po1-14 |
| Gi1/0/4 | N/A | Gi1/0/1           |
| ...     |     |                   |

## 5.2 Example for Loopback Detection

### 5.2.1 Network Requirements

As shown below, Switch A is a convergence-layer switch connecting to several access-layer switches. Loops can be easily caused in case of misoperation on the access-layer switches. If there is a loop on an access-layer switch, broadcast storms will occur on Switch A or even in the entire network, creating excessive traffic and degrading the network performance.

To reduce the impacts of broadcast storms, users need to detect loops in the network via Switch A and timely block the port on which a loop is detected.

Figure 5-5 Network Topology

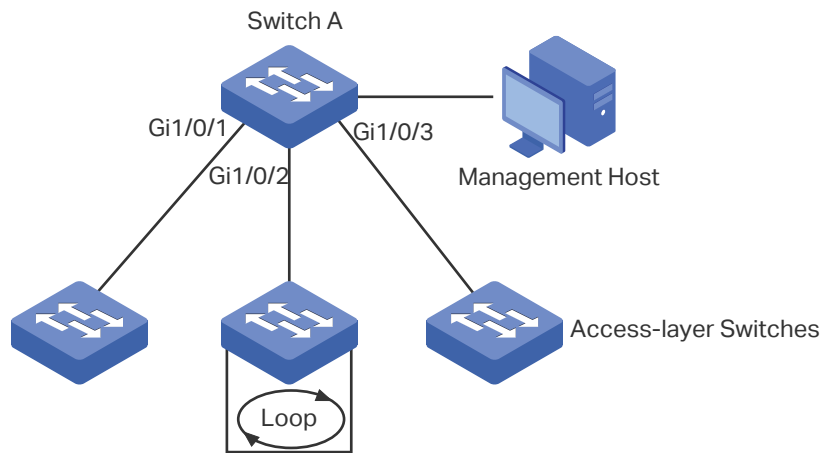

### 5.2.2 Configuration Scheme

Enable loopback detection on ports 1/0/1-3 and configure SNMP to receive the trap notifications. For detailed instructions about SNMP, refer to [Configuring SNMP & RMON](#). Here we introduce how to configure loopback detection and monitor the detection result on the management interface of the switch.

Demonstrated with TL-SG2210P, the following sections provide configuration procedure in two ways: using the GUI and using the CLI.

### 5.2.3 Using the GUI

- 1) Choose the menu **L2 FEATURES > Switching > Port > Loopback Detection** to load the configuration page.
- 2) In the **Loopback Detection** section, enable loopback detection and web refresh globally. Keep the other parameters as default values and click **Apply**.

Figure 5-6 Global Configuration

Loopback Detection

Loopback Detection Status:  **Enable**

Detection Interval:  seconds (1-1000)

Auto-recovery Time:  seconds (2-100,000)

Web Refresh Status:  **Enable**

Web Refresh Interval:  seconds (3-100)

- 3) In the **Port Config** section, enable ports 1/0/1-3, select the operation mode as **Port -Based** so that the port will be blocked when a loop is detected, and keep the recovery mode as **Auto** so that the port will automatically be recovered to normal status after the auto-recovery time. Click **Apply**.

Figure 5-7 Port Configuration

Port Config

↻ Recovery

|                                     | Port   | Status   | Operation Mode | Recovery Mode | Loop Status | Block Status | Block VLAN | LAG |
|-------------------------------------|--------|----------|----------------|---------------|-------------|--------------|------------|-----|
| <input checked="" type="checkbox"/> | 1/0/1  | Enabled  | Port Based     | Auto          | ---         | ---          | --         | --- |
| <input checked="" type="checkbox"/> | 1/0/2  | Enabled  | Port Based     | Auto          | ---         | ---          | --         | --- |
| <input checked="" type="checkbox"/> | 1/0/3  | Enabled  | Port Based     | Auto          | ---         | ---          | --         | --- |
| <input type="checkbox"/>            | 1/0/4  | Disabled | Alert          | Auto          | ---         | ---          | --         | --- |
| <input type="checkbox"/>            | 1/0/5  | Disabled | Alert          | Auto          | ---         | ---          | --         | --- |
| <input type="checkbox"/>            | 1/0/6  | Disabled | Alert          | Auto          | ---         | ---          | --         | --- |
| <input type="checkbox"/>            | 1/0/7  | Disabled | Alert          | Auto          | ---         | ---          | --         | --- |
| <input type="checkbox"/>            | 1/0/8  | Disabled | Alert          | Auto          | ---         | ---          | --         | --- |
| <input type="checkbox"/>            | 1/0/9  | Disabled | Alert          | Auto          | ---         | ---          | --         | --- |
| <input type="checkbox"/>            | 1/0/10 | Disabled | Alert          | Auto          | ---         | ---          | --         | --- |

Total: 28 3 entries selected.

- 4) Monitor the detection result on the above page. The **Loop status** and **Block status** are displayed on the right side of ports.

## 5.2.4 Using the CLI

- 1) Enable loopback detection globally and configure the detection interval and recovery time.

```
Switch#configure
```

```
Switch(config)#loopback-detection
```

```
Switch(config)#loopback-detection interval 30
```

```
Switch(config)#loopback-detection recovery-time 3
```

- 2) Enable loopback detection on ports 1/0/1-3 and set the process mode and recovery mode.

```
Switch(config)#interface range gigabitEthernet 1/0/1-3
```

```
Switch(config-if-range)#loopback-detection
```

```
Switch(config-if-range)#loopback-detection config process-mode port-based
recovery-mode auto
```

```
Switch(config-if-range)#end
```

```
Switch#copy running-config startup-config
```

### Verify the Configuration

Verify the global configuration:

```
Switch#show loopback-detection global
```

```
Loopback detection global status : enable
```

```
Loopback detection interval: 30 s
```

```
Loopback detection recovery time : 90 s
```

Verify the loopback detection configuration on ports:

```
Switch#show loopback-detection interface
```

| Port    | Enable | Process Mode | Recovery Mode | Loopback | Block | LAG |
|---------|--------|--------------|---------------|----------|-------|-----|
| Gi1/0/1 | enable | port-based   | auto          | N/A      | N/A   | N/A |
| Gi1/0/2 | enable | port-based   | auto          | N/A      | N/A   | N/A |
| Gi1/0/3 | enable | port-based   | auto          | N/A      | N/A   | N/A |



# 6 Appendix: Default Parameters

Default settings of Switching are listed in the following tables.

Table 6-1 Configurations for Ports

| Parameter                 | Default Setting                                  |
|---------------------------|--|
| Port Config               |  |
| Jumbo                     | 1518 bytes                                       |
| Type                      | Copper (For RJ45 Ports)<br>Fiber (For SFP Ports) |
| Status                    | Enabled  |
| Speed                     | Auto (For RJ45 Ports)<br>1000M (For SFP Ports)   |
| Duplex                    | Auto (For RJ45 Ports)<br>Full (For SFP Ports)    |
| Flow Control              | Disabled   |
| Loopback Detection        |  |
| Loopback Detection Status | Disabled   |
| Detection Interval        | 30 seconds                                       |
| Auto-recovery Time        | 90 seconds                                       |
| Web Refresh Status        | Disabled   |
| Web Refresh Interval      | 6 seconds  |
| Port Status               | Disabled   |
| Operation mode            | Alert  |
| Recovery mode             | Auto   |

# Part 4

## Configuring LAG

### CHAPTERS

1. LAG
2. LAG Configuration
3. Configuration Example
4. Appendix: Default Parameters

# 1 LAG

## 1.1 Overview

With LAG (Link Aggregation Group) function, you can aggregate multiple physical ports into a logical interface, increasing link bandwidth and providing backup ports to enhance the connection reliability.

## 1.2 Supported Features

You can configure LAG in two ways: static LAG and LACP (Link Aggregation Control Protocol).

### Static LAG

The member ports are manually added to the LAG.

### LACP

The switch uses LACP to implement dynamic link aggregation and disaggregation by exchanging LACP packets with its peer device. LACP extends the flexibility of the LAG configuration.

# 2 LAG Configuration

To complete LAG configuration, follow these steps:

- 1) Configure the global load-balancing algorithm.
- 2) Configure Static LAG or LACP.

## Configuration Guidelines

- Ensure that both ends of the aggregation link work in the same LAG mode. For example, if the local end works in LACP mode, the peer end should also be set as LACP mode.
- Ensure that devices on both ends of the aggregation link use the same number of physical ports with the same speed, duplex, jumbo and flow control mode.
- A port cannot be added to more than one LAG at the same time.
- LACP does not support half-duplex links.
- One static LAG supports up to eight member ports. All the member ports share the bandwidth evenly. If an active link fails, the other active links share the bandwidth evenly.
- One LACP LAG supports multiple member ports, but at most eight of them can work simultaneously, and the other member ports are backups. Using LACP protocol, the switches negotiate parameters and determine the working ports. When a working port fails, the backup port with the highest priority will replace the faulty port and start to forward data.
- For the functions like IGMP Snooping, 802.1Q VLAN, MAC VLAN, Protocol VLAN, VLAN-VPN, GVRP, Voice VLAN, STP, QoS, DHCP Snooping and Flow Control, the member port of an LAG follows the configuration of the LAG but not its own. The configurations of the port can take effect only after it leaves the LAG.
- The port enabled with Port Security, Port Mirror, MAC Address Filtering or 802.1X cannot be added to an LAG, and the member port of an LAG cannot be enabled with these functions.

## 2.1 Using the GUI

### 2.1.1 Configuring Load-balancing Algorithm

Choose the menu **L2 FEATURES > Switching > LAG > LAG Table** to load the following page.

Figure 2-1 Global Config

The screenshot shows the 'Global Config' interface. At the top, there is a 'Hash Algorithm:' dropdown menu currently set to 'SRC MAC+DST MAC'. To the right of this menu is a blue 'Apply' button. Below this is the 'LAG Table' section, which contains a table with the following data:

| <input type="checkbox"/> | Group ID | Description | Members | Operation |
|--------------------------|----------|-------------|---------|-----------|
| <input type="checkbox"/> | 1        | Active LACP | --      |           |

At the bottom left of the table area, it says 'Total: 1'. At the bottom right, there is a 'Delete' button with a minus sign icon.

In the **Global Config** section, select the load-balancing algorithm (Hash Algorithm), then click **Apply**.

#### Hash Algorithm

Select the Hash Algorithm, based on which the switch can choose the port to forward the received packets. In this way, different data flows are forwarded on different physical links to implement load balancing. There are six options:

**SRC MAC:** The computation is based on the source MAC addresses of the packets.

**DST MAC:** The computation is based on the destination MAC addresses of the packets.

**SRC MAC+DST MAC:** The computation is based on the source and destination MAC addresses of the packets.

**SRC IP:** The computation is based on the source IP addresses of the packets.

**DST IP:** The computation is based on the destination IP addresses of the packets.

**SRC IP+DST IP:** The computation is based on the source and destination IP addresses of the packets.

#### Tips:

- Load-balancing algorithm is effective only for outgoing traffic. If the data stream is not well shared by each link, you can change the algorithm of the outgoing interface.
- Please properly choose the load-balancing algorithm to avoid data stream transferring only on one physical link. For example, Switch A receives packets from several hosts and forwards them to the Server with the fixed MAC address, you can set the algorithm

as "SRC MAC" to allow Switch A to determine the forwarding port based on the source MAC addresses of the received packets.

Figure 2-2 Hash Algorithm Configuration

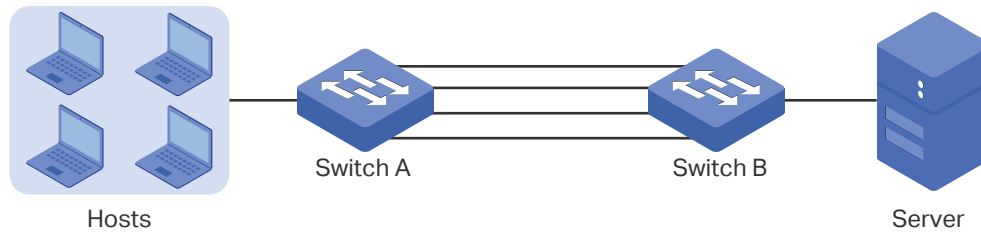

### 2.1.2 Configuring Static LAG or LACP

For one port, you can choose only one LAG mode: Static LAG or LACP. And make sure both ends of a link use the same LAG mode.

#### ■ Configuring Static LAG

Choose the menu **L2 FEATURES > Switching > LAG > Static LAG** to load the following page.

Figure 2-3 Static LAG

**LAG Config**

Group ID:

Description: --

Port:  (Format: 1/0/1, input or choose below)

UNIT1

|   |   |   |   |    |    |    |    |    |    |    |    |    |    |
|---|---|---|---|----|----|----|----|----|----|----|----|----|----|
| 2 | 4 | 6 | 8 | 10 | 12 | 14 | 16 | 18 | 20 | 22 | 24 | 26 | 28 |
| 1 | 3 | 5 | 7 | 9  | 11 | 13 | 15 | 17 | 19 | 21 | 23 | 25 | 27 |

Selected

Unselected

Not Available

Follow these steps to configure the static LAG:

- 1) Select an LAG for configuration.

|                    |   |
|--------------------|---|
| <b>Group ID</b>    | Select an LAG for static LAG configuration. |
| <b>Description</b> | Displays the LAG mode.                      |

- 2) Select the member ports for the LAG. It is multi-optional.
- 3) Click **Apply**.

 **Note:**

Clearing all member ports will delete the LAG.

## ■ Configuring LACP

Choose the menu **L2 FEATURES > Switching > LAG > LACP** to load the following page.

Figure 2-4 LACP Config

Global Config

---

System Priority:  (0-65535) Apply

---

LACP Config

**UNIT1**

| <input type="checkbox"/> | Port   | Status   | Group ID | Port Priority | Mode    | LAG |
|--------------------------|--------|----------|----------|---------------|---------|-----|
| <input type="checkbox"/> | 1/0/1  | Disabled | 0        | 32768         | Passive | --- |
| <input type="checkbox"/> | 1/0/2  | Disabled | 0        | 32768         | Passive | --- |
| <input type="checkbox"/> | 1/0/3  | Disabled | 0        | 32768         | Passive | --- |
| <input type="checkbox"/> | 1/0/4  | Disabled | 0        | 32768         | Passive | --- |
| <input type="checkbox"/> | 1/0/5  | Disabled | 0        | 32768         | Passive | --- |
| <input type="checkbox"/> | 1/0/6  | Disabled | 0        | 32768         | Passive | --- |
| <input type="checkbox"/> | 1/0/7  | Disabled | 0        | 32768         | Passive | --- |
| <input type="checkbox"/> | 1/0/8  | Disabled | 0        | 32768         | Passive | --- |
| <input type="checkbox"/> | 1/0/9  | Disabled | 0        | 32768         | Passive | --- |
| <input type="checkbox"/> | 1/0/10 | Disabled | 0        | 32768         | Passive | --- |

Total: 28

Follow these steps to configure LACP:

- 1) Specify the system priority for the switch and click **Apply**.

**System Priority**

Specify the system priority for the switch. A smaller value means a higher priority.

To keep active ports consistent at both ends, you can set the system priority of one device to be higher than that of the other device. The device with higher priority will determine its active ports, and the other device can select its active ports according to the selection result of the device with higher priority. If the two ends have the same system priority value, the device with a smaller MAC address has the higher priority.

- 2) Select member ports for the LAG and configure the related parameters. Click **Apply**.

---

|                         |  |
|-------------------------|--|
| Group ID                | <p>Specify the group ID of the LAG. Note that the group ID of other static LAGs cannot be set as this value.</p> <p>The valid value of the Group ID is determined by the maximum number of LAGs supported by your switch. For example, if your switch supports up to 14 LAGs, the valid value ranges from 1 to 14.</p>   |
| Port Priority (0-65535) | <p>Specify the Port Priority. A smaller value means a higher port priority.</p> <p>The port with higher priority in an LAG will be selected as the working port to forward data, and at most eight ports can work simultaneously. If two ports have the same priority value, the port with a smaller port number has the higher priority.</p>  |
| Mode                    | <p>Select the LACP mode for the port.</p> <p>In LACP, the switch uses LACPDU (Link Aggregation Control Protocol Data Unit) to negotiate the parameters with the peer end. In this way, the two ends select active ports and form the aggregation link. The LACP mode determines whether the port will take the initiative to send the LACPDU. There are two modes:</p> <p><b>Passive:</b> The port will not send LACPDU before receiving the LACPDU from the peer end.</p> <p><b>Active:</b> The port will take the initiative to send LACPDU.</p> |
| Status                  | <p>Enable the LACP function of the port. By default, it is disabled.</p>   |

---

## 2.2 Using the CLI

### 2.2.1 Configuring Load-balancing Algorithm

Follow these steps to configure the load-balancing algorithm:

---

|        |  |
|--------|--|
| Step 1 | <b>configure</b><br>Enter global configuration mode. |
|--------|--|

---



---

|        |   |
|--------|---|
| Step 2 | <p><b>port-channel load-balance { src-mac   dst-mac   src-dst-mac   src-ip   dst-ip   src-dst-ip }</b></p> <p>Select the Hash Algorithm. The switch will choose the ports to transfer the packets based on the Hash Algorithm. In this way, different data flows are forwarded on different physical links to implement load balancing.</p> <p><b>src-mac:</b> The computation is based on the source MAC addresses of the packets.</p> <p><b>dst-mac:</b> The computation is based on the destination MAC addresses of the packets.</p> <p><b>src-dst-mac:</b> The computation is based on the source and destination MAC addresses of the packets.</p> <p><b>src-ip:</b> The computation is based on the source IP addresses of the packets.</p> <p><b>dst-ip:</b> The computation is based on the destination IP addresses of the packets.</p> <p><b>src-dst-ip:</b> The computation is based on the source and destination IP addresses of the packets.</p> |
| <hr/>  |   |
| Step 3 | <p><b>show etherchannel load-balance</b></p> <p>Verify the configuration of load-balancing algorithm.</p>   |
| <hr/>  |   |
| Step 4 | <p><b>end</b></p> <p>Return to privileged EXEC mode.</p>  |
| <hr/>  |   |
| Step 5 | <p><b>copy running-config startup-config</b></p> <p>Save the settings in the configuration file.</p>  |

---

The following example shows how to set the global load-balancing mode as src-dst-mac:

**Switch#configure**

**Switch(config)#port-channel load-balance src-dst-mac**

**Switch(config)#show etherchannel load-balance**

EtherChannel Load-Balancing Configuration: src-dst-mac

EtherChannel Load-Balancing Addresses Used Per-Protocol:

Non-IP: Source XOR Destination MAC address

IPv4: Source XOR Destination MAC address

IPv6: Source XOR Destination MAC address

**Switch(config)#end**

**Switch#copy running-config startup-config**

## 2.2.2 Configuring Static LAG or LACP

You can choose only one LAG mode for a port: Static LAG or LACP. And make sure both ends of a link use the same LAG mode.

## ■ Configuring Static LAG

Follow these steps to configure static LAG:

|        |   |
|--------|---|
| Step 1 | <b>configure</b><br>Enter global configuration mode.  |
| Step 2 | <b>interface {fastEthernet port   range fastEthernet port-list   gigabitEthernet port   range gigabitEthernet port-list   ten-gigabitEthernet port   range ten-gigabitEthernet port-list }</b><br>Enter interface configuration mode. |
| Step 3 | <b>channel-group num mode on</b><br>Add the port to a static LAG.<br><br><i>num</i> : The group ID of the LAG.  |
| Step 4 | <b>show etherchannel num summary</b><br>Verify the configuration of the static LAG.<br><br><i>num</i> : The group ID of the LAG.  |
| Step 5 | <b>end</b><br>Return to privileged EXEC mode.   |
| Step 6 | <b>copy running-config startup-config</b><br>Save the settings in the configuration file.   |

The following example shows how to add ports 1/0/5-8 to LAG 2 and set the mode as static LAG:

**Switch#configure**

**Switch(config)#interface range gigabitEthernet 1/0/5-8**

**Switch(config-if-range)#channel-group 2 mode on**

**Switch(config-if-range)#show etherchannel 2 summary**

```
Flags: D - down          P - bundled in port-channel    U - in use
       I - stand-alone   H - hot-standby(LACP only)    s - suspended
       R - layer3       S - layer2          f - failed to allocate aggregator
       u - unsuitable for bundling  w - waiting to be aggregated  d - default port
Group  Port-channel  Protocol  Ports
-----  -
2      Po2(S)        -         Gi1/0/5(D) Gi1/0/6(D) Gi1/0/7(D) Gi1/0/8(D)
```

**Switch(config-if-range)#end**

**Switch#copy running-config startup-config**

## ■ Configuring LACP

Follow these steps to configure LACP:

---

|        |   |
|--------|---|
| Step 1 | <b>configure</b><br>Enter global configuration mode.  |
| Step 2 | <b>lACP system-priority <i>pri</i></b><br>Specify the system priority for the switch.<br><br>To keep active ports consistent at both ends, you can set the priority of one device to be higher than that of the other device. The device with higher priority will determine its active ports, and the other device can select its active ports according to the selection result of the device with higher priority. If the two ends have the same system priority value, the end with a smaller MAC address has the higher priority.<br><br><i>pri</i> : System priority. The valid values are from 0 to 65535, and the default value is 32768. A smaller value means a higher device priority.                                     |
| Step 3 | <b>interface {fastEthernet <i>port</i>   range fastEthernet <i>port-list</i>   gigabitEthernet <i>port</i>   range gigabitEthernet <i>port-list</i>   ten-gigabitEthernet <i>port</i>   range ten-gigabitEthernet <i>port-list</i> }</b><br>Enter interface configuration mode.   |
| Step 4 | <b>channel-group <i>num</i> mode { active   passive }</b><br>Add the port to an LAG and set the mode as LACP.<br><br><i>num</i> : The group ID of the LAG.<br><br><b>mode</b> : LAG mode. Here you need to select LACP mode: active or passive.<br><br>In LACP, the switch uses LACPDU (Link Aggregation Control Protocol Data Unit) to negotiate the parameters with the peer end. In this way, the two ends select active ports and form the aggregation link. The LACP mode determines whether the port will take the initiative to send the LACPDU.<br><br><i>passive</i> : The port will not send LACPDU before receiving the LACPDU from the peer end.<br><br><i>active</i> : The port will take the initiative to send LACPDU. |
| Step 5 | <b>lACP port-priority <i>pri</i></b><br>Specify the Port Priority. The port with higher priority in an LAG will be selected as the working port. If two ports have the same priority value, the port with a smaller port number has the higher priority.<br><br><i>pri</i> : Port priority. The valid values are from 0 to 65535, and the default value is 32768. A smaller value means a higher port priority.   |
| Step 6 | <b>show lACP sys-id</b><br>Verify the global system priority.   |
| Step 7 | <b>show lACP internal</b><br>Verify the LACP configuration of the local switch.   |
| Step 8 | <b>end</b><br>Return to privileged EXEC mode.   |

---

---

Step 9      **copy running-config startup-config**  
 Save the settings in the configuration file.

---

The following example shows how to specify the system priority of the switch as 2:

**Switch#configure**

**Switch(config)#lacp system-priority 2**

**Switch(config)#show lacp sys-id**

2,000a.eb13.2397

**Switch(config)#end**

**Switch#copy running-config startup-config**

The following example shows how to add ports 1/0/1-4 to LAG 6, set the mode as LACP, and select the LACPDU sending mode as active:

**Switch#configure**

**Switch(config)#interface range gigabitEthernet 1/0/1-4**

**Switch(config-if-range)#channel-group 6 mode active**

**Switch(config-if-range)#show lacp internal**

Flags: S - Device is requesting Slow LACPDU

        F - Device is requesting Fast LACPDU

        A - Device is in active mode

        P - Device is in passive mode

Channel group 6

| Port    | Flags | State | LACP Port Priority | Admin Key | Oper Key | Port Number | Port State |
|---------|-------|-------|--------------------|-----------|----------|-------------|------------|
| Gi1/0/1 | SA    | Up    | 32768              | 0x6       | 0x4b1    | 0x1         | 0x7d       |
| Gi1/0/2 | SA    | Down  | 32768              | 0x6       | 0        | 0x2         | 0x45       |
| Gi1/0/3 | SA    | Down  | 32768              | 0x6       | 0        | 0x3         | 0x45       |
| Gi1/0/4 | SA    | Down  | 32768              | 0x6       | 0        | 0x4         | 0x45       |

**Switch(config-if-range)#end**

**Switch#copy running-config startup-config**

# 3 Configuration Example

## 3.1 Network Requirements

As shown below, hosts and servers are connected to Switch A and Switch B, and heavy traffic is transmitted between the two switches. To achieve high speed and reliability of data transmission, users need to improve the bandwidth and redundancy of the link between the two switches.

## 3.2 Configuration Scheme

LAG function can bundle multiple physical ports into one logical interface to increase bandwidth and improve reliability. In this case, we take LACP as an example.

As shown below, you can bundle up to eight physical ports into one logical aggregation group to transmit data between the two switches, and respectively connect the ports of the groups. In addition, another two redundant links can be set as the backup. To avoid traffic bottleneck between the servers and Switch B, you also need to configure LAG on them to increase link bandwidth. Here we mainly introduce the LAG configuration between the two switches.

Figure 3-1 Network Topology

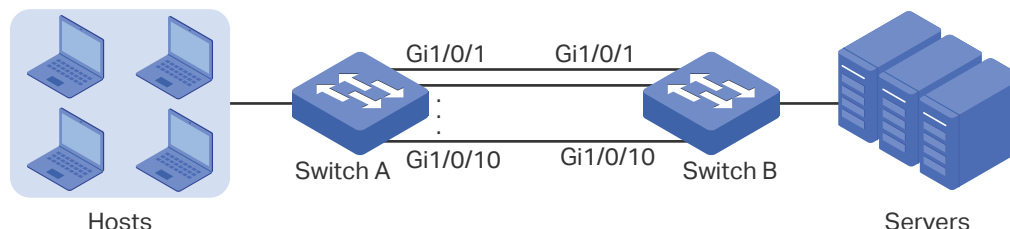

The overview of the configuration is as follows:

- 1) Considering there are multiple devices on each end, configure the load-balancing algorithm as 'SRC MAC+DST MAC'.
- 2) Specify the system priority for the switches. Here we choose Switch A as the dominate device and specify a higher system priority for it.
- 3) Add ports 1/0/1-10 to the LAG and set the mode as LACP.
- 4) Specify a lower port priority for ports 1/0/9-10 to set them as the backup ports. When any of ports 1/0/1-8 is down, the backup ports will automatically be enabled to transmit data.

Demonstrated with TL-SG2210P, the following sections provide configuration procedure in two ways: using the GUI and using the CLI.

### 3.3 Using the GUI

The configurations of Switch A and Switch B are similar. The following introductions take Switch A as an example.

- 1) Choose the menu **L2 FEATURES > Switching > LAG > LAG Table** to load the following page. Select the hash algorithm as 'SRC MAC+DST MAC'.

Figure 3-2 Global Configuration

Global Config

Hash Algorithm: SRC MAC+DST MAC ▾

Apply

- 2) Choose the menu **L2 FEATURES > Switching > LAG > LACP Config** to load the following page. In the **Global Config** section, specify the system priority of Switch A as **0** and Click **Apply**. Remember to ensure that the system priority value of Switch B is bigger than 0.

Figure 3-3 System Priority Configuration

Global Config

System Priority: 0 (0-65535)

Apply

- 3) In the **LACP Table** section, select ports 1/0/1-10, and respectively set the status, group ID, port priority and mode for each port as follows.

Figure 3-4 LACP Configuration

LACP Config

UNIT1

| <input type="checkbox"/> | Port   | Status  | Group ID | Port Priority | Mode   | LAG |
|--------------------------|--------|---------|----------|---------------|--------|-----|
| <input type="checkbox"/> | 1/0/1  | Enabled | 1        | 0             | Active | --- |
| <input type="checkbox"/> | 1/0/2  | Enabled | 1        | 0             | Active | --- |
| <input type="checkbox"/> | 1/0/3  | Enabled | 1        | 0             | Active | --- |
| <input type="checkbox"/> | 1/0/4  | Enabled | 1        | 0             | Active | --- |
| <input type="checkbox"/> | 1/0/5  | Enabled | 1        | 0             | Active | --- |
| <input type="checkbox"/> | 1/0/6  | Enabled | 1        | 0             | Active | --- |
| <input type="checkbox"/> | 1/0/7  | Enabled | 1        | 0             | Active | --- |
| <input type="checkbox"/> | 1/0/8  | Enabled | 1        | 0             | Active | --- |
| <input type="checkbox"/> | 1/0/9  | Enabled | 1        | 1             | Active | --- |
| <input type="checkbox"/> | 1/0/10 | Enabled | 1        | 2             | Active | --- |

Total: 28

- 4) Click Save to save the settings.

## 3.4 Using the CLI

The configurations of Switch A and Switch B are similar. The following introductions take Switch A as an example.

- 1) Configure the load-balancing algorithm as "src-dst-mac".

```
Switch#configure
```

```
Switch(config)#port-channel load-balance src-dst-mac
```

- 2) Specify the system priority of Switch A as 0. Remember to ensure that the system priority value of Switch B is bigger than 0.

```
Switch(config)#lacp system-priority 0
```

- 3) Add ports 1/0/1-8 to LAG 1 and set the mode as LACP. Then specify the port priority as 0 to make them active.

```
Switch(config)#interface range gigabitEthernet 1/0/1-8
```

```
Switch(config-if-range)#channel-group 1 mode active
```

```
Switch(config-if-range)#lacp port-priority 0
```

```
Switch(config-if-range)#exit
```

- 4) Add port 1/0/9 to LAG 1 and set the mode as LACP. Then specify the port priority as 1 to set it as a backup port. When any of the active ports is down, this port will be preferentially selected to work as an active port.

```
Switch(config)#interface gigabitEthernet 1/0/9
```

```
Switch(config-if)#channel-group 1 mode active
```

```
Switch(config-if)#lacp port-priority 1
```

```
Switch(config-if)#exit
```

- 5) Add port 1/0/10 to LAG 1 and set the mode as LACP. Then specify the port priority as 2 to set it as a backup port. The priority of this port is lower than port 1/0/9.

```
Switch(config)#interface gigabitEthernet 1/0/10
```

```
Switch(config-if)#channel-group 1 mode active
```

```
Switch(config-if)#lacp port-priority 2
```

```
Switch(config-if)#end
```

```
Switch#copy running-config startup-config
```

### Verify the Configuration

Verify the system priority:

```
Switch#show lacp sys-id
```

0, 000a.eb13.2397

Verify the LACP configuration:

Switch#show lacp internal

Flags: S - Device is requesting Slow LACPDUs

F - Device is requesting Fast LACPDUs

A - Device is in active mode

P - Device is in passive mode

Channel group 1

| Port     | Flags | State | LACP Port Priority | Admin Key | Oper Key | Port Number | Port State |
|----------|-------|-------|--------------------|-----------|----------|-------------|------------|
| Gi1/0/1  | SA    | Down  | 0                  | 0x1       | 0        | 0x1         | 0x45       |
| Gi1/0/2  | SA    | Down  | 0                  | 0x1       | 0        | 0x2         | 0x45       |
| Gi1/0/3  | SA    | Down  | 0                  | 0x1       | 0        | 0x3         | 0x45       |
| Gi1/0/4  | SA    | Down  | 0                  | 0x1       | 0        | 0x4         | 0x45       |
| Gi1/0/5  | SA    | Down  | 0                  | 0x1       | 0        | 0x5         | 0x45       |
| Gi1/0/6  | SA    | Down  | 0                  | 0x1       | 0        | 0x6         | 0x45       |
| Gi1/0/7  | SA    | Down  | 0                  | 0x1       | 0        | 0x7         | 0x45       |
| Gi1/0/8  | SA    | Down  | 0                  | 0x1       | 0        | 0x8         | 0x45       |
| Gi1/0/9  | SA    | Down  | 1                  | 0x1       | 0        | 0x9         | 0x45       |
| Gi1/0/10 | SA    | Down  | 2                  | 0x1       | 0        | 0xa         | 0x45       |



# 4 Appendix: Default Parameters

Default settings of Switching are listed in the following tables.

Table 4-1 Default Settings of LAG

| Parameter       | Default Setting |
|-----------------|-----------------|
| LAG Table       |                 |
| Hash Algorithm  | SRC MAC+DST MAC |
| LACP Config     |                 |
| System Priority | 32768           |
| Admin Key       | 0               |
| Port Priority   | 32768           |
| Mode            | Passive         |
| Status          | Disabled        |

# Part 5

## Managing MAC Address Table

### CHAPTERS

1. MAC Address Table
2. MAC Address Configurations
3. Appendix: Default Parameters

# 1 MAC Address Table

## 1.1 Overview

The MAC address table contains address information that the switch uses to forward packets. As shown below, the table lists map entries of MAC addresses, VLAN IDs and ports. These entries can be manually added or automatically learned by the switch. Based on the MAC-address-to-port mapping in the table, the switch can forward packets only to the associated port.

Table 1-1 The MAC Address Table

| MAC Address       | VLAN ID | Port | Type    | Aging Status |
|-------------------|---------|------|---------|--------------|
| 00:00:00:00:00:01 | 1       | 1    | Dynamic | Aging        |
| 00:00:00:00:00:02 | 1       | 2    | Static  | No-Aging     |
| ...               |         |      |         |              |

## 1.2 Supported Features

The address table of the switch contains dynamic addresses, static addresses and filtering addresses.

### Address Configurations

#### ■ Dynamic address

Dynamic addresses are addresses learned by the switch automatically, and the switch regularly ages out those that are not in use. That is, the switch removes the MAC address entries related to a network device if no packet is received from the device within the aging time. And you can specify the aging time if needed.

#### ■ Static address

Static addresses are manually added to the address table and do not age. For some relatively fixed connection, for example, frequently visited server, you can manually set the MAC address of the server as a static entry to enhance the forwarding efficiency of the switch.

#### ■ Filtering address

Filtering addresses are manually added and determine the packets with specific source or destination MAC addresses that will should dropped by the switch.

# 2 MAC Address Configurations

With MAC address table, you can:

- Add static MAC address entries
- Change the MAC address aging time
- Add filtering address entries
- View address table entries

## 2.1 Using the GUI

### 2.1.1 Adding Static MAC Address Entries

You can add static MAC address entries by manually specifying the desired MAC address or binding dynamic MAC address entries.

- Adding MAC Addresses Manually

Choose the menu **L2 FEATURES > Switching > MAC Address > Static Address** and click  **Add** to load the following page.

Figure 2-1 Adding MAC Addresses Manually



**Static Address**

MAC Address:  (Format: 00-00-00-00-00-01)

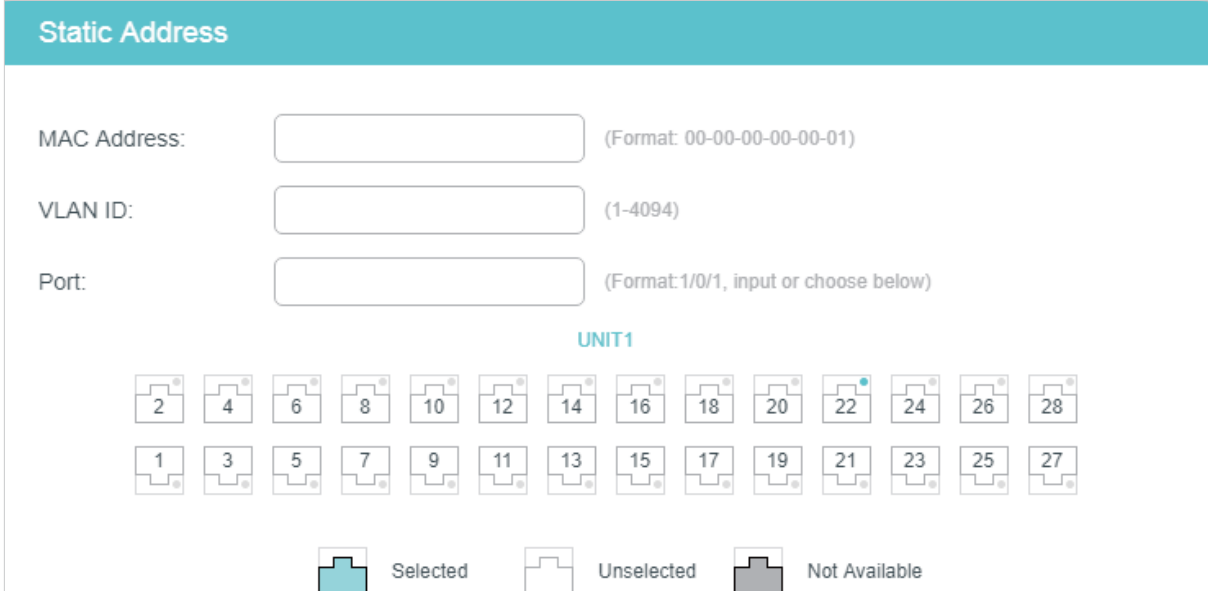

VLAN ID:  (1-4094)

Port:  (Format: 1/0/1, input or choose below)

**UNIT1**

2 4 6 8 10 12 14 16 18 20 22 24 26 28

1 3 5 7 9 11 13 15 17 19 21 23 25 27

 Selected  Unselected  Not Available

Follow these steps to add a static MAC address entry:

- 1) Enter the MAC address, VLAN ID and select a port to bind them together as an address entry.

|                    |  |
|--------------------|--|
| <b>MAC Address</b> | Enter the static MAC address to be added to the static MAC address entry.  |
| <b>VLAN ID</b>     | Specify an existing VLAN in which packets with the specific MAC address are received.  |
| <b>Port</b>        | Specify a port to which packets with the specific MAC address are forwarded. The port must belong to the specified VLAN.<br><br>After you have added the static MAC address, if the corresponding port number of the MAC address is not correct, or the connected port (or the device) has been changed, the switch cannot forward the packets correctly. Please reset the static address entry appropriately. |

2) Click **Create**.

■ **Binding Dynamic Address Entries**

If some dynamic address entries are frequently used, you can bind these entries as static entries.

Choose the menu **L2 FEATURES > Switching > MAC Address > Dynamic Address** to load the following page.

Figure 2-2 Binding Dynamic MAC Address Entries

**Aging Config**

Auto Aging:  Enable

Aging Time:  seconds (10-630)

**Apply**

---

**Dynamic Address Table**

🔍 All

| UNIT1                               | MAC Address       | VLAN ID | Port   | Type    | Aging Status |
|-------------------------------------|-------------------|---------|--------|---------|--------------|
| <input checked="" type="checkbox"/> | 30-B5-C2-BD-04-6E | 1       | 1/0/22 | Dynamic | Aging        |
| <input type="checkbox"/>            | 00-0A-EB-13-23-97 | 1       | 1/0/22 | Dynamic | Aging        |
| <input type="checkbox"/>            | 00-0A-EB-13-23-7B | 1       | 1/0/22 | Dynamic | Aging        |
| <input type="checkbox"/>            | C4-6E-1F-BF-72-51 | 1       | 1/0/22 | Dynamic | Aging        |
| <input type="checkbox"/>            | 00-19-66-35-E1-B0 | 1       | 1/0/22 | Dynamic | Aging        |

🔗 Bind    🗑️ Delete

Total: 5 1 entry selected.

Follow these steps to bind dynamic MAC address entries:

- 1) In the **Dynamic Address Table** section, Select your desired MAC address entries.
- 2) Click **Bind**, and then the selected entries will become static MAC address entries.

 **Note:**

- In the same VLAN, once an address is configured as a static address, it cannot be set as a filtering address, and vice versa.
- Multicast or broadcast addresses cannot be set as static addresses.
- Ports in LAGs (Link Aggregation Group) are not supported for static address configuration.

## 2.1.2 Modifying the Aging Time of Dynamic Address Entries

Choose the menu **L2 FEATURES > Switching > MAC Address > Dynamic Address** to load the following page.

Figure 2-3 Modifying the Aging Time of Dynamic Address Entries

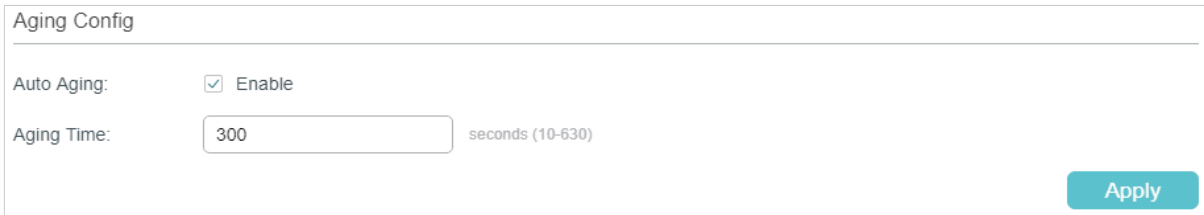

The screenshot shows a configuration page titled "Aging Config". It has two main settings: "Auto Aging" which is checked and labeled "Enable", and "Aging Time" which is set to "300" in a text box, with the unit "seconds (10-630)" indicated to the right. An "Apply" button is located in the bottom right corner of the configuration area.

Follow these steps to modify the aging time of dynamic address entries:

- 1) In the **Aging Config** section, enable Auto Aging, and enter your desired length of time.

|                   |   |
|-------------------|---|
| <b>Auto Aging</b> | Enable Auto Aging, then the switch automatically updates the dynamic address table with the aging mechanism. By default, it is enabled. |
|-------------------|---|

|                   |   |
|-------------------|---|
| <b>Aging Time</b> | Set the length of time that a dynamic entry remains in the MAC address table after the entry is used or updated. The valid values are from 10 to 630 seconds, and the default value is 300. |
|-------------------|---|

A short aging time is applicable to networks where network topology changes frequently, and a long aging time is applicable to stable networks. We recommend that you keep the default value if you are unsure about settings in your case.

- 2) Click **Apply**.

## 2.1.3 Adding MAC Filtering Address Entries

Choose the menu **L2 FEATURES > Switching > MAC Address > Filtering Address** and click **+ Add** to load the following page.

Figure 2-4 Adding MAC Filtering Address Entries

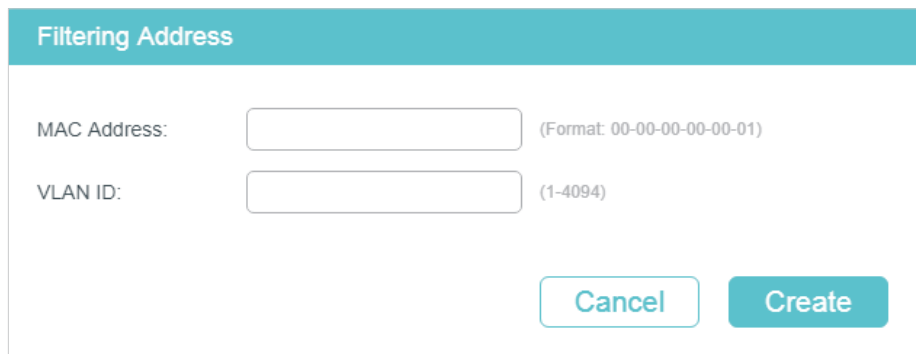

The screenshot shows a web interface for adding MAC filtering address entries. The page has a teal header with the text "Filtering Address". Below the header, there are two input fields. The first is labeled "MAC Address:" and has a placeholder "(Format: 00-00-00-00-00-01)". The second is labeled "VLAN ID:" and has a placeholder "(1-4094)". At the bottom right of the form, there are two buttons: "Cancel" and "Create".

Follow these steps to add MAC filtering address entries:

- 1) Enter the MAC Address and VLAN ID.

|             |  |
|-------------|--|
| MAC Address | Specify the MAC address to be used by the switch to filter the received packets.     |
| VLAN ID     | Specify an existing VLAN in which packets with the specific MAC address are dropped. |

- 2) Click **Create**.

 **Note:**

- In the same VLAN, once an address is configured as a filtering address, it cannot be set as a static address, and vice versa.
- Multicast or broadcast addresses cannot be set as filtering addresses .

## 2.1.4 Viewing Address Table Entries

You can view entries in MAC address table to check your former operations and address information.

Choose the menu **L2 FEATURES > Switching > MAC Address > Address Table** and click  **Search** to load the following page.

Figure 2-5 Viewing Address Table Entries

Address Table  Search ^

---

MAC Address  (Format: 00-00-00-00-00-01)  
 VLAN ID  (1-4094)  
 Type  Dynamic  Static  Filter  
 Port

| MAC Address       | VLAN ID | Port  | Type    | Aging Status |
|-------------------|---------|-------|---------|--------------|
| 30-B5-C2-BD-20-CC | 1       | 1/0/8 | Dynamic | Aging        |
| 00-0A-EB-13-23-97 | 1       | 1/0/8 | Dynamic | Aging        |
| 00-0A-EB-13-23-7B | 1       | 1/0/8 | Dynamic | Aging        |
| 30-B5-C2-BD-20-5C | 1       | 1/0/8 | Dynamic | Aging        |
| 00-0A-EB-13-A2-02 | 1       | 1/0/8 | Dynamic | Aging        |
| C4-6E-1F-BF-72-51 | 1       | 1/0/8 | Dynamic | Aging        |
| 00-19-66-35-E1-B0 | 1       | 1/0/8 | Dynamic | Aging        |
| Total: 7          |         |       |         |              |

## 2.2 Using the CLI

### 2.2.1 Adding Static MAC Address Entries

Follow these steps to add static MAC address entries:

**Step 1**     **configure**

Enter global configuration mode.

**Step 2**     **mac address-table static mac-addr vid vid interface { fastEthernet port | gigabitEthernet port | ten-gigabitEthernet port }**

Bind the MAC address, VLAN and port together to add a static address to the VLAN.

*mac-addr*: Enter the MAC address, and packets with this destination address received in the specified VLAN are forwarded to the specified port. The format is xx:xx:xx:xx:xx:xx, for example, 00:00:00:00:00:01.

*vid*: Specify an existing VLAN in which packets with the specific MAC address are received.

*port*: Specify a port to which packets with the specific MAC address are forwarded. The port must belong to the specified VLAN.



---

Step 3     **end**  
Return to privileged EXEC mode.

---

Step 4     **copy running-config startup-config**  
Save the settings in the configuration file.

---

 **Note:**

- In the same VLAN, once an address is configured as a static address, it cannot be set as a filtering address, and vice versa.
  - Multicast or broadcast addresses cannot be set as static addresses.
  - Ports in LAGs (Link Aggregation Group) are not supported for static address configuration.
- 

The following example shows how to add a static MAC address entry with MAC address 00:02:58:4f:6c:23, VLAN 10 and port 1. When a packet is received in VLAN 10 with this address as its destination, the packet will be forwarded only to port 1/0/1.

**Switch#configure**

**Switch(config)# mac address-table static 00:02:58:4f:6c:23 vid 10 interface gigabitEthernet 1/0/1**

**Switch(config)#show mac address-table static**

MAC Address Table

```

-----
MAC                VLAN    Port          Type          Aging
-----
00:02:58:4f:6c:23  10     Gi1/0/1      config static  no-aging

```

Total MAC Addresses for this criterion: 1

**Switch(config)#end**

**Switch#copy running-config startup-config**

## 2.2.2 Modifying the Aging Time of Dynamic Address Entries

Follow these steps to modify the aging time of dynamic address entries:

---

Step 1     **configure**  
Enter global configuration mode.

---

---

**Step 2** **mac address-table aging-time** *aging-time*

Set your desired length of address aging time for dynamic address entries.

*aging-time*: Set the length of time that a dynamic entry remains in the MAC address table after the entry is used or updated. The valid values are from 10 to 630. Value 0 means the Auto Aging function is disabled. The default value is 300 and we recommend you keep the default value if you are unsure.

---

**Step 3** **end**

Return to privileged EXEC mode.

---

**Step 4** **copy running-config startup-config**

Save the settings in the configuration file.

---

The following example shows how to modify the aging time to 500 seconds. A dynamic entry remains in the MAC address table for 500 seconds after the entry is used or updated.

**Switch#configure**

**Switch(config)# mac address-table aging-time 500**

**Switch(config)#show mac address-table aging-time**

Aging time is 500 sec.

**Switch(config)#end**

**Switch#copy running-config startup-config**

## 2.2.3 Adding MAC Filtering Address Entries

Follow these steps to add MAC filtering address entries:

---

**Step 1** **configure**

Enter global configuration mode.

---

**Step 2** **mac address-table filtering** *mac-addr vid vid*

Add the filtering address to the VLAN.

*mac-addr*: Specify a MAC address to be used by the switch to filter the received packets. The switch will drop packets of which the source address or destination address is the specified MAC address. The format is xx:xx:xx:xx:xx:xx, for example, 00:00:00:00:00:01.

*vid*: Specify an existing VLAN in which packets with the specific MAC address will be dropped.

---

**Step 3** **end**

Return to privileged EXEC mode.

---

**Step 4** **copy running-config startup-config**

Save the settings in the configuration file.

---

 **Note:**

- In the same VLAN, once an address is configured as a filtering address, it cannot be set as a static address, and vice versa.
- Multicast or broadcast addresses cannot be set as filtering addresses .

The following example shows how to add the MAC filtering address 00:1e:4b:04:01:5d to VLAN 10. Then the switch will drop the packet that is received in VLAN 10 with this address as its source or destination.

**Switch#configure****Switch(config)# mac address-table filtering 00:1e:4b:04:01:5d vid 10****Switch(config)#show mac address-table filtering**

MAC Address Table

```
-----  
MAC          VLAN  Port  Type  Aging  
---          -  
00:1e:4b:04:01:5d  10          filter  no-aging
```

Total MAC Addresses for this criterion: 1

**Switch(config)#end****Switch#copy running-config startup-config**

# 3 Appendix: Default Parameters

Default settings of the MAC Address Table are listed in the following tables.

Table 3-1 Entries in the MAC Address Table

| Parameter                 | Default Setting |
|---------------------------|-----------------|
| Static Address Entries    | None            |
| Dynamic Address Entries   | Auto-learning   |
| Filtering Address Entries | None            |

Table 3-2 Default Settings of Dynamic Address Table

| Parameter  | Default Setting |
|------------|-----------------|
| Auto Aging | Enabled         |
| Aging Time | 300 seconds     |

# Part 6

## Configuring 802.1Q VLAN

### CHAPTERS

1. Overview
2. 802.1Q VLAN Configuration
3. Configuration Example
4. Appendix: Default Parameters

# 1 Overview

VLAN (Virtual Local Area Network) is a network technique that solves broadcasting issues in local area networks. It is usually applied in the following occasions:

- To restrict broadcast domain: VLAN technique divides a big local area network into several VLANs, and all VLAN traffic remains within its VLAN. It reduces the influence of broadcast traffic in Layer 2 network to the whole network.
- To enhance network security: Devices from different VLANs cannot achieve Layer 2 communication, and thus users can group and isolate devices to enhance network security.
- For easier management: VLANs group devices logically instead of physically, so devices in the same VLAN need not be located in the same place. It eases the management of devices in the same work group but located in different places.

# 2 802.1Q VLAN Configuration

To complete 802.1Q VLAN configuration, follow these steps:

- 1) Configure the VLAN, including creating a VLAN and adding the desired ports to the VLAN.
- 2) Configure port parameters for 802.1Q VLAN.

## 2.1 Using the GUI

### 2.1.1 Configuring the VLAN

Choose the menu **L2 FEATURES > VLAN > 802.1Q VLAN > VLAN Config** and click  Add to load the following page.

Figure 2-1 Configuring VLAN

Follow these steps to configure VLAN:

- 1) Enter a VLAN ID and a description for identification to create a VLAN.

|                  |  |
|------------------|--|
| <b>VLAN ID</b>   | Enter a VLAN ID for identification with the values between 2 and 4094. |
| <b>VLAN Name</b> | Give a VLAN description for identification with up to 16 characters.   |

- 2) Select the untagged port(s) and the tagged port(s) respectively to add to the created VLAN based on the network topology.



|               |  |
|---------------|--|
| Untagged port | The selected ports will forward untagged packets in the target VLAN. |
| Tagged port   | The selected ports will forward tagged packets in the target VLAN.   |

3) Click **Apply**.

## 2.1.2 Configuring the Port Parameters for 802.1Q VLAN

Choose the menu **L2 FEATURES > VLAN > 802.1Q VLAN > Port Config** to load the following page.

Figure 2-1 Configuring the Port

| Port Config                         |        |      |                  |                        |     |                         |
|-------------------------------------|--------|------|------------------|------------------------|-----|-------------------------|
| UNIT1                               |        | LAGS |                  |                        |     |                         |
| <input type="checkbox"/>            | Port   | PVID | Ingress Checking | Acceptable Frame Types | LAG | Details                 |
| <input checked="" type="checkbox"/> | 1/0/1  | 1    | Enabled          | Admit All              | --- | <a href="#">Details</a> |
| <input type="checkbox"/>            | 1/0/2  | 1    | Enabled          | Admit All              | --- | <a href="#">Details</a> |
| <input type="checkbox"/>            | 1/0/3  | 1    | Enabled          | Admit All              | --- | <a href="#">Details</a> |
| <input type="checkbox"/>            | 1/0/4  | 1    | Enabled          | Admit All              | --- | <a href="#">Details</a> |
| <input type="checkbox"/>            | 1/0/5  | 1    | Enabled          | Admit All              | --- | <a href="#">Details</a> |
| <input type="checkbox"/>            | 1/0/6  | 1    | Enabled          | Admit All              | --- | <a href="#">Details</a> |
| <input type="checkbox"/>            | 1/0/7  | 1    | Enabled          | Admit All              | --- | <a href="#">Details</a> |
| <input type="checkbox"/>            | 1/0/8  | 1    | Enabled          | Admit All              | --- | <a href="#">Details</a> |
| <input type="checkbox"/>            | 1/0/9  | 1    | Enabled          | Admit All              | --- | <a href="#">Details</a> |
| <input type="checkbox"/>            | 1/0/10 | 1    | Enabled          | Admit All              | --- | <a href="#">Details</a> |

Total: 28      1 entry selected.      Cancel Apply

Select a port and configure the parameters. Click **Apply**.

**PVID** Set the default VLAN ID of the port. Valid values are from 1 to 4094. It is used mainly in the following two ways:

When the port receives an untagged packet, the switch inserts a VLAN tag to the packet based on the PVID.

**Ingress Checking** Enable or disable Ingress Checking. With this function enabled, the port will accept the packet of which the VLAN ID is in the port's VLAN list and discard others. With this function disabled, the port will forward the packet directly.

**Acceptable Frame Types** Select the acceptable frame type for the port and the port will perform this operation before Ingress Checking.

**Admit All:** The port will accept both the tagged packets and the untagged packets.

**Tagged Only:** The port will accept the tagged packets only.

---

|         |   |
|---------|---|
| LAG     | Displays the LAG (Link Aggregation Group) which the port belongs to.  |
| Details | Click the Details button to view the VLANs to which the port belongs. |

---

## 2.2 Using the CLI

### 2.2.1 Creating a VLAN

Follow these steps to create a VLAN:

---

|        |  |
|--------|--|
| Step 1 | <b>configure</b><br>Enter global configuration mode.   |
| Step 2 | <b>vlan <i>vlan-list</i></b><br>When you enter a new VLAN ID, the switch creates a new VLAN and enters VLAN configuration mode; when you enter an existing VLAN ID, the switch directly enters VLAN configuration mode.<br><i>vlan-list</i> : Specify the ID or the ID list of the VLAN(s) for configuration. Valid values are from 2 to 4094, for example, 2-3,5. |
| Step 3 | <b>name <i>descript</i></b><br>(Optional) Specify a VLAN description for identification.<br><i>descript</i> : The length of the description should be 1 to 16 characters.  |
| Step 4 | <b>show vlan [ id <i>vlan-list</i> ]</b><br>Show the global information of the specified VLAN(s). When no VLAN is specified, this command shows global information of all 802.1Q VLANs.<br><i>vlan-list</i> : Specify the ID or the ID list of the VLAN(s) to show information. Valid values are from 1 to 4094.   |
| Step 5 | <b>end</b><br>Return to privileged EXEC mode.  |
| Step 6 | <b>copy running-config startup-config</b><br>Save the settings in the configuration file.  |

---

The following example shows how to create VLAN 2 and name it as RD :

```
Switch#configure
```

```
Switch(config)#vlan 2
```

```
Switch(config-vlan)#name RD
```

```
Switch(config-vlan)#show vlan id 2
```

| VLAN  | Name  | Status | Ports |
|-------|-------|--------|-------|
| ----- | ----- | -----  | ----- |
| 2     | RD    | active |       |

```
Switch(config-vlan)#end
```

```
Switch#copy running-config startup-config
```

## 2.2.2 Adding the Port to the Specified VLAN

Follow these steps to add the port to the specified VLAN:

|        |  |
|--------|--|
| Step 1 | <b>configure</b><br>Enter global configuration mode.   |
| Step 2 | <b>interface {fastEthernet port   range fastEthernet port-list   gigabitEthernet port   range gigabitEthernet port-list   ten-gigabitEthernet port   range ten-gigabitEthernet port-list   port-channel port-channel-id   range port-channel port-channel-list}</b><br>Enter interface configuration mode. |
| Step 3 | <b>switchport general allowed vlan vlan-list { tagged   untagged }</b><br>Add ports to the specified VLAN.<br><i>vlan-list</i> : Specify the ID or ID list of the VLAN(s) that the port will be added to. The ID ranges from 1 to 4094.<br><i>tagged   untagged</i> : Select the egress rule for the port. |
| Step 4 | <b>show interface switchport [fastEthernet port   gigabitEthernet port   ten-gigabitEthernet port   port-channel lag-id]</b><br>Verify the information of the port.  |
| Step 5 | <b>end</b><br>Return to privileged EXEC mode.  |
| Step 6 | <b>copy running-config startup-config</b><br>Save the settings in the configuration file.  |

The following example shows how to add the port 1/0/5 to VLAN 2, and specify its egress rule as tagged:

```
Switch#configure
```

```
Switch(config)#interface gigabitEthernet 1/0/5
```

```
Switch(config-if)#switchport general allowed vlan 2 tagged
```

```
Switch(config-if)#show interface switchport gigabitEthernet 1/0/5
```

```
Port Gi1/0/5:
```

```
PVID: 2
```

Acceptable frame type: All

Ingress Checking: Enable

Member in LAG: N/A

Link Type: General

Member in VLAN:

| Vlan | Name        | Egress-rule |
|------|-------------|-------------|
| ---- | -----       | -----       |
| 1    | System-VLAN | Untagged    |
| 2    | RD          | Tagged      |

**Switch(config-if)#end**

**Switch#copy running-config startup-config**

## 2.2.3 Configuring the Port

Follow these steps to configure the port:

|        |  |
|--------|--|
| Step 1 | <b>configure</b><br>Enter global configuration mode.   |
| Step 2 | <b>interface {fastEthernet port   range fastEthernet port-list   gigabitEthernet port   range gigabitEthernet port-list   ten-gigabitEthernet port   range ten-gigabitEthernet port-list   port-channel port-channel-id   range port-channel port-channel-list}</b><br>Enter interface configuration mode.                   |
| Step 3 | <b>switchport pvid vlan-id</b><br>Configure the PVID of the port(s). By default, it is 1.<br><i>vlan-id</i> : The default VLAN ID of the port with the values between 1 and 4094.  |
| Step 4 | <b>switchport check ingress</b><br>Enable or disable Ingress Checking. With this function enabled, the port will accept the packet of which the VLAN ID is in the port's VLAN list and discard others. With this function disabled, the port will forward the packet directly.   |
| Step 5 | <b>switchport acceptable frame {all   tagged}</b><br>Select the acceptable frame type for the port and the port will perform this operation before Ingress Checking.<br><i>all</i> : The port will accept both the tagged packets and the untagged packets.<br><i>tagged</i> : The port will accept the tagged packets only. |
| Step 6 | <b>end</b><br>Return to privileged EXEC mode.  |
| Step 7 | <b>copy running-config startup-config</b><br>Save the settings in the configuration file.  |

The following example shows how to configure the PVID of port 1/0/5 as 2, enable the ingress checking and set the acceptable frame type as all:

```
Switch#configure
```

```
Switch(config)#interface gigabitEthernet 1/0/5
```

```
Switch(config-if)#switchport pvid 2
```

```
Switch(config-if)#switchport check ingress
```

```
Switch(config-if)#switchport acceptable frame all
```

```
Switch(config-if)#show interface switchport gigabitEthernet 1/0/5
```

```
Port Gi1/0/5:
```

```
PVID: 2
```

```
Acceptable frame type: All
```

```
Ingress Checking: Enable
```

```
Member in LAG: N/A
```

```
Link Type: General
```

```
Member in VLAN:
```

```
Vlan   Name           Egress-rule
```

```
----   -
```

```
1      System-VLAN  Untagged
```

```
Switch(config-if)#end
```

```
Switch#copy running-config startup-config
```

# 3 Configuration Example

## 3.1 Network Requirements

- Offices of Department A and Department B in the company are located in different places, and some computers in different offices connect to the same switch.
- It is required that computers can communicate with each other in the same department but not with computers in the other department.

## 3.2 Configuration Scheme

- Divide computers in Department A and Department B into two VLANs respectively so that computers can communicate with each other in the same department but not with computers in the other department.
- Terminal devices like computers usually do not support VLAN tags. Add untagged ports to the corresponding VLANs and specify the PVID.
- The intermediate link between two switches carries traffic from two VLANs simultaneously. Add the tagged ports to both VLANs.

### 3.3 Network Topology

The figure below shows the network topology. Host A1 and Host A2 are in Department A, while Host B1 and Host B2 are in Department B. Switch 1 and Switch 2 are located in two different places. Host A1 and Host B1 are connected to port 1/0/2 and port 1/0/3 on Switch 1 respectively, while Host A2 and Host B2 are connected to port 1/0/6 and port 1/0/7 on Switch 2 respectively. Port 1/0/4 on Switch 1 is connected to port 1/0/8 on Switch 2.

Figure 3-1 Network Topology

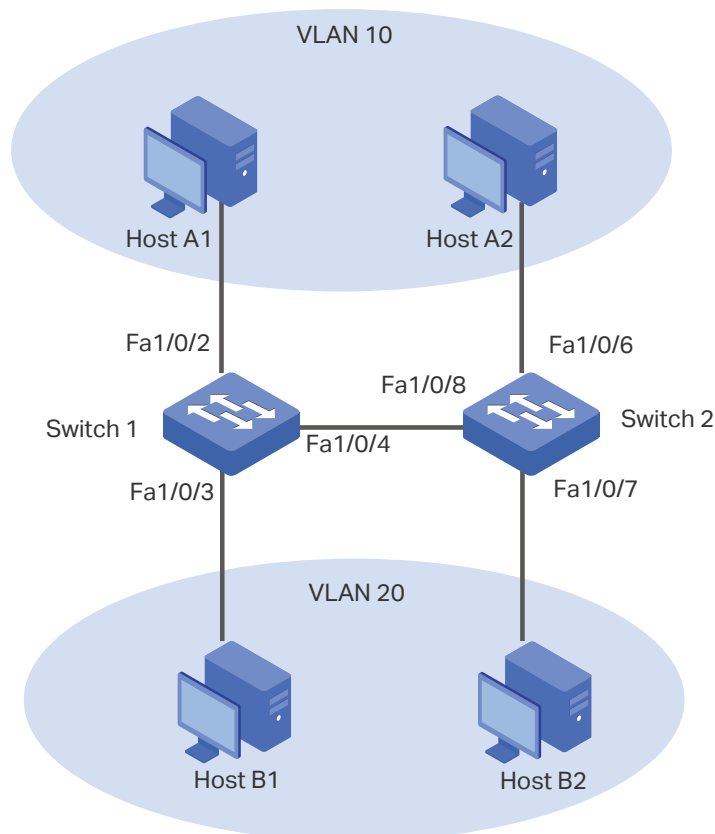

Demonstrated with T1500-28PCT, the following sections provide configuration procedure in two ways: using the GUI and using the CLI.

### 3.4 Using the GUI

The configurations of Switch 1 and Switch 2 are similar. The following introductions take Switch 1 as an example.

- 1) Choose the menu **L2 FEATURES > VLAN > 802.1Q VLAN > VLAN Config** and click **+ Add** to load the following page. Create VLAN 10 with the description of Department\_A. Add port 1/0/2 as an untagged port and port 1/0/4 as a tagged port to VLAN 10. Click **Create**.

Figure 3-2 Creating VLAN 10 for Department A

### VLAN Config

VLAN ID:  (2-4094, format: 2,4-5,8)

VLAN Name:  (1-16 characters)

Untagged Ports

Port:  (Format: 1/0/1, input or choose below)

UNIT1
LAGS

Select All

2

4

6

8

10

12

14

16

18

20

22

24

26

28

1

3

5

7

9

11

13

15

17

19

21

23

25

27

Selected

Unselected

Not Available

Tagged Ports

Port:  (Format: 1/0/1, input or choose below)

UNIT1
LAGS

Select All

2

4

6

8

10

12

14

16

18

20

22

24

26

28

1

3

5

7

9

11

13

15

17

19

21

23

25

27

Selected

Unselected

Not Available

- 2) Choose the menu **L2 FEATURES > VLAN > 802.1Q VLAN > VLAN Config** and click **+ Add** to load the following page. Create VLAN 20 with the description of Department\_B. Add port 1/0/3 as an untagged port and port 1/0/4 as a tagged port to VLAN 20. Click **Create**.



Figure 3-3 Creating VLAN 20 for Department B

VLAN Config

VLAN ID:  (2-4094, format: 2,4-5,8)

VLAN Name:  (1-16 characters)

Untagged Ports

---

Port:  (Format: 1/0/1, input or choose below)

UNIT1
LAGS

Select All

2

4

6

8

10

12

14

16

18

20

22

24

26

28

1

3

5

7

9

11

13

15

17

19

21

23

25

27

Selected

Unselected

Not Available

Tagged Ports

---

Port:  (Format: 1/0/1, input or choose below)

UNIT1
LAGS

Select All

2

4

6

8

10

12

14

16

18

20

22

24

26

28

1

3

5

7

9

11

13

15

17

19

21

23

25

27

Selected

Unselected

Not Available

Cancel

Create

- 3) Choose the menu **L2 FEATURES > VLAN > 802.1Q VLAN > Port Config** to load the following page. Set the PVID of port 1/0/2 as 10 and click **Apply**. Set the PVID of port 1/0/3 as 20 and click **Apply**.

Figure 3-4 Specifying the PVID for the ports

Port Config

UNIT1 LAGS

| <input type="checkbox"/>            | Port   | PVID | Ingress Checking | Acceptable Frame Types | LAG | Details                 |
|-------------------------------------|--------|------|------------------|------------------------|-----|-------------------------|
|                                     |        | 20   |                  |                        |     |                         |
| <input type="checkbox"/>            | 1/0/1  | 1    | Enabled          | Admit All              | --- | <a href="#">Details</a> |
| <input type="checkbox"/>            | 1/0/2  | 10   | Enabled          | Admit All              | --- | <a href="#">Details</a> |
| <input checked="" type="checkbox"/> | 1/0/3  | 20   | Enabled          | Admit All              | --- | <a href="#">Details</a> |
| <input type="checkbox"/>            | 1/0/4  | 1    | Enabled          | Admit All              | --- | <a href="#">Details</a> |
| <input type="checkbox"/>            | 1/0/5  | 1    | Enabled          | Admit All              | --- | <a href="#">Details</a> |
| <input type="checkbox"/>            | 1/0/6  | 1    | Enabled          | Admit All              | --- | <a href="#">Details</a> |
| <input type="checkbox"/>            | 1/0/7  | 1    | Enabled          | Admit All              | --- | <a href="#">Details</a> |
| <input type="checkbox"/>            | 1/0/8  | 1    | Enabled          | Admit All              | --- | <a href="#">Details</a> |
| <input type="checkbox"/>            | 1/0/9  | 1    | Enabled          | Admit All              | --- | <a href="#">Details</a> |
| <input type="checkbox"/>            | 1/0/10 | 1    | Enabled          | Admit All              | --- | <a href="#">Details</a> |

Total: 28 1 entry selected.

Cancel Apply

- 4) Click  Save to save the settings.

## 3.5 Using the CLI

The configurations of Switch 1 and Switch 2 are similar. The following introductions take Switch 1 as an example.

- 1) Create VLAN 10 for Department A, and configure the description as Department-A. Similarly, create VLAN 20 for Department B, and configure the description as Department-B.

```
Switch_1#configure
```

```
Switch_1(config)#vlan 10
```

```
Switch_1(config-vlan)#name Department-A
```

```
Switch_1(config-vlan)#exit
```

```
Switch_1(config)#vlan 20
```

```
Switch_1(config-vlan)#name Department-B
```

```
Switch_1(config-vlan)#exit
```

- 2) Add untagged port 1/0/2 and tagged port 1/0/4 to VLAN 10. Add untagged port 1/0/3 and tagged port 1/0/4 to VLAN 20.

```
Switch_1(config)#interface fastEthernet 1/0/2
```

```
Switch_1(config-if)#switchport general allowed vlan 10 untagged
```

```
Switch_1(config-if)#exit
```

```
Switch_1(config)#interface fastEthernet 1/0/3
Switch_1(config-if)#switchport general allowed vlan 20 untagged
Switch_1(config-if)#exit
Switch_1(config)#interface fastEthernet 1/0/4
Switch_1(config-if)#switchport general allowed vlan 10 tagged
Switch_1(config-if)#switchport general allowed vlan 20 tagged
Switch_1(config-if)#exit
```

- 3) Set the PVID of port 1/0/2 as 10, and set the PVID of port 1/0/3 as 20.

```
Switch_1(config)#interface fastEthernet 1/0/2
Switch_1(config-if)#switchport pvid 10
Switch_1(config-if)#exit
Switch_1(config)#interface fastEthernet 1/0/3
Switch_1(config-if)#switchport pvid 20
Switch_1(config-if)#end
Switch_1#copy running-config startup-config
```

## Verify the Configurations

Verify the VLAN configuration:

```
Switch_1#show vlan
```

| VLAN | Name         | Status | Ports   |
|------|--------------|--------|---|
| 1    | System-VLAN  | active | Fa1/0/1, Fa1/0/2, Fa1/0/3, Fa1/0/4,<br>Fa1/0/5, Fa1/0/6, Fa1/0/7, Fa1/0/8,<br>Fa1/0/9, Fa1/0/10, Fa1/0/11, Fa1/0/12,<br>Fa1/0/13, Fa1/0/14, Fa1/0/15, Fa1/0/16,<br>Fa1/0/17, Fa1/0/18, Fa1/0/19, Fa1/0/20,<br>Fa1/0/21, Fa1/0/22, Fa1/0/23, Fa1/0/24,<br>Gi1/0/25, Gi1/0/26, Gi1/0/27, Gi1/0/28 |
| 10   | Department-A | active | Fa1/0/2, Fa1/0/4  |
| 20   | Department-B | active | Fa1/0/3, Fa1/0/4  |

Verify the VLAN configuration:

```
Switch_1(config)#show interface switchport
```

| Port    | LAG | Type    | PVID | Acceptable frame type | Ingress Checking |
|---------|-----|---------|------|-----------------------|------------------|
| -----   | --- | ----    | ---- | -----                 | -----            |
| Fa1/0/1 | N/A | General | 1    | All                   | Enable           |
| Fa1/0/2 | N/A | General | 10   | All                   | Enable           |
| Fa1/0/3 | N/A | General | 20   | All                   | Enable           |
| Fa1/0/4 | N/A | General | 1    | All                   | Enable           |
| Fa1/0/5 | N/A | General | 1    | All                   | Enable           |
| .....   |     |         |      |                       |                  |

# 4 Appendix: Default Parameters

Default settings of 802.1Q VLAN are listed in the following table.

Table 4-1 Default Settings of 802.1Q VLAN

| Parameter              | Default Setting |
|------------------------|-----------------|
| VLAN ID                | 1               |
| PVID                   | 1               |
| Ingress Checking       | Enabled         |
| Acceptable Frame Types | Admit All       |

# Part 7

## Configuring MAC VLAN

### CHAPTERS

1. Overview
2. MAC VLAN Configuration
3. Configuration Example
4. Appendix: Default Parameters

# 1 Overview

VLAN is generally divided by ports. It is a common way of division but isn't suitable for those networks that require frequent topology changes. With the popularity of mobile office, at different times a terminal device may access the network via different ports. For example, a terminal device that accessed the switch via port 1 last time may change to port 2 this time. If port 1 and port 2 belong to different VLANs, the user has to re-configure the switch to access the original VLAN. Using MAC VLAN can free the user from such a problem. It divides VLANs based on the MAC addresses of terminal devices. In this way, terminal devices always belong to their MAC VLANs even when their access ports change.

The figure below shows a common application scenario of MAC VLAN.

Figure 1-1 Common Application Scenario of MAC VLAN

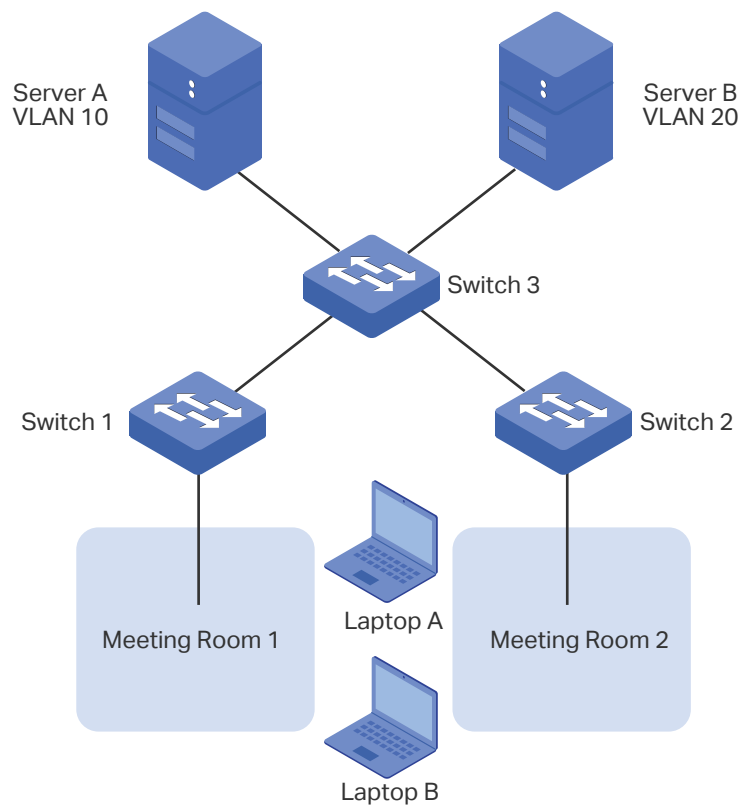

Two departments share all the meeting rooms in the company, but use different servers and laptops. Department A uses Server A and Laptop A, while Department B uses Server B and Laptop B. Server A is in VLAN 10 while Server B is in VLAN 20. It is required that Laptop A can only access Server A and Laptop B can only access Server B, no matter which meeting room the laptops are being used in. To meet this requirement, simply bind the MAC addresses of the laptops to the corresponding VLANs respectively. In this way, the MAC address determines the VLAN each laptop joins. Each laptop can access only the server in the VLAN it joins.

# 2 MAC VLAN Configuration

To complete MAC VLAN configuration, follow these steps:

- 1) Configure 802.1Q VLAN.
- 2) Bind the MAC address to the VLAN.
- 3) Enable MAC VLAN for the port.

## Configuration Guidelines

When a port in a MAC VLAN receives an untagged data packet, the switch will first check whether the source MAC address of the data packet has been bound to the MAC VLAN. If yes, the switch will insert the corresponding tag to the data packet and forward it within the VLAN. If no, the switch will continue to match the data packet with the matching rules of other VLANs (such as the protocol VLAN). If there is a match, the switch will forward the data packet. Otherwise, the switch will process the data packet according to the processing rule of the 802.1 Q VLAN. When the port receives a tagged data packet, the switch will directly process the data packet according to the processing rule of the 802.1 Q VLAN.

## 2.1 Using the GUI

### 2.1.1 Configuring 802.1Q VLAN

Before configuring MAC VLAN, create an 802.1Q VLAN and set the port type according to network requirements. For details, refer to [Configuring 802.1Q VLAN](#).

### 2.1.2 Binding the MAC Address to the VLAN

Choose the menu **L2 FEATURES > VLAN > MAC VLAN** and click  **Add** to load the following page.

Figure 2-1 Creating MAC VLAN

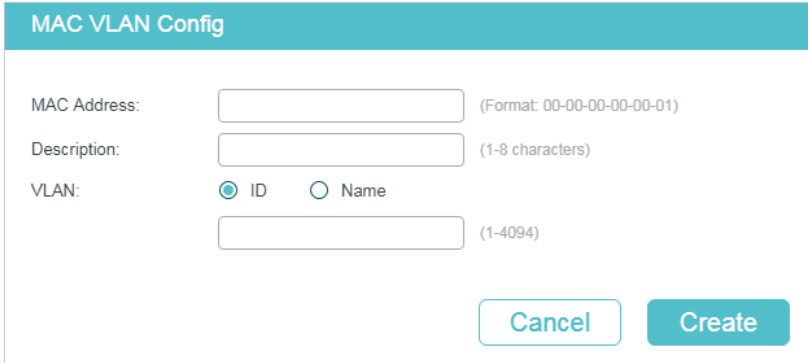

MAC VLAN Config

MAC Address:  (Format: 00-00-00-00-00-01)

Description:  (1-8 characters)

VLAN:  ID  Name  (1-4094)

Follow these steps to bind the MAC address to the 802.1Q VLAN:



- 1) Enter the MAC address of the device, give it a description, and enter the VLAN ID to bind it to the VLAN.

|              |   |
|--------------|---|
| MAC Address  | Enter the MAC address of the device in the format of 00-00-00-00-00-01.             |
| Description  | Give a MAC address description for identification with up to 8 characters.          |
| VLAN ID/Name | Enter the ID number or name of the 802.1Q VLAN that will be bound to the MAC VLAN.. |

- 2) Click **Create**.

 **Note:**

One MAC address can be bound to only one VLAN.

### 2.1.3 Enabling MAC VLAN for the Port

By default, MAC VLAN is disabled on all ports. You need to enable MAC VLAN for your desired ports manually.

Choose the menu **L2 FEATURES > VLAN > MAC VLAN** to load the following page.

Figure 2-2 Enabling MAC VLAN for the Port

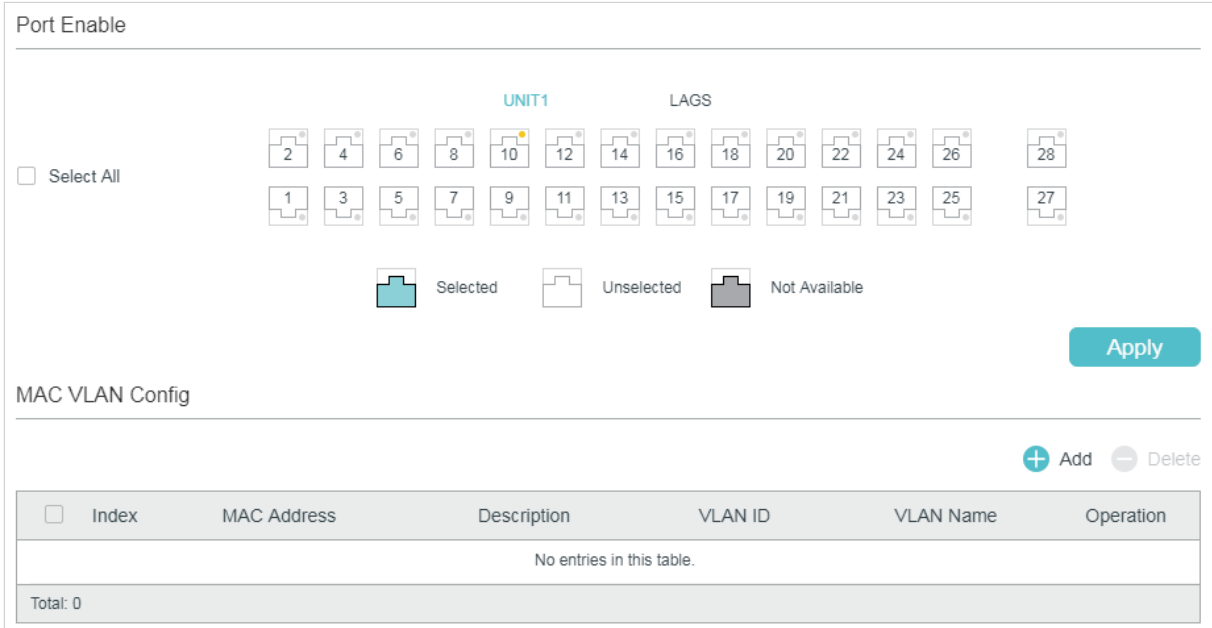



**Port Enable**

Select All

UNIT1      LAGS



2 4 6 8 10 12 14 16 18 20 22 24 26 28

1 3 5 7 9 11 13 15 17 19 21 23 25 27

 Selected     Unselected     Not Available

**Apply**

**MAC VLAN Config**

 Add     Delete

| <input type="checkbox"/>  | Index | MAC Address | Description | VLAN ID | VLAN Name | Operation |
|---------------------------|-------|-------------|-------------|---------|-----------|-----------|
| No entries in this table. |       |             |             |         |           |           |
| Total: 0                  |       |             |             |         |           |           |

In the **Port Enable** section, select the desired ports to enable MAC VLAN, and click **Apply**.

 **Note:**

The member port of an LAG (Link Aggregation Group) follows the configuration of the LAG and not its own. The configurations of the port can take effect only after it leaves the LAG.

## 2.2 Using the CLI

### 2.2.1 Configuring 802.1Q VLAN

Before configuring MAC VLAN, create an 802.1Q VLAN and set the port type according to network requirements. For details, refer to [Configuring 802.1Q VLAN](#).

### 2.2.2 Binding the MAC Address to the VLAN

Follow these steps to bind the MAC address to the VLAN:

|        |   |
|--------|---|
| Step 1 | <b>configure</b><br>Enter global configuration mode.  |
| Step 2 | <b>mac-vlan mac-address mac-addr vlan vlan-id [description descript]</b><br>Bind the MAC address to the VLAN.<br><br><i>mac-addr</i> : Specify the MAC address of the device in the format of xx:xx:xx:xx:xx:xx.<br><i>vlan-id</i> : Enter the ID number of the 802.1Q VLAN that will be bound to the MAC VLAN.<br><i>descript</i> : Specify the MAC address description for identification, with up to 8 characters. |
| Step 3 | <b>show mac-vlan { all   mac-address mac-addr   vlan vlan-id }</b><br>Verify the configuration of MAC VLAN.<br><br><i>vid</i> : Specify the MAC VLAN to be displayed.   |
| Step 4 | <b>end</b><br>Return to privileged EXEC mode.   |
| Step 5 | <b>copy running-config startup-config</b><br>Save the settings in the configuration file.   |

The following example shows how to bind the MAC address 00:19:56:8A:4C:71 to VLAN 10, with the address description as Dept.A.

**Switch#configure**

**Switch(config)#mac-vlan mac-address 00:19:56:8a:4c:71 vlan 10 description Dept.A**

**Switch(config)#show mac-vlan vlan 10**

| MAC-Addr          | Name   | VLAN-ID |
|-------------------|--------|---------|
| -----             | -----  | -----   |
| 00:19:56:8A:4C:71 | Dept.A | 10      |

**Switch(config)#end**

**Switch#copy running-config startup-config**

## 2.2.3 Enabling MAC VLAN for the Port

Follow these steps to enable MAC VLAN for the port:

|        |  |
|--------|--|
| Step 1 | <b>configure</b><br>Enter global configuration mode.   |
| Step 2 | <b>interface {fastEthernet port   range fastEthernet port-list   gigabitEthernet port   range gigabitEthernet port-list   ten-gigabitEthernet port   range ten-gigabitEthernet port-list   port-channel port-channel-id   range port-channel port-channel-list}</b><br>Enter interface configuration mode. |
| Step 3 | <b>mac-vlan</b><br>Enable MAC VLAN for the port.   |
| Step 4 | <b>show mac-vlan interface</b><br>Verify the configuration of MAC VLAN on each interface.  |
| Step 5 | <b>end</b><br>Return to privileged EXEC mode.  |
| Step 6 | <b>copy running-config startup-config</b><br>Save the settings in the configuration file.  |

The following example shows how to enable MAC VLAN for port 1/0/1.

**Switch#configure**

**Switch(config)#interface gigabitEthernet 1/0/1**

**Switch(config-if)#mac-vlan**

**Switch(config-if)#show mac-vlan interface**

Port    STATUS

-----

Gi1/0/1    Enable

Gi1/0/2    Disable

...

**Switch(config-if)#end**

**Switch#copy running-config startup-config**

# 3 Configuration Example

## 3.1 Network Requirements

Two departments share all the meeting rooms in the company, but use different servers and laptops. Department A uses Server A and Laptop A, while Department B uses Server B and Laptop B. Server A is in VLAN 10 while Server B is in VLAN 20. It is required that Laptop A can only access Server A and Laptop B can only access Server B, no matter which meeting room the laptops are being used in. The figure below shows the network topology.

Figure 3-1 Network Topology

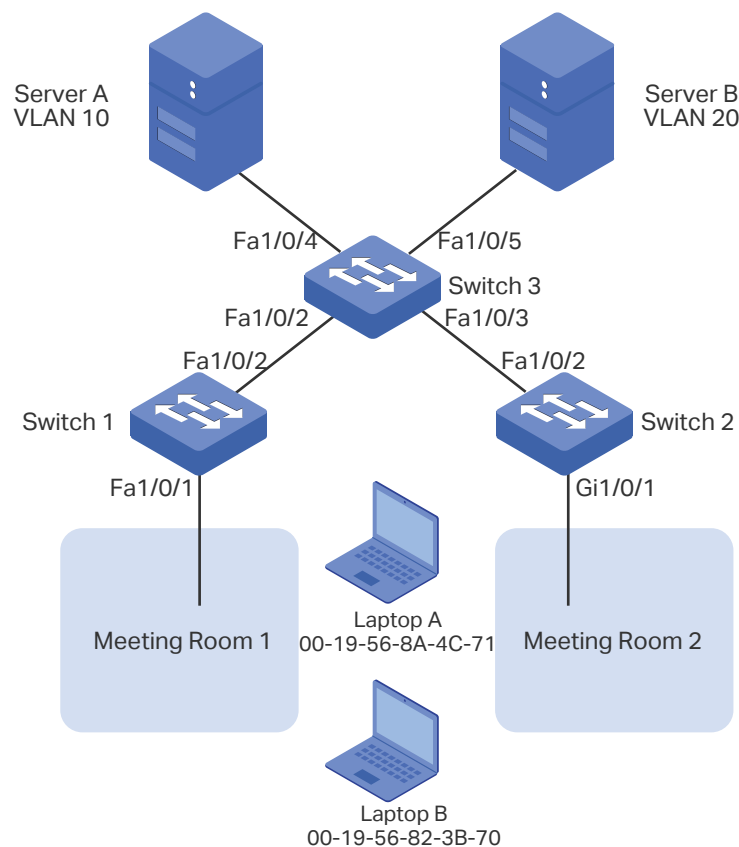

## 3.2 Configuration Scheme

You can configure MAC VLAN to meet this requirement. On Switch 1 and Switch 2, bind the MAC addresses of the laptops to the corresponding VLANs respectively. In this way, each laptop can access only the server in the VLAN it joins, no matter which meeting room the laptops are being used in. The overview of the configuration is as follows:

- 1) Create VLAN 10 and VLAN 20 on each of the three switches and add the ports to the VLANs based on the network topology. For the ports connecting the laptops, set the

egress rule as Untagged; for the ports connecting to other switch, set the egress rule as Tagged.

- 2) On Switch 1 and Switch 2, bind the MAC addresses of the laptops to their corresponding VLANs, and enable MAC VLAN for the ports.

Demonstrated with T1500-28PCT, the following sections provide configuration procedure in two ways: using the GUI and using the CLI.

### 3.3 Using the GUI

#### ■ Configurations for Switch 1 and Switch 2

The configurations of Switch 1 and Switch 2 are similar. The following introductions take Switch 1 as an example.

- 1) Choose the menu **L2 FEATURES > VLAN > 802.1Q VLAN > VLAN Config** and click  **Add** to load the following page. Create VLAN 10, and add untagged port 1/0/1 and tagged port 1/0/2 to VLAN 10. Click **Create**.

Figure 3-2 Creating VLAN 10

**VLAN Config**

VLAN ID:  (2-4094, format: 2,4-5,8)

VLAN Name:  (1-16 characters)

Untagged Ports

Port:  (Format: 1/0/1, input or choose below)

Select All

UNIT1 LAGS

|   |   |   |   |    |    |    |    |    |    |    |    |    |    |
|---|---|---|---|----|----|----|----|----|----|----|----|----|----|
| 2 | 4 | 6 | 8 | 10 | 12 | 14 | 16 | 18 | 20 | 22 | 24 | 26 | 28 |
| 1 | 3 | 5 | 7 | 9  | 11 | 13 | 15 | 17 | 19 | 21 | 23 | 25 | 27 |

Selected Unselected Not Available

Tagged Ports

Port:  (Format: 1/0/1, input or choose below)

Select All

UNIT1 LAGS

|   |   |   |   |    |    |    |    |    |    |    |    |    |    |
|---|---|---|---|----|----|----|----|----|----|----|----|----|----|
| 2 | 4 | 6 | 8 | 10 | 12 | 14 | 16 | 18 | 20 | 22 | 24 | 26 | 28 |
| 1 | 3 | 5 | 7 | 9  | 11 | 13 | 15 | 17 | 19 | 21 | 23 | 25 | 27 |

Selected Unselected Not Available

- 2) Choose the menu **L2 FEATURES > VLAN > 802.1Q VLAN > VLAN Config** and click **+ Add** to load the following page. Create VLAN 20, and add untagged port 1/0/1 and tagged port 1/0/2 to VLAN 20. Click **Create**.

Figure 3-3 Creating VLAN 20

**VLAN Config**

VLAN ID:  (2-4094, format: 2,4-5,8)

VLAN Name:  (1-16 characters)

Untagged Ports

Port:  (Format: 1/0/1, input or choose below)

Select All

UNIT1 LAGS

2 4 6 8 10 12 14 16 18 20 22 24 26 28

1 3 5 7 9 11 13 15 17 19 21 23 25 27

Selected  Unselected  Not Available

Tagged Ports

Port:  (Format: 1/0/1, input or choose below)

Select All

UNIT1 LAGS

2 4 6 8 10 12 14 16 18 20 22 24 26 28

1 3 5 7 9 11 13 15 17 19 21 23 25 27

Selected  Unselected  Not Available

- 3) Choose the menu **L2 FEATURES > VLAN > MAC VLAN** and click **+** Add to load the following page. Specify the corresponding parameters and click **Create** to bind the MAC address of Laptop A to VLAN 10 and bind the MAC address of Laptop B to VLAN 20.

Figure 3-4 Creating MAC VLAN

**MAC VLAN Config**

MAC Address:  (Format: 00-00-00-00-00-01)

Description:  (1-8 characters)

VLAN:  ID  Name

(1-4094)

- 4) Choose the menu **L2 FEATURES > VLAN > MAC VLAN** to load the following page. In the **Port Enable** section select port 1/0/1 and click **Apply** to enable MAC VLAN.

Figure 3-5 Enabling MAC VLAN for the Port



Port Enable

Select All

UNIT1 LAGS

2 4 6 8 10 12 14 16 18 20 22 24 26 28





1 3 5 7 9 11 13 15 17 19 21 23 25 27

 Selected  Unselected  Not Available

**Apply**

MAC VLAN Config

[+](#) Add [-](#) Delete

| <input type="checkbox"/> | Index | MAC Address       | Description | VLAN ID | VLAN Name    | Operation   |
|--------------------------|-------|-------------------|-------------|---------|--------------|---|
| <input type="checkbox"/> | 1     | 00-19-56-8a-4c-71 | PCA         | 10      | Department_A |   |
| <input type="checkbox"/> | 2     | 00-19-56-82-3b-70 | PCB         | 20      | Department_B |   |

Total: 2

5) Click  Save to save the settings.

### ■ Configurations for Switch 3

- 1) Choose the menu **L2 FEATURES > VLAN > 802.1Q VLAN > VLAN Config** and click  Add to load the following page. Create VLAN 10, and add untagged port 1/0/4 and tagged ports 1/0/2-3 to VLAN 10. Click **Create**.



Figure 3-6 Creating VLAN 10

VLAN Config

VLAN ID:  (2-4094, format: 2,4-5,8)

VLAN Name:  (1-16 characters)

---

Untagged Ports

Port:  (Format: 1/0/1, input or choose below)

UNIT1
LAGS

Select All

2

4

6

8

10

12

14

16

18

20

22

24

26

28

1

3

5

7

9

11

13

15

17

19

21

23

25

27

Selected

Unselected

Not Available

---

Tagged Ports

Port:  (Format: 1/0/1, input or choose below)

UNIT1
LAGS

Select All

2

4

6

8

10

12

14

16

18

20

22

24

26

28

1

3

5

7

9

11

13

15

17

19

21

23

25

27

Selected

Unselected

Not Available

Cancel

Create

- 2) Click **Create** to load the following page. Create VLAN 20, and add untagged port 1/0/5 and tagged ports 1/0/2-3 to VLAN 20. Click **Create**.

Figure 3-7 Creating VLAN 20

VLAN Config

VLAN ID:  (2-4094, format: 2,4-5,8)

VLAN Name:  (1-16 characters)

Untagged Ports

Port:  (Format: 1/0/1, input or choose below)

UNIT1
LAGS

|                                     |                          |                          |                          |                          |                          |                          |                          |                          |                          |                          |                          |                          |                          |                          |                          |                          |                                     |   |   |    |    |    |    |    |    |    |    |    |
|-------------------------------------|--------------------------|--------------------------|--------------------------|--------------------------|--------------------------|--------------------------|--------------------------|--------------------------|--------------------------|--------------------------|--------------------------|--------------------------|--------------------------|--------------------------|--------------------------|--------------------------|-------------------------------------|---|---|----|----|----|----|----|----|----|----|----|
| <input type="checkbox"/> Select All | <input type="checkbox"/> | <input type="checkbox"/> | <input type="checkbox"/> | <input type="checkbox"/> | <input type="checkbox"/> | <input type="checkbox"/> | <input type="checkbox"/> | <input type="checkbox"/> | <input type="checkbox"/> | <input type="checkbox"/> | <input type="checkbox"/> | <input type="checkbox"/> | <input type="checkbox"/> | <input type="checkbox"/> | <input type="checkbox"/> | <input type="checkbox"/> | <input type="checkbox"/>            |   |   |    |    |    |    |    |    |    |    |    |
|                                     | 2                        | 4                        | 6                        | 8                        | 10                       | 12                       | 14                       | 16                       | 18                       | 20                       | 22                       | 24                       | 26                       | 28                       | 1                        | 3                        | <input checked="" type="checkbox"/> | 7 | 9 | 11 | 13 | 15 | 17 | 19 | 21 | 23 | 25 | 27 |

Selected

Unselected

Not Available

Tagged Ports

Port:  (Format: 1/0/1, input or choose below)

UNIT1
LAGS

|                                     |                                     |                                     |                          |                          |                          |                          |                          |                          |                          |                          |                          |                          |                          |                          |                          |                                     |                          |   |   |    |    |    |    |    |    |    |    |    |
|-------------------------------------|-------------------------------------|-------------------------------------|--------------------------|--------------------------|--------------------------|--------------------------|--------------------------|--------------------------|--------------------------|--------------------------|--------------------------|--------------------------|--------------------------|--------------------------|--------------------------|-------------------------------------|--------------------------|---|---|----|----|----|----|----|----|----|----|----|
| <input type="checkbox"/> Select All | <input checked="" type="checkbox"/> | <input checked="" type="checkbox"/> | <input type="checkbox"/> | <input type="checkbox"/> | <input type="checkbox"/> | <input type="checkbox"/> | <input type="checkbox"/> | <input type="checkbox"/> | <input type="checkbox"/> | <input type="checkbox"/> | <input type="checkbox"/> | <input type="checkbox"/> | <input type="checkbox"/> | <input type="checkbox"/> | <input type="checkbox"/> | <input type="checkbox"/>            | <input type="checkbox"/> |   |   |    |    |    |    |    |    |    |    |    |
|                                     | 2                                   | 4                                   | 6                        | 8                        | 10                       | 12                       | 14                       | 16                       | 18                       | 20                       | 22                       | 24                       | 26                       | 28                       | 1                        | <input checked="" type="checkbox"/> | 5                        | 7 | 9 | 11 | 13 | 15 | 17 | 19 | 21 | 23 | 25 | 27 |

Selected

Unselected

Not Available

3) Click  Save to save the settings.

## 3.4 Using the CLI

### ■ Configurations for Switch 1 and Switch 2

The configurations of Switch 1 and Switch 2 are the same. The following introductions take Switch 1 as an example.

1) Create VLAN 10 for Department A and create VLAN 20 for Department B.

```
Switch_1#configure
```

```
Switch_1(config)#vlan 10
```

```
Switch_1(config-vlan)#name deptA
```

```
Switch_1(config-vlan)#exit
```

```
Switch_1(config)#vlan 20
```

```
Switch_1(config-vlan)#name deptB
```

```
Switch_1(config-vlan)#exit
```

- 2) Add tagged port 1/0/2 and untagged port 1/0/1 to both VLAN 10 and VLAN 20. Then enable MAC VLAN on port 1/0/1.

```
Switch_1(config)#interface fastEthernet 1/0/2
```

```
Switch_1(config-if)#switchport general allowed vlan 10,20 tagged
```

```
Switch_1(config-if)#exit
```

```
Switch_1(config)#interface fastEthernet 1/0/1
```

```
Switch_1(config-if)#switchport general allowed vlan 10,20 untagged
```

```
Switch_1(config-if)#mac-vlan
```

```
Switch_1(config-if)#exit
```

- 3) Bind the MAC address of Laptop A to VLAN 10 and bind the MAC address of Laptop B to VLAN 20.

```
Switch_1(config)#mac-vlan mac-address 00:19:56:8A:4C:71 vlan 10 description PCA
```

```
Switch_1(config)#mac-vlan mac-address 00:19:56:82:3B:70 vlan 20 description PCB
```

```
Switch_1(config)#end
```

```
Switch_1#copy running-config startup-config
```

### ■ Configurations for Switch 3

- 1) Create VLAN 10 for Department A and create VLAN 20 for Department B.

```
Switch_3#configure
```

```
Switch_3(config)#vlan 10
```

```
Switch_3(config-vlan)#name deptA
```

```
Switch_3(config-vlan)#exit
```

```
Switch_3(config)#vlan 20
```

```
Switch_3(config-vlan)#name deptB
```

```
Switch_3(config-vlan)#exit
```

- 2) Add tagged port 1/0/2 and port 1/0/3 to both VLAN 10 and VLAN 20.

```
Switch_3(config)#interface fastEthernet 1/0/2
```

```
Switch_3(config-if)#switchport general allowed vlan 10,20 tagged
```

```
Switch_3(config-if)#exit
```

```
Switch_3(config)#interface fastEthernet 1/0/3
Switch_3(config-if)#switchport general allowed vlan 10,20 tagged
Switch_3(config-if)#exit
```

- 3) Add untagged port 1/0/4 to VLAN 10 and untagged port 1/0/5 to VLAN 20.

```
Switch_3(config)#interface fastEthernet 1/0/4
Switch_3(config-if)#switchport general allowed vlan 10 untagged
Switch_3(config-if)#exit
Switch_3(config)#interface fastEthernet 1/0/5
Switch_3(config-if)#switchport general allowed vlan 20 untagged
Switch_3(config-if)#end
Switch_3#copy running-config startup-config
```

## Verify the Configurations

### ■ Switch 1

```
Switch_1#show mac-vlan all
```

| MAC Add           | Name | VLAN-ID |
|-------------------|------|---------|
| 00:19:56:8A:4C:71 | PCA  | 10      |
| 00:19:56:82:3B:70 | PCB  | 20      |

### ■ Switch 2

```
Switch_2#show mac-vlan all
```

| MAC Address       | Description | VLAN |
|-------------------|-------------|------|
| 00:19:56:8A:4C:71 | PCA         | 10   |
| 00:19:56:82:3B:70 | PCB         | 20   |

### ■ Switch 3

```
Switch_3#show vlan
```

| VLAN  | Name        | Status | Ports  |
|-------|-------------|--------|--|
| ----- | -----       | -----  | -----  |
| 1     | System-VLAN | active | Fa1/0/1, Fa1/0/2, Fa1/0/3, Fa1/0/4,<br>Fa1/0/5, Fa1/0/6, Fa1/0/7, Fa1/0/8<br>... |
| 10    | DeptA       | active | Fa1/0/2, Fa1/0/3, Fa1/0/4  |
| 20    | DeptB       | active | Fa1/0/2, Fa1/0/3, Fa1/0/5  |

# 4 Appendix: Default Parameters

Default settings of MAC VLAN are listed in the following table.

Table 4-1 Default Settings of MAC VLAN

| Parameter   | Default Setting |
|-------------|-----------------|
| MAC Address | None            |
| Description | None            |
| VLAN ID     | None            |
| Port Enable | Disabled        |

# Part 8

## Configuring Protocol VLAN

### CHAPTERS

1. Overview
2. Protocol VLAN Configuration
3. Configuration Example
4. Appendix: Default Parameters

# 1 Overview

Protocol VLAN is a technology that divides VLANs based on the network layer protocol. With the protocol VLAN rule configured on the basis of the existing 802.1Q VLAN, the switch can analyze specific fields of received packets, encapsulate the packets in specific formats, and forward the packets with different protocols to the corresponding VLANs. Since different applications and services use different protocols, network administrators can use protocol VLAN to manage the network based on specific applications and services.

The figure below shows a common application scenario of protocol VLAN. With protocol VLAN configured, Switch 2 can forward IPv4 and IPv6 packets from different VLANs to the IPv4 and IPv6 networks respectively.

Figure 1-1 Common Application Scenario of Protocol VLAN

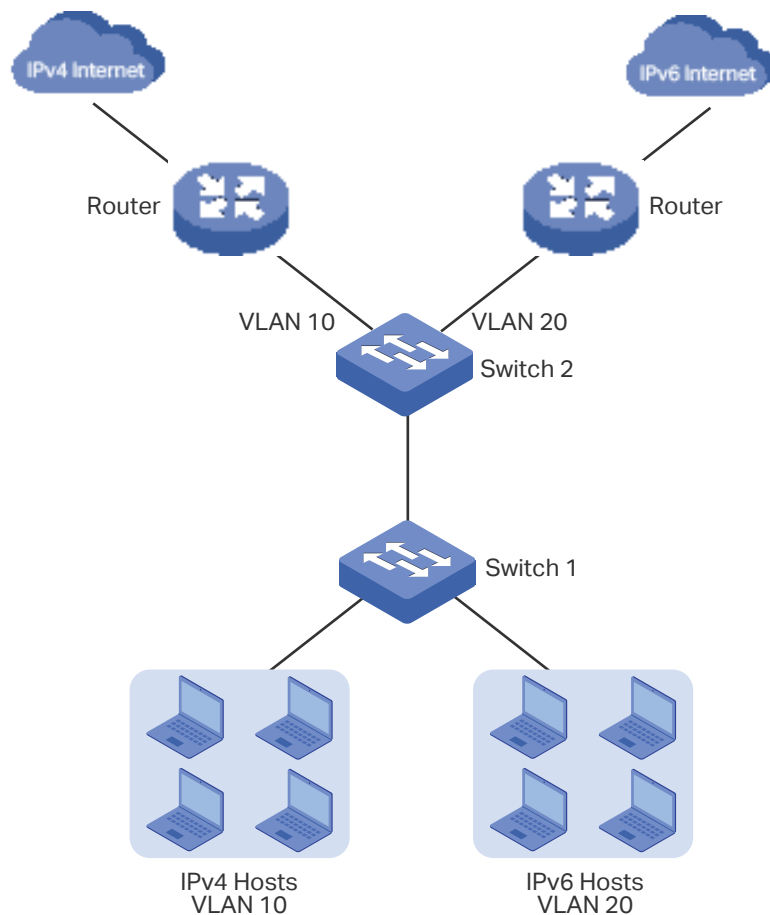



# 2 Protocol VLAN Configuration

To complete protocol VLAN configuration, follow these steps:

- 1) Configure 802.1Q VLAN.
- 2) Create protocol template.
- 3) Configure Protocol VLAN.

## Configuration Guidelines

- You can use the IP, ARP, RARP, and other protocol templates provided by TP-Link switches, or create new protocol templates.
- In a protocol VLAN, when a port receives an untagged data packet, the switch will first search for the protocol VLAN matching the protocol type value of the packet. If there is a match, the switch will insert the corresponding VLAN tag to the data packet and forward it within the VLAN. Otherwise, the switch will forward the data packet to the default VLAN based on the PVID (Port VLAN ID) of the receiving port. (If MAC VLAN is also configured, the switch will first process Protocol VLAN, then MAC VLAN.) When the port receives a tagged data packet, the switch will directly process the data packet according to the processing rule of the 802.1 Q VLAN.

## 2.1 Using the GUI

### 2.1.1 Configuring 802.1Q VLAN

Before configuring protocol VLAN, create an 802.1Q VLAN and set the port type according to network requirements. For details, refer to [Configuring 802.1Q VLAN](#).

## 2.1.2 Creating Protocol Template

Choose the menu **L2 FEATURES > VLAN > Protocol VLAN > Protocol Template** to load the following page.

Figure 2-1 Check the Protocol Template

| Protocol Template Config |    |               |                  |                |
|--------------------------|----|---------------|------------------|----------------|
|                          |    |               |                  | + Add - Delete |
| <input type="checkbox"/> | ID | Template Name | Protocol Type    |                |
| <input type="checkbox"/> | 1  | IP            | Ethernet II 0800 |                |
| <input type="checkbox"/> | 2  | ARP           | Ethernet II 0806 |                |
| <input type="checkbox"/> | 3  | RARP          | Ethernet II 8035 |                |
| <input type="checkbox"/> | 4  | IPX           | SNAP             |                |
| <input type="checkbox"/> | 5  | AT            | SNAP             |                |
| Total: 5                 |    |               |                  |                |

Follow these steps to create a protocol template:

- 1) Check whether your desired template already exists in the **Protocol Template Config** section. If not, click **+ Add** to create a new template.

Figure 2-2 Creating a Protocol Template

**Protocol Template Config**

Template Name:  (1-8 characters)

Frame Type:  Ethernet II  SNAP  LLC

Ether Type:  (4 hexadecimal integers, 0600-FFFF)

|                      |   |
|----------------------|---|
| <b>Template Name</b> | Give a protocol name to identify the protocol template.   |
| <b>Frame Type</b>    | <p>Select the frame type of the new protocol template.</p> <p><b>Ethernet II:</b> A common Ethernet frame format. Select to specify the Frame Type by entering the Ether Type.</p> <p><b>SNAP:</b> An Ethernet 802.3 frame format based on IEEE 802.3 and IEEE 802.2 SNAP. Select to specify the Frame Type by entering the Ether Type.</p> <p><b>LLC:</b> An Ethernet 802.3 frame format based on IEEE 802.3 and IEEE 802.2 LLC. Select to specify the Frame Type by entering the DSAP and SSAP.</p> |
| <b>Ether Type</b>    | Enter the Ethernet protocol type value for the protocol template. It is available when <b>Ethernet II</b> and <b>SNAP</b> is selected. It is the Ether Type field in the frame and is used to identify the data type of the frame.  |

|      |  |
|------|--|
| DSAP | Enter the DSAP value for the protocol template. It is available when <b>LLC</b> is selected. It is the DSAP field in the frame and is used to identify the data type of the frame. |
| SSAP | Enter the SSAP value for the protocol template. It is available when <b>LLC</b> is selected. It is the SSAP field in the frame and is used to identify the data type of the frame. |

2) Click **Create**.

 **Note:**

A protocol template that is bound to a VLAN cannot be deleted.

### 2.1.3 Configuring Protocol VLAN

Choose the menu **L2 FEATURES > VLAN > Protocol VLAN > Protocol VLAN Group** and click  **Add** to load the following page.

Figure 2-3 Configure the Protocol VLAN Group

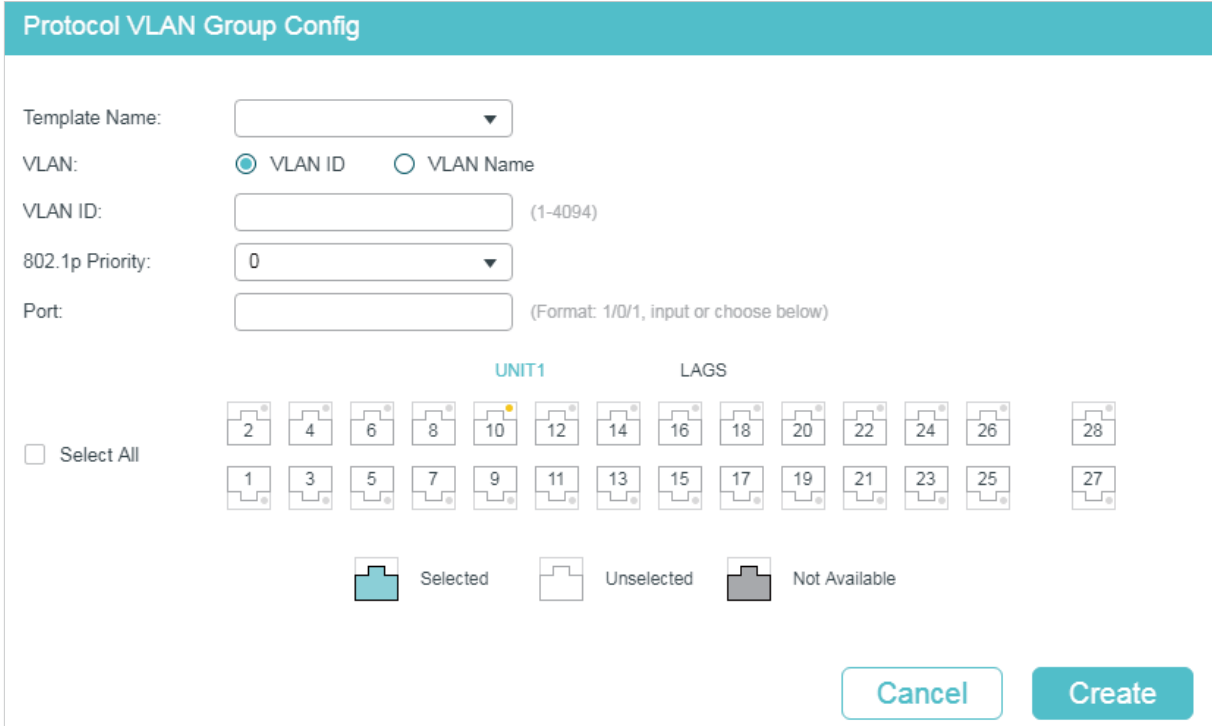

Follow these steps to configure the protocol group:

1) In the **Protocol Group Config** section, specify the following parameters.

|               |  |
|---------------|--|
| Template Name | Select the previously defined protocol template.   |
| VLAN ID/Name  | Enter the ID number or name of the 802.1Q VLAN that will be bound to the Protocol VLAN.. |

|                        |   |
|------------------------|---|
| <b>802.1p Priority</b> | Specify the 802.1p priority for the packets that belong to the protocol VLAN. The switch will determine the forwarding sequence according to this value. The packets with a larger value of 802.1p priority have the higher priority. |
|------------------------|---|

2) Select the desired ports. Click **Create**.

 **Note:**

The member port of an LAG (Link Aggregation Group) follows the configuration of the LAG and not its own. The configurations of the port can take effect only after it leaves the LAG.

## 2.2 Using the CLI

### 2.2.1 Configuring 802.1Q VLAN

Before configuring protocol VLAN, create an 802.1Q VLAN and set the port type according to network requirements. For details, refer to [Configuring 802.1Q VLAN](#).

### 2.2.2 Creating a Protocol Template

Follow these steps to create a protocol template:

|        |  |
|--------|--|
| Step 1 | <b>configure</b><br>Enter global configuration mode.   |
| Step 2 | <b>protocol-vlan template name protocol-name frame { ether_2 ether-type type   snap ether-type type   llc dsap dsap_type ssap ssap_type }</b><br>Create a protocol template.<br><br><i>protocol-name</i> : Specify the protocol name with 1 to 8 characters.<br><br><i>type</i> : Enter 4 hexadecimal numbers as the Ethernet protocol type for the protocol template. It is the Ether Type field in the frame and is used to identify the data type of the frame.<br><br><i>dsap_type</i> : Enter 2 hexadecimal numbers as the DSAP value for the protocol template. It is the DSAP field in the frame and is used to identify the data type of the frame.<br><br><i>ssap_type</i> : Enter 2 hexadecimal numbers as the SSAP value for the protocol template. It is the SSAP field in the frame and is used to identify the data type of the frame. |
| Step 3 | <b>show protocol-vlan template</b><br>Verify the protocol templates.   |
| Step 4 | <b>end</b><br>Return to Privileged EXEC Mode.  |
| Step 5 | <b>copy running-config startup-config</b><br>Save the settings in the configuration file.  |

The following example shows how to create an IPv6 protocol template:

```
Switch#configure
```

```
Switch(config)#protocol-vlan template name IPv6 frame ether_2 ether-type 86dd
```

```
Switch(config)#show protocol-vlan template
```

| Index | Protocol Name | Protocol Type              |
|-------|---------------|----------------------------|
| 1     | IP            | EthernetII ether-type 0800 |
| 2     | ARP           | EthernetII ether-type 0806 |
| 3     | RARP          | EthernetII ether-type 8035 |
| 4     | IPX           | SNAP ether-type 8137       |
| 5     | AT            | SNAP ether-type 809B       |
| 6     | IPv6          | EthernetII ether-type 86DD |

```
Switch(config)#end
```

```
Switch#copy running-config startup-config
```

## 2.2.3 Configuring Protocol VLAN

Follow these steps to configure protocol VLAN:

|        |   |
|--------|---|
| Step 1 | <p><b>configure</b></p> <p>Enter global configuration mode.</p>   |
| Step 2 | <p><b>show protocol-vlan template</b></p> <p>Check the index of each protocol template.</p>   |
| Step 3 | <p><b>protocol-vlan vlan vid priority priority template index</b></p> <p>Bind the protocol template to the VLAN.</p> <p><i>vid</i> : Enter the ID number of the 802.1Q VLAN that will be bound to the Protocol VLAN.</p> <p><i>priority</i> : Specify the 802.1p priority for the packets that belong to the protocol VLAN. The switch will determine the forwarding sequence according this value. The packets with larger value of 802.1p priority have the higher priority.</p> <p><i>index</i> : Specify the protocol template index.</p> |
| Step 4 | <p><b>show protocol-vlan vlan</b></p> <p>Check the protocol VLAN index (entry-id) of each protocol group.</p>   |

|        |  |
|--------|--|
| Step 5 | <b>interface {fastEthernet port   range fastEthernet port-list   gigabitEthernet port   range gigabitEthernet port-list   ten-gigabitEthernet port   range ten-gigabitEthernet port-list   port-channel port-channel-id   range port-channel port-channel-list}</b><br>Enter interface configuration mode. |
| Step 6 | <b>protocol-vlan group entry-id</b><br>Add the specified port to the protocol group.<br><br><i>entry-id</i> : Protocol VLAN index.   |
| Step 7 | <b>end</b><br>Return to Privileged EXEC Mode.  |
| Step 8 | <b>copy running-config startup-config</b><br>Save the settings in the configuration file.  |

The following example shows how to bind the IPv6 protocol template to VLAN 10 and add port 1/0/2 to protocol VLAN:

### Switch#configure

#### Switch(config)#show protocol-vlan template

| Index | Protocol Name | Protocol Type              |
|-------|---------------|----------------------------|
| 1     | IP            | EthernetII ether-type 0800 |
| 2     | ARP           | EthernetII ether-type 0806 |
| 3     | RARP          | EthernetII ether-type 8035 |
| 4     | IPX           | SNAP ether-type 8137       |
| 5     | AT            | SNAP ether-type 809B       |
| 6     | IPv6          | EthernetII ether-type 86DD |

#### Switch(config)#protocol-vlan vlan 10 priority 5 template 6

#### Switch(config)#show protocol-vlan vlan

| Index | Protocol-Name | VID | Priority | Member |
|-------|---------------|-----|----------|--------|
| 1     | IPv6          | 10  | 0        |        |

#### Switch(config)#interface gigabitEthernet 1/0/2

#### Switch(config-if)#protocol-vlan group 1

#### Switch(config-if)#show protocol-vlan vlan

| Index | Protocol-Name | VID | Priority | Member  |
|-------|---------------|-----|----------|---------|
| 1     | IPv6          | 10  | 5        | Gi1/0/2 |

**Switch(config-if)#end**

**Switch#copy running-config startup-config**

# 3 Configuration Example

## 3.1 Network Requirements

A company uses both IPv4 and IPv6 hosts, and these hosts access the IPv4 network and IPv6 network respectively via different routers. It is required that IPv4 packets are forwarded to the IPv4 network, IPv6 packets are forwarded to the IPv6 network, and other packets are dropped.

The figure below shows the network topology. The IPv4 host belongs to VLAN 10, the IPv6 host belongs to VLAN 20, and these hosts access the network via Switch 1. Switch 2 is connected to two routers to access the IPv4 network and IPv6 network respectively. The routers belong to VLAN 10 and VLAN 20 respectively.

Figure 3-1 Network Topology

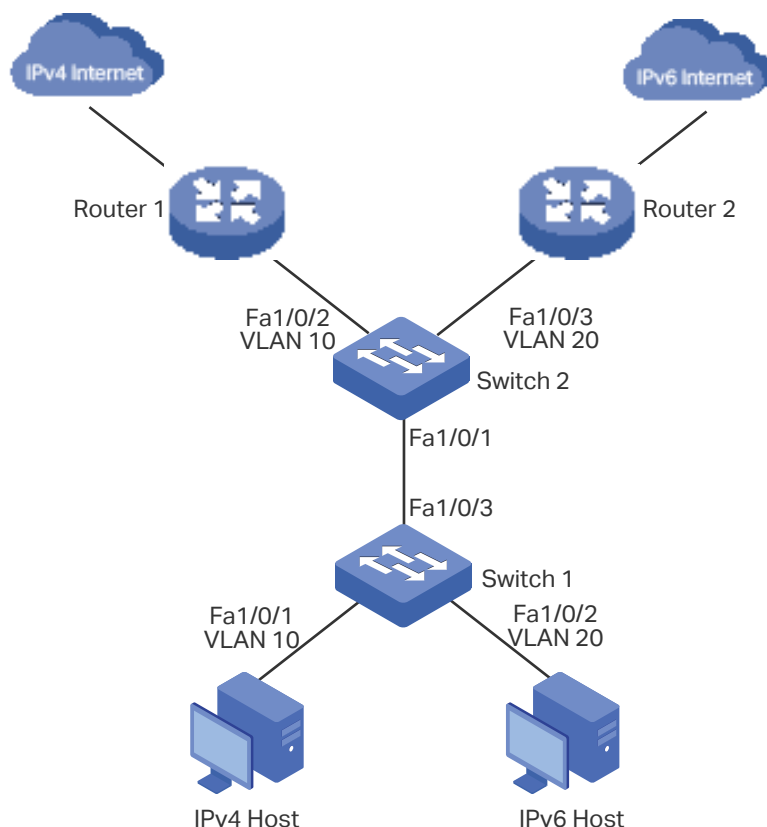

## 3.2 Configuration Scheme

You can configure protocol VLAN on port 1/0/1 of Switch 2 to meet this requirement. When this port receives packets, Switch 2 will forward them to the corresponding VLANs according to their protocol types. The overview of the configuration on Switch 2 is as follows:



- 1) Create VLAN 10 and VLAN 20 and add each port to the corresponding VLAN.
- 2) Use the IPv4 protocol template provided by the switch, and create the IPv6 protocol template.
- 3) Bind the protocol templates to the corresponding VLANs to form protocol groups, and add port 1/0/1 to the groups.

For Switch 1, configure 802.1Q VLAN according to the network topology.

Demonstrated with T1500-28PCT, this chapter provides configuration procedures in two ways: using the GUI and using the CLI.

### 3.3 Using the GUI

- Configurations for Switch 1

- Choose the menu **L2 FEATURES > VLAN > 802.1Q VLAN > VLAN Config** and click **+ Add** to load the following page. Create VLAN 10, and add untagged port 1/0/1 and untagged port 1/0/3 to VLAN 10. Click **Create**.

Figure 3-2 Create VLAN 10

VLAN Config

VLAN ID:  (2-4094, format: 2,4-5,8)

VLAN Name:  (1-16 characters)

Untagged Ports

Port:  (Format: 1/0/1, input or choose below)

UNIT1
LAGS

Select All

2

4

6

8

10

12

14

16

18

20

22

24

26

28

1

3

5

7

9

11

13

15

17

19

21

23

25

27

Selected

Unselected

Not Available

Tagged Ports

Port:  (Format: 1/0/1, input or choose below)

UNIT1
LAGS

Select All

2

4

6

8

10

12

14

16

18

20

22

24

26

28

1

3

5

7

9

11

13

15

17

19

21

23

25

27

Selected

Unselected

Not Available

Cancel

Create

- Click  **Add** to load the following page. Create VLAN 20, and add untagged ports 1/0/2-3 to VLAN 20. Click **Create**.

Figure 3-3 Create VLAN 20

### VLAN Config

VLAN ID:  (2-4094, format: 2,4-5,8)

VLAN Name:  (1-16 characters)

---

Untagged Ports

Port:  (Format: 1/0/1, input or choose below)

UNIT1
LAGS

Select All

2

4

6

8

10

12

14

16

18

20

22

24

26

28

1

3

5

7

9

11

13

15

17

19

21

23

25

27

 Selected

 Unselected

 Not Available

---

Tagged Ports

Port:  (Format: 1/0/1, input or choose below)

UNIT1
LAGS

Select All

2

4

6

8

10

12

14

16

18

20

22

24

26

28

1

3

5

7

9

11

13

15

17

19

21

23

25

27

 Selected

 Unselected

 Not Available

Cancel

Create

- Click  **Save** to save the settings.

■ Configurations for Switch 2

- 1) Choose the menu **L2 FEATURES > VLAN > 802.1Q VLAN > VLAN Config** and click **+ Add** to load the following page. Create VLAN 10, and add tagged port 1/0/1 and untagged port 1/0/2 to VLAN 10. Click **Create**.

Figure 3-4 Create VLAN 10

VLAN Config

VLAN ID:  (2-4094, format: 2,4-5,8)

VLAN Name:  (1-16 characters)

Untagged Ports

---

Port:  (Format: 1/0/1, input or choose below)

UNIT1
LAGS

Select All

2

4

6

8

10

12

14

16

18

20

22

24

26

28

1

3

5

7

9

11

13

15

17

19

21

23

25

27

Selected

Unselected

Not Available

Tagged Ports

---

Port:  (Format: 1/0/1, input or choose below)

UNIT1
LAGS

Select All

2

4

6

8

10

12

14

16

18

20

22

24

26

28

1

3

5

7

9

11

13

15

17

19

21

23

25

27

Selected

Unselected

Not Available

Cancel

Create

- Click **+ Add** to load the following page. Create VLAN 20, and add tagged port 1/0/1 and untagged port 1/0/3 to VLAN 20. Click **Create**.

Figure 3-5 Create VLAN 20

### VLAN Config

VLAN ID:  (2-4094, format: 2,4-5,8)

VLAN Name:  (1-16 characters)

---

Untagged Ports

Port:  (Format: 1/0/1, input or choose below)

UNIT1
LAGS

Select All

2

4

6

8

10

12

14

16

18

20

22

24

26

28

1

3

5

7

9

11

13

15

17

19

21

23

25

27

Selected

Unselected

Not Available

---

Tagged Ports

Port:  (Format: 1/0/1, input or choose below)

UNIT1
LAGS

Select All

2

4

6

8

10

12

14

16

18

20

22

24

26

28

1

3

5

7

9

11

13

15

17

19

21

23

25

27

Selected

Unselected

Not Available

Cancel
Create

- 3) Choose the menu **L2 FEATURES > VLAN > 802.1Q VLAN > Port Config** to load the following page. Set the PVID of port 1/0/2 and port 1/0/3 as 10 and 20 respectively. Click **Apply**.

Figure 3-6 Port Configuration

Port Config

| UNIT1                               |        | LAGS |                  |                        |     |                         |
|-------------------------------------|--------|------|------------------|------------------------|-----|-------------------------|
| <input type="checkbox"/>            | Port   | PVID | Ingress Checking | Acceptable Frame Types | LAG | Details                 |
|                                     |        | 20   |                  |                        |     |                         |
| <input type="checkbox"/>            | 1/0/1  | 1    | Enabled          | Admit All              | --- | <a href="#">Details</a> |
| <input type="checkbox"/>            | 1/0/2  | 10   | Enabled          | Admit All              | --- | <a href="#">Details</a> |
| <input checked="" type="checkbox"/> | 1/0/3  | 20   | Enabled          | Admit All              | --- | <a href="#">Details</a> |
| <input type="checkbox"/>            | 1/0/4  | 1    | Enabled          | Admit All              | --- | <a href="#">Details</a> |
| <input type="checkbox"/>            | 1/0/5  | 1    | Enabled          | Admit All              | --- | <a href="#">Details</a> |
| <input type="checkbox"/>            | 1/0/6  | 1    | Enabled          | Admit All              | --- | <a href="#">Details</a> |
| <input type="checkbox"/>            | 1/0/7  | 1    | Enabled          | Admit All              | --- | <a href="#">Details</a> |
| <input type="checkbox"/>            | 1/0/8  | 1    | Enabled          | Admit All              | --- | <a href="#">Details</a> |
| <input type="checkbox"/>            | 1/0/9  | 1    | Enabled          | Admit All              | --- | <a href="#">Details</a> |
| <input type="checkbox"/>            | 1/0/10 | 1    | Enabled          | Admit All              | --- | <a href="#">Details</a> |

Total: 28      1 entry selected.     

- 4) Choose the menu **L2 FEATURES > VLAN > Protocol VLAN > Protocol Template** and click **+ Add** to load the following page. Enter **IPv6** in the protocol name, select the **Ethernet II** frame type, enter **86DD** in the Ether Type field, and click **Create** to create the IPv6 protocol template.

*Tips:* The IPv4 protocol template is already provided by the switch. You only need to create the IPv6 protocol template.

Figure 3-7 Create the IPv6 Protocol Template

Protocol Template Config

Template Name:  (1-8 characters)

Frame Type:  Ethernet II  SNAP  LLC

Ether Type:  (4 hexadecimal integers, 0600-FFFF)

- 5) Choose the menu **L2 FEATURES > VLAN > Protocol VLAN > Protocol VLAN Group** and click **+ Add** to load the following page. Select the IP protocol name (that is the IPv4 protocol template), enter VLAN ID 10, select port 1, and click **Create**. Select the IPv6 protocol name, enter VLAN ID 20, select port 1, and click **Create**.

Figure 3-8 Configure the IPv4 Protocol Group

**Protocol VLAN Group Config**

Template Name: IP

VLAN:  VLAN ID  VLAN Name

VLAN ID: 10 (1-4094)

802.1p Priority: 0

Port: 1/0/1 (Format: 1/0/1, input or choose below)

Select All

UNIT1 LAGS

2 4 6 8 10 12 14 16 18 20 22 24 26 28

1 3 5 7 9 11 13 15 17 19 21 23 25 27

Selected  Unselected  Not Available

Cancel Create

Figure 3-9 Configure the IPv6 Protocol Group

**Protocol VLAN Group Config**

Template Name: IPv6

VLAN:  VLAN ID  VLAN Name

VLAN ID: 20 (1-4094)

802.1p Priority: 0

Port: 1/0/1 (Format: 1/0/1, input or choose below)

Select All

UNIT1 LAGS

2 4 6 8 10 12 14 16 18 20 22 24 26 28

1 3 5 7 9 11 13 15 17 19 21 23 25 27

Selected  Unselected  Not Available

Cancel Create

6) Click  Save to save the settings.

### 3.4 Using the CLI

- Configurations for Switch 1

- 1) Create VLAN 10 and VLAN 20.

```
Switch_1#configure
Switch_1(config)#vlan 10
Switch_1(config-vlan)#name IPv4
Switch_1(config-vlan)#exit
Switch_1(config)#vlan 20
Switch_1(config-vlan)#name IPv6
Switch_1(config-vlan)#exit
```

- 2) Add untagged port 1/0/1 to VLAN 10. Add untagged port 1/0/2 to VLAN 20. Add untagged port 1/0/3 to both VLAN10 and VLAN 20.

```
Switch_1(config)#interface fastEthernet 1/0/1
Switch_1(config-if)#switchport general allowed vlan 10 untagged
Switch_1(config-if)#exit
Switch_1(config)#interface fastEthernet 1/0/2
Switch_1(config-if)#switchport general allowed vlan 20 untagged
Switch_1(config-if)#exit
Switch_1(config)#interface fastEthernet 1/0/3
Switch_1(config-if)#switchport general allowed vlan 10,20 untagged
Switch_1(config-if)#end
Switch_1#copy running-config startup-config
```

#### ■ Configurations for Switch 2

- 1) Create VLAN 10 and VLAN 20.

```
Switch_2#configure
Switch_2(config)#vlan 10
Switch_2(config-vlan)#name IPv4
Switch_2(config-vlan)#exit
Switch_2(config)#vlan 20
Switch_2(config-vlan)#name IPv6
Switch_2(config-vlan)#exit
```

- 2) Add tagged port 1/0/1 to both VLAN 10 and VLAN 20. Specify the PVID of untagged port 1/0/2 as 10 and add it to VLAN 10. Specify the PVID of untagged port 1/0/3 as 20 and add it to VLAN 20.



```

Switch_2(config)#interface fastEthernet 1/0/1
Switch_2(config-if)#switchport general allowed vlan 10,20 tagged
Switch_2(config-if)#exit
Switch_2(config)#interface fastEthernet 1/0/2
Switch_2(config-if)#switchport pvid 10
Switch_2(config-if)#switchport general allowed vlan 10 untagged
Switch_2(config-if)#exit
Switch_2(config)#interface fastEthernet 1/0/3
Switch_2(config-if)#switchport mode general
Switch_2(config-if)#switchport pvid 20
Switch_2(config-if)#switchport general allowed vlan 20 untagged
Switch_2(config-if)#exit

```

3) Create the IPv6 protocol template.

```

Switch_2(config)#protocol-vlan template name IPv6 frame ether_2 ether-type 86dd
Switch_2(config)#show protocol-vlan template

```

| Index | Protocol Name | Protocol Type               |
|-------|---------------|-----------------------------|
| 1     | IP            | EthernetII ether-type 0800  |
| 2     | ARP           | EthernetII ether-type 0806  |
| 3     | RARP          | EthernetII ether-type 8035  |
| 4     | IPX           | SNAP ether-type 8137        |
| 5     | AT            | SNAP ether-type 809b        |
| 6     | IPv6          | Ethernet II ether-type 86dd |

4) Configure the protocol groups.

```

Switch_2(config)#protocol-vlan vlan 10 priority 0 template 1
Switch_2(config)#protocol-vlan vlan 20 priority 0 template 6

```

5) Add port 1/0/1 to the protocol groups.

```

Switch_2(config)#show protocol-vlan vlan

```

| Index | Protocol-Name | VID | Member |
|-------|---------------|-----|--------|
| 1     | IP            | 10  |        |

```

2      IPv6      20

Switch_2(config)#interface fastEthernet 1/0/1

Switch_2(config-if)#protocol-vlan group 1

Switch_2(config-if)#protocol-vlan group 2

Switch_2(config-if)#exit

Switch_2(config)#end

Switch_2#copy running-config startup-config

```

## Verify the Configurations

### ■ Switch 1

Verify 802.1Q VLAN configuration:

```
Switch_1#show vlan
```

| VLAN | Name        | Status | Ports   |
|------|-------------|--------|---|
| 1    | System-VLAN | active | Fa1/0/1, Fa1/0/2, Fa1/0/3, Fa1/0/4<br>...<br>Gi1/0/25, Gi1/0/26, Gi1/0/27, Gi1/0/28 |
| 10   | IPv4        | active | Fa1/0/1, Fa1/0/3  |
| 20   | IPv6        | active | Fa1/0/2, Fa1/0/3  |

### ■ Switch 2

Verify 802.1Q VLAN configuration:

```
Switch_2#show vlan
```

| VLAN | Name        | Status | Ports   |
|------|-------------|--------|---|
| 1    | System-VLAN | active | Fa1/0/1, Fa1/0/2, Fa1/0/3, Fa1/0/4<br>...<br>Gi1/0/25, Gi1/0/26, Gi1/0/27, Gi1/0/28 |
| 10   | IPv4        | active | Fa1/0/1, Fa1/0/2  |
| 20   | IPv6        | active | Fa1/0/1, Fa1/0/3  |

Verify protocol group configuration:

```
Switch_2#show protocol-vlan vlan
```

| Index | Protocol-Name | VID | Priority | Member  |
|-------|---------------|-----|----------|---------|
| 1     | IP            | 10  | 0        | Fa1/0/1 |
| 2     | IPv6          | 20  | 0        | Fa1/0/1 |

# 4 Appendix: Default Parameters

Default settings of Protocol VLAN are listed in the following table.

Table 4-1 Default Settings of Protocol VLAN

| Parameter               | Default Setting |      |                             |
|-------------------------|-----------------|------|-----------------------------|
| Protocol Template Table | 1               | IP   | Ethernet II ether-type 0800 |
|                         | 2               | ARP  | Ethernet II ether-type 0806 |
|                         | 3               | RARP | Ethernet II ether-type 8035 |
|                         | 4               | IPX  | SNAP ether-type 8137        |
|                         | 5               | AT   | SNAP ether-type 809B        |

# Part 9

## Configuring GVRP

### CHAPTERS

1. Overview
2. GVRP Configuration
3. Configuration Example
4. Appendix: Default Parameters

# 1 Overview

GVRP (GARP VLAN Registration Protocol) is a GARP (Generic Attribute Registration Protocol) application that allows registration and deregistration of VLAN attribute values and dynamic VLAN creation.

Without GVRP operating, configuring the same VLAN on a network would require manual configuration on each device. As shown in Figure 1-1, Switch A, B and C are connected through trunk ports. VLAN 10 is configured on Switch A, and VLAN 1 is configured on Switch B and Switch C. Switch C can receive messages sent from Switch A in VLAN 10 only when the network administrator has manually created VLAN 10 on Switch B and Switch C.

Figure 1-1 VLAN Topology

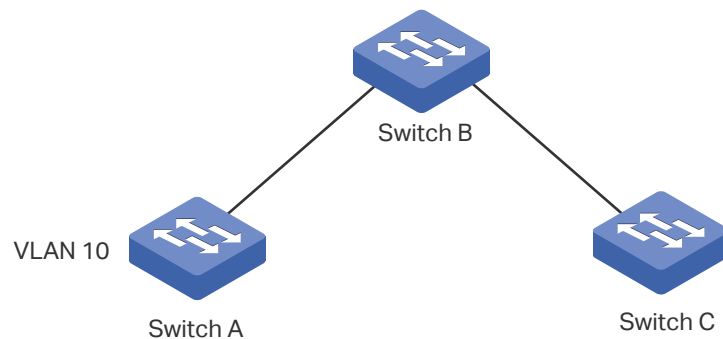

The configuration may seem easy in this situation. However, for a larger or more complex network, such manual configuration would be time-costing and fallible. GVRP can be used to implement dynamic VLAN configuration. With GVRP, the switch can exchange VLAN configuration information with the adjacent GVRP switches and dynamically create and manage the VLANs. This reduces VLAN configuration workload and ensures correct VLAN configuration.

Figure 1-2 GVRP Topology

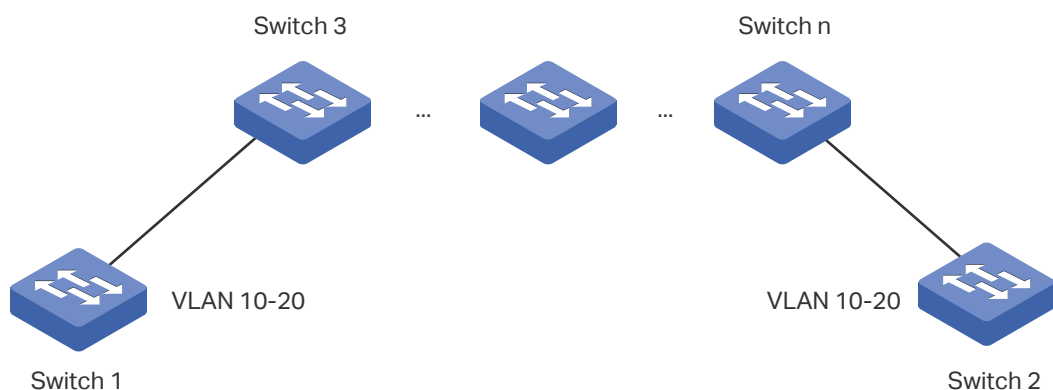

# 2 GVRP Configuration

To complete GVRP configuration, follow these steps:

- 1) Create a VLAN.
- 2) Enable GVRP globally.
- 3) Enable GVRP on each port and configure the corresponding parameters.

## Configuration Guidelines

To dynamically create a VLAN on all ports in a network link, you must configure the same static VLAN on both ends of the link.

We call manually configured 802.1Q VLAN as static VLAN and VLAN created through GVRP as dynamic VLAN. Ports in a static VLAN can initiate the sending of GVRP registration message to other ports. And a port registers VLANs only when it receives GVRP messages. As the messages can only be sent from one GVRP participant to another, two-way registration is required to configure a VLAN on all ports in a link. To implement two-way registration, you need to manually configure the same static VLAN on both ends of the link.

As shown in the figure below, VLAN registration from Switch A to Switch C adds Port 2 to VLAN 2. And VLAN registration from Switch C to Switch A adds Port 3 to VLAN 2.

Figure 2-1

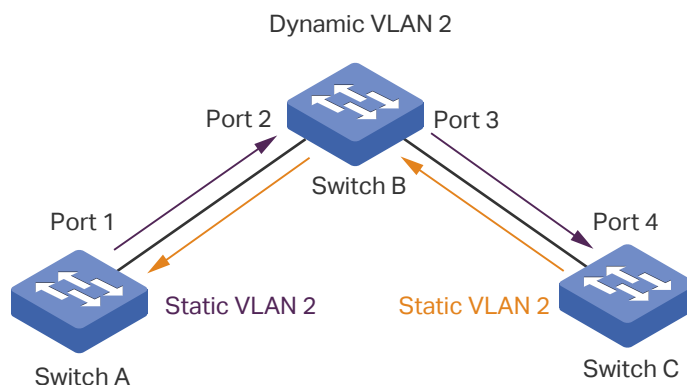

Similarly, if you want to delete a VLAN from the link, two-way deregistration is required. And you need to manually delete the static VLAN on both ends of the link.

## 2.1 Using the GUI

Choose the menu **L2 FEATURES > VLAN > GVRP > GVRP Config** to load the following page.

Figure 2-1 GVRP Config

GVRP

---

GVRP:  Enable Apply

Port Config

UNIT1
LAGS

| <input type="checkbox"/>            | ID | Port   | Status   | Registration Mode | LeaveAll Timer (1000-30000 centiseconds) | Join Timer (20-1000 centiseconds) | Leave Timer (60-3000 centiseconds) | LAG |
|-------------------------------------|----|--------|----------|-------------------|--|-----------------------------------|------------------------------------|-----|
| <input checked="" type="checkbox"/> | 1  | 1/0/1  | Disabled | Normal            | 1000                                     | 20                                | 60                                 | --- |
| <input type="checkbox"/>            | 2  | 1/0/2  | Disabled | Normal            | 1000                                     | 20                                | 60                                 | --- |
| <input type="checkbox"/>            | 3  | 1/0/3  | Disabled | Normal            | 1000                                     | 20                                | 60                                 | --- |
| <input type="checkbox"/>            | 4  | 1/0/4  | Disabled | Normal            | 1000                                     | 20                                | 60                                 | --- |
| <input type="checkbox"/>            | 5  | 1/0/5  | Disabled | Normal            | 1000                                     | 20                                | 60                                 | --- |
| <input type="checkbox"/>            | 6  | 1/0/6  | Disabled | Normal            | 1000                                     | 20                                | 60                                 | --- |
| <input type="checkbox"/>            | 7  | 1/0/7  | Disabled | Normal            | 1000                                     | 20                                | 60                                 | --- |
| <input type="checkbox"/>            | 8  | 1/0/8  | Disabled | Normal            | 1000                                     | 20                                | 60                                 | --- |
| <input type="checkbox"/>            | 9  | 1/0/9  | Disabled | Normal            | 1000                                     | 20                                | 60                                 | --- |
| <input type="checkbox"/>            | 10 | 1/0/10 | Disabled | Normal            | 1000                                     | 20                                | 60                                 | --- |

Total: 28
1 entry selected.

Cancel
Apply

Follow these steps to configure GVRP:

- 1) In the **GVRP** section, enable GVRP globally, then click **Apply**.
- 2) In the **Port Config** section, select one or more ports, set the status as Enable and configure the related parameters according to your needs.

|                          |   |
|--------------------------|---|
| <b>Port</b>              | Select the desired port for GVRP configuration. It is multi-optional.   |
| <b>Status</b>            | Enable or disable GVRP on the port. By default, it is disabled.   |
| <b>Registration Mode</b> | <p>Select the GVRP registration mode for the port.</p> <p><b>Normal:</b> In this mode, the port can dynamically register and deregister VLANs, and transmit both dynamic and static VLAN registration information.</p> <p><b>Fixed:</b> In this mode, the port is unable to dynamically register and deregister VLANs, and can transmit only the static VLAN registration information.</p> <p><b>Forbidden:</b> In this mode, the port is unable to dynamically register and deregister VLANs, and can transmit only information of VLAN 1.</p> |



|                                 |  |
|---------------------------------|--|
| LeaveAll Timer<br>(centisecond) | When a GARP participant is enabled, the LeaveAll timer will be started. When the LeaveAll timer expires, the GARP participant will send LeaveAll messages to request other GARP participants to re-register all its attributes. After that, the participant restarts the LeaveAll timer.   |
|                                 | The timer ranges from 1000 to 30000 centiseconds and should be an integral multiple of 5. The default value is 1000 centiseconds.  |
| Join Timer<br>(centisecond)     | Join timer controls the sending of Join messages. A GVRP participant starts the Join timer after sending the first Join message. If the participant does not receive any response, it will send the second Join message when the Join timer expires to ensure that the Join message can be sent to other participants.   |
|                                 | The timer ranges from 20 to 1000 centiseconds and should be an integral multiple of 5. The default value is 20 centiseconds.   |
| Leave Timer<br>(centisecond)    | The Leave timer controls attribute deregistration. A participant will send a Leave message if it wants other participants to deregister some of its attributes. The participant receiving the message starts the Leave timer. If the participant does not receive any Join message of the corresponding attribute before the Leave timer expires, the participant deregisters the attribute. |
|                                 | The timer ranges from 60 to 3000 centiseconds and should be an integral multiple of 5. The default value is 60 centiseconds.   |
| LAG                             | Displays the LAG the port is in.   |

### 3) Click **Apply**.

#### Note:

- The member port of an LAG follows the configuration of the LAG and not its own. The configurations of the port can take effect only after it leaves the LAG.
- The egress rule of the ports dynamically added to the VLAN is tagged.
- The egress rule of the fixed port should be tagged.
- When setting the timer values, make sure the values are within the required range. The configuration value for LeaveAll should be greater than or equal to ten times the Leave value. The value for Leave should be greater than or equal to two times the Join value.

## 2.2 Using the CLI

|        |                                  |
|--------|----------------------------------|
| Step 1 | <b>configure</b>                 |
|        | Enter global configuration mode. |
| Step 2 | <b>gvrp</b>                      |
|        | Enable GVRP globally.            |

---

|        |   |
|--------|---|
| Step 3 | <b>interface {fastEthernet port   range fastEthernet port-list   gigabitEthernet port   range gigabitEthernet port-list   ten-gigabitEthernet port   range ten-gigabitEthernet port-list   port-channel port-channel-id   range port-channel port-channel-list}</b><br>Enter interface configuration mode.  |
| Step 4 | <b>gvrp</b><br>Enable GVRP on the port.   |
| Step 5 | <b>gvrp registration { normal   fixed   forbidden }</b><br>Configure the GVRP registration mode for the port. By default, it is normal.<br><br><b>normal:</b> In this mode, the port can dynamically register and deregister VLANs, and transmit both dynamic and static VLAN registration information.<br><br><b>fixed:</b> In this mode, the port is unable to dynamically register and deregister VLANs, and can transmit only the static VLAN registration information.<br><br><b>forbidden:</b> In this mode, the port is unable to dynamically register and deregister VLANs, and can transmit only information of VLAN 1.  |
| Step 6 | <b>gvrp timer { leaveall   join   leave } value</b><br>Set the GARP timers according to your needs.<br><br><b>leaveall:</b> When a GARP participant is enabled, the LeaveAll timer will be started. When the LeaveAll timer expires, the GARP participant will send LeaveAll messages to request other GARP participants to re-register all its attributes. After that, the participant restarts the LeaveAll timer.<br><br><b>join:</b> Join timer controls the sending of Join messages. A GVRP participant starts the Join timer after sending the first Join message. If the participant does not receive any response, it will send the second Join message when the Join timer expires to ensure that the Join message can be sent to other participants.<br><br><b>leave:</b> The Leave timer controls attribute deregistration. A participant will send a Leave message if it wants other participants to deregister some of its attributes. The participant receiving the message starts the Leave timer. If the participant does not receive any Join message of the corresponding attribute before the Leave timer expires, the participant deregisters the attribute.<br><br><b>value:</b> Set a value for the timer. It should be an integral multiple of 5. For LeaveAll timer, the valid values are from 1000 to 30000 centiseconds and the default value is 1000 centiseconds. For Join timer, the valid values are from 20 to 1000 centiseconds and the default value is 20 centiseconds. For Leave timer, the valid values are from 60 to 3000 centiseconds and the default value is 60 centiseconds. |
| Step 7 | <b>show gvrp global</b><br>Verify the global configurations of GVRP.  |
| Step 8 | <b>show gvrp interface [ fastEthernet port   gigabitEthernet port   ten-gigabitEthernet port   port-channel port-channel-id ]</b><br>Verify the GVRP configuration of the specified port or LAG.  |

---

- 
- Step 9      **end**  
Return to privileged EXEC mode.
- 
- Step 10     **copy running-config startup-config**  
Save the settings in the configuration file.
- 

 **Note:**

- The member port of an LAG follows the configuration of the LAG and not its own. The configurations of the port can take effect only after it leaves the LAG.
  - The egress rule of the ports dynamically added to the VLAN is tagged.
  - The egress rule of the fixed port should be tagged.
  - When setting the timer values, make sure the values are within the required range. The value for LeaveAll should be greater than or equal to ten times the Leave value. The value for Leave should be greater than or equal to two times the Join value.
- 

The following example shows how to enable GVRP globally and on port 1/0/1, configure the GVRP registration mode as fixed and keep the values of timers as default:

**Switch#configure**

**Switch(config)#gvrp**

**Switch(config)#interface gigabitEthernet 1/0/1**

**Switch(config-if)#gvrp**

**Switch(config-if)#gvrp registration fixed**

**Switch(config-if)#show gvrp global**

GVRP Global Status

-----

Enabled

**Switch(config-if)# show gvrp interface gigabitEthernet 1/0/1**

| Port    | Status  | Reg-Mode | LeaveAll | JoinIn | Leave | LAG |
|---------|---------|----------|----------|--------|-------|-----|
| ----    | -----   | -----    | -----    | -----  | ----- | --- |
| Gi1/0/1 | Enabled | Fixed    | 1000     | 20     | 60    | N/A |

**Switch(config-if)#end**

**Switch#copy running-config startup-config**

# 3 Configuration Example

## 3.1 Network Requirements

Department A and Department B of a company are connected using switches. Offices of one department are distributed on different floors. As shown in Figure 3-1, the network topology is complicated. Configuration of the same VLAN on different switches is required so that computers in the same department can communicate with each other.

Figure 3-1 Network Topology

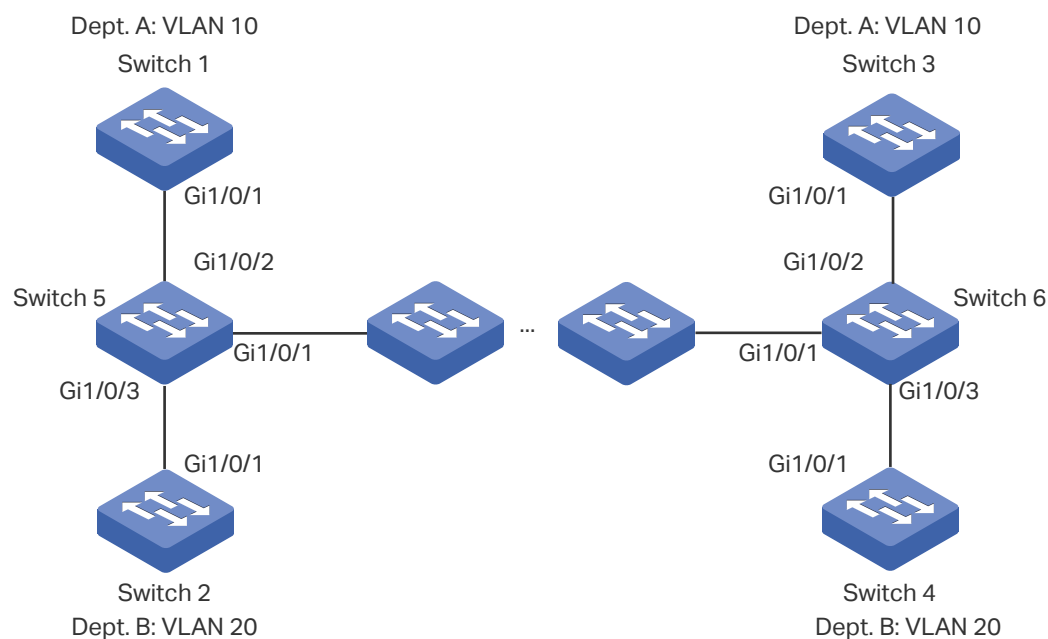

## 3.2 Configuration Scheme

To reduce manual configuration and maintenance workload, GVRP can be enabled to implement dynamic VLAN registration and update on the switches.

When configuring GVRP, please note the following:

- The two departments are in separate VLANs. To make sure the switches only dynamically create VLAN of their own department, you need to set the registration mode for ports on Switch 1 to Switch 4 as Fixed to prevent dynamic registration and deregistration of VLANs and allow the port to transmit only the static VLAN registration information.
- To configure dynamic VLAN creation on other switches, set the registration mode of the corresponding ports as Normal to allow dynamic registration and deregistration of VLANs.

Demonstrated with T1600G-28TS, the following sections provide configuration procedure in two ways: using the GUI and using the CLI.

### 3.3 Using the GUI

GVRP configurations for Switch 3 are the same as Switch 1, and Switch 4 are the same as Switch 2. Other switches share similar configurations.

The following configuration procedures take Switch 1, Switch 2 and Switch 5 as example.

#### ■ Configurations for Switch 1

- 1) Choose the menu **L2 FEATURES > VLAN > 802.1Q VLAN > VLAN Config** and click  **Add** to load the following page. Create VLAN 10 and add tagged port 1/0/1 to it. Click **Create**.

Figure 3-2 Create VLAN 10



**VLAN Config**

VLAN ID:  (2-4094, format: 2,4-5,8)

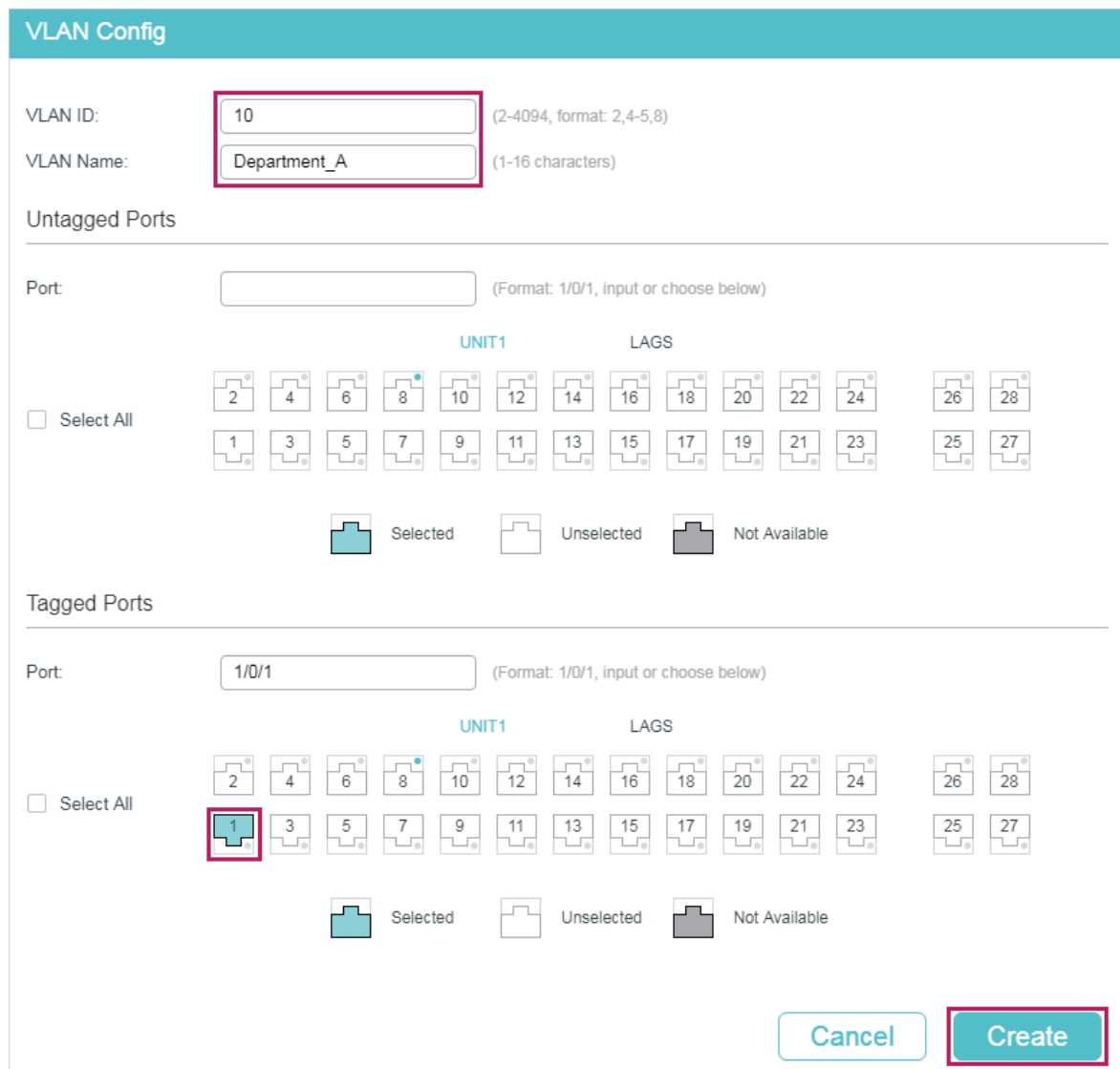
VLAN Name:  (1-16 characters)

Untagged Ports

Port:  (Format: 1/0/1, input or choose below)

Select All

UNIT1 LAGS

|   |   |   |   |    |    |    |    |    |    |    |    |    |    |
|---|---|---|---|----|----|----|----|----|----|----|----|----|----|
| 2 | 4 | 6 | 8 | 10 | 12 | 14 | 16 | 18 | 20 | 22 | 24 | 26 | 28 |
| 1 | 3 | 5 | 7 | 9  | 11 | 13 | 15 | 17 | 19 | 21 | 23 | 25 | 27 |

Selected  Unselected  Not Available

Tagged Ports

Port:  (Format: 1/0/1, input or choose below)

Select All

UNIT1 LAGS

|   |   |   |   |    |    |    |    |    |    |    |    |    |    |
|---|---|---|---|----|----|----|----|----|----|----|----|----|----|
| 2 | 4 | 6 | 8 | 10 | 12 | 14 | 16 | 18 | 20 | 22 | 24 | 26 | 28 |
| 1 | 3 | 5 | 7 | 9  | 11 | 13 | 15 | 17 | 19 | 21 | 23 | 25 | 27 |

Selected  Unselected  Not Available

- 2) Choose the menu **L2 FEATURES > VLAN > GVRP** to load the following page. Enable GVRP globally, then click **Apply**. Select port 1/0/1, set Status as Enable, and set Registration Mode as Fixed. Keep the values of the timers as default. Click **Apply**.

Figure 3-3 GVRP Configuration

**GVRP**

GVRP:  Enable **Apply**

---

Port Config

UNIT1

LAGS

| <input type="checkbox"/>            | ID | Port   | Status   | Registration Mode | LeaveAll Timer (1000-30000 centiseconds) | Join Timer (20-1000 centiseconds) | Leave Timer (60-3000 centiseconds) | LAG |
|-------------------------------------|----|--------|----------|-------------------|--|-----------------------------------|------------------------------------|-----|
| <input checked="" type="checkbox"/> | 1  | 1/0/1  | Enabled  | Fixed             | 1000                                     | 20                                | 60                                 | --- |
| <input type="checkbox"/>            | 2  | 1/0/2  | Disabled | Normal            | 1000                                     | 20                                | 60                                 | --- |
| <input type="checkbox"/>            | 3  | 1/0/3  | Disabled | Normal            | 1000                                     | 20                                | 60                                 | --- |
| <input type="checkbox"/>            | 4  | 1/0/4  | Disabled | Normal            | 1000                                     | 20                                | 60                                 | --- |
| <input type="checkbox"/>            | 5  | 1/0/5  | Disabled | Normal            | 1000                                     | 20                                | 60                                 | --- |
| <input type="checkbox"/>            | 6  | 1/0/6  | Disabled | Normal            | 1000                                     | 20                                | 60                                 | --- |
| <input type="checkbox"/>            | 7  | 1/0/7  | Disabled | Normal            | 1000                                     | 20                                | 60                                 | --- |
| <input type="checkbox"/>            | 8  | 1/0/8  | Disabled | Normal            | 1000                                     | 20                                | 60                                 | --- |
| <input type="checkbox"/>            | 9  | 1/0/9  | Disabled | Normal            | 1000                                     | 20                                | 60                                 | --- |
| <input type="checkbox"/>            | 10 | 1/0/10 | Disabled | Normal            | 1000                                     | 20                                | 60                                 | --- |

Total: 28 1 entry selected. **Cancel** **Apply**

- 3) Click **Save** to save the settings.

■ **Configurations for Switch 2**

- 1) Choose the menu **L2 FEATURES > VLAN > 802.1Q VLAN > VLAN Config** and click **Add** to load the following page. Create VLAN 20 and add tagged port 1/0/1 to it. Click **Create**.

Figure 3-4 Create VLAN 20

### VLAN Config

VLAN ID:  (2-4094, format: 2,4-5,8)

VLAN Name:  (1-16 characters)

---

Untagged Ports

Port:  (Format: 1/0/1, input or choose below)

UNIT1
LAGS

Select All

2

4

6

8

10

12

14

16

18

20

22

24

26

28

1

3

5

7

9

11

13

15

17

19

21

23

25

27

Selected
 

Unselected

Not Available

---

Tagged Ports

Port:  (Format: 1/0/1, input or choose below)

UNIT1
LAGS

Select All

2

4

6

8

10

12

14

16

18

20

22

24

26

28

1

3

5

7

9

11

13

15

17

19

21

23

25

27

Selected
 

Unselected

Not Available

- 2) Choose the menu **L2 FEATURES > VLAN > GVRP** to load the following page. Enable GVRP globally, then click **Apply**. Select port 1/0/1, set Status as Enable, and set Registration Mode as Fixed. Keep the values of the timers as default. Click **Apply**.

Figure 3-5 GVRP Configuration

GVRP

GVRP:  Enable

Port Config

UNIT1 | LAGS

| <input type="checkbox"/>            | ID | Port   | Status   | Registration Mode | LeaveAll Timer (1000-30000 centiseconds) | Join Timer (20-1000 centiseconds) | Leave Timer (60-3000 centiseconds) | LAG |
|-------------------------------------|----|--------|----------|-------------------|--|-----------------------------------|------------------------------------|-----|
| <input checked="" type="checkbox"/> | 1  | 1/0/1  | Enabled  | Fixed             | 1000                                     | 20                                | 60                                 | --- |
| <input type="checkbox"/>            | 2  | 1/0/2  | Disabled | Normal            | 1000                                     | 20                                | 60                                 | --- |
| <input type="checkbox"/>            | 3  | 1/0/3  | Disabled | Normal            | 1000                                     | 20                                | 60                                 | --- |
| <input type="checkbox"/>            | 4  | 1/0/4  | Disabled | Normal            | 1000                                     | 20                                | 60                                 | --- |
| <input type="checkbox"/>            | 5  | 1/0/5  | Disabled | Normal            | 1000                                     | 20                                | 60                                 | --- |
| <input type="checkbox"/>            | 6  | 1/0/6  | Disabled | Normal            | 1000                                     | 20                                | 60                                 | --- |
| <input type="checkbox"/>            | 7  | 1/0/7  | Disabled | Normal            | 1000                                     | 20                                | 60                                 | --- |
| <input type="checkbox"/>            | 8  | 1/0/8  | Disabled | Normal            | 1000                                     | 20                                | 60                                 | --- |
| <input type="checkbox"/>            | 9  | 1/0/9  | Disabled | Normal            | 1000                                     | 20                                | 60                                 | --- |
| <input type="checkbox"/>            | 10 | 1/0/10 | Disabled | Normal            | 1000                                     | 20                                | 60                                 | --- |

Total: 28 1 entry selected.

3) Click  Save to save the settings.

■ Configurations for Switch 5

1) Choose the menu **L2 FEATURES > VLAN > GVRP** to load the following page. Enable GVRP globally, then click **Apply**. Select ports 1/0/1-3, set Status as Enable, and keep the Registration Mode and the values of the timers as default. Click **Apply**.



Figure 3-6 GVRP Configuration

GVRP

GVRP:  Enable

Port Config

UNIT1 | LAGS

| <input type="checkbox"/>            | ID | Port   | Status   | Registration Mode | LeaveAll Timer (1000-30000 centiseconds) | Join Timer (20-1000 centiseconds) | Leave Timer (60-3000 centiseconds) | LAG |
|-------------------------------------|----|--------|----------|-------------------|--|-----------------------------------|------------------------------------|-----|
| <input checked="" type="checkbox"/> | 1  | 1/0/1  | Enabled  | Normal            | 1000                                     | 20                                | 60                                 | --- |
| <input checked="" type="checkbox"/> | 2  | 1/0/2  | Enabled  | Normal            | 1000                                     | 20                                | 60                                 | --- |
| <input checked="" type="checkbox"/> | 3  | 1/0/3  | Enabled  | Normal            | 1000                                     | 20                                | 60                                 | --- |
| <input type="checkbox"/>            | 4  | 1/0/4  | Disabled | Normal            | 1000                                     | 20                                | 60                                 | --- |
| <input type="checkbox"/>            | 5  | 1/0/5  | Disabled | Normal            | 1000                                     | 20                                | 60                                 | --- |
| <input type="checkbox"/>            | 6  | 1/0/6  | Disabled | Normal            | 1000                                     | 20                                | 60                                 | --- |
| <input type="checkbox"/>            | 7  | 1/0/7  | Disabled | Normal            | 1000                                     | 20                                | 60                                 | --- |
| <input type="checkbox"/>            | 8  | 1/0/8  | Disabled | Normal            | 1000                                     | 20                                | 60                                 | --- |
| <input type="checkbox"/>            | 9  | 1/0/9  | Disabled | Normal            | 1000                                     | 20                                | 60                                 | --- |
| <input type="checkbox"/>            | 10 | 1/0/10 | Disabled | Normal            | 1000                                     | 20                                | 60                                 | --- |

Total: 28 3 entries selected.

- 2) Click  Save to save the settings.

### 3.4 Using the CLI

GVRP configuration for Switch 3 is the same as Switch 1, and Switch 4 the same as Switch 2. Other switches share similar configurations.

The following configuration procedures take Switch 1, Switch 2 and Switch 5 as example.

#### ■ Configurations for Switch 1

- 1) Enable GVRP globally.

```
Switch_1#configure
```

```
Switch_1(config)#gvrp
```

- 2) Create VLAN 10.

```
Switch_1(config)#vlan 10
```

```
Switch_1(config-vlan)#name Department_A
```

```
Switch_1(config-vlan)#exit
```

- 3) Add tagged port 1/0/1 to VLAN 10. Enable GVRP on the port and set the registration mode as Fixed.

```
Switch_1(config)#interface gigabitEthernet 1/0/1
Switch_1(config-if)#switchport general allowed vlan 10 tagged
Switch_1(config-if)#gvrp
Switch_1(config-if)#gvrp registration fixed
Switch_1(config-if)#end
Switch_1#copy running-config startup-config
```

#### ■ Configurations for Switch 2

- 1) Enable GVRP globally.

```
Switch_2#configure
Switch_2(config)#gvrp
```

- 2) Create VLAN 20.

```
Switch_2(config)#vlan 20
Switch_2(config-vlan)#name Department_B
Switch_2(config-vlan)#exit
```

- 3) Add tagged port 1/0/1 to VLAN 20. Enable GVRP on the port and set the registration mode as Fixed.

```
Switch_2(config)#interface gigabitEthernet 1/0/1
Switch_2(config-if)#switchport general allowed vlan 20 tagged
Switch_2(config-if)#gvrp
Switch_2(config-if)#gvrp registration fixed
Switch_2(config-if)#end
Switch_2#copy running-config startup-config
```

#### ■ Configurations for Switch 5

- 1) Enable GVRP globally.

```
Switch_5#configure
Switch_5(config)#gvrp
```

- 2) Enable GVRP on ports 1/0/1-3.

```
Switch_5(config)#interface range gigabitEthernet 1/0/1-3
Switch_5(config-if-range)#gvrp
Switch_5(config-if-range)#end
```

```
Switch_5#copy running-config startup-config
```

## Verify the Configuration

### ■ Switch 1

Verify the global GVRP configuration:

```
Switch_1#show gvrp global
```

```
GVRP Global Status
```

```
-----
```

```
Enabled
```

Verify GVRP configuration for port 1/0/1:

```
Switch_1#show gvrp interface
```

| Port    | Status   | Reg-Mode | LeaveAll | JoinIn | Leave | LAG |
|---------|----------|----------|----------|--------|-------|-----|
| ----    | -----    | -----    | -----    | -----  | ----- | --- |
| Gi1/0/1 | Enabled  | Fixed    | 1000     | 20     | 60    | N/A |
| Gi1/0/2 | Disabled | Normal   | 1000     | 20     | 60    | N/A |
| ...     |          |          |          |        |       |     |

### ■ Switch 2

Verify the global GVRP configuration:

```
Switch_2#show gvrp global
```

```
GVRP Global Status
```

```
-----
```

```
Enabled
```

Verify GVRP configuration for port 1/0/1:

```
Switch_2#show gvrp interface
```

| Port    | Status  | Reg-Mode | LeaveAll | JoinIn | Leave | LAG |
|---------|---------|----------|----------|--------|-------|-----|
| ----    | -----   | -----    | -----    | -----  | ----- | --- |
| Gi1/0/1 | Enabled | Fixed    | 1000     | 20     | 60    | N/A |

```

Gi1/0/2 Disabled Normal 1000 20 60 N/A
...

```

#### ■ Switch 5

Verify global GVRP configuration:

GVRP Global Status

-----

Enabled

Verify GVRP configuration for ports 1/0/1-3:

Switch\_5#show gvrp interface

| Port    | Status   | Reg-Mode | LeaveAll | JoinIn | Leave | LAG |
|---------|----------|----------|----------|--------|-------|-----|
| ----    | -----    | -----    | -----    | -----  | ----- | --- |
| Gi1/0/1 | Enabled  | Normal   | 1000     | 20     | 60    | N/A |
| Gi1/0/2 | Enabled  | Normal   | 1000     | 20     | 60    | N/A |
| Gi1/0/3 | Enabled  | Normal   | 1000     | 20     | 60    | N/A |
| Gi1/0/4 | Disabled | Normal   | 1000     | 20     | 60    | N/A |
| ...     |          |          |          |        |       |     |

# 4 Appendix: Default Parameters

Default settings of GVRP are listed in the following tables.

Table 4-1 Default Settings of GVRP

| Parameter         | Default Setting   |
|-------------------|-------------------|
| Global Config     |                   |
| GVRP              | Disabled          |
| Port Config       |                   |
| Status            | Disabled          |
| Registration Mode | Normal            |
| LeaveAll Timer    | 1000 centiseconds |
| Join Timer        | 20 centiseconds   |
| Leave Timer       | 60 centiseconds   |

# Part 10

## Configuring Layer 2 Multicast

### CHAPTERS

1. Layer 2 Multicast
2. IGMP Snooping Configuration
3. MLD Snooping Configuration
4. MVR Configuration
5. Multicast Filtering Configuration
6. Viewing Multicast Snooping Information
7. Configuration Examples
8. Appendix: Default Parameters

# 1 Layer 2 Multicast

## 1.1 Overview

In a point-to-multipoint network, packets can be sent in three ways: unicast, broadcast and multicast. With unicast, many copies of the same information will be sent to all the receivers, occupying a large bandwidth.

With broadcast, information will be sent to all users in the network no matter they need it or not, wasting network resources and impacting information security.

Multicast, however, solves all the problems caused by unicast and broadcast. With multicast, the source only need to send one piece of information, and all and only the users who need the information will receive copies of the information. In a point-to-multipoint network, multicast technology not only transmits data with high efficiency, but also saves a large bandwidth and reduces network load.

In practical applications, Internet information provider can provide value-added services such as Online Live, IPTV, Distance Education, Telemedicine, Internet Radio and Real-time Video Conferences more conveniently using multicast.

Layer 2 Multicast allows Layer 2 switches to listen for IGMP (Internet Group Management Protocol) packets between IGMP Querier and user hosts to establish multicast forwarding table and to manage and control transmission of packets.

Take IGMP Snooping as an example. When IGMP Snooping is disabled on the Layer 2 device, multicast packets will be broadcast in the Layer 2 network; when IGMP Snooping is enabled on the Layer 2 device, multicast data from a known multicast group will be transmitted to the designated receivers instead of being broadcast in the Layer 2 network.

Demonstrated as below:

Figure 1-1 IGMP Snooping

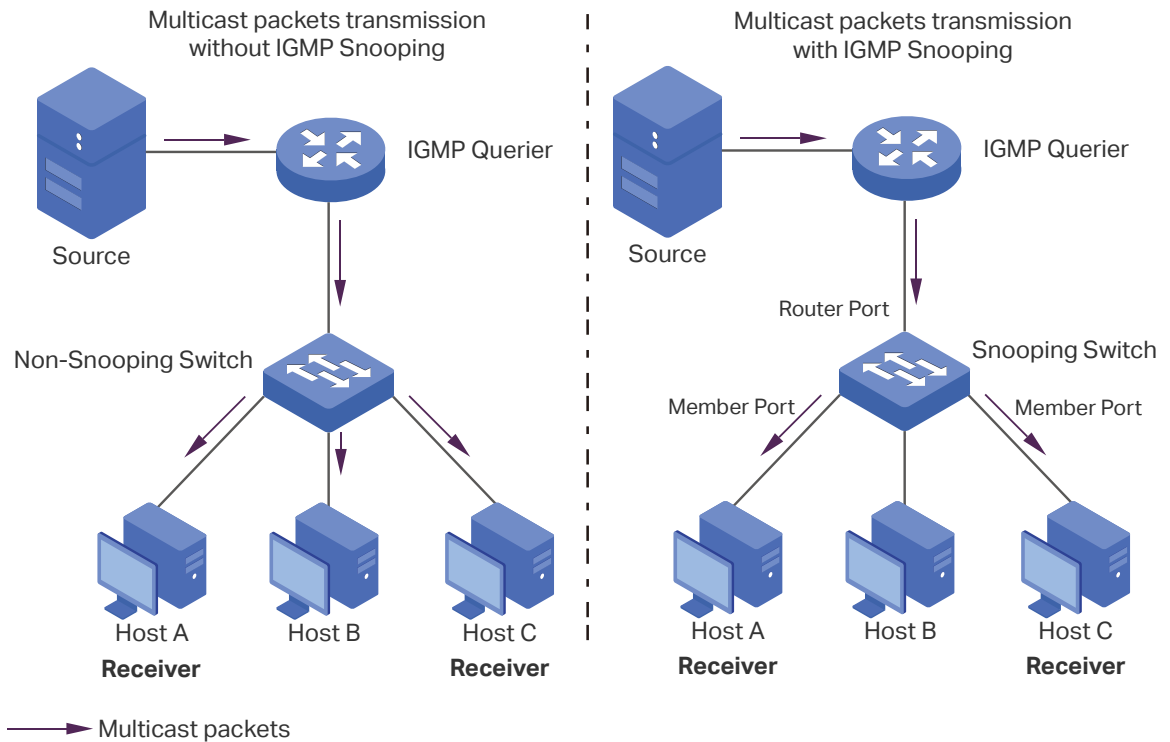

The following basic concepts of IGMP Snooping will be introduced: IGMP querier, snooping switch, router port and member port.

### IGMP Querier

An IGMP querier is a multicast router (a router or a Layer 3 switch) that sends query messages to maintain a list of multicast group memberships for each attached network, and a timer for each membership.

Normally only one device acts as querier per physical network. If there are more than one multicast router in the network, a querier election process will be implemented to determine which one acts as the querier.

### Snooping Switch

A snooping switch indicates a switch with IGMP Snooping enabled. The switch maintains a multicast forwarding table by snooping on the IGMP transmissions between the host and the querier. With the multicast forwarding table, the switch can forward multicast data only to the ports that are in the corresponding multicast group, so as to constrain the flooding of multicast data in the Layer 2 network.

### Router Port

A router port is a port on snooping switch that is connecting to the IGMP querier.

### Member Port

A member port is a port on snooping switch that is connecting to the host.



## 1.2 Supported Features

### Layer 2 Multicast protocol for IPv4: IGMP Snooping

On the Layer 2 device, IGMP Snooping transmits data on demand on data link layer by analyzing IGMP packets between the IGMP querier and the users, to build and maintain Layer 2 multicast forwarding table.

### Layer 2 Multicast protocol for IPv6: MLD Snooping

On the Layer 2 device, MLD Snooping (Multicast Listener Discovery Snooping) transmits data on demand on data link layer by analyzing MLD packets between the MLD querier and the users, to build and maintain Layer 2 multicast forwarding table.

### Multicast VLAN Registration (MVR)

MVR allows a single multicast VLAN to be shared for multicast member ports in different VLANs in IPv4 network. In IGMP Snooping, if member ports are in different VLANs, a copy of the multicast streams is sent to each VLAN that has member ports. While MVR provides a dedicated multicast VLAN to forward multicast traffic over the Layer 2 network, to avoid duplication of multicast streams for clients in different VLANs. Clients can dynamically join or leave the multicast VLAN without interfering with their relationships in other VLANs.

There are two types of MVR modes:

- Compatible Mode

In compatible mode, the MVR switch does not forward report or leave messages from the hosts to the IGMP querier. So the IGMP querier cannot learn the multicast groups membership information from the MVR switch. You have to statically configure the IGMP querier to transmit all the required multicast streams to the MVR switch via the multicast VLAN.

- Dynamic Mode

In dynamic mode, after receiving report or leave messages from the hosts, the MVR switch will forward them to the IGMP querier via the multicast VLAN (with appropriate translation of the VLAN ID). So the IGMP querier can learn the multicast groups membership information through the report and leave messages, and transmit the multicast streams to the MVR switch via the multicast VLAN according to the multicast forwarding table.

### Multicast Filtering

Multicast Filtering allows you to control the set of multicast groups to which a host can belong. You can filter multicast joins on a per-port basis by configuring IP multicast profiles (IGMP profiles or MLD profiles) and associating them with individual switch ports.

# 2 IGMP Snooping Configuration

To complete IGMP Snooping configuration, follow these steps:

- 1) Enable IGMP Snooping globally and configure the global parameters.
- 2) Configure IGMP Snooping for VLANs.
- 3) Configure IGMP Snooping for ports.
- 4) (Optional) Configure hosts to statically join a group.

## Note:

IGMP Snooping takes effect only when it is enabled globally, in the corresponding VLAN and port at the same time.

## 2.1 Using the GUI

### 2.1.1 Configuring IGMP Snooping Globally

Choose the menu **L2 FEATURES > Multicast > IGMP Snooping > Global Config** to load the following page.

Figure 2-1 Configure IGMP Snooping Globally

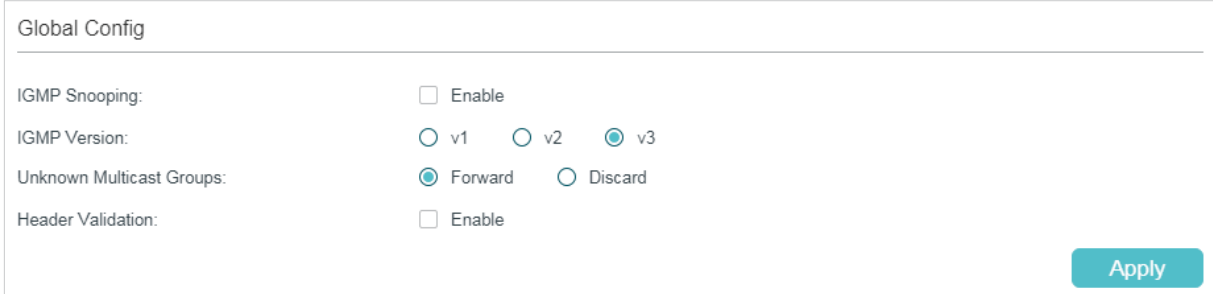

| Global Config             |   |
|---------------------------|---|
| IGMP Snooping:            | <input type="checkbox"/> Enable   |
| IGMP Version:             | <input type="radio"/> v1 <input type="radio"/> v2 <input checked="" type="radio"/> v3 |
| Unknown Multicast Groups: | <input checked="" type="radio"/> Forward <input type="radio"/> Discard                |
| Header Validation:        | <input type="checkbox"/> Enable   |
| <a href="#">Apply</a>     |   |

Follow these steps to configure IGMP Snooping globally:

- 1) In the **Global Config** section, enable IGMP Snooping globally and configure the global parameters.

|               |   |
|---------------|---|
| IGMP Snooping | Enable or disable IGMP Snooping globally. |
|---------------|---|

|                          |   |
|--------------------------|---|
| IGMP Version             | <p>Specify the IGMP version.</p> <p><b>v1:</b> The switch works as an IGMPv1 Snooping switch. It can only process IGMPv1 messages from the host. Messages of other versions are ignored.</p> <p><b>v2:</b> The switch works as an IGMPv2 Snooping switch. It can process both IGMPv1 and IGMPv2 messages from the host. IGMPv3 messages are ignored.</p> <p><b>v3:</b> The switch works as an IGMPv3 Snooping switch. It can process IGMPv1, IGMPv2 and IGMPv3 messages from the host.</p>  |
| Unknown Multicast Groups | <p>Set the way in which the switch processes data that are sent to unknown multicast groups as Forward or Discard. By default, it is Forward.</p> <p>Unknown multicast groups are multicast groups that do not match any of the groups announced in earlier IGMP membership reports, and thus cannot be found in the multicast forwarding table of the switch.</p> <p><b>Note:</b> IGMP Snooping and MLD Snooping share the setting of Unknown Multicast Groups, so you have to enable MLD Snooping globally on the <b>L2 FEATURES &gt; Multicast &gt; MLD Snooping &gt; Global Config</b> page at the same time.</p> |
| Header Validation        | <p>Enable or disable Header Validation. By default, it is disabled.</p> <p>Generally, for IGMP packets, the TTL value should be 1, ToS field should be 0xC0, and Router Alert option should be 0x94040000. The fields to be validated depend on the IGMP version being used. IGMPv1 only checks the TTL field. IGMPv2 checks the TTL field and the Router Alert option. IGMPv3 checks TTL field, ToS field and Router Alert option. Packets that fail the validation process will be dropped.</p>   |

2) Click **Apply**.

## 2.1.2 Configuring IGMP Snooping for VLANs

Before configuring IGMP Snooping for VLANs, set up the VLANs that the router ports and the member ports are in. For details, please refer to [Configuring 802.1Q VLAN](#).

The switch supports configuring IGMP Snooping on a per-VLAN basis. After IGMP Snooping is enabled globally, you also need to enable IGMP Snooping and configure the corresponding parameters for the VLANs that the router ports and the member ports are in.

Choose the menu **L2 FEATURES > Multicast > IGMP Snooping > Global Config**, and click  in your desired VLAN entry in the **IGMP VLAN Config** section to load the following page.

Figure 2-2 Configure IGMP Snooping for VLAN

Configure IGMP Snooping for VLAN

|                         |  |                  |
|-------------------------|--|------------------|
| VLAN ID:                | 1  |                  |
| IGMP Snooping Status:   | <input type="checkbox"/> Enable                        |                  |
| Fast Leave:             | <input type="checkbox"/> Enable                        |                  |
| Report Suppression:     | <input type="checkbox"/> Enable                        |                  |
| Member Port Aging Time: | <input style="width: 100px;" type="text" value="260"/> | seconds (60-600) |
| Router Port Aging Time: | <input style="width: 100px;" type="text" value="300"/> | seconds (60-600) |
| Leave Time:             | <input style="width: 100px;" type="text" value="1"/>   | seconds (1-30)   |
| IGMP Snooping Querier:  | <input type="checkbox"/> Enable                        |                  |
| Static Router Ports     |  |                  |

Follow these steps to configure IGMP Snooping for a specific VLAN:

- 1) Enable IGMP Snooping for the VLAN, and configure the corresponding parameters.

|                             |  |
|-----------------------------|--|
| <b>VLAN ID</b>              | Displays the VLAN ID.  |
| <b>IGMP Snooping Status</b> | Enable or disable IGMP Snooping for the VLAN.  |
| <b>Fast Leave</b>           | <p>Enable or disable Fast Leave for the VLAN. IGMPv1 does not support Fast Leave.</p> <p>Without Fast Leave, after a receiver sends an IGMP leave message to leave a multicast group, the switch will forward the leave message to the Layer 3 device (the querier).</p> <p>From the point of view of the querier, the port connecting to the switch is a member port of the corresponding multicast group. After receiving the leave message from the switch, the querier will send out a configured number (Last Member Query Count) of group-specific queries on that port with a configured interval (Last Member Query Interval), and wait for IGMP group membership reports. If there are other receivers connecting to the switch, they will response to the queries before the Last Member Query Interval expires. If no reports are received after the response time of the last query expires, the querier will remove the port from the forwarding list of the corresponding multicast group.</p> <p>That is, if there are other receivers connecting to the switch, the one sent leave message have to wait until the port ages out from the switch's forwarding list of the corresponding multicast group (the maximum waiting time is decided by the Member Port Aging Time).</p> <p>With Fast Leave enabled on a VLAN, the switch will remove the (Multicast Group, Port, VLAN) entry from the multicast forwarding table before forwarding the leave message to the querier. This helps to reduce bandwidth waste since the switch no longer sends the corresponding multicast streams to the VLAN of the port as soon as the port receives a leave message from the VLAN.</p> |

---

|                        |  |
|------------------------|--|
| Report Suppression     | <p>Enable or disable Report Suppression for the VLAN.</p> <p>When enabled, the switch will only forward the first IGMP report message for each multicast group to the IGMP querier and suppress subsequent IGMP report messages for the same multicast group during one query interval. This feature prevents duplicate report messages from being sent to the IGMP querier.</p>   |
| Member Port Aging Time | <p>Specify the aging time of the member ports in the VLAN.</p> <p>Once the switch receives an IGMP membership report message from a port, the switch adds this port to the member port list of the corresponding multicast group. Member ports that are learned in this way are called dynamic member ports.</p> <p>If the switch does not receive any IGMP membership report messages for a specific multicast group from a dynamic member port, it will no longer consider this port as a member port of this multicast group and delete it from the multicast forwarding table.</p>   |
| Router Port Aging Time | <p>Specify the aging time of the router ports in the VLAN.</p> <p>Once the switch receives an IGMP general query message from a port, the switch adds this port to the router port list. Router ports that are learned in this way are called dynamic router ports.</p> <p>If the switch does not receive any IGMP general query message from a dynamic router port within the router port aging time, the switch will no longer consider this port as a router port and delete it from the router port list.</p>  |
| Leave Time             | <p>Specify the leave time for the VLAN.</p> <p>When the switch receives a leave message from a port to leave a multicast group, it will wait for a leave time before removing the port from the multicast group. During the period, if the switch receives any report messages from the port, the port will not be removed from the multicast group. Exceptions are as follows:</p> <ul style="list-style-type: none"><li>• If the member port ages out before the Leave Time ends and no report messages are received, the port will be removed from the multicast group once its Member Port Aging Time ends.</li><li>• The Leave Time mechanism will not take effect when Fast Leave takes effect.</li></ul> <p>A proper leave time value can avoid other hosts connecting to the same port of the switch being mistakenly removed from the multicast group when only some of them want to leave.</p> |
| IGMP Snooping Querier  | <p>Enable or disable the IGMP Snooping Querier for the VLAN.</p> <p>When enabled, the switch acts as an IGMP Snooping Querier for the hosts in this VLAN. A querier periodically sends a general query on the network to solicit membership information, and sends group-specific queries when it receives leave messages from hosts.</p> <p><b>Note:</b></p> <p>To enable IGMP Snooping Querier for a VLAN, IGMP Snooping should be enabled both globally and in the VLAN.</p>  |

---

|                            |   |
|----------------------------|---|
| Query Interval             | With IGMP Snooping Querier enabled, specify the interval between general query messages sent by the switch.   |
| Maximum Response Time      | With IGMP Snooping Querier enabled, specify the host's maximum response time to general query messages.   |
| Last Member Query Interval | With IGMP Snooping Querier enabled, when the switch receives an IGMP leave message, it obtains the address of the multicast group that the host wants to leave from the message. Then the switch sends out group-specific queries to this multicast group through the port receiving the leave message. This parameter determines the interval between group-specific queries.            |
| Last Member Query Count    | With IGMP Snooping Querier enabled, specify the number of group-specific queries to be sent. If specified count of group-specific queries are sent and no report message is received, the switch will delete the multicast address from the multicast forwarding table.   |
| General Query Source IP    | With IGMP Snooping Querier enabled, specify the source IP address of the general query messages sent by the switch. It should be a unicast address.   |
| Static Router Ports        | <p>Select one or more ports to be the static router ports in the VLAN. Static router ports do not age.</p> <p>Multicast streams and IGMP packets to all groups in this VLAN will be forwarded through the static router ports. Multicast streams and IGMP packets to the groups that have dynamic router ports will be also forwarded through the corresponding dynamic router ports.</p> |
| Forbidden Router Ports     | Select ports to forbid them from being router ports in the VLAN.  |

2) Click **Save**.

## 2.1.3 Configuring IGMP Snooping for Ports

Choose the menu **L2 FEATURES > Multicast > IGMP Snooping > Port Config** to load the following page.

Figure 2-3 Configure IGMP Snooping for Ports

| UNIT1                               | LAGS | Port   | IGMP Snooping | Fast Leave | LAG |
|-------------------------------------|------|--------|---------------|------------|-----|
| <input checked="" type="checkbox"/> |      | 1/0/1  | Enabled       | Disabled   | --- |
| <input type="checkbox"/>            |      | 1/0/2  | Enabled       | Disabled   | --- |
| <input type="checkbox"/>            |      | 1/0/3  | Enabled       | Disabled   | --- |
| <input type="checkbox"/>            |      | 1/0/4  | Enabled       | Disabled   | --- |
| <input type="checkbox"/>            |      | 1/0/5  | Enabled       | Disabled   | --- |
| <input type="checkbox"/>            |      | 1/0/6  | Enabled       | Disabled   | --- |
| <input type="checkbox"/>            |      | 1/0/7  | Enabled       | Disabled   | --- |
| <input type="checkbox"/>            |      | 1/0/8  | Enabled       | Disabled   | --- |
| <input type="checkbox"/>            |      | 1/0/9  | Enabled       | Disabled   | --- |
| <input type="checkbox"/>            |      | 1/0/10 | Enabled       | Disabled   | --- |

Total: 28      1 entry selected.     

Follow these steps to configure IGMP Snooping for ports:

- 1) Enable IGMP Snooping for the port and enable Fast Leave if there is only one receiver connected to the port.

**IGMP Snooping**      Enable or disable IGMP Snooping for the port.

**Fast Leave**      Enable or disable Fast Leave for the port. IGMPv1 does not support fast leave.

Fast Leave can be enabled on a per-port basis or per-VLAN basis. When enabled on a per-port basis, the switch will remove the port from the corresponding multicast group of all VLANs before forwarding the leave message to the querier.

You should only use Fast Leave for a port when there is a single receiver connected to the port. For more details about Fast Leave, see ["2.1.2 Configuring IGMP Snooping for VLANs"](#).

**LAG**      Displays the LAG the port belongs to.

- 2) Click **Apply**.

## 2.1.4 Configuring Hosts to Statically Join a Group

Hosts or Layer 2 ports normally join multicast groups dynamically, but you can also configure hosts to statically join a group.

Choose the menu **L2 FEATURES > Multicast > IGMP Snooping > Static Group Config** and click **+ Add** to load the following page.

Figure 2-4 Configure Hosts to Statically Join a Group

Follow these steps to configure hosts to statically join a group:

- 1) Specify the multicast IP address, VLAN ID. Select the ports to be the static member ports of the multicast group.

|                     |  |
|---------------------|--|
| <b>Multicast IP</b> | Specify the address of the multicast group that the hosts need to join.  |
| <b>VLAN ID</b>      | Specify the VLAN that the hosts are in.  |
| <b>Member Ports</b> | Select the ports that the hosts are connected to. These ports will become the static member ports of the multicast group and will never age. |

- 2) Click **Create**.

## 2.2 Using the CLI

### 2.2.1 Configuring IGMP Snooping Globally

Follow these steps to configure IGMP Snooping globally:

|               |   |
|---------------|---|
| <b>Step 1</b> | <b>configure</b><br>Enter global configuration mode.      |
| <b>Step 2</b> | <b>ip igmp snooping</b><br>Enable IGMP Snooping Globally. |



- 
- Step 3     **ip igmp snooping version {v1 | v2 | v3}**  
Configure the IGMP version.
- v1:**The switch works as an IGMPv1 Snooping switch. It can only process IGMPv1 report messages from the host. Report messages of other versions are ignored.
- v2:** The switch works as an IGMPv2 Snooping switch. It can process both IGMPv1 and IGMPv2 report messages from the host. IGMPv3 report messages are ignored.
- v3:** The switch works as an IGMPv3 Snooping switch. It can process IGMPv1, IGMPv2 and IGMPv3 report messages from the host.
- 
- Step 4     **ip igmp snooping drop-unknown**  
(Optional) Configure the way how the switch processes multicast streams that are sent to unknown multicast groups as Discard. By default, it is Forward.
- Unknown multicast groups are multicast groups that do not match any of the groups announced in earlier IGMP membership reports, and thus cannot be found in the multicast forwarding table of the switch.
- Note:** IGMP Snooping and MLD Snooping share the setting of Unknown Multicast Groups, you need to ensure MLD Snooping is enabled globally. To enable MLD Snooping globally, use the **ipv6 mld snooping** command in global configuration mode.
- 
- Step 5     **ip igmp snooping header-validation**  
(Optional) Enable header validation.
- Generally, for IGMP packets, the TTL value should be 1, ToS field should be 0xC0, and Router Alert option should be 0x94040000. The fields validated depend on the IGMP version being used. IGMPv1 only checks the TTL field. IGMPv2 checks the TTL field and the Router Alert option. IGMPv3 checks TTL field, ToS field and Router Alert option. Packets that fail the validation process will be dropped.
- 
- Step 6     **show ip igmp snooping**  
Show the basic IGMP Snooping configuration.
- 
- Step 7     **end**  
Return to privileged EXEC mode.
- 
- Step 8     **copy running-config startup-config**  
Save the settings in the configuration file.
- 

The following example shows how to enable IGMP Snooping and header validation globally, and specify the IGMP Snooping version as IGMPv3, the way how the switch processes multicast streams that are sent to unknown multicast groups as discard.

**Switch#configure**

**Switch(config)#ip igmp snooping**

**Switch(config)#ip igmp snooping version v3**

**Switch(config)#ipv6 mld snooping**

**Switch(config)#ip igmp snooping drop-unknown**

```
Switch(config)#ip igmp snooping header-validation
```

```
Switch(config)#show ip igmp snooping
```

```
IGMP Snooping          :Enable
```

```
IGMP Version           :V3
```

```
Unknown Multicast      :Discard
```

```
Header Validation      :Enable
```

```
...
```

```
Switch(config)#end
```

```
Switch#copy running-config startup-config
```

## 2.2.2 Configuring IGMP Snooping for VLANs

Before configuring IGMP Snooping for VLANs, set up the VLANs that the router ports and the member ports are in. For details, please refer to [Configuring 802.1Q VLAN](#).

The switch supports configuring IGMP Snooping on a per-VLAN basis. After IGMP Snooping is enabled globally, you also need to enable IGMP Snooping and configure the corresponding parameters for the VLANs that the router ports and the member ports are in.

Follow these steps to configure IGMP Snooping for VLANs:

---

Step 1     **configure**

Enter global configuration mode.

---

Step 2     **ip igmp snooping vlan-config** *vlan-id-list* **mtime** *member-time*

Enable IGMP Snooping for the specified VLANs, and specify the member port aging time for the VLANs.

*vlan-id-list*: Specify the ID or the ID list of the VLAN(s).

*member-time*: Specify the aging time of the member ports in the specified VLANs. Valid values are from 60 to 600 seconds. By default, it is 260 seconds.

Once the switch receives an IGMP membership report message from a port, the switch adds this port to the member port list of the corresponding multicast group. Member ports that are learned in this way are called dynamic member ports.

If the switch does not receive any IGMP membership report message for a specific multicast group from a dynamic member port, it will no longer consider this port as a member port of this multicast group and delete it from the multicast forwarding table.

---

---

**Step 3** **ip igmp snooping vlan-config *vlan-id-list* rtime *router-time***

Specify the router port aging time for the VLANs.

*vlan-id-list*: Specify the ID or the ID list of the VLAN(s).

*router-time*: Specify the aging time of the router ports in the specified VLANs. Valid values are from 60 to 600 seconds. By default, it is 300 seconds.

Once the switch receives an IGMP general query message from a port, the switch adds this port to the router port list. Router ports that are learned in this way are called dynamic router ports.

If the switch does not receive any IGMP general query message from a dynamic router port within the router port aging time, the switch will no longer consider this port as a router port and delete it from the router port list.

---

**Step 4** **ip igmp snooping vlan-config *vlan-id-list* ltime *leave-time***

Specify the router port aging time for the VLANs.

*vlan-id-list*: Specify the ID or the ID list of the VLAN(s).

*leave-time*: Specify the leave time for the VLAN(s). Valid values are from 1 to 30 in seconds, and the default value is 1 second.

When the switch receives a leave message from a port to leave a multicast group, it will wait for a leave time before removing the port from the multicast group. During the period, if the switch receives any report messages from the port, the port will not be removed from the multicast group. Exceptions are as follows:

- If the member port ages out before the Leave Time ends and no report messages are received, the port will be removed from the multicast group once its Member Port Aging Time ends.
- The Leave Time mechanism will not take effect when Fast Leave takes effect.

A proper leave time value can avoid other hosts connecting to the same port of the switch being mistakenly removed from the multicast group when only some of them want to leave.

---

**Step 5** **ip igmp snooping vlan-config *vlan-id-list* report-suppression**

(Optional) Enable the Report Suppression for the VLANs. By default, it is disabled.

When enabled, the switch will only forward the first IGMP report message for each multicast group to the IGMP querier and suppress subsequent IGMP report messages for the same multicast group during one query interval. This feature prevents duplicate report messages from being sent to the IGMP querier.

*vlan-id-list*: Specify the ID or the ID list of the VLAN(s).

---

---

**Step 6** **ip igmp snooping vlan-config *vlan-id-list* immediate-leave**

(Optional) Enable the Fast Leave for the VLANs. By default, it is disabled. IGMPv1 does not support fast leave.

Without Fast Leave, after a receiver sends an IGMP leave message to leave a multicast group, the switch will forward the leave message to the Layer 3 device (the querier).

From the point of view of the querier, the port connecting to the switch is a member port of the corresponding multicast group. After receiving the leave message from the switch, the querier will send out a configured number (Last Member Query Count) of group-specific queries on that port with a configured interval (Last Member Query Interval), and wait for IGMP group membership reports. If there are other receivers connecting to the switch, they will response to the queries before the Last Member Query Interval expires. If no reports are received after the response time of the last query expires, the querier will remove the port from the forwarding list of the corresponding multicast group.

That is, if there are other receivers connecting to the switch, the one sent leave message have to wait until the port ages out from the switch's forwarding list of the corresponding multicast group (the maximum waiting time is decided by the Member Port Aging Time).

With Fast Leave enabled on a VLAN, the switch will remove the (Multicast Group, Port, VLAN) entry from the multicast forwarding table before forwarding the leave message to the querier. This helps to reduce bandwidth waste since the switch no longer sends the corresponding multicast streams to the VLAN of the port as soon as the port receives a leave message from the VLAN.

You should only enable Fast Leave for a VLAN when there is a single receiver belongs to this VLAN on every port of the VLAN.

*vlan-id-list*: Specify the ID or the ID list of the VLAN(s).

---

**Step 7** **ip igmp snooping vlan-config *vlan-id-list* rport interface { fastEthernet *port-list* | gigabitEthernet *port-list* | ten-gigabitEthernet *port-list*| port-channel *lag-list* }**

(Optional) Specify the static router ports for the VLANs. Static router ports do not age.

*vlan-id-list*: Specify the ID or the ID list of the VLAN(s).

*port-list*: The number or the list of the Ethernet port that need to be configured as static router ports.

*lag-list*: The ID or the list of the LAG that need to be configured as static router ports.

---

**Step 8** **ip igmp snooping vlan-config *vlan-id-list* router-ports-forbidden interface { fastEthernet *port-list* | gigabitEthernet *port-list* | ten-gigabitEthernet *port-list*| port-channel *lag-list* }**

(Optional) Specify the ports to forbid them from being router ports in the VLANs.

*vlan-id-list*: Specify the ID or the ID list of the VLAN(s).

*port-list*: The number or the list of the Ethernet port that need to be forbidden from being router ports.

*lag-list*: The ID or the list of the LAG that need to be forbidden from being router ports.

---

**Step 9 ip igmp snooping vlan-config vlan-id-list querier**

(Optional) Enable the IGMP Snooping Querier for the VLAN. By default, it is disabled.

When enabled, the switch acts as an IGMP Snooping Querier for the hosts in this VLAN. A querier periodically sends a general query on the network to solicit membership information, and sends group-specific queries when it receives leave messages from hosts.

*vlan-id-list*: Specify the ID or the ID list of the VLAN(s).

**Note:**

To enable IGMP Snooping Querier for a VLAN, IGMP Snooping should be enabled both globally and in the VLAN.

After enabling IGMP Snooping Querier feature, you need to specify the corresponding parameters including the Last Member Query Count, Last Member Query Interval, Maximum Response Time, Query Interval and General Query Source IP. Use the command below in global configuration mode to configure the parameters:

```
ip igmp snooping vlan-config vlan-id-list querier { max-response-time response-time |
query-interval interval | general-query source-ip ip-addr | last-member-query-count num |
last-member-query-interval interval }
```

*vlan-id-list*: Specify the ID or the ID list of the VLAN(s).

*response-time*: Specify the host's maximum response time to general query messages. Valid values are from 1 to 25 seconds, and the default value is 10 seconds.

*query-interval interval*: Specify the interval between general query messages sent by the switch. Valid values are from 10 to 300 seconds, and the default value is 60 seconds.

*ip-addr*: Specify the source IP address of the general query messages sent by the switch. It should be a unicast address. By default, it is 0.0.0.0.

*num*: Specify the number of group-specific queries to be sent. With IGMP Snooping Querier enabled, when the switch receives an IGMP leave message, it obtains the address of the multicast group that the host wants to leave from the message. Then the switch sends out group-specific queries to this multicast group through the port receiving the leave message. If specified count of group-specific queries are sent and no report message is received, the switch will delete the multicast address from the multicast forwarding table. Valid values are from 1 to 5, and the default value is 2.

*last-member-query-interval interval*: Specify the interval between group-specific queries. Valid values are from 1 to 5 seconds, and the default value is 1 second.

**Step 10 show ip igmp snooping vlan vlan-id**

Show the basic IGMP Snooping configuration in the specified VLAN.

**Step 11 end**

Return to privileged EXEC mode.

**Step 12 copy running-config startup-config**

Save the settings in the configuration file.

The following example shows how to enable IGMP Snooping for VLAN 1, and configure the member port aging time as 300 seconds, the router port aging time as 320 seconds, and then enable Fast Leave and Report Suppression for the VLAN:

**Switch#configure**

```
Switch(config)#ip igmp snooping vlan-config 1 mtime 300
Switch(config)#ip igmp snooping vlan-config 1 rtime 320
Switch(config)#ip igmp snooping vlan-config 1 immediate-leave
Switch(config)#ip igmp snooping vlan-config 1 report-suppression
Switch(config)#show ip igmp snooping vlan 1
```

Vlan Id: 1

Vlan IGMP Snooping Status: Enable

Fast Leave: Enable

Report Suppression: Enable

Router Time:320

Member Time: 300

Querier: Disable

...

```
Switch(config)#end
```

```
Switch#copy running-config startup-config
```

The following example shows how to enable IGMP Snooping querier for VLAN 1, and configure the query interval as 100 seconds, the maximum response time as 15 seconds, the last member query interval as 2 seconds, the last member query count as 3, and the general query source IP as 192.168.0.5:

```
Switch#configure
```

```
Switch(config)#ip igmp snooping vlan-config 1 querier
```

```
Switch(config)#ip igmp snooping vlan-config 1 querier query-interval 100
```

```
Switch(config)#ip igmp snooping vlan-config 1 querier max-response-time 15
```

```
Switch(config)#ip igmp snooping vlan-config 1 querier last-member-query-interval 2
```

```
Switch(config)#ip igmp snooping vlan-config 1 querier last-member-query-count 3
```

```
Switch(config)#ip igmp snooping vlan-config 1 querier general-query source-
ip192.168.0.5
```

```
Switch(config)#show ip igmp snooping vlan 1
```

Vlan Id: 1

...

Querier:

Maximum Response Time: 15

```

Query Interval:          100
Last Member Query Interval: 2
Last Member Query Count: 3
General Query Source IP: 192.168.0.5

```

...

```
Switch(config)#end
```

```
Switch#copy running-config startup-config
```

## 2.2.3 Configuring IGMP Snooping for Ports

Follow these steps to configure IGMP Snooping for ports:

|        |  |
|--------|--|
| Step 1 | <b>configure</b><br>Enter global configuration mode.   |
| Step 2 | <b>interface {fastEthernet port   range fastEthernet port-list   gigabitEthernet port   range gigabitEthernet port-list   ten-gigabitEthernet port   range ten-gigabitEthernet port-list   port-channel port-channel-id   range port-channel port-channel-list}</b><br>Enter interface configuration mode.   |
| Step 3 | <b>ip igmp snooping</b><br>Enable IGMP Snooping for the port. By default, it is enabled.   |
| Step 4 | <b>ip igmp snooping immediate-leave</b><br>(Optional) Enable Fast Leave on the specified port.<br><br>Fast Leave can be enabled on a per-port basis or per-VLAN basis. When enabled on a per-port basis, the switch will remove the port from the corresponding multicast group of all VLANs before forwarding the leave message to the querier.<br><br>You should only use Fast Leave for a port when there is a single receiver connected to the port. For more details about Fast Leave, see “2.2.2 Configuring IGMP Snooping for VLANs”. |
| Step 5 | <b>show ip igmp snooping interface [fastEthernet [ port-list ]   gigabitEthernet [ port-list ]   ten-gigabitEthernet [ port-list ]   port-channel [port-channel-list] ] basic-config</b><br>Show the basic IGMP Snooping configuration on the specified port(s) or of all the ports.   |
| Step 6 | <b>end</b><br>Return to privileged EXEC mode.  |
| Step 7 | <b>copy running-config startup-config</b><br>Save the settings in the configuration file.  |

The following example shows how to enable IGMP Snooping and fast leave for port 1/0/1-3:

```
Switch#configure
```

```
Switch(config)#interface range fastEthernet 1/0/1-3
```

```
Switch(config-if-range)#ip igmp snooping
```

```
Switch(config-if-range)#ip igmp snooping immediate-leave
```

```
Switch(config-if-range)#show ip igmp snooping interface gigabitEthernet 1/0/1-3
```

| Port    | IGMP-Snooping | Fast-Leave |
|---------|---------------|------------|
| -----   | -----         | -----      |
| Gi1/0/1 | enable        | enable     |
| Gi1/0/2 | enable        | enable     |
| Gi1/0/3 | enable        | enable     |

```
Switch(config-if-range)#end
```

```
Switch#copy running-config startup-config
```

## 2.2.4 Configuring Hosts to Statically Join a Group

Hosts or Layer 2 ports normally join multicast groups dynamically, but you can also configure hosts to statically join a group.

Follow these steps to configure hosts to statically join a group:

|        |  |
|--------|--|
| Step 1 | <b>configure</b><br>Enter global configuration mode.   |
| Step 2 | <b>ip igmp snooping vlan-config <i>vlan-id-list</i> static ip interface { fastEthernet <i>port-list</i>   gigabitEthernet <i>port-list</i>   ten-gigabitEthernet <i>port-list</i>  port-channel <i>lag-list</i> }</b><br><br><i>vlan-id-list</i> : Specify the ID or the ID list of the VLAN(s).<br><i>ip</i> : Specify the IP address of the multicast group that the hosts want to join.<br><i>port-list</i> / <i>lag-list</i> : Specify the ports that is connected to the hosts. These ports will become static member ports of the group. |
| Step 3 | <b>show ip igmp snooping groups static</b><br>Show the static MLD Snooping configuration.  |
| Step 4 | <b>end</b><br>Return to privileged EXEC mode.  |
| Step 5 | <b>copy running-config startup-config</b><br>Save the settings in the configuration file.  |

The following example shows how to configure port 1/0/1-3 in VLAN 2 to statically join the multicast group 239.1.2.3:

```
Switch#configure
```



```
Switch(config)#ip igmp snooping vlan-config 2 static 239.1.2.3 interface
gigabitEthernet 1/0/1-3
```

```
Switch(config)#show ip igmp snooping groups static
```

| Multicast-ip | VLAN-id | Addr-type | Switch-port |
|--------------|---------|-----------|-------------|
| -----        | -----   | -----     | -----       |
| 239.1.2.3    | 2       | static    | Gi1/0/1-3   |

```
Switch(config)#end
```

```
Switch#copy running-config startup-config
```

# 3 MLD Snooping Configuration

To complete MLD Snooping configuration, follow these steps:

- 1) Enable MLD Snooping globally and configure the global parameters.
- 2) Configure MLD Snooping for VLANs.
- 3) Configure MLD Snooping for ports.
- 4) (Optional) Configure hosts to statically join a group.

## Note:

MLD Snooping takes effect only when it is enabled globally, in the corresponding VLAN and port at the same time.

## 3.1 Using the GUI

### 3.1.1 Configuring MLD Snooping Globally

Choose the menu **L2 FEATURES > Multicast > MLD Snooping > Global Config** to load the following page.

Figure 3-1 Configure MLD Snooping Globally

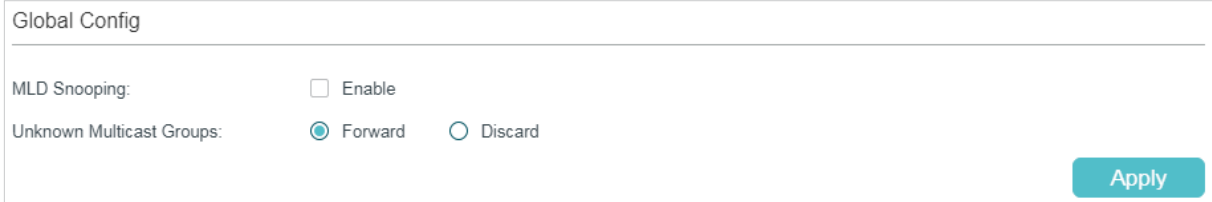

Global Config

MLD Snooping:  Enable

Unknown Multicast Groups:  Forward  Discard

Apply

Follow these steps to configure MLD Snooping globally:

- 1) In the **Global Config** section, enable MLD Snooping and configure the Unknown Multicast Groups feature globally.

|                          |   |
|--------------------------|---|
| MLD Snooping             | Enable or disable MLD Snooping globally.  |
| Unknown Multicast Groups | <p>Configure the way in which the switch processes data that are sent to unknown multicast groups as Forward or Discard. By default, it is Forward.</p> <p>Unknown multicast groups are multicast groups that do not match any of the groups announced in earlier IGMP membership reports, and thus cannot be found in the multicast forwarding table of the switch.</p> <p><b>Note:</b> IGMP Snooping and MLD Snooping share the setting of Unknown Multicast Groups, so you have to enable IGMP Snooping globally on the <b>L2 FEATURES &gt; Multicast &gt; IGMP Snooping &gt; Global Config</b> page at the same time.</p> |

- 2) Click **Apply**.

### 3.1.2 Configuring MLD Snooping for VLANs

Before configuring MLD Snooping for VLANs, set up the VLANs that the router ports and the member ports are in. For details, please refer to [Configuring 802.1Q VLAN](#).

The switch supports configuring MLD Snooping on a per-VLAN basis. After MLD Snooping is enabled globally, you also need to enable MLD Snooping and configure the corresponding parameters for the VLANs that the router ports and the member ports are in.

Choose the menu **L2 FEATURES > Multicast > MLD Snooping > Global Config**, and click  in your desired VLAN entry in the **MLD VLAN Config** section to load the following page.

Figure 3-2 Configure MLD Snooping for VLAN

Configure MLD Snooping for VLAN

VLAN ID:

MLD Snooping Status:  Enable

Fast Leave:  Enable

Report Suppression:  Forward  Discard

Member Port Aging Time:  seconds (60-600)

Router Port Aging Time:  seconds (60-600)

Leave Time:  seconds (1-30)

MLD Snooping Querier:  Enable

Static Router Ports

Follow these steps to configure MLD Snooping for a specific VLAN:

- 1) Enable MLD Snooping for the VLAN, and configure the corresponding parameters.

|                            |  |
|----------------------------|--|
| <b>VLAN ID</b>             | Displays the VLAN ID.                        |
| <b>MLD Snooping Status</b> | Enable or disable MLD Snooping for the VLAN. |

---

|                        |  |
|------------------------|--|
| Fast Leave             | Enable or disable Fast Leave for the VLAN.   |
|                        | <p>Without Fast Leave, after a receiver sends an MLD done message (equivalent to an IGMP leave message) to leave a multicast group, the switch will forward the done message to the Layer 3 device (the querier).</p>  |
|                        | <p>From the point of view of the querier, the port connecting to the switch is a member port of the corresponding multicast group. After receiving the done message from the switch, the querier will send out a configured number (Last Listener Query Count) of Multicast-Address-Specific Queries (MASQs) on that port with a configured interval (Last Listener Query Interval), and wait for MLD reports. If there are other receivers connecting to the switch, they will response to the MASQs before the Last Listener Query Interval expires. If no reports are received after the response time of the last query expires, the querier will remove the port from the forwarding list of the corresponding multicast group.</p> |
|                        | <p>That is, if there are other receivers connecting to the switch, the one sent done message have to wait until the port ages out from the switch's forwarding list of the corresponding multicast group (the maximum waiting time is decided by the Member Port Aging Time).</p>  |
|                        | <p>With Fast Leave enabled on a VLAN, the switch will remove the (Multicast Group, Port, VLAN) entry from the multicast forwarding table before forwarding the done message to the querier. This helps to reduce bandwidth waste since the switch no longer sends the corresponding multicast streams to the VLAN of the port as soon as the port receives a done message from the VLAN.</p>   |
| Report Suppression     | Enable or disable Report Suppression for the VLAN.   |
|                        | <p>When enabled, the switch will only forward the first MLD report message for each multicast group to the MLD querier and suppress subsequent MLD report messages for the same multicast group during one query interval. This feature prevents duplicate report messages from being sent to the MLD querier.</p>   |
| Member Port Aging Time | Specify the aging time of the member ports in the VLAN.  |
|                        | <p>Once the switch receives an MLD report message from a port, the switch adds this port to the member port list of the corresponding multicast group. Member ports that are learned in this way are called dynamic member ports.</p>  |
|                        | <p>If the switch does not receive any MLD report messages for a specific multicast group from a dynamic member port, it will no longer consider this port as a member port of this multicast group and delete it from the multicast forwarding table.</p>  |
| Router Port Aging Time | Specify the aging time of the router ports in the VLAN.  |
|                        | <p>Once the switch receives an MLD general query message from a port, the switch adds this port to the router port list. Router ports that are learned in this way are called dynamic router ports.</p>  |
|                        | <p>If the switch does not receive any MLD general query messages from a dynamic router port within the router port aging time, the switch will no longer consider this port as a router port and delete it from the router port list.</p>  |

---

|                              |   |
|------------------------------|---|
| Leave Time                   | <p>Specify the leave time for the VLAN.</p> <p>When the switch receives a leave message from a port to leave a multicast group, it will wait for a leave time before removing the port from the multicast group. During the period, if the switch receives any report messages from the port, the port will not be removed from the multicast group. Exceptions are as follows:</p> <ul style="list-style-type: none"> <li>• If the member port ages out before the Leave Time ends and no report messages are received, the port will be removed from the multicast group once its Member Port Aging Time ends.</li> <li>• The Leave Time mechanism will not take effect when Fast Leave takes effect.</li> </ul> <p>A proper leave time value can avoid other hosts connecting to the same port of the switch being mistakenly removed from the multicast group when only some of them want to leave.</p> |
| MLD Snooping Querier         | <p>Enable or disable the MLD Snooping Querier for the VLAN.</p> <p>When enabled, the switch acts as an MLD Snooping Querier for the hosts in this VLAN. A querier periodically sends a general query on the network to solicit membership information, and sends MASQs when it receives done messages from hosts.</p> <p><i>Note:</i></p> <p>To enable MLD Snooping Querier for a VLAN, MLD Snooping should be enabled both globally and in the VLAN.</p>   |
| Query Interval               | <p>With MLD Snooping Querier enabled, specify the interval between general query messages sent by the switch.</p>   |
| Maximum Response Time        | <p>With MLD Snooping Querier enabled, specify the host's maximum response time to general query messages.</p>   |
| Last Listener Query Interval | <p>With MLD Snooping Querier enabled, when the switch receives a done message, it obtains the address of the multicast group that the host wants to leave from the message. Then the switch sends out MASQs to this multicast group through the port receiving the done message. This parameter determines the interval between MASQs.</p>  |
| Last Listener Query Count    | <p>With MLD Snooping Querier enabled, specify the number of MASQs to be sent. If specified count of MASQs are sent and no report message is received, the switch will delete the multicast address from the multicast forwarding table.</p>   |
| General Query Source IP      | <p>With MLD Snooping Querier enabled, specify the source IPv6 address of the general query messages sent by the switch. It should be a unicast address.</p>   |
| Static Router Ports          | <p>Select one or more ports to be the static router ports in the VLAN. Static router ports do not age.</p> <p>Multicast streams and MLD packets to all groups in this VLAN will be forwarded through the static router ports. Multicast streams and MLD packets to the groups that have dynamic router ports will be also forwarded through the corresponding dynamic router ports.</p>   |

**Forbidden Router Ports**

Select the ports to forbid them from being router ports in the VLAN.

2) Click **Save**.

### 3.1.3 Configuring MLD Snooping for Ports

Choose the menu **L2 FEATURES > Multicast > MLD Snooping > Port Config** to load the following page.

Figure 3-3 Configure MLD Snooping for Ports

| UNIT1                               |        | LAGS         |            |     |
|-------------------------------------|--------|--------------|------------|-----|
| <input type="checkbox"/>            | Port   | MLD Snooping | Fast Leave | LAG |
| <input checked="" type="checkbox"/> | 1/0/1  | Enabled      | Disabled   | --- |
| <input type="checkbox"/>            | 1/0/2  | Enabled      | Disabled   | --- |
| <input type="checkbox"/>            | 1/0/3  | Enabled      | Disabled   | --- |
| <input type="checkbox"/>            | 1/0/4  | Enabled      | Disabled   | --- |
| <input type="checkbox"/>            | 1/0/5  | Enabled      | Disabled   | --- |
| <input type="checkbox"/>            | 1/0/6  | Enabled      | Disabled   | --- |
| <input type="checkbox"/>            | 1/0/7  | Enabled      | Disabled   | --- |
| <input type="checkbox"/>            | 1/0/8  | Enabled      | Disabled   | --- |
| <input type="checkbox"/>            | 1/0/9  | Enabled      | Disabled   | --- |
| <input type="checkbox"/>            | 1/0/10 | Enabled      | Disabled   | --- |

Total: 28      1 entry selected.      **Cancel** **Apply**

Follow these steps to configure MLD Snooping for ports:

1) Enable MLD Snooping for the port and enable Fast Leave if there is only one receiver connected to the port.

**MLD Snooping**      Enable or disable MLD Snooping for the port.

**Fast Leave**      Enable or disable Fast Leave for the port.

Fast Leave can be enabled on a per-port basis or per-VLAN basis. When enabled on a per-port basis, the switch will remove the port from the corresponding multicast group of all VLANs before forwarding the done message to the querier.

You should only use Fast Leave for a port when there is a single receiver connected to the port. For more details about Fast Leave, see ["3.1.2 Configuring MLD Snooping for VLANs"](#).

**LAG**      Displays the LAG the port belongs to.

2) Click **Apply**.

### 3.1.4 Configuring Hosts to Statically Join a Group

Hosts or Layer 2 ports normally join multicast groups dynamically, but you can also configure hosts to statically join a group.

Choose the menu **L2 FEATURES > Multicast > MLD Snooping > Static Group Config** and click **+ Add** to load the following page.

Figure 3-4 Configure Hosts to Statically Join a Group

Follow these steps to configure hosts to statically join a group:

- 1) Specify the multicast IP address, VLAN ID. Select the ports to be the static member ports of the multicast group.

|                     |  |
|---------------------|--|
| <b>Multicast IP</b> | Specify the IPv6 address of the multicast group that the hosts need to join.   |
| <b>VLAN ID</b>      | Specify the VLAN that the hosts are in.  |
| <b>Member Ports</b> | Select the ports that the hosts are connected to. These ports will become the static member ports of the multicast group and will never age. |

- 2) Click **Create**.

## 3.2 Using the CLI

### 3.2.1 Configuring MLD Snooping Globally

Follow these steps to configure MLD Snooping globally:

|        |   |
|--------|---|
| Step 1 | <b>configure</b><br>Enter global configuration mode.      |
| Step 2 | <b>ipv6 mld snooping</b><br>Enable MLD Snooping Globally. |

- 
- Step 3     **ipv6 mld snooping drop-unknown**
- (Optional) Configure the way how the switch processes multicast streams that are sent to unknown multicast groups as Discard. By default, it is Forward.
- Unknown multicast groups are multicast groups that do not match any of the groups announced in earlier IGMP membership reports, and thus cannot be found in the multicast forwarding table of the switch.
- Note:** IGMP Snooping and MLD Snooping share the setting of Unknown Multicast Groups, you need to ensure IGMP Snooping is enabled globally. To enable IGMP Snooping globally, use the **ip igmp snooping** command in global configuration mode.
- 
- Step 4     **show ipv6 mld snooping**
- Show the basic IGMP Snooping configuration.
- 
- Step 5     **end**
- Return to privileged EXEC mode.
- 
- Step 6     **copy running-config startup-config**
- Save the settings in the configuration file.
- 

The following example shows how to enable MLD Snooping globally, and the way how the switch processes multicast streams that are sent to unknown multicast groups as discard.

**Switch#configure**

**Switch(config)#ipv6 mld snooping**

**Switch(config)#ipv6 mld snooping**

**Switch(config)#ipv6 mld snooping drop-unknown**

**Switch(config)#show ipv6 mld snooping**

MLD Snooping            :Enable

Unknown Multicast        :Discard

...

**Switch(config)#end**

**Switch#copy running-config startup-config**

### 3.2.2 Configuring MLD Snooping for VLANs

Before configuring MLD Snooping for VLANs, set up the VLANs that the router ports and the member ports are in. For details, please refer to [Configuring 802.1Q VLAN](#).

The switch supports configuring MLD Snooping on a per-VLAN basis. After MLD Snooping is enabled globally, you also need to enable MLD Snooping and configure the corresponding parameters for the VLANs that the router ports and the member ports are in.



Follow these steps to configure MLD Snooping for VLANs:

---

Step 1 **configure**

Enter global configuration mode.

---

Step 2 **ipv6 mld snooping vlan-config vlan-id-list mtime member-time**

Enable MLD Snooping for the specified VLANs, and specify the member port aging time for the VLANs.

*vlan-id-list*: Specify the ID or the ID list of the VLAN(s).

*member-time*: Specify the aging time of the member ports in the specified VLANs. Valid values are from 60 to 600 seconds. By default, it is 260 seconds.

Once the switch receives an MLD report message from a port, the switch adds this port to the member port list of the corresponding multicast group. Member ports that are learned in this way are called dynamic member ports.

If the switch does not receive any MLD report message for a specific multicast group from a dynamic member port, it will no longer consider this port as a member port of this multicast group and delete it from the multicast forwarding table.

---

Step 3 **ipv6 mld snooping vlan-config vlan-id-list rtime router-time**

Specify the router port aging time for the VLANs.

*vlan-id-list*: Specify the ID or the ID list of the VLAN(s).

*router-time*: Specify the aging time of the router ports in the specified VLANs. Valid values are from 60 to 600 seconds. By default, it is 300 seconds.

Once the switch receives an MLD general query message from a port, the switch adds this port to the router port list. Router ports that are learned in this way are called dynamic router ports.

If the switch does not receive any MLD general query message from a dynamic router port within the router port aging time, the switch will no longer consider this port as a router port and delete it from the router port list.

---

Step 4 **ipv6 mld snooping vlan-config vlan-id-list ltime leave-time**

Specify the router port aging time for the VLANs.

*vlan-id-list*: Specify the ID or the ID list of the VLAN(s).

*leave-time*: Specify the leave time for the VLAN(s). Valid values are from 1 to 30 in seconds, and the default value is 1 second.

When the switch receives a leave message from a port to leave a multicast group, it will wait for a leave time before removing the port from the multicast group. During the period, if the switch receives any report messages from the port, the port will not be removed from the multicast group. Exceptions are as follows:

- If the member port ages out before the Leave Time ends and no report messages are received, the port will be removed from the multicast group once its Member Port Aging Time ends.
- The Leave Time mechanism will not take effect when Fast Leave takes effect.

A proper leave time value can avoid other hosts connecting to the same port of the switch being mistakenly removed from the multicast group when only some of them want to leave.

- 
- Step 5 **ipv6 mld snooping vlan-config vlan-id-list report-suppression**
- (Optional) Enable Report Suppression for the VLANs. By default, it is disabled.
- When enabled, the switch will only forward the first MLD report message for each multicast group to the MLD querier and suppress subsequent MLD report messages for the same multicast group during one query interval. This feature prevents duplicate report messages from being sent to the MLD querier.
- vlan-id-list*: Specify the ID or the ID list of the VLAN(s).
- 
- Step 6 **ipv6 mld snooping vlan-config vlan-id-list immediate-leave**
- (Optional) Enable Fast Leave for the VLANs. By default, it is disabled.
- Without Fast Leave, after a receiver sends an MLD done message (equivalent to an IGMP leave message) to leave a multicast group, the switch will forward the done message to the Layer 3 device (the querier).
- From the point of view of the querier, the port connecting to the switch is a member port of the corresponding multicast group. After receiving the done message from the switch, the querier will send out a configured number (Last Listener Query Count) of Multicast-Address-Specific Queries (MASQs) on that port with a configured interval (Last Listener Query Interval), and wait for MLD reports. If there are other receivers connecting to the switch, they will response to the MASQs before the Last Listener Query Interval expires. If no reports are received after the response time of the last query expires, the querier will remove the port from the forwarding list of the corresponding multicast group.
- That is, if there are other receivers connecting to the switch, the one sent done message have to wait until the port ages out from the switch's forwarding list of the corresponding multicast group (the maximum waiting time is decided by the Member Port Aging Time).
- With Fast Leave enabled on a VLAN, the switch will remove the (Multicast Group, Port, VLAN) entry from the multicast forwarding table before forwarding the done message to the querier. This helps to reduce bandwidth waste since the switch no longer sends the corresponding multicast streams to the VLAN of the port as soon as the port receives a done message from the VLAN.
- vlan-id-list*: Specify the ID or the ID list of the VLAN(s).
- 
- Step 7 **ipv6 mld snooping vlan-config vlan-id-list rport interface { fastEthernet port-list | gigabitEthernet port-list | ten-gigabitEthernet port-list | port-channel lag-list }**
- (Optional) Specify the static router ports for the VLANs. Static router ports do not age.
- vlan-id-list*: Specify the ID or the ID list of the VLAN(s).
- port-list*: The number or the list of the Ethernet port that need to be configured as static router ports.
- lag-list*: The ID or the list of the LAG that need to be configured as static router ports.
- 
- Step 8 **ipv6 mld snooping vlan-config vlan-id-list router-ports-forbidden interface { fastEthernet port-list | gigabitEthernet port-list | ten-gigabitEthernet port-list | port-channel lag-list }**
- (Optional) Specify the ports to forbid them from being router ports in the VLANs.
- vlan-id-list*: Specify the ID or the ID list of the VLAN(s).
- port-list*: The number or the list of the Ethernet port that need to be forbidden from being router ports.
- lag-list*: The ID or the list of the LAG that need to be forbidden from being router ports.
-

**Step 9** `ipv6 mld snooping vlan-config vlan-id-list querier`

(Optional) Enable MLD Snooping Querier for the VLAN. By default, it is disabled.

When enabled, the switch acts as an MLD Snooping Querier for the hosts in this VLAN. A querier periodically sends a general query on the network to solicit membership information, and sends group-specific queries when it receives done messages from hosts.

*vlan-id-list*: Specify the ID or the ID list of the VLAN(s).

**Note:**

To enable MLD Snooping Querier for a VLAN, MLD Snooping should be enabled both globally and in the VLAN.

After enabling MLD Snooping Querier feature, you need to specify the corresponding parameters including the Last Member Query Count, Last Member Query Interval, Maximum Response Time, Query Interval and General Query Source IP. Use the command below in global configuration mode to configure the parameters:

```
ipv6 mld snooping vlan-config vlan-id-list querier { max-response-time response-time | query-interval interval | general-query source-ip ip-addr | last-listener-query-count num | last-listener-query-interval interval }
```

*vlan-id-list*: Specify the ID or the ID list of the VLAN(s).

*response-time*: Specify the host's maximum response time to general query messages.

**query-interval** *interval*: Specify the interval between general query messages sent by the switch.

*ip-addr*: Specify the source IP address of the general query messages sent by the switch. It should be a unicast address.

*num*: Specify the number of group-specific queries to be sent. With MLD Snooping Querier enabled, when the switch receives a done message, it obtains the address of the multicast group that the host wants to leave from the message. Then the switch sends out MASQs to this multicast group through the port receiving the done message. If specified count of MASQs are sent and no report message is received, the switch will delete the multicast address from the multicast forwarding table.

**last-listener-query-interval** *interval*: Specify the interval between MASQs.

**Step 10** `show ipv6 mld snooping vlan vlan-id`

Show the basic MLD snooping configuration in the specified VLAN.

**Step 11** `end`

Return to privileged EXEC mode.

**Step 12** `copy running-config startup-config`

Save the settings in the configuration file.

The following example shows how to enable MLD Snooping for VLAN 1, and configure the member port aging time as 300 seconds, the router port aging time as 320 seconds, and then enable Fast Leave and Report Suppression for the VLAN:

**Switch#configure**

```
Switch(config)#ipv6 mld snooping vlan-config 1 mtime 300
```

```
Switch(config)#ipv6 mld snooping vlan-config 1 rtime 320
Switch(config)#ipv6 mld snooping vlan-config 1 immediate-leave
Switch(config)#ipv6 mld snooping vlan-config 1 report-suppression
Switch(config)#show ipv6 mld snooping vlan 1
```

Vlan Id: 1

Vlan MLD Snooping Status: Enable

Fast Leave: Enable

Report Suppression: Enable

Router Time: Enable

Member Time: Enable

Querier: Disable

...

```
Switch(config)#end
```

```
Switch#copy running-config startup-config
```

The following example shows how to enable MLD Snooping querier for VLAN 1, and configure the query interval as 100 seconds, the maximum response time as 15 seconds, the last listener query interval as 2 seconds, the last listener query count as 3, and the general query source IP as FE80::1:

```
Switch#configure
```

```
Switch(config)#ipv6 mld snooping vlan-config 1 querier
```

```
Switch(config)#ipv6 mld snooping vlan-config 1 querier query-interval 100
```

```
Switch(config)#ipv6 mld snooping vlan-config 1 querier max-response-time 15
```

```
Switch(config)#ipv6 mld snooping vlan-config 1 querier last-listener-query-interval 2
```

```
Switch(config)#ipv6 mld snooping vlan-config 1 querier last-listener-query-count 3
```

```
Switch(config)#ipv6 mld snooping vlan-config 1 querier general-query source-ip FE80::1
```

```
Switch(config)#show ipv6 mld snooping vlan 1
```

Vlan Id: 1

...

Querier: Enable

Maximum Response Time: 15

Query Interval: 100

```
Last Member Query Interval: 2
Last Member Query Count: 3
General Query Source IP: fe80::1
```

...

```
Switch(config)#end
```

```
Switch#copy running-config startup-config
```

### 3.2.3 Configuring MLD Snooping for Ports

Follow these steps to configure MLD Snooping for ports:

|        |   |
|--------|---|
| Step 1 | <b>configure</b><br>Enter global configuration mode.  |
| Step 2 | <b>interface {fastEthernet port   range fastEthernet port-list   gigabitEthernet port   range gigabitEthernet port-list   ten-gigabitEthernet port   range ten-gigabitEthernet port-list   port-channel port-channel-id   range port-channel port-channel-list}</b><br>Enter interface configuration mode.  |
| Step 3 | <b>ipv6 mld snooping</b><br>Enable MLD Snooping for the port. By default, it is enabled.  |
| Step 4 | <b>ipv6 mld snooping immediate-leave</b><br>(Optional) Enable Fast Leave on the specified port.<br><br>Fast Leave can be enabled on a per-port basis or per-VLAN basis. When enabled on a per-port basis, the switch will remove the port from the corresponding multicast group of all VLANs before forwarding the done message to the querier.<br><br>You should only use Fast Leave for a port when there is a single receiver connected to the port. For more details about Fast Leave, see “3.2.2 Configuring MLD Snooping for VLANs”. |
| Step 5 | <b>show ipv6 mld snooping interface [fastEthernet [ port-list ]   gigabitEthernet [ port-list ]   ten-gigabitEthernet [ port-list ]   port-channel [port-channel-list]] basic-config</b><br>Show the basic MLD Snooping configuration on the specified port(s) or of all the ports.   |
| Step 6 | <b>end</b><br>Return to privileged EXEC mode.   |
| Step 7 | <b>copy running-config startup-config</b><br>Save the settings in the configuration file.   |

The following example shows how to enable MLD Snooping and fast leave for port 1/0/1-3:

```
Switch#configure
```

```
Switch(config)#interface range fastEthernet 1/0/1-3
```

```
Switch(config-if-range)#ipv6 mld snooping
```

```
Switch(config-if-range)#ipv6 mld snooping immediate-leave
```

```
Switch(config-if-range)#show ipv6 mld snooping interface gigabitEthernet 1/0/1-3
```

| Port    | MLD-Snooping | Fast-Leave |
|---------|--------------|------------|
| -----   | -----        | -----      |
| Gi1/0/1 | enable       | enable     |
| Gi1/0/2 | enable       | enable     |
| Gi1/0/3 | enable       | enable     |

```
Switch(config-if-range)#end
```

```
Switch#copy running-config startup-config
```

### 3.2.4 Configuring Hosts to Statically Join a Group

Hosts or Layer 2 ports normally join multicast groups dynamically, but you can also configure hosts to statically join a group.

Follow these steps to configure hosts to statically join a group:

|        |   |
|--------|---|
| Step 1 | <b>configure</b><br>Enter global configuration mode.  |
| Step 2 | <b>ipv6 mld snooping vlan-config</b> <i>vlan-id-list</i> <b>static ip interface</b> { <b>fastEthernet</b> <i>port-list</i>   <b>gigabitEthernet</b> <i>port-list</i>   <b>ten-gigabitEthernet</b> <i>port-list</i>   <b>port-channel</b> <i>lag-list</i> }<br><i>vlan-id-list</i> : Specify the ID or the ID list of the VLAN(s).<br><i>ip</i> : Specify the IP address of the multicast group that the hosts want to join.<br><i>port-list</i> / <i>lag-list</i> : Specify the ports that is connected to the hosts. These ports will become static member ports of the group. |
| Step 3 | <b>show ipv6 mld snooping groups static</b><br>Show the static MLD Snooping configuration.  |
| Step 4 | <b>end</b><br>Return to privileged EXEC mode.   |
| Step 5 | <b>copy running-config startup-config</b><br>Save the settings in the configuration file.   |

The following example shows how to configure port 1/0/1-3 in VLAN 2 to statically join the multicast group FF80::1234:01:

```
Switch#configure
```

```
Switch(config)#ipv6 mld snooping vlan-config 2 static FF80::1234:01 interface gigabitEthernet 1/0/1-3
```

```
Switch(config)#show ipv6 mld snooping groups static
```

| Multicast-ip  | VLAN-id | Addr-type | Switch-port |
|---------------|---------|-----------|-------------|
| -----         | -----   | -----     | -----       |
| ff80::1234:01 | 2       | static    | Gi1/0/1-3   |

**Switch(config)#end**

**Switch#copy running-config startup-config**

# 4 MVR Configuration

To complete MVR configuration, follow these steps:

- 1) Configure 802.1Q VLANs.
- 2) Configure MVR globally.
- 3) Add multicast groups to MVR.
- 4) Configure MVR for the ports.
- 5) (Optional) Statically add ports to MVR groups.

## Configuration Guidelines

- MVR does not support IGMPv3 messages.
- Do not configure MVR on private VLAN ports, otherwise MVR cannot take effect.
- MVR operates on the underlying mechanism of IGMP Snooping, but the two features operate independently of each other. Both protocols can be enabled on a port at the same time. When both are enabled, MVR listens to the report and leave messages only for the multicast groups configured in MVR. All other multicast groups are managed by IGMP Snooping.

## 4.1 Using the GUI

### 4.1.1 Configuring 802.1Q VLANs

Before configuring MVR, create an 802.1Q VLAN as the multicast VLAN. Add all source ports (uplink ports that receive multicast data from the router) to the multicast VLAN as tagged ports. Configure 802.1Q VLANs for the receiver ports (ports that are connecting to the hosts) according to network requirements. Note that receiver ports can only belong to one VLAN and cannot be added to the multicast VLAN. For details, refer to [Configuring 802.1Q VLAN](#).



## 4.1.2 Configuring MVR Globally

Choose the menu **L2 FEATURES > Multicast > MVR > MVR Config** to load the following page.

Figure 4-1 Configure MVR Globally

The screenshot shows the 'MVR Config' page with the following settings:

- MVR:**  Enable
- MVR Mode:**  Compatible  Dynamic
- Multicast VLAN ID:**  (1-4094)
- Query Response Time:**  tenths of a second (1-100)
- Maximum Multicast Groups:** 511
- Current Multicast Groups:** 0

An **Apply** button is located at the bottom right of the configuration area.

Follow these steps to configure MVR globally:

- 1) Enable MVR globally and configure the global parameters.

|                                 |  |
|---------------------------------|--|
| <b>MVR</b>                      | Enable or disable MVR globally.  |
| <b>MVR Mode</b>                 | Specify the MVR mode as compatible or dynamic.<br><br><p><b>Compatible:</b> In this mode, the switch does not forward report or leave messages from the hosts to the IGMP querier. This means IGMP querier cannot learn the multicast groups' membership information from the switch. The IGMP querier must be statically configured to transmit all the required multicast streams to the switch via the multicast VLAN.</p> <p><b>Dynamic:</b> In this mode, after receiving report or leave messages from the hosts, the switch will forward them to the IGMP querier via the multicast VLAN (with appropriate translation of the VLAN ID). The IGMP querier can learn the multicast groups' membership information through the report and leave messages, and transmit the multicast streams to the switch via the multicast VLAN according to the multicast forwarding table.</p> |
| <b>Multicast VLAN ID</b>        | Specify an existing 802.1Q VLAN as the multicast VLAN.   |
| <b>Query Response Time</b>      | Specify the maximum time to wait for IGMP report on a receiver port before removing the port from multicast group membership.  |
| <b>Maximum Multicast Groups</b> | Displays the maximum number of multicast groups that can be configured on the switch.  |
| <b>Current Multicast Groups</b> | Displays the current number of multicast groups that have been configured on the switch.   |

- 2) Click **Apply**.

### 4.1.3 Adding Multicast Groups to MVR

You need to manually add multicast groups to the MVR. Choose the menu **L2 FEATURES > Multicast > MVR > MVR Group Config** and click  Add to load the following page.

Figure 4-2 Add Multicast Groups to MVR

MVR Group IP

MVR Group IP:  (Format: 235.0.0.1)

MVR Group Count:  (1-256)

Cancel
Create

Follow these steps to add multicast groups to MVR:

- 1) Specify the IP address of the multicast groups.

**MVR Group IP /  
MVR Group Count**

Specify the start IP address and the number of contiguous series of multicast groups.

Multicast data sent to the address specified here will be sent to all source ports on the switch and all receiver ports that have requested to receive data from that multicast address.



- 2) Click **Create**.

Then the added multicast groups will appear in the MVR group table, as the following figure shows:

Figure 4-3 MVR Group Table

MVR Group Config

+ Add - Delete

| <input type="checkbox"/> | Index | MVR Group IP | Status   | Members | Operation   |
|--------------------------|-------|--------------|----------|---------|---|
| <input type="checkbox"/> | 1     | 239.1.2.3    | Inactive |         |  |
| <input type="checkbox"/> | 2     | 239.1.2.4    | Inactive |         |  |
| Total: 2                 |       |              |          |         |   |

**MVR Group IP**

Displays the IP address of multicast group.

|               |   |
|---------------|---|
| <b>Status</b> | <p>Displays the status of the MVR group. In compatible mode, all the MVR groups are added manually, so the status is always active. In dynamic mode, there are two status:</p> <p><b>Inactive:</b> The MVR group is added successfully, but the source port has not received any query messages from this multicast group.</p> <p><b>Active:</b> The MVR group is added successfully and the source port has received query messages from this multicast group.</p> |
| <b>Member</b> | Displays the member ports in this MVR group.  |

#### 4.1.4 Configuring MVR for the Port

Choose the menu **L2 FEATURES > Multicast > MVR > Port Config** to load the following page.

Figure 4-4 Configure MVR for the Port

Port Config

UNIT1

|                                     | Port   | Mode    | Type | Status          | Fast Leave |
|-------------------------------------|--------|---------|------|-----------------|------------|
| <input checked="" type="checkbox"/> | 1/0/1  | Disable | None | Inactive/InVLAN | Disable    |
| <input type="checkbox"/>            | 1/0/2  | Disable | None | Inactive/InVLAN | Disable    |
| <input type="checkbox"/>            | 1/0/3  | Disable | None | Inactive/InVLAN | Disable    |
| <input type="checkbox"/>            | 1/0/4  | Disable | None | Inactive/InVLAN | Disable    |
| <input type="checkbox"/>            | 1/0/5  | Disable | None | Inactive/InVLAN | Disable    |
| <input type="checkbox"/>            | 1/0/6  | Disable | None | Inactive/InVLAN | Disable    |
| <input type="checkbox"/>            | 1/0/7  | Disable | None | Inactive/InVLAN | Disable    |
| <input type="checkbox"/>            | 1/0/8  | Disable | None | Inactive/InVLAN | Disable    |
| <input type="checkbox"/>            | 1/0/9  | Disable | None | Inactive/InVLAN | Disable    |
| <input type="checkbox"/>            | 1/0/10 | Disable | None | Inactive/InVLAN | Disable    |

Total: 28
1 entry selected.

Cancel
Apply

Follow these steps to add multicast groups to MVR:

- 1) Select one or more ports to configure.
- 2) Enable MVR, and configure the port type and Fast Leave feature for the port.

|             |   |
|-------------|---|
| <b>Mode</b> | Enable or disable MVR for the selected ports. |
|-------------|---|

|            |   |
|------------|---|
| Type       | <p>Configure the port type.</p> <p><b>None:</b> The port is a non-MVR port. If you attempt to configure a non-MVR port with MVR characteristics, the operation will be unsuccessful.</p> <p><b>Source:</b> Configure the uplink ports that receive and send multicast data on the multicast VLAN as source ports. Source ports should belong to the multicast VLAN. In compatible mode, source ports will be automatically added to all multicast groups, while in dynamic mode, you need to manually add them to the corresponding multicast groups.</p> <p><b>Receiver:</b> Configure the ports that are connecting to the hosts as receiver ports. A receiver port can only belong to one VLAN, and cannot belong to the multicast VLAN. In both modes, the switch will add or remove the receiver ports to the corresponding multicast groups by snooping the report and leave messages from the hosts.</p> |
| Status     | <p>Displays the port's status.</p> <p><b>Active/InVLAN:</b> The port is physically up and in one or more VLANs.</p> <p><b>Active/NotInVLAN:</b> The port is physically up and not in any VLAN.</p> <p><b>Inactive/InVLAN:</b> The port is physically down and in one or more VLANs.</p> <p><b>Inactive/NotInVLAN:</b> The port is physically down and not in any VLAN.</p>  |
| Fast Leave | <p>Enable or disable Fast Leave for the selected ports. Only receiver ports support Fast Leave. Before enabling Fast Leave for a port, make sure there is only a single receiver device connecting to the port.</p>   |

3) Click **Apply**.

#### 4.1.5 (Optional) Adding Ports to MVR Groups Statically

You can add only receiver ports to MVR groups statically. The switch adds or removes receiver ports to the corresponding multicast groups by snooping the report and leave messages from the hosts. You can also statically add a receiver port to an MVR group.

Choose the menu **L2 FEATURES > Multicast > MVR > Static Group Members**, and click  in your desired MVR group entry to load the following page.

Figure 4-5 Configure Hosts to Statically Join an MVR group



Follow these steps to statically add ports to an MVR group:

- 1) Select the ports to add them to the MVR group.
- 2) Click **Save**.

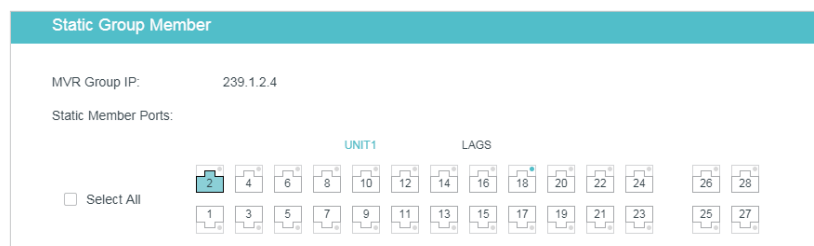
## 4.2 Using the CLI

### 4.2.1 Configuring 802.1Q VLANs

Before configuring MVR, create an 802.1Q VLAN as the multicast VLAN. Add the all source ports to the multicast VLAN as tagged ports. Configure 802.1Q VLANs for the receiver ports according to network requirements. Note that receiver ports can only belong to one VLAN and cannot be added to the multicast VLAN. For details, refer to [Configuring 802.1Q VLAN](#).

### 4.2.2 Configuring MVR Globally

Follow these steps to configure MVR globally:

---

|        |   |
|--------|---|
| Step 1 | <b>configure</b><br>Enter global configuration mode.  |
| Step 2 | <b>mvr</b><br>Enable MVR Globally.  |
| Step 3 | <b>mvr mode { compatible   dynamic }</b><br>Configure the MVR mode as compatible or dynamic.<br><br><b>compatible:</b> In this mode, the switch does not forward report or leave messages from the hosts to the IGMP querier. So the IGMP querier cannot learn the multicast groups membership information from the switch. You have to statically configure the IGMP querier to transmit all the required multicast streams to the switch via the multicast VLAN.<br><br><b>dynamic:</b> In this mode, after receiving report or leave messages from the hosts, the switch will forward them to the IGMP querier via the multicast VLAN (with appropriate translation of the VLAN ID). So the IGMP querier can learn the multicast groups membership information through the report and leave messages, and transmit the multicast streams to the switch via the multicast VLAN according to the multicast forwarding table. |
| Step 4 | <b>mvr vlan <i>vlan-id</i></b><br>Specify the multicast VLAN.<br><br><b>vlan-id:</b> Specify the ID of the multicast VLAN. Valid values are from 1 to 4094.   |
| Step 5 | <b>mvr querytime <i>time</i></b><br>Specify the maximum time to wait for IGMP report on a receiver port before removing the port from multicast group membership.<br><br><b>time:</b> Specify the maximum response time. Valid values are from 1 to 100 tenths of a second, and the default value is 5 tenths of a second.  |

---

---

Step 6 **mvr group** *ip-addr count*

Add multicast groups to the MVR.

*ip-addr*: Specify the start IP address of the contiguous series of multicast groups.

*count*: Specify the number of the multicast groups to be added to the MVR. Valid values are from 1 to 511.

---

Step 7 **show mvr** [ **interface** { **fastEthernet** *port* | **gigabitEthernet** *port* | **port-channel** *lagid* | **ten-gigabitEthernet** *port* } [ **members** { **vlan** *vlan-id* } ]

Show the global MVR configuration.

**show mvr members** [*ip*] [**status** { *inactive* | *active* }]

Show the existing MVR groups.

*ip*: Specify the IP address of the multicast group.

*inactive*: Show all inactive multicast group.

*active*: Show all active multicast group.

---

Step 8 **end**

Return to privileged EXEC mode.

---

Step 9 **copy running-config startup-config**

Save the settings in the configuration file.

---

The following example shows how to enable MVR globally, and configure the MVR mode as compatible, the multicast VLAN as VLAN 2 and the query response time as 5 tenths of a second. Then add 239.1.1.2.3-239.1.1.2.5 to MVR group.

**Switch#configure**

**Switch(config)#mvr mode** compatible

**Switch(config)#mvr vlan** 2

**Switch(config)#mvr querytime** 5

**Switch(config)#mvr group** 239.1.1.2.3 3

**Switch(config)#show mvr**

```
MVR                               :Enable
MVR Multicast Vlan                 :2
MVR Max Multicast Groups           :511
MVR Current Multicast Groups       :3
MVR Global Query Response Time     :5 (tenths of sec)
MVR Mode Type                      :Compatible
```

**Switch(config)#show mvr members**

| MVR Group IP | status | Members |
|--------------|--------|---------|
| -----        | -----  | -----   |
| 239.1.2.3    | active |         |
| 239.1.2.4    | active |         |
| 239.1.2.5    | active |         |

**Switch(config)#end****Switch#copy running-config startup-config**

## 4.2.3 Configuring MVR for the Ports

Follow these steps to configure MVR for the ports:

|        |  |
|--------|--|
| Step 1 | <b>configure</b><br>Enter global configuration mode.   |
| Step 2 | <b>interface {fastEthernet port   range fastEthernet port-list   gigabitEthernet port   range gigabitEthernet port-list   ten-gigabitEthernet port   range ten-gigabitEthernet port-list }</b><br>Enter interface configuration mode.  |
| Step 3 | <b>mvr</b><br>Enable MVR for the port.   |
| Step 4 | <b>mvr type { source   receiver }</b><br>Configure the MVR port type as receiver or source. By default, the port is a non-MVR port. If you attempt to configure a non-MVR port with MVR characteristics, the operation fails.<br><br><b>source:</b> Configure the uplink ports that receive and send multicast data on the multicast VLAN as source ports. Source ports should belong to the multicast VLAN.<br><br><b>receiver:</b> Configure the ports that are connecting to the hosts as receiver ports. A receiver port can only belong to one VLAN, and cannot belong to the multicast VLAN. |
| Step 5 | <b>mvr immediate</b><br>(Optional) Enable the Fast Leave feature of MVR for the port. Only receiver ports support Fast Leave. Before enabling Fast Leave for a port, make sure there is only a single receiver device connecting to the port.  |

**Step 6** `mvr vlan vlan-id group ip-addr`

(Optional) Statically add the port to an MVR group. Then the port can receive multicast traffic sent to the IP multicast address via the multicast VLAN.

This command applies to only receiver ports. The switch adds or removes the receiver ports to the corresponding multicast groups by snooping the report and leave messages from the hosts. You can also statically add a receiver port to an MVR group.

*vlan-id*: Enter the multicast VLAN ID.

*ip-addr*: Specify the IP address of the multicast group.

**Step 7** `show mvr interface {fastEthernet [port-list] | gigabitEthernet [port-list] | ten-gigabitEthernet [port-list] }`

Show the MVR configuration of the specified interface(s).

**show mvr members**

Show the membership information of all MVR groups.

**Step 8** `end`

Return to privileged EXEC mode.

**Step 9** `copy running-config startup-config`

Save the settings in the configuration file.

The following example shows how to configure port 1/0/7 as source port, and port 1/0/1-3 as receiver ports. Then statically add port 1/0/1-3 to group 239.1.2.3 and enable MVR Fast Leave for these ports. The multicast VLAN is VLAN 2.

**Switch#configure**

```
Switch(config)#interface gigabitEthernet 1/0/7
```

```
Switch(config-if)#mvr
```

```
Switch(config-if)#mvr type source
```

```
Switch(config-if)#exit
```

```
Switch(config)#interface range gigabitEthernet 1/0/1-3
```

```
Switch(config-if-range)#mvr
```

```
Switch(config-if-range)#mvr type receiver
```

```
Switch(config-if-range)#mvr immediate
```

```
Switch(config-if-range)#mvr vlan 2 group 239.1.2.3
```

```
Switch(config-if-range)#show mvr interface fastEthernet 1/0/1-3,1/0/7
```



| Port    | Mode   | Type     | Status          | Immediate Leave |
|---------|--------|----------|-----------------|-----------------|
| Gi1/0/1 | Enable | Receiver | INACTIVE/InVLAN | Enable          |
| Gi1/0/2 | Enable | Receiver | INACTIVE/InVLAN | Enable          |
| Gi1/0/3 | Enable | Receiver | INACTIVE/InVLAN | Enable          |
| Gi1/0/7 | Enable | Source   | INACTIVE/InVLAN | Disable         |

**Switch(config-if-range)#show mvr members**

| MVR Group IP | status | Members          |
|--------------|--------|------------------|
| 239.1.2.3    | active | Gi1/0/1-3, 1/0/7 |

**Switch(config)#end**

**Switch#copy running-config startup-config**

# 5 Multicast Filtering Configuration

To complete multicast filtering configuration, follow these steps:

- 1) Create the IGMP profile or MLD profile.
- 2) Configure multicast groups a port can join and the overflow action.

## 5.1 Using the GUI

### 5.1.1 Creating the Multicast Profile

You can create multicast profiles for both IPv4 and IPv6 network. With multicast profile, the switch can define a blacklist or whitelist of multicast groups so as to filter multicast sources.

The process for creating multicast profiles for IPv4 and IPv6 are similar. The following introductions take creating an IPv4 profile as an example.

Choose the menu **L2 FEATURES > Multicast > Multicast Filtering > IPv4 Profile**, and click

 Add to load the following page.

---

 **Note:**

To create a multicast profile for IPv6, choose the menu **L2 FEATURES > Multicast > Multicast Filtering > IPv6 Profile**.

---

Figure 5-1 Create IPv4 Profile

**General Config**

Profile ID:  (1-999)

Mode:  Permit  Deny

**IP-Range**

+ Add - Delete

| <input type="checkbox"/>  | Index | Start IP Address | End IP Address | Operation |
|---------------------------|-------|------------------|----------------|-----------|
| No entries in this table. |       |                  |                |           |
| Total: 0                  |       |                  |                |           |

**Bind Ports**

UNIT1                      LAGS

2    4    6    8    10    12    14    16    18    20    22    24    26    28  
 1    3    5    7    9    11    13    15    17    19    21    23    25    27

Selected    Unselected    Not Available

Follow these steps to create a profile.

- 1) In the **General Config** section, specify the Profile ID and Mode.

|                   |  |
|-------------------|--|
| <b>Profile ID</b> | Enter a profile ID between 1 and 999.  |
| <b>Mode</b>       | <p>Select <b>Permit</b> or <b>Deny</b> as the filtering mode.</p> <p><b>Permit:</b> Acts as a whitelist and only allows specific member ports to join specified multicast groups.</p> <p><b>Deny:</b> Acts as a blacklist and prevents specific member ports from joining specific multicast groups.</p> |

- 2) In the **IP-Range** section, click **+ Add** to load the following page. Configure the start IP address and end IP address of the multicast groups to be filtered, and click **Create**.

Figure 5-2 Configure Multicast Groups to Be Filtered

**IP-Range**

Start IP Address:  (Format: 235.0.0.1)

End IP Address:  (Format: 235.0.0.1)

Cancel
Create

- 3) In the **Bind Ports** section, select your desired ports to be bound with the profile.
- 4) Click **Save**.

### 5.1.2 Configure Multicast Filtering for Ports

You can modify the mapping relation between ports and profiles in batches, and configure the number of multicast groups a port can join and the overflow action.

The process for configuring multicast filtering for ports in IPv4 and IPv6 are similar. The following introductions take configuring multicast filtering for ports in IPv4 as an example.

Choose the menu **L2 FEATURES > Multicast > Multicast Filtering > IPv4 Port Config** to load the following page.

**Note:**

For IPv6, choose the menu **L2 FEATURES > Multicast > Multicast Filtering > IPv6 Port Config**.

Figure 5-3 Configure Multicast Filtering for Ports

| Port Config                         |        |            |                   |                 |   |                               |
|-------------------------------------|--------|------------|-------------------|-----------------|---|-------------------------------|
| UNIT1                               | LAGS   |            |                   |                 |   |                               |
| <input type="checkbox"/>            | Port   | Profile ID | Maximum Groups    | Overflow Action | LAG   | Operation                     |
| <input checked="" type="checkbox"/> | 1/0/1  |            | 511               | Drop            | ---   | <a href="#">Clear Profile</a> |
| <input type="checkbox"/>            | 1/0/2  |            | 511               | Drop            | ---   | <a href="#">Clear Profile</a> |
| <input type="checkbox"/>            | 1/0/3  |            | 511               | Drop            | ---   | <a href="#">Clear Profile</a> |
| <input type="checkbox"/>            | 1/0/4  |            | 511               | Drop            | ---   | <a href="#">Clear Profile</a> |
| <input type="checkbox"/>            | 1/0/5  |            | 511               | Drop            | ---   | <a href="#">Clear Profile</a> |
| <input type="checkbox"/>            | 1/0/6  |            | 511               | Drop            | ---   | <a href="#">Clear Profile</a> |
| <input type="checkbox"/>            | 1/0/7  |            | 511               | Drop            | ---   | <a href="#">Clear Profile</a> |
| <input type="checkbox"/>            | 1/0/8  |            | 511               | Drop            | ---   | <a href="#">Clear Profile</a> |
| <input type="checkbox"/>            | 1/0/9  |            | 511               | Drop            | ---   | <a href="#">Clear Profile</a> |
| <input type="checkbox"/>            | 1/0/10 |            | 511               | Drop            | ---   | <a href="#">Clear Profile</a> |
| Total: 28                           |        |            | 1 entry selected. |                 | <span style="border: 1px solid #ccc; padding: 5px 15px; margin-right: 10px;">Cancel</span> <span style="background-color: #00a696; color: white; padding: 5px 15px; border-radius: 3px;">Apply</span> |                               |

Follow these steps to bind the profile to ports and configure the corresponding parameters for the ports:

- 1) Select one or more ports to configure.
- 2) Specify the profile to be bound, and configure the maximum groups the port can join and the overflow action.

|                 |   |
|-----------------|---|
| Profile ID      | Specify the ID of an existing profile to bind the profile to the selected ports. One port can only be bound to one profile.   |
| Maximum Groups  | Enter the number of multicast groups the port can join. Valid values are from 1 to 511.   |
| Overflow Action | Select the action the switch will take with the new multicast member groups when the number of multicast groups the port has joined exceeds the maximum.<br><br><b>Drop:</b> Drop all subsequent membership report messages to prevent the port joining a new multicast groups.<br><br><b>Replace:</b> Replace the existing multicast group that has the lowest multicast MAC address with the new multicast group. |
| LAG             | Displays the LAG the port belongs to.   |
| Operation       | Click <b>Clear Profile</b> to clear the binding between the profile and the port.   |

- 3) Click **Apply**.

## 5.2 Using the CLI

### 5.2.1 Creating the Multicast Profile

You can create multicast profiles for both IPv4 and IPv6 network. With multicast profile, the switch can define a blacklist or whitelist of multicast groups so as to filter multicast sources.

#### Creating IGMP Profile (Multicast Profile for IPv4)

|        |   |
|--------|---|
| Step 1 | <b>configure</b><br>Enter global configuration mode.                                    |
| Step 2 | <b>ip igmp profile id</b><br>Create a new profile and enter profile configuration mode. |

- 
- Step 3     **Permit**
- Configure the profile's filtering mode as permit. Then the profile acts as a whitelist and only allows specific member ports to join specified multicast groups.
- deny**
- Configure the profile's filtering mode as deny. Then the profile acts as a blacklist and prevents specific member ports from joining specific multicast groups.
- 
- Step 4     **range start-ip end-ip**
- Configure the range of multicast IP addresses to be filtered.
- start-ip / end-ip*: Specify the start IP address and end IP address of the IP range.
- 
- Step 5     **show ip igmp profile [id]**
- Show the detailed IGMP profile configuration.
- 
- Step 6     **end**
- Return to privileged EXEC mode.
- 
- Step 7     **copy running-config startup-config**
- Save the settings in the configuration file.
- 

The following example shows how to configure Profile 1 so that the switch filters multicast streams sent to 226.0.0.5-226.0.0.10:

**Switch#configure**

**Switch(config)#ip igmp snooping**

**Switch(config)#ip igmp profile 1**

**Switch(config-igmp-profile)#deny**

**Switch(config-igmp-profile)#range 226.0.0.5 226.0.0.10**

**Switch(config-igmp-profile)#show ip igmp profile**

IGMP Profile 1

deny

range 226.0.0.5 226.0.0.10

Switch(config)#end

Switch#copy running-config startup-config

## Creating MLD Profile (Multicast Profile for IPv6)

---

- Step 1     **configure**
- Enter global configuration mode.
-

- 
- Step 2     **ipv6 mld profile id**  
Create a new profile and enter profile configuration mode.
- 
- Step 3     **Permit**  
Configure the profile's filtering mode as permit. It is similar to a whitelist, indicating that the switch only allow specific member ports to join specific multicast groups.
- deny**  
Configure the profile's filtering mode as deny. It is similar to a blacklist, indicating that the switch disallow specific member ports to join specific multicast groups.
- 
- Step 4     **range start-ip end-ip**  
Configure the range of multicast IP addresses to be filtered.  
*start-ip / end-ip*: Specify the start IP address and end IP address of the IP range.
- 
- Step 5     **show ipv6 mld profile [id]**  
Show the detailed MLD profile configuration.
- 
- Step 6     **end**  
Return to privileged EXEC mode.
- 
- Step 7     **copy running-config startup-config**  
Save the settings in the configuration file.
- 

The following example shows how to configure Profile 1 so that the switch filters multicast streams sent to ff01::1234:5-ff01::1234:8:

```
Switch#configure
```

```
Switch(config)#ipv6 mld snooping
```

```
Switch(config)#ipv6 mld profile 1
```

```
Switch(config-mld-profile)#deny
```

```
Switch(config-mld-profile)#range ff01::1234:5 ff01::1234:8
```

```
Switch(config-mld-profile)#show ipv6 mld profile
```

```
MLD Profile 1
```

```
    deny
```

```
    range ff01::1234:5 ff01::1234:8
```

```
Switch(config)#end
```

```
Switch#copy running-config startup-config
```

## 5.2.2 Binding the Profile to Ports

You can bind the created IGMP profile or MLD profile to ports, and configure the number of multicast groups a port can join and the overflow action.

### Binding the IGMP Profile to Ports

|        |  |
|--------|--|
| Step 1 | <p><b>configure</b></p> <p>Enter global configuration mode.</p>  |
| Step 2 | <p><b>interface {fastEthernet port   range fastEthernet port-list   gigabitEthernet port   range gigabitEthernet port-list   ten-gigabitEthernet port   range ten-gigabitEthernet port-list   port-channel port-channel-id   range port-channel port-channel-list}</b></p> <p>Enter interface configuration mode.</p>  |
| Step 3 | <p><b>ip igmp filter profile-id</b></p> <p>Bind the IGMP profile to the specified ports.</p> <p><i>profile-id</i>: Specify the ID of the profile to be bound. It should be an existing profile.</p>  |
| Step 4 | <p><b>ip igmp snooping max-groups maxgroup</b></p> <p>Configure the maximum number of multicast groups the port can join.</p> <p><i>maxgroup</i>: Specify the maximum number of multicast groups the port can join. Valid values are from 1 to 511.</p>  |
| Step 5 | <p><b>ip igmp snooping max-groups action {drop   replace}</b></p> <p>Specify the action towards the new multicast group when the number of multicast groups the port joined exceeds the limit.</p> <p><i>drop</i>: Drop all subsequent membership report messages, and the port join no more new multicast groups.</p> <p><i>replace</i>: Replace the existing multicast group owning the lowest multicast MAC address with the new multicast group.</p> |
| Step 6 | <p><b>show ip igmp profile [id]</b></p> <p>Show the detailed IGMP profile configurations.</p> <p><b>show ip igmp snooping interface [fastEthernet [port-list]   gigabitEthernet [port-list]   ten-gigabitEthernet [port-list]   port-channel [port-channel-list]] max-groups</b></p> <p>Show the multicast group limitation on the specified port(s) or of all the ports.</p>  |
| Step 7 | <p><b>end</b></p> <p>Return to privileged EXEC mode.</p>   |
| Step 8 | <p><b>copy running-config startup-config</b></p> <p>Save the settings in the configuration file.</p>   |



The following example shows how to bind the existing Profile 1 to port 1/0/2, and specify the maximum number of multicast groups that port 1/0/2 can join as 50 and the Overflow Action as Drop:

```
Switch#configure
```

```
Switch(config)#interface gigabitEthernet 1/0/2
```

```
Switch(config-if)#ip igmp snooping
```

```
Switch(config-if)#ip igmp filter 1
```

```
Switch(config-if)#ip igmp snooping max-groups 50
```

```
Switch(config-if)#ip igmp snooping max-groups action drop
```

```
Switch(config-if)#show ip igmp profile
```

```
IGMP Profile 1
```

```
...
```

```
Binding Port(s)
```

```
Gi1/0/2
```

```
Switch(config-if)#show ip igmp snooping interface gigabitEthernet 1/0/2 max-groups
```

| Port    | Max-Groups | Overflow-Action |
|---------|------------|-----------------|
| -----   | -----      | -----           |
| Gi1/0/2 | 50         | Drops           |

```
Switch(config)#end
```

```
Switch#copy running-config startup-config
```

## Binding the MLD Profile to Ports

Step 1 **configure**

Enter global configuration mode.

Step 2 **interface {fastEthernet port | range fastEthernet port-list | gigabitEthernet port | range gigabitEthernet port-list | ten-gigabitEthernet port | range ten-gigabitEthernet port-list | port-channel port-channel-id | range port-channel port-channel-list}**

Enter interface configuration mode.

Step 3 **ipv6 mld filter profile-id**

Bind the MLD profile to the specified ports.

*profile-id*: Specify the ID of the profile to be bound. It should be an existing profile.

**Step 4** `ipv6 mld snooping max-groups maxgroup`

Configure the maximum number of multicast groups the port can join.

`maxgroup`: Specify the maximum number of multicast groups the port can join. Valid values range from 1 to 511.

**Step 5** `ipv6 mld snooping max-groups action {drop | replace}`

Specify the action towards the new multicast group when the number of multicast groups the port joined exceeds max group.

`drop`: Drop all subsequent membership report messages, and the port join no more new multicast groups.

`replace`: Replace the existing multicast group owning the lowest multicast MAC address with the new multicast group.

**Step 6** `show ipv6 mld profile [id]`

Show the detailed MLD profile configuration.

`show ipv6 mld snooping interface [fastEthernet [port-list] | gigabitEthernet [port-list] | ten-gigabitEthernet [port-list] | port-channel [port-channel-list] ] max-groups`

Show the multicast group limitation on the specified port(s) or of all the ports.

**Step 7** `end`

Return to privileged EXEC mode.

**Step 8** `copy running-config startup-config`

Save the settings in the configuration file.

The following example shows how to bind the existing Profile 1 to port 1/0/2, and specify the maximum number of multicast groups that port 1/0/2 can join as 50 and the Overflow Action as Drop:

```
Switch#configure
```

```
Switch(config)#interface gigabitEthernet 1/0/2
```

```
Switch(config-if)#ipv6 mld snooping
```

```
Switch(config-if)#ipv6 mld filter 1
```

```
Switch(config-if)#ipv6 mld snooping max-groups 50
```

```
Switch(config-if)#ipv6 mld snooping max-groups action drop
```

```
Switch(config-if)#show ipv6 mld profile
```

```
MLD Profile 1
```

```
...
```

```
Binding Port(s)
```

```
Gi1/0/2
Switch(config-if)#show ipv6 mld snooping interface gigabitEthernet 1/0/2 max-groups
Port                Max-Groups          Overflow-Action
-----            -
Gi1/0/2            50                  Drops
Switch(config)#end
Switch#copy running-config startup-config
```

# 6 Viewing Multicast Snooping Information

You can view the following multicast snooping information:

- View IPv4 multicast table.
- View IPv4 multicast statistics on each port.
- View IPv6 multicast table.
- View IPv6 multicast statistics on each port.

## 6.1 Using the GUI

### 6.1.1 Viewing IPv4 Multicast Table

Choose the menu **L2 FEATURES > Multicast > Multicast Info > IPv4 Multicast Table** to load the following page:

Figure 6-1 IPv4 Multicast Table

| Index                     | Multicast IP | VLAN ID | Source | Type | Forward Ports |
|---------------------------|--------------|---------|--------|------|---------------|
| No entries in this table. |              |         |        |      |               |
| Total: 0                  |              |         |        |      |               |

The multicast IP address table shows all valid Multicast IP-VLAN-Port entries:

|                     |   |
|---------------------|---|
| <b>Multicast IP</b> | Displays the multicast source IP address.   |
| <b>VLAN ID</b>      | Displays the ID of the VLAN the multicast group belongs to.   |
| <b>Source</b>       | Displays the source of the multicast entry.<br><b>IGMP Snooping:</b> The multicast entry is learned by IGMP Snooping.<br><b>MVR:</b> The multicast entry is learned by MVR.   |
| <b>Type</b>         | Displays how the multicast entry is generated.<br><b>Dynamic:</b> The entry is dynamically learned. All the member ports are dynamically added to the multicast group.<br><b>Static:</b> The entry is manually added. All the member ports are manually added to the multicast group.<br><b>Mix:</b> The entry is dynamically learned (manually learned), and some of the member ports are manually added (dynamically added) to the multicast group. |

**Forward Ports** All ports in the multicast group, including router ports and member ports.

### 6.1.2 Viewing IPv4 Multicast Statistics on Each Port

Choose the menu **L2 FEATURES > Multicast > Multicast Info > IPv4 Multicast Statistics** to load the following page:

Figure 6-2 IPv4 Multicast Statistics

**Auto Refresh**

---

Auto Refresh:

Refresh Interval:  seconds (3-300)

[Apply](#)

---

**Port Statistics**

**UNIT1** | **LAGS**

[↻](#) Refresh

| ID        | Port   | Query Packets | Report Packets (v1) | Report Packets (v2) | Report Packets (v3) | Leave Packets | Error Packets |
|-----------|--------|---------------|---------------------|---------------------|---------------------|---------------|---------------|
| 1         | 1/0/1  | 0             | 0                   | 0                   | 0                   | 0             | 0             |
| 2         | 1/0/2  | 0             | 0                   | 0                   | 0                   | 0             | 0             |
| 3         | 1/0/3  | 0             | 0                   | 0                   | 0                   | 0             | 0             |
| 4         | 1/0/4  | 0             | 0                   | 0                   | 0                   | 0             | 0             |
| 5         | 1/0/5  | 0             | 0                   | 0                   | 0                   | 0             | 0             |
| 6         | 1/0/6  | 0             | 0                   | 0                   | 0                   | 0             | 0             |
| 7         | 1/0/7  | 0             | 0                   | 0                   | 0                   | 0             | 0             |
| 8         | 1/0/8  | 0             | 0                   | 0                   | 0                   | 0             | 0             |
| 9         | 1/0/9  | 0             | 0                   | 0                   | 0                   | 0             | 0             |
| 10        | 1/0/10 | 0             | 0                   | 0                   | 0                   | 0             | 0             |
| Total: 28 |        |               |                     |                     |                     |               |               |

Follow these steps to view IPv4 multicast statistics on each port:

- 1) To get the real-time multicast statistics, enable **Auto Refresh**, or click **Refresh**.

|                         |   |
|-------------------------|---|
| <b>Auto Refresh</b>     | Enable or disable Auto Refresh. When enabled, the switch will automatically refresh the multicast statistics.       |
| <b>Refresh Interval</b> | After <b>Auto Refresh</b> is enabled, specify the time interval for the switch to refresh the multicast statistics. |

- 2) In the **Port Statistics** section, view IPv4 multicast statistics on each port.

|                            |  |
|----------------------------|--|
| <b>Query Packets</b>       | Displays the number of query packets received by the port.         |
| <b>Report Packets (v1)</b> | Displays the number of IGMPv1 report packets received by the port. |

|                     |  |
|---------------------|--|
| Report Packets (v2) | Displays the number of IGMPv2 report packets received by the port. |
| Report Packets (v3) | Displays the number of IGMPv3 report packets received by the port. |
| Leave Packets       | Displays the number of leave packets received by the port.         |
| Error Packets       | Displays the number of error packets received by the port.         |

### 6.1.3 Viewing IPv6 Multicast Table

Choose the menu **L2 FEATURES > Multicast > Multicast Info > IPv6 Multicast Table** to load the following page:

Figure 6-3 IPv6 Multicast Table

| Index                     | Multicast IP | VLAN ID | Source | Type | Forward Ports |
|---------------------------|--------------|---------|--------|------|---------------|
| No entries in this table. |              |         |        |      |               |
| Total: 0                  |              |         |        |      |               |

The multicast IP address table shows all valid Multicast IP-VLAN-Port entries:

|              |   |
|--------------|---|
| Multicast IP | Displays the multicast source IP address.   |
| VLAN ID      | Displays the ID of the VLAN the multicast group belongs to.   |
| Source       | Displays the source of the multicast entry.<br><br><b>MLD Snooping:</b> The multicast entry is learned by MLD Snooping.   |
| Type         | Displays how the multicast entry is generated.<br><br><b>Dynamic:</b> The entry is dynamically learned. All the member ports are dynamically added to the multicast group.<br><br><b>Static:</b> The entry is manually added. All the member ports are manually added to the multicast group.<br><br><b>Mix:</b> The entry is dynamically learned (manually learned), and some of the member ports are manually added (dynamically added) to the multicast group. |
| Forward Port | All ports in the multicast group, including router ports and member ports.  |

## 6.1.4 Viewing IPv6 Multicast Statistics on Each Port

Choose the menu **L2 FEATURES > Multicast > Multicast Info > IPv6 Multicast Statistics** to load the following page:

Figure 6-4 IPv6 Multicast Statistics

**Auto Refresh**

---

Auto Refresh:

Refresh Interval:  seconds (3-300)

[Apply](#)

---

**Port Statistics**

UNIT1

LAGS

[↻](#) Refresh

| ID        | Port   | Query Packets | Report Packets (v1) | Report Packets (v2) | Done Packets | Error Packets |
|-----------|--------|---------------|---------------------|---------------------|--------------|---------------|
| 1         | 1/0/1  | 0             | 0                   | 0                   | 0            | 0             |
| 2         | 1/0/2  | 0             | 0                   | 0                   | 0            | 0             |
| 3         | 1/0/3  | 0             | 0                   | 0                   | 0            | 0             |
| 4         | 1/0/4  | 0             | 0                   | 0                   | 0            | 0             |
| 5         | 1/0/5  | 0             | 0                   | 0                   | 0            | 0             |
| 6         | 1/0/6  | 0             | 0                   | 0                   | 0            | 0             |
| 7         | 1/0/7  | 0             | 0                   | 0                   | 0            | 0             |
| 8         | 1/0/8  | 0             | 0                   | 0                   | 0            | 0             |
| 9         | 1/0/9  | 0             | 0                   | 0                   | 0            | 0             |
| 10        | 1/0/10 | 0             | 0                   | 0                   | 0            | 0             |
| Total: 28 |        |               |                     |                     |              |               |

Follow these steps to view IPv6 multicast statistics on each port:

- 1) To get the real-time IPv6 multicast statistics, enable **Auto Refresh**, or click **Refresh**.

**Auto Refresh** Enable or disable Auto Refresh. When enabled, the switch will automatically refresh the multicast statistics.

**Refresh Interval** After **Auto Refresh** is enabled, specify the time interval for the switch to refresh the multicast statistics.

- 2) In the **Port Statistics** section, view IPv6 multicast statistics on each port.

**Query Packets** Displays the number of query packets received by the port.

**Report Packets (v1)** Displays the number of MLDv1 packets received by the port.

**Report Packets (v2)** Displays the number of MLDv2 packets received by the port.

**Done Packets** Displays the number of done packets received by the port.

---

|               |  |
|---------------|--|
| Error Packets | Displays the number of error packets received by the port. |
|---------------|--|

---

## 6.2 Using the CLI

### 6.2.1 Viewing IPv4 Multicast Snooping Information

---

**show ip igmp snooping groups [ vlan *vlan-id* ] [count | dynamic | dynamic count | static | static count ]**

Displays information of specific multicast group in all VLANs or in the specific VLAN.

count: Displays the number of multicast groups.

dynamic: Displays information of all dynamic multicast groups.

dynamic count: Displays the number of dynamic multicast groups.

static: Displays information of all static multicast groups.

static count: Displays the number of static multicast groups.

---

**show ip igmp snooping interface [ fastEthernet [ *port-list* ] | gigabitEthernet [ *port-list* ] | ten-gigabitEthernet [ *port-list* ] ] packet-stat**

Displays the packet statistics on specified ports or all ports.

---

**clear ip igmp snooping statistics**

Clear all statistics of all IGMP packets.

### 6.2.2 Viewing IPv6 Multicast Snooping Configurations

---

**show ipv6 mld snooping groups [vlan *vlan-id* ] [count | dynamic | dynamic count | static | static count ]**

Displays information of specific multicast group in all VLANs or in the specific VLAN.

count displays the number of multicast groups.

dynamic displays information of all dynamic multicast groups.

dynamic count displays the number of dynamic multicast groups.

static displays information of all static multicast groups.

static count displays the number of static multicast groups.

---

**show ipv6 mld snooping interface [ fastEthernet [ *port-list* ] | gigabitEthernet [ *port-list* ] | ten-gigabitEthernet [ *port-list* ] ] packet-stat**

Displays the packet statistics on specified ports or all ports.

---

**clear ipv6 mld snooping statistics**

Clear all statistics of all MLD packets.



# 7 Configuration Examples

## 7.1 Example for Configuring Basic IGMP Snooping

### 7.1.1 Network Requirements

Host B, Host C and Host D are in the same VLAN of the switch. All of them want to receive multicast streams sent to multicast group 225.1.1.1.

As shown in the following topology, Host B, Host C and Host D are connected to port 1/0/1, port 1/0/2 and port 1/0/3 respectively. Port 1/0/4 is the router port connected to the multicast querier.

Figure 7-1 Network Topology for Basic IGMP Snooping

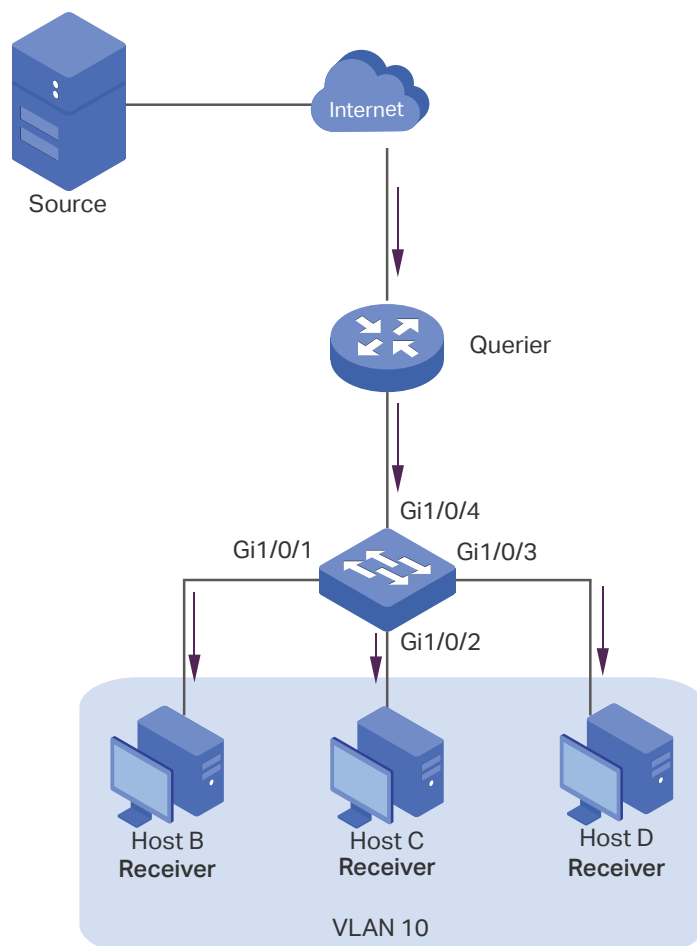

### 7.1.2 Configuration Scheme

- Add the three member ports and the router port to a VLAN and configure their PVIDs.
- Enable IGMP Snooping globally and in the VLAN.

- Enable IGMP Snooping on the ports.

Demonstrated with T1500-28PCT, this section provides configuration procedures in two ways: using the GUI and using the CLI.

### 7.1.3 Using the GUI

- 1) Choose the menu **L2 FEATURES > VLAN > 802.1Q VLAN > VLAN Config** and click  Add to load the following page. Create VLAN 10 and add Untagged port 1/0/1-3 and Tagged port 1/0/4 to VLAN 10.

Figure 7-2 Create VLAN 10

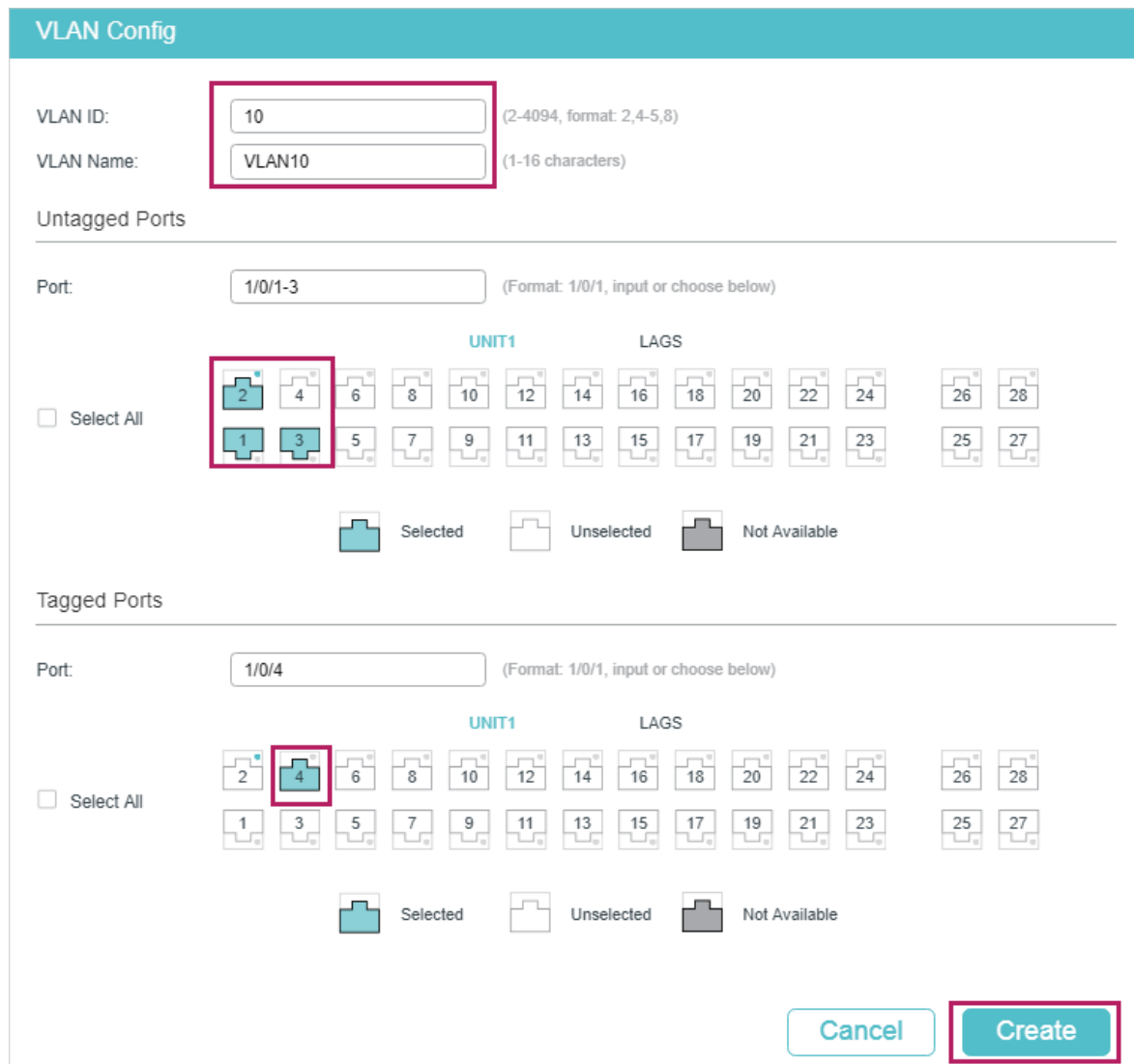

**VLAN Config**

VLAN ID:  (2-4094, format: 2,4-5,8)

VLAN Name:  (1-16 characters)

Untagged Ports

Port:  (Format: 1/0/1, input or choose below)

Select All

UNIT1 LAGS

|                                     |                                     |                          |                          |                          |                          |                          |                          |                          |                          |                          |                          |                          |                          |                          |                          |                          |                          |                          |                          |
|-------------------------------------|-------------------------------------|--------------------------|--------------------------|--------------------------|--------------------------|--------------------------|--------------------------|--------------------------|--------------------------|--------------------------|--------------------------|--------------------------|--------------------------|--------------------------|--------------------------|--------------------------|--------------------------|--------------------------|--------------------------|
| <input checked="" type="checkbox"/> | <input checked="" type="checkbox"/> | <input type="checkbox"/> | <input type="checkbox"/> | <input type="checkbox"/> | <input type="checkbox"/> | <input type="checkbox"/> | <input type="checkbox"/> | <input type="checkbox"/> | <input type="checkbox"/> | <input type="checkbox"/> | <input type="checkbox"/> | <input type="checkbox"/> | <input type="checkbox"/> | <input type="checkbox"/> | <input type="checkbox"/> | <input type="checkbox"/> | <input type="checkbox"/> | <input type="checkbox"/> | <input type="checkbox"/> |
| <input checked="" type="checkbox"/> | <input checked="" type="checkbox"/> | <input type="checkbox"/> | <input type="checkbox"/> | <input type="checkbox"/> | <input type="checkbox"/> | <input type="checkbox"/> | <input type="checkbox"/> | <input type="checkbox"/> | <input type="checkbox"/> | <input type="checkbox"/> | <input type="checkbox"/> | <input type="checkbox"/> | <input type="checkbox"/> | <input type="checkbox"/> | <input type="checkbox"/> | <input type="checkbox"/> | <input type="checkbox"/> | <input type="checkbox"/> | <input type="checkbox"/> |

Selected  Unselected  Not Available

Tagged Ports

Port:  (Format: 1/0/1, input or choose below)

Select All

|                          |                          |                                     |                          |                          |                          |                          |                          |                          |                          |                          |                          |                          |                          |                          |                          |                          |                          |                          |                          |
|--------------------------|--------------------------|-------------------------------------|--------------------------|--------------------------|--------------------------|--------------------------|--------------------------|--------------------------|--------------------------|--------------------------|--------------------------|--------------------------|--------------------------|--------------------------|--------------------------|--------------------------|--------------------------|--------------------------|--------------------------|
| <input type="checkbox"/> | <input type="checkbox"/> | <input checked="" type="checkbox"/> | <input type="checkbox"/> | <input type="checkbox"/> | <input type="checkbox"/> | <input type="checkbox"/> | <input type="checkbox"/> | <input type="checkbox"/> | <input type="checkbox"/> | <input type="checkbox"/> | <input type="checkbox"/> | <input type="checkbox"/> | <input type="checkbox"/> | <input type="checkbox"/> | <input type="checkbox"/> | <input type="checkbox"/> | <input type="checkbox"/> | <input type="checkbox"/> | <input type="checkbox"/> |
| <input type="checkbox"/> | <input type="checkbox"/> | <input type="checkbox"/>            | <input type="checkbox"/> | <input type="checkbox"/> | <input type="checkbox"/> | <input type="checkbox"/> | <input type="checkbox"/> | <input type="checkbox"/> | <input type="checkbox"/> | <input type="checkbox"/> | <input type="checkbox"/> | <input type="checkbox"/> | <input type="checkbox"/> | <input type="checkbox"/> | <input type="checkbox"/> | <input type="checkbox"/> | <input type="checkbox"/> | <input type="checkbox"/> | <input type="checkbox"/> |

Selected  Unselected  Not Available

- 2) Choose the menu **L2 FEATURES > VLAN > 802.1Q VLAN > Port Config** to load the following page. Configure the PVID of port 1/0/1-4 as 10.

Figure 7-3 Configure PVID for the Ports

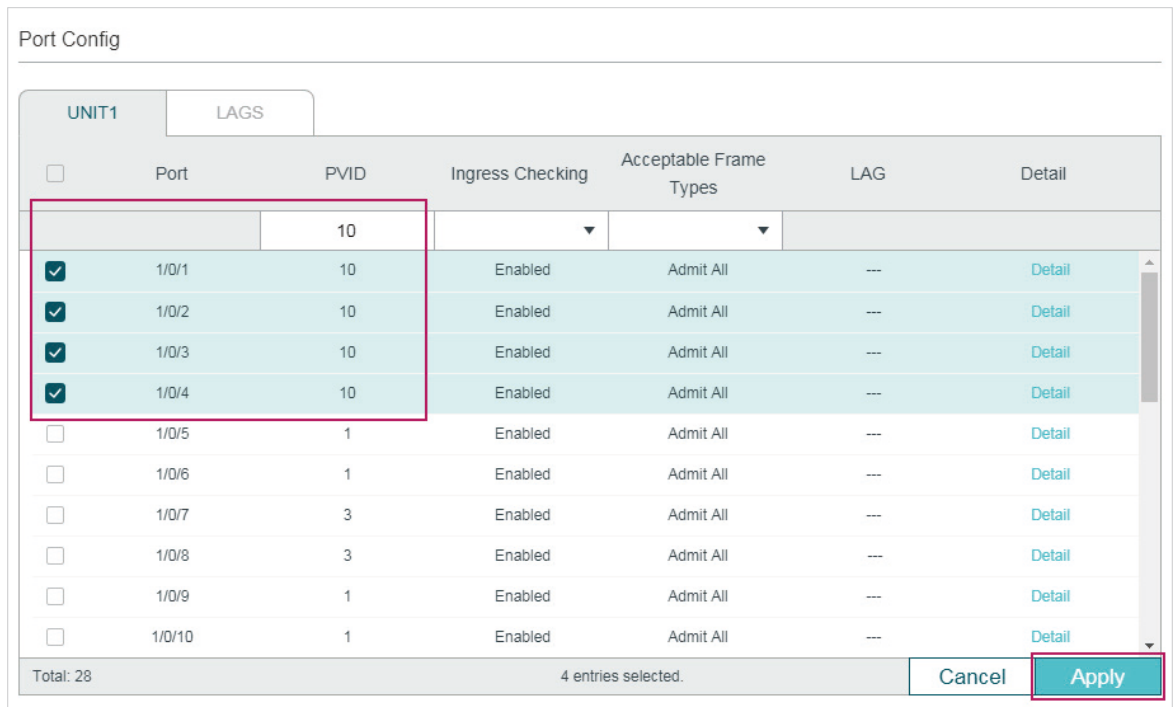

- 3) Choose the menu **L2 FEATURES > Multicast > IGMP Snooping > Global Config** to load the following page. In the **Global Config** section, enable IGMP Snooping globally. Configure the IGMP version as v3 so that the switch can process IGMP messages of all versions. Then click **Apply**.

Figure 7-4 Configure IGMP Snooping Globally

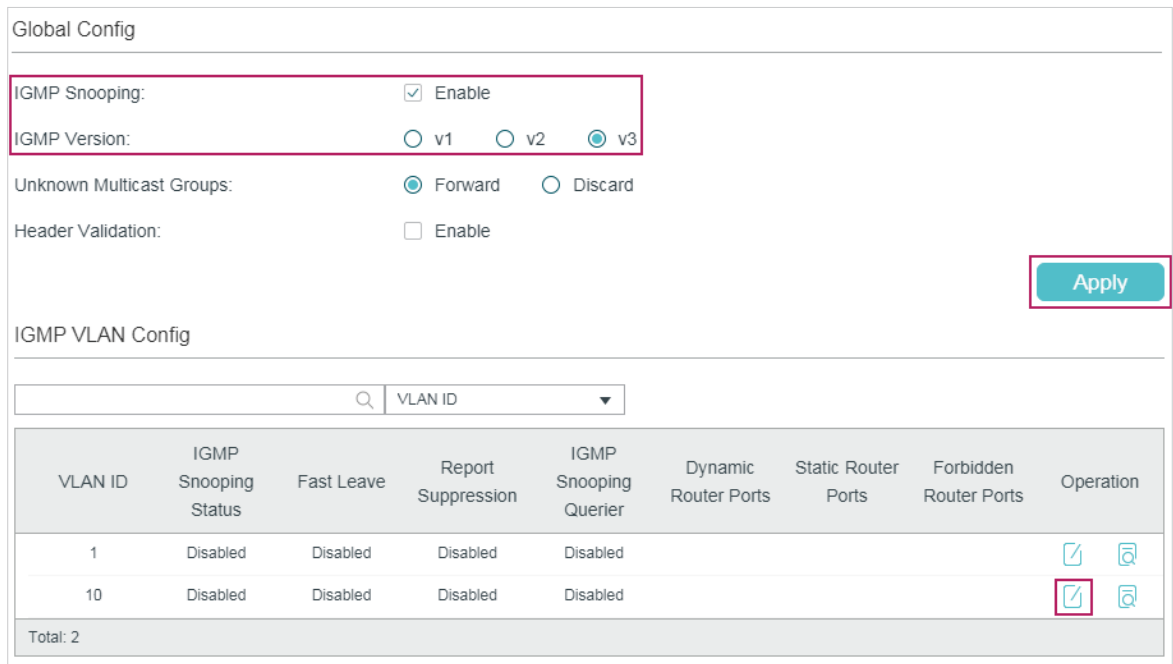

- 4) In the **IGMP VLAN Config** section, click in VLAN 10 to load the following page. Enable IGMP Snooping for VLAN 10.

Figure 7-5 Enable IGMP Snooping for VLAN 10

**Configure IGMP Snooping for VLAN**

VLAN ID: 10

IGMP Snooping Status:  Enable

Fast Leave:  Enable

Report Suppression:  Enable

Member Port Aging Time:  seconds (60-600)

Router Port Aging Time:  seconds (60-600)

IGMP Snooping Querier:  Enable

Static Router Ports

- 5) Choose the menu **L2 FEATURES > Multicast > IGMP Snooping > Port Config** to load the following page. Enable IGMP Snooping for ports 1/0/1-4.

Figure 7-6 Enable IGMP Snooping for the Ports

**Port Config**

UNIT1 | LAGS

| <input type="checkbox"/>            | Port   | IGMP Snooping | Fast Leave | LAG  |
|-------------------------------------|--------|---------------|------------|------|
| <input checked="" type="checkbox"/> | 1/0/1  | Enabled       | Disabled   | ---  |
| <input checked="" type="checkbox"/> | 1/0/2  | Enabled       | Disabled   | ---  |
| <input checked="" type="checkbox"/> | 1/0/3  | Enabled       | Disabled   | ---  |
| <input checked="" type="checkbox"/> | 1/0/4  | Enabled       | Disabled   | ---  |
| <input type="checkbox"/>            | 1/0/5  | Enabled       | Disabled   | ---  |
| <input type="checkbox"/>            | 1/0/6  | Enabled       | Disabled   | ---  |
| <input type="checkbox"/>            | 1/0/7  | Enabled       | Disabled   | LAG1 |
| <input type="checkbox"/>            | 1/0/8  | Enabled       | Disabled   | LAG1 |
| <input type="checkbox"/>            | 1/0/9  | Enabled       | Disabled   | ---  |
| <input type="checkbox"/>            | 1/0/10 | Enabled       | Disabled   | ---  |

Total: 28 | 4 entries selected. |

- 6) Click  Save to save the settings.

## 7.1.4 Using the CLI

- 1) Create VLAN 10.

```
Switch#configure
```

```
Switch(config)#vlan 10
```

```
Switch(config-vlan)#name vlan10
```

```
Switch(config-vlan)#exit
```

- 2) Add port 1/0/1-3 to VLAN 10 and set the link type as untagged. Add port 1/0/4 to VLAN 10 and set the link type as tagged.

```
Switch(config)#interface range fastEthernet 1/0/1-3
```

```
Switch(config-if-range)#switchport general allowed vlan 10 untagged
```

```
Switch(config-if-range)#exit
```

```
Switch(config)#interface fastEthernet 1/0/4
```

```
Switch(config-if)#switchport general allowed vlan 10 tagged
```

```
Switch(config-if)#exit
```

- 3) Set the PVID of port 1/0/1-4 as 10.

```
Switch(config)#interface range fastEthernet 1/0/1-4
```

```
Switch(config-if-range)#switchport pvid 10
```

```
Switch(config-if-range)#exit
```

- 4) Enable IGMP Snooping globally.

```
Switch(config)#ip igmp snooping
```

- 5) Enable IGMP Snooping in VLAN 10.

```
Switch(config)#ip igmp snooping vlan-config 10
```

- 6) Enable IGMP Snooping on port 1/0/1-4.

```
Switch(config)#interface range fastEthernet 1/0/1-4
```

```
Switch(config-if-range)#ip igmp snooping
```

```
Switch(config-if-range)#exit
```

- 7) Save the settings.

```
Switch(config)#end
```

```
Switch#copy running-config startup-config
```

## Verify the Configurations

Show members in the VLAN:

```
Switch(config)#show vlan brief
```

| VLAN | Name        | Status | Ports                               |
|------|-------------|--------|-------------------------------------|
| 1    | System-VLAN | active | Gi1/0/1, Gi1/0/2, Gi1/0/3, Gi1/0/4, |

```

                                Gi1/0/5, Gi1/0/6, Gi1/0/7, Gi1/0/8,
                                ...
10      vlan10      active      Gi1/0/1, Gi1/0/2, Gi1/0/3, Gi1/0/4

```

Show status of IGMP Snooping globally, on the ports and in the VLAN:

```

Switch(config)#show ip igmp snooping
IGMP Snooping      :Enable
IGMP Version       :V3
Header Validation   :Disable
Global Authentication Accounting :Disable
Enable Port : Gi1/0/1-4
Enable VLAN:10

```

## 7.2 Example for Configuring MVR

### 7.2.1 Network Requirements

Host B, Host C and Host D are in three different VLANs of the switch. All of them want to receive multicast streams sent to multicast group 225.1.1.1.

### 7.2.2 Network Topology

As shown in the following network topology, Host B, Host C and Host D are connected to port 1/0/1, port 1/0/2 and port 1/0/3 respectively. Port 1/0/1, port 1/0/2 and port 1/0/3 belong to VLAN 10, VLAN 20 and VLAN 30 respectively. Port 1/0/4 is connected to the multicast network in the upper layer network.

Figure 7-7 Network Topology for Multicast VLAN

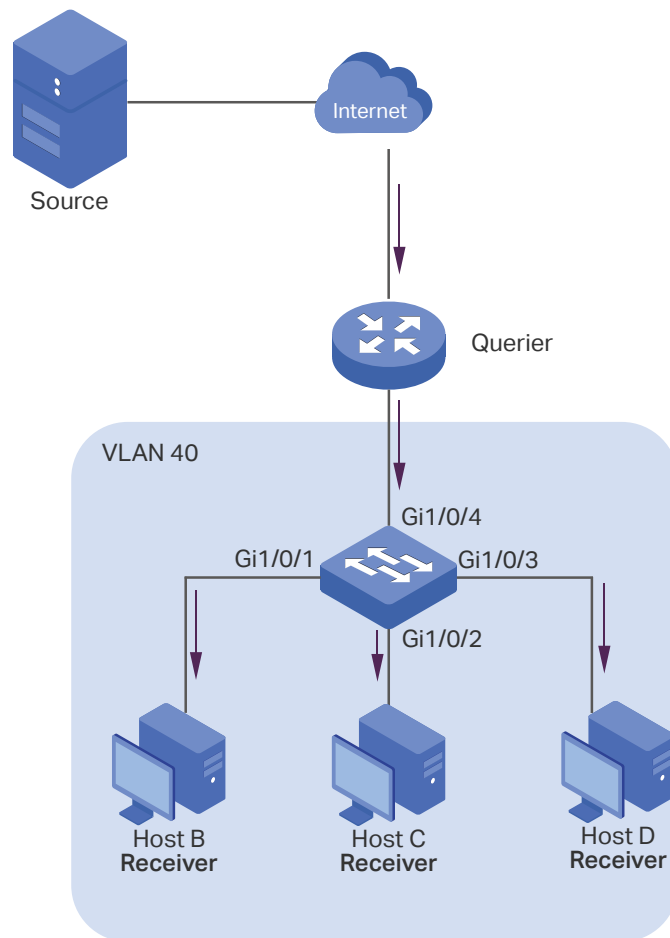

### 7.2.3 Configuration Scheme

As the hosts are in different VLANs, in IGMP Snooping, the Querier need to duplicate multicast streams for hosts in each VLAN. To avoid duplication of multicast streams being sent between Querier and the switch, you can configure MVR on the switch.

The switch can work in either MVR compatible mode or MVR dynamic mode. When in compatible mode, remember to statically configure the Querier to transmit the streams of multicast group 225.1.1.1 to the switch via the multicast VLAN. Here we take the MVR dynamic mode as an example.

Demonstrated with T1500-28PCT , this section provides configuration procedures in two ways: using the GUI and using the CLI.

### 7.2.4 Using the GUI

- 1) Add port 1/0/1-3 to VLAN 10, VLAN 20 and VLAN 30 as Untagged ports respectively, and configure the PVID of port 1/0/1 as 10, port 1/0/2 as 20, port 1/0/3 as 30. Make sure port 1/0/1-3 only belong to VLAN 10, VLAN 20 and VLAN 30 respectively. For details, refer to [Configuring 802.1Q VLAN](#).

Figure 7-8 VLAN Configurations for Port 1/0/1-3

VLAN Config

Search:  VLAN ID + Add - Delete

| <input type="checkbox"/> | VLAN ID | VLAN Name   | Members  | Operation                                   |
|--------------------------|---------|-------------|----------|---|
| <input type="checkbox"/> | 1       | System-VLAN | 1/0/4-28 | <a href="#">Edit</a> <a href="#">Delete</a> |
| <input type="checkbox"/> | 10      | VLAN10      | 1/0/1    | <a href="#">Edit</a> <a href="#">Delete</a> |
| <input type="checkbox"/> | 20      | VLAN20      | 1/0/2    | <a href="#">Edit</a> <a href="#">Delete</a> |
| <input type="checkbox"/> | 30      | VLAN30      | 1/0/3    | <a href="#">Edit</a> <a href="#">Delete</a> |

Total: 4

Figure 7-9 PVID for Port 1/0/1-3

Port Config

UNIT1 | LAGS

| <input type="checkbox"/> | Port   | PVID | Ingress Checking | Acceptable Frame Types | LAG | Detail                 |
|--------------------------|--------|------|------------------|------------------------|-----|------------------------|
| <input type="checkbox"/> | 1/0/1  | 10   | Enabled          | Admit All              | --- | <a href="#">Detail</a> |
| <input type="checkbox"/> | 1/0/2  | 20   | Enabled          | Admit All              | --- | <a href="#">Detail</a> |
| <input type="checkbox"/> | 1/0/3  | 30   | Enabled          | Admit All              | --- | <a href="#">Detail</a> |
| <input type="checkbox"/> | 1/0/4  | 1    | Enabled          | Admit All              | --- | <a href="#">Detail</a> |
| <input type="checkbox"/> | 1/0/5  | 1    | Enabled          | Admit All              | --- | <a href="#">Detail</a> |
| <input type="checkbox"/> | 1/0/6  | 1    | Enabled          | Admit All              | --- | <a href="#">Detail</a> |
| <input type="checkbox"/> | 1/0/7  | 1    | Enabled          | Admit All              | --- | <a href="#">Detail</a> |
| <input type="checkbox"/> | 1/0/8  | 1    | Enabled          | Admit All              | --- | <a href="#">Detail</a> |
| <input type="checkbox"/> | 1/0/9  | 1    | Enabled          | Admit All              | --- | <a href="#">Detail</a> |
| <input type="checkbox"/> | 1/0/10 | 1    | Enabled          | Admit All              | --- | <a href="#">Detail</a> |

Total: 28

- Choose the menu **L2 FEATURES > VLAN > 802.1Q VLAN > VLAN Config** and click **+ Add** to load the following page. Create VLAN 40 and add port 1/0/4 to the VLAN as Tagged port.



Figure 7-10 Create Multicast VLAN

**VLAN Config**

VLAN ID:  (2-4094, format: 2,4-5,8)

VLAN Name:  (1-16 characters)

Untagged Ports

Port:  (Format: 1/0/1, input or choose below)

Select All

UNIT1 LAGS

2 4 6 8 10 12 14 16 18 20 22 24 26 28

1 3 5 7 9 11 13 15 17 19 21 23 25 27

Selected  Unselected  Not Available

Tagged Ports

Port:  (Format: 1/0/1, input or choose below)

Select All

UNIT1 LAGS

2 4 6 8 10 12 14 16 18 20 22 24 26 28

1 3 5 7 9 11 13 15 17 19 21 23 25 27

Selected  Unselected  Not Available

- 3) Choose the menu **L2 FEATURES > Multicast > MVR > MVR Config** to load the following page. Enable MVR globally, and configure the MVR mode as **Dynamic**, multicast VLAN ID as **40**.

Figure 7-11 Configure MVR Globally

**MVR Config**

MVR:  Enable

MVR Mode:  Compatible  Dynamic

Multicast VLAN ID:  (1-4094)

Query Response Time:  tenths of a second (1-100)

Maximum Multicast Groups: 511

Current Multicast Groups: 0

- 4) Choose the menu **L2 FEATURES > Multicast > MVR > MVR Group Config** and click **+ Add** to load the following page. Add multicast group 225.1.1.1 to MVR.

Figure 7-12 Add Multicast Group to MVR

- 5) Choose the menu **L2 FEATURES > Multicast > MVR > Port Config** to load the following page. Enable MVR for port 1/0/1-4. Configure port 1/0/1-3 as **Receiver** ports and port 1/0/4 as **Source** port.

Figure 7-13 Configure MVR for the Ports

| <input type="checkbox"/> | Port   | Mode    | Type     | Status          | Immediate Leave |
|--------------------------|--------|---------|----------|-----------------|-----------------|
| <input type="checkbox"/> | 1/0/1  | Enable  | Receiver | Inactive/InVLAN | Disable         |
| <input type="checkbox"/> | 1/0/2  | Enable  | Receiver | Inactive/InVLAN | Disable         |
| <input type="checkbox"/> | 1/0/3  | Enable  | Receiver | Inactive/InVLAN | Disable         |
| <input type="checkbox"/> | 1/0/4  | Enable  | Source   | Inactive/InVLAN | Disable         |
| <input type="checkbox"/> | 1/0/5  | Disable | None     | Inactive/InVLAN | Disable         |
| <input type="checkbox"/> | 1/0/6  | Disable | None     | Inactive/InVLAN | Disable         |
| <input type="checkbox"/> | 1/0/7  | Disable | None     | Inactive/InVLAN | Disable         |
| <input type="checkbox"/> | 1/0/8  | Disable | None     | Inactive/InVLAN | Disable         |
| <input type="checkbox"/> | 1/0/9  | Disable | None     | Inactive/InVLAN | Disable         |
| <input type="checkbox"/> | 1/0/10 | Disable | None     | Inactive/InVLAN | Disable         |

Total: 28

- 6) Click  Save to save the settings.

## 7.2.5 Using the CLI

- 1) Create VLAN 10, VLAN 20, VLAN 30 and VLAN 40.

```
Switch#configure
```

```
Switch(config)#vlan 10,20,30,40
```

```
Switch(config-vlan)#exit
```

- 2) Add port 1/0/1-3 to VLAN 10, VLAN 20 and VLAN 30 as untagged ports respectively, and configure the PVID of port 1/0/1 as 10, port 1/0/2 as 20, port 1/0/3 as 30. Add port 1/0/4 to VLAN 40 as tagged port and configure the PVID as of port 1/0/4 as 40.

```
Switch(config)#interface fastEthernet 1/0/1
```

```
Switch(config-if)#switchport general allowed vlan 10 untagged
```

```

Switch(config-if)#switchport pvid 10
Switch(config-if)#exit
Switch(config)#interface fastEthernet 1/0/2
Switch(config-if)#switchport general allowed vlan 20 untagged
Switch(config-if)#switchport pvid 20
Switch(config-if)#exit
Switch(config)#interface fastEthernet 1/0/3
Switch(config-if)#switchport general allowed vlan 30 untagged
Switch(config-if)#switchport pvid 30
Switch(config-if)#exit
Switch(config)#interface fastEthernet 1/0/4
Switch(config-if)#switchport general allowed vlan 40 tagged
Switch(config-if)#switchport pvid 40
Switch(config-if)#exit

```

- 3) Check whether port 1/0/1-3 only belong to VLAN 10, VLAN 20 and VLAN 30 respectively. If not, delete them from the other VLANs. By default, all ports are in VLAN 1, so you need to delete them from VLAN 1.

```
Switch(config)#show vlan brief
```

| VLAN | Name        | Status | Ports   |
|------|-------------|--------|---|
| 1    | System-VLAN | active | Gi1/0/1, Gi1/0/2, Gi1/0/3, Gi1/0/4,<br>Gi1/0/5, Gi1/0/6, Gi1/0/7, Gi1/0/8,<br>... |
| 10   | VLAN10      | active | Gi1/0/1   |
| 20   | VLAN20      | active | Gi1/0/2   |
| 30   | VLAN30      | active | Gi1/0/3   |
| 40   | VLAN40      | active | Gi1/0/4   |

```

Switch(config)#interface range fastEthernet 1/0/1-3
Switch(config-if-range)#no switchport general allowed vlan 1
Switch(config-if-range)#exit

```

- 4) Enable MVR globally, and configure the MVR mode as **Dynamic**, multicast VLAN ID as **40**. Add multicast group 225.1.1.1 to MVR.

```
Switch(config)#mvr
Switch(config)#mvr mode dynamic
Switch(config)#mvr vlan 40
Switch(config)#mvr group 225.1.1.1 1
```

- 5) Enable MVR for port 1/0/1-4. Configure port 1/0/1-3 as **Receiver** ports and port 1/0/4 as **Source** port.

```
Switch(config)#interface range fastEthernet 1/0/1-3
Switch(config-if-range)#mvr
Switch(config-if-range)#mvr type receiver
Switch(config-if-range)#exit
Switch(config)#interface fastEthernet 1/0/4
Switch(config-if)#mvr
Switch(config-if)#mvr type source
Switch(config-if)#exit
```

- 6) Save the settings.

```
Switch(config)#end
Switch#copy running-config startup-config
```

## Verify the Configurations

Show the brief information of all VLANs:

```
Switch(config)#show vlan brief
```

| VLAN | Name        | Status | Ports                                      |
|------|-------------|--------|--|
| 1    | System-VLAN | active | Gi1/0/4, Gi1/0/5, Gi1/0/6, Gi1/0/7,<br>... |
| 10   | VLAN10      | active | Gi1/0/1                                    |
| 20   | VLAN20      | active | Gi1/0/2                                    |
| 30   | VLAN30      | active | Gi1/0/3                                    |
| 40   | VLAN40      | active | Gi1/0/4                                    |

Show the brief information of MVR:

```
Switch(config)#show mvr
```

```
MVR :Enable
```

```

MVR Multicast Vlan           :40
MVR Max Multicast Groups     :511
MVR Current Multicast Groups :1
MVR Global Query Response Time :5 (tenths of sec)
MVR Mode Type                :Dynamic

```

Show the membership of MVR groups:

```
Switch(config)#show mvr members
```

| MVR Group IP | Status | Members |
|--------------|--------|---------|
| -----        | -----  | -----   |
| 225.1.1.1    | active | Gi1/0/4 |

## 7.3 Example for Configuring Unknown Multicast and Fast Leave

### 7.3.1 Network Requirement

A user experiences lag when he is changing channel on his IPTV. He wants solutions to this problem. As shown in the following network topology, port 1/0/4 on the switch is connected to the upper layer network, and port 1/0/2 is connected to Host B.

Figure 7-14 Network Topology for Unknow Multicast and Fast Leave

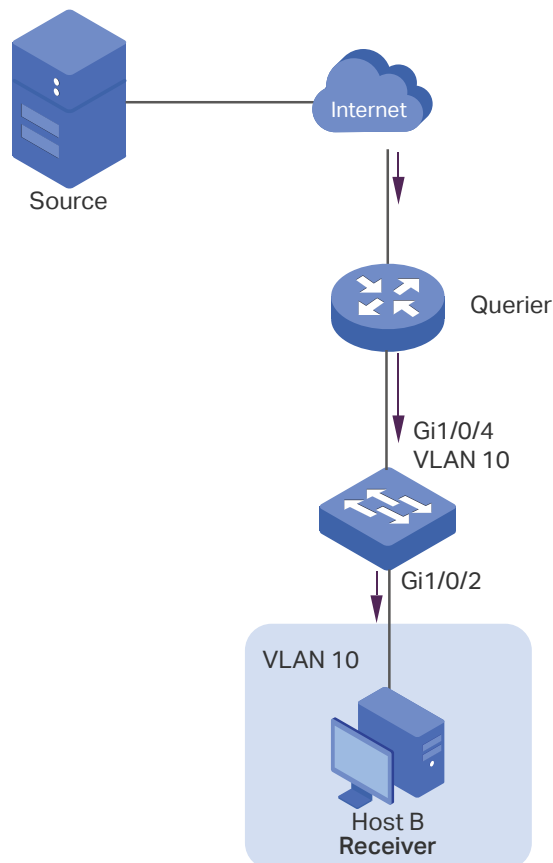

### 7.3.2 Configuration Scheme

After the channel is changed, the client (Host B) still receives irrelevant multicast data, the data from the previous channel and possibly other unknown multicast data, which increases the network load and results in network congestion.

To avoid Host B from receiving irrelevant multicast data, you can enable Fast Leave on port 1/0/2 and configure the switch to discard unknown multicast data. To change channel, Host B sends a leave message about leaving the previous channel. With Fast Leave enabled on port 1/0/2, the switch will then drop multicast data from the previous channel, which ensures that Host B only receives multicast data from the new channel and that the multicast network is unimpeded.

Demonstrated with T1500-28PCT, this section provides configuration procedures in two ways: using the GUI and using the CLI.

### 7.3.3 Using the GUI

- 1) Create VLAN 10. Add port 1/0/2 to the VLAN as untagged port and port 1/0/4 as tagged port. Configure the PVID of the two ports as 10. For details, refer to [Configuring 802.1Q VLAN](#).
- 2) Choose the menu **L2 FEATURES > Multicast > IGMP Snooping > Global Config** to load the following page. In the **Global Config** section, enable IGMP Snooping globally and configure Unknown Multicast Groups as **Discard**.

Figure 7-15 Configure IGMP Snooping Globally

Global Config

IGMP Snooping:  Enable

IGMP Version:  v1  v2  v3

Unknown Multicast Groups:  Forward  Discard

Header Validation:  Enable

Apply

IGMP VLAN Config

| VLAN ID  | IGMP Snooping Status | Fast Leave | Report Suppression | IGMP Snooping Querier | Dynamic Router Ports | Static Router Ports | Forbidden Router Ports | Operation  |
|----------|----------------------|------------|--------------------|-----------------------|----------------------|---------------------|------------------------|--|
| 1        | Disabled             | Disabled   | Disabled           | Disabled              |                      |                     |                        |  |
| 10       | Disabled             | Disabled   | Disabled           | Disabled              |                      |                     |                        | <span style="border: 1px solid #00a651; padding: 2px;"></span> |
| Total: 2 |                      |            |                    |                       |                      |                     |                        |  |

**Note:**

IGMP Snooping and MLD Snooping share the setting of Unknown Multicast, so you have to enable MLD Snooping globally on the **L2 FEATURES > Multicast > MLD Snooping > Global Config** page at the same time.

- 3) In the **IGMP VLAN Config** section, click in VLAN 10 to load the following page. Enable IGMP Snooping for VLAN 10.

Figure 7-16 Enable IGMP Snooping for VLAN 10

Configure IGMP Snooping for VLAN

VLAN ID: 10

IGMP Snooping Status:  Enable

Fast Leave:  Enable

Report Suppression:  Enable

Member Port Aging Time:  seconds (60-600)

Router Port Aging Time:  seconds (60-600)

IGMP Snooping Querier:  Enable

Static Router Ports

- 4) Choose the menu **L2 FEATURES > Multicast > IGMP Snooping > Port Config** to load the following page. Enable IGMP Snooping on port 1/0/2 and port 1/0/4 and enable Fast Leave on port 1/0/2.

Figure 7-17 Configure IGMP Snooping on Ports

Port Config

UNIT1 LAGS

| <input type="checkbox"/>            | Port   | IGMP Snooping | Fast Leave | LAG |
|-------------------------------------|--------|---------------|------------|-----|
| <input type="checkbox"/>            | 1/0/1  | Enabled       | Disabled   | --- |
| <input checked="" type="checkbox"/> | 1/0/2  | Enabled       | Enabled    | --- |
| <input type="checkbox"/>            | 1/0/3  | Enabled       | Disabled   | --- |
| <input type="checkbox"/>            | 1/0/4  | Enabled       | Disabled   | --- |
| <input type="checkbox"/>            | 1/0/5  | Enabled       | Disabled   | --- |
| <input type="checkbox"/>            | 1/0/6  | Enabled       | Disabled   | --- |
| <input type="checkbox"/>            | 1/0/7  | Enabled       | Disabled   | --- |
| <input type="checkbox"/>            | 1/0/8  | Enabled       | Disabled   | --- |
| <input type="checkbox"/>            | 1/0/9  | Enabled       | Disabled   | --- |
| <input type="checkbox"/>            | 1/0/10 | Enabled       | Disabled   | --- |

Total: 28 1 entry selected. Cancel Apply

- 5) Click  Save to save the settings.

### 7.3.4 Using the CLI

- 1) Enable IGMP Snooping and MLD Snooping globally.

```
Switch#configure
```

```
Switch(config)#ip igmp snooping
```

```
Switch(config)#ipv6 mld snooping
```

- 2) Configure Unknown Multicast Groups as Discard globally.

```
Switch(config)#ip igmp snooping drop-unknown
```

- 3) Enable IGMP Snooping on port 1/0/2 and enable Fast Leave. On port 1/0/4, enable IGMP Snooping.

```
Switch(config)#interface fastEthernet 1/0/2
```

```
Switch(config-if)#ip igmp snooping
```

```
Switch(config-if)#ip igmp snooping immediate-leave
```

```
Switch(config-if)#exit
```

```
Switch(config)#interface fastEthernet 1/0/4
```

```
Switch(config-if)#ip igmp snooping
```

```
Switch(config-if)#exit
```

- 4) Enable IGMP Snooping in VLAN 10.

```
Switch(config)#ip igmp snooping vlan-config 10
```



- 5) Save the settings.

```
Switch(config)#end
```

```
Switch#copy running-config startup-config
```

### Verify the Configurations

Show global settings of IGMP Snooping:

```
Switch(config)#show ip igmp snooping
```

```
IGMP Snooping           :Enable
```

```
IGMP Version             :V3
```

```
Unknown Multicast       :Discard
```

...

```
Enable Port: Gi1/0/1-28
```

```
Enable VLAN:10
```

Show settings of IGMP Snooping on port 1/0/2:

```
Switch(config)#show ip igmp snooping interface fastEthernet 1/0/2 basic-config
```

```
Port      IGMP-Snooping      Fast-Leave
```

```
-----
```

```
Gi1/0/2   enable           enable
```

## 7.4 Example for Configuring Multicast Filtering

### 7.4.1 Network Requirements

Host B, Host C and Host D are in the same subnet. Host C and Host D only receive multicast data sent to 225.0.0.1, while Host B receives all multicast data except the one sent from 225.0.0.2.

### 7.4.2 Configuration Scheme

With the functions for managing multicast groups, whitelist and blacklist mechanism (profile binding), the switch can only allow specific member ports to join specific multicast groups or disallow specific member ports to join specific multicast groups. You can achieve this filtering function by creating a profile and binding it to the corresponding member port.

### 7.4.3 Network Topology

As shown in the following network topology, Host B is connected to port 1/0/1, Host C is connected to port 1/0/2 and Host D is connected to port 1/0/3. They are all in VLAN 10.

Figure 7-18 Network Topology for Multicast Filtering

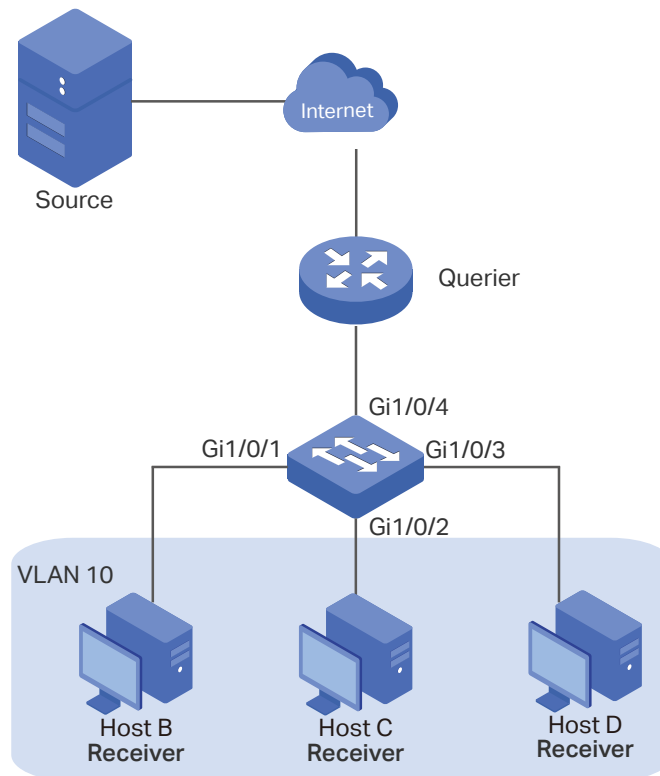

Demonstrated with T1500-28PCT , this section provides configuration procedures in two ways: using the GUI and using the CLI.

### 7.4.4 Using the GUI

- 1) Create VLAN 10. Add port 1/0/1-3 to the VLAN as untagged port and port 1/0/4 as tagged port. Configure the PVID of the four ports as 10. For details, refer to [Configuring 802.1Q VLAN](#).
- 2) Choose the menu **L2 FEATURES > Multicast > IGMP Snooping > Global Config** to load the following page. In the **Global Config** section, enable IGMP Snooping globally.

Figure 7-19 Enable IGMP Snooping Globally

**Global Config**

---

IGMP Snooping:  Enable

IGMP Version:  v1  v2  v3

Unknown Multicast Groups:  Forward  Discard

Header Validation:  Enable

Apply

---

**IGMP VLAN Config**

| VLAN ID  | IGMP Snooping Status | Fast Leave | Report Suppression | IGMP Snooping Querier | Dynamic Router Ports | Static Router Ports | Forbidden Router Ports | Operation   |
|----------|----------------------|------------|--------------------|-----------------------|----------------------|---------------------|------------------------|---|
| 1        | Disabled             | Disabled   | Disabled           | Disabled              |                      |                     |                        | <a href="#">✎</a> <a href="#">🔍</a>   |
| 10       | Disabled             | Disabled   | Disabled           | Disabled              |                      |                     |                        | <span style="border: 2px solid #e91e63; padding: 2px;"><a href="#">✎</a></span> <a href="#">🔍</a> |
| Total: 2 |                      |            |                    |                       |                      |                     |                        |   |

- 3) In the **IGMP VLAN Config** section, click [✎](#) in VLAN 10 to load the following page. Enable IGMP Snooping for VLAN 10.

Figure 7-20 Enable IGMP Snooping for VLAN 10

Configure IGMP Snooping for VLAN

VLAN ID: 10

IGMP Snooping Status:  Enable

Fast Leave:  Enable

Report Suppression:  Enable

Member Port Aging Time:  seconds (60-600)

Router Port Aging Time:  seconds (60-600)

IGMP Snooping Querier:  Enable

Static Router Ports

- 4) Choose the menu **L2 FEATURES > Multicast > IGMP Snooping > Port Config** to load the following page.

Figure 7-21 Enable IGMP Snooping on the Port

The screenshot shows the 'Port Config' interface with a table of ports. The table has columns for 'Port', 'IGMP Snooping', 'Fast Leave', and 'LAG'. The first four rows (ports 1/0/1 to 1/0/4) are highlighted in light blue, indicating they are selected. The 'IGMP Snooping' column for these rows is 'Enabled', while for the other rows it is 'Enabled' but the checkbox is unchecked. The 'Fast Leave' column is 'Disabled' for all rows. The 'LAG' column shows 'LAG1' for ports 1/0/7 and 1/0/8, and '---' for others. At the bottom, there is a status bar showing 'Total: 28' and '4 entries selected.', along with 'Cancel' and 'Apply' buttons.

| Port                                      | IGMP Snooping | Fast Leave | LAG  |
|---|---------------|------------|------|
| <input checked="" type="checkbox"/> 1/0/1 | Enabled       | Disabled   | ---  |
| <input checked="" type="checkbox"/> 1/0/2 | Enabled       | Disabled   | ---  |
| <input checked="" type="checkbox"/> 1/0/3 | Enabled       | Disabled   | ---  |
| <input checked="" type="checkbox"/> 1/0/4 | Enabled       | Disabled   | ---  |
| <input type="checkbox"/> 1/0/5            | Enabled       | Disabled   | ---  |
| <input type="checkbox"/> 1/0/6            | Enabled       | Disabled   | ---  |
| <input type="checkbox"/> 1/0/7            | Enabled       | Disabled   | LAG1 |
| <input type="checkbox"/> 1/0/8            | Enabled       | Disabled   | LAG1 |
| <input type="checkbox"/> 1/0/9            | Enabled       | Disabled   | ---  |
| <input type="checkbox"/> 1/0/10           | Enabled       | Disabled   | ---  |

- 5) Choose the menu **L2 FEATURES > Multicast > Multicast Filtering > IPv4 Profile** and click **+ Add** to load the following page. Create Profile 1, specify the mode as **Permit**, bind the profile to port 1/0/2-3, and specify the filtering multicast IP address as 225.0.0.1. Then click **Back** to return to the **IPv4 Profile Table** page.

Figure 7-22 Configure Filtering Profile for Host C and Host D

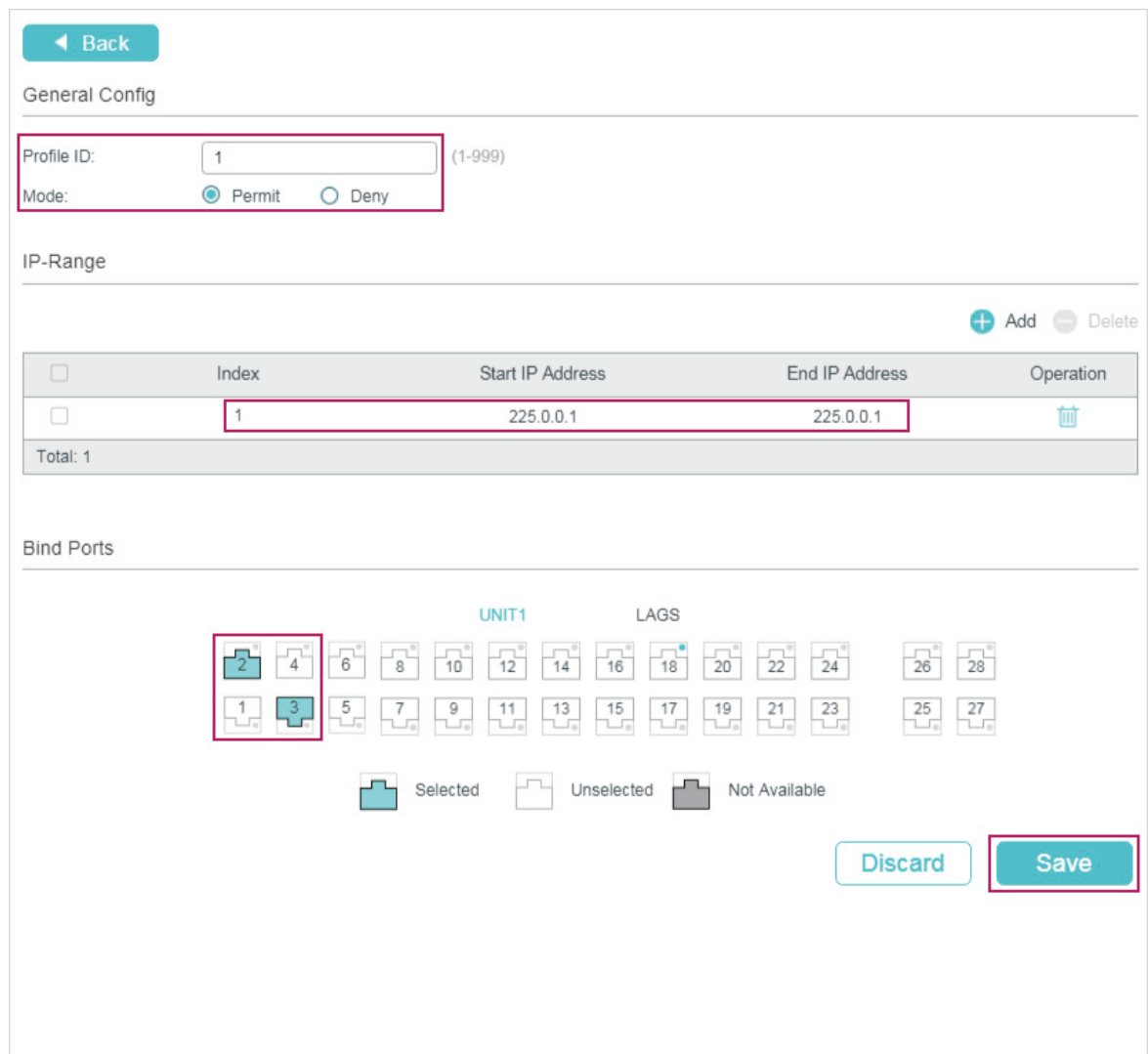

- Click Add again to load the following page. Create Profile 2, specify the mode as **Deny**, bind the profile to port 1/0/1, and specify the filtering multicast IP address as 225.0.0.2.

Figure 7-23 Configure Filtering Profile for Host B

General Config

Profile ID:  (1-999)

Mode:  Permit  Deny

IP-Range

+ Add - Delete

| <input type="checkbox"/> | Index | Start IP Address | End IP Address | Operation |
|--------------------------|-------|------------------|----------------|-----------|
| <input type="checkbox"/> | 1     | 225.0.0.2        | 225.0.0.2      |           |

Total: 1

Bind Ports

UNIT1 LAGS

2 4 6 8 10 12 14 16 18 20 22 24 26 28

1 3 5 7 9 11 13 15 17 19 21 23 25 27

Selected Unselected Not Available

Discard Save

7) Click Save to save the settings.

## 7.4.5 Using the CLI

1) Create VLAN 10.

```
Switch#configure
```

```
Switch(config)#vlan 10
```

```
Switch(config-vlan)#name vlan10
```

```
Switch(config-vlan)#exit
```

2) Add port 1/0/1-3 to VLAN 10 and set the link type as untagged. Add port 1/0/4 to VLAN 10 and set the link type as tagged.

```
Switch(config)#interface range fastEthernet 1/0/1-3
```

```
Switch(config-if-range)#switchport general allowed vlan 10 untagged
```

```
Switch(config-if-range)#exit
```

```
Switch(config)#interface fastEthernet 1/0/4
```

```
Switch(config-if)#switchport general allowed vlan 10 tagged
```

```
Switch(config-if)#exit
```

- 3) Set the PVID of port 1/0/1-4 as 10.

```
Switch(config)#interface range fastEthernet 1/0/1-4
```

```
Switch(config-if-range)#switchport pvid 10
```

```
Switch(config-if-range)#exit
```

- 4) Enable IGMP Snooping Globally.

```
Switch(config)#ip igmp snooping
```

- 5) Enable IGMP Snooping in VLAN 10.

```
Switch(config)#ip igmp snooping vlan-config 10
```

- 6) Enable IGMP Snooping on port 1/0/1-4.

```
Switch(config)#interface range fastEthernet 1/0/1-4
```

```
Switch(config-if-range)#ip igmp snooping
```

```
Switch(config-if-range)#exit
```

- 7) Create Profile 1, configure the mode as permit, and add an IP range with both start IP and end IP being 225.0.0.1.

```
Switch(config)#ip igmp profile 1
```

```
Switch(config-igmp-profile)#permit
```

```
Switch(config-igmp-profile)#range 225.0.0.1 225.0.0.1
```

```
Switch(config-igmp-profile)#exit
```

- 8) Bind Profile 1 to Port 1/0/2 and Port 1/10/3.

```
Switch(config)#interface range fastEthernet 1/0/2-3
```

```
Switch(config-if-range)#ip igmp filter 1
```

```
Switch(config-if-range)#exit
```

- 9) Create Profile 2, configure the mode as deny, and add an IP range with both start IP and end IP being 225.0.0.2.

```
Switch(config)#ip igmp profile 2
```

```
Switch(config-igmp-profile)#deny
```

```
Switch(config-igmp-profile)#range 225.0.0.2 225.0.0.2
```

```
Switch(config-igmp-profile)#exit
```

- 10) Bind Profile 2 to Port 1/0/1.

```
Switch(config)#interface fastEthernet 1/0/1
Switch(config-if)#ip igmp filter 2
Switch(config-if)#exit
```

11) Save the settings.

```
Switch(config)#end
Switch#copy running-config startup-config
```

## Verify the Configurations

Show global settings of IGMP Snooping:

```
Switch(config)#show ip igmp snooping
```

```
IGMP Snooping           :Enable
```

```
IGMP Version             :V3
```

...

```
Enable Port:Gi1/0/1-4
```

```
Enable VLAN:10
```

Show all profile bindings:

```
Switch(config)#show ip igmp profile
```

```
IGMP Profile 1
```

```
  permit
```

```
  range 225.0.0.1 225.0.0.1
```

```
  Binding Port(s)
```

```
    Gi1/0/2-3
```

```
IGMP Profile 2
```

```
  deny
```

```
  range 225.0.0.2 225.0.0.2
```

```
  Binding Port(s)
```

```
    Gi1/0/1
```



# 8 Appendix: Default Parameters

## 8.1 Default Parameters for IGMP Snooping

Table 8-1 Default Parameters of IGMP Snooping

| Function                                   | Parameter                      | Default Setting |
|--|--------------------------------|-----------------|
| Global Settings of IGMP Snooping           | IGMP Snooping                  | Disabled        |
|  | IGMP Version                   | v3              |
|  | Unknown Multicast Groups       | Forward         |
|  | Header Validation              | Disabled        |
| IGMP Snooping Settings in the VLAN         | IGMP Snooping                  | Disabled        |
|  | Fast Leave                     | Disabled        |
|  | Report Suppression             | Disabled        |
|  | Member Port Aging Time         | 260 seconds     |
|  | Router Port Aging Time         | 300 seconds     |
|  | Leave Time                     | 1 second        |
|  | IGMP Snooping Querier          | Disabled        |
|  | Query Interval                 | 60 seconds      |
|  | Maximum Response Time          | 10 seconds      |
|  | Last Member Query Interval     | 1 second        |
|  | Last Member Query Count        | 2               |
|  | General Query Source IP        | 0.0.0.0         |
|  | Static Router Ports            | None            |
|  | Forbidden Router Ports         | None            |
| IGMP Snooping Settings on the Port and LAG | IGMP Snooping                  | Enabled         |
|  | Fast Leave                     | Disabled        |
| Static Multicast Group Settings            | Static Multicast Group Entries | None            |

## 8.2 Default Parameters for MLD Snooping

Table 8-2 Default Parameters of MLD Snooping

| Function                                  | Parameter                      | Default Setting |
|---|--------------------------------|-----------------|
| Global Settings of IGMP Snooping          | MLD Snooping                   | Disabled        |
|   | Unknown Multicast Groups       | Forward         |
| MLD Snooping Settings in the VLAN         | MLD Snooping                   | Disabled        |
|   | Fast Leave                     | Disabled        |
|   | Report Suppression             | Disabled        |
|   | Member Port Aging Time         | 260 seconds     |
|   | Router Port Aging Time         | 300 seconds     |
|   | Leave Time                     | 1 second        |
|   | MLD Snooping Querier           | Disabled        |
|   | Query Interval                 | 60 seconds      |
|   | Maximum Response Time          | 10 seconds      |
|   | Last Listener Query Interval   | 1 second        |
|   | Last Listener Query Count      | 2               |
|   | General Query Source IP        | ::              |
|   | Static Router Ports            | None            |
|   | Forbidden Router Ports         | None            |
| MLD Snooping Settings on the Port and LAG | MLD Snooping                   | Enabled         |
|   | Fast Leave                     | Disabled        |
| Static Multicast Group Settings           | Static Multicast Group Entries | None            |

## 8.3 Default Parameters for MVR

Table 8-3 Default Parameters of MVR

| Function                 | Parameter                       | Default Setting      |
|--------------------------|---------------------------------|----------------------|
| Global Settings of MVR   | MVR                             | Disabled             |
|                          | MVR Mode                        | Compatible           |
|                          | Multicast VLAN ID               | 1                    |
|                          | Query Response Time             | 5 tenths of a second |
|                          | Maximum Multicast Groups        | 511                  |
| MVR Group Settings       | MVR Group Entries               | None                 |
| MVR Settings on the Port | MVR Mode                        | Disabled             |
|                          | MVR Port Type                   | None                 |
|                          | Fast Leave                      | Disabled             |
| MVR Static Group Members | MVR Static Group Member Entries | None                 |

## 8.4 Default Parameters for Multicast Filtering

Table 8-4 Default Parameters of Multicast Filtering

| Function   | Parameter                             | Default Setting |
|--|---------------------------------------|-----------------|
| Profile Settings                                 | IPv4 Profile and IPv6 Profile Entries | None            |
| Multicast Filtering Settings on the Port and LAG | Bound Profile                         | None            |
|  | Maximum Groups                        | 511             |
|  | Overflow Action                       | Drop            |

# Part 11

## Configuring Spanning Tree

### CHAPTERS

1. Spanning Tree
2. STP/RSTP Configurations
3. MSTP Configurations
4. STP Security Configurations
5. Configuration Example for MSTP
6. Appendix: Default Parameters

# 1 Spanning Tree

## 1.1 Overview

### STP

STP (Spanning Tree Protocol) is a layer 2 Protocol that prevents loops in the network. As is shown in Figure 1-1, STP helps to:

- Block specific ports of the switches to build a loop-free topology.
- Detect topology changes and automatically generate a new loop-free topology.

Figure 1-1 STP Function

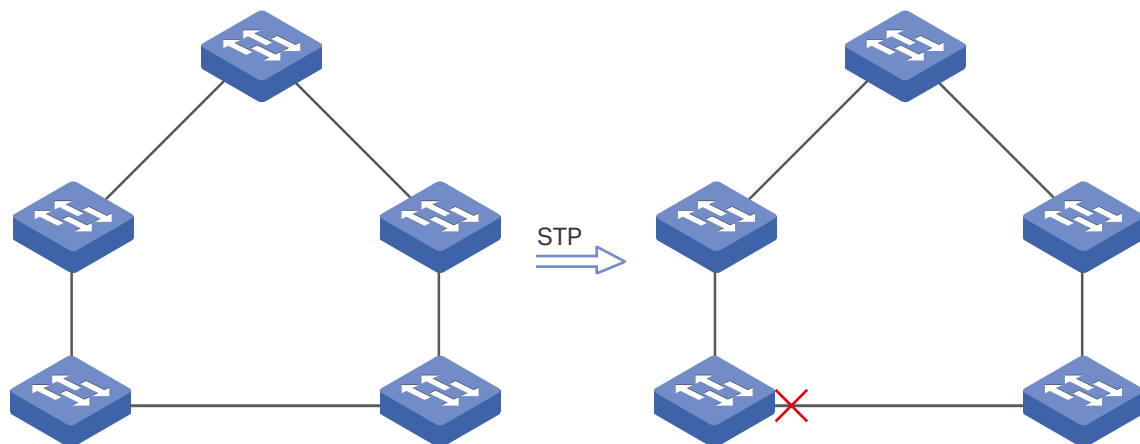

### RSTP

RSTP (Rapid Spanning Tree Protocol) provides the same features as STP. Besides, RSTP can provide much faster spanning tree convergence.

### MSTP

MSTP (Multiple Spanning Tree Protocol) also provides the fast spanning tree convergence as RSTP. In addition, MSTP enables VLANs to be mapped to different spanning trees (MST instances), and traffic in different VLANs will be transmitted along their respective paths, implementing load balancing.

## 1.2 Basic Concepts

### 1.2.1 STP/RSTP Concepts

Based on the networking topology below, this section will introduce some basic concepts in STP/RSTP.

Figure 1-2 STP/RSTP Topology

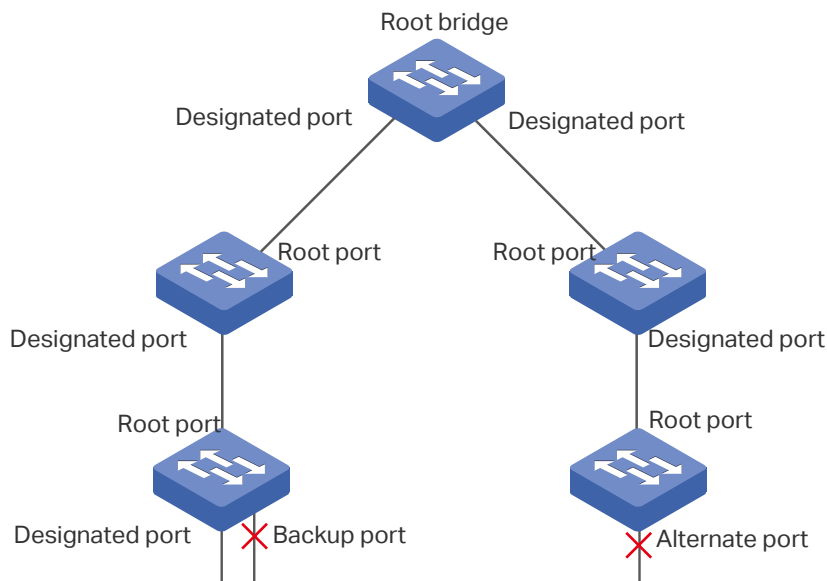

## Root Bridge

The root bridge is the root of a spanning tree. The switch with the lowest bridge ID will be the root bridge, and there is only one root bridge in a spanning tree.

## Bridge ID

Bridge ID is used to select the root bridge. It is composed of a 2-byte priority and a 6-byte MAC address. The priority is allowed to be configured manually on the switch, and the switch with the lowest priority value will be elected as the root bridge. If the priority of the switches are the same, the switch with the smallest MAC address will be selected as the root bridge.

## Port Role

### ■ Root Port

The root port is selected on non-root bridge that can provide the lowest root path cost. There is only one root port in each non-root bridge.

### ■ Designated Port

The designated port is selected in each LAN segment that can provide the lowest root path cost from that LAN segment to the root bridge.

### ■ Alternate Port

If a port is not selected as the designated port for it receives better BPDUs from another switch, it will become an alternate port.

In RSTP/MSTP, the alternate port is the backup for the root port. It is blocked when the root port works normally. Once the root port fails, the alternate port will become the new root port.

In STP, the alternate port is always blocked.

#### ■ Backup Port

If a port is not selected as the designated port for it receives better BPDUs from the switch it belongs to, it will become an backup port.

In RSTP/MSTP, the backup port is the backup for the designated port. It is blocked when the designated port works normally. Once the root port fails, the backup port will become the new designated port.

In STP, the backup port is always blocked.

#### ■ Disable Port

The disconnected port with spanning tree function enabled .

### Port Status

Generally, in STP, the port status includes: Blocking, Listening, Learning, Forwarding and Disabled.

#### ■ Blocking

In this status, the port receives and sends BPDUs. The other packets are dropped.

#### ■ Listening

In this status, the port receives and sends BPDUs. The other packets are dropped.

#### ■ Learning

In this status, the port receives and sends BPDUs. It also receives the other user packets to update its MAC address table, but doesn't forward them.

#### ■ Forwarding

In this status, the port receives and sends BPDUs. It also receives the other user packets to update its MAC address table, and forwards them.

#### ■ Disabled

In this status, the port is not participating in the spanning tree, and drops all the packets it receives.

In RSTP/MSTP, the port status includes: Discarding, Learning and Forwarding. The Discarding status is the grouping of STP's Blocking, Listening and Disabled, and the

Learning and Forwarding status correspond exactly to the Learning and Forwarding status specified in STP.

In TP-Link switches, the port status includes: Blocking, Learning, Forwarding and Disconnected.

- **Blocking**

In this status, the port receives and sends BPDUs. The other packets are dropped.

- **Learning**

In this status, the port receives and sends BPDUs. It also receives the other user packets to update its MAC address table, but doesn't forward them.

- **Forwarding**

In this status, the port receives and sends BPDUs. It also receives the other user packets to update its MAC address table, and forwards them.

- **Disconnected**

In this status, the port is enabled with spanning tree function but not connected to any device.

## Path Cost

The path cost reflects the link speed of the port. The smaller the value, the higher link speed the port has.

The path cost can be manually configured on each port. If not, the path cost values are automatically calculated according to the link speed as shown below:

Table 1-1 The Default Path Cost Value

| Link Speed | Path Cost Value |
|------------|-----------------|
| 10Mb/s     | 2,000,000       |
| 100Mb/s    | 200,000         |
| 1Gb/s      | 20,000          |
| 10Gb/s     | 2,000           |

## Root Path Cost

The root path cost is the accumulated path costs from the root bridge to the other switches. When root bridge sends its BPDU, the root path cost value is 0. When a switch receives this BPDU, the root path cost will be increased according to the path cost of the receive port. Then it create a new BPDU with the new root file cost and forwards it to the



downstream switch. The value of the accumulated root path cost increases as the BPDU spreads further.

## BPDU

BPDU is a kind of packet that is used to generate and maintain the spanning tree. The BPDUs (Bridge Protocol Data Unit) contain a lot of information, like bridge ID, root path cost, port priority and so on. Switches share these information to help determine the spanning tree topology.

## 1.2.2 MSTP Concepts

MSTP, compatible with STP and RSTP, has the same basic elements used in STP and RSTP. Based on the networking topology, this section will introduce some concepts only used in MSTP.

Figure 1-3 MSTP Topology

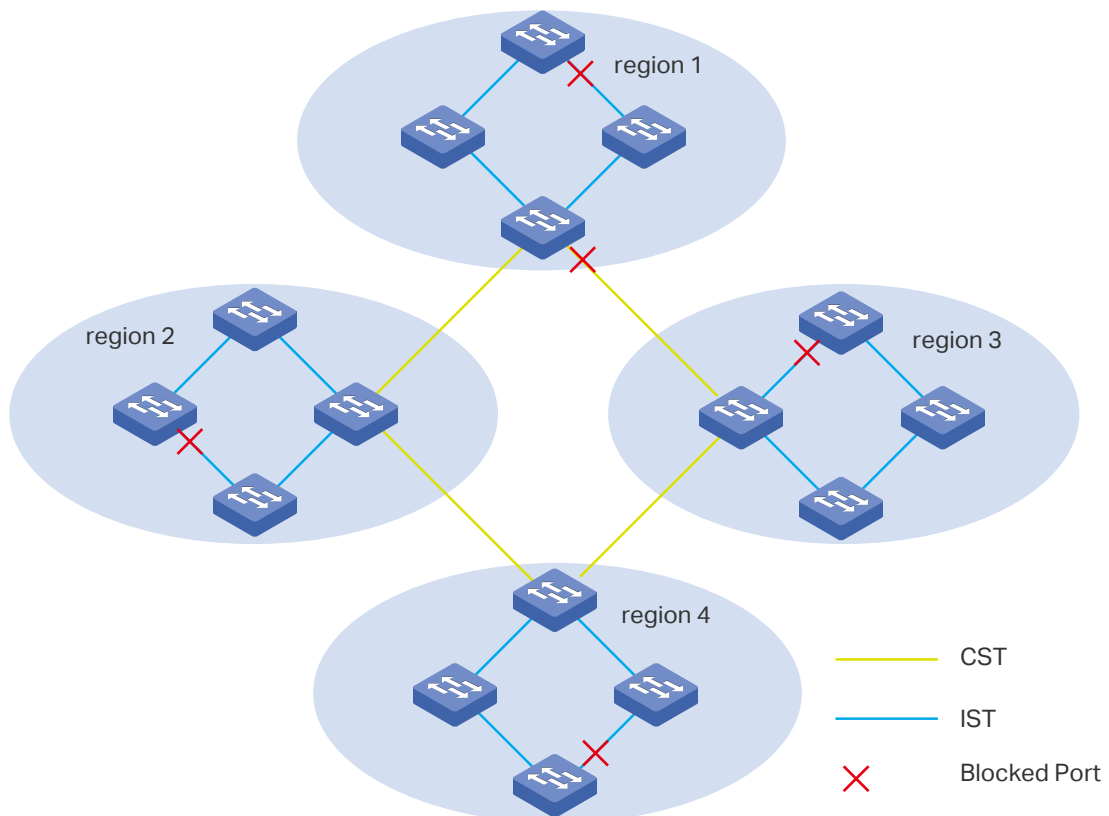

### MST Region

An MST region consists of multiple interconnected switches. The switches with the same following characteristics are considered as in the same region:

- Same region name
- Same revision level
- Same VLAN-Instance mapping

## MST Instance

The MST instance is a spanning tree running in the MST region. Multiple MST instances can be established in one MST region and they are independent of each other. As is shown in Figure 1-4, there are three instances in a region, and each instance has its own root bridge.

Figure 1-4 MST Region

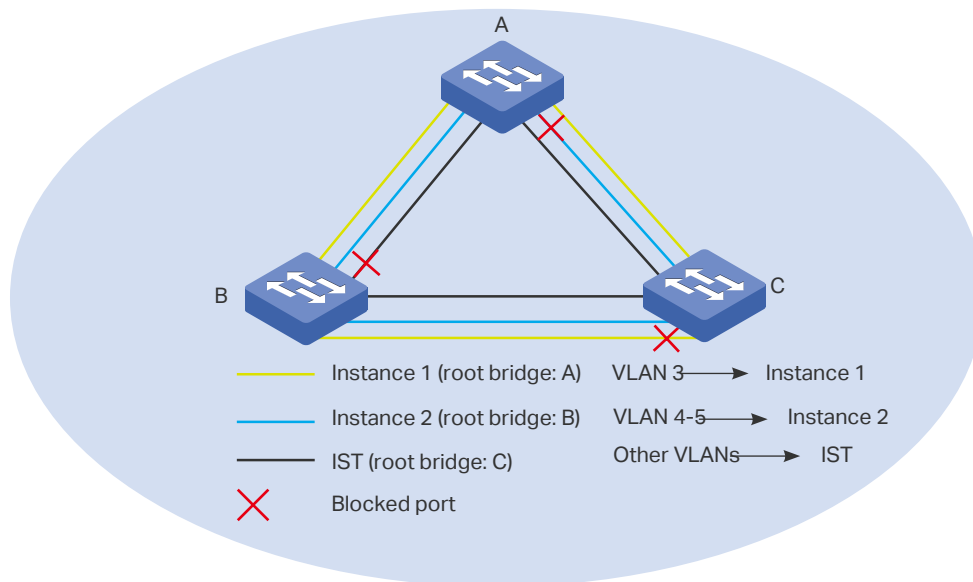

## VLAN-Instance Mapping

VLAN-Instance Mapping describes the mapping relationship between VLANs and instances. Multiple VLANs can be mapped to a same instance, but one VLAN can be mapped to only one instance. As Figure 1-4 shows, VLAN 3 is mapped to instance 1, VLAN 4 and VLAN 5 are mapped to instance 2, the other VLANs are mapped to the IST.

## IST

The Internal Spanning Tree (IST), which is a special MST instance with an instance ID 0. By default, all the VLANs are mapped to IST.

## CST

The Common Spanning Tree (CST), that is the spanning tree connecting all MST regions. As is shown in Figure 1-3, region1-region 4 are connected by the CST.

## CIST

The Common and Internal Spanning Tree (CIST), comprising IST and CST. CIST is the spanning tree that connects all the switches in the network.

## 1.3 STP Security

STP Security prevents the loops caused by wrong configurations or BPDU attacks. It contains Loop Protect, Root Protect, BPDU Protect, BPDU Filter and TC Protect functions.

#### » Loop Protect

Loop Protect function is used to prevent loops caused by link congestions or link failures. It is recommended to enable this function on root ports and alternate ports.

If the switch cannot receive BPDUs because of link congestions or link failures, the root port will become a designated port and the alternate port will transit to forwarding status, so loops will occur.

With Loop Protect function enabled, the port will temporarily transit to blocking state when the port does not receive BPDUs. After the link restores to normal, the port will transit to its normal state, so loops can be prevented.

#### » Root Protect

Root Protect function is used to ensure that the desired root bridge will not lose its position. It is recommended to enable this function on the designated ports of the root bridge.

Generally, the root bridge will lose its position once receiving higher-priority BPDUs caused by wrong configurations or malicious attacks. In this case, the spanning tree will be regenerated, and traffic needed to be forwarded along high-speed links may be lead to low-speed links.

With root protect function enabled, when the port receives higher-priority BPDUs, it will temporarily transit to blocking state. After two times of forward delay, if the port does not receive any higher-priority BPDUs, it will transit to its normal state.

#### » BPDU Protect

BPDU Protect function is used to prevent the port from receiving BPDUs. It is recommended to enable this function on edge ports.

Normally edge ports do not receive BPDUs, but if a user maliciously attacks the switch by sending BPDUs, the system automatically configures these ports as non-edge ports and regenerates the spanning tree.

With BPDU protect function enabled, the edge port will be shutdown when it receives BPDUs, and reports these cases to the administrator. Only the administrator can restore it.

#### » BPDU Filter

BPDU filter function is to prevent BPDU flooding in the network. It is recommended to enable this function on edge ports.

If a switch receives malicious BPDUs, it forwards these BPDUs to the other switches in the network, and the spanning tree will be continuously regenerated. In this case, the switch occupies too much CPU or the protocol status of BPDUs is wrong.

With BPDU filter enabled, the port does not forward BPDUs from the other switches.

#### » TC Protect

TC Protect function is used to prevent the switch from frequently removing MAC address entries. It is recommended to enable this function on the ports of non-root switches.

A switch removes MAC address entries upon receiving TC-BPDUs (the packets used to announce changes in the network topology). If a user maliciously sends a large number of TC-BPDUs to a switch in a short period, the switch will be busy with removing MAC address entries, which may decrease the performance and stability of the network.

With TC protect function enabled, if the number of the received TC-BPDUs exceeds the maximum number you set in the TC threshold, the switch will not remove MAC address entries in the TC protect cycle.



Follow these steps to configure STP/RSTP parameters on ports:

1) In the **Port Config** section, configure STP/RSTP parameters on ports.

|               |  |
|---------------|--|
| UNIT          | Select the desired unit or LAGs.   |
| Status        | Enable or disable spanning tree function on the desired port.  |
| Priority      | <p>Specify the Priority for the desired port. The value should be an integral multiple of 16, ranging from 0 to 240.</p> <p>The port with lower value has the higher priority. When the root path of the port is the same as other ports', the switch will compare the port priorities between these port and select a root port with the highest priority.</p>  |
| Ext-Path Cost | <p>Enter the value of the external path cost. The valid values are from 0 to 2000000. The default setting is Auto, which means the port calculates the external path cost automatically according to the port's link speed.</p> <p>For STP/RSTP, external path cost indicates the path cost of the port in spanning tree. The port with the lowest root path cost will be elected as the root port of the switch.</p> <p>For MSTP, external path cost indicates the path cost of the port in CST.</p>  |
| Int-Path Cost | <p>Enter the value of the internal path cost. The default setting is Auto, which means the port calculates the internal path cost automatically according to the port's link speed. This parameter is only used in MSTP and you need not to configure it if the spanning tree mode is STP/RSTP.</p> <p>For MSTP, internal path cost is used to calculate the path cost in IST. The port with the lowest root path cost will be elected as the root port of the switch in IST.</p>  |
| Edge Port     | <p>Select Enable to set the port as an edge port.</p> <p>When the topology is changed, the edge port can transit its state from blocking to forwarding directly. For the quick generation of the spanning tree, it is recommended to set the ports that are connected to the end devices as edge ports.</p>  |
| P2P Link      | <p>Select the status of the P2P (Point-to-Point) link to which the ports are connected. During the regeneration of the spanning tree, if the port of P2P link is elected as the root port or the designated port, it can transit its state to forwarding directly.</p> <p>Three options are supported: Auto, Open(Force) and Closed(Force). By default, it is Auto.</p> <p><b>Auto:</b> The switch automatically checks if the port is connected to a P2P link, then sets the status as Open or Closed.</p> <p><b>Open(Force):</b> A port is set as the one that is connected to a P2P link. You should check the link first.</p> <p><b>Close(Force):</b> A port is set as the one that is not connected to a P2P link. You should check the link first.</p> |

|             |  |
|-------------|--|
| MCheck      | <p>Select whether to perform MCheck operations on the port. If a port on an RSTP-enabled/MSTP-enabled device is connected to an STP-enabled device, the port will switch to STP compatible mode and send packets in STP format. MCheck is used to switch the mode of the port back to RSTP/MSTP after the port is disconnected from the STP-enabled device. The MCheck configuration can take effect only once, after that the MCheck status of the port will switch to Disabled.</p>  |
| Port Mode   | <p>Displays the spanning tree mode of the port.</p> <p><b>STP:</b> The spanning tree mode of the port is STP.</p> <p><b>RSTP:</b> The spanning tree mode of the port is RSTP.</p> <p><b>MSTP:</b> The spanning tree mode of the port is MSTP.</p>  |
| Port Role   | <p>Displays the role that the port plays in the spanning tree.</p> <p><b>Root Port:</b> Indicates that the port is the root port in the spanning tree. It has the lowest path cost from the root bridge to this switch and is used to communicate with the root bridge.</p> <p><b>Designated Port:</b> Indicates that the port is the designated port in the spanning tree. It has the lowest path cost from the root bridge to this physical network segment and is used to forward data for the corresponding network segment.</p> <p><b>Alternate Port:</b> Indicates that the port is the alternate port in the spanning tree. It is the backup of the root port or master port.</p> <p><b>Backup Port:</b> Indicates that the port is the backup port in the spanning tree. It is the backup of the designated port.</p> <p><b>Disabled:</b> Indicates that the port is not participating in the spanning tree.</p> |
| Port Status | <p>Displays the port status.</p> <p><b>Forwarding:</b> The port receives and sends BPDUs, and forwards user data.</p> <p><b>Learning:</b> The port receives and sends BPDUs. It also receives user traffic, but doesn't forward the traffic.</p> <p><b>Blocking:</b> The port only receives and sends BPDUs.</p> <p><b>Disconnected:</b> The port has the spanning tree function enabled but is not connected to any device.</p>   |
| LAG         | <p>Displays the LAG the port belongs to.</p>   |

2) Click **Apply**.

## 2.1.2 Configuring STP/RSTP Globally

Choose the menu **L2 FEATURES > Spanning Tree > STP Config > STP Config** to load the following page.

Figure 2-2 Configuring STP/RSTP Globally

**Global Config**

Spanning Tree:  Enable

Mode:

[Apply](#)

**Parameters Config**

CIST Priority:  (0-61440, in increments of 4096)

Hello Time:  seconds (1-10)

Max Age:  seconds (6-40)

Forward Delay:  seconds (4-30)

Tx Hold Count:  pps (1-20)

Max Hops:  hop (1-40)

[Apply](#)

Follow these steps to configure STP/RSTP globally:

- 1) In the **Parameters Config** section, configure the global parameters of STP/RSTP and click **Apply**.

|                      |   |
|----------------------|---|
| <b>CIST Priority</b> | <p>Specify the CIST priority for the switch. CIST priority is a parameter used to determine the root bridge for spanning tree. The switch with the lower value has the higher priority.</p> <p>In STP/RSTP, CIST priority is the priority of the switch in spanning tree. The switch with the highest priority will be elected as the root bridge.</p> <p>In MSTP, CISP priority is the priority of the switch in CIST. The switch with the higher priority will be elected as the root bridge in CIST.</p> |
| <b>Hello Time</b>    | Specify the interval between BPDUs' sending. The default value is 2. The root bridge sends configuration BPDUs at an interval of Hello Time. It works with the MAX Age to test the link failures and maintain the spanning tree.  |
| <b>Max Age</b>       | Specify the maximum time that the switch can wait without receiving a BPDU before attempting to regenerate a new spanning tree. The default value is 2.   |
| <b>Forward Delay</b> | Specify the interval between the port state transition from listening to learning. The default value is 15. It is used to prevent the network from causing temporary loops during the regeneration of spanning tree. The interval between the port state transition from learning to forwarding is also the Forward Delay.  |
| <b>Tx Hold Count</b> | Specify the maximum number of BPDU that can be sent in a second. The default value is 5.  |



**Max Hops**

Specify the maximum BPDU counts that can be forwarded in a MST region. The default value is 20. A switch receives BPDU, then decrements the hop count by one and generates BPDUs with the new value. When the hop reaches zero, the switch will discard the BPDU. This value can control the scale of the spanning tree in the MST region.

**Note:** Max Hops is a parameter configured in MSTP. You need not configure it if the spanning tree mode is STP/RSTP.

---

 **Note:**

To prevent frequent network flapping, make sure that Hello Time, Forward Delay, and Max Age conform to the following formulas:

- $2 * (\text{Hello Time} + 1) \leq \text{Max Age}$
- $2 * (\text{Forward Delay} - 1) \geq \text{Max Age}$

---

2) In the **Global Config** section, enable spanning tree function, choose the STP mode as STP/RSTP, and click **Apply**.

**Spanning Tree**

Check the box to enable the spanning tree function globally.

**Mode**

Select the desired spanning tree mode as STP/RSTP on the switch. By default, it's STP.

**STP:** Specify the spanning tree mode as STP.

**RSTP:** Specify the spanning tree mode as RSTP.

**MSTP:** Specify the spanning tree mode as MSTP.

---

### 2.1.3 Verifying the STP/RSTP Configurations

Verify the STP/RSTP information of your switch after all the configurations are finished.

Choose the menu **L2 FEATURES > Spanning Tree > STP Config > STP Summary** to load the following page.

Figure 2-3 Verifying the STP/RSTP Configurations

**STP Summary**

---

Spanning Tree: Enable

Spanning Tree Mode: STP

Local Bridge: 32768---00-0a-eb-13-a2-02

Root Bridge: 32768---00-0a-eb-13-a2-02

External Path Cost: 0

Regional Root Bridge: ---

Internal Path Cost: ---

Designated Bridge: 32768---00-0a-eb-13-a2-02

Root Port: ---

Latest TC Time: 2006-01-01 08:00:45

TC Count: 0

**MSTP Instance Summary**

---

Instance ID:

Instance Status: Disable

Local Bridge: ---

Regional Root Bridge: ---

Internal Path Cost: ---

Designated Bridge: ---

Root Port: ---

Latest TC Time: ---

TC Count: ---

[Refresh](#)

The **STP Summary** section shows the summary information of spanning tree :

|                             |   |
|-----------------------------|---|
| <b>Spanning Tree</b>        | Displays the status of the spanning tree function.  |
| <b>Spanning Tree Mode</b>   | Displays the spanning tree mode.  |
| <b>Local Bridge</b>         | Displays the bridge ID of the local bridge. The local bridge is the current switch.   |
| <b>Root Bridge</b>          | Displays the bridge ID of the root bridge.  |
| <b>External Path Cost</b>   | Displays the root path cost from the switch to the root bridge.   |
| <b>Regional Root Bridge</b> | It is the root bridge of IST. It is not displayed when you choose the spanning tree mode as STP/RSTP.   |
| <b>Internal Path Cost</b>   | The internal path cost is the root path cost from the switch to the root bridge of IST. It is not displayed when you choose the spanning tree mode as STP/RSTP. |

---

|                   |   |
|-------------------|---|
| Designated Bridge | Displays the bridge ID of the designated bridge. The designated bridge is the switch that has designated ports. |
| Root Port         | Displays the root port of the current switch.   |
| Latest TC Time    | Displays the latest time when the topology is changed.  |
| TC Count          | Displays how many times the topology has changed.   |

---

## 2.2 Using the CLI

### 2.2.1 Configuring STP/RSTP Parameters on Ports

Follow these steps to configure STP/RSTP parameters on ports:

---

|        |  |
|--------|--|
| Step 1 | <b>configure</b><br>Enter global configuration mode.   |
| Step 2 | <b>interface {fastEthernet port   range fastEthernet port-list   gigabitEthernet port   range gigabitEthernet port-list   ten-gigabitEthernet port   range ten-gigabitEthernet port-list   port-channel port-channel-id   range port-channel port-channel-list}</b><br>Enter interface configuration mode. |
| Step 3 | <b>spanning-tree</b><br>Enable spanning tree function for desired ports.   |

---

- 
- Step 4 **spanning-tree common-config [ port-priority *pri* ] [ ext-cost *ext-cost* ] [ portfast { enable | disable } ] [ point-to-point { auto | open | close } ]**
- Configure STP/RSTP parameters on the desired port .
- pri*: Specify the Priority for the desired port. The value should be an integral multiple of 16, ranging from 0 to 240. The default value is 128. Ports with lower values have higher priority. When the root path of the port is the same as other ports', the switch will compare the port priorities and select a root port with the highest priority.
- ext-cost*: Specify the value of the external path cost. The valid values are from 0 to 2000000 and the default setting is Auto, which means the port calculates the external path cost automatically according to the port's link speed.
- For STP/RSTP, external path cost indicates the path cost of the port in spanning tree. The Port with the lowest root path cost will be elected as the root port of the switch.
- For MSTP, external path cost indicates the path cost of the port in CST.
- portfast { enable | disable }**: Enable to set the port as an edge port. By default, it is disabled. When the topology is changed, the edge port can transit its state from blocking to forwarding directly. For the quick generation of the spanning tree, it is recommended to set the ports that are connected to the end devices as edge ports.
- point-to-point { auto | open | close }**: Select the status of the P2P (Point-to-Point) link to which the ports are connected. During the regeneration of the spanning tree, if the port of P2P link is elected as the root port or the designated port, it can transit its state to forwarding directly. Auto indicates that the switch automatically checks if the port is connected to a P2P link, then sets the status as Open or Closed. Open is used to set the port as the one that is connected to a P2P link. Close is used to set the port as the one that is not connected to a P2P link.
- 
- Step 5 **spanning-tree mcheck**
- (Optional) Perform MCheck operations on the port.
- If a port on an RSTP-enabled/MSTP-enabled device is connected to an STP-enabled device, the port will switch to STP compatible mode and send packets in STP format. MCheck is used to switch the mode of the port back to RSTP/MSTP after the port is disconnected from the STP-enabled device. The MCheck configuration can take effect only once, after that the MCheck status of the port will switch to Disabled.
- 
- Step 6 **show spanning-tree interface [ fastEthernet *port* | gigabitEthernet *port* | ten-gigabitEthernet *port* | port-channel *lagid* ] [ edge | ext-cost | int-cost | mode | p2p | priority | role | state | status ]**
- (Optional) View the information of all ports or a specified port.
- port*: Specify the port number.
- lagid*: Specify the ID of the LAG.
- ext-cost | int-cost | mode | p2p | priority | role | state | status*: Display the specified information.
- 
- Step 7 **end**
- Return to privileged EXEC mode.
- 
- Step 8 **copy running-config startup-config**
- Save the settings in the configuration file.
-

The following example shows how to enable spanning tree function on port 1/0/3 and configure the port priority as 32 :

```
Switch#configure
```

```
Switch(config)#interface gigabitEthernet 1/0/3
```

```
Switch(config-if)#spanning-tree
```

```
Switch(config-if)#spanning-tree common-config port-priority 32
```

```
Switch(config-if)#show spanning-tree interface gigabitEthernet 1/0/3
```

| Interface | State  | Prio  | Ext-Cost | Int-Cost | Edge | P2p      | Mode  |
|-----------|--------|-------|----------|----------|------|----------|-------|
| -----     | -----  | ----  | -----    | -----    | ---- | -----    | ----- |
| Gi1/0/3   | Enable | 32    | Auto     | Auto     | No   | No(auto) | N/A   |
| Role      | Status | LAG   |          |          |      |          |       |
| -----     | -----  | ----- |          |          |      |          |       |
| N/A       | LnkDwn | N/A   |          |          |      |          |       |

```
Switch(config-if)#end
```

```
Switch#copy running-config startup-config
```

## 2.2.2 Configuring Global STP/RSTP Parameters

Follow these steps to configure global STP/RSTP parameters of the switch:

Step 1     **configure**

Enter global configuration mode.

Step 2     **spanning-tree priority pri**

Configure the priority of the switch.

*pri*: Specify the priority for the switch. The valid value is from 0 to 61440, which are divisible by 4096. The priority is a parameter used to determine the root bridge for spanning tree. The switch with the lower value has the higher priority.

In STP/RSTP, the value is the priority of the switch in spanning tree. The switch with the highest priority will be elected as the root bridge.

In MSTP, the value is the priority of the switch in CIST. The switch with the higher priority will be elected as the root bridge in CIST.

---

Step 3 **spanning-tree timer** [[ **forward-time** *forward-time*] [**hello-time** *hello-time*] [**max-age** *max-age*]]

(Optional) Configure the Forward Delay, Hello Time and Max Age.

*forward-time*: Specify the value of Forward Delay. It is the interval between the port state transition from listening to learning. The valid values are from 4 to 30 in seconds, and the default value is 15. Forward Delay is used to prevent the network from causing temporary loops during the regeneration of spanning tree. The interval between the port state transition from learning to forwarding is also the Forward Delay.

*hello-time*: Specify the value of Hello Time. It is the interval between BPDUs' sending. The valid values are from 1 to 10 in seconds, and the default value is 2. The root bridge sends configuration BPDUs at an interval of Hello Time. It works with the MAX Age to test the link failures and maintain the spanning tree.

*max-age*: Specify the value of Max Age. It is the maximum time that the switch can wait without receiving a BPDU before attempting to regenerate a new spanning tree. The valid values are from 6 to 40 in seconds, and the default value is 20.

---

Step 4 **spanning-tree hold-count** *value*

Specify the maximum number of BPDU that can be sent in a second.

*value*: Specify the maximum number of BPDU packets that can be sent in a second. The valid values are from 1 to 20 pps, and the default value is 5.

---

Step 5 **show spanning-tree bridge**

(Optional) View the global STP/RSTP parameters of the switch.

---

Step 6 **end**

Return to privileged EXEC mode.

---

Step 7 **copy running-config startup-config**

Save the settings in the configuration file.

---

 **Note:**

To prevent frequent network flapping, make sure that Hello Time, Forward Delay, and Max Age conform to the following formulas:

- $2 * (\text{Hello Time} + 1) \leq \text{Max Age}$
- $2 * (\text{Forward Delay} - 1) \geq \text{Max Age}$

---

This example shows how to configure the priority of the switch as 36864, the Forward Delay as 12 seconds:

```
Switch#configure
```

```
Switch(config)#spanning-tree priority 36864
```

```
Switch(config)#spanning-tree timer forward-time 12
```

```
Switch(config)#show spanning-tree bridge
```

| State  | Mode  | Priority | Hello-Time | Fwd-Time | Max-Age | Hold-Count | Max-Hops |
|--------|-------|----------|------------|----------|---------|------------|----------|
| -----  | ----- | -----    | -----      | -----    | -----   | -----      | -----    |
| Enable | Rstp  | 36864    | 2          | 12       | 20      | 5          | 20       |

```
Switch(config)#end
```

```
Switch#copy running-config startup-config
```

## 2.2.3 Enabling STP/RSTP Globally

Follow these steps to configure the spanning tree mode as STP/RSTP, and enable spanning tree function globally:

- 
- |        |   |
|--------|---|
| Step 1 | <p><b>configure</b></p> <p>Enter global configuration mode.</p> |
|--------|---|
- 
- |        |  |
|--------|--|
| Step 2 | <p><b>spanning-tree mode { stp   rstp }</b></p> <p>Configure the spanning tree mode as STP/RSTP.</p> <p><b>stp:</b> Specify the spanning tree mode as STP .</p> <p><b>rstp:</b> Specify the spanning tree mode as RSTP .</p> |
|--------|--|
- 
- |        |  |
|--------|--|
| Step 3 | <p><b>spanning-tree</b></p> <p>Enable spanning tree function globally.</p> |
|--------|--|
- 
- |        |  |
|--------|--|
| Step 4 | <p><b>show spanning-tree active</b></p> <p>(Optional) View the active information of STP/RSTP.</p> |
|--------|--|
- 
- |        |  |
|--------|--|
| Step 5 | <p><b>end</b></p> <p>Return to privileged EXEC mode.</p> |
|--------|--|
- 
- |        |  |
|--------|--|
| Step 6 | <p><b>copy running-config startup-config</b></p> <p>Save the settings in the configuration file.</p> |
|--------|--|
- 

This example shows how to enable spanning tree function, configure the spanning tree mode as RSTP and verify the configurations:

```
Switch#configure
```

```
Switch(config)#spanning-tree mode rstp
```

```
Switch(config)#spanning-tree
```

**Switch(config)#show spanning-tree active**

Spanning tree is enabled

Spanning-tree's mode: RSTP (802.1w Rapid Spanning Tree Protocol)

Latest topology change time: 2006-01-02 10:04:02

Root Bridge

Priority : 32768

Address : 00-0a-eb-13-12-ba

Local bridge is the root bridge

Designated Bridge

Priority : 32768

Address : 00-0a-eb-13-12-ba

Local Bridge

Priority : 32768

Address : 00-0a-eb-13-12-ba

| Interface | State  | Prio | Ext-Cost | Int-Cost | Edge | P2p       | Mode  |
|-----------|--------|------|----------|----------|------|-----------|-------|
| -----     | -----  | ---- | -----    | -----    | ---- | -----     | ----- |
| Gi1/0/16  | Enable | 128  | 200000   | 200000   | No   | Yes(auto) | Rstp  |
| Gi1/0/18  | Enable | 128  | 200000   | 200000   | No   | Yes(auto) | Rstp  |
| Gi1/0/20  | Enable | 128  | 200000   | 200000   | No   | Yes(auto) | Rstp  |

Role Status LAG

-----

Desg Fwd N/A

Desg Fwd N/A

Desg Fwd N/A

**Switch(config)#end**

**Switch#copy running-config startup-config**





Follow these steps to configure parameters on ports in CIST:

- 1) In the **Port Config** section, configure the parameters on ports.

|                      |   |
|----------------------|---|
| <b>UNIT</b>          | Select the desired unit or LAGs.  |
| <b>Status</b>        | Enable or disable spanning tree function on the desired port.   |
| <b>Priority</b>      | <p>Specify the Priority for the desired port. The value should be an integral multiple of 16, ranging from 0 to 240.</p> <p>The port with lower value has the higher priority. When the root path of the port is the same as other ports', the switch will compare the port priorities between these port and select a root port with the highest priority.</p>   |
| <b>Ext-Path Cost</b> | <p>Enter the value of the external path cost. The default setting is Auto, which means the port calculates the external path cost automatically according to the port's link speed.</p> <p>For STP/RSTP, external path cost indicates the path cost of the port in spanning tree. The port with the lowest root path cost will be elected as the root port of the switch.</p> <p>For MSTP, external path cost indicates the path cost of the port in CST.</p>   |
| <b>Int-Path Cost</b> | <p>Enter the value of the internal path cost. The valid values are from 0 to 2000000. The default setting is Auto, which means the port calculates the internal path cost automatically according to the port's link speed. This parameter is only used in MSTP and you need not to configure it if the spanning tree mode is STP/RSTP.</p> <p>For MSTP, internal path cost is used to calculate the path cost in IST. The port with the lowest root path cost will be elected as the root port of the switch in IST.</p> |
| <b>Edge Port</b>     | <p>Select Enable to set the port as an edge port.</p> <p>When the topology is changed, the edge port can transit its state from blocking to forwarding directly. For the quick generation of the spanning tree, it is recommended to set the ports that are connected to the end devices as edge ports.</p>   |

---

|           |   |
|-----------|---|
| P2P Link  | <p>Select the status of the P2P (Point-to-Point) link to which the ports are connected. During the regeneration of the spanning tree, if the port of P2P link is elected as the root port or the designated port, it can transit its state to forwarding directly.</p> <p>Three options are supported: Auto, Open(Force) and Closed(Force). By default, it is Auto.</p> <p><b>Auto:</b> The switch automatically checks if the port is connected to a P2P link, then sets the status as Open or Closed.</p> <p><b>Open(Force):</b> A port is set as the one that is connected to a P2P link. You should check the link first.</p> <p><b>Close(Force):</b> A port is set as the one that is not connected to a P2P link. You should check the link first.</p>  |
| MCheck    | <p>Select whether to perform MCheck operations on the port. If a port on an RSTP-enabled/MSTP-enabled device is connected to an STP-enabled device, the port will switch to STP compatible mode and send packets in STP format. MCheck is used to switch the mode of the port back to RSTP/MSTP after the port is disconnected from the STP-enabled device. The MCheck configuration can take effect only once, after that the MCheck status of the port will switch to Disabled.</p>   |
| Port Mode | <p>Displays the spanning tree mode of the port.</p> <p><b>STP:</b> The spanning tree mode of the port is STP.</p> <p><b>RSTP:</b> The spanning tree mode of the port is RSTP.</p> <p><b>MSTP:</b> The spanning tree mode of the port is MSTP.</p>   |
| Port Role | <p>Displays the role that the port plays in the spanning tree.</p> <p><b>Root Port:</b> Indicates that the port is the root port in the spanning tree. It has the lowest path cost from the root bridge to this switch and is used to communicate with the root bridge.</p> <p><b>Designated Port:</b> Indicates that the port is the designated port in the spanning tree. It has the lowest path cost from the root bridge to this physical network segment and is used to forward data for the corresponding network segment.</p> <p><b>Master Port:</b> Indicates the port provides the lowest root path cost from the region to the root bridge in CIST. In CIST, each region is regarded as a switch, and the master port is the root port of the corresponding region.</p> <p><b>Alternate Port:</b> Indicates that the port is the alternate port in the spanning tree. It is the backup of the root port or master port.</p> <p><b>Backup Port:</b> Indicates that the port is the backup port in the spanning tree. It is the backup of the designated port.</p> <p><b>Disabled:</b> Indicates that the port is not participating in the spanning tree.</p> |

---

|                    |  |
|--------------------|--|
| <b>Port Status</b> | <p>Displays the port status.</p> <p><b>Forwarding:</b> The port receives and sends BPDUs, and forwards user data.</p> <p><b>Learning:</b> The port receives and sends BPDUs. It also receives user traffic, but doesn't forward the traffic.</p> <p><b>Blocking:</b> The port only receives and sends BPDUs.</p> <p><b>Disconnected:</b> The port has the spanning tree function enabled but is not connected to any device.</p> |
| <b>LAG</b>         | Displays the LAG the port belongs to.  |

2) Click **Apply**.

### 3.1.2 Configuring the MSTP Region

Configure the region name, revision level, VLAN-Instance mapping of the switch. The switches with the same region name, the same revision level and the same VLAN-Instance mapping are considered as in the same region.

Besides, configure the priority of the switch, the priority and path cost of ports in the desired instance.

#### ■ Configuring the Region Name and Revision Level

Choose the menu **L2 FEATURES > Spanning Tree > MSTP Instance > Region Config** to load the following page.

Figure 3-2 Configuring the Region

The screenshot shows a web interface titled "Region Config". It contains two input fields: "Region Name" with the value "00-0a-eb-13-a2-02" and "Revision" with the value "0". A small text "(0-65535)" is visible next to the Revision field. An "Apply" button is located in the bottom right corner.

Follow these steps to create an MST region:

1) In the **Region Config** section, set the name and revision level to specify an MSTP region.

|                    |  |
|--------------------|--|
| <b>Region Name</b> | Configure the name for an MST region using up to 32 characters. By default, it is the MAC address of the switch. |
| <b>Revision</b>    | Enter the revision level. By default, it is 0.   |

2) Click **Apply**.

■ **Configuring the VLAN-Instance Mapping and Switch Priority**

Choose the menu **L2 FEATURES > Spanning Tree > MSTP Instance > Instance Config** to load the following page.

Figure 3-3 Configuring the VLAN-Instance Mapping

| Instance Config          |             |          |         |           |          |
|--------------------------|-------------|----------|---------|-----------|----------|
|                          |             |          |         | + Add     | - Delete |
| <input type="checkbox"/> | Instance ID | Priority | VLAN ID | Operation |          |
| <input type="checkbox"/> | CIST        | 36864    | 1-4094, |           |          |
| Total: 1                 |             |          |         |           |          |

Follow these steps to map VLANs to the corresponding instance, and configure the priority of the switch in the desired instance:

- 1) In the **Instance Config** section, click **Add** and enter the instance ID, Priority and corresponding VLAN ID.

Figure 3-4 Configuring the Instance

**Instance Config**

Instance ID:  (1-8)

Priority:  (0-61440, in increments of 4096)

VLAN ID:  Add  Delete

(1-4094, format:1,3,4-7,11-30)

|                    |  |
|--------------------|--|
| <b>Instance ID</b> | Enter the corresponding instance ID.   |
| <b>Priority</b>    | Specify the priority for the switch in the corresponding instance. The value should be an integral multiple of 4096, ranging from 0 to 61440. It is used to determine the root bridge for the instance. Switches with a lower value have higher priority, and the switch with the highest priority will be elected as the root bridge in the corresponding instance. |
| <b>VLAN ID</b>     | Enter the VLAN ID to map the VLAN to the desired instance or unbind the VLAN-instance mapping.   |

- 2) Click **Create**.

■ **Configuring Parameters on Ports in the Instance**

Choose the menu **L2 FEATURES > Spanning Tree > MSTP Instance > Instance Port Config** to load the following page.

Figure 3-5 Configuring Port Parameters in the Instance

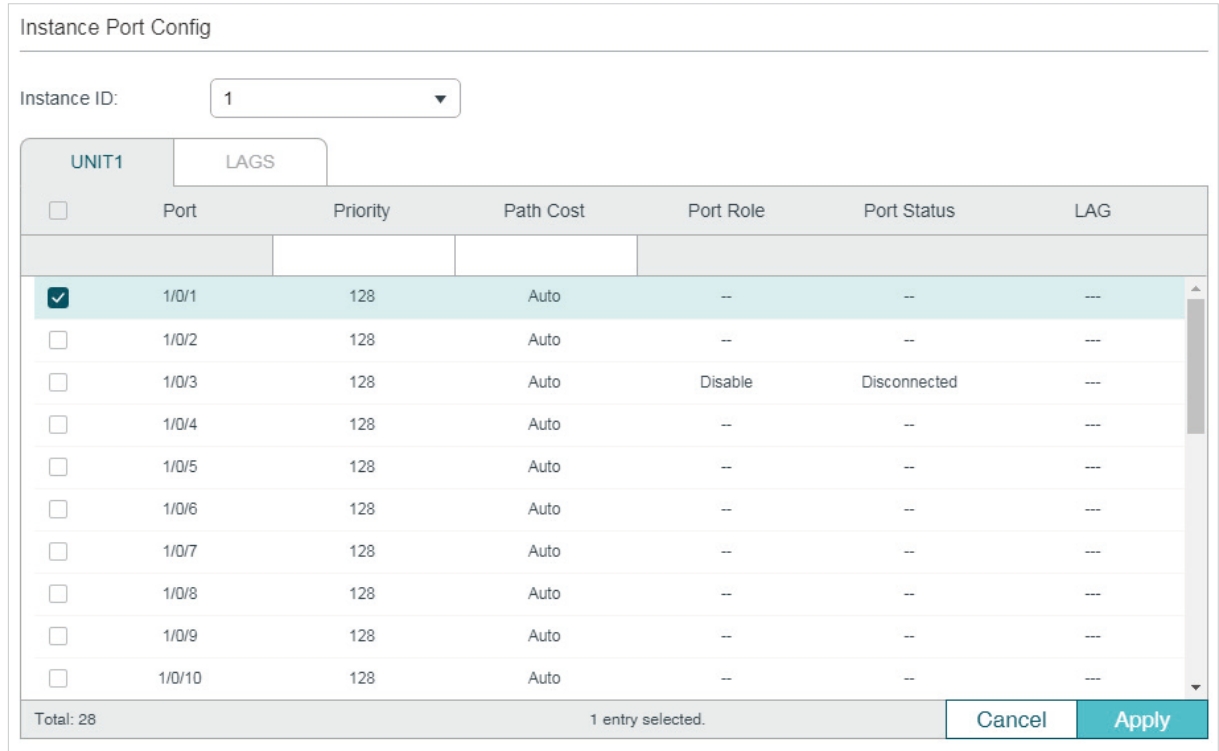

Follow these steps to configure port parameters in the instance:

- 1) In the **Instance Port Config** section, select the desired instance ID.

---

**Instance ID**                      Select the ID number of the instance that you want to configure.

---

- 2) Configure port parameters in the desired instance.

---

**UNIT**                                Select the desired unit or LAGs for configuration.

---



---

**Priority**                              Specify the Priority for the port in the corresponding instance. The value should be an integral multiple of 16, ranging from 0 to 240.

The port with lower value has the higher priority. When the root path of the port is the same as other ports', the switch will compare the port priorities between these ports and select a root port with the highest priority.

---



---

**Path Cost**                            Enter the value of the path cost in the corresponding instance. The valid values are from 0 to 2000000. The default setting is Auto, which means the port calculates the external path cost automatically according to the port's link speed. The port with the lowest root path cost will be elected as the root port of the switch.

---

---

|             |  |
|-------------|--|
| Port Role   | <p>Displays the role that the port plays in the desired instance.</p> <p><b>Root Port:</b> Indicates that the port is the root port in the desired instance. It has the lowest path cost from the root bridge to this switch and is used to communicate with the root bridge.</p> <p><b>Designated Port:</b> Indicates that the port is the designated port in the desired instance. It has the lowest path cost from the root bridge to this physical network segment and is used to forward data for the corresponding network segment.</p> <p><b>Alternate Port:</b> Indicates that the port is the alternate port in the desired instance. It is the backup of the root port or master port.</p> <p><b>Backup Port:</b> Indicates that the port is the backup port in the desired instance. It is the backup of the designated port.</p> <p><b>Master Port:</b> Indicates the port provides the lowest root path cost from the region to the root bridge in CIST. In CIST, each region is regarded as a switch, and the master port is the root port of the corresponding region.</p> <p><b>Disabled:</b> Indicates that the port is not participating in the spanning tree.</p> |
| Port Status | <p>Displays the port status.</p> <p><b>Forwarding:</b> The port receives and sends BPDUs, and forwards user traffic.</p> <p><b>Learning:</b> The port receives and sends BPDUs. It also receives user traffic, but doesn't forward the traffic.</p> <p><b>Blocking:</b> The port only receives and sends BPDUs.</p> <p><b>Disconnected:</b> The port has the spanning tree function enabled but is not connected to any device.</p>  |
| LAG         | <p>Displays the LAG which the port belongs to.</p>   |

---

### 3.1.3 Configuring MSTP Globally

Choose the menu **L2 FEATURES > Spanning Tree > STP Config > STP Config** to load the following page.

Figure 3-6 Configure MSTP Function Globally

**Global Config**

---

Spanning Tree:  Enable

Mode: MSTP

Apply

---

**Parameters Config**

CIST Priority: 36864 (0-61440, in increments of 4096)

Hello Time: 2 seconds (1-10)

Max Age: 20 seconds (6-40)

Forward Delay: 12 seconds (4-30)

Tx Hold Count: 5 pps (1-20)

Max Hops: 20 hop (1-40)

Apply

Follow these steps to configure MSTP globally:

- 1) In the **Parameters Config** section, Configure the global parameters of MSTP and click **Apply**.

|                      |   |
|----------------------|---|
| <b>CIST Priority</b> | <p>Specify the CIST priority for the switch. CIST priority is a parameter used to determine the root bridge for spanning tree. The switch with the lower value has the higher priority.</p> <p>In STP/RSTP, CIST priority is the priority of the switch in spanning tree. The switch with the highest priority will be elected as the root bridge.</p> <p>In MSTP, CISP priority is the priority of the switch in CIST. The switch with the higher priority will be elected as the root bridge in CIST.</p> |
| <b>Hello Time</b>    | <p>Specify the interval between BPDUs' sending. The default value is 2. The root bridge sends configuration BPDUs at an interval of Hello Time. It works with the MAX Age to test the link failures and maintain the spanning tree.</p>   |
| <b>Max Age</b>       | <p>Specify the maximum time that the switch can wait without receiving a BPDU before attempting to regenerate a new spanning tree. The default value is 20.</p>   |



|                      |  |
|----------------------|--|
| <b>Forward Delay</b> | Specify the interval between the port state transition from listening to learning. The default value is 15. It is used to prevent the network from causing temporary loops during the regeneration of spanning tree. The interval between the port state transition from learning to forwarding is also the Forward Delay.   |
| <b>Tx Hold Count</b> | Specify the maximum number of BPDU that can be sent in a second. The default value is 5.   |
| <b>Max Hops</b>      | Specify the maximum BPDU hop counts that can be forwarded in a MST region. The default value is 20. A switch receives BPDU, then decrements the hop count by one and generates BPDUs with the new value. When the hop reaches zero, the switch will discard the BPDU. This value can control the scale of the spanning tree in the MST region.<br><br>Note: Max Hops is a parameter configured in MSTP. You need not configure it if the spanning tree mode is STP/RSTP. |

 **Note:**

To prevent frequent network flapping, make sure that Hello Time, Forward Delay, and Max Age conform to the following formulas:

- $2 * (\text{Hello Time} + 1) \leq \text{Max Age}$
- $2 * (\text{Forward Delay} - 1) \geq \text{Max Age}$

2) In the **Global Config** section, enable Spanning-Tree function and choose the STP mode as MSTP and click **Apply**.

|                      |  |
|----------------------|--|
| <b>Spanning-Tree</b> | Check the box to enable the spanning tree function globally.   |
| <b>Mode</b>          | Select the desired spanning tree mode as STP/RSTP on the switch. By default, it's STP.<br><br><b>STP:</b> Specify the spanning tree mode as STP.<br><br><b>RSTP:</b> Specify the spanning tree mode as RSTP.<br><br><b>MSTP:</b> Specify the spanning tree mode as MSTP. |

### 3.1.4 Verifying the MSTP Configurations

Choose the menu **Spanning Tree > STP Config > STP Summary** to load the following page.

Figure 3-7 Verifying the MSTP Configurations

**STP Summary**

---

|                       |                           |
|-----------------------|---------------------------|
| Spanning Tree:        | Enable                    |
| Spanning Tree Mode:   | MSTP                      |
| Local Bridge:         | 36864---00-0a-eb-13-a2-02 |
| Root Bridge:          | 36864---00-0a-eb-13-a2-02 |
| External Path Cost:   | 0                         |
| Regional Root Bridge: | 36864---00-0a-eb-13-a2-02 |
| Internal Path Cost:   | 0                         |
| Designated Bridge:    | 36864---00-0a-eb-13-a2-02 |
| Root Port:            | ---                       |
| Latest TC Time:       | 2006-01-01 08:00:45       |
| TC Count:             | 0                         |

**MSTP Instance Summary**

---

|                       |                               |
|-----------------------|-------------------------------|
| Instance ID:          | <input type="text" value=""/> |
| Instance Status:      | Disable                       |
| Local Bridge:         | ---                           |
| Regional Root Bridge: | ---                           |
| Internal Path Cost:   | ---                           |
| Designated Bridge:    | ---                           |
| Root Port:            | ---                           |
| Latest TC Time:       | ---                           |
| TC Count:             | ---                           |

Refresh

The **STP Summary** section shows the summary information of CIST:

|                           |   |
|---------------------------|---|
| <b>Spanning Tree</b>      | Displays the status of the spanning tree function.  |
| <b>Spanning-Tree Mode</b> | Displays the spanning tree mode.  |
| <b>Local Bridge</b>       | Displays the bridge ID of the local switch. The local bridge is the current switch.                   |
| <b>Root Bridge</b>        | Displays the bridge ID of the root bridge in CIST.  |
| <b>External Path Cost</b> | Displays the external path cost. It is the root path cost from the switch to the root bridge in CIST. |

|                      |  |
|----------------------|--|
| Regional Root Bridge | Displays the bridge ID of the root bridge in IST.  |
| Internal Path Cost   | Displays the internal path cost. It is the root path cost from the current switch to the root bridge in IST. |
| Designated Bridge    | Displays the bridge ID of the designated bridge in CIST.   |
| Root Port            | Displays the root port of in CIST.   |
| Latest TC Time       | Displays the latest time when the topology is changed.   |
| TC Count             | Displays how many times the topology has changed.  |

The **MSTP Instance Summary** section shows the information in MST instances:

|                      |  |
|----------------------|--|
| Instance ID          | Select the desired instance.   |
| Instance Status      | Displays the status of the desired instance.   |
| Local Bridge         | Displays the bridge ID of the local switch. The local bridge is the current switch.                            |
| Regional Root Bridge | Displays the bridge ID of the root bridge in the desired instance.   |
| Internal Path Cost   | Displays the internal path cost. It is the root path cost from the current switch to the regional root bridge. |
| Designated Bridge    | Displays the bridge ID of the designated bridge in the desired instance.                                       |
| Root Port            | Displays the root port of the desired instance.  |
| Latest TC Time       | Displays the latest time when the topology is changed.   |
| TC Count             | Displays how many times the topology has changed.  |

## 3.2 Using the CLI

### 3.2.1 Configuring Parameters on Ports in CIST

Follow these steps to configure the parameters of the port in CIST:

|        |  |
|--------|--|
| Step 1 | <b>configure</b><br>Enter global configuration mode.   |
| Step 2 | <b>interface {fastEthernet port   range fastEthernet port-list   gigabitEthernet port   range gigabitEthernet port-list   ten-gigabitEthernet port   range ten-gigabitEthernet port-list   port-channel port-channel-id   range port-channel port-channel-list}</b><br>Enter interface configuration mode. |

---

**Step 3** **spanning-tree**

Enable spanning tree function for the desired port.

---

**Step 4** **spanning-tree common-config [ port-priority pri ] [ ext-cost ext-cost ] [ int-cost int-cost ] [ portfast { enable | disable } ] [ point-to-point { auto | open | close } ]**

Configure the parameters on ports in CIST.

**pri**: Specify the Priority for the desired port. The value should be an integral multiple of 16, ranging from 0 to 240. The default value is 128. Ports with lower values have higher priority. When the root path of the port is the same as other ports', the switch will compare the port priorities and select a root port with the highest priority.

**ext-cost**: Specify the value of the external path cost. The valid values are from 0 to 2000000 and the default setting is Auto, which means the port calculates the external path cost automatically according to the port's link speed.

For STP/RSTP, external path cost indicates the path cost of the port in spanning tree. The Port with the lowest root path cost will be elected as the root port of the switch.

For MSTP, external path cost indicates the path cost of the port in CST.

**int-cost**: Specify the value of the internal path cost. The valid values are from 0 to 2000000. The default setting is Auto, which means the port calculates the internal path cost automatically according to the port's link speed. This parameter is only used in MSTP.

For MSTP, internal path cost is used to calculate the path cost in IST. The port with the lowest root path cost will be elected as the root port of the switch in IST.

**portfast { enable | disable }**: Enable to set the port as an edge port. By default, it is disabled. When the topology is changed, the edge port can transit its state from blocking to forwarding directly. For the quick generation of the spanning tree, it is recommended to set the ports that are connected to the end devices as edge ports.

**point-to-point { auto | open | close }**: Select the status of the P2P (Point-to-Point) link to which the ports are connected. During the regeneration of the spanning tree, if the port of P2P link is elected as the root port or the designated port, it can transit its state to forwarding directly. Auto indicates that the switch automatically checks if the port is connected to a P2P link, then sets the status as Open or Closed. Open is used to set the port as the one that is connected to a P2P link. Close is used to set the port as the one that is not connected to a P2P link.

---

**Step 5** **spanning-tree mcheck**

(Optional) Perform MCheck operations on the port.

If a port on an RSTP-enabled/MSTP-enabled device is connected to an STP-enabled device, the port will switch to STP compatible mode and send packets in STP format. MCheck is used to switch the mode of the port back to RSTP/MSTP after the port is disconnected from the STP-enabled device. The MCheck configuration can take effect only once, after that the MCheck status of the port will switch to Disabled.

---

- 
- Step 6 **show spanning-tree interface [ fastEthernet port | gigabitEthernet port | ten-gigabitEthernet port | port-channel lagid ] [ edge | ext-cost | int-cost | mode | p2p | priority | role | state | status ]**  
 (Optional) View the information of all ports or a specified port.  
*port*: Specify the port number.  
*lagid*: Specify the ID of the LAG.  
*ext-cost | int-cost | mode | p2p | priority | role | state | status*: Display the specified information.
- 
- Step 7 **end**  
 Return to privileged EXEC mode.
- 
- Step 8 **copy running-config startup-config**  
 Save the settings in the configuration file.
- 

This example shows how to enable spanning tree function for port 1/0/3 and configure the port priority as 32 :

**Switch#configure**

**Switch(config)#interface gigabitEthernet 1/0/3**

**Switch(config-if)#spanning-tree**

**Switch(config-if)#spanning-tree common-config port-priority 32**

**Switch(config-if)#show spanning-tree interface gigabitEthernet 1/0/3**

MST-Instance 0 (CIST)

| Interface | State  | Prio | Ext-Cost | Int-Cost | Edge | P2p      | Mode  | Role  | Status |
|-----------|--------|------|----------|----------|------|----------|-------|-------|--------|
| -----     | -----  | ---- | -----    | -----    | ---- | -----    | ----- | ----- | -----  |
| Gi1/0/3   | Enable | 32   | Auto     | Auto     | No   | No(auto) | N/A   | N/A   | LnkDwn |

MST-Instance 5

| Interface | Prio  | Cost  | Role  | Status |
|-----------|-------|-------|-------|--------|
| -----     | ----- | ----- | ----- | -----  |
| Gi1/0/3   | 144   | 200   | N/A   | LnkDwn |

**Switch(config-if)#end**

**Switch#copy running-config startup-config**

## 3.2.2 Configuring the MSTP Region

### ■ Configuring the MST Region

Follow these steps to configure the MST region and the priority of the switch in the instance:

|        |  |
|--------|--|
| Step 1 | <p><b>configure</b></p> <p>Enter global configuration mode.</p>  |
| Step 2 | <p><b>spanning-tree mst instance</b> <i>instance-id</i> <b>priority</b> <i>pri</i></p> <p>Configure the priority of the switch in the instance.</p> <p><i>instance-id</i>: Specify the instance ID, the valid values ranges from 1 to 8.</p> <p><i>pri</i>: Specify the priority for the switch in the corresponding instance. The value should be an integral multiple of 4096, ranging from 0 to 61440. The default value is 32768. It is used to determine the root bridge for the instance. Switches with a lower value have higher priority, and the switch with the highest priority will be elected as the root bridge in the corresponding instance.</p> |
| Step 3 | <p><b>spanning-tree mst configuration</b></p> <p>Enter MST configuration mode, as to configure the VLAN-Instance mapping, region name and revision level.</p>  |
| Step 4 | <p><b>name</b> <i>name</i></p> <p>Configure the region name of the region.</p> <p><i>name</i>: Specify the region name, used to identify an MST region. The valid values are from 1 to 32 characters.</p>  |
| Step 5 | <p><b>revision</b> <i>revision</i></p> <p>Configure the revision level of the region.</p> <p><i>revision</i>: Specify the revision level of the region. The valid values are from 0 to 65535.</p>  |
| Step 6 | <p><b>instance</b> <i>instance-id</i> <b>vlan</b> <i>vlan-id</i></p> <p>Configure the VLAN-Instance mapping.</p> <p><i>instance-id</i>: Specify the Instance ID. The valid values are from 1 to 8.</p> <p><i>vlan-id</i>: Specify the VLAN mapped to the corresponding instance.</p>   |
| Step 7 | <p><b>show spanning-tree mst</b> { <b>configuration</b> [ <i>digest</i> ]   <b>instance</b> <i>instance-id</i> [ <b>interface</b> [ <b>fastEthernet</b> <i>port</i>   <b>gigabitEthernet</b> <i>port</i>   <b>port-channel</b> <i>lagid</i>   <b>ten-gigabitEthernet</b> <i>port</i> ] ] }</p> <p>(Optional) View the related information of MSTP Instance.</p> <p><i>digest</i>: Specify to display the digest calculated by instance-vlan map.</p> <p><i>instance-id</i>: Specify the Instance ID desired to view, ranging from 1 to 8.</p> <p><i>port</i>: Specify the port number.</p> <p><i>lagid</i>: Specify the ID of the LAG.</p>                       |

---

Step 8     **end**  
Return to privileged EXEC mode.

---

Step 9     **copy running-config startup-config**  
Save the settings in the configuration file.

---

This example shows how to create an MST region, of which the region name is R1, the revision level is 100 and VLAN 2-VLAN 6 are mapped to instance 5:

**Switch#configure**

**Switch(config)#spanning-tree mst configuration**

**Switch(config-mst)#name R1**

**Switch(config-mst)#revision 100**

**Switch(config-mst)#instance 5 vlan 2-6**

**Switch(config-mst)#show spanning-tree mst configuration**

Region-Name : R1

Revision : 100

| MST-Instance | Vlans-Mapped |
|--------------|--------------|
| -----        | -----        |
| 0            | 1,7-4094     |
| 5            | 2-6,         |
| -----        | -----        |

**Switch(config-mst)#end**

**Switch#copy running-config startup-config**

#### ■ Configuring the Parameters on Ports in Instance

Follow these steps to configure the priority and path cost of ports in the specified instance:

---

Step 1     **configure**  
Enter global configuration mode.

---

Step 2     **interface {fastEthernet port | range fastEthernet port-list | gigabitEthernet port | range gigabitEthernet port-list | ten-gigabitEthernet port | range ten-gigabitEthernet port-list | port-channel port-channel-id | range port-channel port-channel-list}**  
Enter interface configuration mode.

---

Step 3 **spanning-tree mst instance** *instance-id* **[ [ port-priority pri ] | [ cost cost ] ]**

Configure the priority and path cost of ports in the specified instance.

*instance-id*: Specify the instance ID, the valid values ranges from 1 to 8.

*pri*: Specify the Priority for the port in the corresponding instance. The value should be an integral multiple of 16, ranging from 0 to 240. The default value is 128. The port with lower value has the higher priority. When the root path of the port is the same as other ports', the switch will compare the port priorities between these ports and select a root port with the highest priority.

*cost*: Enter the value of the path cost in the corresponding instance. The valid values are from 0 to 2000000. The default setting is Auto, which means the port calculates the external path cost automatically according to the port's link speed. The port with the lowest root path cost will be elected as the root port of the switch.

Step 4 **show spanning-tree mst** **{ configuration [ digest ] | instance** *instance-id* **[ interface [ fastEthernet** *port* **| gigabitEthernet** *port* **| port-channel** *lagid* **| ten-gigabitEthernet** *port* **]]}**

(Optional) View the related information of MSTP Instance.

*digest*: Specify to display the digest calculated by instance-vlan map.

*instance-id*: Specify the Instance ID desired to view, ranging from 1 to 8.

*port*: Specify the port number.

*lagid*: Specify the ID of the LAG.

Step 5 **end**  
Return to privileged EXEC mode.

Step 6 **copy running-config startup-config**  
Save the settings in the configuration file.

This example shows how to configure the priority as 144, the path cost as 200 of port 1/0/3 in instance 5:

**Switch#configure**

**Switch(config)#interface gigabitEthernet 1/0/3**

**Switch(config-if)#spanning-tree mst instance 5 port-priority 144 cost 200**

**Switch(config-if)#show spanning-tree interface gigabitEthernet 1/0/3**

MST-Instance 0 (CIST)

| Interface | State  | Prio | Ext-Cost | Int-Cost | Edge | P2p      | Mode  | Role | Status | LAG  |
|-----------|--------|------|----------|----------|------|----------|-------|------|--------|------|
| -----     | -----  | ---- | -----    | -----    | ---- | -----    | ----- | ---- | -----  | ---- |
| Gi1/0/3   | Enable | 32   | Auto     | Auto     | No   | No(auto) | N/A   | N/A  | LnkDwn | N/A  |

MST-Instance 5



| Interface | Prio  | Cost  | Role  | Status | LAG   |
|-----------|-------|-------|-------|--------|-------|
| -----     | ----- | ----- | ----- | -----  | ----- |
| Gi1/0/3   | 144   | 200   | N/A   | LnkDwn | N/A   |

```
Switch(config-if)#end
```

```
Switch#copy running-config startup-config
```

### 3.2.3 Configuring Global MSTP Parameters

Follow these steps to configure the global MSTP parameters of the switch:

---

Step 1 **configure**

Enter global configuration mode.

---

Step 2 **spanning-tree priority *pri***

Configure the priority of the switch for comparison in CIST.

*pri*: Specify the priority for the switch. The valid value is from 0 to 61440, which are divisible by 4096. The priority is a parameter used to determine the root bridge for spanning tree. The switch with the lower value has the higher priority.

In STP/RSTP, the value is the priority of the switch in spanning tree. The switch with the highest priority will be elected as the root bridge.

In MSTP, the value is the priority of the switch in CIST. The switch with the higher priority will be elected as the root bridge in CIST.

---

Step 3 **spanning-tree timer { [ *forward-time* *forward-time* ] [ *hello-time* *hello-time* ] [ *max-age* *max-age* ] }**

(Optional) Configure the Forward Delay, Hello Time and Max Age.

*forward-time*: Specify the value of Forward Delay. It is the interval between the port state transition from listening to learning. The valid values are from 4 to 30 in seconds, and the default value is 15. Forward Delay is used to prevent the network from causing temporary loops during the regeneration of spanning tree. The interval between the port state transition from learning to forwarding is also the Forward Delay.

*hello-time*: Specify the value of Hello Time. It is the interval between BPDUs' sending. The valid values are from 1 to 10 in seconds, and the default value is 2. The root bridge sends configuration BPDUs at an interval of Hello Time. It works with the MAX Age to test the link failures and maintain the spanning tree.

*max-age*: Specify the value of Max Age. It is the maximum time that the switch can wait without receiving a BPDU before attempting to regenerate a new spanning tree. The valid values are from 6 to 40 in seconds, and the default value is 20.

---

Step 4 **spanning-tree hold-count *value***

(Optional) Specify the maximum number of BPDU that can be sent in a second.

*value*: Specify the maximum number of BPDU packets that can be sent in a second. The valid values are from 1 to 20 pps, and the default value is 5.

---

**Step 5** `spanning-tree max-hops value`

(Optional) Specify the maximum BPDU hop counts that can be forwarded in a MST region. A switch receives BPDU, then decrements the hop count by one and generates BPDUs with the new value. When the hop reaches zero, the switch will discard the BPDU. This value can control the scale of the spanning tree in the MST region.

*value*: Specify the maximum number of hops that occur in a specific region before the BPDU is discarded. The valid values are from 1 to 40 in hop, and the default value is 20.

**Step 6** `show spanning-tree bridge`

(Optional) View the global parameters of the switch.

**Step 7** `end`

Return to privileged EXEC mode.

**Step 8** `copy running-config startup-config`

Save the settings in the configuration file.

 **Note:**

To prevent frequent network flapping, make sure that Hello Time, Forward Delay, and Max Age conform to the following formulas:

- $2 * (\text{Hello Time} + 1) \leq \text{Max Age}$
- $2 * (\text{Forward Delay} - 1) \geq \text{Max Age}$

This example shows how to configure the CIST priority as 36864, the Forward Delay as 12 seconds, the Hold Count as 8 and the Max Hop as 25:

**Switch#configure**

```
Switch(config)#spanning-tree priority 36864
```

```
Switch(config-if)#spanning-tree timer forward-time 12
```

```
Switch(config-if)#spanning-tree hold-count 8
```

```
Switch(config-if)#spanning-tree max-hops 25
```

```
Switch(config-if)#show spanning-tree bridge
```

| State  | Mode | Priority | Hello-Time | Fwd-Time | Max-Age | Hold-Count | Max-Hops |
|--------|------|----------|------------|----------|---------|------------|----------|
| Enable | Mstp | 36864    | 2          | 12       | 20      | 8          | 25       |

```
Switch(config-if)#end
```

```
Switch#copy running-config startup-config
```

### 3.2.4 Enabling Spanning Tree Globally

Follow these steps to configure the spanning tree mode as MSTP and enable spanning tree function globally:

|        |  |
|--------|--|
| Step 1 | <b>configure</b><br>Enter global configuration mode.   |
| Step 2 | <b>spanning-tree mode mstp</b><br>Configure the spanning tree mode as MSTP.<br><i>mstp</i> : Specify the spanning tree mode as MSTP. |
| Step 3 | <b>spanning-tree</b><br>Enable spanning tree function globally.  |
| Step 4 | <b>show spanning-tree active</b><br>(Optional) View the active information of MSTP.  |
| Step 5 | <b>end</b><br>Return to privileged EXEC mode.  |
| Step 6 | <b>copy running-config startup-config</b><br>Save the settings in the configuration file.  |

This example shows how to configure the spanning tree mode as MSTP and enable spanning tree function globally :

**Switch#configure**

**Switch(config)#spanning-tree mode mstp**

**Switch(config)#spanning-tree**

**Switch(config)#show spanning-tree active**

Spanning tree is enabled

Spanning-tree's mode: MSTP (802.1s Multiple Spanning Tree Protocol)

Latest topology change time: 2006-01-04 10:47:42

MST-Instance 0 (CIST)

Root Bridge

Priority : 32768

Address : 00-0a-eb-13-23-97

External Cost : 200000

Root Port : Gi/0/20

Designated Bridge

Priority : 32768

Address : 00-0a-eb-13-23-97

Regional Root Bridge

Priority : 36864

Address : 00-0a-eb-13-12-ba

Local bridge is the regional root bridge

Local Bridge

Priority : 36864

Address : 00-0a-eb-13-12-ba

| Interface | State  | Prio | Ext-Cost | Int-Cost | Edge | P2p       | Mode | Role | Status |
|-----------|--------|------|----------|----------|------|-----------|------|------|--------|
| Gi/0/16   | Enable | 128  | 200000   | 200000   | No   | Yes(auto) | Mstp | Altn | Blk    |
| Gi/0/20   | Enable | 128  | 200000   | 200000   | No   | Yes(auto) | Mstp | Root | Fwd    |

MST-Instance 1

Root Bridge

Priority : 32768

Address : 00-0a-eb-13-12-ba

Local bridge is the root bridge

Designated Bridge

Priority : 32768

Address : 00-0a-eb-13-12-ba

Local Bridge

Priority : 32768

Address : 00-0a-eb-13-12-ba

| Interface | Prio | Cost   | Role | Status |
|-----------|------|--------|------|--------|
| Gi/0/16   | 128  | 200000 | Altn | Blk    |
| Gi/0/20   | 128  | 200000 | Mstr | Fwd    |

**Switch(config)#end**

**Switch#copy running-config startup-config**

# 4 STP Security Configurations

## 4.1 Using the GUI

Choose the menu **L2 FEATURES > Spanning Tree > STP Security** to load the following page.

Figure 4-1 Configuring the Port Protect

| UNIT1                               |        | LAGS         |              |          |              |             |              |     |
|-------------------------------------|--------|--------------|--------------|----------|--------------|-------------|--------------|-----|
| <input type="checkbox"/>            | Port   | Loop Protect | Root Protect | TC Guard | BPDU Protect | BPDU Filter | BPDU Forward | LAG |
| <input checked="" type="checkbox"/> | 1/0/1  | Disabled     | Disabled     | Disabled | Disabled     | Disabled    | Enabled      | --- |
| <input type="checkbox"/>            | 1/0/2  | Disabled     | Disabled     | Disabled | Disabled     | Disabled    | Enabled      | --- |
| <input type="checkbox"/>            | 1/0/3  | Disabled     | Disabled     | Disabled | Disabled     | Disabled    | Enabled      | --- |
| <input type="checkbox"/>            | 1/0/4  | Disabled     | Disabled     | Disabled | Disabled     | Disabled    | Enabled      | --- |
| <input type="checkbox"/>            | 1/0/5  | Disabled     | Disabled     | Disabled | Disabled     | Disabled    | Enabled      | --- |
| <input type="checkbox"/>            | 1/0/6  | Disabled     | Disabled     | Disabled | Disabled     | Disabled    | Enabled      | --- |
| <input type="checkbox"/>            | 1/0/7  | Disabled     | Disabled     | Disabled | Disabled     | Disabled    | Enabled      | --- |
| <input type="checkbox"/>            | 1/0/8  | Disabled     | Disabled     | Disabled | Disabled     | Disabled    | Enabled      | --- |
| <input type="checkbox"/>            | 1/0/9  | Disabled     | Disabled     | Disabled | Disabled     | Disabled    | Enabled      | --- |
| <input type="checkbox"/>            | 1/0/10 | Disabled     | Disabled     | Disabled | Disabled     | Disabled    | Enabled      | --- |

Total: 28      1 entry selected.     

Configure the Port Protect features for the selected ports, and click **Apply**.

|                     |  |
|---------------------|--|
| <b>UNIT</b>         | Select the desired unit or LAGs for configuration.   |
| <b>Loop Protect</b> | <p>Enable or disable Loop Protect. It is recommended to enable this function on root ports and alternate ports.</p> <p>When there are link congestions or link failures in the network, the switch will not receive BPDUs from the upstream device in time. Loop Protect is used to avoid loop caused by the recalculation in this situation. With Loop Protect function enabled, the port will temporarily transit to a blocking state after it does not receive BPDUs in time.</p> |

---

|              |   |
|--------------|---|
| Root Protect | <p>Enable or disable Root Protect. It is recommended to enable this function on the designated ports of the root bridge.</p> <p>Switches with faulty configurations may produce a higher-priority BPDUs than the root bridge's, and this situation will cause recalculation of the spanning tree. Root Protect is used to ensure that the desired root bridge will not lose its position in the scenario above. With root protect enabled, the port will temporarily transit to blocking state when it receives higher-priority BPDUs. After two forward delays, if the port does not receive any other higher-priority BPDUs, it will transit to its normal state.</p> |
| TC Guard     | <p>Enable or disable the TC Guard function. It is recommended to enable this function on the ports of non-root switches.</p> <p>TC Guard function is used to prevent the switch from frequently changing the MAC address table. With TC Guard function enabled, when the switch receives TC-BPDUs, it will not process the TC-BPDUs at once. The switch will wait for a fixed time and process the TC-BPDUs together after receiving the first TC-BPDU, then it will restart timing.</p>  |
| BPDU Protect | <p>Enable or disable the BPDU Protect function. It is recommended to enable this function on edge ports.</p> <p>Edge ports in spanning tree are used to connect to the end devices and it doesn't receive BPDUs in the normal situation. If edge ports receive BPDUs, it may be an attack. BPDU Protect is used to protect the switch from the attack talked above. With BPDU protect function enabled, the edge ports will be shutdown when they receives BPDUs, and will report these cases to the administrator. Only the administrator can restore the state of the ports.</p>  |
| BPDU Filter  | <p>Enable or disable BPDU Filter. It is recommended to enable this function on edge ports.</p> <p>With BPDU Filter enabled, the port does not forward BPDUs from the other switches.</p>  |
| BPDU Forward | <p>Enable or disable BPDU Forward. This function only takes effect when the spanning tree function is disabled globally.</p> <p>With BPDU forward enabled, the port can still forward spanning tree BPDUs when the spanning tree function is disabled.</p>  |

---

## 4.2 Using the CLI

### 4.2.1 Configuring the STP Security

Follow these steps to configure the Root protect feature, BPDU protect feature and BPDU filter feature for ports:

---

|        |  |
|--------|--|
| Step 1 | <b>configure</b><br>Enter global configuration mode. |
|--------|--|

---

- 
- Step 2 **interface {fastEthernet port | range fastEthernet port-list | gigabitEthernet port | range gigabitEthernet port-list | ten-gigabitEthernet port | range ten-gigabitEthernet port-list | port-channel port-channel-id | range port-channel port-channel-list}**
- Enter interface configuration mode.
- 
- Step 3 **spanning-tree guard loop**
- (Optional) Enable Loop Protect. It is recommended to enable this function on root ports and alternate ports.
- When there are link congestions or link failures in the network, the switch will not receive BPDUs from the upstream device in time. Loop Protect is used to avoid loop caused by the recalculation in this situation. With Loop Protect function enabled, the port will temporarily transit to a blocking state after it does not receive BPDUs in time.
- 
- Step 4 **spanning-tree guard root**
- (Optional) Enable Root Protect. It is recommended to enable this function on the designated ports of the root bridge.
- Switches with faulty configurations may produce a higher-priority BPDUs than the root bridge's, and this situation will cause recalculation of the spanning tree. Root Protect is used to ensure that the desired root bridge will not lose its position in the scenario above. With root protect enabled, the port will temporarily transit to blocking state when it receives higher-priority BPDUs. After two forward delays, if the port does not receive any other higher-priority BPDUs, it will transit to its normal state.
- 
- Step 5 **spanning-tree guard tc**
- (Optional) Enable the TC Guard function. It is recommended to enable this function on the ports of non-root switches.
- TC Guard function is used to prevent the switch from frequently changing the MAC address table. With TC Guard function enabled, when the switch receives TC-BPDUs, it will not process the TC-BPDUs at once. The switch will wait for a fixed time and process the TC-BPDUs together after receiving the first TC-BPDU, then it will restart timing.
- 
- Step 6 **spanning-tree bpduguard**
- (Optional) Enable the BPDU Protect function. It is recommended to enable this function on edge ports.
- Edge ports in spanning tree are used to connect to the end devices and it doesn't receive BPDUs in the normal situation. If edge ports receive BPDUs, it may be an attack. BPDU Protect is used to protect the switch from the attack talked above. With BPDU protect function enabled, the edge ports will be shutdown when they receives BPDUs, and will report these cases to the administrator. Only the administrator can restore the state of the ports.
- 
- Step 7 **spanning-tree bpdufilter**
- (Optional) Enable or disable BPDU Filter. It is recommended to enable this function on edge ports.
- With BPDU Filter enabled, the port does not forward BPDUs from the other switches.
-

**Step 8 spanning-tree bpdulflood**

(Optional) Enable BPDU Forward. This function only takes effect when the spanning tree function is disabled globally. By default, it is enabled.

With BPDU forward enabled, the port can still forward spanning tree BPDUs when the spanning tree function is disabled.

**Step 9 show spanning-tree interface-security [ fastEthernet port | gigabitEthernet port | ten-gigabitEthernet port | port-channel port-channel-id ] [ bpdufilter | bpduguard | bpdulflood | loop | root | tc ]**

(Optional) View the protect information of ports.

*port*: Specify the port number.

*lagid*: Specify the ID of the LAG.

**Step 10 end**

Return to privileged EXEC mode.

**Step 11 copy running-config startup-config**

Save the settings in the configuration file.

This example shows how to enable Loop Protect, Root Protect, BPDU Filter and BPDU Protect functions on port 1/0/3:

**Switch#configure**

**Switch(config)#interface gigabitEthernet 1/0/3**

**Switch(config-if)#spanning-tree guard loop**

**Switch(config-if)#spanning-tree guard root**

**Switch(config-if)#spanning-tree bpdufilter**

**Switch(config-if)#spanning-tree bpduguard**

**Switch(config-if)#show spanning-tree interface-security gigabitEthernet 1/0/3**

| Interface | BPDU-Filter | BPDU-Guard | Loop-Protect | Root-Protect | TC-Protect | BPDU-Flood |
|-----------|-------------|------------|--------------|--------------|------------|------------|
| Gi1/0/3   | Enable      | Enable     | Enable       | Enable       | Disable    | Enable     |

-----

-----

**Switch(config-if)#end**

**Switch#copy running-config startup-config**



# 5 Configuration Example for MSTP

MSTP, backwards-compatible with STP and RSTP, can map VLANs to instances to implement load-balancing, thus providing a more flexible method in network management. Here we take the MSTP configuration as an example.

## 5.1 Network Requirements

As shown in figure 5-1, the network consists of three switches. Traffic in VLAN 101-VLAN 106 is transmitted in this network. The link speed between the switches is 100Mb/s (the default path cost of the port is 200000).

It is required that traffic in VLAN 101 - VLAN 103 and traffic in VLAN 104 - VLAN 106 should be transmitted along different paths.

Figure 5-1 Network Topology

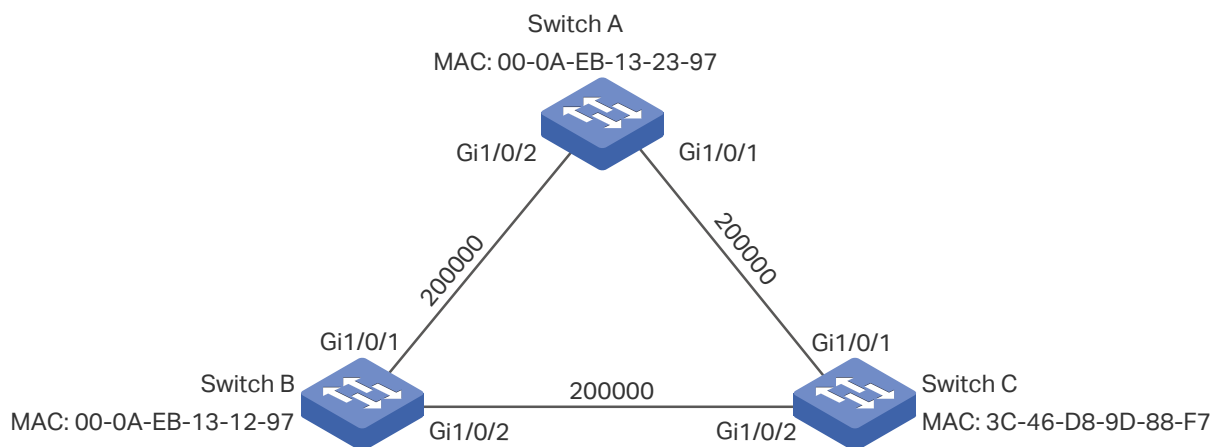

## 5.2 Configuration Scheme

To meet this requirement, you are suggested to configure MSTP function on the switches. Map the VLANs to different instances to ensure traffic can be transmitted along the respective instance.

Here we configure two instances to meet the requirement, as is shown below:

Figure 5-2 VLAN-Instance Mapping

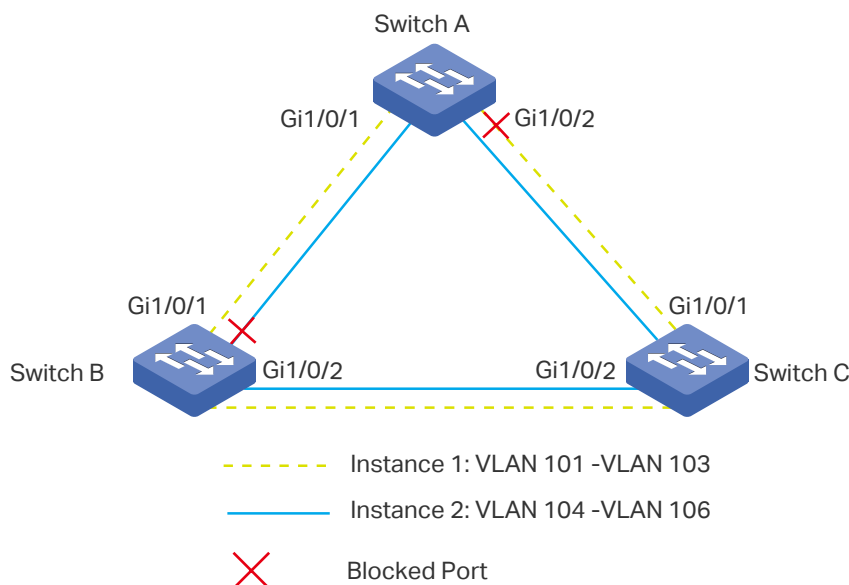

The overview of configuration is as follows:

- 1) Enable MSTP function globally in all the switches.
- 2) Enable Spanning Tree function on the ports in each switch.
- 3) Configure Switch A, Switch B and Switch C in the same region. Configure the region name as 1, and the revision level as 100. Map VLAN 101 - VLAN 103 to instance 1 and VLAN 104 - VLAN 106 to instance 2.
- 4) Configure the priority of Switch B as 0 to set it as the root bridge in instance 1; configure the priority of Switch C as 0 to set it as the root bridge in instance 2.
- 5) Configure the path cost to block the specified ports. For instance 1, set the path cost of port 1/0/1 of Switch A to be greater than the default path cost (200000); for instance 2, set the path cost of port 1/0/2 of Switch B to be greater than the default path cost (200000). After this configuration, port 1/0/2 of Switch A in instance 1 and port 1/0/1 of Switch B in instance 2 will be blocked for they cannot be neither root port nor designated port.

#### Note:

Please configure MSTP for each switch first and then connect them together to avoid broadcast storm.

## 5.3 Using the GUI

### ■ Configurations for Switch A

- 1) Choose the menu **L2 FEATURES > Spanning Tree > STP Config > STP Config** to load the following page. Enable MSTP function globally, here we leave the values of the other global parameters as default settings. **Click Apply.**

Figure 5-3 Configure the Global MSTP Parameters of the Switch

**Global Config**

---

Spanning Tree:  Enable

Mode: MSTP

Apply

---

**Parameters Config**

CIST Priority:  (0-61440, in increments of 4096)

Hello Time:  seconds (1-10)

Max Age:  seconds (6-40)

Forward Delay:  seconds (4-30)

Tx Hold Count:  pps (1-20)

Max Hops:  (1-40)

Apply

- 2) Choose the menu **L2 FEATURES > Spanning Tree > STP Config > Port Config** to load the following page. Enable spanning tree function on port 1/0/1 and port 1/0/2. Here we leave the values of the other parameters as default settings. Click **Apply**.

Figure 5-4 Enable Spanning Tree Function on Ports

**Port Config**

---

UNIT1

LAGS

| <input type="checkbox"/>            | Port   | Status   | Priority | Ext-Path Cost | Int-Path Cost | Edge Port | P2P Link | MCheck | Port Mode | Port t |
|-------------------------------------|--------|----------|----------|---------------|---------------|-----------|----------|--------|-----------|--------|
| <input checked="" type="checkbox"/> | 1/0/1  | Enabled  | 128      | Auto          | Auto          | Disabled  | Auto     | --     | --        | --     |
| <input checked="" type="checkbox"/> | 1/0/2  | Enabled  | 128      | Auto          | Auto          | Disabled  | Auto     | --     | --        | --     |
| <input type="checkbox"/>            | 1/0/3  | Disabled | 128      | Auto          | Auto          | Disabled  | Auto     | --     | --        | --     |
| <input type="checkbox"/>            | 1/0/4  | Disabled | 128      | Auto          | Auto          | Disabled  | Auto     | --     | --        | --     |
| <input type="checkbox"/>            | 1/0/5  | Disabled | 128      | Auto          | Auto          | Disabled  | Auto     | --     | --        | --     |
| <input type="checkbox"/>            | 1/0/6  | Disabled | 128      | Auto          | Auto          | Disabled  | Auto     | --     | --        | --     |
| <input type="checkbox"/>            | 1/0/7  | Disabled | 128      | Auto          | Auto          | Disabled  | Auto     | --     | --        | --     |
| <input type="checkbox"/>            | 1/0/8  | Disabled | 128      | Auto          | Auto          | Disabled  | Auto     | --     | --        | --     |
| <input type="checkbox"/>            | 1/0/9  | Disabled | 128      | Auto          | Auto          | Disabled  | Auto     | --     | --        | --     |
| <input type="checkbox"/>            | 1/0/10 | Disabled | 128      | Auto          | Auto          | Disabled  | Auto     | --     | --        | --     |

Total: 28
2 entries selected.

Cancel
Apply

- 3) Choose the menu **L2 FEATURES > Spanning Tree > MSTP Instance > Region Config** to load the following page. Set the region name as 1 and the revision level as 100. Click **Apply**.

Figure 5-5 Configuring the MST Region

Region Config

Region Name:

Revision:  (0-65535)

- 4) Choose the menu **L2 FEATURES > Spanning Tree > MSTP Instance > Instance Config**. Click Add, map VLAN101-VLAN103 to instance 1 and set the priority as 32768; map VLAN104-VLAN106 to instance 2 and set the priority as 32768. Click **Create**.

Figure 5-6 Configuring the VLAN-Instance Mapping

Instance Config

Instance ID:  (1-8)

Priority:  (0-61440, in increments of 4096)

VLAN ID:  Add  Delete

(1-4094, format:1,3,4-7,11-30)

- 5) Choose the menu **L2 FEATURES > Spanning Tree > MSTP Instance > Instance Port Config** to load the following page. Set the path cost of port 1/0/1 in instance 1 as **300000** so that port 1/0/1 of switch C can be selected as the designated port.

Figure 5-7 Configure the Path Cost of Port 1/0/1 In Instance 1

Instance Port Config

Instance ID:

| <input type="checkbox"/>            | Port   | Priority | Path Cost | Port Role | Port Status | LAG |
|-------------------------------------|--------|----------|-----------|-----------|-------------|-----|
| <input checked="" type="checkbox"/> | 1/0/1  | 128      | 300000    | --        | --          | --  |
| <input type="checkbox"/>            | 1/0/2  | 128      | Auto      | --        | --          | --  |
| <input type="checkbox"/>            | 1/0/3  | 128      | Auto      | --        | --          | --  |
| <input type="checkbox"/>            | 1/0/4  | 128      | Auto      | --        | --          | --  |
| <input type="checkbox"/>            | 1/0/5  | 128      | Auto      | --        | --          | --  |
| <input type="checkbox"/>            | 1/0/6  | 128      | Auto      | --        | --          | --  |
| <input type="checkbox"/>            | 1/0/7  | 128      | Auto      | --        | --          | --  |
| <input type="checkbox"/>            | 1/0/8  | 128      | Auto      | --        | --          | --  |
| <input type="checkbox"/>            | 1/0/9  | 128      | Auto      | --        | --          | --  |
| <input type="checkbox"/>            | 1/0/10 | 128      | Auto      | --        | --          | --  |

Total: 28 1 entry selected.

6) Click  Save to save the settings.

■ Configurations for Switch B

1) Choose the menu **L2 FEATURES > Spanning Tree > STP Config > STP Config** to load the following page. Enable MSTP function globally, here we leave the values of the other global parameters as default settings. **Click Apply.**

Figure 5-8 Configure the Global MSTP Parameters of the Switch

Global Config

Spanning Tree:  Enable

Mode:

---

Parameters Config

CIST Priority:  (0-61440, in increments of 4096)

Hello Time:  seconds (1-10)

Max Age:  seconds (6-40)

Forward Delay:  seconds (4-30)

Tx Hold Count:  pps (1-20)

Max Hops:  (1-40)

2) Choose the menu **L2 FEATURES > Spanning Tree > STP Config > Port Config** to load the following page. Enable the spanning tree function on port 1/0/1 and port 1/0/2. Here we leave the values of the other parameters as default settings. **Click Apply.**

Figure 5-9 Enable Spanning Tree Function on Ports

Port Config

| UNIT1                               |        | LAGS     |          |               |               |           |          |        |           |        |
|-------------------------------------|--------|----------|----------|---------------|---------------|-----------|----------|--------|-----------|--------|
| <input type="checkbox"/>            | Port   | Status   | Priority | Ext-Path Cost | Int-Path Cost | Edge Port | P2P Link | MCheck | Port Mode | Port I |
| <input checked="" type="checkbox"/> | 1/0/1  | Enabled  | 128      | Auto          | Auto          | Disabled  | Auto     | --     | --        |        |
| <input checked="" type="checkbox"/> | 1/0/2  | Enabled  | 128      | Auto          | Auto          | Disabled  | Auto     | --     | --        |        |
| <input type="checkbox"/>            | 1/0/3  | Disabled | 128      | Auto          | Auto          | Disabled  | Auto     | --     | --        |        |
| <input type="checkbox"/>            | 1/0/4  | Disabled | 128      | Auto          | Auto          | Disabled  | Auto     | --     | --        |        |
| <input type="checkbox"/>            | 1/0/5  | Disabled | 128      | Auto          | Auto          | Disabled  | Auto     | --     | --        |        |
| <input type="checkbox"/>            | 1/0/6  | Disabled | 128      | Auto          | Auto          | Disabled  | Auto     | --     | --        |        |
| <input type="checkbox"/>            | 1/0/7  | Disabled | 128      | Auto          | Auto          | Disabled  | Auto     | --     | --        |        |
| <input type="checkbox"/>            | 1/0/8  | Disabled | 128      | Auto          | Auto          | Disabled  | Auto     | --     | --        |        |
| <input type="checkbox"/>            | 1/0/9  | Disabled | 128      | Auto          | Auto          | Disabled  | Auto     | --     | --        |        |
| <input type="checkbox"/>            | 1/0/10 | Disabled | 128      | Auto          | Auto          | Disabled  | Auto     | --     | --        |        |

Total: 28      2 entries selected.     

- 3) Choose the menu **L2 FEATURES > Spanning Tree > MSTP Instance > Region Config** to load the following page. Set the region name as 1 and the revision level as 100. Click **Apply**.

Figure 5-10 Configuring the Region

Region Config

Region Name:

Revision:  (0-65535)

- 4) Choose the menu **L2 FEATURES > Spanning Tree > MSTP Instance > Instance Config**. Map VLAN101-VLAN103 to instance 1 and set the Priority as 0; map VLAN104-VLAN106 to instance 2 and set the priority as 32768. Click **Create**.

Figure 5-11 Configuring the VLAN-Instance Mapping

Instance Config

Instance ID:  (1-8)

Priority:  (0-61440, in increments of 4096)

VLAN ID:  Add  Delete

(1-4094, format:1,3,4-7,11-30)

- Choose the menu **L2 FEATURES > Spanning Tree > MSTP Instance > Instance Port Config** to load the following page. Set the path cost of port 1/0/2 in instance 2 as 300000 so that port 1/0/1 of switch A can be selected as the designated port.

Figure 5-12 Configure the Path Cost of Port 1/0/2 in Instance 2

Instance Port Config

Instance ID:

UNIT1 | LAGS

| <input type="checkbox"/>            | Port   | Priority | Path Cost | Port Role | Port Status | LAG |
|-------------------------------------|--------|----------|-----------|-----------|-------------|-----|
| <input type="checkbox"/>            | 1/0/1  | 128      | Auto      | --        | --          | --- |
| <input checked="" type="checkbox"/> | 1/0/2  | 128      | 300000    | --        | --          | --- |
| <input type="checkbox"/>            | 1/0/3  | 128      | Auto      | --        | --          | --- |
| <input type="checkbox"/>            | 1/0/4  | 128      | Auto      | --        | --          | --- |
| <input type="checkbox"/>            | 1/0/5  | 128      | Auto      | --        | --          | --- |
| <input type="checkbox"/>            | 1/0/6  | 128      | Auto      | --        | --          | --- |
| <input type="checkbox"/>            | 1/0/7  | 128      | Auto      | --        | --          | --- |
| <input type="checkbox"/>            | 1/0/8  | 128      | Auto      | --        | --          | --- |
| <input type="checkbox"/>            | 1/0/9  | 128      | Auto      | --        | --          | --- |
| <input type="checkbox"/>            | 1/0/10 | 128      | Auto      | --        | --          | --- |

Total: 28 | 1 entry selected. |

- Click Save to save the settings.

■ Configurations for Switch C

- Choose the menu **L2 FEATURES > Spanning Tree > STP Config > STP Config** to load the following page. Enable MSTP function globally, here we leave the values of the other global parameters as default settings. **Click Apply.**

Figure 5-13 Configure the Global MSTP Parameters of the Switch

Global Config

Spanning Tree:  Enable

Mode:

Parameters Config

CIST Priority:  (0-61440, in increments of 4096)

Hello Time:  seconds (1-10)

Max Age:  seconds (6-40)

Forward Delay:  seconds (4-30)

Tx Hold Count:  pps (1-20)

Max Hops:  (1-40)

- Choose the menu **L2 FEATURES > Spanning Tree > STP Config > Port Config** to load the following page. Enable the spanning tree function on port 1/0/1 and port 1/0/2. Here we leave the values of the other parameters as default settings. Click **Apply**.

Figure 5-14 Enable Spanning Tree Function on Ports

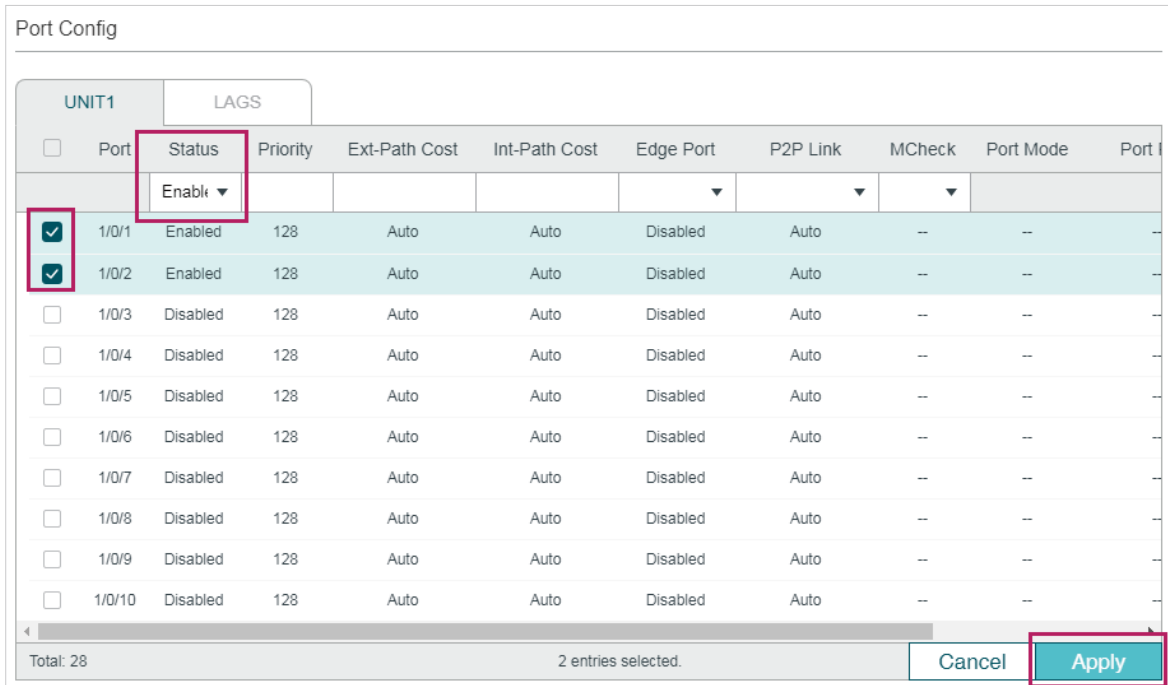

- Choose the menu **Spanning Tree > MSTP Instance > Region Config** to load the following page. Set the region name as 1 and the revision level as 100. Click **Apply**.

Figure 5-15 Configuring the Region



- Choose the menu **L2 FEATURES > Spanning Tree > MSTP Instance > Instance Config**. Click Add, map VLAN101-VLAN103 to instance 1 and set the priority as 32768; map VLAN104-VLAN106 to instance 2 and set the priority as 0. Click **Create**.

Figure 5-16 Configuring the VLAN-Instance Mapping

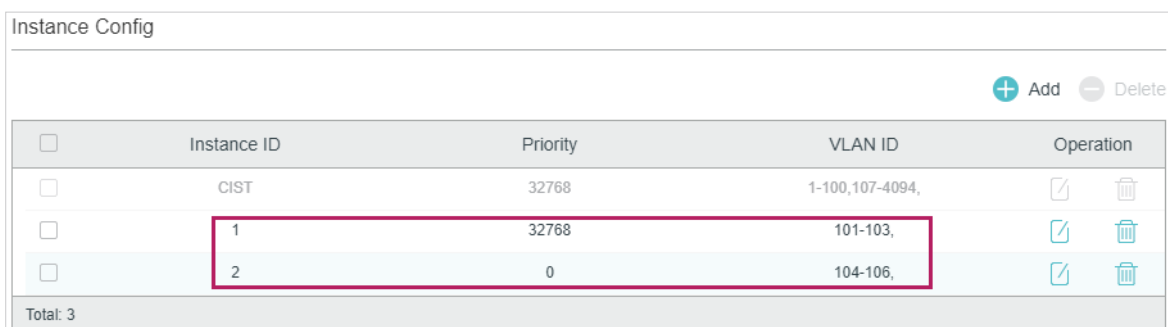

- Click  to save the settings.



## 5.4 Using the CLI

### ■ Configurations for Switch A

- 1) Configure the spanning tree mode as MSTP, then enable spanning tree function globally.

```
Switch#configure
```

```
Switch(config)#spanning-tree mode mstp
```

```
Switch(config)#spanning-tree
```

- 2) Enable the spanning tree function on port 1/0/1 and port 1/0/2, and specify the path cost of port 1/0/1 in instance 1 as 300000.

```
Switch(config)#interface gigabitEthernet 1/0/1
```

```
Switch(config-if)#spanning-tree
```

```
Switch(config-if)#spanning-tree mst instance 1 cost 300000
```

```
Switch(config-if)#exit
```

```
Switch(config)#interface gigabitEthernet 1/0/2
```

```
Switch(config-if)#spanning-tree
```

```
Switch(config-if)#exit
```

- 3) Configure the region name as 1, the revision number as 100; map VLAN101-VLAN103 to instance 1; map VLAN104-VLAN106 to instance 2:

```
Switch(config)#spanning-tree mst configuration
```

```
Switch(config-mst)#name 1
```

```
Switch(config-mst)#revision 100
```

```
Switch(config-mst)#instance 1 vlan 101-103
```

```
Switch(config-mst)#instance 2 vlan 104-106
```

```
Switch(config-mst)#end
```

```
Switch#copy running-config startup-config
```

### ■ Configurations for Switch B

- 1) Configure the spanning tree mode as MSTP, then enable spanning tree function globally.

```
Switch#configure
```

```
Switch(config)#spanning-tree mode mstp
```

```
Switch(config)#spanning-tree
```

- 2) Enable the spanning tree function on port 1/0/1 and port 1/0/2, and specify the path cost of port 1/0/2 in instance 2 as 300000.

```
Switch(config)#interface gigabitEthernet 1/0/2
Switch(config-if)#spanning-tree
Switch(config-if)#spanning-tree mst instance 2 cost 300000
Switch(config-if)#exit
Switch(config)#interface gigabitEthernet 1/0/1
Switch(config-if)#spanning-tree
Switch(config-if)#exit
```

- 3) Configure the region name as 1, the revision number as 100; map VLAN101-VLAN103 to instance 1; map VLAN104-VLAN106 to instance 2; configure the priority of Switch B in instance 1 as 0 to set it as the root bridge in instance 1:

```
Switch(config)#spanning-tree mst configuration
Switch(config-mst)#name 1
Switch(config-mst)#revision 100
Switch(config-mst)#instance 1 vlan 101-103
Switch(config-mst)#instance 2 vlan 104-106
Switch(config-mst)#exit
Switch(config)#spanning-tree mst instance 1 priority 0
Switch(config)#end
Switch#copy running-config startup-config
```

#### ■ Configurations for Switch C

- 1) Configure the spanning tree mode as MSTP, then enable spanning tree function globally.

```
Switch#configure
Switch(config)#spanning-tree mode mstp
Switch(config)#spanning-tree
```

- 2) Enable the spanning tree function on port 1/0/1 and port 1/0/2.

```
Switch(config)#interface range gigabitEthernet 1/0/1-2
Switch(config-if-range)#spanning-tree
Switch(config-if-range)#exit
```

- 3) Configure the region name as 1, the revision number as 100; map VLAN101-VLAN103 to instance 1; map VLAN104-VLAN106 to instance 2; configure the priority of Switch C in instance 2 as 0 to set it as the root bridge in instance 2:

```
Switch(config)#spanning-tree mst configuration
Switch(config-mst)#name 1
Switch(config-mst)#revision 100
Switch(config-mst)#instance 1 vlan 101-103
Switch(config-mst)#instance 2 vlan 104-106
Switch(config-mst)#exit
Switch(config)#spanning-tree mst instance 2 priority 0
Switch(config)#end
Switch#copy running-config startup-config
```

## Verify the Configurations

### ■ Switch A

Verify the configurations of Switch A in instance 1:

```
Switch(config)#show spanning-tree mst instance 1
MST-Instance 1
Root Bridge
Priority    :0
Address    :00-0a-eb-13-12-ba
Internal Cost : 400000
Root Port  : 1
Designated Bridge
Priority    :0
Address    :00-0a-eb-13-12-ba
Local Bridge
Priority    :32768
Address    :00-0a-eb-13-23-97
```

| Interface | Prio | Cost   | Role  | Status | LAG  |
|-----------|------|--------|-------|--------|------|
| -----     | ---- | -----  | ----- | -----  | ---- |
| Gi1/0/1   | 128  | 300000 | Root  | Fwd    | N/A  |
| Gi1/0/2   | 128  | 200000 | Altn  | Blk    | N/A  |

Verify the configurations of Switch A in instance 2:

```
Switch(config)#show spanning-tree mst instance 2
```

```
MST-Instance 2
```

```
Root Bridge
```

```
Priority :0
```

```
Address :3c-46-d8-9d-88-f7
```

```
Internal Cost : 200000
```

```
Root Port :2
```

```
Designated Bridge
```

```
Priority :0
```

```
Address :3c-46-d8-9d-88-f7
```

```
Local Bridge
```

```
Priority :32768
```

```
Address :00-0a-eb-13-23-97
```

| Interface | Prio | Cost   | Role  | Status | LAG  |
|-----------|------|--------|-------|--------|------|
| -----     | ---- | -----  | ----- | -----  | ---- |
| Gi1/0/1   | 128  | 200000 | Desg  | Fwd    | N/A  |
| Gi1/0/2   | 128  | 200000 | Root  | Fwd    | N/A  |

#### ■ Switch B

Verify the configurations of Switch B in instance 1:

```
Switch(config)#show spanning-tree mst instance 1
```

```
MST-Instance 1
```

```
Root Bridge
```

```
Priority :0
```

```
Address :00-0a-eb-13-12-ba
```

Local bridge is the root bridge

Designated Bridge

Priority :0

Address :00-0a-eb-13-12-ba

Local Bridge

Priority :0

Address :00-0a-eb-13-12-ba

| Interface | Prio | Cost   | Role | Status |
|-----------|------|--------|------|--------|
| Gi1/0/1   | 128  | 200000 | Desg | Fwd    |
| Gi1/0/2   | 128  | 200000 | Desg | Fwd    |

Verify the configurations of Switch B in instance 2:

Switch(config)#show spanning-tree mst instance 2

MST-Instance 2

Root Bridge

Priority :0

Address :3c-46-d8-9d-88-f7

Internal Cost : 400000

Root Port :2

Designated Bridge

Priority :0

Address :3c-46-d8-9d-88-f7

Local Bridge

Priority :32768

Address :00-0a-eb-13-12-ba

| Interface | Prio | Cost   | Role | Status |
|-----------|------|--------|------|--------|
| Gi1/0/1   | 128  | 200000 | Altn | Blk    |
| Gi1/0/2   | 128  | 300000 | Root | Fwd    |

- Switch C

Verify the configurations of Switch C in instance 1:

```
Switch(config)#show spanning-tree mst instance 1
```

```
MST-Instance 1
```

```
Root Bridge
```

```
Priority :0
```

```
Address :00-0a-eb-13-12-ba
```

```
Internal Cost : 200000
```

```
Root Port : 2
```

```
Designated Bridge
```

```
Priority :0
```

```
Address :00-0a-eb-13-12-ba
```

```
Local Bridge
```

```
Priority :32768
```

```
Address :3c-46-d8-9d-88-f7
```

| Interface | Prio | Cost   | Role | Status |
|-----------|------|--------|------|--------|
| Gi1/0/1   | 128  | 200000 | Desg | Fwd    |
| Gi1/0/2   | 128  | 200000 | Root | Fwd    |

Verify the configurations of Switch C in instance 2:

```
Switch(config)#show spanning-tree mst instance 2
```

```
MST-Instance 2
```

```
Root Bridge
```

```
Priority :0
```

```
Address :3c-46-d8-9d-88-f7
```

```
Local bridge is the root bridge
```

```
Designated Bridge
```

```
Priority :0
```

```
Address :3c-46-d8-9d-88-f7
```

## Local Bridge

Priority :0

Address :3c-46-d8-9d-88-f7

| Interface | Prio  | Cost   | Role  | Status |
|-----------|-------|--------|-------|--------|
| -----     | ----- | -----  | ----- | -----  |
| Gi1/0/1   | 128   | 200000 | Desg  | Fwd    |
| Gi1/0/2   | 128   | 200000 | Desg  | Fwd    |

# 6 Appendix: Default Parameters

Default settings of the Spanning Tree feature are listed in the following table.

Table 6-1 Default Settings of the Global Parameters

| Parameter     | Default Setting |
|---------------|-----------------|
| Spanning-tree | Disabled        |
| Mode          | STP             |
| CIST Priority | 32768           |
| Hello Time    | 2 seconds       |
| Max Age       | 20 seconds      |
| Forward Delay | 15 seconds      |
| Tx Hold Count | 5 pps           |
| Max Hops      | 20 hops         |

Table 6-2 Default Settings of the Port Parameters

| Parameter     | Default Setting |
|---------------|-----------------|
| Status        | Disabled        |
| Priority      | 128             |
| Ext-Path Cost | Auto            |
| In-Path Cost  | Auto            |
| Edge Port     | Disabled        |
| P2P Link      | Auto            |
| MCheck        | -----           |

Table 6-3 Default Settings of the MSTP Instance

| Parameter      | Default Setting |
|----------------|-----------------|
| Status         | Disabled        |
| Revision Level | 0               |



| Parameter     | Default Setting |
|---------------|-----------------|
| Priority      | 32768           |
| Port Priority | 128             |
| Path Cost     | Auto            |

Table 6-4 Default Settings of the STP Security

| Parameter    | Default Setting |
|--------------|-----------------|
| Loop Protect | Disabled        |
| Root Protect | Disabled        |
| TC Guard     | Disabled        |
| BPDU Protect | Disabled        |
| BPDU Filter  | Disabled        |
| BPDU Forward | Enabled         |

# Part 12

## Configuring LLDP

### CHAPTERS

1. LLDP
2. LLDP Configurations
3. LLDP-MED Configurations
4. Viewing LLDP Settings
5. Viewing LLDP-MED Settings
6. Configuration Example
7. Appendix: Default Parameters

# 1 LLDP

## 1.1 Overview

LLDP (Link Layer Discovery Protocol) is a neighbor discovery protocol that is used for network devices to advertise information about themselves to other devices on the network. This protocol is a standard IEEE 802.1ab defined protocol and runs over the Layer 2 (the data-link layer) , which allows for interoperability between network devices of different vendors.

With LLDP enabled, the switch can get its neighbors' information, and network administrators can use the NMS (Network Management System) to gather these information, helping them to know about the network topology, examine the network connectivity and troubleshoot the network faults.

LLDP-MED (LLDP for Media Endpoint Discovery) is an extension of LLDP and is used to advertise information between network devices and media endpoints. It is specially used together with Auto VoIP (Voice over Internet Protocol) to allow VoIP device to access the network. VoIP devices can use LLDP-MED for auto-configuration to minimize the configuration effort.

## 1.2 Supported Features

The switch supports LLDP and LLDP-MED.

LLDP allows the local device to encapsulate its management address, device ID, interface ID and other information into a LLDPDU (Link Layer Discovery Protocol Data Unit) and periodically advertise this LLDPDU to its neighbor devices. The neighbors store the received LLDPDU in a standard MIB (Management Information Base), making it possible for the information to be accessed by a NMS (Network Management System) using a management protocol such as the SNMP (Simple Network Management Protocol).

LLDP-MED allows the network device to send its information including Auto VoIP information, PoE (Power over Ethernet) capacity and more to the media endpoint devices (for example, IP phones) for auto-configuration. The media endpoint devices receive the Auto VoIP information and finish the auto-configuration, then send the voice traffic with the desired configuration, which can provide preferential treatment to the voice traffic.

# 2 LLDP Configurations

To configure LLDP function, follow the steps:

- 1) Configure the LLDP feature globally.
- 2) Configure the LLDP feature for the port.

## 2.1 Using the GUI

### 2.1.1 Configuring LLDP Globally

Choose the **L2 FEATURES > LLDP > LLDP Config > Global Config** to load the following page.

Figure 2-1 Global Config

| Global Config            |                                 |                   |
|--------------------------|---------------------------------|-------------------|
| LLDP:                    | <input type="checkbox"/>        | Enable            |
| LLDP Forwarding:         | <input type="checkbox"/>        | Enable            |
| <a href="#">Apply</a>    |                                 |                   |
| Parameter Config         |                                 |                   |
| Transmit Interval:       | <input type="text" value="30"/> | seconds (5-32768) |
| Hold Multiplier:         | <input type="text" value="4"/>  | (2-10)            |
| Transmit Delay:          | <input type="text" value="2"/>  | seconds (1-8192)  |
| Reinitialization Delay:  | <input type="text" value="2"/>  | seconds (1-10)    |
| Notification Interval:   | <input type="text" value="5"/>  | seconds (5-3600)  |
| Fast Start Repeat Count: | <input type="text" value="3"/>  | (1-10)            |
| <a href="#">Apply</a>    |                                 |                   |

Follow these steps to configure the LLDP feature globally.

- 1) In the **Global Config** section, enable LLDP. You can also enable the switch to forward LLDP messages when LLDP function is disabled. Click **Apply**.

|                 |   |
|-----------------|---|
| LLDP            | Enable LLDP function globally.  |
| LLDP Forwarding | (Optional) Enable the switch to forward LLDP messages when LLDP function is disabled. |

- 3) In the **Parameter Config** section, configure the LLDP parameters. Click **Apply**.

|                         |  |
|-------------------------|--|
| Transmit Interval       | Enter the interval between successive LLDP packets that are periodically sent from the local device to its neighbors. The default is 30 seconds.   |
| Hold Multiplier         | This parameter is a multiplier on the Transmit Interval that determines the actual TTL (Time To Live) value used in an LLDP packet. TTL is the duration that the neighbor device should hold the received LLDP packet before discarding it. The default value is 4.<br><br>TTL= Hold Multiplier * Transmit Interval.   |
| Transmit Delay          | Specify the amount of delay from when Admin Status of ports becomes "Disable" until reinitialization will be attempted. The default value is 2 seconds.  |
| Reinitialization Delay  | Specify the amount of delay from when Admin Status of ports becomes "Disable" until reinitialization will be attempted. The default value is 2 seconds.  |
| Notification Interval   | Enter the interval between successive in seconds Trap messages that are periodically sent from the local device to the NMS. The default value is 5.  |
| Fast Start Repeat Count | Specify the number of LLDP packets that the local port sends when its Admin Status changes from Disable (or Rx_Only) to Tx&RX (or Tx_Only). The default value is 3.<br><br>In this case, the local device will shorten the Transmit Interval of LLDP packets to 1 second to make it quickly discovered by its neighbors. After the specified number of LLDP packets are sent, the Transmit Interval will be restored to the specified value. |

## 2.1.2 Configuring LLDP For the Port

Choose the menu **L2 FEATURES > LLDP > LLDP Config > Port Config** to load the following page.

Figure 2-2 Port Config

Port Config

| UNIT1                               |        | Admin Status | Notification Mode | Management Address | Included TLVs                       |                                     |                                     |                                     |                                     |                                     |                                     |                                     |                                     |                                     |                                     |                                     |                                     |
|-------------------------------------|--------|--------------|-------------------|--------------------|-------------------------------------|-------------------------------------|-------------------------------------|-------------------------------------|-------------------------------------|-------------------------------------|-------------------------------------|-------------------------------------|-------------------------------------|-------------------------------------|-------------------------------------|-------------------------------------|-------------------------------------|
| <input type="checkbox"/>            | Port   |              |                   |                    | <input checked="" type="checkbox"/> | <input checked="" type="checkbox"/> | <input checked="" type="checkbox"/> | <input checked="" type="checkbox"/> | <input checked="" type="checkbox"/> | <input checked="" type="checkbox"/> | <input checked="" type="checkbox"/> | <input checked="" type="checkbox"/> | <input checked="" type="checkbox"/> | <input checked="" type="checkbox"/> | <input checked="" type="checkbox"/> | <input checked="" type="checkbox"/> | <input checked="" type="checkbox"/> |
| <input checked="" type="checkbox"/> | 1/0/1  | Tx & Rx      | Disabled          |                    | PD                                  | SC                                  | SD                                  | SN                                  | SA                                  | PV                                  | VP                                  | VA                                  | LA                                  | PS                                  | FS                                  | PW                                  |                                     |
| <input type="checkbox"/>            | 1/0/2  | Tx & Rx      | Disabled          |                    | PD                                  | SC                                  | SD                                  | SN                                  | SA                                  | PV                                  | VP                                  | VA                                  | LA                                  | PS                                  | FS                                  | PW                                  |                                     |
| <input type="checkbox"/>            | 1/0/3  | Tx & Rx      | Disabled          |                    | PD                                  | SC                                  | SD                                  | SN                                  | SA                                  | PV                                  | VP                                  | VA                                  | LA                                  | PS                                  | FS                                  | PW                                  |                                     |
| <input type="checkbox"/>            | 1/0/4  | Tx & Rx      | Disabled          |                    | PD                                  | SC                                  | SD                                  | SN                                  | SA                                  | PV                                  | VP                                  | VA                                  | LA                                  | PS                                  | FS                                  | PW                                  |                                     |
| <input type="checkbox"/>            | 1/0/5  | Tx & Rx      | Disabled          |                    | PD                                  | SC                                  | SD                                  | SN                                  | SA                                  | PV                                  | VP                                  | VA                                  | LA                                  | PS                                  | FS                                  | PW                                  |                                     |
| <input type="checkbox"/>            | 1/0/6  | Tx & Rx      | Disabled          |                    | PD                                  | SC                                  | SD                                  | SN                                  | SA                                  | PV                                  | VP                                  | VA                                  | LA                                  | PS                                  | FS                                  | PW                                  |                                     |
| <input type="checkbox"/>            | 1/0/7  | Tx & Rx      | Disabled          |                    | PD                                  | SC                                  | SD                                  | SN                                  | SA                                  | PV                                  | VP                                  | VA                                  | LA                                  | PS                                  | FS                                  | PW                                  |                                     |
| <input type="checkbox"/>            | 1/0/8  | Tx & Rx      | Disabled          |                    | PD                                  | SC                                  | SD                                  | SN                                  | SA                                  | PV                                  | VP                                  | VA                                  | LA                                  | PS                                  | FS                                  | PW                                  |                                     |
| <input type="checkbox"/>            | 1/0/9  | Tx & Rx      | Disabled          |                    | PD                                  | SC                                  | SD                                  | SN                                  | SA                                  | PV                                  | VP                                  | VA                                  | LA                                  | PS                                  | FS                                  | PW                                  |                                     |
| <input type="checkbox"/>            | 1/0/10 | Tx & Rx      | Disabled          |                    | PD                                  | SC                                  | SD                                  | SN                                  | SA                                  | PV                                  | VP                                  | VA                                  | LA                                  | PS                                  | FS                                  | PW                                  |                                     |
| Total: 28                           |        |              |                   | 1 entry selected.  |                                     |                                     |                                     |                                     |                                     |                                     |                                     |                                     |                                     |                                     |                                     | Cancel                              | Apply                               |

Follow these steps to configure the LLDP feature for the interface.

- 1) Select one or more ports to configure.
- 2) Configure the Admin Status and Notification Mode for the port.

|                           |   |
|---------------------------|---|
| <b>Admin Status</b>       | Set Admin Status for the port to deal with LLDP packets.<br><br>Tx&Rx: The port transmits LLDP packets and receives LLDP packets.<br><br>Rx_Only: The port only receives LLDP packets.<br><br>Tx_Only: The port only transmits LLDP packets.<br><br>Disable: The port will not transmit LLDP packets or drop the received LLDP packets. |
| <b>Notification Mode</b>  | (Optional) Enable the switch to send trap messages to the NMS when the information of the neighbor device connected to this port changes.   |
| <b>Management Address</b> | Specify the Management IP address of the port to be notified to the neighbor. Value 0.0.0.0 means the port will notify its default management address to the neighbor.  |

- 3) Select the TLVs (Type/Length/Value) included in the LLDP packets according to your needs.

---

|                      |   |
|----------------------|---|
| <b>Included TLVs</b> | <p>Configure the TLVs included in the outgoing LLDP packets.</p> <p>The switch supports the following TLVs:</p> <p>PD: Used to advertise the port description defined by the IEEE 802 LAN station.</p> <p>SC: Used to advertise the supported functions and whether or not these functions are enabled.</p> <p>SD: Used to advertise the system's description including the full name and version identification of the system's hardware type, software operating system, and networking software.</p> <p>SN: Used to advertise the system name.</p> <p>SA: Used to advertise the local device's management address to make it possible to be managed by SNMP.</p> <p>PV: Used to advertise the 802.1Q VLAN ID of the port.</p> <p>VP: Used to advertise the protocol VLAN ID of the port.</p> <p>VA: Used to advertise the name of the VLAN which the port is in.</p> <p>LA: Used to advertise whether the link is capable of being aggregated, whether the link is currently in an aggregation, and the port ID when it is in an aggregation.</p> <p>PS: Used to advertise the port's attributes including the duplex and bit-rate capability of the sending IEEE 802.3 LAN node that is connected to the physical medium, the current duplex and bit-rate settings of the sending IEEE 802.3 LAN node and whether these settings are the result of auto-negotiation during link initiation or of manual set override action.</p> <p>FS: Used to advertise the maximum frame size capability of the implemented MAC and PHY.</p> <p>PW: Used to advertise the port's PoE (Power over Ethernet) support capabilities.</p> |
|----------------------|---|

---

4) Click **Apply**.

## 2.2 Using the CLI

### 2.2.1 Global Config

Enable the LLDP feature on the switch and configure the LLDP parameters.

---

|        |   |
|--------|---|
| Step 1 | <b>configure</b><br>Enter global configuration mode.  |
| Step 2 | <b>lldp</b><br>Enable the LLDP feature on the switch. |

---

|        |   |
|--------|---|
| Step 3 | <p><b>lldp forward_message</b></p> <p>(Optional) Enable the switch to forward LLDP messages when LLDP function is disabled.</p>   |
| Step 4 | <p><b>lldp hold-multiplier multiplier</b></p> <p>(Optional) Specify the amount of time the neighbor device should hold the received information before discarding it. This parameter is a multiplier on the Transmit Interval that determines the actual TTL (Time To Live) value used in an LLDP packet. TTL is the duration that the neighbor device should hold the received LLDP packet before discarding it.</p> <p>TTL= Hold Multiplier * Transmit Interval.</p> <p><i>multiplier</i>: Specify the hold-multiplier. The valid value ranges from 2 to 10, and the default value is 4.</p>  |
| Step 5 | <p><b>lldp timer { tx-interval tx-interval   tx-delay tx-delay   reinit-delay reinit-delay   notify-interval notify-interval   fast-count fast-count }</b></p> <p>(Optional) Configure the timers for LLDP packet forwarding.</p> <p><i>tx-interval</i>: Enter the interval between successive LLDP packets that are periodically sent from the local device to its neighbors.</p> <p><i>tx-delay</i>: Specify the amount of time that the local device waits before sending another LLDP packet to its neighbors. The default is 2 seconds.</p> <p><i>reinit-delay</i>: Specify the amount of time that the local device waits before sending another LLDP packet to its neighbors. The default is 2 seconds.</p> <p><i>notify-interval</i>: Enter the interval between successive Trap messages that are periodically sent from the local device to the NMS. The default is 5 seconds.</p> <p><i>fast-count</i>: Specify the number of packets that the local port sends when its Admin Status changes. The default is 3.</p> |
| Step 6 | <p><b>show lldp</b></p> <p>Display the LLDP information.</p>  |
| Step 7 | <p><b>end</b></p> <p>Return to Privileged EXEC Mode.</p>  |
| Step 8 | <p><b>copy running-config startup-config</b></p> <p>Save the settings in the configuration file.</p>  |

The following example shows how to configure the following parameters, lldp timer=4, tx-interval=30 seconds, tx-delay=2 seconds, reinit-delay=3 seconds, notify-interval=5 seconds, fast-count=3.

```
Switch#configure
```

```
Switch(config)#lldp
```

```
Switch(config)#lldp hold-multiplier 4
```

```
Switch(config)#lldp timer tx-interval 30
```



```

Switch(config)#lldp timer tx-delay 2
Switch(config)#lldp timer reinit-delay 3
Switch(config)#lldp timer notify-interval 5
Switch(config)#lldp timer fast-count 3
Switch(config)#show lldp
LLDP Status: Enabled
LLDP Forward Message: Disabled
Tx Interval: 30 seconds
TTL Multiplier: 4
Tx Delay: 2 seconds
Initialization Delay: 2 seconds
Trap Notification Interval: 5 seconds
Fast-packet Count: 3
LLDP-MED Fast Start Repeat Count: 4
Switch(config)#end
Switch#copy running-config startup-config

```

## 2.2.2 Port Config

Select the desired port and set its Admin Status, Notification Mode and the TLVs included in the LLDP packets.

|        |   |
|--------|---|
| Step 1 | <b>configure</b><br>Enter global configuration mode.  |
| Step 2 | <b>interface {fastEthernet port   range fastEthernet port-list   gigabitEthernet port   range gigabitEthernet port-list   ten-gigabitEthernet port   range ten-gigabitEthernet port-list }</b><br>Enter interface configuration mode. |
| Step 3 | <b>lldp receive</b><br>(Optional) Set the mode for the port to receive LLDP packets. It is enabled by default.  |
| Step 4 | <b>lldp transmit</b><br>(Optional) Set the mode for the port to send LLDP packets. It is enabled by default.  |
| Step 5 | <b>lldp snmp-trap</b><br>(Optional) Enable the Notification Mode feature on the port. If it is enabled, the local device will send trap messages to the NMS when neighbor information changed. It is disabled by default.             |

|        |   |
|--------|---|
| Step 6 | <b>lldp tlv-select</b><br>(Optional) Configure the TLVs included in the outgoing LLDP packets. By default, the outgoing LLDP packets include all TLVs.      |
| Step 7 | <b>show lldp interface { fastEthernet port   gigabitEthernet port   ten-gigabitEthernet port }</b><br>Display LLDP configuration of the corresponding port. |
| Step 8 | <b>end</b><br>Return to Privileged EXEC Mode.   |
| Step 9 | <b>copy running-config startup-config</b><br>Save the settings in the configuration file.   |

The following example shows how to configure the port 1/0/1. The port can receive and transmit LLDP packets, its notification mode is enabled and the outgoing LLDP packets include all TLVs.

**Switch#configure**

**Switch(config)#lldp**

**Switch(config)#interface gigabitEthernet 1/0/1**

**Switch(config-if)#lldp receive**

**Switch(config-if)#lldp transmit**

**Switch(config-if)#lldp snmp-trap**

**Switch(config-if)#lldp tlv-select all**

**Switch(config-if)#show lldp interface gigabitEthernet 1/0/1**

LLDP interface config:

gigabitEthernet 1/0/1:

Admin Status: TxRx

SNMP Trap: Enabled

| TLV | Status |
|-----|--------|
|-----|--------|

|     |       |
|-----|-------|
| --- | ----- |
|-----|-------|

|                  |     |
|------------------|-----|
| Port-Description | Yes |
|------------------|-----|

|                   |     |
|-------------------|-----|
| System-Capability | Yes |
|-------------------|-----|

|                    |     |
|--------------------|-----|
| System-Description | Yes |
|--------------------|-----|

|             |     |
|-------------|-----|
| System-Name | Yes |
|-------------|-----|

|                    |     |
|--------------------|-----|
| Management-Address | Yes |
|--------------------|-----|

|                  |     |
|------------------|-----|
| Port-VLAN-ID     | Yes |
| Protocol-VLAN-ID | Yes |
| VLAN-Name        | Yes |
| Link-Aggregation | Yes |
| MAC-Physic       | Yes |
| Max-Frame-Size   | Yes |
| Power            | Yes |

**Switch(config-if)#end**

**Switch#copy running-config startup-config**

# 3 LLDP-MED Configurations

To configure LLDP-MED function, follow the steps:

- 1) Enable LLDP feature globally and configure the LLDP parameters for the ports.
- 2) Configuring LLDP-MED fast repeat count globally.
- 3) Enable and configure the LLDP-MED feature on the port.

## Configuration Guidelines

LLDP-MED is used together with Auto VoIP to implement VoIP access. Besides the configuration of LLDP-MED feature, you also need configure the Auto VoIP feature. Refer to [Configuring QoS](#) for detailed instructions.

## 3.1 Using the GUI

### 3.1.1 Configuring LLDP Globally

Enable LLDP globally and configure the LLDP parameters for the ports. For the details of LLDP configuration, refer to [LLDP Configuration](#).

### 3.1.1 Configuring LLDP-MED Globally

Choose the menu **L2 FEATURES > LLDP Config > LLDP-MED Config > Global Config** to load the following page.

Figure 3-1 LLDP-MED Parameters Config

LLDP-MED Parameters Config

Fast Start Repeat Count:  (1-10)

Device Class: Network Connectivity

Apply

Configure the Fast Start Count and view the current device class. Click **Apply**.

|                                |   |
|--------------------------------|---|
| <b>Fast Start Repeat Count</b> | Specify the number of successive LLDP-MED packets that the switch sends when it receives the LLDP-MED packets from the neighbor endpoints. The default is 4.  |
|                                | If the switch receives LLDP-MED packets from the neighbor endpoints for the first time, it will send the specified number of LLDP-MED packets carrying LLDP-MED information. After that, the transmit interval will be restored to the specified value. |

|                     |   |
|---------------------|---|
| <b>Device Class</b> | Display the current device class.<br><br>LLDP-MED defines two device classes, Network Connectivity Device and Endpoint Device. The switch is a Network Connectivity device. |
|---------------------|---|

### 3.1.2 Configuring LLDP-MED for Ports

Choose the menu **L2 FEATURES > LLDP > LLDP-MED Config > Port Config** to load the following page.

Figure 3-2 LLDP-MED Port Config

The screenshot shows the 'Port Config' interface for 'UNIT1'. It features a table with columns for 'Port', 'LLDP-MED Status', and 'Included TLVs'. The first port, 1/0/1, is selected (checkbox checked) and its status is 'Disabled'. The other ports (1/0/2 to 1/0/10) are not selected and also have a status of 'Disabled'. Each row has a 'Detail' link. At the bottom, there are 'Cancel' and 'Apply' buttons, and a status bar indicating 'Total: 28' and '1 entry selected.'

| <input type="checkbox"/>            | Port   | LLDP-MED Status | Included TLVs          |
|-------------------------------------|--------|-----------------|------------------------|
| <input checked="" type="checkbox"/> | 1/0/1  | Disabled        | <a href="#">Detail</a> |
| <input type="checkbox"/>            | 1/0/2  | Disabled        | <a href="#">Detail</a> |
| <input type="checkbox"/>            | 1/0/3  | Disabled        | <a href="#">Detail</a> |
| <input type="checkbox"/>            | 1/0/4  | Disabled        | <a href="#">Detail</a> |
| <input type="checkbox"/>            | 1/0/5  | Disabled        | <a href="#">Detail</a> |
| <input type="checkbox"/>            | 1/0/6  | Disabled        | <a href="#">Detail</a> |
| <input type="checkbox"/>            | 1/0/7  | Disabled        | <a href="#">Detail</a> |
| <input type="checkbox"/>            | 1/0/8  | Disabled        | <a href="#">Detail</a> |
| <input type="checkbox"/>            | 1/0/9  | Disabled        | <a href="#">Detail</a> |
| <input type="checkbox"/>            | 1/0/10 | Disabled        | <a href="#">Detail</a> |

Total: 28      1 entry selected.      [Cancel](#)      [Apply](#)

Follow these steps to enable LLDP-MED:

- 1) Select the desired port and enable LLDP-MED. Click **Apply**.
- 2) Click **Detail** to enter the following page. Configure the TLVs included in the outgoing LLDP packets. If **Location Identification** is selected, you need configure the Emergency Number or select Civic Address to configure the details. Click **Apply**.

Figure 3-3 LLDP-MED Port Config-Detail

**Included TLVs Detail(Port:1/0/1)**

---

**Included TLVs**

All
  Network Policy
  Location Identification
  Extended Power-Via-MDI
  Inventory

---

**Location Identification Parameters**

Emergency Number
  Civic Address (Parameters in total should not exceed 230 characters in length)

What:

Country Code:

Language:

Province/State:

City/Township:

County/Parish/District:

Street:

House Number:

Name:

Postal/Zip Code:

Room Number:

|                                |   |
|--------------------------------|---|
| <b>Network Policy</b>          | Used to advertise VLAN configuration and the associated Layer 2 and Layer 3 attributes of the port to the endpoint devices.   |
| <b>Location Identification</b> | Used to assign the location identifier information to the Endpoint devices.<br><br>If this option is selected, you can configure the emergency number and the detailed address of the endpoint device in the Location Identification Parameters section.                    |
| <b>Extended Power-Via-MDI</b>  | Used to advertise the detailed PoE information including power supply priority and supply status between LLDP-MED Endpoint devices and Network Connectivity devices.  |
| <b>Inventory</b>               | Used to advertise the inventory information. The Inventory TLV set contains seven basic Inventory management TLVs, that is, Hardware Revision TLV, Firmware Revision TLV, Software Revision TLV, Serial Number TLV, Manufacturer Name TLV, Model Name TLV and Asset ID TLV. |
| <b>Emergency Number</b>        | Configure the emergency number to call CAMA or PSAP. The number should contain 10-25 characters.  |

---

|                      |  |
|----------------------|--|
| <b>Civic Address</b> | <p>Configure the address of the audio device in the IETF defined address format.</p> <p>What: Specify the role type of the local device, DHCP Server, Switch or LLDP-MED Endpoint.</p> <p>Country Code: Enter the country code defined by ISO 3166 , for example, CN, US.</p> <p>Language, Province/State etc.: Enter the regular details.</p> |
|----------------------|--|

---

## 3.2 Using the CLI

### 3.2.1 Global Config

---

|        |  |
|--------|--|
| Step 1 | <p><b>configure</b></p> <p>Enter global configuration mode.</p>  |
| Step 2 | <p><b>lldp</b></p> <p>Enable the LLDP feature on the switch.</p>   |
| Step 3 | <p><b>lldp med-fast-count count</b></p> <p>(Optional) Specify the number of successive LLDP-MED frames that the local device sends when fast start mechanism is activated. When the fast start mechanism is activated, the local device will send the specified number of LLDP packets carrying LLDP-MED information.</p> <p><i>count</i>: The valid value are from 1 to 10. The default is 4.</p> |
| Step 4 | <p><b>show lldp</b></p> <p>Display the LLDP information.</p>   |
| Step 5 | <p><b>end</b></p> <p>Return to Privileged EXEC Mode.</p>   |
| Step 6 | <p><b>copy running-config startup-config</b></p> <p>Save the settings in the configuration file.</p>   |

---

The following example shows how to configure LLDP-MED fast count as 4:

**Switch#configure**

**Switch(config)#lldp**

**Switch(config)#lldp med-fast-count 4**

**Switch(config)#show lldp**

LLDP Status: Enabled

Tx Interval: 30 seconds

|                                   |           |
|-----------------------------------|-----------|
| TTL Multiplier:                   | 4         |
| Tx Delay:                         | 2 seconds |
| Initialization Delay:             | 2 seconds |
| Trap Notification Interval:       | 5 seconds |
| Fast-packet Count:                | 3         |
| LLDP-MED Fast Start Repeat Count: | 4         |

**Switch(config)#end**

**Switch#copy running-config startup-config**

### 3.2.2 Port Config

Select the desired port, enable LLDP-MED and select the TLVs (Type/Length/Value) included in the outgoing LLDP packets according to your needs.

|        |   |
|--------|---|
| Step 1 | <p><b>configure</b></p> <p>Enter global configuration mode.</p>   |
| Step 2 | <p><b>interface {fastEthernet port   range fastEthernet port-list   gigabitEthernet port   range gigabitEthernet port-list   ten-gigabitEthernet port   range ten-gigabitEthernet port-list }</b></p> <p>Enter interface configuration mode.</p>  |
| Step 3 | <p><b>lldp med-status</b></p> <p>(Optional) Enable the LLDP-MED on the port. It is disabled by default.</p>   |
| Step 4 | <p><b>lldp med-tlv-select { [ inventory-management ] [ location ] [ network-policy ] [ power-management ] [ all ] }</b></p> <p>(Optional) Configure the LLDP-MED TLVs included in the outgoing LLDP packets. By default, the outgoing LLDP packets include all TLVs.</p> <p>If LLDP-MED Location TLV is selected, configure the parameters as follows:</p> <p><b>lldp med-location {emergency-number identifier   civic-address [language language   province-state province-state   lci-county-name county   lci-city city   street street   house-number house-number   name name   postal-zipcode postal-zipcode   room-number room-number   post-office-box post-office-box   additional additional   country-code country-code   what { dhcp-server   endpoint   switch } ] }</b></p> <p>Configure the LLDP-MED Location TLV included in the outgoing LLDP packets. Used to assign the location identifier information to the Endpoint devices.</p> <p><i>identifier</i>: Configure the emergency number to call CAMA or PSAP. The number should contain 10-25 characters.</p> <p><i>language, province-state, county.etc</i>: Configure the address in the IETF defined address format.</p> |
| Step 5 | <p><b>show lldp interface { fastEthernet port   gigabitEthernet port   ten-gigabitEthernet port }</b></p> <p>Display LLDP configuration of the corresponding port.</p>  |



- 
- Step 6      **end**  
Return to Privileged EXEC Mode.
- 
- Step 7      **copy running-config startup-config**  
Save the settings in the configuration file.
- 

The following example shows how to enable LLDP-MED on port 1/0/1, configure the LLDP-MED TLVs included in the outgoing LLDP packets.

**Switch(config)#lldp**

**Switch(config)#lldp med-fast-count 4**

**Switch(config)#interface gigabitEthernet 1/0/1**

**Switch(config-if)#lldp med-status**

**Switch(config-if)#lldp med-tlv-select all**

**Switch(config-if)#show lldp interface gigabitEthernet 1/0/1**

LLDP interface config:

gigabitEthernet 1/0/1:

Admin Status: TxRx

SNMP Trap: Enabled

TLV Status

--- -----

Port-Description                      Yes

System-Capability                      Yes

System-Description                      Yes

System-Name                              Yes

Management-Address Yes

Port-VLAN-ID Yes

Protocol-VLAN-ID Yes

VLAN-Name Yes

Link-Aggregation Yes

MAC-Physic Yes

Max-Frame-Size                          Yes

Power                                        Yes

LLDP-MED Status: Enabled

TLV Status

--- -----

Network Policy Yes

Location Identification Yes

Extended Power Via MDI Yes

Inventory Management Yes

**Switch(config)#end**

**Switch#copy running-config startup-config**

# 4 Viewing LLDP Settings

This chapter introduces how to view the LLDP settings on the local device.

## 4.1 Using GUI

### 4.1.1 Viewing LLDP Device Info

#### ■ Viewing the Local Info

Choose the menu **L2 FEATURES > LLDP > LLDP Config > Local Info** to load the following page.

Figure 4-1 Local Info

Auto Refresh

Auto Refresh:  Enable Apply

Local Info

UNIT1

2

4

6

8

10

12

14

16

18

20

22

24

26

28

1

3

5

7

9

11

13

15

17

19

21

23

25

27

Selected

Unselected

Not Available

| Port 1/0/10                    |   |
|--------------------------------|---|
| Local Interface:               | 1/0/10  |
| Chassic ID Subtype:            | MAC address   |
| Chassic ID:                    | 00-0A-EB-13-A2-11   |
| Port ID Subtype:               | Interface name  |
| Port ID:                       | FastEthernet1/0/10  |
| TTL:                           | 120   |
| Port Description:              | FastEthernet1/0/10 Interface                                    |
| System Name:                   | T1500-28PCT   |
| System Description:            | JetStream 24-Port 10/100Mbps + 4-Port Gigabit Smart PoE+ Switch |
| System Capabilities Supported: | Bridge  |
| System Capabilities Enabled:   | Bridge  |
| Management Address Type:       | IPv4  |
| Management Address:            | 192.168.0.150   |

Follow these steps to view the local information:

- 1) In the **Auto Refresh** section, enable the Auto Refresh feature and set the Refresh Rate according to your needs. Click **Apply**.
- 2) In the **Local Info** section, select the desired port and view its associated local device information.

|                                   |  |
|-----------------------------------|--|
| Local Interface                   | Displays the local port ID.  |
| Chassis ID Subtype                | Displays the Chassis ID type.  |
| Chassis ID                        | Displays the value of the Chassis ID.  |
| Port ID Subtype                   | Displays the Port ID type.   |
| Port ID                           | Displays the value of the Port ID.   |
| TTL                               | Specify the amount of time in seconds the neighbor device should hold the received information before discarding it.           |
| Port Description                  | Displays the description of the local port.  |
| System Name                       | Displays the system name of the local device.  |
| System Description                | Displays the system description of the local device.   |
| System Capabilities Supported     | Displays the supported capabilities of the local system.   |
| System Capabilities Enabled       | Displays the primary functions of the local device.  |
| Management Address Type           | Displays the management IP address type of the local device.   |
| Management Address                | Displays the management IP address of the local device.  |
| Management Address Interface Type | Displays the interface numbering type that is used to define the interface ID.   |
| Management Address Interface ID   | Displays the interface ID that is used to identify the specific interface associated with the MAC address of the local device. |
| Management Address OID            | Displays the OID (Object Identifier) of the local device. A value of 0 means that the OID is not provided.                     |
| Port VLAN ID(PVID)                | Displays the PVID of the local port.   |
| Port And Protocol VLAN ID(PPVID)  | Displays the PPVID of the local port.  |

|                                |  |
|--------------------------------|--|
| Port And Protocol Supported    | Displays whether the local device supports port and protocol VLAN feature.           |
| Port And Protocol VLAN Enabled | Displays the status of the port and protocol VLAN feature.                           |
| VLAN Name of VLAN 1            | Displays the VLAN name of VLAN 1 for the local device.                               |
| Protocol Identify              | Displays the particular protocol that the local device wants to advise.              |
| Auto-negotiation Supported     | Displays whether the local device supports auto-negotiation.                         |
| Auto-Negotiation Enable        | Displays the status of auto-negotiation for the local device.                        |
| OperMau                        | Displays the OperMau (Optional Mau) field of the TLV configured by the local device. |
| Link Aggregation Supported     | Displays whether the local device supports link aggregation.                         |
| Link Aggregation Enabled       | Displays the status of link aggregation for the local device.                        |
| Aggregation Port ID            | Displays the aggregation port ID of the local device.                                |
| Power Port Class               | Displays the power port class of the local device.                                   |
| PSE Power Supported            | Displays whether the local device supports PSE power.                                |
| PSE Power Enabled              | Displays the status of PSE power for the local device.                               |
| PSE Pairs Control Ability      | Displays whether the PSE pairs can be controlled for the local device.               |
| Maximum Frame Size             | Displays the maximum frame size supported by the local device.                       |

## ■ Viewing the Neighbor Info

Choose the menu **L2 FEATURES > LLDP > LLDP Config > Neighbor Info** to load the following page.

Figure 4-2 Neighbor Info

Auto Refresh

Auto Refresh:  Enable Apply

---

Neighbor Info

UNIT1

2

4

6

8

10

12

14

16

18

20

22

24

26

28

1

3

5

7

9

11

13

15

17

19

21

23

25

27

Selected

Unselected

Not Available

| Port 1/0/1                |            |                    |               |             |
|---------------------------|------------|--------------------|---------------|-------------|
| System Name               | Chassis ID | System Description | Neighbor Port | Information |
| No entries in this table. |            |                    |               |             |

Follow these steps to view the neighbor information:

- 1) In the **Auto Refresh** section, enable the Auto Refresh feature and set the Refresh Rate according to your needs. Click **Apply**.
- 2) In the **Neighbor Info** section, select the desired port and view its associated neighbor device information.

|                           |   |
|---------------------------|---|
| <b>System Name</b>        | Displays the system name of the neighbor device.                                  |
| <b>Chassis ID</b>         | Displays the Chassis ID of the neighbor device.                                   |
| <b>System Description</b> | Displays the system description of the neighbor device.                           |
| <b>Neighbor Port</b>      | Displays the port ID of the neighbor device which is connected to the local port. |
| <b>Information</b>        | Click to view the details of the neighbor device.                                 |

## 4.1.2 Viewing LLDP Statistics

Choose the menu **L2 FEATURES > LLDP > LLDP Config > Statistics Info** to load the following page.

Figure 4-3 Static Info

**Auto Refresh**

Auto Refresh:  Enable Apply

---

**Global Statistics**

| Last Update        | Total Inserts | Total Deletes | Total Drops | Total Age-outs |
|--------------------|---------------|---------------|-------------|----------------|
| 2 days 18h:25m:00s | 1             | 0             | 0           | 0              |

---

**Neighbor Statistics**

UNIT1

↻ Refresh
 ✕ Clear

| Port      | Transmit Total | Receive Total | Discards | Errors | Age-outs | Discarded TLVs | Unknown TLVs |
|-----------|----------------|---------------|----------|--------|----------|----------------|--------------|
| 1/0/1     | 0              | 0             | 0        | 0      | 0        | 0              | 0            |
| 1/0/2     | 0              | 0             | 0        | 0      | 0        | 0              | 0            |
| 1/0/3     | 0              | 0             | 0        | 0      | 0        | 0              | 0            |
| 1/0/4     | 0              | 0             | 0        | 0      | 0        | 0              | 0            |
| 1/0/5     | 0              | 0             | 0        | 0      | 0        | 0              | 0            |
| 1/0/6     | 0              | 0             | 0        | 0      | 0        | 0              | 0            |
| 1/0/7     | 0              | 0             | 0        | 0      | 0        | 0              | 0            |
| 1/0/8     | 0              | 0             | 0        | 0      | 0        | 0              | 0            |
| 1/0/9     | 0              | 0             | 0        | 0      | 0        | 0              | 0            |
| 1/0/10    | 3948           | 3939          | 0        | 0      | 0        | 0              | 0            |
| Total: 28 |                |               |          |        |          |                |              |

Follow these steps to view LLDP statistics:

- 1) In the **Auto Refresh** section, enable the Auto Refresh feature and set the Refresh Rate according to your needs. Click **Apply**.
- 2) In the **Global Statistics** section, view the global statistics of the local device.

|                      |   |
|----------------------|---|
| <b>Last Update</b>   | Displays the time when the statistics updated.  |
| <b>Total Inserts</b> | Displays the total number of neighbors during latest update time.   |
| <b>Total Deletes</b> | Displays the number of neighbors deleted by the local device. The port will delete neighbors when the port is disabled or the TTL of the LLDP packets sent by the neighbor is 0.            |
| <b>Total Drops</b>   | Displays the number of neighbors dropped by the local device. Each port can learn a maximum of 80 neighbor device, and the subsequent neighbors will be dropped when the limit is exceeded. |

---

|                |   |
|----------------|---|
| Total Age-outs | Displays the latest number of neighbors that have aged out on the local device. |
|----------------|---|

---

3) In the **Neighbors Statistics** section, view the statistics of the corresponding port.

---

|                |  |
|----------------|--|
| Transmit Total | Displays the total number of the LLDP packets sent via the port. |
|----------------|--|

---

|               |  |
|---------------|--|
| Receive Total | Displays the total number of the LLDP packets received via the port. |
|---------------|--|

---

|          |  |
|----------|--|
| Discards | Displays the total number of the LLDP packets discarded by the port. |
|----------|--|

---

|        |  |
|--------|--|
| Errors | Displays the total number of the error LLDP packets received via the port. |
|--------|--|

---

|          |   |
|----------|---|
| Age-outs | Displays the number of the aged out neighbors that are connected to the port. |
|----------|---|

---

|              |  |
|--------------|--|
| TLV Discards | Displays the total number of the TLVs discarded by the port when receiving LLDP packets. |
|--------------|--|

---

|              |  |
|--------------|--|
| TLV Unknowns | Displays the total number of the unknown TLVs included in the received LLDP packets. |
|--------------|--|

---

## 4.2 Using CLI

### ■ Viewing the Local Info

---

```
show lldp local-information interface { fastEthernet port | gigabitEthernet port | ten-gigabitEthernet port }
```

View the LLDP details of a specific port or all the ports on the local device.

---

### ■ Viewing the Neighbor Info

---

```
show lldp neighbor-information interface { fastEthernet port | gigabitEthernet port | ten-gigabitEthernet port }
```

Display the information of the neighbor device which is connected to the port.

---

### ■ Viewing LLDP Statistics

---

```
show lldp traffic interface { fastEthernet port | gigabitEthernet port | ten-gigabitEthernet port }
```

View the statistics of the corresponding port on the local device.

---



# 5 Viewing LLDP-MED Settings

## 5.1 Using GUI

Choose the menu **L2 FEATURES > LLDP > LLDP-MED Config > Local Info** to load the following page.

- Viewing the Local Info

Figure 5-1 LLDP-MED Local Info

Auto Refresh

Auto Refresh:  Enable

Apply

Local Info

UNIT1

2

4

6

8

10

12

14

16

18

20

22

24

26

28

1

3

5

7

9

11

13

15

17

19

21

23

25

27

Selected

Unselected

Not Available

Port 1/0/10

|                                |                      |
|--------------------------------|----------------------|
| Local Interface:               | 1/0/10               |
| Device Type:                   | Network Connectivity |
| Application Type:              | Reserved             |
| Unknown Policy Flag:           | Yes                  |
| VLAN tagged:                   | 0                    |
| Media Policy VLAN ID:          | 0                    |
| Media Policy Layer 2 Priority: | 0                    |
| Media Policy DSCP:             | 0                    |
| Location Data Format:          | Civic Address LCI    |
| What:                          | Switch               |
| Country Code:                  | CN China(Default)    |
| Power Type:                    | PSE Device           |
| Power Source:                  | Primary              |
| Power Priority:                | Low                  |
| Power Value:                   | 30                   |
| Hardware Revision:             | T1500-28PCT 3.0      |

User Guide ■ 382

Follow these steps to view LLDP-MED local information:

- 1) In the **Auto Refresh** section, enable the Auto Refresh feature and set the Refresh Rate according to your needs. Click **Apply**.
- 2) In the **LLDP-MED Local Info** section, select the desired port and view the LLDP-MED settings.

|                               |   |
|-------------------------------|---|
| Local Interface               | Displays the local port ID.   |
| Device Type                   | Displays the local device type defined by LLDP-MED.LLDP-MED.  |
| Application Type              | Displays the supported applications of the local device.  |
| Unknown Policy Flag           | Displays the unknown location settings included in the network policy TLV.  |
| VLAN tagged                   | Displays the VLAN Tag type of the applications, tagged or untagged.   |
| Media Policy VLAN ID          | Displays the 802.1Q VLAN ID of the port.  |
| Media Policy Layer 2 Priority | Displays the Layer 2 priority used in the specific application.   |
| Media Policy DSCP             | Displays the DSCP value used in the specific application.   |
| Location Data Format          | Displays the Location ID data format of the local device.   |
| What                          | Displays the type of the local device.  |
| Country Code                  | Displays the country code of the local device.  |
| Power Type                    | Displays the whether the local device is a PSE device or PD device.   |
| Power Source                  | Displays the power source of the local device.  |
| Power Priority                | Displays the power priority of the local device, which represents the priority of power that is received by the PD devices, or the priority of power that the PSE devices supply. |
| Power Value                   | Displays the power required by the PD device or supplied by the PSE device.   |
| Hardware Revision             | Displays the hardware revision of the local device.   |
| Firmware Revision             | Displays the firmware revision of the local device.   |
| Software Revision             | Displays the software revision of the local device.   |

|                   |   |
|-------------------|---|
| Serial Number     | Displays the serial number of the local device.     |
| Manufacturer Name | Displays the manufacturer name of the local device. |
| Model Name        | Displays the model name of the local device.        |
| Asset ID          | Displays the asset ID of the local device.          |

■ Viewing the Neighbor Info

Choose the menu **L2 FEATURES > LLDP > LLDP-MED Config > Neighbor Info** to load the following page.

Figure 5-2 LLDP-MED Neighbor Info

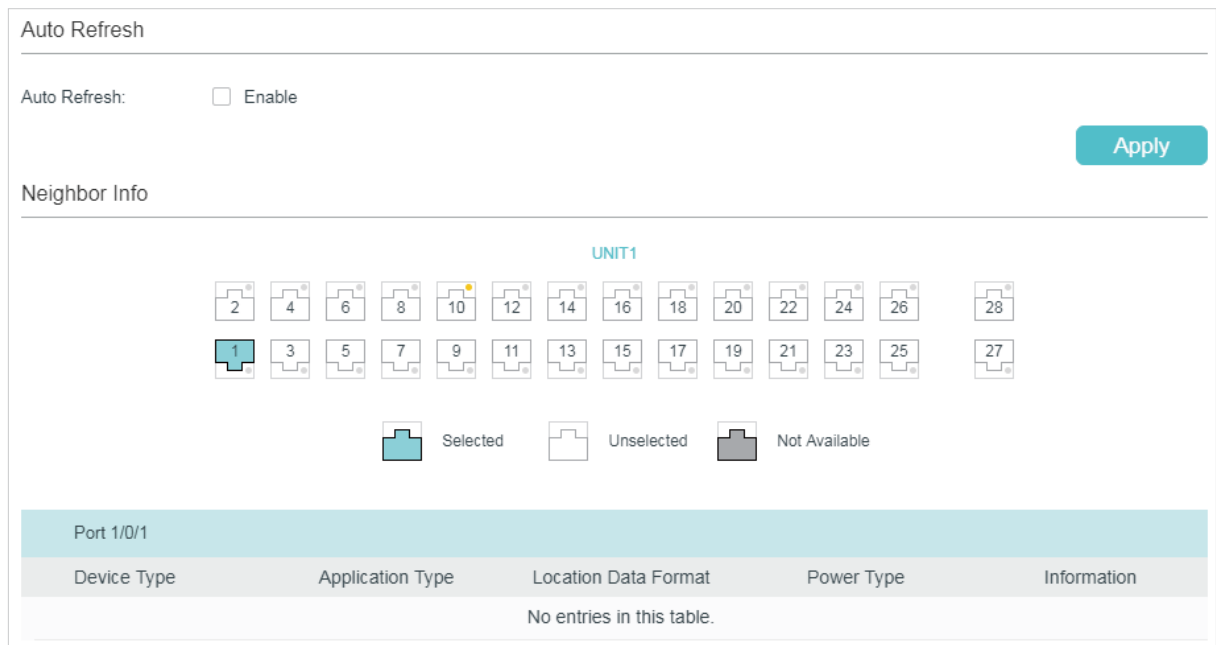

Follow these steps to view LLDP-MED neighbor information:

- 1) In the **Auto Refresh** section, enable the Auto Refresh feature and set the Refresh Rate according to your needs. Click **Apply**.
- 2) In the **Neighbor Info** section, select the desired port and view the LLDP-MED settings.

|                      |   |
|----------------------|---|
| Device Type          | Displays the LLDP-MED device type of the neighbor device. |
| Application Type     | Displays the application type of the neighbor device.     |
| Location Data Format | Displays the location type of the neighbor device.        |
| Power Type           | Displays the power type of the neighbor device.           |
| Information          | View more LLDP-MED details of the neighbor device.        |

## 5.2 Using CLI

### ■ Viewing the Local Info

---

```
show lldp local-information interface { fastEthernet port | gigabitEthernet port | ten-gigabitEthernet port }
```

View the LLDP details of a specific port or all the ports on the local device.

---

### ■ Viewing the Neighbor Info

---

```
show lldp neighbor-information interface { fastEthernet port | gigabitEthernet port | ten-gigabitEthernet port }
```

Display the information of the neighbor device which is connected to the port.

---

### ■ Viewing LLDP Statistics

---

```
show lldp traffic interface { fastEthernet port | gigabitEthernet port | tengigabitEthernet port }
```

View the statistics of the corresponding port.

---

# 6 Configuration Example

## 6.1 Network Requirements

The network administrator needs view the information of the devices in the company network to know about the link situation and network topology so that he can troubleshoot the potential network faults in advance.

## 6.2 Network Topology

Exemplified with the following situation:

Port Fa1/0/1 on Switch A is directly connected to port Fa1/0/2 on Switch B. Switch B is directly connected to the PC. The administrator can view the device information using the NMS.

Figure 6-1 LLDP Network Topology

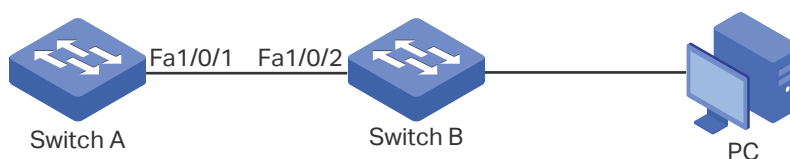

## 6.3 Configuration Scheme

LLDP can meet the network requirements. Enable the LLDP feature globally on Switch A and Switch B. Configure the related LLDP parameters on the corresponding ports.

Configuring Switch A and Switch B:

The configurations of Switch A and Switch B are similar. The following introductions take Switch A as an example. Demonstrated with T1500-28PCT, this chapter provides configuration procedures in two ways: using the GUI and using the CLI.

## 6.4 Using the GUI

- 1) Choose the menu **L2 FEATURES > LLDP > LLDP Config > Global Config** to load the following page. Enable LLDP globally and configure the related parameters. Here we take the default settings as an example.

Figure 6-2 LLDP Global Config

**Global Config**

---

LLDP:  **Enable**

LLDP Forwarding:  Enable

---

**Parameter Config**

Transmit Interval:  seconds (5-32768)

Hold Multiplier:  (2-10)

Transmit Delay:  seconds (1-8192)

Reinitialization Delay:  seconds (1-10)

Notification Interval:  seconds (5-3600)

Fast Start Repeat Count:  (1-10)

- Choose the menu **L2 FEATURES > LLDP > LLDP Config > Port Config** to load the following page. Set the Admin Status of port Fa1/0/1 as Tx&Rx, enable Notification Mode and configure all the TLVs included in the outgoing LLDP packets.

Figure 6-3 LLDP Port Config

**Port Config**

UNIT1

| <input type="checkbox"/>            | Port   | Admin Status | Notification Mode | Included TLVs                       |                                     |                                     |                                     |                                     |                                     |                                     |                                     |                                     |                                     |                                     |                                     |                                     |
|-------------------------------------|--------|--------------|-------------------|-------------------------------------|-------------------------------------|-------------------------------------|-------------------------------------|-------------------------------------|-------------------------------------|-------------------------------------|-------------------------------------|-------------------------------------|-------------------------------------|-------------------------------------|-------------------------------------|-------------------------------------|
| <input checked="" type="checkbox"/> | 1/0/1  | Tx & Rx      | Enabled           | <input checked="" type="checkbox"/> | <input checked="" type="checkbox"/> | <input checked="" type="checkbox"/> | <input checked="" type="checkbox"/> | <input checked="" type="checkbox"/> | <input checked="" type="checkbox"/> | <input checked="" type="checkbox"/> | <input checked="" type="checkbox"/> | <input checked="" type="checkbox"/> | <input checked="" type="checkbox"/> | <input checked="" type="checkbox"/> | <input checked="" type="checkbox"/> | <input checked="" type="checkbox"/> |
| <input type="checkbox"/>            | 1/0/2  | Tx & Rx      | Disabled          | <input type="checkbox"/>            | <input type="checkbox"/>            | <input type="checkbox"/>            | <input type="checkbox"/>            | <input type="checkbox"/>            | <input type="checkbox"/>            | <input type="checkbox"/>            | <input type="checkbox"/>            | <input type="checkbox"/>            | <input type="checkbox"/>            | <input type="checkbox"/>            | <input type="checkbox"/>            | <input type="checkbox"/>            |
| <input type="checkbox"/>            | 1/0/3  | Tx & Rx      | Disabled          | <input type="checkbox"/>            | <input type="checkbox"/>            | <input type="checkbox"/>            | <input type="checkbox"/>            | <input type="checkbox"/>            | <input type="checkbox"/>            | <input type="checkbox"/>            | <input type="checkbox"/>            | <input type="checkbox"/>            | <input type="checkbox"/>            | <input type="checkbox"/>            | <input type="checkbox"/>            | <input type="checkbox"/>            |
| <input type="checkbox"/>            | 1/0/4  | Tx & Rx      | Disabled          | <input type="checkbox"/>            | <input type="checkbox"/>            | <input type="checkbox"/>            | <input type="checkbox"/>            | <input type="checkbox"/>            | <input type="checkbox"/>            | <input type="checkbox"/>            | <input type="checkbox"/>            | <input type="checkbox"/>            | <input type="checkbox"/>            | <input type="checkbox"/>            | <input type="checkbox"/>            | <input type="checkbox"/>            |
| <input type="checkbox"/>            | 1/0/5  | Tx & Rx      | Disabled          | <input type="checkbox"/>            | <input type="checkbox"/>            | <input type="checkbox"/>            | <input type="checkbox"/>            | <input type="checkbox"/>            | <input type="checkbox"/>            | <input type="checkbox"/>            | <input type="checkbox"/>            | <input type="checkbox"/>            | <input type="checkbox"/>            | <input type="checkbox"/>            | <input type="checkbox"/>            | <input type="checkbox"/>            |
| <input type="checkbox"/>            | 1/0/6  | Tx & Rx      | Disabled          | <input type="checkbox"/>            | <input type="checkbox"/>            | <input type="checkbox"/>            | <input type="checkbox"/>            | <input type="checkbox"/>            | <input type="checkbox"/>            | <input type="checkbox"/>            | <input type="checkbox"/>            | <input type="checkbox"/>            | <input type="checkbox"/>            | <input type="checkbox"/>            | <input type="checkbox"/>            | <input type="checkbox"/>            |
| <input type="checkbox"/>            | 1/0/7  | Tx & Rx      | Disabled          | <input type="checkbox"/>            | <input type="checkbox"/>            | <input type="checkbox"/>            | <input type="checkbox"/>            | <input type="checkbox"/>            | <input type="checkbox"/>            | <input type="checkbox"/>            | <input type="checkbox"/>            | <input type="checkbox"/>            | <input type="checkbox"/>            | <input type="checkbox"/>            | <input type="checkbox"/>            | <input type="checkbox"/>            |
| <input type="checkbox"/>            | 1/0/8  | Tx & Rx      | Disabled          | <input type="checkbox"/>            | <input type="checkbox"/>            | <input type="checkbox"/>            | <input type="checkbox"/>            | <input type="checkbox"/>            | <input type="checkbox"/>            | <input type="checkbox"/>            | <input type="checkbox"/>            | <input type="checkbox"/>            | <input type="checkbox"/>            | <input type="checkbox"/>            | <input type="checkbox"/>            | <input type="checkbox"/>            |
| <input type="checkbox"/>            | 1/0/9  | Tx & Rx      | Disabled          | <input type="checkbox"/>            | <input type="checkbox"/>            | <input type="checkbox"/>            | <input type="checkbox"/>            | <input type="checkbox"/>            | <input type="checkbox"/>            | <input type="checkbox"/>            | <input type="checkbox"/>            | <input type="checkbox"/>            | <input type="checkbox"/>            | <input type="checkbox"/>            | <input type="checkbox"/>            | <input type="checkbox"/>            |
| <input type="checkbox"/>            | 1/0/10 | Tx & Rx      | Disabled          | <input type="checkbox"/>            | <input type="checkbox"/>            | <input type="checkbox"/>            | <input type="checkbox"/>            | <input type="checkbox"/>            | <input type="checkbox"/>            | <input type="checkbox"/>            | <input type="checkbox"/>            | <input type="checkbox"/>            | <input type="checkbox"/>            | <input type="checkbox"/>            | <input type="checkbox"/>            | <input type="checkbox"/>            |

Total: 28 1 entry selected.

## 6.5 Using CLI

- Enable LLDP globally and configure the corresponding parameters.

Switch\_A#configure

```
Switch_A(config)#lldp
Switch_A(config)#lldp hold-multiplier 4
Switch_A(config)#lldp timer tx-interval 30
Switch_A(config)#lldp timer tx-delay 2
Switch_A(config)#lldp timer reinit-delay 3
Switch_A(config)#lldp timer notify-interval 5
Switch_A(config)#lldp timer fast-count 3
```

- 2) Set the Admin Status of port Fa1/0/1 to Tx&Rx, enable Notification Mode and configure all the TLVs included in the outgoing LLDP packets.

```
Switch_A#configure
Switch_A(config)#interface fastEthernet 1/0/1
Switch_A(config-if)#lldp receive
Switch_A(config-if)#lldp transmit
Switch_A(config-if)#lldp snmp-trap
Switch_A(config-if)#lldp tlv-select all
Switch_A(config-if)#end
Switch_A#copy running-config startup-config
```

## Verify the Configurations

### View LLDP settings globally

```
Switch_A#show lldp
```

|                                   |            |
|-----------------------------------|------------|
| LLDP Status:                      | Enabled    |
| LLDP Forward Message:             | Disabled   |
| Tx Interval:                      | 30 seconds |
| TTL Multiplier:                   | 4          |
| Tx Delay:                         | 2 seconds  |
| Initialization Delay:             | 2 seconds  |
| Trap Notification Interval:       | 5 seconds  |
| Fast-packet Count:                | 3          |
| LLDP-MED Fast Start Repeat Count: | 4          |

### View LLDP settings on each port

```
Switch_A#show lldp interface fastEthernet 1/0/1
```

```
LLDP interface config:
```

```
fastEthernet 1/0/1:
```

|                         |          |
|-------------------------|----------|
| Admin Status:           | TxRx     |
| SNMP Trap:              | Enabled  |
| TLV                     | Status   |
| ---                     | -----    |
| Port-Description        | Yes      |
| System-Capability       | Yes      |
| System-Description      | Yes      |
| System-Name             | Yes      |
| Management-Address      | Yes      |
| Port-VLAN-ID            | Yes      |
| Protocol-VLAN-ID        | Yes      |
| VLAN-Name               | Yes      |
| Link-Aggregation        | Yes      |
| MAC-Physic              | Yes      |
| Max-Frame-Size          | Yes      |
| Power                   | Yes      |
| LLDP-MED Status:        | Disabled |
| TLV                     | Status   |
| ---                     | -----    |
| Network Policy          | Yes      |
| Location Identification | Yes      |
| Extended Power Via MDI  | Yes      |
| Inventory Management    | Yes      |

### View the Local Info

```
Switch_A#show lldp local-information interface fastEthernet 1/0/1
```

```
LLDP local Information:
```

```
fastEthernet 1/0/1:
```



|                                    |   |
|------------------------------------|---|
| Chassis type:                      | MAC address   |
| Chassis ID:                        | 00:0A:EB:13:A2:11   |
| Port ID type:                      | Interface name  |
| Port ID:                           | FastEthernet1/0/1   |
| Port description:                  | FastEthernet1/0/1 Interface   |
| TTL:                               | 120   |
| System name:                       | T1500-28PCT   |
| System description:                | JetStream 24-Port 10/100Mbps + 4<br>-Port Gigabit Smart PoE+ Switch |
| System capabilities supported:     | Bridge  |
| System capabilities enabled:       | Bridge  |
| Management address type:           | ipv4  |
| Management address:                | 192.168.0.226   |
| Management address interface type: | IfIndex   |
| Management address interface ID:   | 1   |
| Management address OID:            | 0   |
| Port VLAN ID(PVID):                | 1   |
| Port and protocol VLAN ID(PPVID):  | 0   |
| Port and protocol VLAN supported:  | Yes   |
| Port and protocol VLAN enabled:    | No  |
| VLAN name of VLAN 1:               | System-VLAN   |
| Protocol identity:                 |   |
| Auto-negotiation supported:        | Yes   |
| Auto-negotiation enabled:          | Yes   |
| OperMau:                           | speed(100)/duplex(Full)   |
| Link aggregation supported:        | Yes   |
| Link aggregation enabled:          | No  |
| Aggregation port ID:               | 0   |
| Power port class:                  | PSE   |
| PSE power supported:               | Yes   |

|                            |  |
|----------------------------|--|
| PSE power enabled:         | No   |
| PSE pairs control ability: | No   |
| Maximum frame size:        | 1518   |
| LLDP-MED Capabilities:     | Capabilities<br>Network Policy<br>Location Identification<br>Extended Power via MDI - PSE<br>Inventory |
| Device Type:               | Network Connectivity   |
| Application type:          | Reserved   |
| Unknown policy:            | Yes  |
| Tagged:                    | No   |
| VLAN ID:                   | 0  |
| Layer 2 Priority:          | 0  |
| DSCP:                      | 0  |
| Location Data Format:      | Civic Address LCI  |
| - What:                    | Switch   |
| - Country Code:            | CN   |
| Power Type:                | PSE Device   |
| Power Source:              | Primary  |
| Power Priority:            | Low  |
| Power Value:               | 30.0w  |
| Hardware Revision:         | T1500-28PCT 3.0  |
| Firmware Revision:         | Reserved   |
| Software Revision:         | 3.0.0 Build 20180309 Rel.34341(s)  |
| Serial Number:             | Reserved   |
| Manufacturer Name:         | TP-Link  |
| Model Name:                | T1500-28PCT 3.0  |
| Asset ID:                  | unknown  |

**View the Neighbor Info**

```
Switch_A#show lldp neighbor-information interface fastEthernet 1/0/1
```

```
LLDP Neighbor Information:
```

```
fastEthernet 1/0/1:
```

```
Neighbor index 1:
```

|                                    |  |
|------------------------------------|--|
| Chassis type:                      | MAC address  |
| Chassis ID:                        | 00:0A:EB:13:18:2D  |
| Port ID type:                      | Interface name   |
| Port ID:                           | GigabitEthernet1/0/2   |
| Port description:                  | GigabitEthernet1/0/2 Interface                                 |
| TTL:                               | 120  |
| System name:                       | T1500-28PCT  |
| System description:                | JetStream 48-Port Gigabit Smart<br>PoE Switch with 4 SFP Slots |
| System capabilities supported:     | Bridge Router  |
| System capabilities enabled:       | Bridge Router  |
| Management address type:           | ipv4   |
| Management address:                | 192.168.0.1  |
| Management address interface type: | IfIndex  |
| Management address interface ID:   | 1  |
| Management address OID:            | 0  |
| Port VLAN ID(PVID):                | 1  |
| Port and protocol VLAN ID(PPVID):  | 0  |
| Port and protocol VLAN supported:  | Yes  |
| Port and protocol VLAN enabled:    | No   |
| VLAN name of VLAN 1:               | System-VLAN  |
| Protocol identity:                 |  |
| Auto-negotiation supported:        | Yes  |
| Auto-negotiation enabled:          | Yes  |
| OperMau:                           | speed(1000)/duplex(Full)                                       |

|                             |      |
|-----------------------------|------|
| Link aggregation supported: | Yes  |
| Link aggregation enabled:   | No   |
| Aggregation port ID:        | 0    |
| Power port class:           | PSE  |
| PSE power supported:        | Yes  |
| PSE power enabled:          | No   |
| PSE pairs control ability:  | No   |
| Maximum frame size:         | 1518 |

# 7 Appendix: Default Parameters

Default settings of LLDP are listed in the following tables.

## Default LLDP Settings

Table 7-1 Default LLDP Settings

| Parameter               | Default Setting |
|-------------------------|-----------------|
| LLDP                    | Disabled        |
| LLDP Forward Message    | Disabled        |
| Transmit Interval       | 30 seconds      |
| Hold Multiplier         | 4               |
| Transmit Delay          | 2 seconds       |
| Reinitialization Delay  | 2 seconds       |
| Notification Interval   | 5 seconds       |
| Fast Start Repeat Count | 3               |

Table 7-2 Default LLDP Settings on the Port

| Parameter         | Default Setting |
|-------------------|-----------------|
| Admin Status      | Tx&Rx           |
| Notification Mode | Disabled        |
| Included TLVs     | All             |

## Default LLDP-MED Settings

Table 7-3 Default LLDP-MED Settings

| Parameter               | Default Setting |
|-------------------------|-----------------|
| Fast Start Repeat Count | 4               |
| LLDP-MED Status (port)  | Disabled        |
| Included TLVs           | All             |

# Part 13

## Configuring DHCP Service

### CHAPTERS

1. DHCP
2. DHCP Relay Configuration
3. DHCP L2 Relay Configuration
4. Configuration Examples
5. Appendix: Default Parameters

# 1 DHCP

## 1.1 Overview

DHCP (Dynamic Host Configuration Protocol) is widely used to automatically assign IP addresses and other network configuration parameters to network devices, enhancing the utilization of IP address.

## 1.2 Supported Features

The supported DHCP features of the switch include DHCP Relay and DHCP L2 Relay.

### DHCP Relay

DHCP Relay is used to process and forward DHCP packets between different subnets or VLANs.

DHCP clients broadcast DHCP request packets to require for IP addresses. Without this function, clients cannot obtain IP addresses from a DHCP server in the different LAN because the broadcast packets can be transmitted only in the same LAN. To equip each LAN with a DHCP server can solve this problem, but the costs of network construction will be increased and the management of central network will become inconvenient.

A device with DHCP Relay function is a better choice. It acts as a relay agent and can forward DHCP packets between DHCP clients and DHCP servers in different LANs. Therefore, DHCP clients in different LANs can share one DHCP server.

DHCP Relay includes three features: Option 82 and DHCP VLAN Relay.

#### ■ Option 82

Option 82 is called the DHCP Relay Agent Information Option. It provides additional security and a more flexible way to allocate network addresses compared with the traditional DHCP.

When enabled, the DHCP relay agent can inform the DHCP server of some specified information of clients by inserting an Option 82 payload to DHCP request packets before forwarding them to the DHCP server, so that the DHCP server can distribute the IP addresses or other parameters to clients based on the payload. In this way, Option 82 prevents DHCP client requests from untrusted sources. Besides, it allows the DHCP server to assign IP addresses of different address pools to clients in different groups.

An Option 82 has two sub-options, namely, the Agent Circuit ID and Agent Remote ID. The information that the two sub-options carry depends on the settings of the DHCP relay agent, and are different among devices from different vendors. To allocate network addresses using Option 82, you need to define the two sub-options on the DHCP relay agent, and create a DHCP class on the DHCP server to identify the Option 82 payload.

TP-Link switches preset a default circuit ID and remote ID in TLV (Type, Length, and Value) format. You can also configure the format to include Value only and customize the Value.

Table 1-1 and Table 1-2 show the packet formats of the Agent Circuit ID and Agent Remote ID, respectively.

Table 1-1 Packet Formats of the Agent Circuit ID with Different Option 82 Settings

| Option 82 Settings       |                          | *Type (Hex) | *Length (Hex)                       | *Value                |
|--------------------------|--------------------------|-------------|-------------------------------------|-----------------------|
| *Format                  | Circuit ID Customization |             |                                     |                       |
| Normal (TLV)             | Disabled                 | 00          | 04                                  | Default circuit ID    |
|                          | Enabled                  | 01          | Length of the customized circuit ID | Customized circuit ID |
| Private (Only the value) | Disabled                 | -           | -                                   | Default circuit ID    |
|                          | Enabled                  | -           | -                                   | Customized circuit ID |

Table 1-2 Packet Formats of the Agent Remote ID with Different Option 82 Settings

| Option 82 Settings       |                         | *Type (Hex) | *Length (Hex)                      | *Value               |
|--------------------------|-------------------------|-------------|------------------------------------|----------------------|
| *Format                  | Remote ID Customization |             |                                    |                      |
| Normal (TLV)             | Disabled                | 00          | 06                                 | Default remote ID    |
|                          | Enabled                 | 01          | Length of the customized remote ID | Customized remote ID |
| Private (Only the value) | Disabled                | -           | -                                  | Default remote ID    |
|                          | Enabled                 | -           | -                                  | Customized remote ID |

### \*Format

Indicates the packet format of the sub-option field. Two options are available:

- Normal: Indicates the field consists of three parts: Type, Length, and Value (TLV).
- Private: Indicates the field consists of the value only.

### \*Type

A one-byte field indicating whether the Value field is customized or not. **00** in hexadecimal means the Value field is not customized (uses the default circuit/remote ID) while **01** in hexadecimal means it is customized.

### \*Length

A one-byte field indicating the length of the Value field. The length of the default circuit ID is 4 bytes and that of default remote ID is 6 bytes. For the customized circuit ID and remote ID, the length is variable, ranging from 1 to 64 bytes.



**\*Value**

Indicates the value of the sub-option. The switch has preset a default circuit ID and remoter ID. You can also customize them with Circuit ID Customization and Remote ID Customization enabled.

- **Default circuit ID:** A 4-byte value which consists of 2-byte VLAN ID and 2-byte Port ID. The VLAN ID indicates which VLAN the DHCP client belongs to, and the Port ID indicates which port the DHCP client is connected to.

For example, if the DHCP client is connected to port 1/0/1 in VLAN 2, this field is **00:02:00:01** in hexadecimal.

- **Default remote ID:** A 6-byte value which indicates the MAC address of the DHCP relay agent.
- **Customized circuit/remoter ID:** You can configure a string using up to 64 characters. The switch encodes the string using ASCII. When configuring your DHCP server to identify the string, use the correct notation that is used by your DHCP server to represent ASCII strings, or convert it into hexadecimal format if necessary.

**Tips:**

As shown in [Table 1-1](#) and [Table 1-2](#), by default, the circuit ID records the ports of the DHCP relay agent that are connected to the clients and the VLANs that the clients belong to, and the remote ID records the MAC address of the DHCP relay agent. That is, the two sub-options together record the location of the clients. To record the accurate location of clients, configure Option 82 on the switch which is closest to the clients.

**■ DHCP VLAN Relay**

DHCP VLAN Relay allows clients in different VLANs to obtain IP addresses from the DHCP server using the IP address of a single agent interface.

In DHCP VLAN Relay, you can simply specify the default management VLAN interface as the default agent interface for all VLANs. The switch fills this default agent interface's IP address in the Relay Agent IP Address field of the DHCP packets from all VLANs.

As the following figure shows, no IP addresses are assigned to VLAN 10 and VLAN 20, but a default relay agent interface is configured with the IP address 192.168.2.1/24. The switch fills in the Relay Agent IP Address field of the DHCP packets with the IP address of the default agent interface (192.168.2.1/24) when applying for IP addresses for clients in both VLAN 10 and VLAN 20. As a result, the DHCP server will assign IP addresses on 192.168.2.0/24 (the same subnet with the IP address of the default agent interface) to clients in both VLAN 10 and VLAN 20.

Figure 1-1 Application Scenario of DHCP VLAN Relay

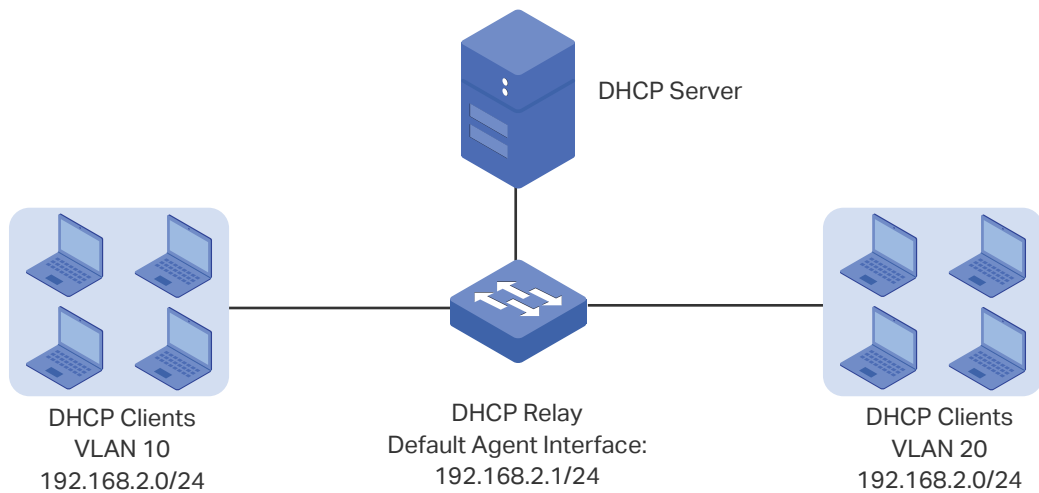

**Note:**

Only the management VLAN interface can be specified as the default relay agent interface.

## DHCP L2 Relay

Unlike DHCP relay, DHCP L2 Relay is used in the situation that the DHCP server and clients are in the same VLAN. In DHCP L2 Relay, in addition to normally assigning IP addresses to clients from the DHCP server, the switch can inform the DHCP server of some specified information, such as the location information, of clients by inserting an Option 82 payload to DHCP request packets before forwarding them to the DHCP server. This allows the DHCP server which supports Option 82 can set the distribution policy of IP addresses and other parameters, providing a more flexible way to distribute IP addresses.

Figure 1-2 Application Scenario of DHCP L2 Relay

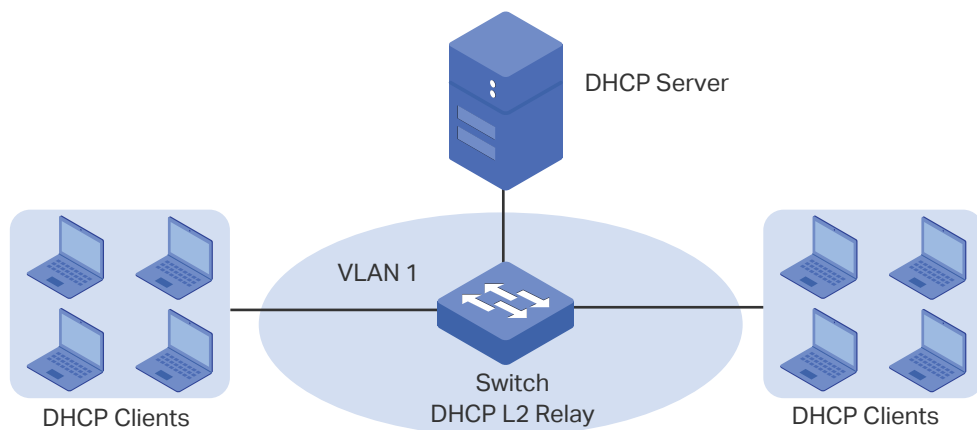

# 2 DHCP Relay Configuration

To complete DHCP Relay configuration, follow these steps:

- 1) Enable DHCP Relay. Configure Option 82 if needed.
- 2) Specify DHCP server for the Interface or VLAN.

## 2.1 Using the GUI

### 2.1.1 Enabling DHCP Relay and Configuring Option 82

Choose the menu **L3 FEATURES > DHCP Service > DHCP Relay > DHCP Relay Config** to load the following page.

Figure 2-1 Enable DHCP Relay and Configure Option 82

Global Config

---

DHCP Relay:  Enable

DHCP Relay Hops:  (1-16)

DHCP Relay Time Threshold:  seconds (0-65535)

[Apply](#)

---

Option 82 Config

UNIT1

LAGS

| <input type="checkbox"/> | Port   | Option 82 Support | Option 82 Policy | Format | Circuit ID Customization | Circuit ID | Remote ID Customization | Remote ID | LAG |
|--------------------------|--------|-------------------|------------------|--------|--------------------------|------------|-------------------------|-----------|-----|
| <input type="checkbox"/> | 1/0/1  | Disabled          | Keep             | Normal | Disabled                 |            | Disabled                |           | --- |
| <input type="checkbox"/> | 1/0/2  | Disabled          | Keep             | Normal | Disabled                 |            | Disabled                |           | --- |
| <input type="checkbox"/> | 1/0/3  | Disabled          | Keep             | Normal | Disabled                 |            | Disabled                |           | --- |
| <input type="checkbox"/> | 1/0/4  | Disabled          | Keep             | Normal | Disabled                 |            | Disabled                |           | --- |
| <input type="checkbox"/> | 1/0/5  | Disabled          | Keep             | Normal | Disabled                 |            | Disabled                |           | --- |
| <input type="checkbox"/> | 1/0/6  | Disabled          | Keep             | Normal | Disabled                 |            | Disabled                |           | --- |
| <input type="checkbox"/> | 1/0/7  | Disabled          | Keep             | Normal | Disabled                 |            | Disabled                |           | --- |
| <input type="checkbox"/> | 1/0/8  | Disabled          | Keep             | Normal | Disabled                 |            | Disabled                |           | --- |
| <input type="checkbox"/> | 1/0/9  | Disabled          | Keep             | Normal | Disabled                 |            | Disabled                |           | --- |
| <input type="checkbox"/> | 1/0/10 | Disabled          | Keep             | Normal | Disabled                 |            | Disabled                |           | --- |
| Total: 28                |        |                   |                  |        |                          |            |                         |           |     |

Follow these steps to enable DHCP Relay and configure Option 82:

- 1) In the **Global Config** section, enable DHCP Relay globally and configure the relay hops and time threshold. Click **Apply**.

|                           |  |
|---------------------------|--|
| DHCP Relay                | Enable DHCP Relay globally.  |
| DHCP Relay Hops           | Specify the DHCP relay hops.<br><br>DHCP Relay Hops defines the maximum number of hops (DHCP Relay agent) that the DHCP packets can be relayed. If a packet's hop count is more than the value you set here, the packet will be dropped.   |
| DHCP Relay Time Threshold | Specify the threshold of the DHCP relay time. The valid values are from 0 to 65535 seconds.<br><br>DHCP relay time is the time elapsed since the client began address acquisition or renewal process. There is a field in DHCP packets which specially records this time, and the switch will drop the packets if the value of this field is greater than the threshold. Value 0 means the switch will not examine this field of the DHCP packets. |

2) (Optional) In the **Option 82 Config** section, configure Option 82.

|                          |   |
|--------------------------|---|
| Option 82 Support        | Select whether to enable Option 82 or not.<br><br>Enable it if you want to prevent DHCP client requests from untrusted sources, or assign different IP addresses to clients in different groups from the same DHCP server.  |
| Option 82 Policy         | Select the operation for the switch to take when receiving DHCP packets that include the Option 82 field.<br><br><b>Keep:</b> The switch keeps the Option 82 field of the packets.<br><br><b>Replace:</b> The switch replaces the Option 82 field of the packets with a new one. The switch presets a default circuit ID and remote ID in TLV (Type, Length, and Value) format. You can also configure the format to include Value only and customize the Value.<br><br><b>Drop:</b> The switch discards the packets that include the Option 82 field.      |
| Format                   | Specify the packet format for the sub-option fields of Option 82.<br><br><b>Normal:</b> Indicates the fields consist of three parts: Type, Length, and Value (TLV).<br><br><b>Private:</b> Indicates the fields consist of the value only.  |
| Circuit ID Customization | Enable or disable Circuit ID Customization. Enable it if you want to manually configure the circuit ID. Otherwise, the switch uses the default one when inserting Option 82 to DHCP packets.<br><br>The default circuit ID is a 4-byte value which consists of 2-byte VLAN ID and 2-byte Port ID. The VLAN ID indicates which VLAN the DHCP client belongs to, and the Port ID indicates which port the DHCP client is connected to. For example, if the DHCP client is connected to port 1/0/1 in VLAN 2, this field is <b>00:02:00:01</b> in hexadecimal. |
| Circuit ID               | Enter the customized circuit ID with up to 64 characters. The circuit ID configurations of the switch and the DHCP server should be compatible with each other.   |

|                         |  |
|-------------------------|--|
| Remote ID Customization | Enable or disable Remote ID Customization. Enable it if you want to manually configure the remote ID. Otherwise, the switch uses its own MAC address as the remote ID. |
| Remote ID               | Enter the customized remote ID with up to 64 characters. The remote ID configurations of the switch and the DHCP server should be compatible with each other.          |

3) Click **Apply**.

## 2.1.2 Configuring DHCP VLAN Relay

DHCP VLAN Relay allows clients in different VLANs to obtain IP addresses from a DHCP server using the IP address of a single agent interface. It is often used when the relay switch does not support configuring multiple Layer 3 interfaces.

Choose the menu **L3 FEATURES > DHCP Service > DHCP Relay > DHCP VLAN Relay** to load the following page.

Figure 2-2 Configure DHCP VLAN Relay

Follow these steps to specify DHCP Server for the specific VLAN:

1) In the **Default Relay Agent Interface** section, configure the management VLAN (by default, it is VLAN 1) as the default relay agent interface. Then click **Apply**.

|              |  |
|--------------|--|
| Interface ID | Configure the management VLAN (by default, it is VLAN 1) as the default relay agent interface.<br><br>The DHCP server will assign IP addresses in the same subnet with this relay agent interface to the clients who use this relay-agent interface to apply for IP addresses. |
| IP Address   | Displays the IP address of this interface.   |

### Note:

Only the management VLAN interface can be specified as the default relay agent interface.

2) In the **DHCP VLAN Relay Config** section, click  **Add** to load the configuration page.

Figure 2-3 Specify a DHCP server for the VLAN

Specify the VLAN the clients belong to and the server address. Click **Create**.

|                |  |
|----------------|--|
| VLAN ID        | Specify the VLAN in which the clients can get IP addresses from the DHCP server. |
| Server Address | Enter the IP address of the DHCP server.   |

## 2.2 Using the CLI

### 2.2.1 Enabling DHCP Relay

Follow these steps to enable DHCP Relay and configure the corresponding parameters:

|        |   |
|--------|---|
| Step 1 | <p><b>configure</b></p> <p>Enter Global Configuration Mode.</p>   |
| Step 2 | <p><b>service dhcp relay</b></p> <p>Enable DHCP Relay.</p>  |
| Step 3 | <p><b>ip dhcp relay hops hops</b></p> <p>Specify the maximum hops (DHCP relay agent) that the DHCP packets can be relayed. If a packet's hop count is more than the value you set here, the packet will be dropped.</p> <p><i>hops</i>: Specify the maximum hops for DHCP packets. Valid values are from the 1 to 16, and the default value is 4.</p>   |
| Step 4 | <p><b>ip dhcp relay time time</b></p> <p>Specify the threshold for the DHCP relay time.</p> <p>DHCP relay time is the time elapsed since the client began address acquisition or renewal process. There is a field in DHCP packets which specially records this time, and the switch will drop the packets if the value of this field is greater than the threshold. Value 0 means the switch will not examine this field of the DHCP packets.</p> <p><i>time</i>: Specify the threshold for the DHCP relay time. Valid values are from 1 to 65535. By default, the value is 0, which means the switch will not examine this field of the DHCP packets.</p> |
| Step 5 | <p><b>show ip dhcp relay</b></p> <p>Verify the configuration of DHCP Relay.</p>   |

---

|        |   |
|--------|---|
| Step 6 | <b>end</b><br>Return to Privileged EXEC Mode. |
|--------|---|

---

|        |   |
|--------|---|
| Step 7 | <b>copy running-config startup-config</b><br>Save the settings in the configuration file. |
|--------|---|

---

The following example shows how to enable DHCP Relay, configure the relay hops as 5 and configure the relay time as 10 seconds :

**Switch#configure**

**Switch(config)#service dhcp relay**

**Switch(config)#show ip dhcp relay**

**Switch(config)#ip dhcp relay hops 5**

**Switch(config)#ip dhcp relay time 10**

DHCP relay state: enabled

DHCP relay hops: 5

DHCP relay Time Threshold: 10 seconds

...

**Switch(config)#end**

**Switch#copy running-config startup-config**

## 2.2.2 (Optional) Configuring Option 82

Follow these steps to configure Option 82:

---

|        |  |
|--------|--|
| Step 1 | <b>configure</b><br>Enter Global Configuration Mode. |
|--------|--|

---

|        |  |
|--------|--|
| Step 2 | <b>interface { fastEthernet port   range fastEthernet port-list   gigabitEthernet port   range gigabitEthernet port-list   ten-gigabitEthernet port   range ten-gigabitEthernet port-list }</b><br>Enter Interface Configuration Mode. |
|--------|--|

---

|        |  |
|--------|--|
| Step 3 | <b>ip dhcp relay information option</b><br>Enable the Option 82 feature on the port. |
|--------|--|

---

---

|         |   |
|---------|---|
| Step 4  | <b>ip dhcp relay information strategy { keep   replace   drop }</b><br>Specify the operation for the switch to take when receiving DHCP packets that include the Option 82 field.<br><br><i>keep</i> : The switch keeps the Option 82 field of the packets.<br><br><i>replace</i> : The switch replaces the Option 82 field of the packets with a new one. The switch presets a default circuit ID and remote ID in TLV (Type, Length, and Value) format. You can also configure the format to include Value only and customize the Value.<br><br><i>drop</i> : The switch discards the packets that include the Option 82 field.   |
| Step 5  | <b>ip dhcp relay information format { normal   private }</b><br>Specify the packet format for the sub-option fields of Option 82.<br><br><i>normal</i> : Indicates the fields consist of three parts: Type, Length, and Value (TLV).<br><br><i>private</i> : Indicates the fields consist of the value only.  |
| Step 6  | <b>ip dhcp relay information circuit-id string</b><br>(Optional) A default circuit ID is preset on the switch, and you can also run this command to customize the circuit ID. The circuit ID configurations of the switch and the DHCP server should be compatible with each other.<br><br>The default circuit ID is a 4-byte value which consists of 2-byte VLAN ID and 2-byte Port ID. The VLAN ID indicates which VLAN the DHCP client belongs to, and the Port ID indicates which port the DHCP client is connected to. For example, if the DHCP client is connected to port 1/0/1 in VLAN 2, this field is <b>00:02:00:01</b> in hexadecimal.<br><br><i>string</i> : Enter the customized circuit ID with up to 64 characters. |
| Step 7  | <b>ip dhcp relay information remote-id string</b><br>(Optional) The switch uses its own MAC address as the default remote ID, and you can also run this command to customize the remote ID. The remote ID configurations of the switch and the DHCP server should be compatible with each other.<br><br><i>string</i> : Enter the remote ID with up to 64 characters.   |
| Step 8  | <b>show ip dhcp relay information interface { fastEthernet port   gigabitEthernet port   ten-gigabitEthernet port   port-channel port-channel-id }</b><br>Verify the Option 82 configurations of the port.  |
| Step 9  | <b>end</b><br>Return to Privileged EXEC Mode.   |
| Step 10 | <b>copy running-config startup-config</b><br>Save the settings in the configuration file.   |

---

The following example shows how to enable Option 82 on port 1/0/7 and configure the strategy as replace, the format as normal, the circuit-id as VLAN20 and the remote-id as Host1:

**Switch#configure**



```
Switch(config)#interface gigabitEthernet 1/0/7
```

```
Switch(config-if)#ip dhcp relay information option
```

```
Switch(config-if)#ip dhcp relay information strategy replace
```

```
Switch(config-if)#ip dhcp relay information format normal
```

```
Switch(config-if)#ip dhcp relay information circuit-id VLAN20
```

```
Switch(config-if)#ip dhcp relay information remote-id Host1
```

```
Switch(config-if)#show ip dhcp relay information interface gigabitEthernet 1/0/7
```

| Interface | Option 82 Status | Operation Strategy | Format | Circuit ID | Remote ID | LAG   |
|-----------|------------------|--------------------|--------|------------|-----------|-------|
| -----     | -----            | -----              | -----  | -----      | -----     | ----- |
| Gi1/0/7   | Enable           | Replace            | Normal | VLAN20     | Host1     | N/A   |

```
Switch(config-if)#end
```

```
Switch#copy running-config startup-config
```

## 2.2.3 Configuring DHCP VLAN Relay

Follow these steps to configure DHCP VLAN Relay:

|        |   |
|--------|---|
| Step 1 | <b>configure</b><br>Enter Global Configuration Mode.  |
| Step 2 | Enter VLAN Interface Configuration Mode:<br><b>interface vlan <i>vlan-id</i></b><br><i>vlan-id</i> : Specify a VLAN interface. Only the management VLAN is supported.   |
| Step 3 | <b>ip dhcp relay default-interface</b><br>Set the management VLAN interface as the default relay-agent interface.   |
| Step 4 | <b>exit</b><br>Return to Global Configuration Mode.   |
| Step 5 | <b>ip dhcp relay vlan <i>vid</i> helper-address <i>ip-address</i></b><br>Specify the VLAN ID and the DHCP server.<br><i>vid</i> : Enter the ID of the VLAN, in which the hosts can dynamically get the IP addresses from the DHCP server.<br><i>ip-address</i> : Enter the IP address of the DHCP server. |
| Step 6 | <b>show ip dhcp relay</b><br>Verify the configuration of DHCP Relay.  |
| Step 7 | <b>end</b><br>Return to Privileged EXEC Mode.   |

---

Step 8      **copy running-config startup-config**  
Save the settings in the configuration file.

---

The following example shows how to set the VLAN interface 1 (the default management VLAN interface) as the default relay agent interface and configure the DHCP server address as 192.168.1.8 on VLAN 10:

**Switch#configure**

**Switch(config)#interface vlan 1**

**Switch(config-if)# ip dhcp relay default-interface**

**Switch(config-if)#exit**

**Switch(config)#ip dhcp relay vlan 10 helper-address 192.168.1.8**

**Switch(config)#show ip dhcp relay**

...

DHCP VLAN relay helper address is configured on the following vlan:

| vlan    | Helper address |
|---------|----------------|
| -----   | -----          |
| VLAN 10 | 192.168.1.8    |

**Switch(config)#end**

**Switch#copy running-config startup-config**

# 3 DHCP L2 Relay Configuration

To complete DHCP L2 Relay configuration, follow these steps:

- 1) Enable DHCP L2 Relay.
- 2) Configure Option 82 for ports.

## 3.1 Using the GUI

### 3.1.1 Enabling DHCP L2 Relay

Choose the menu **L3 FEATURES > DHCP Service > DHCP L2 Relay > Global Config** to load the following page.

Figure 3-1 Enable DHCP L2 Relay

Global Config

DHCP L2 Relay:  Enable Apply

VLAN Config

Filter by VLAN: From  To  Apply

| <input type="checkbox"/>            | VLAN | Status   |
|-------------------------------------|------|----------|
| <input checked="" type="checkbox"/> | 1    | Disabled |
| <input type="checkbox"/>            | 8    | Disabled |

Total: 2 1 entry selected. Cancel Apply

Follow these steps to enable DHCP L2 Relay globally for the specified VLAN:

- 1) In the **Global Config** section, enable DHCP L2 Relay globally. Click **Apply**.

**DHCP L2 Relay** Enable DHCP Relay globally.

- 2) In the **VLAN Config** section, enable DHCP L2 Relay for the specified VLAN. Click **Apply**.

**VLAN** Displays the VLAN ID.

**Status** Enable DHCP L2 Relay for the specified VLAN.

### 3.1.2 Configuring Option 82 for Ports

Choose the menu **L3 FEATURES > DHCP Service > DHCP L2 Relay > Port Config** to load the following page.

Figure 3-2 Configure Option 82 for Ports

| UNIT1                               |        | LAGS              |                  |        |                          |            |                         |           |     |
|-------------------------------------|--------|-------------------|------------------|--------|--------------------------|------------|-------------------------|-----------|-----|
| <input type="checkbox"/>            | Port   | Option 82 Support | Option 82 Policy | Format | Circuit ID Customization | Circuit ID | Remote ID Customization | Remote ID | LAG |
| <input checked="" type="checkbox"/> | 1/0/1  | Disabled          | Keep             | Normal | Disabled                 |            | Disabled                |           | --- |
| <input type="checkbox"/>            | 1/0/2  | Disabled          | Keep             | Normal | Disabled                 |            | Disabled                |           | --- |
| <input type="checkbox"/>            | 1/0/3  | Disabled          | Keep             | Normal | Disabled                 |            | Disabled                |           | --- |
| <input type="checkbox"/>            | 1/0/4  | Disabled          | Keep             | Normal | Disabled                 |            | Disabled                |           | --- |
| <input type="checkbox"/>            | 1/0/5  | Disabled          | Keep             | Normal | Disabled                 |            | Disabled                |           | --- |
| <input type="checkbox"/>            | 1/0/6  | Disabled          | Keep             | Normal | Disabled                 |            | Disabled                |           | --- |
| <input type="checkbox"/>            | 1/0/7  | Disabled          | Keep             | Normal | Disabled                 |            | Disabled                |           | --- |
| <input type="checkbox"/>            | 1/0/8  | Disabled          | Keep             | Normal | Disabled                 |            | Disabled                |           | --- |
| <input type="checkbox"/>            | 1/0/9  | Disabled          | Keep             | Normal | Disabled                 |            | Disabled                |           | --- |
| <input type="checkbox"/>            | 1/0/10 | Disabled          | Keep             | Normal | Disabled                 |            | Disabled                |           | --- |

Total: 28      1 entry selected.      Cancel Apply

Follow these steps to enable DHCP Relay and configure Option 82:

- 1) Select one or more ports to configure Option 82.

**Option 82 Support**

Select whether to enable Option 82 or not.

Enable it if you want to prevent DHCP client requests from untrusted sources, or assign different IP addresses to clients in different groups from the same DHCP server.

**Option 82 Policy**

Select the operation for the switch to take when receiving DHCP packets that include the Option 82 field.

**Keep:** The switch keeps the Option 82 field of the packets.

**Replace:** The switch replaces the Option 82 field of the packets with a new one. The switch presets a default circuit ID and remote ID in TLV (Type, Length, and Value) format. You can also configure the format to include Value only and customize the Value.

**Drop:** The switch discards the packets that include the Option 82 field.

**Format**

Specify the packet format for the sub-option fields of Option 82.

**Normal:** Indicates the fields consist of three parts: Type, Length, and Value (TLV).

**Private:** Indicates the fields consist of the value only.

|                          |   |
|--------------------------|---|
| Circuit ID Customization | <p>Enable or disable Circuit ID Customization. Enable it if you want to manually configure the circuit ID. Otherwise, the switch uses the default one when inserting Option 82 to DHCP packets.</p> <p>The default circuit ID is a 4-byte value which consists of 2-byte VLAN ID and 2-byte Port ID. The VLAN ID indicates which VLAN the DHCP client belongs to, and the Port ID indicates which port the DHCP client is connected to. For example, if the DHCP client is connected to port 1/0/1 in VLAN 2, this field is 00:02:00:01 in hexadecimal.</p> |
| Circuit ID               | Enter the customized circuit ID with up to 64 characters. The circuit ID configurations of the switch and the DHCP server should be compatible with each other.   |
| Remote ID Customization  | Enable or disable Remote ID Customization. Enable it if you want to manually configure the remote ID. Otherwise, the switch uses its own MAC address as the remote ID.  |
| Remote ID                | Enter the customized remote ID with up to 64 characters. The remote ID configurations of the switch and the DHCP server should be compatible with each other.   |

2) Click **Apply**.

## 3.2 Using the CLI

### 3.2.1 Enabling DHCP L2 Relay

Follow these steps to enable DHCP L2 Relay:

|        |  |
|--------|--|
| Step 1 | <p><b>configure</b></p> <p>Enter Global Configuration Mode.</p>  |
| Step 2 | <p><b>ip dhcp l2relay</b></p> <p>Enable DHCP L2 Relay.</p>   |
| Step 3 | <p><b>ip dhcp l2relay vlan <i>vlan-list</i></b></p> <p>Enable DHCP L2 Relay for specified VLANs.</p> <p><i>vlan-list</i>: Specify the vlan to be enabled with DHCP L2 relay.</p> |
| Step 5 | <p><b>show ip dhcp l2relay</b></p> <p>Verify the configuration of DHCP Relay.</p>  |
| Step 6 | <p><b>end</b></p> <p>Return to Privileged EXEC Mode.</p>   |
| Step 7 | <p><b>copy running-config startup-config</b></p> <p>Save the settings in the configuration file.</p>   |

The following example shows how to enable DHCP L2 Relay globally and for VLAN 2:

```
Switch#configure
```

```
Switch(config)#ip dhcp l2relay
```

```
Switch(config)#ip dhcp l2relay vlan 2
```

```
Switch(config)#show ip dhcp l2relay
```

```
Global Status: Enable
```

```
VLAN ID: 2
```

```
Switch(config)#end
```

```
Switch#copy running-config startup-config
```

### 3.2.2 Configuring Option 82 for Ports

Follow these steps to configure Option 82:

|        |  |
|--------|--|
| Step 1 | <b>configure</b><br>Enter Global Configuration Mode.   |
| Step 2 | <b>interface { fastEthernet port   range fastEthernet port-list   gigabitEthernet port   range gigabitEthernet port-list   ten-gigabitEthernet port   range ten-gigabitEthernet port-list }</b><br>Enter Interface Configuration Mode.   |
| Step 3 | <b>ip dhcp l2relay information option</b><br>Enable the Option 82 feature on the port.   |
| Step 4 | <b>ip dhcp l2relay information strategy { keep   replace   drop }</b><br>Specify the operation for the switch to take when receiving DHCP packets that include the Option 82 field.<br><br><b>keep:</b> The switch keeps the Option 82 field of the packets.<br><br><b>replace:</b> The switch replaces the Option 82 field of the packets with a new one. The switch presets a default circuit ID and remote ID in TLV (Type, Length, and Value) format. You can also configure the format to include Value only and customize the Value.<br><br><b>drop:</b> The switch discards the packets that include the Option 82 field. |
| Step 5 | <b>ip dhcp l2relay information format { normal   private }</b><br>Specify the packet format for the sub-option fields of Option 82.<br><br><b>normal:</b> Indicates the fields consist of three parts: Type, Length, and Value (TLV).<br><br><b>private:</b> Indicates the fields consist of the value only.   |

- 
- Step 6      **ip dhcp l2relay information circuit-id string**
- (Optional) A default circuit ID is preset on the switch, and you can also run this command to customize the circuit ID. The circuit ID configurations of the switch and the DHCP server should be compatible with each other.
- The default circuit ID is a 4-byte value which consists of 2-byte VLAN ID and 2-byte Port ID. The VLAN ID indicates which VLAN the DHCP client belongs to, and the Port ID indicates which port the DHCP client is connected to. For example, if the DHCP client is connected to port 1/0/1 in VLAN 2, this field is **00:02:00:01** in hexadecimal.
- string*: Enter the customized circuit ID with up to 64 characters.
- 
- Step 7      **ip dhcp l2relay information remote-id string**
- (Optional) The switch uses its own MAC address as the default remote ID, and you can also run this command to customize the remote ID. The remote ID configurations of the switch and the DHCP server should be compatible with each other.
- string*: Enter the remote ID with up to 64 characters.
- 
- Step 8      **show ip dhcp l2relay information interface { fastEthernet port | gigabitEthernet port | port-channel port-channel-id }**
- Verify the Option 82 configuration of the port.
- 
- Step 9      **end**
- Return to Privileged EXEC Mode.
- 
- Step 10     **copy running-config startup-config**
- Save the settings in the configuration file.
- 

The following example shows how to enable Option 82 on port 1/0/7 and configure the strategy as replace, the format as normal, the circuit-id as VLAN20 and the remote-id as Host1:

**Switch#configure**

**Switch(config)#interface gigabitEthernet 1/0/7**

**Switch(config-if)#ip dhcp l2relay information option**

**Switch(config-if)#ip dhcp l2relay information strategy replace**

**Switch(config-if)#ip dhcp l2relay information format normal**

**Switch(config-if)#ip dhcp l2relay information circuit-id VLAN20**

**Switch(config-if)#ip dhcp l2relay information remote-id Host1**

**Switch(config-if)#show ip dhcp l2relay information interface gigabitEthernet 1/0/7**

| Interface | Option 82 Status | Operation Strategy | Format | Circuit ID | Remote ID | LAG   |
|-----------|------------------|--------------------|--------|------------|-----------|-------|
| -----     | -----            | -----              | -----  | -----      | -----     | ----- |
| Gi1/0/7   | Enable           | Replace            | Normal | VLAN20     | Host1     | N/A   |

```
Switch(config-if)#end
```

```
Switch#copy running-config startup-config
```



# 4 Configuration Examples

## 4.1 Example for DHCP VLAN Relay

### 4.1.1 Network Requirements

The administrator needs to deploy the office network for the Marketing department and the R&D department. The detailed requirements are listed below:

- The Marketing department and the R&D department belong to VLAN 10 and VLAN 20, respectively. Both of the VLANs have no Layer 3 gateways.
- Computers in the two departments need to obtain IP addresses from the same DHCP server.

The network topology designed by the administrator is shown below.

Figure 4-1 Network Topology for DHCP VLAN Relay

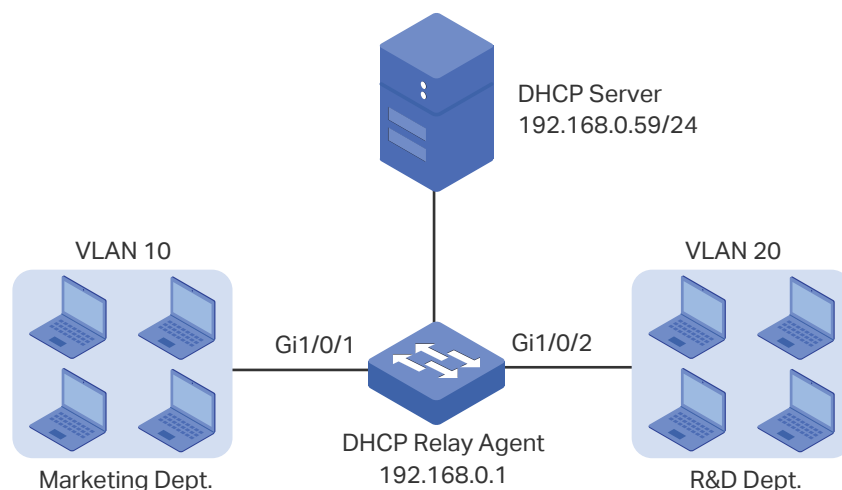

### 4.1.2 Configuration Scheme

In the given situation, the DHCP server and the computers are isolated by VLANs, so the DHCP request from the clients cannot be directly forwarded to the DHCP server. Considering that the two VLANs have no Layer 3 gateways, we recommend you to configure DHCP VLAN Relay to satisfy the requirement.

The overview of the configurations are as follows:

- 1) Create one DHCP IP pool on the DHCP server, which is on 192.168.0.0/24 network segment.
- 2) Configure 802.1Q VLAN on the DHCP relay agent. Add all computers in the marketing department to VLAN 10, and add all computers in the R&D department to VLAN 20.

- 3) Configure DHCP VLAN Relay on the DHCP relay agent. Enable DHCP Relay globally, choose the VLAN interface 1 (the default management VLAN interface) as the default relay agent interface, and specify the DHCP server address for VLAN 10 and VLAN 20.

In this example, the DHCP server is demonstrated with T2600G-28TS and the DHCP relay agent is demonstrated with T1500-28PCT. The following sections provide configuration procedures in two ways: using the GUI and using the CLI.

### 4.1.3 Using the GUI

#### ■ Configuring the DHCP Server

- 1) Choose the menu **L3 FEATURES > DHCP Service > DHCP Server > DHCP Server** to load the following page. In the **Global Config** section, enable DHCP Server globally.

Figure 4-2 Configuring DHCP Server

Global Config

DHCP Server:  Enable

Option 60:  (Optional. 1-64 characters)

Option 138:  (Optional. Format:192.168.0.1)

- 2) Choose the menu **L3 FEATURES > DHCP Service > DHCP Server > Pool Setting** and click **+ Add** to load the following page. Create a DHCP pool for the clients. Configure the corresponding parameters as the following picture shows.

Figure 4-3 Configuring DHCP Pool 1 for VLAN 10

DHCP Server Pool

Pool Name:  (8 characters maximum)

Network Address:  (Format: 192.168.0.0)

Subnet Mask:  (Format: 255.255.255.0)

Lease Time:  (Optional. 1-2880 min, Default: 120)

▶ Default Gateway:  (Optional. Format: 192.168.0.1)

▶ DNS Server:  (Optional. Format: 192.168.0.1)

▶ NetBIOS Server:  (Optional. Format: 192.168.0.1)

NetBIOS Node Type:  (Optional, b/p/m/h/none)

Next Server Address:  (Optional. Format: 192.168.0.1)

Domain Name:  (0 to 200 characters)

Bootfile:  (0 to 128 characters)

■ **Configuring the VLANs on the Relay Agent**

- 1) Choose the menu **L2 FEATURES > VLAN > 802.1Q VLAN > VLAN Config** and click  **Add** to load the following page. Create VLAN 10 for the Marketing department and add port 1/0/1 as untagged port to the VLAN.

Figure 4-4 Creating VLAN 10

The screenshot shows the 'VLAN Config' interface. At the top, the title 'VLAN Config' is displayed in a teal header. Below the header, there are two input fields: 'VLAN ID:' with the value '10' and a note '(2-4094, format: 2,4-5,8)', and 'VLAN Name:' with the value 'Marketing' and a note '(1-16 characters)'. Both fields are highlighted with a red box. Below these fields is the 'Untagged Ports' section. It features a 'Port:' input field with '1/0/1' and a note '(Format: 1/0/1, input or choose below)'. Underneath, there are two columns of port selection buttons labeled 'UNIT1' and 'LAGS'. In the 'UNIT1' column, port '1' is highlighted with a red box and a blue 'Selected' icon. Below the port buttons are three legend icons: a blue square for 'Selected', a white square for 'Unselected', and a grey square for 'Not Available'. The 'Tagged Ports' section is currently empty. At the bottom right, there are two buttons: 'Cancel' and 'Create', with the 'Create' button highlighted by a red box.

- 2) On the same page, click **+** Add again to create VLAN 20 for the R&D department and add port 1/0/2 as untagged port to the VLAN.

Figure 4-5 Creating VLAN 20

The screenshot shows the 'VLAN Config' interface. At the top, there are two input fields: 'VLAN ID' with the value '20' and 'VLAN Name' with the value 'RD'. Below these is the 'Untagged Ports' section, which includes a 'Port' input field containing '1/0/2'. A grid of port icons is displayed, with port 2 highlighted in blue. A legend below the grid indicates that blue icons are 'Selected', white icons are 'Unselected', and grey icons are 'Not Available'. At the bottom right, there are 'Cancel' and 'Create' buttons.

■ **Configuring DHCP VLAN Relay on the Relay Agent**

- 1) Choose the menu **L3 FEATURES > DHCP Service > DHCP Relay > DHCP Relay Config** to load the following page. In the **Global Config** section, enable DHCP Relay, and click **Apply**.

Figure 4-6 Enable DHCP Relay

The screenshot shows the 'Global Config' section for DHCP Relay. It features three settings: 'DHCP Relay' with a checked 'Enable' checkbox, 'DHCP Relay Hops' with a value of '4', and 'DHCP Relay Time Threshold' with a value of '0'. An 'Apply' button is located at the bottom right.

- 2) Choose the menu **L3 FEATURES > DHCP Service > DHCP Relay > DHCP VLAN Relay** to load the following page. In the **Default Relay Agent Interface** section, specify

VLAN interface 1 (the default management VLAN interface) as the default relay-agent interface. Click **Apply**.

Figure 4-7 Specify the Default Relay Agent Interface

Default Relay Agent Interface

Interface ID:   (1-4094)

IP Address: 192.168.0.1

- 3) Choose the menu **L3 FEATURES > DHCP Service > DHCP Relay > DHCP VLAN Relay** and click **+ Add** to load the following page. Specify the DHCP server address for the clients in VLAN 10 and VLAN 20.

Figure 4-8 Specify DHCP Server for Interface VLAN 10

DHCP VLAN Relay

VLAN ID:  (1-4094)

Server Address:  (Format: 192.168.0.1)

Figure 4-9 Specify DHCP Server for Interface VLAN 20

DHCP VLAN Relay

VLAN ID:  (1-4094)

Server Address:  (Format: 192.168.0.1)

- 4) Click  to save the settings.

#### 4.1.4 Using the CLI

##### ■ Configuring the DHCP Server

- 1) Enable DHCP service globally.

```
Switch#configure
```

```
Switch(config)#service dhcp server
```

- 2) Create a DHCP pool and name it as "pool" and configure its network address as 192.168.0.0, subnet mask as 255.255.255.0, lease time as 120 minutes, default gateway as 192.168.0.1.

```
Switch(config)#ip dhcp server pool pool
```

```
Switch(dhcp-config)#network 192.168.0.0 255.255.255.0
```

```
Switch(dhcp-config)#lease 120
Switch(dhcp-config)#default-gateway 192.168.0.1
Switch(dhcp-config)#dns-server 192.168.0.2
Switch(dhcp-config)#end
Switch#copy running-config startup-config
```

#### ■ Configuring the VLAN on the Relay Agent

```
Switch#configure
Switch(config)# vlan 10
Switch(config-vlan)#name Marketing
Switch(config-vlan)#exit
Switch(config)#interface gigabitEthernet 1/0/1
Switch(config-if)#switchport general allowed vlan 10 untagged
Switch(config-if)#exit
Switch(config)# vlan 20
Switch(config-vlan)#name RD
Switch(config-vlan)#exit
Switch(config)#interface gigabitEthernet 1/0/2
Switch(config-if)#switchport general allowed vlan 20 untagged
Switch(config-if)#exit
```

#### ■ Configuring DHCP VLAN Relay on the Relay Agent

- 1) Enable DHCP Relay.

```
Switch(config)#service dhcp relay
```

- 2) Specify the routed port 1/0/5 as the default relay agent interface.

```
Switch(config)#interface vlan 1
Switch(config-if)#ip dhcp relay default-interface
Switch(config-if)#exit
```

- 3) Specify the DHCP server for VLAN 10 and VLAN 20

```
Switch(config)#ip dhcp relay vlan 10 helper-address 192.168.0.59
Switch(config)#ip dhcp relay vlan 20 helper-address 192.168.0.59
Switch(config)#exit
```

## Verify the Configurations of the DHCP Relay Agent

```
Switch#show ip dhcp relay
```

```
Switch#show ip dhcp relay
```

```
DHCP relay state: enabled
```

```
...
```

```
DHCP relay default relay agent interface:
```

```
Interface: VLAN 1
```

```
IP address: 192.168.0.1
```

```
DHCP vlan relay helper address is configured on the following vlan:
```

| vlan    | Helper address |
|---------|----------------|
| -----   |                |
| VLAN 10 | 192.168.0.59   |
| VLAN 20 | 192.168.0.59   |

## 4.2 Example for Option 82 in DHCP Relay

### 4.2.1 Network Requirements

As the following figure shows, there are two groups of computers. Group 1 is connected to Switch A via port 1/0/1, and Group 2 is connected via port 1/0/2. All computers are in the same VLAN, but the computers and the DHCP server are in different VLANs. For management convenience, the administrator wants to allocate separate address spaces for the two groups of computers.

Figure 4-10 Network Topology for Option 82 in DHCP Relay

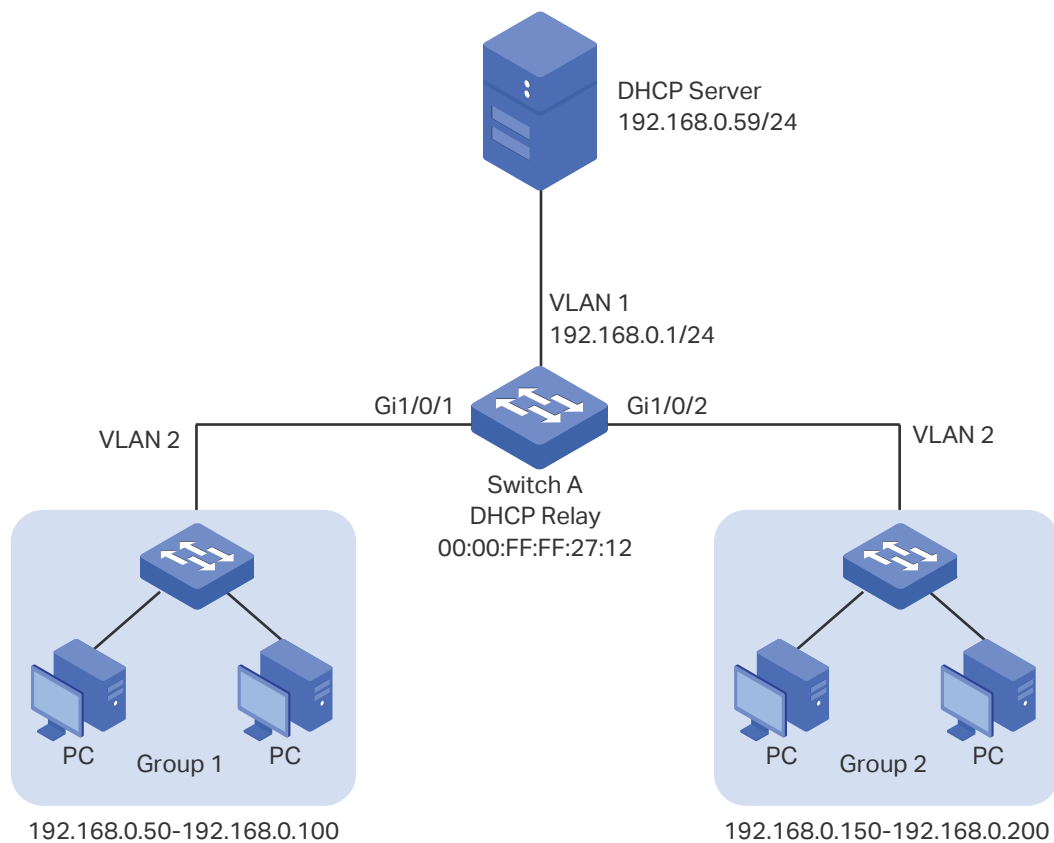

## 4.2.2 Configuration Scheme

To meet the requirements, you can configure Option 82 in DHCP Relay on Switch A. With DHCP Relay enabled, the switch can forward DHCP requests and replies between clients and the server. With Option 82 enabled, Switch A informs the DHCP server of the group information of each computer, so that the DHCP server can assign IP addresses of different address pools to the computers in different groups.

The overview of the configurations are as follows:

### 1) Configuring Switch A

- a. Configure 802.1Q VLAN. Add all computers to VLAN 2. For details, refer to [Configuring 802.1Q VLAN](#).
- b. Configure DHCP VLAN relay and enable Option 82 in DHCP Relay. Demonstrated with T1500-28PCT, "4.2.3 Configuring the DHCP Relay Switch" provides configuration procedures to configure DHCP VLAN Relay in two ways: using the GUI and using the CLI.

### 2) Configuring the DHCP Server

The detailed configurations on the DHCP server may be different among different devices. You can refer to the related document that is for the DHCP server you use. Demonstrated with a Linux ISC DHCP Server, "4.2.4 Configuring the DHCP Server" provides information about how to set its DHCP configuration file.



## 4.2.3 Configuring the DHCP Relay Switch

### Using the GUI

Follow these steps to configure DHCP relay and enable Option 82 in DHCP Relay on Switch A:

- 1) Choose the menu **L3 FEATURES > DHCP Service > DHCP Relay > DHCP Relay Config** to load the following page. In the **Global Config** section, enable DHCP Relay, and click **Apply**.

Figure 4-11 Enable DHCP Relay

Global Config

DHCP Relay:  Enable

DHCP Relay Hops:  (1-16)

DHCP Relay Time Threshold:  seconds (0-65535)

- 2) In the **Option 82 Config** section, select port 1/0/1 and port 1/0/2, enable Option 82 Support and set Option 82 Policy as Replace. You can configure other parameters according to your needs. In this example, the Format is set as Normal, and Circuit ID Customization and Remote ID Customization as Disabled. Click **Apply**.

Figure 4-12 Configure Option 82

Option 82 Config

| UNIT1                               |        | LAGS              |                  | Format | Circuit ID Customization | Circuit ID | Remote ID Customization | Remote ID | LAG |
|-------------------------------------|--------|-------------------|------------------|--------|--------------------------|------------|-------------------------|-----------|-----|
| <input type="checkbox"/>            | Port   | Option 82 Support | Option 82 Policy |        |                          |            |                         |           |     |
| <input checked="" type="checkbox"/> | 1/0/1  | Enabled           | Replace          | Normal | Disabled                 |            | Disabled                |           | --- |
| <input checked="" type="checkbox"/> | 1/0/2  | Enabled           | Replace          | Normal | Disabled                 |            | Disabled                |           | --- |
| <input type="checkbox"/>            | 1/0/3  | Disabled          | Keep             | Normal | Disabled                 |            | Disabled                |           | --- |
| <input type="checkbox"/>            | 1/0/4  | Disabled          | Keep             | Normal | Disabled                 |            | Disabled                |           | --- |
| <input type="checkbox"/>            | 1/0/5  | Disabled          | Keep             | Normal | Disabled                 |            | Disabled                |           | --- |
| <input type="checkbox"/>            | 1/0/6  | Disabled          | Keep             | Normal | Disabled                 |            | Disabled                |           | --- |
| <input type="checkbox"/>            | 1/0/7  | Disabled          | Keep             | Normal | Disabled                 |            | Disabled                |           | --- |
| <input type="checkbox"/>            | 1/0/8  | Disabled          | Keep             | Normal | Disabled                 |            | Disabled                |           | --- |
| <input type="checkbox"/>            | 1/0/9  | Disabled          | Keep             | Normal | Disabled                 |            | Disabled                |           | --- |
| <input type="checkbox"/>            | 1/0/10 | Disabled          | Keep             | Normal | Disabled                 |            | Disabled                |           | --- |

Total: 28      2 entries selected.     

- 3) Choose the menu **L3 FEATURES > DHCP Service > DHCP Relay > DHCP VLAN Relay** to load the following page. In the **Default Relay Agent Interface** section, configure the

management VLAN (by default, it is VLAN 1) as the default relay agent interface. Then click **Apply**.

Figure 4-13 Configure the Management VLAN as the Default Relay Agent Interface

Default Relay Agent Interface

---

Interface ID: VLAN 1 (1-4094)

IP Address: 192.168.0.1

Apply

---

DHCP VLAN Relay Config

+ Add - Delete

| <input type="checkbox"/>  | Index | VLAN ID | Server Address |
|---------------------------|-------|---------|----------------|
| No entries in this table. |       |         |                |
| Total: 0                  |       |         |                |

- 4) In the **DHCP VLAN Relay Config** section, click + **Add** to load the configuration page. Specify the VLAN ID as 2, and the Server Address as 192.168.0.59. Click **Create**.

Figure 4-14 Specify a DHCP server for the VLAN

DHCP VLAN Relay

VLAN ID: 2 (1-4094)

Server Address: 192.168.0.59 (Format: 192.168.0.1)

Cancel
Create

- 5) Click Save to save the settings.

## Using the CLI

Follow these steps to configure DHCP relay and enable Option 82 in DHCP Relay on Switch A:

- 1) Enable DHCP Relay.

```
Switch#configure
```

```
Switch(config)#service dhcp relay
```

- 2) Enable Option 82 for port 1/0/1 and port 1/0/2. Set Option 82 policy as **Replace**. You can configure other parameters according to your needs. In this example, the Format is set as Normal, and Circuit ID Customization and Remote ID Customization as Disabled.

```
Switch(config)#interface range gigabitEthernet 1/0/1-2
```

```
Switch(config-if)#ip dhcp relay information option
```

```
Switch(config-if)#ip dhcp relay information strategy replace
```

```
Switch(config-if)#ip dhcp relay information format normal
```

```
Switch(config-if)#exit
```

- 3) Configure the management VLAN (by default, it is VLAN 1) as the default relay agent interface.

```
Switch(config)#interface vlan 1
```

```
Switch(config-if)#ip dhcp relay default-interface
```

```
Switch(config-if)#exit
```

- 4) Specify the DHCP server for the interface VLAN 2.

```
Switch(config)#ip dhcp relay vlan 2 helper-address 192.168.0.59
```

```
Switch(config)#end
```

```
Switch#copy running-config startup-config
```

- 5) Verify the Configurations

**View global settings:**

```
Switch#show ip dhcp relay
```

```
DHCP relay state: enabled
```

```
...
```

DHCP relay helper address is configured on the following interfaces:

| Interface | Helper address |
|-----------|----------------|
| -----     | -----          |
| VLAN 2    | 192.168.0.59   |

```
...
```

**View port settings:**

```
Switch#show ip dhcp relay information interface

Interface Option 82 Status  Operation Strategy  Format  Circuit ID      ...
-----  -
Gi1/0/1  Enable                Replace              Normal  Default:VLAN-POR...
Gi1/0/2  Enable                Replace              Normal  Default:VLAN-POR...
...
```

## 4.2.4 Configuring the DHCP Server

### Note:

- Make sure the DHCP server supports Option 82 and more than one DHCP address pool.
- To make sure the DHCP server can reach the computers, you can create static routes or enable dynamic routing protocol like RIP on the DHCP server.
- In this section, we use different notations to distinguish ASCII strings from hexadecimal numbers. An ASCII string is enclosed with quotation marks, such as "123", while a hexadecimal number is divided by colon into parts of two digits, such as **31:32:33**.

On the DHCP server, you need to create two DHCP classes to identify the Option 82 payloads of DHCP request packets from Group 1 and Group 2, respectively.

In this example, the DHCP relay agent uses the default circuit ID and remote ID in TLV format. According to packet formats described in [Table 1-1](#) and [Table 1-2](#), the sub-options of the two groups are as shown in the following table.

Table 4-1 Sub-options of Group1 and Group 2

| Group | Sub-option | Type (Hex) | Length (Hex) | Value (Hex)       |
|-------|------------|------------|--------------|-------------------|
| 1     | Circuit ID | 00         | 04           | 00:02:00:01       |
|       | Remote ID  | 00         | 06           | 00:00:FF:FF:27:12 |
| 2     | Circuit ID | 00         | 04           | 00:02:00:02       |
|       | Remote ID  | 00         | 06           | 00:00:FF:FF:27:12 |

The configuration file **/etc/dhcpd.conf** of the Linux ISC DHCP Server is:

```
ddns-update-style interim;
ignore client-updates;
```

```
# Create two classes to match the pattern of Option 82 in DHCP request packets from
# Group 1 and Group 2, respectively.
# The agent circuit ID inserted by the DHCP relay switch is 6 bytes long in TLV format, one
# byte for Type, one byte for Length, and 4 bytes for Value. Therefore, the offset is 2 and the
length is 4.
```

```
# Similarly, the offset of the agent remote ID is 2 and the length is 6.
class "VLAN2Port1" {
    match if substring (option agent.circuit-id, 2, 4) = 00:02:00:01
        and substring (option agent.remote-id, 2, 6) = 00:00:ff:ff:27:12;
}

class "VLAN2Port2" {
    match if substring (option agent.circuit-id, 2, 4) = 00:02:00:02
        and substring (option agent.remote-id, 2, 6) = 00:00:ff:ff:27:12;
}

# Create two IP Address pools in the same subnet.
# Assign different IP addresses to the DHCP clients in different groups.
subnet 192.168.0.0 netmask 255.255.255.0 {
    option routers 192.168.0.1;
    option subnet-mask 255.255.255.0;
    option domain-name-servers 192.168.0.59;
    option domain-name "example.com";
    default-lease-time 600;
    max-lease-time 7200;
    authoritative;

    pool {
        range 192.168.0.50 192.168.0.100;
        allow members of "VLAN2Port1";
    }

    pool {
        range 192.168.0.150 192.168.0.200;
        allow members of "VLAN2Port2";
    }
}
```

## 4.3 Example for DHCP L2 Relay

### 4.3.1 Network Requirements

As the following figure shows, two groups of computers are connected to Switch A, and Switch A is connected to the DHCP server. All devices on the network are in the default VLAN 1. All computers get dynamic IP addresses from the DHCP server. For management convenience, the administrator wants to allocate separate address spaces for the two groups of computers.

Figure 4-15 Network Topology for DHCP L2 Relay

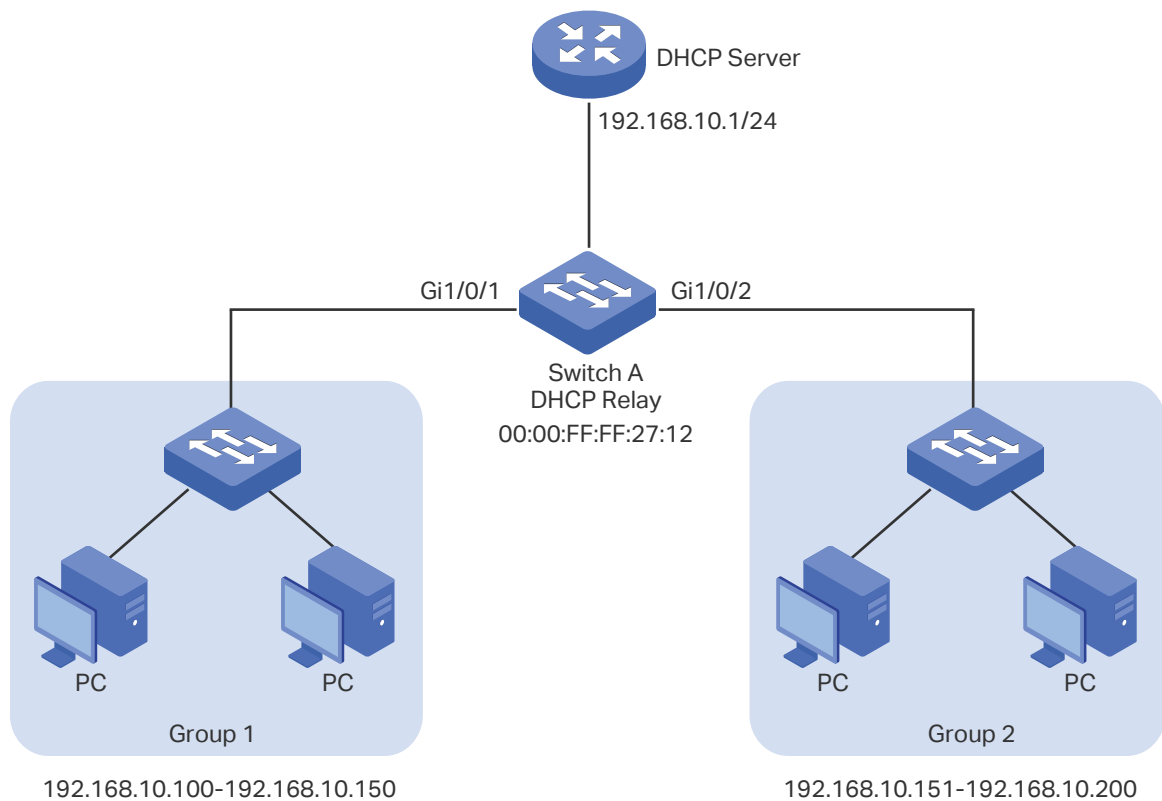

### 4.3.2 Configuration Scheme

To meet the requirements, you can configure DHCP L2 Relay on Switch A to inform the DHCP server of the group information of each PC, so that the DHCP server can assign IP addresses of different address pools to the PCs in different groups.

The overview of the configurations are as follows:

- 1) Configuring Switch A
  - a. Enable DHCP L2 Relay globally and on VLAN 1.
  - b. Configure Option 82 on ports 1/0/1 and 1/0/2.

Demonstrated with T2600G-28TS, "[4.3.3 Configuring the DHCP Relay Switch](#)" provides configuration procedures in two ways: using the GUI and using the CLI.

- 2) Configuring the DHCP Server

The detailed configurations on the DHCP server may be different among different devices. You can refer to the related document that is for the DHCP server you use. Demonstrated with a Linux ISC DHCP Server, "[4.3.4 Configuring the DHCP Server](#)" provides information about how to set its DHCP configuration file.

### 4.3.3 Configuring the DHCP Relay Switch

#### Using the GUI

- 1) Choose the menu **L3 FEATURES > DHCP Service > DHCP L2 Relay > Global Config** to load the following page. In the **Global Config** section, enable DHCP L2 Relay globally and click **Apply**. Enable DHCP L2 Relay on VLAN 1 and click **Apply**.

Figure 4-16 Enabling DHCP L2 Relay



- 2) Choose the menu **L3 FEATURES > DHCP Service > DHCP L2 Relay > Port Config** to load the following page. Select port 1/0/1, enable Option 82 Support and select Option 82 Policy as Replace. You can configure other parameters according to your needs. In this example, keep Format as Normal and Remote ID Customization as Disabled. Enable Circuit ID Customization and specify the Circuit ID as Group1. Click **Apply**.

Figure 4-17 Configuring Port 1/0/1

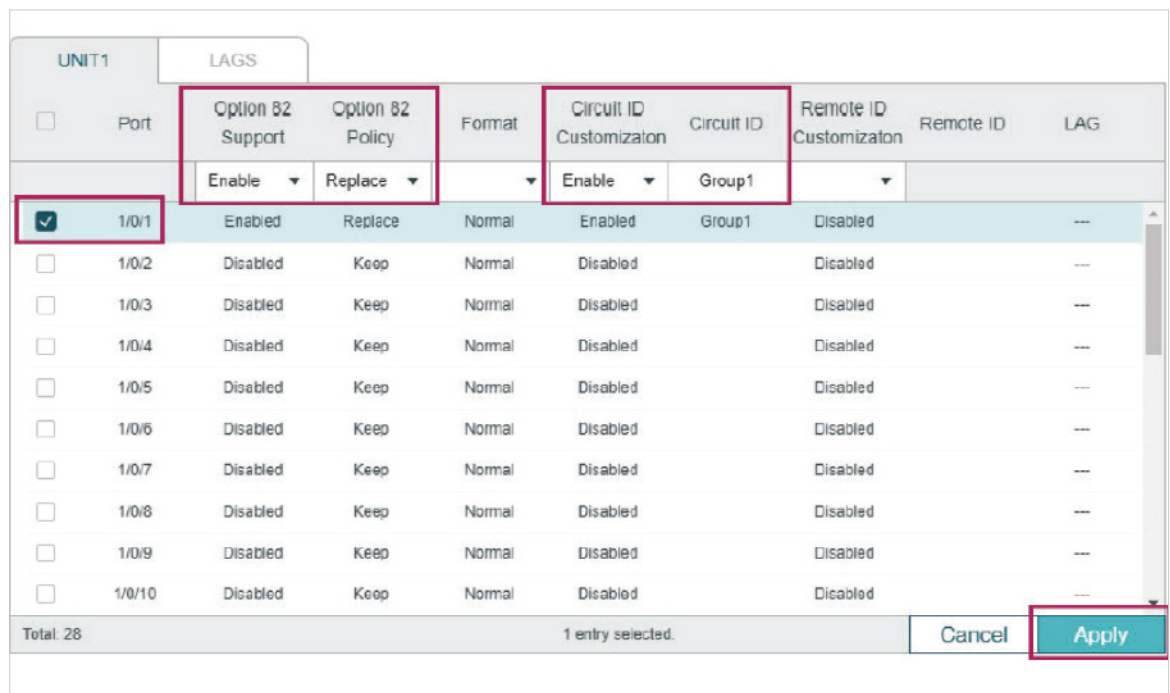

- 3) On the same page, select port 1/0/2, enable Option 82 Support and select Option 82 Policy as Replace. You can configure other parameters according to your needs. In this example, keep Format as Normal and Remote ID Customization as Disabled. Enable Circuit ID Customization and specify the Circuit ID as Group2. Click **Apply**.

Figure 4-18 Configuring Port 1/0/2

| UNIT1                               |        | LAGS              |                  |        |                          |            |                         |           |     |        |       |
|-------------------------------------|--------|-------------------|------------------|--------|--------------------------|------------|-------------------------|-----------|-----|--------|-------|
| <input type="checkbox"/>            | Port   | Option 82 Support | Option 82 Policy | Format | Circuit ID Customization | Circuit ID | Remote ID Customization | Remote ID | LAG |        |       |
|                                     |        | Enable ▾          | Replace ▾        |        | Enable ▾                 | Group2     |                         |           |     |        |       |
| <input type="checkbox"/>            | 1/0/1  | Enabled           | Replace          | Normal | Enabled                  | Group1     | Disabled                |           |     |        |       |
| <input checked="" type="checkbox"/> | 1/0/2  | Enabled           | Replace          | Normal | Enabled                  | Group2     | Disabled                |           |     |        |       |
| <input type="checkbox"/>            | 1/0/3  | Disabled          | Keep             | Normal | Disabled                 |            | Disabled                |           |     |        |       |
| <input type="checkbox"/>            | 1/0/4  | Disabled          | Keep             | Normal | Disabled                 |            | Disabled                |           |     |        |       |
| <input type="checkbox"/>            | 1/0/5  | Disabled          | Keep             | Normal | Disabled                 |            | Disabled                |           |     |        |       |
| <input type="checkbox"/>            | 1/0/6  | Disabled          | Keep             | Normal | Disabled                 |            | Disabled                |           |     |        |       |
| <input type="checkbox"/>            | 1/0/7  | Disabled          | Keep             | Normal | Disabled                 |            | Disabled                |           |     |        |       |
| <input type="checkbox"/>            | 1/0/8  | Disabled          | Keep             | Normal | Disabled                 |            | Disabled                |           |     |        |       |
| <input type="checkbox"/>            | 1/0/9  | Disabled          | Keep             | Normal | Disabled                 |            | Disabled                |           |     |        |       |
| <input type="checkbox"/>            | 1/0/10 | Disabled          | Keep             | Normal | Disabled                 |            | Disabled                |           |     |        |       |
| Total: 28                           |        |                   |                  |        | 1 entry selected.        |            |                         |           |     | Cancel | Apply |

- 4) Click  to save the settings.

## Using the CLI

- 1) Enable DHCP L2 Relay globally and on VLAN1.

```
Switch#configure
```

```
Switch(config)#ip dhcp l2relay
```

```
Switch(config)#ip dhcp l2relay vlan 1
```

- 2) On port 1/0/1, enable Option 82 and select Option 82 Policy as Replace. You can configure other parameters according to your needs. In this example, keep Format as Normal and Remote ID Customization as Disabled. Enable Circuit ID Customization and specify the Circuit ID as Group1.

```
Switch(config)#interface gigabitEthernet 1/0/1
```

```
Switch(config-if)#ip dhcp l2relay information option
```

```
Switch(config-if)#ip dhcp l2relay information strategy replace
```

```
Switch(config-if)#ip dhcp l2relay information circuit-id Group1
```

```
Switch(config-if)#exit
```

- 3) On port 1/0/2, enable Option 82 and select Option 82 Policy as Replace. You can configure other parameters according to your needs. In this example, keep Format as



Normal and Remote ID Customization as Disabled. Enable Circuit ID Customization and specify the Circuit ID as Group2.

```
Switch(config)#interface gigabitEthernet 1/0/2
```

```
Switch(config-if)#ip dhcp l2relay information
```

```
Switch(config-if)#ip dhcp l2relay information strategy replace
```

```
Switch(config-if)#ip dhcp l2relay information circuit-id Group2
```

```
Switch(config-if)#end
```

```
Switch#copy running-config startup-config
```

## Verify the Configurations

### View global settings:

```
Switch#show ip dhcp l2relay
```

```
Global Status: Enable
```

```
VLAN ID: 1
```

### View port settings:

```
Switch#show ip dhcp l2relay information interface gigabitEthernet 1/0/1
```

```
Interface Option 82 Status Operation Strategy Format Circuit ID ...
```

```
-----
```

```
Gi1/0/1 Enable Replace Normal Group1 ...
```

```
Switch#show ip dhcp l2relay information interface gigabitEthernet 1/0/1
```

```
Interface Option 82 Status Operation Strategy Format Circuit ID ...
```

```
-----
```

```
Gi1/0/2 Enable Replace Normal Group2 ...
```

## 4.3.4 Configuring the DHCP Server

### Note:

- Make sure the DHCP server supports Option 82 and more than one DHCP address pool.
- To make sure the DHCP server can reach the computers, you can create static routes or enable dynamic routing protocol like RIP on the DHCP server.
- In this section, we use different notations to distinguish ASCII strings from hexadecimal numbers. An ASCII string is enclosed with quotation marks, such as "123", while a hexadecimal number is divided by colon into parts of two digits, such as **31:32:33**.

On the DHCP server, you need to create two DHCP classes to identify the Option 82 payloads of DHCP request packets from Group 1 and Group 2, respectively.

In this example, the DHCP relay agent uses the customized circuit ID and default remote ID in TLV format. According to packet format described in [Table 1-1](#) and [Table 1-2](#), the sub-options of the two groups are as shown in the following table.

Table 4-2 Sub-options of Group1 and Group 2

| Group | Sub-option | Type (Hex) | Length (Hex) | Value  |
|-------|------------|------------|--------------|--|
| 1     | Circuit ID | 00         | 06           | "Group1" as an ASCII string (or <b>47:72:6F:75:70:31</b> in hexadecimal) |
|       | Remote ID  | 00         | 06           | 00:00:FF:FF:27:12  |
| 2     | Circuit ID | 00         | 06           | "Group2" as an ASCII string (or <b>47:72:6F:75:70:32</b> in hexadecimal) |
|       | Remote ID  | 00         | 06           | 00:00:FF:FF:27:12  |

The configuration file **/etc/dhcpd.conf** of the Linux ISC DHCP Server is:

```
ddns-update-style interim;
```

```
ignore client-updates;
```

```
# Create two classes to match the pattern of Option 82 in DHCP request packets from  
# Group 1 and Group 2, respectively.
```

```
# The agent circuit ID inserted by the DHCP relay switch is 8 byte long in TLV format, one  
# byte for Type, one byte for Length, and 6 bytes for Value. Therefore, the offset is 2 and the  
length is 6.
```

```
# Similarly, the offset of the agent remote ID is 2 and the length is 6.
```

```
class "Group1" {  
    match if substring (option agent.circuit-id, 2, 6) = "Group1"  
        and substring (option agent.remote-id, 2, 6) = 00:00:ff:ff:27:12;  
}
```

```
class "Group2" {  
    match if substring (option agent.circuit-id, 2, 6) = "Group2"  
        and substring (option agent.remote-id, 2, 6) = 00:00:ff:ff:27:12;  
}
```

```
# Create two IP Address pools in the same subnet.
```

```
# Assign different IP addresses to the DHCP clients in different groups.
```

```
subnet 192.168.10.0 netmask 255.255.255.0 {  
    option routers 192.168.10.1;  
    option subnet-mask 255.255.255.0;  
    option domain-name-servers 192.168.10.1;
```

```
option domain-name "example.com";
default-lease-time 600;
max-lease-time 7200;
authoritative;

pool {
  range 192.168.10.100 192.168.10.150;
  allow members of "Group1";
}

pool {
  range 192.168.10.151 192.168.10.200;
  allow members of "Group2";
}
```

# 5 Appendix: Default Parameters

Default settings of DHCP Relay are listed in the following table.

Table 5-1 Default Settings of DHCP Relay

| Parameter                 | Default Setting |
|---------------------------|-----------------|
| DHCP Relay                |                 |
| DHCP Relay                | Disabled        |
| DHCP Relay Hops           | 4               |
| DHCP Relay Time Threshold | 0               |
| Option 82 Configuration   |                 |
| Option 82 Support         | Disabled        |
| Option 82 Policy          | Keep            |
| Format                    | Normal          |
| Circuit ID Customization  | Disabled        |
| Circuit ID                | None            |
| Remote ID Customization   | Disabled        |
| Remote ID                 | None            |
| DHCP VLAN Relay           |                 |
| Interface ID              | None            |
| VLAN ID                   | None            |
| Server Address            | None            |

Default settings of DHCP L2 Relay are listed in the following table.

Table 5-2 Default Settings of DHCP L2 Relay

| Parameter     | Default Setting |
|---------------|-----------------|
| Global Config |                 |
| DHCP Relay    | Disabled        |

| Parameter                | Default Setting |
|--------------------------|-----------------|
| VLAN Status              | Disabled        |
| Port Config              |                 |
| Option 82 Support        | Disabled        |
| Option 82 Policy         | Keep            |
| Format                   | Normal          |
| Circuit ID Customization | Disabled        |
| Circuit ID               | None            |
| Remote ID Customization  | Disabled        |
| Remote ID                | None            |

# Part 14

## Configuring QoS

### CHAPTERS

1. QoS
2. Class of Service Configuration
3. Bandwidth Control Configuration
4. Voice VLAN Configuration
5. Auto VoIP Configuration
6. Configuration Examples
7. Appendix: Default Parameters

# 1 QoS

## 1.1 Overview

With network scale expanding and applications developing, internet traffic is dramatically increased, thus resulting in network congestion, packet drops and long transmission delay. Typically, networks treat all traffic equally on FIFO (First In First Out) delivery basis, but nowadays many special applications like VoD, video conferences, VoIP, etc, require more bandwidth or shorter transmission delay to guarantee the performance.

With QoS (Quality of Service) technology, you can classify and prioritize network traffic to provide differentiated services to certain types of traffic.

## 1.2 Supported Features

You can configure the class of service, bandwidth control, Voice VLAN and Auto VoIP features on the switch to maximize the network performance and bandwidth utilization.

### Class of Service

The switch classifies the ingress packets, maps the packets to different priority queues and then forwards the packets according to specified scheduler settings to implement QoS function.

- Priority Mode: Three modes are supported, Port Priority, 802.1p Priority and DSCP Priority.
- Scheduler Mode: Two scheduler types are supported, Strict and Weighted.

### Bandwidth Control

Bandwidth Control functions to control the traffic rate and traffic threshold on each port to ensure network performance.

- Rate limit functions to limit the ingress/egress traffic rate on each port. In this way, the network bandwidth can be reasonably distributed and utilized.
- Storm Control function allows the switch to monitor broadcast packets, multicast packets and UL-frames (Unknown unicast frames) in the network. If the transmission rate of the packets exceeds the set rate, the packets will be automatically discarded to avoid network broadcast storm.

### Voice VLAN and Auto VoIP

The voice VLAN and Auto VoIP features are used to prioritize the transmission of voice traffic. Voice traffic is typically more time-sensitive than data traffic, and the voice quality

can deteriorate a lot because of packet loss and delay. To ensure the high voice quality, you can configure Voice VLAN or Auto VoIP.

These two features can be enabled on the ports that transmit voice traffic only or transmit both voice traffic and data traffic. Voice VLAN can change the voice packets' 802.1p priority and transmit the packets in desired VLAN. Auto VoIP can inform the voice devices of send the packets with specific configuration by working with the LLDP-MED feature.



# 2 Class of Service Configuration

With class of service configurations, you can:

- Configure port priority
- Configure 802.1p priority
- Configure DSCP priority
- Specify the scheduler settings

## Configuration Guidelines

- Select the priority mode that the ports trust according to your network requirements.  
A port can use only one priority to classify the ingress packets. Three priority modes are supported on the switch: Port Priority, 802.1P Priority and DSCP Priority.
  - Port Priority  
In this mode, the switch prioritizes packets according to their ingress ports, regardless of the packet field or type.
  - 802.1P Priority  
802.1P defines the first three bits in 802.1Q Tag as PRI field. The PRI values are from 0 to 7. 802.1P priority determines the priority of packets based on the PRI value.  
In this mode, the switch only prioritizes packets with VLAN tag, regardless of the IP header of the packets.
  - DSCP Priority  
DSCP priority determines the priority of packets based on the ToS (Type of Service) field in their IP header. RFC2474 re-defines the ToS field in the IP packet header as DS field. The first six bits (bit 0-bit 5) of the DS field is used to represent DSCP priority. The DSCP values are from 0 to 63.  
In this mode, the switch only prioritizes IP packets.
- Specify the 802.1p to queue mapping according to your needs.  
For 802.1p Priority, the packets will be forwarded according to the 802.1p to queue mapping directly.  
For Port Priority and DSCP Priority, the port priority and DSCP priority will first be mapped to the 802.1p priority, and then mapped to the queue according to the 802.1p to queue mapping.

## 2.1 Using the GUI

### 2.1.1 Configuring Port Priority

- Configuring the Trust Mode and Port to 802.1p Mapping

Choose the menu **QoS > Class of Service > Port Priority** to load the following page.

Figure 2-1 Configuring the Trust Mode and Port to 802.1p Mapping

Port Priority Config

UNIT1 | LAGS

| <input type="checkbox"/>            | Port   | 802.1p Priority | Trust Mode | LAG |
|-------------------------------------|--------|-----------------|------------|-----|
| <input checked="" type="checkbox"/> | 1/0/1  | 0               | Untrusted  | --  |
| <input type="checkbox"/>            | 1/0/2  | 0               | Untrusted  | --  |
| <input type="checkbox"/>            | 1/0/3  | 0               | Untrusted  | --  |
| <input type="checkbox"/>            | 1/0/4  | 0               | Untrusted  | --  |
| <input type="checkbox"/>            | 1/0/5  | 0               | Untrusted  | --  |
| <input type="checkbox"/>            | 1/0/6  | 0               | Untrusted  | --  |
| <input type="checkbox"/>            | 1/0/7  | 0               | Untrusted  | --  |
| <input type="checkbox"/>            | 1/0/8  | 0               | Untrusted  | --  |
| <input type="checkbox"/>            | 1/0/9  | 0               | Untrusted  | --  |
| <input type="checkbox"/>            | 1/0/10 | 0               | Untrusted  | --  |

Total: 28 | 1 entry selected. | Cancel | Apply

Follow these steps to configure the parameters of the port priority:

- 1) Select the desired ports, specify the 802.1p priority and set the trust mode as Untrusted.

#### 802.1p Priority

Specify the port to 802.1p mapping for the desired port. The ingress packets from one port are first mapped to 802.1p priority based on the port to 802.1p mapping, then to TC queues based on the 802.1p to queue mapping. The untagged packets from one port will be added an 802.1p priority value according to the port to 802.1p priority mapping.

#### Trust Mode

Select the Trust mode as Untrusted. In this mode, the packets will be processed according to the port priority configuration.

- 2) Click **Apply**.

## ■ Configuring the 802.1p to Queue Mapping

Choose the menu **QoS > Class of Service > 802.1p Priority** to load the following page.

Figure 2-2 Configuring the 802.1p to Queue Mapping

### 802.1p to Queue Mapping

| 802.1p Priority | Queue                             |
|-----------------|-----------------------------------|
| 0:              | <input type="text" value="TC-1"/> |
| 1:              | <input type="text" value="TC-0"/> |
| 2:              | <input type="text" value="TC-2"/> |
| 3:              | <input type="text" value="TC-3"/> |
| 4:              | <input type="text" value="TC-4"/> |
| 5:              | <input type="text" value="TC-5"/> |
| 6:              | <input type="text" value="TC-6"/> |
| 7:              | <input type="text" value="TC-7"/> |

### 802.1p Remap

| 802.1p Priority | Remap                          |
|-----------------|--------------------------------|
| 0:              | <input type="text" value="0"/> |
| 1:              | <input type="text" value="1"/> |
| 2:              | <input type="text" value="2"/> |
| 3:              | <input type="text" value="3"/> |
| 4:              | <input type="text" value="4"/> |
| 5:              | <input type="text" value="5"/> |
| 6:              | <input type="text" value="6"/> |
| 7:              | <input type="text" value="7"/> |

In the **802.1p to Queue Mapping** section, configure the mappings and click **Apply**.

#### 802.1p Priority

Displays the number of 802.1p priority. In QoS, 802.1p priority is used to represent class of service.

#### Queue

Select the TC queue for the desired 802.1p priority. The packets with the desired 802.1p priority will be put in the corresponding queue.

## 2.1.2 Configuring 802.1p Priority

### ■ Configuring the Trust Mode

Choose the menu **QoS > Class of Service > Port Priority** to load the following page.

Figure 2-3 Configuring the Trust Mode

Port Priority Config

---

UNIT1

LAGS

|                                     | Port   | 802.1p Priority | Trust Mode | LAG |
|-------------------------------------|--------|-----------------|------------|-----|
| <input checked="" type="checkbox"/> | 1/0/1  | 0               | Untrusted  | --  |
| <input type="checkbox"/>            | 1/0/2  | 0               | Untrusted  | --  |
| <input type="checkbox"/>            | 1/0/3  | 0               | Untrusted  | --  |
| <input type="checkbox"/>            | 1/0/4  | 0               | Untrusted  | --  |
| <input type="checkbox"/>            | 1/0/5  | 0               | Untrusted  | --  |
| <input type="checkbox"/>            | 1/0/6  | 0               | Untrusted  | --  |
| <input type="checkbox"/>            | 1/0/7  | 0               | Untrusted  | --  |
| <input type="checkbox"/>            | 1/0/8  | 0               | Untrusted  | --  |
| <input type="checkbox"/>            | 1/0/9  | 0               | Untrusted  | --  |
| <input type="checkbox"/>            | 1/0/10 | 0               | Untrusted  | --  |

Total: 28
1 entry selected.

Cancel
Apply

Follow these steps to configure the trust mode:

- 1) Select the desired ports and set the trust mode as Trust 802.1p.

#### Trust Mode

Select the Trust mode as Trust 802.1p. In this mode, the tagged packets will be processed according to the 802.1p priority configuration and the untagged packets will be processed according to the port priority configuration.

- 2) Click **Apply**.

## ■ Configuring the 802.1p to Queue Mapping and 802.1p Remap

Choose the menu **QoS > Class of Service > 802.1p Priority** to load the following page.

Figure 2-4 Configuring the 802.1p to Queue Mapping and 802.1p Remap

### 802.1p to Queue Mapping

| 802.1p Priority | Queue                             |
|-----------------|-----------------------------------|
| 0:              | <input type="text" value="TC-1"/> |
| 1:              | <input type="text" value="TC-0"/> |
| 2:              | <input type="text" value="TC-2"/> |
| 3:              | <input type="text" value="TC-3"/> |
| 4:              | <input type="text" value="TC-4"/> |
| 5:              | <input type="text" value="TC-5"/> |
| 6:              | <input type="text" value="TC-6"/> |
| 7:              | <input type="text" value="TC-7"/> |

### 802.1p Remap

| 802.1p Priority | Remap                          |
|-----------------|--------------------------------|
| 0:              | <input type="text" value="0"/> |
| 1:              | <input type="text" value="1"/> |
| 2:              | <input type="text" value="2"/> |
| 3:              | <input type="text" value="3"/> |
| 4:              | <input type="text" value="4"/> |
| 5:              | <input type="text" value="5"/> |
| 6:              | <input type="text" value="6"/> |
| 7:              | <input type="text" value="7"/> |

Follow these steps to configure the parameters of the 802.1p priority:

- 1) In the **802.1p to Queue Mapping** section, configure the mappings and click **Apply**.

|                        |  |
|------------------------|--|
| <b>802.1p Priority</b> | Displays the number of 802.1p priority. In QoS, 802.1p priority is used to represent class of service. IEEE 802.1p standard defines three bits in 802.1Q tag as PRI field. The PRI values are called 802.1p priority and used to represent the priority of the layer 2 packets. This function requires packets with VLAN tags. |
|------------------------|--|

|              |   |
|--------------|---|
| <b>Queue</b> | Select the TC queue for the desired 802.1p priority. The packets with the desired 802.1p priority will be put in the corresponding queue. |
|--------------|---|

- 2) (Optional) In the **802.1p Remap** section, configure the 802.1p to 802.1p mappings and click **Apply**.

|                        |  |
|------------------------|--|
| <b>802.1p Priority</b> | Displays the number of 802.1p priority. In QoS, 802.1p priority is used to represent class of service. IEEE 802.1p standard defines three bits in 802.1Q tag as PRI field. The PRI values are called 802.1p priority and used to represent the priority of the layer 2 packets. This function requires packets with VLAN tags. |
|------------------------|--|

**Remap** Select the number of 802.1p priority to which the original 802.1p priority will be remapped. 802.1p Remap is used to modify the 802.1p priority of the ingress packets. When the switch detects the packets with desired 802.1p priority, it will modify the value of 802.1p priority according to the map.

 **Note:**

In Trust 802.1p mode, the untagged packets will be added an 802.1p priority based on the port to 802.1p mapping and will be forwarded according to the 802.1p to queue mapping.

### 2.1.3 Configuring DSCP Priority

■ **Configuring the Trust Mode**

Choose the menu **QoS > Class of Service > Port Priority** to load the following page.

Figure 2-5 Configuring the Trust Mode

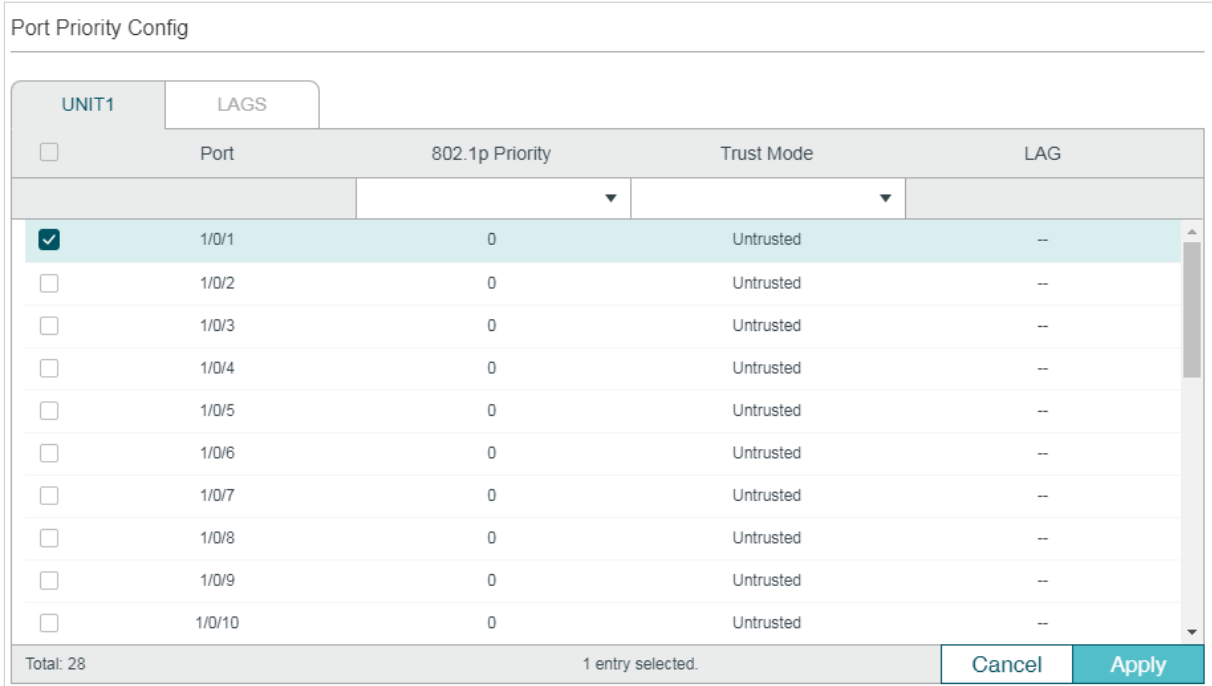

| Port Priority Config                |        |                 |            |     |
|-------------------------------------|--------|-----------------|------------|-----|
| UNIT1                               |        | LAGS            |            |     |
| <input type="checkbox"/>            | Port   | 802.1p Priority | Trust Mode | LAG |
| <input checked="" type="checkbox"/> | 1/0/1  | 0               | Untrusted  | --  |
| <input type="checkbox"/>            | 1/0/2  | 0               | Untrusted  | --  |
| <input type="checkbox"/>            | 1/0/3  | 0               | Untrusted  | --  |
| <input type="checkbox"/>            | 1/0/4  | 0               | Untrusted  | --  |
| <input type="checkbox"/>            | 1/0/5  | 0               | Untrusted  | --  |
| <input type="checkbox"/>            | 1/0/6  | 0               | Untrusted  | --  |
| <input type="checkbox"/>            | 1/0/7  | 0               | Untrusted  | --  |
| <input type="checkbox"/>            | 1/0/8  | 0               | Untrusted  | --  |
| <input type="checkbox"/>            | 1/0/9  | 0               | Untrusted  | --  |
| <input type="checkbox"/>            | 1/0/10 | 0               | Untrusted  | --  |

Total: 28      1 entry selected.      Cancel Apply

Follow these steps to configure the trust mode:

- 1) Select the desired ports and set the trust mode as Trust DSCP.

**Trust Mode** Select the Trust mode as Trust DSCP. In this mode, the IP packets will be processed according to the DSCP priority configuration and the non-IP packets will be processed according to the port priority configuration.

- 2) Click **Apply**.

## ■ Configuring the 802.1p to Queue Mapping

Choose the menu **QoS > Class of Service > 802.1p Priority** to load the following page.

Figure 2-6 Configuring the 802.1p to Queue Mapping

### 802.1p to Queue Mapping

| 802.1p Priority | Queue                             |
|-----------------|-----------------------------------|
| 0:              | <input type="text" value="TC-1"/> |
| 1:              | <input type="text" value="TC-0"/> |
| 2:              | <input type="text" value="TC-2"/> |
| 3:              | <input type="text" value="TC-3"/> |
| 4:              | <input type="text" value="TC-4"/> |
| 5:              | <input type="text" value="TC-5"/> |
| 6:              | <input type="text" value="TC-6"/> |
| 7:              | <input type="text" value="TC-7"/> |

### 802.1p Remap

| 802.1p Priority | Remap                          |
|-----------------|--------------------------------|
| 0:              | <input type="text" value="0"/> |
| 1:              | <input type="text" value="1"/> |
| 2:              | <input type="text" value="2"/> |
| 3:              | <input type="text" value="3"/> |
| 4:              | <input type="text" value="4"/> |
| 5:              | <input type="text" value="5"/> |
| 6:              | <input type="text" value="6"/> |
| 7:              | <input type="text" value="7"/> |

In the **802.1p to Queue Mapping** section, configure the mappings and click **Apply**.

#### 802.1p Priority

Displays the number of 802.1p priority. In QoS, 802.1p priority is used to represent class of service.

#### Queue

Select the TC queue for the desired 802.1p priority. The packets with the desired 802.1p priority will be put in the corresponding queue.





## 2.1.4 Specifying the Scheduler Settings

Specify the scheduler settings to control the forwarding sequence of different TC queues when congestion occurs.

Choose the menu **QoS > Class of Service > Scheduler Settings** to load the following page.

Figure 2-8 Specifying the Scheduler Settings

**Scheduler Config**

UNIT1      LAGS

2

4

6

8

10

12

14

16

18

20

22

24

26

28

1

3

5

7

9

11

13

15

17

19

21

23

25

27

Selected

Unselected

Not Available

Port 1/0/1

| <input type="checkbox"/>            | Queue TC-id | Scheduler Type    | Queue Weight | Management Type   |
|-------------------------------------|-------------|-------------------|--------------|---|
| <input checked="" type="checkbox"/> | 0           | Weighted          | 1            | Taildrop  |
| <input type="checkbox"/>            | 1           | Weighted          | 1            | Taildrop  |
| <input type="checkbox"/>            | 2           | Weighted          | 1            | Taildrop  |
| <input type="checkbox"/>            | 3           | Weighted          | 1            | Taildrop  |
| <input type="checkbox"/>            | 4           | Weighted          | 1            | Taildrop  |
| <input type="checkbox"/>            | 5           | Weighted          | 1            | Taildrop  |
| <input type="checkbox"/>            | 6           | Weighted          | 1            | Taildrop  |
| <input type="checkbox"/>            | 7           | Weighted          | 1            | Taildrop  |
| Total: 8                            |             | 1 entry selected. |              | <input type="button" value="Cancel"/> <input style="background-color: #00a0c0; color: white;" type="button" value="Apply"/> |

Follow these steps to configure the schedule mode:

- 1) In the **Scheduler Config** section, select the desired port.
- 2) Select the desired queue and configure the parameters.

|                    |   |
|--------------------|---|
| <b>Queue TC-id</b> | Displays the ID number of priority Queue. |
|--------------------|---|

User Guide ■ 446

|                 |   |
|-----------------|---|
| Scheduler Type  | <p>Select the type of scheduling used for corresponding queue. When the network congestion occurs, the egress queue will determine the forwarding sequence of the packets according to the type.</p> <p><b>Strict:</b> In this mode, the egress queue will use SP (Strict Priority) to process the traffic in different queues. When congestion occurs, the traffic will be transmitted according to its queue priority strictly. The queue with higher priority occupies the whole bandwidth. Packets in the queue with lower priority are sent only when the queue with higher priority is empty.</p> <p><b>Weighted:</b> In this mode, the egress queue will use WRR (Weighted Round Robin) to process the traffic in different queues. When congestion occurs, all the traffic will be transmitted, but the bandwidth that each traffic queue occupies will be allocated based on the queue weight.</p> |
| Queue Weight    | Specify the queue weight for the desired queue. This value can be set only in the Weighted mode. The valid values are from 1 to 127.  |
| Management Type | Displays the Management Type for the queues. The switch supports Taildrop mode. When the traffic exceeds the limit, the additional traffic will be dropped.   |

### 3) Click **Apply**.

#### Note:

With ACL Redirect feature, the switch maps all the packets that meet the configured ACL rules to the new TC queue, regardless of the mapping relations configured in this section.

## 2.2 Using CLI

### 2.2.1 Configuring Port Priority

#### ■ Configuring the Trust Mode and the port to 802.1p Mapping

Follow these steps to configure the trust mode and the port to 802.1p mapping:

|        |   |
|--------|---|
| Step 1 | <p><b>configure</b></p> <p>Enter global configuration mode</p>  |
| Step 2 | <p><b>interface {fastEthernet port   range fastEthernet port-list   gigabitEthernet port   range gigabitEthernet port-list   ten-gigabitEthernet port   range ten-gigabitEthernet port-list   port-channel port-channel-id   range port-channel port-channel-list}</b></p> <p>Enter interface configuration mode.</p>         |
| Step 3 | <p><b>qos trust mode {untrust   dot1p   dscp}</b></p> <p>Select the trust mode for the port. By default, it is untrust. Here we set the trust mode as untrust.</p> <p><i>untrust:</i> Specify the ports' trust mode as untrust. In this mode, the packets will be processed according to the port priority configuration.</p> |

---

|        |   |
|--------|---|
| Step 4 | <b>qos port-priority {dot1p-priority}</b><br>Specify the port to 802.1p priority mapping for the desired port. The ingress packets from one port are first mapped to 802.1p priority based on the port to 802.1p mapping, then to TC queues based on the 802.1p to queue mapping. The untagged packets from one port will be added an 802.1p priority value according to the port to 802.1p mapping.<br><br><i>dot1p-priority:</i> Specify the 802.1p priority ranging from 0 to 7. The default value is 0. |
| Step 5 | <b>show qos trust interface [fastEthernet port   gigabitEthernet port   ten-gigabitEthernet port   port-channel port-channel-id]</b><br>Verify the trust mode of the ports.   |
| Step 6 | <b>show qos port-priority interface [fastEthernet port   gigabitEthernet port   ten-gigabitEthernet port   port-channel port-channel-id]</b><br>Verify the port to 802.1p mappings.   |
| Step 7 | <b>end</b><br>Return to privileged EXEC mode.   |
| Step 8 | <b>copy running-config startup-config</b><br>Save the settings in the configuration file.   |

---

## ■ Configuring the 802.1p to Queue Mapping

Follow these steps to configure the 802.1p to queue mapping:

---

|        |   |
|--------|---|
| Step 1 | <b>configure</b><br>Enter global configuration mode   |
| Step 2 | <b>qos cos-map {dot1p-priority} {tc-queue}</b><br>Specify the 802.1p to queue mapping. The packets with the desired 802.1p priority will be put in the corresponding queues. By default, the 802.1p priority 0 to 7 is respectively mapped to TC-1, TC-0, TC-2, TC-3, TC-4, TC-5, TC-6, TC-7.<br><br><i>dot1p-priority:</i> Specify the 802.1p priority. The valid values are from 0 to 7.<br><br><i>tc-queue:</i> Specify the ID number of the TC queue. The valid values are from 0 to 7. |
| Step 3 | <b>show qos cos-map</b><br>Verify the 802.1p to queue mappings.   |
| Step 4 | <b>end</b><br>Return to privileged EXEC mode.   |
| Step 5 | <b>copy running-config startup-config</b><br>Save the settings in the configuration file.   |

---

The following example shows how to configure the trust mode of port 1/0/1 as untrust, map the port 1/0/1 to 802.1p priority 1 and map 802.1p priority 1 to TC3:

```
Switch#configure
```

```
Switch(config)#interface gigabitEthernet 1/0/1
```

```
Switch(config-if)#qos trust mode untrust
```

```
Switch(config-if)#qos port-priority 1
```

```
Switch(config-if)#exit
```

```
Switch(config)#qos cos-map 1 3
```

```
Switch(config)#show qos trust interface gigabitEthernet 1/0/1
```

| Port    | Trust Mode | LAG   |
|---------|------------|-------|
| -----   | -----      | ----- |
| Gi1/0/1 | untrust    | N/A   |

```
Switch(config)#show qos port-priority interface gigabitEthernet 1/0/1
```

| Port    | CoS Value | LAG   |
|---------|-----------|-------|
| -----   | -----     | ----- |
| Gi1/0/1 | CoS 1     | N/A   |

```
Switch(config)#show qos cos-map
```

| Dot1p Value | 0     | 1     | 2     | 3     | 4     | 5     | 6     | 7     |
|-------------|-------|-------|-------|-------|-------|-------|-------|-------|
| -----       | ----- | ----- | ----- | ----- | ----- | ----- | ----- | ----- |
| TC          | TC0   | TC3   | TC2   | TC3   | TC4   | TC5   | TC6   | TC7   |
| -----       | ----- | ----- | ----- | ----- | ----- | ----- | ----- | ----- |

```
Switch(config)#end
```

```
Switch#copy running-config startup-config
```

## 2.2.2 Configuring 802.1p Priority

### ■ Configuring the Trust Mode

Follow these steps to configure the trust mode:

---

|        |                                 |
|--------|---------------------------------|
| Step 1 | <b>configure</b>                |
|        | Enter global configuration mode |

---

|        |   |
|--------|---|
| Step 2 | <p><b>interface</b> {<i>fastEthernet port</i>   <b>range</b> <i>fastEthernet port-list</i>   <b>gigabitEthernet</b> <i>port</i>   <b>range</b> <i>gigabitEthernet port-list</i>   <b>ten-gigabitEthernet</b> <i>port</i>   <b>range</b> <i>ten-gigabitEthernet port-list</i>   <b>port-channel</b> <i>port-channel-id</i>   <b>range</b> <i>port-channel port-channel-list</i>}</p> <p>Enter interface configuration mode.</p>                |
| Step 3 | <p><b>qos trust mode</b> {<i>untrust</i>   <i>dot1p</i>   <i>dscp</i>}</p> <p>Select the trust mode for the port. By default, it is untrust. Here we set the trust mode as dot1p.</p> <p><i>dot1p</i>: Specify the ports' trust mode as dot1p. In this mode, the tagged packets will be processed according to the 802.1p priority configuration and the untagged packets will be processed according to the port priority configuration.</p> |
| Step 4 | <p><b>show qos trust interface</b> [<i>fastEthernet port</i>   <i>gigabitEthernet port</i>   <i>ten-gigabitEthernet port</i>   <i>port-channel port-channel-id</i>]</p> <p>Verify the trust mode of the ports.</p>  |
| Step 5 | <p><b>end</b></p> <p>Return to privileged EXEC mode.</p>  |
| Step 6 | <p><b>copy running-config startup-config</b></p> <p>Save the settings in the configuration file.</p>  |

## ■ Configuring the 802.1p to Queue Mapping and 802.1p Remap

Follow these steps to configure the 802.1p to queue mapping and 802.1p remap:

|        |  |
|--------|--|
| Step 1 | <p><b>configure</b></p> <p>Enter global configuration mode</p>   |
| Step 2 | <p><b>qos cos-map</b> {<i>dot1p-priority</i>} {<i>tc-queue</i>}</p> <p>Specify the 802.1p to queue mapping. The packets with the desired 802.1p priority will be put in the corresponding queues. By default, the 802.1p priority 0 to 7 is respectively mapped to TC-1, TC-0, TC-2, TC-3, TC-4, TC-5, TC-6, TC-7.</p> <p><i>dot1p-priority</i>: Specify the 802.1p priority. The valid values are from 0 to 7.</p> <p><i>tc-queue</i>: Specify the ID number of the TC queue. The valid values are from 0 to 7.</p>   |
| Step 3 | <p><b>qos dot1p-remap</b> {<i>dot1p-priority</i>} {<i>new-dot1p-priority</i>}</p> <p>(Optional) Specify the 802.1p to 802.1p mappings. 802.1p Remap is used to modify the 802.1p priority of the ingress packets. When the switch detects the packets with desired 802.1p priority, it will modify the value of 802.1p priority according to the map. By default, the original 802.1p priority 0 is mapped to the 802.1p priority 0, the original 802.1p priority 1 is mapped to the 802.1p priority 1 and so on.</p> <p><i>dot1p-priority</i>: Specify the original 802.1p priority. The valid values are from 0 to 7.</p> <p><i>new-dot1p-priority</i>: Specify the new 802.1p priority. The valid values are from 0 to 7.</p> |
| Step 4 | <p><b>show qos cos-map</b></p> <p>Verify the 802.1p to queue mappings.</p>   |

Step 5 **show qos dot1p-remap**  
Verify the 802.1p to 802.1p mappings.

Step 6 **end**  
Return to privileged EXEC mode.

Step 7 **copy running-config startup-config**  
Save the settings in the configuration file.

 **Note:**

In Trust 802.1p mode, the untagged packets will be added an 802.1p priority based on the port to 802.1p mapping and will be forwarded according to the 802.1p to queue mapping.

The following example shows how to configure the trust mode of port 1/0/1 as dot1p, map 802.1p priority 3 to TC4, and configure to map the original 802.1p 1 to 802.1p priority 3:

**Switch#configure**

**Switch(config)#interface gigabitEthernet 1/0/1**

**Switch(config-if)#qos trust mode dot1p**

**Switch(config-if)#exit**

**Switch(config)#qos cos-map 3 4**

**Switch(config)#qos dot1p-remap 1 3**

**Switch(config)#show qos trust interface gigabitEthernet 1/0/1**

| Port    | Trust Mode   | LAG   |
|---------|--------------|-------|
| -----   | -----        | ----- |
| Gi1/0/1 | trust 802.1P | N/A   |

**Switch(config)#show qos cos-map**

| Dot1p Value | 0     | 1     | 2     | 3     | 4     | 5     | 6     | 7     |
|-------------|-------|-------|-------|-------|-------|-------|-------|-------|
| -----       | ----- | ----- | ----- | ----- | ----- | ----- | ----- | ----- |
| TC          | TC0   | TC1   | TC2   | TC4   | TC4   | TC5   | TC6   | TC7   |
| -----       | ----- | ----- | ----- | ----- | ----- | ----- | ----- | ----- |

**Switch(config)#show qos dot1p-remap**

|             |       |          |       |       |       |       |       |       |       |
|-------------|-------|----------|-------|-------|-------|-------|-------|-------|-------|
| Dot1p Value | 0     | <b>1</b> | 2     | 3     | 4     | 5     | 6     | 7     | LAG   |
|             | ----- | -----    | ----- | ----- | ----- | ----- | ----- | ----- | ----- |
| Dot1p Remap | 0     | <b>3</b> | 2     | 3     | 4     | 5     | 6     | 7     | N/A   |

```
Switch(config)#end
```

```
Switch#copy running-config startup-config
```

## 2.2.3 Configuring DSCP Priority

### ■ Configuring the Trust Mode

Follow these steps to configure the trust mode:

|        |   |
|--------|---|
| Step 1 | <b>configure</b><br>Enter global configuration mode   |
| Step 2 | <b>interface {fastEthernet port   range fastEthernet port-list   gigabitEthernet port   range gigabitEthernet port-list   ten-gigabitEthernet port   range ten-gigabitEthernet port-list   port-channel port-channel-id   range port-channel port-channel-list}</b><br>Enter interface configuration mode.  |
| Step 3 | <b>qos trust mode {untrust   dot1p   dscp}</b><br>Select the trust mode for the port. By default, it is untrust. Here we set the trust mode as dscp.<br><br><i>dscp</i> : Specify the ports' trust mode as dscp. In this mode, the IP packets will be processed according to the DSCP priority configuration and the non-IP packets will be processed according to the port priority configuration. |
| Step 4 | <b>show qos trust interface [fastEthernet port   gigabitEthernet port   ten-gigabitEthernet port   port-channel port-channel-id]</b><br>Verify the trust mode of the ports.   |
| Step 5 | <b>end</b><br>Return to privileged EXEC mode.   |
| Step 6 | <b>copy running-config startup-config</b><br>Save the settings in the configuration file.   |

### ■ Configuring the 802.1p to Queue Mapping

Follow these steps to configure the 802.1p to queue mapping:

|        |   |
|--------|---|
| Step 1 | <b>configure</b><br>Enter global configuration mode |
|--------|---|

|        |   |
|--------|---|
| Step 2 | <b>qos cos-map {dot1p-priority} {tc-queue}</b><br>Specify the 802.1p to queue mapping. The packets with the desired 802.1p priority will be put in the corresponding queues. By default, the 802.1p priority 0 to 7 is respectively mapped to TC-1, TC-0, TC-2, TC-3, TC-4, TC-5, TC-6, TC-7.<br><i>dot1p-priority</i> : Specify the 802.1p priority. The valid values are from 0 to 7.<br><i>tc-queue</i> : Specify the ID number of the TC queue. The valid values are from 0 to 7. |
| Step 3 | <b>show qos cos-map</b><br>Verify the 802.1p to queue mappings.   |
| Step 4 | <b>end</b><br>Return to privileged EXEC mode.   |
| Step 5 | <b>copy running-config startup-config</b><br>Save the settings in the configuration file.   |

## ■ Configuring the DSCP to 802.1p Mapping and DSCP Remap

Follow these steps to configure the DSCP to 802.1p mapping and DSCP remap:

|        |   |
|--------|---|
| Step 1 | <b>configure</b><br>Enter global configuration mode   |
| Step 2 | <b>qos dscp-map {dscp-value-list} {dot1p-priority}</b><br>Specify the DSCP to 802.1p mapping. The ingress packets with the desired DSCP priority are first mapped to 802.1p priority based on the DSCP to 802.1p mapping, then to TC queues based on the 802.1p to queue mapping. The untagged packets with the desired DSCP priority will be added an 802.1p priority value according to the DSCP to 802.1p mapping. by default, the DSCP priorities 0-7 are mapped to the 802.1p priority 0, the DSCP priorities 8-15 are mapped to the 802.1p priority 1 and so on.<br><i>dscp-value-list</i> : Specify the DSCP value list in the format of "1-3,5,7". The valid values are from 0 to 63.<br><i>dot1p-priority</i> : Specify the 802.1p priority. The valid values are from 0 to 7. |
| Step 3 | <b>qos dscp-remap {dscp-value-list} {dscp-remap-value}</b><br>(Optional) Specify the DSCP to DSCP mappings. DSCP Remap is used to modify the DSCP priority of the ingress packets. When the switch detects the packets with the desired DSCP priority, it will modify the value of DSCP priority according to the map. By default, the original DSCP priority 0 is mapped to the DSCP priority 0, the original DSCP priority 1 is mapped to the DSCP priority 1 and so on.<br><i>dscp-value-list</i> : Specify the original DSCP priority list in the format of "1-3,5,7". The valid values are from 0 to 63.<br><i>dscp-remap-value</i> : Specify the new DSCP priority. The valid values are from 0 to 63.  |
| Step 4 | <b>show qos dscp-map</b><br>Verify the DSCP to queue mappings.  |



- 
- Step 5     **show qos dscp-remap**  
Verify the DSCP to DSCP mappings.
- 
- Step 6     **end**  
Return to privileged EXEC mode.
- 
- Step 7     **copy running-config startup-config**  
Save the settings in the configuration file.
- 

 **Note:**

In Trust DSCP mode, non-IP packets will be added an 802.1p priority based on the port to 802.1p mapping and will be forwarded according to the 802.1p to queue mapping.

The following example shows how to configure the trust mode of port 1/0/1 as dscp, map 802.1p priority 3 to TC4, map DSCP priority 1-3,5,7 to 802.1p priority 3, and configure to map the original DSCP priority 9 to DSCP priority 5:

**Switch#configure**

**Switch(config)#interface gigabitEthernet 1/0/1**

**Switch(config-if)#qos trust mode dscp**

**Switch(config-if)#exit**

**Switch(config)#qos cos-map 3 4**

**Switch(config)#qos dscp-map 1-3,5,7 3**

**Switch(config)#qos dscp-remap 9 5**

**Switch(config)#show qos trust interface gigabitEthernet 1/0/1**

| Port    | Trust Mode | LAG   |
|---------|------------|-------|
| -----   | -----      | ----- |
| Gi1/0/1 | trust DSCP | N/A   |

**Switch(config)#show qos cos-map**

```

-----+-----+-----+-----+-----+-----+-----+-----+-----
Dot1p Value |0  |1  |2  |3  |4  |5  |6  |7
-----+-----+-----+-----+-----+-----+-----+-----+-----
TC          |TC0|TC1|TC2|TC4|TC4|TC5|TC6|TC7
-----+-----+-----+-----+-----+-----+-----+-----+-----

```

**Switch(config)#show qos dscp-map**

| DSCP: | 0 | 1 | 2 | 3 | 4 | 5 | 6 | 7 |
|-------|---|---|---|---|---|---|---|---|
|       |   |   |   |   |   |   |   |   |

```

DSCP to 802.1P  0  3  3  3  0  3  0  3
                -----
DSCP:           8  9  10 11 12 13 14 15
DSCP to 802.1P  1  1  1  1  1  1  1  1
                -----
DSCP:           16 17 18 19 20 21 22 23
DSCP to 802.1P  2  2  2  2  2  2  2  2
                -----
DSCP:           24 25 26 27 28 29 30 31
DSCP to 802.1P  3  3  3  3  3  3  3  3
                -----
DSCP:           32 33 34 35 36 37 38 39
DSCP to 802.1P  4  4  4  4  4  4  4  4
                -----
DSCP:           40 41 42 43 44 45 46 47
DSCP to 802.1P  5  5  5  5  5  5  5  5
                -----
DSCP:           48 49 50 51 52 53 54 55
DSCP to 802.1P  6  6  6  6  6  6  6  6
                -----
DSCP:           56 57 58 59 60 61 62 63
DSCP to 802.1P  7  7  7  7  7  7  7  7
                -----

```

**Switch(config)#show qos dscp-remap**

```

DSCP:           0  1  2  3  4  5  6  7
DSCP remap value 0  1  2  3  4  5  6  7
                -----
DSCP:           8  9  10 11 12 13 14 15

```

```

DSCP remap value 8 5 10 11 12 13 14 15
-----
DSCP:           16 17 18 19 20 21 22 23
DSCP remap value 16 17 18 19 20 21 22 23
-----
DSCP:           24 25 26 27 28 29 30 31
DSCP remap value 24 25 26 27 28 29 30 31
-----
DSCP:           32 33 34 35 36 37 38 39
DSCP remap value 32 33 34 35 36 37 38 39
-----
DSCP:           40 41 42 43 44 45 46 47
DSCP remap value 40 41 42 43 44 45 46 47
-----
DSCP:           48 49 50 51 52 53 54 55
DSCP remap value 48 49 50 51 52 53 54 55
-----
DSCP:           56 57 58 59 60 61 62 63
DSCP remap value 56 57 58 59 60 61 62 63
-----

```

**Switch(config-if)#end**

**Switch#copy running-config startup-config**

## 2.2.4 Specifying the Scheduler Settings

Follow these steps to specify the scheduler settings to control the forwarding sequence of different TC queues when congestion occurs.

- 
- |        |   |
|--------|---|
| Step 1 | <p><b>configure</b></p> <p>Enter global configuration mode.</p> |
|--------|---|
- 
- |        |   |
|--------|---|
| Step 2 | <p><b>interface {fastEthernet port   range fastEthernet port-list   gigabitEthernet port   range gigabitEthernet port-list   ten-gigabitEthernet port   range ten-gigabitEthernet port-list   port-channel port-channel-id   range port-channel port-channel-list}</b></p> <p>Enter interface configuration mode.</p> |
|--------|---|
-

**Step 3** `qos queue tc-queue mode {sp | wrr} [weight weight]`

Specify the type of scheduling used for corresponding queue. When the network congestion occurs, the egress queue will determine the forwarding sequence of the packets according to the type. By default, it is wrr mode and the all the queue weights are 1.

**tc-queue:** Specify the ID number of TC queue. The valid values are from 0 to 7.

**sp:** In sp mode, the egress queue will use SP (Strict Priority) to process the traffic in different queues. When congestion occurs, the traffic will be transmitted according to its queue priority strictly. The queue with higher priority occupies the whole bandwidth. Packets in the queue with lower priority are sent only when the queue with higher priority is empty.

**wrr:** In wrr mode, the egress queue will use WRR (Weighted Round Robin) to process the traffic in different queues. When congestion occurs, all the traffic will be transmitted, but the bandwidth that each traffic queue occupies will be allocated based on the queue weight.

**weight:** Specify the queue weight for the desired queue. This value can be set only in the wrr mode. The valid values are from 1 to 127.

**Step 4** `show qos queue interface [fastEthernet port | gigabitEthernet port | ten-gigabitEthernet port | port-channel port-channel-id]`

Verify the scheduler settings..

**Step 5** `end`

Return to privileged EXEC mode.

**Step 6** `copy running-config startup-config`

Save the settings in the configuration file.

 **Note:**

With ACL Redirect feature, the switch maps all the packets that meet the configured ACL rules to the new TC queue, regardless of the mapping relations configured in this section.

The following example shows how to specify the scheduler settings for port 1/0/1. Set the scheduler mode of TC1 as sp mode, set the scheduler mode of TC4 as wrr mode and set the queue weight as 5.

**Switch#configure**

```
Switch(config)#interface gigabitEthernet 1/0/1
```

```
Switch(config-if)#qos queue 1 mode sp
```

```
Switch(config-if)#qos queue 4 mode wrr weight 5
```

```
Switch(config-if)#show qos queue interface gigabitEthernet 1/0/1
```

```
Gi1/0/1----LAG: N/A
```

```
Queue  Schedule Mode  Weight
```

```
-----
```

```
TC0    WRR          1
```

|     |        |     |
|-----|--------|-----|
| TC1 | Strict | N/A |
| TC2 | WRR    | 1   |
| TC3 | WRR    | 1   |
| TC4 | WRR    | 5   |
| TC5 | WRR    | 1   |
| TC6 | WRR    | 1   |
| TC7 | WRR    | 1   |

**Switch(config-if)#end**

**Switch#copy running-config startup-config**

# 3 Bandwidth Control Configuration

With bandwidth control configurations, you can:

- Configure rate limit
- Configure storm control

## 3.1 Using the GUI

### 3.1.1 Configuring Rate Limit

Choose the menu **QoS > Bandwidth Control > Rate Limit** to load the following page.

Figure 3-1 Configuring Rate Limit

Rate Limit Config

UNIT1
LAGS

| <input type="checkbox"/>            | Port   | Ingress Rate (0-1,000,000Kbps) | Egress Rate (0-1,000,000Kbps) | LAG |
|-------------------------------------|--------|--------------------------------|-------------------------------|-----|
| <input checked="" type="checkbox"/> | 1/0/1  | 0                              | 0                             | --- |
| <input type="checkbox"/>            | 1/0/2  | 0                              | 0                             | --- |
| <input type="checkbox"/>            | 1/0/3  | 0                              | 0                             | --- |
| <input type="checkbox"/>            | 1/0/4  | 0                              | 0                             | --- |
| <input type="checkbox"/>            | 1/0/5  | 0                              | 0                             | --- |
| <input type="checkbox"/>            | 1/0/6  | 0                              | 0                             | --- |
| <input type="checkbox"/>            | 1/0/7  | 0                              | 0                             | --- |
| <input type="checkbox"/>            | 1/0/8  | 0                              | 0                             | --- |
| <input type="checkbox"/>            | 1/0/9  | 0                              | 0                             | --- |
| <input type="checkbox"/>            | 1/0/10 | 0                              | 0                             | --- |

Total: 28
1 entry selected.

Cancel
Apply

Follow these steps to configure the Rate Limit function:

- 1) Select the desired port and configure the upper rate limit to receive and send packets.

**Ingress Rate (0-1,000,000Kbps)**

Configure the upper rate limit for receiving packets on the port. The valid values are from 0 to 1000000 Kbps and 0 means the ingress rate limit is disabled.

**Egress Rate (0-1,000,000Kbps)**

Configure the bandwidth for sending packets on the port. The valid values are from 0 to 1000000 Kbps and 0 means the egress rate limit is disabled.

- 2) Click **Apply**.

### 3.1.2 Configuring Storm Control

Choose the menu **QoS > Bandwidth Control > Storm Control** to load the following page.

Figure 3-2 Configuring Storm Control

Storm Control Config

UNIT1
LAGS
↻ Recover

| <input type="checkbox"/>            | Port   | Rate Mode | Broadcast<br>Threshold (0-<br>1,000,000) | Multicast<br>Threshold (0-<br>1,000,000) | UL-Frame<br>Threshold (0-<br>1,000,000) | Action | Recover Time | LAG |
|-------------------------------------|--------|-----------|--|--|---|--------|--------------|-----|
|                                     |        | kbps ▼    |  |  |   | ▼      |              |     |
| <input checked="" type="checkbox"/> | 1/0/1  | kbps      | 0  | 0  | 0                                       | Drop   | 0            | --- |
| <input type="checkbox"/>            | 1/0/2  | kbps      | 0  | 0  | 0                                       | Drop   | 0            | --- |
| <input type="checkbox"/>            | 1/0/3  | kbps      | 0  | 0  | 0                                       | Drop   | 0            | --- |
| <input type="checkbox"/>            | 1/0/4  | kbps      | 0  | 0  | 0                                       | Drop   | 0            | --- |
| <input type="checkbox"/>            | 1/0/5  | kbps      | 0  | 0  | 0                                       | Drop   | 0            | --- |
| <input type="checkbox"/>            | 1/0/6  | kbps      | 0  | 0  | 0                                       | Drop   | 0            | --- |
| <input type="checkbox"/>            | 1/0/7  | kbps      | 0  | 0  | 0                                       | Drop   | 0            | --- |
| <input type="checkbox"/>            | 1/0/8  | kbps      | 0  | 0  | 0                                       | Drop   | 0            | --- |
| <input type="checkbox"/>            | 1/0/9  | kbps      | 0  | 0  | 0                                       | Drop   | 0            | --- |
| <input type="checkbox"/>            | 1/0/10 | kbps      | 0  | 0  | 0                                       | Drop   | 0            | --- |

Total: 28
1 entry selected.
Cancel
Apply

Follow these steps to configure the Storm Control function:

- 1) Select the desired port and configure the upper rate limit for forwarding broadcast packets, multicast packets and UL-frames (Unknown unicast frames).

|   |   |
|---|---|
| <p><b>Rate Mode</b></p>                         | <p>Specify the Rate Mode for the broadcast threshold, multicast threshold and UL-Frame threshold on the desired port.</p> <p><b>kbps:</b> The switch will limit the maximum speed of the specific kinds of traffic in kilo-bits per second.</p> <p><b>ratio:</b> The switch will limit the percentage of bandwidth utilization for specific kinds of traffic.</p> |
| <p><b>Broadcast Threshold (0-1,000,000)</b></p> | <p>Specify the upper rate limit for receiving broadcast packets. The valid values differ among different rate modes. The value 0 means the broadcast threshold is disabled. The broadcast traffic exceeding the limit will be processed according to the Action configurations.</p>   |
| <p><b>Multicast Threshold (0-1,000,000)</b></p> | <p>Specify the upper rate limit for receiving multicast packets. The valid values differ among different rate modes. The value 0 means the multicast threshold is disabled. The multicast traffic exceeding the limit will be processed according to the Action configurations.</p>   |

|                                  |   |
|----------------------------------|---|
| UL-Frame Threshold (0-1,000,000) | Specify the upper rate limit for receiving unknown unicast frames. The valid values differ among different rate modes. The value 0 means the unknown unicast threshold is disabled. The traffic exceeding the limit will be processed according to the Action configurations.   |
| Action                           | <p>Select the action that the switch will take when the traffic exceeds its corresponding limit.</p> <p><b>Drop:</b> Set the Action as Drop. The port will drop the subsequent packets when the traffic exceeds the limit.</p> <p><b>Shutdown:</b> Set the Action as Shutdown. The port will be shutdown when the traffic exceeds the limit.</p>  |
| Recover Time                     | Specify the recover time for the port. It takes effect only when the action is set as shutdown. The valid values are from 0 to 3600 seconds. When the port is shutdown, it can recover to its normal state after the recover time passed. If the recover time is specified as 0, which means the port will not recover to its normal state automatically and you can recover the port manually. |

2) Click **Apply**.

#### Note:

The member port of an LAG (Link Aggregation Group) follows the configuration of the LAG and not its own. The configurations of the port can take effect only after it leaves the LAG.

## 3.2 Using the CLI

### 3.2.1 Configuring Rate Limit

Follow these steps to configure the upper rate limit for the port to receive and send packets:

|        |  |
|--------|--|
| Step 1 | <p><b>configure</b></p> <p>Enter global configuration mode.</p>  |
| Step 2 | <p><b>interface {fastEthernet port   range fastEthernet port-list   gigabitEthernet port   range gigabitEthernet port-list   ten-gigabitEthernet port   range ten-gigabitEthernet port-list   port-channel port-channel-id   range port-channel port-channel-list}</b></p> <p>Enter interface configuration mode.</p>  |
| Step 3 | <p><b>bandwidth {ingress ingress-rate   egress egress-rate}</b></p> <p>Configure the upper rate limit for the port to receive and send packets.</p> <p><i>ingress-rate:</i> Configure the upper rate limit for receiving packets on the port. The valid values are from 0 to 1000000 Kbps.</p> <p><i>egress-rate:</i> Configure the upper rate limit for sending packets on the port. The valid values are from 0 to 1000000 Kbps.</p> |



- 
- Step 4    **show bandwidth interface [fastEthernet port | gigabitEthernet port | ten-gigabitEthernet port | port-channel port-channel-id]**  
Verify the ingress/egress rate limit for forwarding packets on the port or LAG. If no port or LAG is specified, it displays the upper ingress/egress rate limit for all ports or LAGs.
- 
- Step 5    **end**  
Return to privileged EXEC mode.
- 
- Step 6    **copy running-config startup-config**  
Save the settings in the configuration file.
- 

The following example shows how to configure the ingress-rate as 5120 Kbps and egress-rate as 1024 Kbps for port 1/0/5:

**Switch#configure**

**Switch(config)#interface gigabitEthernet 1/0/5**

**Switch(config-if)#bandwidth ingress 5120 egress 1024**

**Switch(config-if)#show bandwidth interface gigabitEthernet 1/0/5**

| Port    | IngressRate(Kbps) | EgressRate(Kbps) | LAG   |
|---------|-------------------|------------------|-------|
| -----   | -----             | -----            | ----- |
| Gi1/0/5 | 5120              | 1024             | N/A   |

**Switch(config-if)#end**

**Switch#copy running-config startup-config**

### 3.2.2 Configuring Storm Control

Follow these steps to configure the upper rate limit on the port for forwarding broadcast packets, multicast packets and unknown unicast frames:

- 
- Step 1    **configure**  
Enter global configuration mode
- 
- Step 2    **interface {fastEthernet port | range fastEthernet port-list | gigabitEthernet port | range gigabitEthernet port-list | ten-gigabitEthernet port | range ten-gigabitEthernet port-list | port-channel port-channel-id | range port-channel port-channel-list}**  
Enter interface configuration mode.
-

---

**Step 3** **storm-control rate-mode {kbps | ratio}**

Specify the Rate Mode for the broadcast threshold, multicast threshold and UL-Frame threshold on the desired port.

**kbps:** The switch will limit the maximum speed of the specific kinds of traffic in kilo-bits per second.

**ratio:** The switch will limit the percentage of bandwidth utilization for specific kinds of traffic.

---

**Step 4** **storm-control broadcast rate**

Specify the upper rate limit for receiving broadcast packets. The broadcast traffic exceeding the limit will be processed according to the Action configurations.

**rate:** Enter the upper rate. In kbps mode, the valid values are from 1 to 1000000 Kbps. In ratio mode, the valid values are from 1 to 100 percent.

---

**Step 5** **storm-control multicast rate**

Specify the upper rate limit for receiving multicast packets. The multicast traffic exceeding the limit will be processed according to the Action configurations.

**rate:** Enter the upper rate. In kbps mode, the valid values are from 1 to 1000000 Kbps. In ratio mode, the valid values are from 1 to 100 percent.

---

**Step 6** **storm-control unicast rate**

Specify the upper rate limit for receiving unknown unicast frames. The traffic exceeding the limit will be processed according to the Action configurations.

**rate:** Enter the upper rate. In kbps mode, the valid values are from 1 to 1000000 Kbps. In ratio mode, the valid values are from 1 to 100 percent.

---

**Step 7** **storm-control exceed {drop | shutdown} [recover-time time]**

Specify the action and the recover time. The switch will perform the action when the traffic exceeds its corresponding limit. By default, it is drop.

**drop:** Set the Action as Drop. The port will drop the subsequent packets when the traffic exceeds the limit.

**shutdown:** Set the Action as Shutdown. The port will be shutdown when the traffic exceeds the limit.

**time:** Specify the recover time for the port. It takes effect only when the action is set as shutdown. The valid values are from 0 to 3600 and the default value is 0. When the port is shutdown, it can recover to its normal state after the recover time passed. If the recover time is specified as 0, which means the port will not recover to its normal state automatically and you can recover the port manually.

---

**Step 8** **storm-control recover**

(Optional) Recover the port manually. When the recover time is specified as 0, the port will not recover to its normal state automatically. In this condition, you need to use this command to recover the port manually.

---

---

Step 9 **show storm-control interface** [*fastEthernet port* | *gigabitEthernet port* | *ten-gigabitEthernet port* | *port-channel port-channel-id*]

Verify the storm control configurations of the port or LAG. If no port or LAG is specified, it displays the storm control configuration for all ports or LAGs.

---

Step 10 **end**

Return to privileged EXEC mode.

---

Step 11 **copy running-config startup-config**

Save the settings in the configuration file.

---

The following example shows how to configure the upper rate limit of broadcast packets as 1024 kbps, Specify the action as shutdown and set the recover time as 10 for port 1/0/5:

**Switch#configure**

**Switch(config)#interface gigabitEthernet 1/0/5**

**T2600G-28TS(config-if)#storm-control rate-mode kbps**

**T2600G-28TS(config-if)#storm-control broadcast 1024**

**T2600G-28TS(config-if)#storm-control exceed shutdown recover-time 10**

**T2600G-28TS(config-if)#show storm-control interface gigabitEthernet 1/0/5**

| Port    | Rate Mode | BcRate | McRate | UIRate | Exceed   | Recover Time | LAG   |
|---------|-----------|--------|--------|--------|----------|--------------|-------|
| -----   | -----     | -----  | -----  | -----  | -----    | -----        | ----- |
| Gi1/0/5 | kbps      | 1024   | 0      | 0      | shutdown | 10           | N/A   |

**Switch(config-if)#end**

**Switch#copy running-config startup-config**

# 4 Voice VLAN Configuration

To complete the voice VLAN configurations, follow these steps:

- 1) Create a 802.1Q VLAN
- 2) Configure OUI addresses
- 3) Configure Voice VLAN globally
- 4) Add ports to Voice VLAN

## Configuration Guidelines

- Before configuring voice VLAN, you need to create a 802.1Q VLAN for voice traffic. For details about 802.1Q VLAN Configuration, please refer to [Configuring 802.1Q VLAN](#).
- VLAN 1 is a default VLAN and cannot be configured as the voice VLAN.
- Only one VLAN can be set as the voice VLAN on the switch.

## 4.1 Using the GUI

### 4.1.1 Configuring OUI Addresses

The OUI address is assigned as a unique identifier by IEEE (Institute of Electrical and Electronics Engineers) to a device vendor. It is used by the switch to determine whether a packet is a voice packet.

If the OUI address of your voice device is not in the OUI table, you need to add the OUI address to the table.

Choose the menu **QoS > Voice VLAN > OUI Config** to load the following page.

Figure 4-1 Configuring OUI Addresses

| OUI Config  |          |         |             |  |
|---|----------|---------|-------------|--|
| UNIT1 <span style="float: right;">+ Add - Delete</span> |          |         |             |  |
| <input type="checkbox"/>                                | OUI      | Status  | Description |  |
| <input type="checkbox"/>                                | 00:01:E3 | Default | SIEMENS     |  |
| <input type="checkbox"/>                                | 00:03:6B | Default | CISCO1      |  |
| <input type="checkbox"/>                                | 00:12:43 | Default | CISCO2      |  |
| <input type="checkbox"/>                                | 00:0F:E2 | Default | H3C         |  |
| <input type="checkbox"/>                                | 00:60:B9 | Default | NITSUKO     |  |
| <input type="checkbox"/>                                | 00:D0:1E | Default | PINTEL      |  |
| <input type="checkbox"/>                                | 00:E0:75 | Default | VERILINK    |  |
| <input type="checkbox"/>                                | 00:E0:BB | Default | 3COM        |  |
| <input type="checkbox"/>                                | 00:04:0D | Default | AVAYA1      |  |
| <input type="checkbox"/>                                | 00:1B:4F | Default | AVAYA2      |  |
| Total: 11   |          |         |             |  |

Follow these steps to configure the OUI addresses:

- 1) Click **+ Add** to load the following page.

Figure 4-2 Creating an OUI Entry

**OUI**

OUI:  (Format: 00:00:00)

Description:  (1-16 characters)

Cancel
Create

- 2) Specify the OUI and the Description.

|                    |  |
|--------------------|--|
| <b>OUI</b>         | Enter the OUI address of your voice devices. The OUI address is used by the switch to determine whether a packet is a voice packet. An OUI address is the first 24 bits of a MAC address, and is assigned as a unique identifier by IEEE (Institute of Electrical and Electronics Engineers) to a device vendor. If the source MAC address of a packet matches the OUI addresses in the OUI list, the switch identifies the packet as a voice packet and prioritizes it in transmission. |
| <b>Description</b> | Give an OUI address description for identification.  |

- 3) Click **Create**.

### 4.1.1 Configuring Voice VLAN Globally

Choose the menu **QoS > Voice VLAN > Global Config** to load the following page.

Figure 4-3 Configuring Voice VLAN Globally

**Global Config**

Voice VLAN:  Enable

VLAN ID:  (2-4094)

Priority:

[Apply](#)

Follow these steps to configure voice VLAN globally:

- 1) Enable the voice VLAN feature and specify the parameters.

|                 |  |
|-----------------|--|
| <b>VLAN ID</b>  | Specify the 802.1Q VLAN ID to set the 802.1Q VLAN as the voice VLAN.   |
| <b>Priority</b> | Select the priority that will be assigned to voice packets. A bigger value means a higher priority. This is an IEEE 802.1p priority, and you can further configure its scheduler mode in Class of Service if needed. |

- 2) Click **Apply**.

### 4.1.1 Adding Ports to Voice VLAN

Choose the menu **QoS > Voice VLAN > Port Config** to load the following page.

Figure 4-4 Adding Ports to Voice VLAN

**Port Config**

UNIT1

LAGS

|                                     | Port   | Voice VLAN | Operational Status |
|-------------------------------------|--------|------------|--------------------|
| <input checked="" type="checkbox"/> | 1/0/1  | Disabled   | Inactive           |
| <input type="checkbox"/>            | 1/0/2  | Disabled   | Inactive           |
| <input type="checkbox"/>            | 1/0/3  | Disabled   | Inactive           |
| <input type="checkbox"/>            | 1/0/4  | Disabled   | Inactive           |
| <input type="checkbox"/>            | 1/0/5  | Disabled   | Inactive           |
| <input type="checkbox"/>            | 1/0/6  | Disabled   | Inactive           |
| <input type="checkbox"/>            | 1/0/7  | Disabled   | Inactive           |
| <input type="checkbox"/>            | 1/0/8  | Disabled   | Inactive           |
| <input type="checkbox"/>            | 1/0/9  | Disabled   | Inactive           |
| <input type="checkbox"/>            | 1/0/10 | Disabled   | Inactive           |

Total: 28
1 entry selected.

Cancel
Apply

Follow these steps to configure voice VLAN globally:

- 1) Select the desired ports and choose Enable in Voice VLAN filed.

|                   |  |
|-------------------|--|
| <b>Voice VLAN</b> | Select Enable to enable the voice VLAN feature on ports and add the desired ports to Voice VLAN. |
|-------------------|--|

---

|                        |  |
|------------------------|--|
| <b>Optional Status</b> | Displays the state of the Voice VLAN on the corresponding port.              |
|                        | <b>Active:</b> Indicates that Voive VLAN function is enabled on the port.    |
|                        | <b>Inactive:</b> Indicates that Voive VLAN function is disabled on the port. |

---

2) Click **Apply**.

## 4.2 Using the CLI

Follow these steps to configure voice VLAN:

---

|        |   |
|--------|---|
| Step 1 | <p><b>configure</b></p> <p>Enter global configuration mode.</p>   |
| Step 2 | <p><b>show voice vlan oui-table</b></p> <p>Check whether the OUI address of your voice device is in the OUI table.</p> <p>The OUI address is used by the switch to determine whether a packet is a voice packet. An OUI address is the first 24 bits of a MAC address, and is assigned as a unique identifier by IEEE (Institute of Electrical and Electronics Engineers) to a device vendor. If the source MAC address of a packet matches the OUI addresses in the OUI list, the switch identifies the packet as a voice packet and prioritizes it in transmission.</p> |
| Step 3 | <p><b>voice vlan oui <i>oui-prefix</i> <i>oui-desc</i> <i>string</i></b></p> <p>If the OUI address of your voice device is not in the OUI table, add the OUI address to the table.</p> <p><i>oui-prefix:</i> Enter the OUI address for your voice device in the format of XX:XX:XX.</p> <p><i>string:</i> Give an OUI address description for identification. It contains 16 characters at most.</p>  |
| Step 4 | <p><b>voice vlan <i>vid</i></b></p> <p>Enable the voice VLAN feature and specify an existing 802.1Q VLAN as the voice VLAN.</p> <p><i>vid:</i> Enter the 802.1Q VLAN ID to set the 802.1Q VLAN as the voice VLAN.</p>   |
| Step 5 | <p><b>voice vlan priority <i>pri</i></b></p> <p>Specify the priority that will be assigned to voice packets.</p> <p><i>pri:</i> Enter the priority that will be assigned to voice packets. A bigger value means a higher priority. The valid values are from 0 to 7 and the default value is 7. This is an IEEE 802.1p priority, and you can further configure its scheduler mode in Class of Service if needed.</p>  |
| Step 6 | <p><b>interface {fastEthernet <i>port</i>   range fastEthernet <i>port-list</i>   gigabitEthernet <i>port</i>   range gigabitEthernet <i>port-list</i>   ten-gigabitEthernet <i>port</i>   range ten-gigabitEthernet <i>port-list</i>   port-channel <i>port-channel-id</i>   range port-channel <i>port-channel-list</i>}</b></p> <p>Enter interface configuration mode.</p>   |
| Step 7 | <p><b>voice vlan</b></p> <p>Enable the voice VLAN feature on ports and add the desired ports to voice VLAN.</p>   |
| Step 8 | <p><b>show voice vlan interface</b></p> <p>Verify the voice VLAN configuration information.</p>   |

---

---

Step 8     **end**  
Return to privileged EXEC mode.

---

Step 9     **copy running-config startup-config**  
Save the settings in the configuration file.

---

The following example shows how to show the OUI table, set VLAN 8 as voice VLAN, set the priority as 6 and enable voice VLAN feature on port 1/0/3:

### Switch#configure

#### Switch(config)#show voice vlan oui-table

```
00:01:E3   Default   SIEMENS
00:03:6B   Default   CISCO1
00:12:43   Default   CISCO2
00:0F:E2   Default   H3C
00:60:B9   Default   NITSUKO
00:D0:1E   Default   PINTEL
00:E0:75   Default   VERILINK
00:E0:BB   Default   3COM
00:04:0D   Default   AVAYA1
00:1B:4F   Default   AVAYA2
00:04:13   Default   SNOM
```

#### Switch(config)#voice vlan 8

#### Switch(config)#voice vlan priority 6

#### Switch(config)#interface gigabitEthernet 1/0/3

#### Switch(config-if)#voice vlan

#### Switch(config-if)#show voice vlan interface

```
Voice VLAN ID      8
Priority            6

Interface  Voice VLAN Mode  Operational Status  LAG
-----  -
Gi1/0/1   disabled          Down                N/A
Gi1/0/2   disabled          Down                N/A
```



|         |          |      |     |
|---------|----------|------|-----|
| Gi1/0/3 | enabled  | Up   | N/A |
| Gi1/0/4 | disabled | Down | N/A |
| Gi1/0/5 | disabled | Down | N/A |

...

**Switch(config-if)#end**

**Switch#copy running-config startup-config**

# 5 Auto VoIP Configuration

## Configuration Guidelines

- Before configuring Auto VoIP, you need to enable LLDP-MED on ports and configure the relevant parameters. For details about LLDP-MED configuration, please refer to [Configuring LLDP](#).
- Auto VoIP provide flexible solutions for optimizing the voice traffic. It can work with other features such as VLAN and Class of Service to process the voice packets with specific fields. You can choose and configure Auto VoIP and other features according to your needs.

## 5.1 Using the GUI

Choose the menu **QoS > Auto VoIP** to load the following page.

Figure 5-1 Configuring Auto VoIP

Global Config

---

Auto VoIP:  Enable Apply

Port Config

UNIT1

|                                     | Port   | Interface Mode | Value | CoS Override Mode | Operational Status | DSCP Value |
|-------------------------------------|--------|----------------|-------|-------------------|--------------------|------------|
| <input checked="" type="checkbox"/> | 1/0/1  | Disable        | 0     | Disabled          | Disabled           | 0          |
| <input type="checkbox"/>            | 1/0/2  | Disable        | 0     | Disabled          | Disabled           | 0          |
| <input type="checkbox"/>            | 1/0/3  | Disable        | 0     | Disabled          | Disabled           | 0          |
| <input type="checkbox"/>            | 1/0/4  | Disable        | 0     | Disabled          | Disabled           | 0          |
| <input type="checkbox"/>            | 1/0/5  | Disable        | 0     | Disabled          | Disabled           | 0          |
| <input type="checkbox"/>            | 1/0/6  | Disable        | 0     | Disabled          | Disabled           | 0          |
| <input type="checkbox"/>            | 1/0/7  | Disable        | 0     | Disabled          | Disabled           | 0          |
| <input type="checkbox"/>            | 1/0/8  | Disable        | 0     | Disabled          | Disabled           | 0          |
| <input type="checkbox"/>            | 1/0/9  | Disable        | 0     | Disabled          | Disabled           | 0          |
| <input type="checkbox"/>            | 1/0/10 | Disable        | 0     | Disabled          | Disabled           | 0          |

Total: 28 1 entry selected. Cancel Apply

Follow these steps to configure the OUI addresses:

- 1) In the **Global Config** section, enable the Auto VoIP function globally.
- 2) In the **Port Config** section, select the desired and configure the parameters.

|                    |  |
|--------------------|--|
| Interface Mode     | <p>Select the interface mode for the port.</p> <p><b>Disable:</b> Disable the Auto VoIP function on the corresponding port.</p> <p><b>None:</b> Allow the voice devices to use its own configuration to send voice traffic.</p> <p><b>VLAN ID:</b> The voice devices will send voice packets with desired VLAN tag. If this mode is selected, it is necessary to specify the VLAN ID in the Value field.</p> <p>In addition, you need to configure the 802.1Q VLAN to ensure the corresponding ports can forward the packets normally.</p> <p><b>Dot1p:</b> The voice devices will send voice packets with desired 802.1p priority. If this mode is selected, it is necessary to specify 802.1p priority in the Value field.</p> <p>In addition, you can configure the Class of Service to make the switch process the packets according to the 802.1p priority.</p> <p><b>Untagged:</b> The voice devices will send untagged voice packets.</p> |
| Value              | <p>Enter the value of VLAN ID or 802.1p priority for the port according to the Interface Mode configurations.</p>  |
| CoS Override Mode  | <p>Enable or disable the Class of Service override mode.</p> <p><b>Enabled:</b> Enable CoS override. The switch will ignore the 802.1p priority in the voice packets and put the packets in TC-5 directly.</p> <p><b>Disabled:</b> Disable CoS override. The switch will then put the voice packets in the corresponding TC queue according to Class of Service settings.</p>  |
| Operational Status | <p>Displays the operating status of the Voice VLAN feature on the interface. To make it enabled, you must enable the Voice VLAN both globally and on the interface.</p>  |
| DSCP Value         | <p>Enter the value of DSCP priority. The voice device will send the packets with the corresponding DSCP value.</p> <p>In addition, you can configure the Class of Service to make the switch process the packets according to the DSCP priority.</p>   |

3) Click **Apply**.

## 5.2 Using the CLI

Follow these steps to configure Auto VoIP:

|        |   |
|--------|---|
| Step 1 | <p><b>configure</b></p> <p>Enter global configuration mode.</p> |
| Step 2 | <p><b>auto-voip</b></p> <p>Enable Auto VoIP globally.</p>       |

- 
- Step 3 **interface {fastEthernet *port* | range fastEthernet *port-list* | gigabitEthernet *port* | range gigabitEthernet *port-list* | ten-gigabitEthernet *port* | range ten-gigabitEthernet *port-list* | port-channel *port-channel-id* | range port-channel *port-channel-list*}**  
Enter interface configuration mode.
- 
- Step 4 Select the interface mode for the port.
- no auto-voip**
- Specify the interface mode as disabled, which means the Auto VoIP function is disabled on the corresponding port.
- auto-voip none**
- Specify the interface mode as none. In this mode, the switch allows the voice devices to use its own configuration to send voice traffic.
- auto-voip *vlan-id***
- Specify the interface mode as VLAN ID. In this mode, the voice devices will send voice packets with desired VLAN tag. If this mode is selected, it is necessary to specify the 802.1Q VLAN ID. The valid values are from 1 to 4093.
- In addition, you need to configure the 802.1Q VLAN to ensure the corresponding ports can forward the packets normally.
- auto-voip dot1p *dot1p***
- Specify the interface mode as dot1p. In this mode, the voice devices will send voice packets with desired 802.1p priority. If this mode is selected, it is necessary to specify 802.1p priority. The valid values are from 0 to 7.
- In addition, you can configure the Class of Service to make the switch process the packets according to the 802.1p priority.
- auto-voip untagged**
- Specify the interface mode as untagged. In this mode, the voice devices will send untagged voice packets.
- 
- Step 5 **auto-voip data priority {trust | untrust}**
- Enable or disable the Class of Service override mode. By default, it is trust, which means the Class of Service override mode is disabled.
- trust:** In this mode, the switch will then put the voice packets in the corresponding TC queue according to Class of Service settings.
- untrust:** In this mode, the switch will ignore Class of Service settings and put the packets in TC-5 directly.
- 
- Step 6 **auto-voip dscp *value***
- Specify the value of DSCP priority. The voice device will send the packets with the corresponding DSCP value.
- In addition, you can configure the Class of Service to make the switch process the packets according to the DSCP priority.
- value:** Enter the value of DSCP priority. The valid values are from 0 to 63 and the default value is 0.
-

- 
- Step 7     **show auto-voip**  
Verify the global state of Auto VoIP.
- 
- Step 8     **show auto-voip interface**  
Verify the Auto VoIP configuration information of ports.
- 
- Step 8     **end**  
Return to privileged EXEC mode.
- 
- Step 9     **copy running-config startup-config**  
Save the settings in the configuration file.
- 

The following example shows how to set the interface mode as dot1p, specify the 802.1p priority as 4, specify the DSCP priority as 10 and enable the CoS override mode for port 1/0/3:

**Switch#configure**

**Switch(config)#auto-voip**

**Switch(config)#interface gigabitEthernet 1/0/3**

**Switch(config-if)#auto-voip dot1p 4**

**Switch(config-if)#auto-voip dscp 10**

**Switch(config-if)#auto-voip data priority untrust**

**Switch(config-if)#show auto-voip**

Administrative Mode: Enabled

**Switch(config-if)#show auto-voip interface**

Interface.Gi1/0/1

Auto-VoIP Interface Mode.       Disabled

Auto-VoIP COS Override.       False

Auto-VoIP DSCP Value.       0

Auto-VoIP Port Status.       Disabled

Interface.Gi1/0/2

Auto-VoIP Interface Mode.       Disabled

Auto-VoIP COS Override.       False

Auto-VoIP DSCP Value.       0

Auto-VoIP Port Status.       Disabled

```
Interface.Gi1/0/3
Auto-VoIP Interface Mode.      Enabled
Auto-VoIP Priority.            4
Auto-VoIP COS Override.       True
Auto-VoIP DSCP Value.         10
Auto-VoIP Port Status.        Enabled
...
Switch(config-if)#end
Switch#copy running-config startup-config
```

# 6 Configuration Examples

## 6.1 Example for Class of Service

### 6.1.1 Network Requirements

As shown below, both RD department and Marketing department can access the internet. When congestion occurs, the traffic from two departments can both be forwarded and the traffic from the Marketing department should take precedence.

Figure 6-1 QoS Application Topology

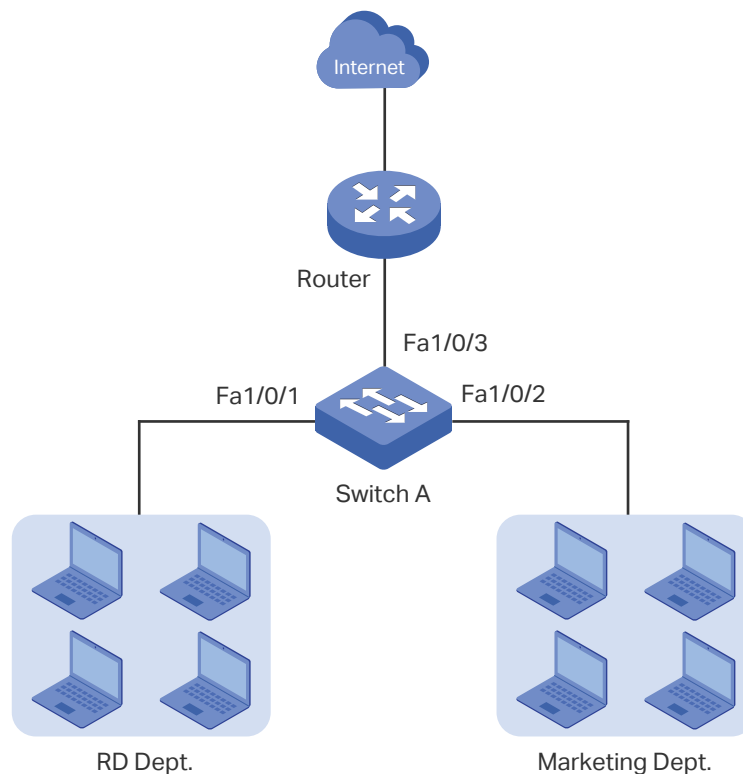

### 6.1.2 Configuration Scheme

To implement this requirement, you can configure Port Priority to put the packets from the Marketing department into the queue with the higher priority than the packets from the RD department.

- 1) Configure the trust mode of port 1/0/1 and port 1/0/2 as untrusted and map the ports to different queues.
- 2) Set the scheduler type of the queues as weighted for port 1/0/3 and specify the queue weight to make the traffic from the Marketing department take precedence.

Demonstrated with T1500-28PCT, the following sections provide configuration procedure in two ways: using the GUI and using the CLI.

### 6.1.3 Using the GUI

- 1) Choose the menu **QoS > Class of Service > Port Priority** to load the following page. Set the trust mode of port 1/0/1 and 1/0/2 as untrusted. Specify the 802.1p priority of port 1/0/1 as 1 and specify the 802.1p priority of port 1/0/2 as 0. Click **Apply**.

Figure 6-2 Configuring Port Priority

Port Priority Config

UNIT1
LAGS

| <input type="checkbox"/>            | Port   | 802.1p Priority | Trust Mode | LAG |
|-------------------------------------|--------|-----------------|------------|-----|
| <input checked="" type="checkbox"/> | 1/0/1  | 1               | Untrusted  | --  |
| <input type="checkbox"/>            | 1/0/2  | 0               | Untrusted  | --  |
| <input type="checkbox"/>            | 1/0/3  | 0               | Untrusted  | --  |
| <input type="checkbox"/>            | 1/0/4  | 0               | Untrusted  | --  |
| <input type="checkbox"/>            | 1/0/5  | 0               | Untrusted  | --  |
| <input type="checkbox"/>            | 1/0/6  | 0               | Untrusted  | --  |
| <input type="checkbox"/>            | 1/0/7  | 0               | Untrusted  | --  |
| <input type="checkbox"/>            | 1/0/8  | 0               | Untrusted  | --  |
| <input type="checkbox"/>            | 1/0/9  | 0               | Untrusted  | --  |
| <input type="checkbox"/>            | 1/0/10 | 0               | Untrusted  | --  |

Total: 28
1 entry selected.
Cancel
Apply

- 2) Choose the menu **QoS > Class of Service > 802.1p Priority** to load the following page. Map the 802.1p priority 0 to TC-1 and map the 802.1p priority 1 to TC-0. Click **Apply**.



Figure 6-3 Configuring the 802.1p to Queue Mappings

802.1p to Queue Mapping

| 802.1p Priority | Queue |
|-----------------|-------|
| 0:              | TC-1  |
| 1:              | TC-0  |
| 2:              | TC-2  |
| 3:              | TC-3  |
| 4:              | TC-4  |
| 5:              | TC-5  |
| 6:              | TC-6  |
| 7:              | TC-7  |

Apply

802.1p Remap

| 802.1p Priority | Remap |
|-----------------|-------|
| 0:              | 0     |
| 1:              | 1     |
| 2:              | 2     |
| 3:              | 3     |
| 4:              | 4     |
| 5:              | 5     |
| 6:              | 6     |
| 7:              | 7     |

Apply

- 3) Choose the menu **QoS > Class of Service > Scheduler Settings** to load the following page. Select the port 1/0/3 and set the scheduler type of TC-0 and TC-1 as Weighted. Specify the queue weight of TC-0 as 1 and specify the queue weight of TC-1 as 5. Click **Apply**.



Figure 6-4 Configuring the Egress Queue

Scheduler Config

UNIT1 LAGS

2 4 6 8 10 12 14 16 18 20 22 24 26 28

1 3 5 7 9 11 13 15 17 19 21 23 25 27

 Selected  Unselected  Not Available

Port 1/0/3

| <input type="checkbox"/>            | Queue TC-id | Scheduler Type | Queue Weight | Management Type |
|-------------------------------------|-------------|----------------|--------------|-----------------|
| <input type="checkbox"/>            | 0           | Weighted       | 1            | Taildrop        |
| <input checked="" type="checkbox"/> | 1           | Weighted       | 5            | Taildrop        |
| <input type="checkbox"/>            | 2           | Weighted       | 1            | Taildrop        |
| <input type="checkbox"/>            | 3           | Weighted       | 1            | Taildrop        |
| <input type="checkbox"/>            | 4           | Weighted       | 1            | Taildrop        |
| <input type="checkbox"/>            | 5           | Weighted       | 1            | Taildrop        |
| <input type="checkbox"/>            | 6           | Weighted       | 1            | Taildrop        |
| <input type="checkbox"/>            | 7           | Weighted       | 1            | Taildrop        |

Total: 8 1 entry selected.

- 4) Click  Save to save the settings.

### 6.1.4 Using the CLI

- 1) Set the trust mode of port 1/0/1 as untrusted and specify the 802.1p priority as 1.

```
Switch_A#configure
```

```
Switch_A(config)#interface fastEthernet 1/0/1
```

```
Switch_A(config-if)#qos trust mode untrust
```

```
Switch_A(config-if)#qos port-priority 1
```

```
Switch_A(config-if)#exit
```

- 2) Set the trust mode of port 1/0/2 as untrusted and specify the 802.1p priority as 0.

```
Switch_A(config)#interface fastEthernet 1/0/2
```

```
Switch_A(config-if)#qos trust mode untrust
```

```
Switch_A(config-if)#qos port-priority 0
```

```
Switch_A(config-if)#exit
```

- 3) Map the 802.1p priority 0 to TC-1 and map the 802.1p priority 1 to TC-0.

```
Switch_A(config)#qos cos-map 0 1
```

```
Switch_A(config)#qos cos-map 1 0
```

- 4) Set the scheduler type of TC-0 and TC-1 as Weighted for egress port 1/0/3. Specify the queue weight of TC-0 as 1 and specify the queue weight of TC-1 as 5.

```
Switch_A(config)#interface fastEthernet 1/0/3
Switch_A(config-if)#qos queue 0 mode wrr weight 1
Switch_A(config-if)#qos queue 1 mode wrr weight 5
Switch_A(config-if)#end
Switch_A#copy running-config startup-config
```

### Verify the configurations

Verify the trust mode of the port:

```
Switch_A#show qos trust interface
```

| Port    | Trust Mode | LAG   |
|---------|------------|-------|
| -----   | -----      | ----- |
| Fa1/0/1 | untrust    | N/A   |
| Fa1/0/2 | untrust    | N/A   |
| Fa1/0/3 | untrust    | N/A   |
| Fa1/0/4 | untrust    | N/A   |
| ...     |            |       |

Verify the port to 802.1p mappings:

```
Switch_A#show qos port-priority interface
```

| Port    | CoS Value | LAG   |
|---------|-----------|-------|
| -----   | -----     | ----- |
| Fa1/0/1 | CoS 1     | N/A   |
| Fa1/0/2 | CoS 0     | N/A   |
| Fa1/0/3 | CoS 0     | N/A   |
| Fa1/0/4 | CoS 0     | N/A   |
| ...     |           |       |

Verify the 802.1p to queue mappings:

```
Switch_A#show qos cos-map
```

```
-----+-----+-----+-----+-----+-----+-----+-----+-----
Dot1p Value |0   |1   |2   |3   |4   |5   |6   |7
-----+-----+-----+-----+-----+-----+-----+-----+-----
TC          |TC1 |TC0 |TC2 |TC4 |TC4 |TC5 |TC6 |TC7
-----+-----+-----+-----+-----+-----+-----+-----+-----
```

Verify the scheduler mode of the egress port:

```
Switch_A#show qos queue interface fastEthernet 1/0/3
```

```
Fa1/0/3----LAG: N/A
```

```
Queue  Schedule Mode  Weight
```

```
-----  -----  -----
TC0     WRR       1
TC1     WRR       5
TC2     WRR       1
TC3     WRR       1
TC4     WRR       1
TC5     WRR       1
TC6     WRR       1
TC7     WRR       1
```

## 6.2 Example for Voice VLAN

### 6.2.1 Network Requirements

As shown below, the company plans to install IP phones in the office area. To ensure the good voice quality, IP phones and the computers will be connected to the different ports of the switch, and the voice traffic requires a higher priority than the data traffic.

Figure 6-5 Voice VLAN Application Topology

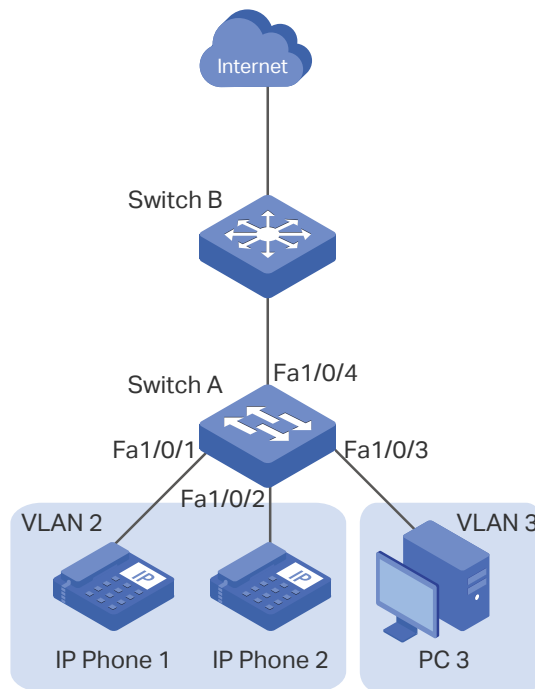

## 6.2.2 Configuration Scheme

To implement this requirement, you can configure Voice VLAN to ensure that the voice traffic can be transmitted in the same VLAN and the data traffic is transmitted in another VLAN. In addition, specify the priority to make the voice traffic can take precedence when the congestion occurs.

- 1) Configure 802.1Q VLAN for port 1/0/1, port 1/0/2, port 1/0/3 and port 1/0/4.
- 2) Configure Voice VLAN feature on port 1/0/1 and port 1/0/2.

Demonstrated with T2600G-28TS, the following sections provide configuration procedure in two ways: using the GUI and using the CLI.

## 6.2.3 Using the GUI

- 1) Choose the menu **L2 FEATURES > VLAN > 802.1Q VLAN > VLAN Config** and click **+ Add** to load the following page. Create VLAN 2 and add untagged port 1/0/1, port 1/0/2 and port 1/0/4 to VLAN 2. Click **Create**.

Figure 6-6 Configuring VLAN 2

VLAN Config

VLAN ID:  (2-4094, format: 2,4-5,8)

VLAN Name:  (1-16 characters)

---

Untagged Ports

Port:  (Format: 1/0/1, input or choose below)

UNIT1
LAGS

Select All

2

4

6

8

10

12

14

16

18

20

22

24

26

28

1

3

5

7

9

11

13

15

17

19

21

23

25

27

Selected

Unselected

Not Available

---

Tagged Ports

Port:  (Format: 1/0/1, input or choose below)

UNIT1
LAGS

Select All

2

4

6

8

10

12

14

16

18

20

22

24

26

28

1

3

5

7

9

11

13

15

17

19

21

23

25

27

Selected

Unselected

Not Available

Cancel

Create

- 2) Click **Add** to load the following page. Create VLAN 3 and add untagged port 1/0/3 and port 1/0/4 to VLAN 3. Click **Create**.

Figure 6-7 Configuring VLAN 3

VLAN Config

VLAN ID:  (2-4094, format: 2,4-5,8)

VLAN Name:  (1-16 characters)

---

Untagged Ports

Port:  (Format: 1/0/1, input or choose below)

UNIT1
LAGS

Select All

2

4

6

8

10

12

14

16

18

20

22

24

26

28

1

3

5

7

9

11

13

15

17

19

21

23

25

27

Selected

Unselected

Not Available

---

Tagged Ports

Port:  (Format: 1/0/1, input or choose below)

UNIT1
LAGS

Select All

2

4

6

8

10

12

14

16

18

20

22

24

26

28

1

3

5

7

9

11

13

15

17

19

21

23

25

27

Selected

Unselected

Not Available

- 3) Choose the menu **L2 FEATURES > VLAN > 802.1Q VLAN > Port Config** to load the following page. Disable the Ingress Checking feature on port 1/0/1 and port 1/0/2 and specify the PVID as 2. Click **Apply**.

Figure 6-8 Specifying the Parameters of the Ports

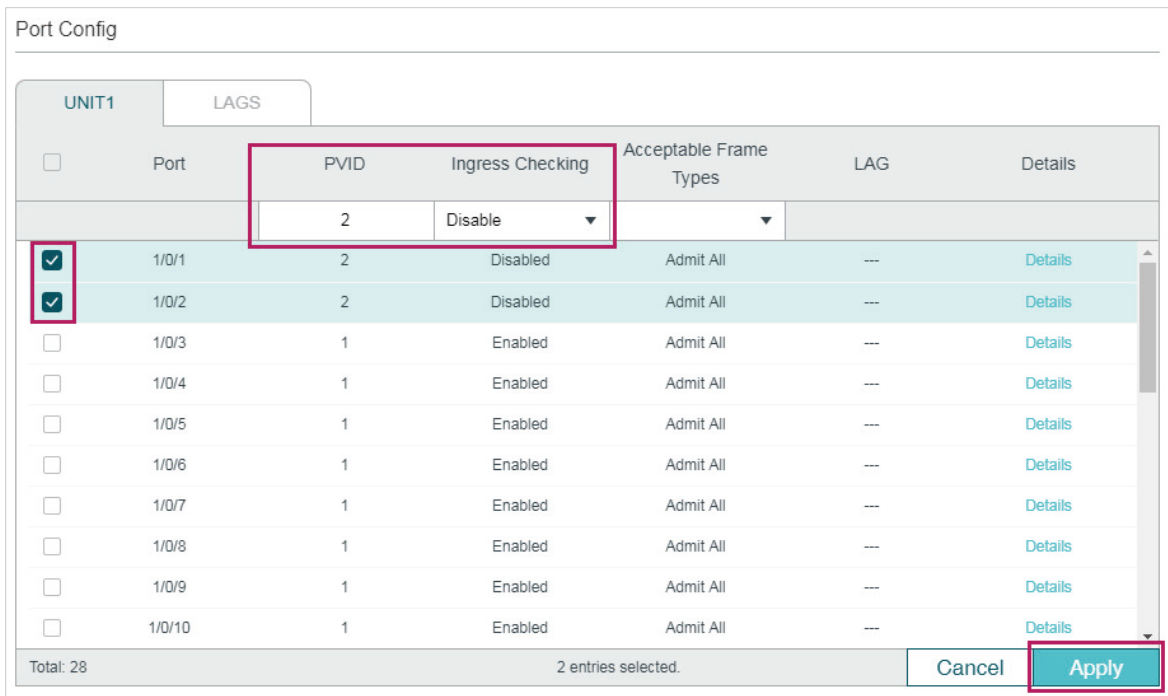

- 4) Choose the menu **QoS > Voice VLAN > OUI Config** to load the following page. Check the OUI table.

Figure 6-9 Checking the OUI Table

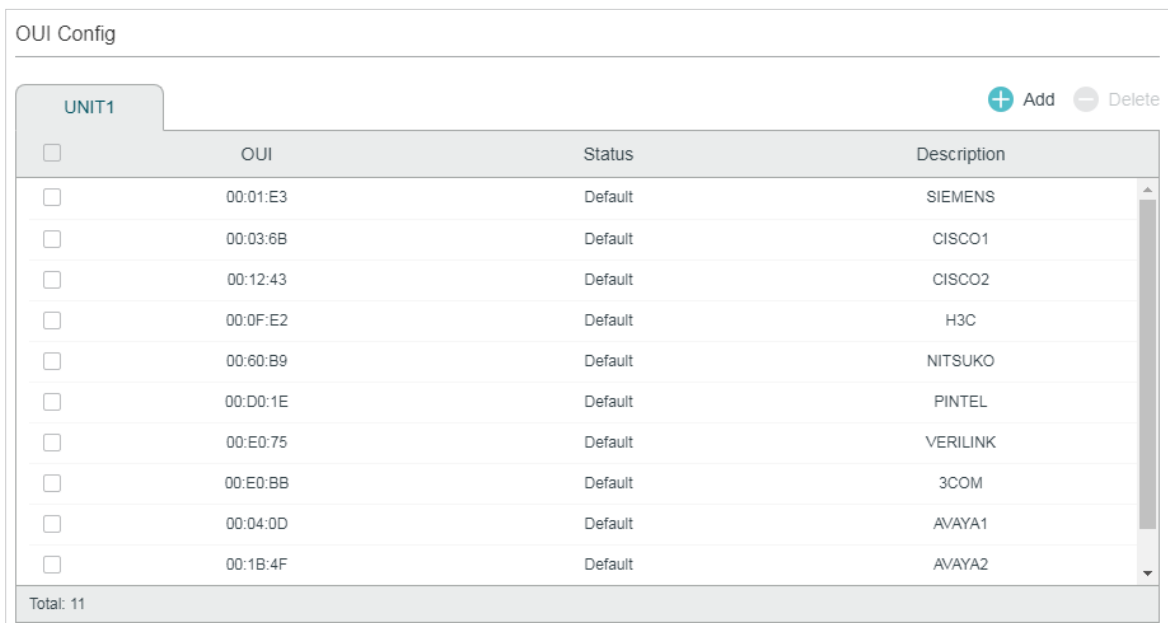

- 5) Choose the menu **QoS > Voice VLAN > Global Config** to load the following page. Enable Voice VLAN globally. Specify the VLAN ID as 2 and set the priority as 7. Click **Apply**.



Figure 6-10 Configuring Voice VLAN Globally

Global Config

Voice VLAN:  Enable

VLAN ID:  (2-4094)

Priority:

- 6) Choose the menu **QoS > Voice VLAN > Port Config** to load the following page. Enable Voice VLAN on port 1/0/1 and port 1/0/2. Click **Apply**.

Figure 6-11 Enabling Voice VLAN on Ports

Port Config

UNIT1 LAGS

| <input type="checkbox"/>            | Port   | Voice VLAN | Operational Status |
|-------------------------------------|--------|------------|--------------------|
| <input checked="" type="checkbox"/> | 1/0/1  | Enabled    | Inactive           |
| <input checked="" type="checkbox"/> | 1/0/2  | Enabled    | Inactive           |
| <input type="checkbox"/>            | 1/0/3  | Disabled   | Inactive           |
| <input type="checkbox"/>            | 1/0/4  | Disabled   | Inactive           |
| <input type="checkbox"/>            | 1/0/5  | Disabled   | Inactive           |
| <input type="checkbox"/>            | 1/0/6  | Disabled   | Inactive           |
| <input type="checkbox"/>            | 1/0/7  | Disabled   | Inactive           |
| <input type="checkbox"/>            | 1/0/8  | Disabled   | Inactive           |
| <input type="checkbox"/>            | 1/0/9  | Disabled   | Inactive           |
| <input type="checkbox"/>            | 1/0/10 | Disabled   | Inactive           |

Total: 28      2 entries selected.     

- 7) Click  Save to save the settings.

## 6.2.4 Using the CLI

- 1) Create VLAN 2 and add untagged port 1/0/1, port 1/0/2 and port 1/0/4 to VLAN 2.

```
Switch_A#configure
```

```
Switch_A(config)#vlan 2
```

```
Switch_A(config-vlan)#name VoiceVLAN
```

```
Switch_A(config-vlan)#exit
```

```
Switch_A(config)#interface fastEthernet 1/0/1
```

```
Switch_A(config-if)#switchport general allowed vlan 2 untagged
```

```
Switch_A(config-if)#exit
```

```
Switch_A(config)#interface fastEthernet 1/0/2
```

```
Switch_A(config-if)#switchport general allowed vlan 2 untagged
```

```
Switch_A(config-if)#exit
```

```
Switch_A(config)#interface fastEthernet 1/0/4
```

```
Switch_A(config-if)#switchport general allowed vlan 2 untagged
```

```
Switch_A(config-if)#exit
```

- 2) Create VLAN 3 and add untagged port 1/0/3 and port 1/0/4 to VLAN 3.

```
Switch_A(config)#vlan 3
```

```
Switch_A(config-vlan)#name VLAN3
```

```
Switch_A(config-vlan)#exit
```

```
Switch_A(config)#interface fastEthernet 1/0/3
```

```
Switch_A(config-if)#switchport general allowed vlan 3 untagged
```

```
Switch_A(config-if)#exit
```

```
Switch_A(config)#interface fastEthernet 1/0/4
```

```
Switch_A(config-if)#switchport general allowed vlan 3 untagged
```

```
Switch_A(config-if)#exit
```

- 3) Disable the Ingress Checking feature on port 1/0/1 and port 1/0/2 and specify the PVID as 2.

```
Switch_A(config)#interface fastEthernet 1/0/1
```

```
Switch_A(config-if)#no switchport check ingress
```

```
Switch_A(config-if)#switchport pvid 2
```

```
Switch_A(config-if)#exit
```

```
Switch_A(config)#interface fastEthernet 1/0/2
```

```
Switch_A(config-if)#no switchport check ingress
```

```
Switch_A(config-if)#switchport pvid 2
```

```
Switch_A(config-if)#exit
```

- 4) Check the OUI table.

```
Switch(config)#show voice vlan oui
```

```
00:01:E3   Default   SIEMENS
```

```
00:03:6B   Default   CISCO1
```

```
00:12:43   Default   CISCO2
```

```
00:0F:E2   Default   H3C
```

```

00:60:B9   Default   NITSUKO
00:D0:1E   Default   PINTEL
00:E0:75   Default   VERILINK
00:E0:BB   Default   3COM
00:04:0D   Default   AVAYA1
00:1B:4F   Default   AVAYA2
00:04:13   Default   SNOM

```

- 5) Enable Voice VLAN globally. Specify the VLAN ID as 2 and set the priority as 7.

```
Switch_A(config)#voice vlan 2
```

```
Switch_A(config)#voice vlan priority 7
```

- 6) Enable Voice VLAN on port 1/0/1 and port 1/0/2.

```
Switch_A(config)#interface fastEthernet 1/0/1
```

```
Switch_A(config-if)#voice vlan
```

```
Switch_A(config-if)#exit
```

```
Switch_A(config)#interface fastEthernet 1/0/2
```

```
Switch_A(config-if)#voice vlan
```

```
Switch_A(config-if)#end
```

```
Switch_A#copy running-config startup-config
```

## Verify the configurations

Verify the basic VLAN configuration:

```
Switch_A(config)#show vlan brief
```

| VLAN | Name        | Status | Ports   |
|------|-------------|--------|---|
| 1    | System-VLAN | active | Fa1/0/1, Fa1/0/2, Fa1/0/3, Fa1/0/4,<br>Fa1/0/5, Fa1/0/6, Fa1/0/7, Fa1/0/8,<br>Fa1/0/9, Fa1/0/10, Fa1/0/11, Fa1/0/12,<br>Fa1/0/13, Fa1/0/14, Fa1/0/15, Fa1/0/16,<br>Fa1/0/17, Fa1/0/18, Fa1/0/19, Fa1/0/20,<br>Fa1/0/21, Fa1/0/22, Fa1/0/23, Fa1/0/24,<br>Gi1/0/25, Gi1/0/26, Gi1/0/27, Gi1/0/28 |

```

2    VoiceVLAN    active    Fa1/0/1, Fa1/0/2, Fa1/0/4
3    VLAN3        active    Fa1/0/3, Fa1/0/4

```

Verify the Voice VLAN configuration:

```
Switch_A(config)#show voice vlan interface
```

```
Voice VLAN ID      2
```

```
Priority            7
```

| Interface | Voice VLAN Mode | Operational Status | LAG |
|-----------|-----------------|--------------------|-----|
| -----     | -----           | -----              | --- |
| Fa1/0/1   | enabled         | Up                 | N/A |
| Fa1/0/2   | enabled         | Up                 | N/A |
| Fa1/0/3   | disabled        | Down               | N/A |
| Fa1/0/4   | disabled        | Down               | N/A |
| Fa1/0/5   | disabled        | Down               | N/A |
| ...       |                 |                    |     |
| Gi1/0/28  | disabled        | Down               | N/A |

## 6.3 Example for Auto VoIP

### 6.3.1 Network Requirements

As shown below, the company plans to install IP phones in the office area. IP phones share switch ports used by computers, because no more ports are available for IP phones. To ensure the good voice quality, the voice traffic requires a higher priority than the data traffic.

Figure 6-12 Auto VoIP Application Topology

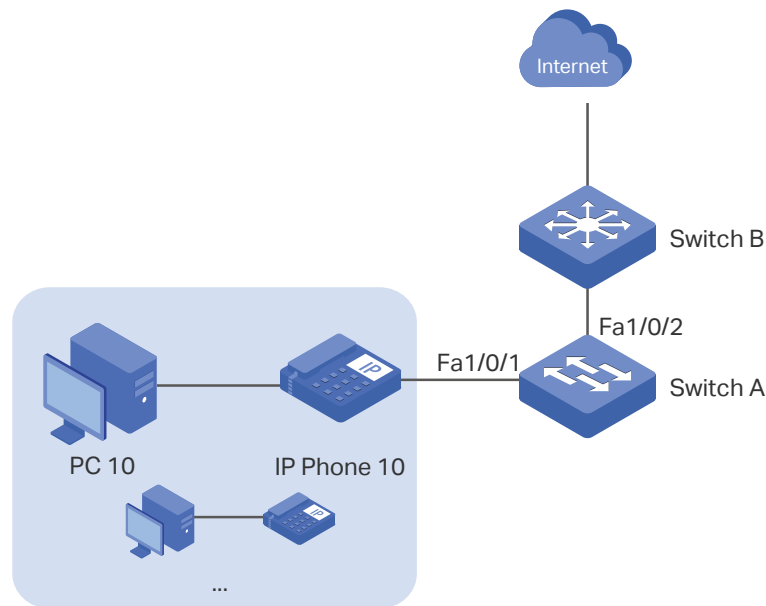

### 6.3.2 Configuration Scheme

To optimize voice traffic, configure Auto VoIP and LLDP-MED to instruct IP Phones to send traffic with desired DSCP priority. Voice traffic is put in the desired queue and data traffic is put in other queues according to the Class of Service configurations. Make sure that the voice traffic can take precedence when congestion occurs.

- 1) Enable the Auto VoIP feature and configure the DSCP value of ports.
- 2) Configure Class of Service.
- 3) Enable LLDP-MED and configure the corresponding parameters.

Demonstrated with T2600G-28TS, the following sections provide configuration procedure in two ways: using the GUI and using the CLI.

### 6.3.3 Using the GUI

Auto VoIP configurations for port1/0/1 and other ports connected to the IP phone are the same, the following configuration procedures take port 1/0/1 as example.

- 1) Choose the menu **QoS > Auto VoIP** to load the following page. Enable Auto VoIP globally and specify the DSCP value of port 1/0/1 as 63. Click **Apply**.

Figure 6-13 Configuring Auto VoIP

Global Config

Auto VoIP:  Enable

Port Config

UNIT1

| <input type="checkbox"/>            | Port   | Interface Mode | Value | CoS Override Mode | Operational Status | DSCP Value |
|-------------------------------------|--------|----------------|-------|-------------------|--------------------|------------|
| <input checked="" type="checkbox"/> | 1/0/1  | Disable        | 0     | Disabled          | Disabled           | 63         |
| <input type="checkbox"/>            | 1/0/2  | Disable        | 0     | Disabled          | Disabled           | 0          |
| <input type="checkbox"/>            | 1/0/3  | Disable        | 0     | Disabled          | Disabled           | 0          |
| <input type="checkbox"/>            | 1/0/4  | Disable        | 0     | Disabled          | Disabled           | 0          |
| <input type="checkbox"/>            | 1/0/5  | Disable        | 0     | Disabled          | Disabled           | 0          |
| <input type="checkbox"/>            | 1/0/6  | Disable        | 0     | Disabled          | Disabled           | 0          |
| <input type="checkbox"/>            | 1/0/7  | Disable        | 0     | Disabled          | Disabled           | 0          |
| <input type="checkbox"/>            | 1/0/8  | Disable        | 0     | Disabled          | Disabled           | 0          |
| <input type="checkbox"/>            | 1/0/9  | Disable        | 0     | Disabled          | Disabled           | 0          |
| <input type="checkbox"/>            | 1/0/10 | Disable        | 0     | Disabled          | Disabled           | 0          |

Total: 28 1 entry selected.

- 2) Choose the menu **QoS > Class of Service > Port Priority** to load the following page. Set the trust mode of port 1/0/1 as trust DSCP. Click **Apply**.

Figure 6-14 Configuring Port Priority

Port Priority Config

UNIT1 LAGS

| <input type="checkbox"/>            | Port   | 802.1p Priority | Trust Mode | LAG |
|-------------------------------------|--------|-----------------|------------|-----|
| <input checked="" type="checkbox"/> | 1/0/1  | 0               | Trust DSCP | --  |
| <input type="checkbox"/>            | 1/0/2  | 0               | Untrusted  | --  |
| <input type="checkbox"/>            | 1/0/3  | 0               | Untrusted  | --  |
| <input type="checkbox"/>            | 1/0/4  | 0               | Untrusted  | --  |
| <input type="checkbox"/>            | 1/0/5  | 0               | Untrusted  | --  |
| <input type="checkbox"/>            | 1/0/6  | 0               | Untrusted  | --  |
| <input type="checkbox"/>            | 1/0/7  | 0               | Untrusted  | --  |
| <input type="checkbox"/>            | 1/0/8  | 0               | Untrusted  | --  |
| <input type="checkbox"/>            | 1/0/9  | 0               | Untrusted  | --  |
| <input type="checkbox"/>            | 1/0/10 | 0               | Untrusted  | --  |

Total: 28 1 entry selected.

- 3) Choose the menu **QoS > Class of Service > DSCP Priority** to load the following page. Specify the 802.1p priority as 7 for DSCP priority 63. Click **Apply**.

Figure 6-15 Specifying the 802.1p priority for DSCP priority 63

DSCP Priority Config

| <input type="checkbox"/>            | DSCP Priority | 802.1p Priority | DSCP Remap      |
|-------------------------------------|---------------|-----------------|-----------------|
|                                     |               | 7               |                 |
| <input type="checkbox"/>            | 54            | 6               | 54              |
| <input type="checkbox"/>            | 55            | 6               | 55              |
| <input type="checkbox"/>            | 56            | 7               | 56 cs7 (111000) |
| <input type="checkbox"/>            | 57            | 7               | 57              |
| <input type="checkbox"/>            | 58            | 7               | 58              |
| <input type="checkbox"/>            | 59            | 7               | 59              |
| <input type="checkbox"/>            | 60            | 7               | 60              |
| <input type="checkbox"/>            | 61            | 7               | 61              |
| <input type="checkbox"/>            | 62            | 7               | 62              |
| <input checked="" type="checkbox"/> | 63            | 7               | 63              |

Total: 64      1 entry selected.     

- Specify the 802.1p priority as 5 for other DSCP priorities. Click **Apply**.

Figure 6-16 Specifying the 802.1p priority for Other DSCP priorities

DSCP Priority Config

| <input type="checkbox"/>            | DSCP Priority | 802.1p Priority | DSCP Remap      |
|-------------------------------------|---------------|-----------------|-----------------|
|                                     |               | 5               |                 |
| <input checked="" type="checkbox"/> | 54            | 5               | 54              |
| <input checked="" type="checkbox"/> | 55            | 5               | 55              |
| <input checked="" type="checkbox"/> | 56            | 5               | 56 cs7 (111000) |
| <input checked="" type="checkbox"/> | 57            | 5               | 57              |
| <input checked="" type="checkbox"/> | 58            | 5               | 58              |
| <input checked="" type="checkbox"/> | 59            | 5               | 59              |
| <input checked="" type="checkbox"/> | 60            | 5               | 60              |
| <input checked="" type="checkbox"/> | 61            | 5               | 61              |
| <input checked="" type="checkbox"/> | 62            | 5               | 62              |
| <input type="checkbox"/>            | 63            | 7               | 63              |

Total: 64      63 entries selected.     

- Choose the menu **QoS > Class of Service > Scheduler Settings** to load the following page. Select port 1/0/2. Set the scheduler mode as weighted and specify the queue weight as 1 for TC-5. Click **Apply**.

Figure 6-17 Configuring the TC-5 for the Port

Scheduler Config

UNIT1 LAGS

Selected Unselected Not Available

Port 1/0/2

| <input type="checkbox"/>            | Queue TC-id | Scheduler Type | Queue Weight | Management Type |
|-------------------------------------|-------------|----------------|--------------|-----------------|
| <input type="checkbox"/>            | 0           | Weighted       | 1            | Taildrop        |
| <input type="checkbox"/>            | 1           | Weighted       | 1            | Taildrop        |
| <input type="checkbox"/>            | 2           | Weighted       | 1            | Taildrop        |
| <input type="checkbox"/>            | 3           | Weighted       | 1            | Taildrop        |
| <input type="checkbox"/>            | 4           | Weighted       | 1            | Taildrop        |
| <input checked="" type="checkbox"/> | 5           | Weighted       | 1            | Taildrop        |
| <input type="checkbox"/>            | 6           | Weighted       | 1            | Taildrop        |
| <input type="checkbox"/>            | 7           | Weighted       | 1            | Taildrop        |

Total: 8 1 entry selected. Cancel Apply

- 6) Select port 1/0/2. Set the scheduler mode as weighted and specify the queue weight as 10 for TC-7. Click **Apply**.

Figure 6-18 Configuring the TC-7 for the Port

Scheduler Config

UNIT1 LAGS

Selected Unselected Not Available

Port 1/0/2

| <input type="checkbox"/>            | Queue TC-id | Scheduler Type | Queue Weight | Management Type |
|-------------------------------------|-------------|----------------|--------------|-----------------|
| <input type="checkbox"/>            | 0           | Weighted       | 1            | Taildrop        |
| <input type="checkbox"/>            | 1           | Weighted       | 1            | Taildrop        |
| <input type="checkbox"/>            | 2           | Weighted       | 1            | Taildrop        |
| <input type="checkbox"/>            | 3           | Weighted       | 1            | Taildrop        |
| <input type="checkbox"/>            | 4           | Weighted       | 1            | Taildrop        |
| <input type="checkbox"/>            | 5           | Weighted       | 1            | Taildrop        |
| <input type="checkbox"/>            | 6           | Weighted       | 1            | Taildrop        |
| <input checked="" type="checkbox"/> | 7           | Weighted       | 10           | Taildrop        |

Total: 8 1 entry selected. Cancel Apply



- 7) Choose the menu **L2 FEATURES > LLDP > LLDP-MED Config > Port Config** click Detail to of port1/0/1 to load the following page. Check the boxes of all the TLVs. Click **Save**.

Figure 6-19 Configuring the TLVs

- 8) Choose the menu **L2 FEATURES > LLDP > LLDP-MED Config > Port Config** to load the following page. Enable LLDP-MED on port 1/0/1. Click **Apply**.

Figure 6-20 Enabling LLDP-MED on the Port

| UNIT1                               |        |                 |                        |
|-------------------------------------|--------|-----------------|------------------------|
| <input type="checkbox"/>            | Port   | LLDP-MED Status | Included TLVs          |
| <input checked="" type="checkbox"/> | 1/0/1  | Enabled         | <a href="#">Detail</a> |
| <input type="checkbox"/>            | 1/0/2  | Disabled        | <a href="#">Detail</a> |
| <input type="checkbox"/>            | 1/0/3  | Disabled        | <a href="#">Detail</a> |
| <input type="checkbox"/>            | 1/0/4  | Disabled        | <a href="#">Detail</a> |
| <input type="checkbox"/>            | 1/0/5  | Disabled        | <a href="#">Detail</a> |
| <input type="checkbox"/>            | 1/0/6  | Disabled        | <a href="#">Detail</a> |
| <input type="checkbox"/>            | 1/0/7  | Disabled        | <a href="#">Detail</a> |
| <input type="checkbox"/>            | 1/0/8  | Disabled        | <a href="#">Detail</a> |
| <input type="checkbox"/>            | 1/0/9  | Disabled        | <a href="#">Detail</a> |
| <input type="checkbox"/>            | 1/0/10 | Disabled        | <a href="#">Detail</a> |

Total: 28      1 entry selected.

- 9) Click  Save to save the settings.

### 6.3.4 Using the CLI

- 1) Enable Auto VoIP globally and specify the DSCP value of port 1/0/1 as 63.

```
Switch_A#configure
```

```
Switch_A(config)#auto-voip
```

```
Switch_A(config)#interface fastEthernet 1/0/1
```

```
Switch_A(config-if)#auto-voip dscp 63
```

```
Switch_A(config-if)#exit
```

- 2) Set the trust mode of port 1/0/1 as trust DSCP. Specify the 802.1p priority as 7 for DSCP priority 63 and specify 802.1p priority as 5 for other DSCP priorities.

```
Switch_A(config)#interface fastEthernet 1/0/1
```

```
Switch_A(config-if)#qos trust mode dscp
```

```
Switch_A(config-if)#exit
```

```
Switch_A(config)#qos dscp-map 63 7
```

```
Switch_A(config)#qos dscp-map 0-62 5
```

- 3) On port 1/0/1, set the scheduler mode as weighted and specify the queue weight as 1 for TC-5. Set the scheduler mode as weighted and specify the queue weight as 10 for TC-7.

```
Switch_A(config)#interface fastEthernet 1/0/1
```

```
Switch_A(config-if)#qos queue 5 mode wrr weight 1
```

```
Switch_A(config-if)#qos queue 7 mode wrr weight 10
```

```
Switch_A(config-if)#exit
```

- 4) Enable LLDP-MED on port 1/0/1 and select all the TLVs to be included in outgoing LLDPDU.

```
Switch_A(config)#interface fastEthernet 1/0/1
```

```
Switch_A(config-if)#lldp med-status
```

```
Switch_A(config-if)#lldp med-tlv-select all
```

```
Switch_A(config-if)#end
```

```
Switch_A#copy running-config startup-config
```

## Verify the configurations

Verify the configuration of Auto VoIP:

```
Switch_A(config)#show auto-voip
```

```
Administrative Mode: Enabled
```

Verify the Auto VoIP configuration of ports:

```
Switch_A(config)#show auto-voip interface
```

```
Interface.Fa1/0/1
```

```
Auto-VoIP Interface Mode.      Disabled
```

```
Auto-VoIP COS Override.        False
```

```
Auto-VoIP DSCP Value.          63
```

```
Auto-VoIP Port Status.         Disabled
```

```
Interface.Fa1/0/2
```

```
Auto-VoIP Interface Mode.      Disabled
```

```
Auto-VoIP COS Override.        False
```

```
Auto-VoIP DSCP Value.          0
```

```
Auto-VoIP Port Status.         Disabled
```

```
Interface.Fa1/0/3
```

```
Auto-VoIP Interface Mode.      Disabled
```

```
Auto-VoIP COS Override.        False
```

```
Auto-VoIP DSCP Value.          0
```

```
Auto-VoIP Port Status.         Disabled
```

...

Verify the configuration of Class of Service:

```
Switch_A(config)#show qos trust interface fastEthernet 1/0/1
```

```
Port      Trust Mode  LAG
```

```
-----
```

```
Fa1/0/1  trust DSCP  N/A
```

```
Switch_A(config)#show qos cos-map
-----+-----+-----+-----+-----+-----+-----+-----+
Dot1p Value |0   |1   |2   |3   |4   |5   |6   |7
-----+-----+-----+-----+-----+-----+-----+-----+
TC           |TC1 |TC0 |TC2 |TC3 |TC4 |TC5 |TC6 |TC7
-----+-----+-----+-----+-----+-----+-----+-----+
```

```
Switch_A(config)#show qos dscp-map
DSCP:          0  1  2  3  4  5  6  7
DSCP to 802.1P 5  5  5  5  5  5  5  5
-----
DSCP:          8  9 10 11 12 13 14 15
DSCP to 802.1P 5  5  5  5  5  5  5  5
-----
DSCP:         16 17 18 19 20 21 22 23
DSCP to 802.1P 5  5  5  5  5  5  5  5
-----
DSCP:         24 25 26 27 28 29 30 31
DSCP to 802.1P 5  5  5  5  5  5  5  5
-----
DSCP:         32 33 34 35 36 37 38 39
DSCP to 802.1P 5  5  5  5  5  5  5  5
-----
DSCP:         40 41 42 43 44 45 46 47
DSCP to 802.1P 5  5  5  5  5  5  5  5
-----
DSCP:         48 49 50 51 52 53 54 55
DSCP to 802.1P 5  5  5  5  5  5  5  5
-----
DSCP:         56 57 58 59 60 61 62 63
DSCP to 802.1P 5  5  5  5  5  5  5  7
```

-----

Verify the configuration of LLDP-MED:

Switch\_A(config)#show lldp interface

LLDP interface config:

fastEthernet 1/0/1:

|                         |          |
|-------------------------|----------|
| Admin Status:           | TxRx     |
| SNMP Trap:              | Disabled |
| TLV                     | Status   |
| ---                     | -----    |
| Port-Description        | Yes      |
| System-Capability       | Yes      |
| System-Description      | Yes      |
| System-Name             | Yes      |
| Management-Address      | Yes      |
| Port-VLAN-ID            | Yes      |
| Protocol-VLAN-ID        | Yes      |
| VLAN-Name               | Yes      |
| Link-Aggregation        | Yes      |
| MAC-Physic              | Yes      |
| Max-Frame-Size          | Yes      |
| Power                   | Yes      |
| LLDP-MED Status:        | Enabled  |
| TLV                     | Status   |
| ---                     | -----    |
| Network Policy          | Yes      |
| Location Identification | Yes      |
| Extended Power Via MDI  | Yes      |

Inventory Management    Yes

...

# 7 Appendix: Default Parameters

Default settings of Class of Service are listed in the following tables.

Table 7-1 Default Settings of Port Priority Configuration

| Parameter       | Default Setting |
|-----------------|-----------------|
| 802.1P Priority | 0               |
| Trust Mode      | Untrusted       |

Table 7-2 Default Settings of 802.1p to Queue Mapping

| 802.1p Priority | Queues (8) |
|-----------------|------------|
| 0               | TC1        |
| 1               | TC0        |
| 2               | TC2        |
| 3               | TC3        |
| 4               | TC4        |
| 5               | TC5        |
| 6               | TC6        |
| 7               | TC7        |

Table 7-3 Default Settings of 802.1p Remap Configuration

| Original 802.1p Priority | New 802.1p Priority |
|--------------------------|---------------------|
| 0                        | 0                   |
| 1                        | 1                   |
| 2                        | 2                   |
| 3                        | 3                   |
| 4                        | 4                   |
| 5                        | 5                   |
| 6                        | 6                   |
| 7                        | 7                   |

Table 7-4 Default Settings of DSCP to 802.1p Mapping

| DSCP    | 802.1p Priority |
|---------|-----------------|
| 0 to 7  | 0               |
| 8 to 15 | 1               |

| DSCP     | 802.1p Priority |
|----------|-----------------|
| 16 to 23 | 2               |
| 24 to 31 | 3               |
| 32 to 39 | 4               |
| 40 to 47 | 5               |
| 48 to 55 | 6               |
| 56 to 63 | 7               |

Table 7-5 Default Settings of DSCP Remap Configuration

| Original DSCP | New DSCP         | Original DSCP | New DSCP         | Original DSCP | New DSCP        |
|---------------|------------------|---------------|------------------|---------------|-----------------|
| 0             | 0 be (000000)    | 22            | 22 af23 (010110) | 44            | 44              |
| 1             | 1                | 23            | 23               | 45            | 45              |
| 2             | 2                | 24            | 24 cs3 (011000)  | 46            | 46 ef (101110)  |
| 3             | 3                | 25            | 25               | 47            | 47              |
| 4             | 4                | 26            | 26 af31 (011010) | 48            | 48 cs6 (110000) |
| 5             | 5                | 27            | 27               | 49            | 49              |
| 6             | 6                | 28            | 28 af32 (011100) | 50            | 50              |
| 7             | 7                | 29            | 29               | 51            | 51              |
| 8             | 8 cs1 (001000)   | 30            | 30 af33 (011110) | 52            | 52              |
| 9             | 9                | 31            | 31               | 53            | 53              |
| 10            | 10 af11 (001010) | 32            | 32 cs4 (100000)  | 54            | 54              |
| 11            | 11               | 33            | 33               | 55            | 55              |
| 12            | 12 af12 (001100) | 34            | 34 af41 (100010) | 56            | 56 cs7 (111000) |
| 13            | 13               | 35            | 35               | 57            | 57              |
| 14            | 14 af13 (001110) | 36            | 36 af42 (100100) | 58            | 58              |
| 15            | 15               | 37            | 37               | 59            | 59              |
| 16            | 16 cs2 (010000)  | 38            | 38 af43 (100110) | 60            | 60              |
| 17            | 17               | 39            | 39               | 61            | 61              |
| 18            | 18 af21 (010010) | 40            | 40 cs5 (101000)  | 62            | 62              |
| 19            | 19               | 41            | 41               | 63            | 63              |
| 20            | 20 af22 (010100) | 42            | 42               |               |                 |
| 21            | 21               | 43            | 43               |               |                 |



Table 7-6 Default Settings of Scheduler Settings Configuration

| Parameter       | Default Setting |
|-----------------|-----------------|
| Scheduler Type  | Weighted        |
| Queue Weight    | 1               |
| Management Type | Taildrop        |

Default settings of Class of Service are listed in the following tables.

Table 7-7 Default Settings of Bandwidth Control

| Parameter                      | Default Setting |
|--------------------------------|-----------------|
| Ingress Rate (0-1,000,000Kbps) | 0               |
| Egress Rate (0-1,000,000Kbps)  | 0               |

Table 7-8 Default Settings of Storm Control

| Parameter                         | Default Setting |
|-----------------------------------|-----------------|
| Rate Mode                         | kbps            |
| Broadcast Threshold (0-1,000,000) | 0               |
| Multicast Threshold (0-1,000,000) | 0               |
| UL-Frame Threshold (0-1,000,000)  | 0               |
| Action                            | Drop            |
| Recover Time                      | 0               |

Default settings of Voice VLAN are listed in the following tables.

Table 7-9 Default Settings of Global Configuration

| Parameter  | Default Setting |
|------------|-----------------|
| Voice VLAN | Disabled        |
| VLAN ID    | None            |
| Priority   | 7               |

Table 7-10 Default Settings of Port Configuration

| Parameter  | Default Setting |
|------------|-----------------|
| Voice VLAN | Disabled        |

Table 7-11 Default Settings of OUI Table

| OUI      | Status  | Description |
|----------|---------|-------------|
| 00:01:E3 | Default | SIEMENS     |
| 00:03:6B | Default | CISCO1      |
| 00:12:43 | Default | CISCO2      |
| 00:0F:E2 | Default | H3C         |
| 00:60:B9 | Default | NITSUKO     |
| 00:D0:1E | Default | PINTEL      |
| 00:E0:75 | Default | VERILINK    |
| 00:E0:BB | Default | 3COM        |
| 00:04:0D | Default | AVAYA1      |
| 00:1B:4F | Default | AVAYA2      |
| 00:04:13 | Default | SNOM        |

Default settings of Auto VoIP are listed in the following tables.

Table 7-12 Default Settings of Auto VoIP

| Parameter         | Default Setting |
|-------------------|-----------------|
| Interface Mode    | Disabled        |
| Value             | None            |
| Cos Override Mode | Disabled        |
| DSCP Value        | 0               |

# Part 15

## Configuring Access Security

### CHAPTERS

1. Access Security
2. Access Security Configurations
3. Appendix: Default Parameters

# 1 Access Security

## 1.1 Overview

Access Security provides different security measures for accessing the switch remotely so as to enhance the configuration management security.

## 1.2 Supported Features

### Access Control

This function is used to control the users' access to the switch based on IP address, MAC address or port.

### HTTP

This function is based on the HTTP protocol. It can allow or deny users to access the switch via a web browser.

### HTTPS

This function is based on the SSL or TLS protocol working in transport layer. It supports a security access via a web browser.

### SSH

This function is based on the SSH protocol, a security protocol established on application and transport layers. The function with SSH is similar to a telnet connection, but SSH can provide information security and powerful authentication.

### Telnet

This function is based on the Telnet protocol subjected to TCP/IP protocol. Through Telnet, users can log on to the switch remotely.

# 2 Access Security Configurations

With access security configurations, you can:

- Configure the Access Control feature
- Configure the HTTP feature
- Configure the HTTPS feature
- Configure the SSH feature
- Configure the Telnet function

## 2.1 Using the GUI

### 2.1.1 Configuring the Access Control Feature

Choose the menu **SECURITY > Access Security > Access Control** to load the following page.

Figure 2-1 Configuring the Access Control

The screenshot shows a configuration page for Access Control. It is divided into two main sections: 'Global Config' and 'Entry Config'.

**Global Config:**

- Access Control:** A checkbox labeled 'Enable' is checked.
- Control Mode:** A dropdown menu is set to 'IP-based'.
- An **Apply** button is located on the right side.

**Entry Config:**

- Buttons for **+ Add** and **- Delete** are present.
- A table with the following columns: **Index**, **Port/IP/MAC**, **Access Interface**, and **Operation**.
- The table is currently empty, with the text "No entries in this table." centered below the header.
- A **Total: 0** summary is shown at the bottom of the table area.

- 1) In the **Global Config** section, enable Access Control, select one control mode and click **Apply**.

#### Control Mode

Choose how to control the users' access.

**IP-based:** Only the users within a certain IP-range can access the switch via the specified interfaces.

**MAC-based:** Only the users with a certain MAC address can access the switch via the specified interfaces.

**Port-based:** Only the users who are connected to certain ports can access the switch via the specified interfaces.

- 2) In the **Entry Config** section, click **+ Add** to add an Access Control entry.
- When the **IP-based** mode is selected, the following window will pop up.

Figure 2-2 Configuring Access Control Based on IP Range

#### Access Interface

Select the interfaces where to apply the Access Control rule. If an interface is unselected, all users can access the switch via it.

**SNMP:** A function to manage the network devices via NMS.

**Telnet:** A connection type for users to remote login.

**SSH:** A connection type based on SSH protocol.

**HTTP:** A connection type based on HTTP protocol.

**HTTPS:** A connection type based on SSL protocol.

**Ping:** A communication protocol to test the connection of the network.

#### IP Address/ Mask

Enter the IP address and mask to specify an IP range. Only the users within this IP range can access the switch via the specified interfaces.

- When the **MAC-based** mode is selected, the following window will pop up.

Figure 2-3 Configuring Access Control Based on MAC Address

**Access Interface**

Select the interfaces where to apply the Access Control rule. If an interface is unselected, all users can access the switch via it.

**SNMP:** A function to manage the network devices via NMS.

**Telnet:** A connection type for users to remote login.

**SSH:** A connection type based on SSH protocol.

**HTTP:** A connection type based on HTTP protocol.

**HTTPS:** A connection type based on SSL protocol.

**Ping:** A communication protocol to test the connection of the network.

**MAC Address**

Enter the MAC address. Only the users with this MAC address can access the switch via the specified interfaces.

- When the **Port-based** mode is selected, the following window will pop up.

Figure 2-4 Configuring Access Control Based on Port

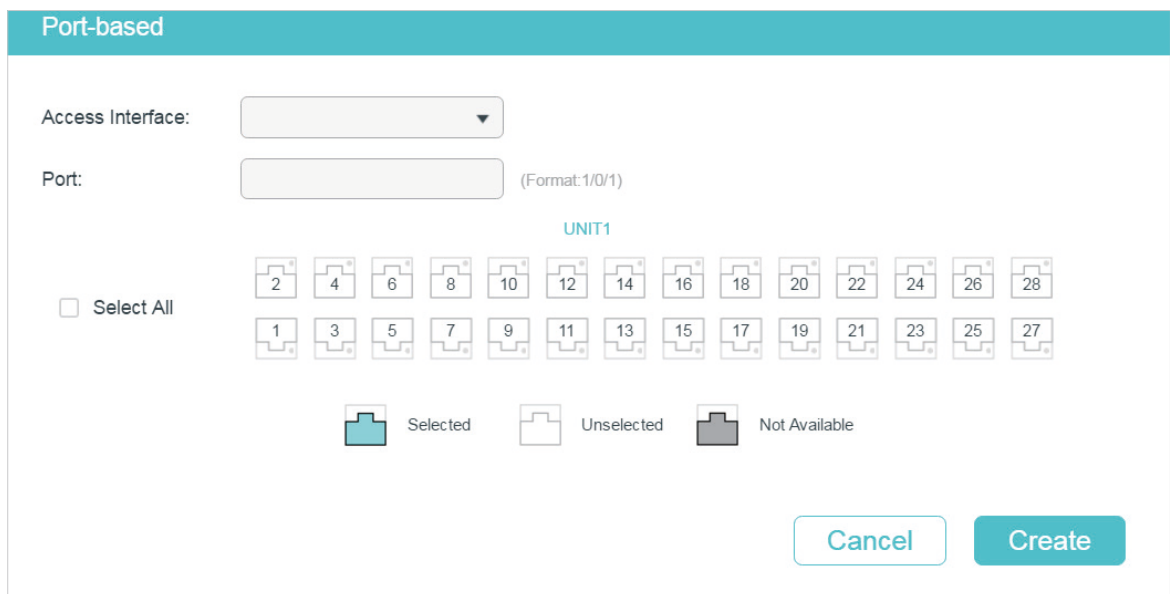

**Access Interface**

Select the interfaces where to apply the Access Control rule. If an interface is unselected, all users can access the switch via it.

**SNMP:** A function to manage the network devices via NMS.

**Telnet:** A connection type for users to remote login.

**SSH:** A connection type based on SSH protocol.

**HTTP:** A connection type based on HTTP protocol.

**HTTPS:** A connection type based on SSL protocol.

**Ping:** A communication protocol to test the connection of the network.

|             |   |
|-------------|---|
| <b>Port</b> | Select one or more ports. Only the users who are connected to these ports can access the switch via the specified interfaces. |
|-------------|---|

- 3) Click **Create**. Then you can view the created entries in the table.

## 2.1.2 Configuring the HTTP Function

Choose the menu **SECURITY > Access Security > HTTP Config** to load the following page.

Figure 2-5 Configuring the HTTP Function

The screenshot shows the configuration interface for the HTTP function, divided into three sections:

- Global Config:**
  - HTTP:**  Enable
  - Port:**  (1-65535)
  - Apply** button
- Session Config:**
  - Session Timeout:**  minutes (5-30)
  - Apply** button
- Number of Access Users:**
  - Number Control:**  Enable
  - Number of Admins:**  (1-16)
  - Number of Operators:**  (0-15)
  - Number of Power Users:**  (0-15)
  - Number of Users:**  (0-15)
  - Apply** button

- 1) In the **Global Control** section, enable HTTP function, specify the port using for HTTP, and click **Apply** to enable the HTTP function.

|             |  |
|-------------|--|
| <b>HTTP</b> | HTTP function is based on the HTTP protocol. It allows users to manage the switch through a web browser. |
|-------------|--|

|             |   |
|-------------|---|
| <b>Port</b> | Specify the port number for HTTP service. |
|-------------|---|

- 2) In the **Session Config** section, specify the Session Timeout and click **Apply**.

|                        |  |
|------------------------|--|
| <b>Session Timeout</b> | The system will log out automatically if users do nothing within the Session Timeout time. |
|------------------------|--|

- 3) In the **Number of Access Users** section, enable Number Control function, specify the following parameters and click **Apply**.



---

|                              |  |
|------------------------------|--|
| <b>Number Control</b>        | Enable or disable Number Control. With this option enabled, you can control the number of the users logging on to the web management page at the same time. The total number of users should be no more than 16. |
| <b>Number of Admins</b>      | Specify the maximum number of users whose access level is Admin.   |
| <b>Number of Operators</b>   | Specify the maximum number of users whose access level is Operator.  |
| <b>Number of Power Users</b> | Specify the maximum number of users whose access level is Power User.  |
| <b>Number of Users</b>       | Specify the maximum number of users whose access level is User.  |

---

## 2.1.3 Configuring the HTTPS Function

Choose the menu **SECURITY > Access Security > HTTPS Config** to load the following page.

Figure 2-6 Configuring the HTTPS Function

### Global Config

HTTPS:  Enable

Protocol Version:  ▼

Port:  (1-65535)

[Apply](#)

### Cipher Suite Config

RSA\_WITH\_RC4\_128\_MD5:  Enable

RSA\_WITH\_RC4\_128\_SHA:  Enable

RSA\_WITH\_DES\_CBC\_SHA:  Enable

RSA\_WITH\_3DES\_EDE\_CBC\_SHA:  Enable

ECDHE\_WITH\_AES\_128\_GCM\_SHA256:  Enable

ECDHE\_WITH\_AES\_256\_GCM\_SHA384:  Enable

[Apply](#)

### Session Config

Session Timeout:  minutes (5-30)

[Apply](#)

### Number of Access Users

Number Control:  Enable

Number of Admins:  (1-16)

Number of Operators:  (0-15)

Number of Power Users:  (0-15)

Number of Users:  (0-15)

[Apply](#)

### Load Certificate

Certificate File:  [Browse](#)

[Load](#)

### Load Key

Key File:  [Browse](#)

[Load](#)

- 1) In the Global Config section, enable HTTPS function, select the protocol version that the switch supports, and specify the port number for HTTPS. Click Apply.

|                  |  |
|------------------|--|
| HTTPS            | <p>Enable or disable the HTTPS function.</p> <p>HTTPS function is based on the SSL or TLS protocol. It provides a secure connection between the client and the switch.</p>   |
| Protocol Version | <p>Select the protocol version for HTTPS. Make sure the protocol in use is compatible with that on your HTTPS client.</p> <p>SSL is a transport protocol. It can provide server authentication, encryption and message integrity to allow secure HTTP connections.</p> <p>TLS is a transport protocol upgraded from SSL. It can support a more secure connection than SSL. TLS and SSL are not compatible with each other.</p> <p><b>SSL Version 3.0:</b> Select SSL Version 3.0 as the protocol for HTTPS.</p> <p><b>TLS Version 1.0:</b> Select TLS Version 1.0 as the protocol for HTTPS.</p> <p><b>TLS Version 1.1:</b> Select TLS Version 1.1 as the protocol for HTTPS.</p> <p><b>TLS Version 1.2:</b> Select TLS Version 1.2 as the protocol for HTTPS.</p> <p><b>All:</b> Enable all the above protocols for HTTPS. The HTTPS server and client will negotiate the protocol each time.</p> |
| Port             | Specify the port number for HTTPS service.   |

- 2) In the **Cipher Suite Config** section, select the algorithm to be enabled and click **Apply**.

|                               |   |
|-------------------------------|---|
| RSA_WITH_RC4_128_MD5          | 128-bit RC4 encryption with MD5 message authentication and RSA key exchange.  |
| RSA_WITH_RC4_128_SHA          | 128-bit RC4 encryption with SHA-1 message authentication and RSA key exchange.  |
| RSA_WITH_DES_CBC_SHA          | 56-bit DES encryption with SHA-1 message authentication and RSA key exchange.   |
| RSA_WITH_3DES_EDE_CBC_SHA     | 168-bit Triple DES encryption with SHA-1 message authentication and RSA key exchange.   |
| ECDHE_WITH_AES_128_GCM_SHA256 | 128-bit AES in Galois Counter Mode encryption with SHA-256 message authentication and elliptic curve Diffie-Hellman key exchange signed with an RSA certificate or ECDSA certificate. |
| ECDHE_WITH_AES_256_GCM_SHA384 | 256-bit AES in Galois Counter Mode encryption with SHA-384 message authentication and elliptic curve Diffie-Hellman key exchange signed with an RSA certificate or ECDSA certificate. |

- 3) In the **Session Config** section, specify the Session Timeout and click **Apply**.

|                 |  |
|-----------------|--|
| Session Timeout | The system will log out automatically if users do nothing within the Session Timeout time. |
|-----------------|--|

- 4) In the **Number of Access Users** section, enable Number Control function, specify the following parameters and click **Apply**.

---

|                              |  |
|------------------------------|--|
| <b>Number Control</b>        | Enable or disable Number Control. With this option enabled, you can control the number of the users logging on to the web management page at the same time. The total number of users should be no more than 16. |
| <b>Number of Admins</b>      | Specify the maximum number of users whose access level is Admin.   |
| <b>Number of Operators</b>   | Specify the maximum number of users whose access level is Operator.  |
| <b>Number of Power Users</b> | Specify the maximum number of users whose access level is Power User.  |
| <b>Number of Users</b>       | Specify the maximum number of users whose access level is User.  |

---

- 5) In the **Load Certificate** and **Load Key** section, download the certificate and key.

---

|                         |   |
|-------------------------|---|
| <b>Certificate File</b> | Select the desired certificate to download to the switch. The certificate must be BASE64 encoded. The SSL certificate and key downloaded must match each other, otherwise the HTTPS connection will not work. |
| <b>Key File</b>         | Select the desired Key to download to the switch. The key must be BASE64 encoded. The SSL certificate and key downloaded must match each other, otherwise the HTTPS connection will not work.                 |

---

## 2.1.4 Configuring the SSH Feature

Choose the menu **SECURITY > Access Security > SSH Config** to load the following page.

Figure 2-7 Configuring the SSH Feature

**Global Config**

SSH:  Enable

Protocol V1:  Enable

Protocol V2:  Enable

Idle Timeout:  seconds (1-120)

Maximum Connections:  (1-5)

Port:  (1-65535)

[Apply](#)

**Encryption Algorithm**

AES128-CBC:  Enable

AES192-CBC:  Enable

AES256-CBC:  Enable

Blowfish-CBC:  Enable

CAST128-CBC:  Enable

3DES-CBC:  Enable

[Apply](#)

**Data Integrity Algorithm**

HMAC-SHA1:  Enable

HMAC-MD5:  Enable

[Apply](#)

**Import Key File**

Choose the SSH public key file to be imported to the switch.

Key Type:

Key File:  [Browse](#)

[Import](#)

- 1) In the **Global Config** section, select **Enable** to enable SSH function and specify following parameters.

| SSH | Select <b>Enable</b> to enable the SSH function. |
|-----|--|
|-----|--|

SSH is a protocol working in application layer and transport layer. It can provide a secure, remote connection to a device. It is more secure than Telnet protocol as it provides strong encryption.

|                     |  |
|---------------------|--|
| Protocol V1         | Select <b>Enable</b> to enable SSH version 1.  |
| Protocol V2         | Select <b>Enable</b> to enable SSH version 2.  |
| Idle Timeout        | Specify the idle timeout time. The system will automatically release the connection when the time is up.   |
| Maximum Connections | Specify the maximum number of the connections to the SSH server. New connection will not be established when the number of the connections reaches the maximum number you set. |
| Port                | Specify the port using for SSH.  |

- 2) In the **Encryption Algorithm** section, enable the encryption algorithm you want the switch to support and click **Apply**.
- 3) In **Data Integrity Algorithm** section, enable the integrity algorithm you want the switch to support and click **Apply**.
- 4) In **Import Key File** section, select key type from the drop-down list and click **Browse** to download the desired key file.

|          |  |
|----------|--|
| Key Type | Select the key type. The algorithm of the corresponding type is used for both key generation and authentication.           |
| Key File | Select the desired public key to download to the switch. The key length of the downloaded file ranges of 512 to 3072 bits. |

 **Note:**

It will take a long time to download the key file. Please wait without any operation.

## 2.1.5 Configuring the Telnet Function

Choose the menu **SECURITY > Access Security > Telnet Config** to load the following page.

Figure 2-8 Configuring the Telnet Function

Telnet Config

---

Telnet:  Enable

Port:  (1-65535)

[Apply](#)

Enable Telnet and click **Apply**.

|        |   |
|--------|---|
| Telnet | Select <b>Enable</b> to make the Telnet function effective. Telnet function is based on the Telnet protocol subjected to TCP/IP protocol. It allows users to log on to the switch remotely. |
| Port   | Specify the port using for Telnet.  |

## 2.2 Using the CLI

### 2.2.1 Configuring the Access Control Feature

Follow these steps to configure the access control:

---

Step 1     **configure**

Enter global configuration mode.

---

Step 2     ■ Use the following command to control the users' access by limiting the IP address:

**user access-control ip-based enable**

Configure the control mode as IP-based.

**user access-control ip-based** { *ip-addr ip-mask* } [ snmp ] [ telnet ] [ ssh ] [ http ] [ https ] [ ping ] [ all ]

Only the users within a certain IP-range can access the switch via the specified interfaces.

*ip-addr*: Specify the IP address of the user.

*ip-mask*: Specify the subnet mask of the user.

[ snmp ] [ telnet ] [ ssh ] [ http ] [ https ] [ ping ] [ all ]: Select the interfaces where to apply the Access Control rule. If an interface is unselected, all users can access the switch via it. By default, all the interfaces are selected.

■ Use the following command to control the users' access by limiting the MAC address:

**user access-control mac-based enable**

Configure the control mode as MAC-based.

**user access-control mac-based** { *mac-addr* } [ snmp ] [ telnet ] [ ssh ] [ http ] [ https ] [ ping ] [ all ]

Only the users with a certain MAC address can access the switch via the specified interfaces.

*mac-addr*: Specify the MAC address of the user.

[ snmp ] [ telnet ] [ ssh ] [ http ] [ https ] [ ping ] [ all ]: Select the interfaces where to apply the Access Control rule. If an interface is unselected, all users can access the switch via it. By default, all the interfaces are selected.

■ Use the following command to control the users' access by limiting the ports connected to the users:

**user access-control port-based enable**

Configure the control mode as Port-based.

**user access-control port-based interface** { *fastEthernet port-list* | *gigabitEthernet port-list* | *ten-gigabitEthernet port-list* } [ snmp ] [ telnet ] [ ssh ] [ http ] [ https ] [ ping ] [ all ]

Only the users who are connected to certain ports can access the switch via the specified interfaces.

*port-list*: Specify the list of Ethernet ports, in the format of 1/0/1-4. You can appoint 5 ports at most.

[ snmp ] [ telnet ] [ ssh ] [ http ] [ https ] [ ping ] [ all ]: Select the interfaces where to apply the Access Control rule. If an interface is unselected, all users can access the switch via it. By default, all the interfaces are selected.

---

- 
- Step 3     **show user configuration**  
Verify the configuration of access control.
- 
- Step 4     **end**  
Return to privileged EXEC mode.
- 
- Step 5     **copy running-config startup-config**  
Save the settings in the configuration file.
- 

The following example shows how to set the type of access control as IP-based. Set the IP address as 192.168.0.100, set the subnet mask as 255.255.255.0, and select snmp, telnet, http and https to apply the Access Control rule.

**Switch#configure**

**Switch(config)#user access-control ip-based enable**

**Switch(config)#user access-control ip-based 192.168.0.100 255.255.255.0 snmp telnet http https**

**Switch(config)#show user configuration**

User authentication mode: IP based

| Index | IP Address       | Access Interface       |
|-------|------------------|------------------------|
| ----- | -----            | -----                  |
| 1     | 192.168.0.100/24 | SNMP Telnet HTTP HTTPS |

**Switch(config)#end**

**Switch#copy running-config startup-config**

## 2.2.2 Configuring the HTTP Function

Follow these steps to configure the HTTP function:

- 
- Step 1     **configure**  
Enter global configuration mode.
- 
- Step 2     **ip http server**  
Enable the HTTP function. By default, it is enabled.
- 
- Step 3     **ip http session timeout *minutes***  
Specify the Session Timeout time. The system will log out automatically if users do nothing within the Session Timeout time.
- minutes*: Specify the timeout time, which ranges from 5 to 30 minutes. The default value is 10.
-



- 
- Step 4    **ip http max-users** *admin-num operator-num poweruser-num user-num*
- Specify the maximum number of users that are allowed to connect to the HTTP server. The total number of users should be no more than 16.
- admin-num*: Enter the maximum number of users whose access level is Admin. The valid values are from 1 to 16.
- operator-num*: Enter the maximum number of users whose access level is Operator. The valid values are from 0 to 15.
- poweruser-num*: Enter the maximum number of users whose access level is Power User. The valid values are from 0 to 15.
- user-num*: Enter the maximum number of users whose access level is User. The valid values are from 0 to 15.
- 
- Step 5    **show ip http configuration**
- Verify the configuration information of the HTTP server, including status, session timeout, access-control, max-user number and the idle-timeout, etc.
- 
- Step 6    **end**
- Return to privileged EXEC mode.
- 
- Step 7    **copy running-config startup-config**
- Save the settings in the configuration file.
- 

The following example shows how to set the session timeout as 9, set the maximum admin number as 6, and set the maximum operator number as 2, the maximum power user number as 2, the maximum user number as 2.

**Switch#configure**

**Switch(config)#ip http server**

**Switch(config)#ip http session timeout 9**

**Switch(config)#ip http max-user 6 2 2 2**

**Switch(config)#show ip http configuration**

|                               |         |
|-------------------------------|---------|
| HTTP Status:                  | Enabled |
| HTTP Port:                    | 80      |
| HTTP Session Timeout:         | 9       |
| HTTP User Limitation:         | Enabled |
| HTTP Max Users as Admin:      | 6       |
| HTTP Max Users as Operator:   | 2       |
| HTTP Max Users as Power User: | 2       |
| HTTP Max Users as User:       | 2       |

**Switch(config)#end**

**Switch#copy running-config startup-config****2.2.3 Configuring the HTTPS Function**

Follow these steps to configure the HTTPS function:

---

|        |   |
|--------|---|
| Step 1 | <p><b>configure</b></p> <p>Enter global configuration mode.</p>   |
| Step 2 | <p><b>ip http secure-server</b></p> <p>Enable the HTTPS function. By default, it is enabled.</p>  |
| Step 3 | <p><b>ip http secure-protocol { ssl3   tls1   tls11   tls12   all }</b></p> <p>Select the protocol version for HTTPS. Make sure the protocol in use is compatible with that on your HTTPS client.</p> <p>SSL is a transport protocol. It can provide server authentication, encryption and message integrity to allow secure HTTP connections.</p> <p>TLS is a transport protocol upgraded from SSL. It can support a more secure connection than SSL. TLS and SSL are not compatible with each other.</p> <p><b>ssl3</b>: Select SSL Version 3.0 as the protocol for HTTPS.</p> <p><b>tls1</b>: Select TLS Version 1.0 as the protocol for HTTPS.</p> <p><b>tls11</b>: Select TLS Version 1.1 as the protocol for HTTPS.</p> <p><b>tls12</b>: Select TLS Version 1.2 as the protocol for HTTPS.</p> <p><b>all</b>: Enable all the above protocols for HTTPS. The HTTPS server and client will negotiate the protocol each time.</p>  |
| Step 4 | <p><b>ip http secure-ciphersuite { [ rc4-128-md5 ] [ rc4-128-sha ] [ des-cbc-sha ] [ 3des-ede-cbc-sha ] [ ecdhe-a128-g-s256 ] [ ecdhe-a256-g-s384 ] }</b></p> <p>Enable the corresponding cipher suite. By default, these types are all enabled.</p> <p><b>rc4-128-md5</b>: 128-bit RC4 encryption with MD5 message authentication and RSA key exchange.</p> <p><b>rc4-128-sha</b>: 128-bit RC4 encryption with SHA-1 message authentication and RSA key exchange.</p> <p><b>des-cbc-sha</b>: 56-bit DES encryption with SHA-1 message authentication and RSA key exchange.</p> <p><b>3des-ede-cbc-sha</b>: 168-bit Triple DES encryption with SHA-1 message authentication and RSA key exchange.</p> <p><b>ecdhe-a128-g-s256</b>: 128-bit AES in Galois Counter Mode encryption with SHA-256 message authentication and elliptic curve Diffie-Hellman key exchange signed with an RSA certificate or ECDSA certificate.</p> <p><b>ecdhe-a256-g-s384</b>: 256-bit AES in Galois Counter Mode encryption with SHA-384 message authentication and elliptic curve Diffie-Hellman key exchange signed with an RSA certificate or ECDSA certificate.</p> |

---

- 
- Step 5     **ip http secure-session timeout** *minutes*
- Specify the Session Timeout time. The system will log out automatically if users do nothing within the Session Timeout time.
- minutes*: Specify the timeout time, which ranges from 5 to 30 minutes. The default value is 10.
- 
- Step 6     **ip http secure-max-users** *admin-num operator-num poweruser-num user-num*
- Specify the maximum number of users that are allowed to connect to the HTTPS server. The total number of users should be no more than 16.
- admin-num*: Enter the maximum number of users whose access level is Admin. The valid values are from 1 to 16.
- operator-num*: Enter the maximum number of users whose access level is Operator. The valid values are from 0 to 15.
- poweruser-num*: Enter the maximum number of users whose access level is Power User. The valid values are from 0 to 15.
- user-num*: Enter the maximum number of users whose access level is User. The valid values are from 0 to 15.
- 
- Step 7     **ip http secure-server download certificate** *ssl-cert ip-address ip-addr*
- Download the desired certificate to the switch from TFTP server.
- ssl-cert*: Specify the name of the SSL certificate, which ranges from 1 to 25 characters. The certificate must be BASE64 encoded. The SSL certificate and key downloaded must match each other.
- ip-addr*: Specify the IP address of the TFTP server. Both IPv4 and IPv6 addresses are supported.
- 
- Step 8     **ip http secure-server download key** *ssl-key ip-address ip-addr*
- Download the desired key to the switch from TFTP server.
- ssl-key*: Specify the name of the key file saved in TFTP server. The key must be BASE64 encoded.
- ip-addr*: Specify the IP address of the TFTP server. Both IPv4 and IPv6 addresses are supported.
- 
- Step 9     **show ip http secure-server**
- Verify the global configuration of HTTPS.
- 
- Step 10    **end**
- Return to privileged EXEC mode.
- 
- Step 11    **copy running-config startup-config**
- Save the settings in the configuration file.
- 

The following example shows how to configure the HTTPS function. Enable all the protocol versions, including SSL 3.0, TLS 1.0, TLS 1.1 and TLS1.2. Enable the cipher suite of 3des-ede-cbc-sha. Set the session timeout time as 15, the maximum admin number as 2, the maximum operator number as 2, the maximum power user number as 2, the maximum user

number as 2. Download the certificate named ca.crt and the key named ca.key from the TFTP server with the IP address 192.168.0.100.

**Switch#configure**

**Switch(config)#ip http secure-server**

**Switch(config)#ip http secure-protocol all**

**Switch(config)#ip http secure-ciphersuite 3des-edc-cbc-sha**

**Switch(config)#ip http secure-session timeout 15**

**Switch(config)#ip http secure-max-users 2 2 2 2**

**Switch(config)#ip http secure-server download certificate ca.crt ip-address 192.168.0.100**

Start to download SSL certificate...

Download SSL certificate OK.

**Switch(config)#ip http secure-server download key ca.key ip-address 192.168.0.100**

Start to download SSL key...

Download SSL key OK.

**Switch(config)#show ip http secure-server**

|                                |                  |
|--------------------------------|------------------|
| HTTPS Status:                  | Enabled          |
| HTTPS Port:                    | 443              |
| SSL Protocol Level(s):         | all              |
| SSL CipherSuite:               | 3des-edc-cbc-sha |
| HTTPS Session Timeout:         | 15               |
| HTTPS User Limitation:         | Enabled          |
| HTTPS Max Users as Admin:      | 2                |
| HTTPS Max Users as Operator:   | 2                |
| HTTPS Max Users as Power User: | 2                |
| HTTPS Max Users as User:       | 2                |

**Switch(config)#end**

**Switch#copy running-config startup-config**

## 2.2.4 Configuring the SSH Feature

Follow these steps to configure the SSH function:

---

|        |   |
|--------|---|
| Step 1 | <b>configure</b><br>Enter global configuration mode.  |
| Step 2 | <b>ip ssh server</b><br>Enable the SSH function. By default, it is disabled.  |
| Step 3 | <b>ip ssh version { v1   v2 }</b><br>Configure to make the switch support the corresponding protocol. By default, the switch supports SSHv1 and SSHv3.<br><br><i>v1   v2</i> : Select to enable the corresponding protocol.   |
| Step 4 | <b>ip ssh timeout value</b><br>Specify the idle timeout time. The system will automatically release the connection when the time is up.<br><br><i>value</i> : Enter the value of the timeout time, which ranges from 1 to 120 seconds. The default value is 120 seconds.  |
| Step 5 | <b>ip ssh max-client num</b><br>Specify the maximum number of the connections to the SSH server. New connection will not be established when the number of the connections reaches the maximum number you set.<br><br><i>num</i> : Enter the number of the connections, which ranges from 1 to 5. The default value is 5.   |
| Step 6 | <b>ip ssh algorithm { AES128-CBC   AES192-CBC   AES256-CBC   Blowfish-CBC   Cast128-CBC   3DES-CBC   HMAC-SHA1   HMAC-MD5 }</b><br>Enable the corresponding algorithm. By default, these types are all enabled.<br><br><b>AES128-CBC   AES192-CBC   AES256-CBC   Blowfish-CBC   Cast128-CBC   3DES-CBC</b> : Specify the encryption algorithm you want the switch supports.<br><br><b>HMAC-SHA1   HMAC-MD5</b> : Specify the data integrity algorithm you want the switch supports.   |
| Step 7 | <b>ip ssh download { v1   v2 } key-file ip-address ip-addr</b><br>Select the type of the key file and download the desired file to the switch from TFTP server.<br><br><i>v1   v2</i> : Select the key type. The algorithm of the corresponding type is used for both key generation and authentication.<br><br><i>key-file</i> : Specify the name of the key file saved in TFTP server. Ensure the key length of the downloaded file is in the range of 512 to 3072 bits.<br><br><i>ip-addr</i> : Specify the IP address of the TFTP server. Both IPv4 and IPv6 addresses are supported. |
| Step 8 | <b>show ip ssh</b><br>Verify the global configuration of SSH.   |

---

---

Step 9     **end**  
Return to privileged EXEC mode.

---

Step 10    **copy running-config startup-config**  
Save the settings in the configuration file.

---

---

 **Note:**

It will take a long time to download the key file. Please wait without any operation.

---

The following example shows how to configure the SSH function. Set the version as SSH V1 and SSH V2. Enable the AES128-CBC and Cast128-CBC encryption algorithm. Enable the HMAC-MD5 data integrity algorithm. Choose the key type as SSH-2 RSA/DSA.

**Switch(config)#ip ssh server**

**Switch(config)#ip ssh version v1**

**Switch(config)#ip ssh version v2**

**Switch(config)#ip ssh timeout 100**

**Switch(config)#ip ssh max-client 4**

**Switch(config)#ip ssh algorithm AES128-CBC**

**Switch(config)#ip ssh algorithm Cast128-CBC**

**Switch(config)#ip ssh algorithm HMAC-MD5**

**Switch(config)#ip ssh download v2 publickey ip-address 192.168.0.100**

Start to download SSH key file...

Download SSH key file OK.

**Switch(config)#show ip ssh**

Global Config:

SSH Server:     Enabled

Protocol V1:    Enabled

Protocol V2:    Enabled

Idle Timeout:   100

MAX Clients:    4

Port:           22

Encryption Algorithm:

AES128-CBC:    Enabled

```
AES192-CBC: Disabled
AES256-CBC: Disabled
Blowfish-CBC: Disabled
Cast128-CBC: Enabled
3DES-CBC: Disabled
Data Integrity Algorithm:
HMAC-SHA1: Disabled
HMAC-MD5: Enabled
Key Type: SSH-2 RSA/DSA
Key File:
---- BEGIN SSH2 PUBLIC KEY ----
Comment: "dsa-key-20160711"
Switch(config)#end
Switch#copy running-config startup-config
```

## 2.2.5 Configuring the Telnet Function

Follow these steps enable the Telnet function:

- 
- |        |   |
|--------|---|
| Step 1 | <b>configure</b><br>Enter global configuration mode.                                      |
| Step 2 | <b>telnet enable</b><br>Enable the telnet function. By default, it is enabled.            |
| Step 3 | <b>telnet port port</b><br>Specify the port using for Telnet. It ranges from 1 to 65535.  |
| Step 4 | <b>end</b><br>Return to privileged EXEC mode.   |
| Step 4 | <b>copy running-config startup-config</b><br>Save the settings in the configuration file. |
-

# 3 Appendix: Default Parameters

Default settings of Access Security are listed in the following tables.

Table 3-1 Default Settings of Access Control Configuration

| Parameter      | Default Setting |
|----------------|-----------------|
| Access Control | Disabled        |

Table 3-2 Default Settings of HTTP Configuration

| Parameter       | Default Setting |
|-----------------|-----------------|
| HTTP            | Enabled         |
| Port            | 80              |
| Session Timeout | 10 minutes      |
| Number Control  | Disabled        |

Table 3-3 Default Settings of HTTPS Configuration

| Parameter                     | Default Setting |
|-------------------------------|-----------------|
| HTTPS                         | Enabled         |
| Protocol Version              | All             |
| Port                          | 443             |
| RSA_WITH_RC4_128_MD5          | Enabled         |
| RSA_WITH_RC4_128_SHA          | Enabled         |
| RSA_WITH_DES_CBC_SHA          | Enabled         |
| RSA_WITH_3DES_EDE_CBC_SHA     | Enabled         |
| ECDHE_WITH_AES_128_GCM_SHA256 | Enabled         |
| ECDHE_WITH_AES_256_GCM_SHA384 | Enabled         |
| Session Timeout               | 10 minutes      |
| Number Control                | Disabled        |

Table 3-4 Default Settings of SSH Configuration

| Parameter   | Default Setting |
|-------------|-----------------|
| SSH         | Disabled        |
| Protocol V1 | Enabled         |
| Protocol V2 | Enabled         |



| Parameter           | Default Setting |
|---------------------|-----------------|
| Idle Timeout        | 120 seconds     |
| Maximum Connections | 5               |
| Port                | 22              |
| AES128-CBC          | Enabled         |
| AES192-CBC          | Enabled         |
| AES256-CBC          | Enabled         |
| Blowfish-CBC        | Enabled         |
| Cast128-CBC         | Enabled         |
| 3DES-CBC            | Enabled         |
| HMAC-SHA1           | Enabled         |
| HMAC-MD5            | Enabled         |
| Key Type:           | SSH-2 RSA/DSA   |

Table 3-5 Default Settings of Telnet Configuration

| Parameter | Default Setting |
|-----------|-----------------|
| Telnet    | Enabled         |
| Port      | 23              |

# Part 16

## Configuring AAA

### CHAPTERS

1. Overview
2. AAA Configuration
3. Configuration Example
4. Appendix: Default Parameters

# 1 Overview

AAA stands for authentication, authorization and accounting. On TP-Link switches, this feature is mainly used to authenticate the users trying to log in to the switch or get administrative privileges. The administrator can create guest accounts and an Enable password for other users. The guests do not have administrative privileges without the Enable password provided.

AAA provides a safe and efficient authentication method. The authentication can be processed locally on the switch or centrally on the RADIUS/TACACS+ server(s). As the following figure shows, the network administrator can centrally configure the management accounts of the switches on the RADIUS server and use this server to authenticate the users trying to access the switch or get administrative privileges.

Figure 1-1 Network Topology of AAA

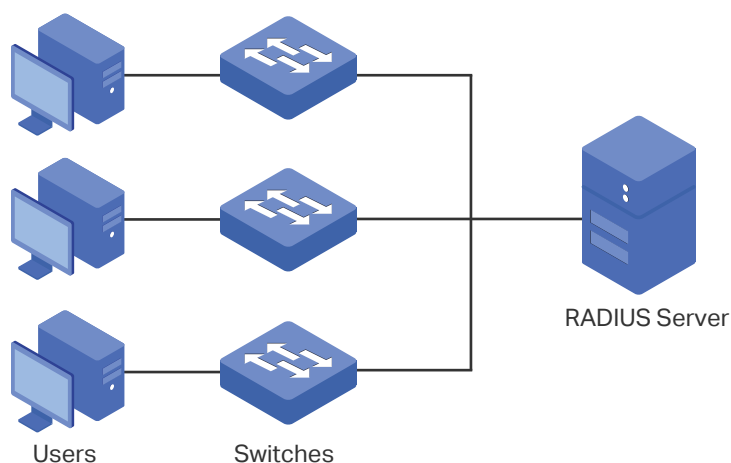

# 2 AAA Configuration

In the AAA feature, the authentication can be processed locally on the switch or centrally on the RADIUS/TACACS+ server(s). To ensure the stability of the authentication system, you can configure multiple servers and authentication methods at the same time. This chapter introduces how to configure this kind of comprehensive authentication in AAA.

To complete the configuration, follow these steps:

- 1) Add the servers.
- 2) Configure the server groups.
- 3) Configure the method list.
- 4) Configure the AAA application list.
- 5) Configure the login account and the Enable password.

## Configuration Guidelines

The basic concepts and working mechanism of AAA are as follows:

### ■ AAA Default Setting

By default, the AAA feature is enabled and cannot be disabled.

### ■ Server Group

Multiple servers running the same protocol can be added to a server group, and the servers in the group will authenticate the users in the order they are added. The server that is first added to the group has the highest priority, and is responsible for authentication under normal circumstances. If the first one breaks down or doesn't respond to the authentication request for some reason, the second sever will start working for authentication, and so on.

### ■ Method List

A server group is regarded as a method, and the local authentication is another method. Several methods can be configured to form a method list. The switch uses the first method in the method list to authenticate the user, and if that method fails to respond, the switch selects the next method. This process continues until the user has a successful communication with a method or until all defined methods are exhausted. If the authentication succeeds or the secure server or the local switch denies the user's access, the authentication process stops and no other methods are attempted.

Two types of method list are provided: Login method list for users of all types to access the switch, and Enable method list for guests to get administrative privileges.

## ■ AAA Application List

The switch supports the following access applications: Telnet, SSH and HTTP. You can select the configured authentication method lists for each application.

## 2.1 Using the GUI

### 2.1.1 Adding Servers

You can add one or more RADIUS/TACACS+ servers on the switch for authentication. If multiple servers are added, the server that is first added to the group has the highest priority and authenticates the users trying to access the switch. The others act as backup servers in case the first one breaks down.

#### ■ Adding RADIUS Server

Choose the menu **SECURITY > AAA > RADIUS Config** and click  Add to load the following page.

Figure 2-1 RADIUS Server Configuration

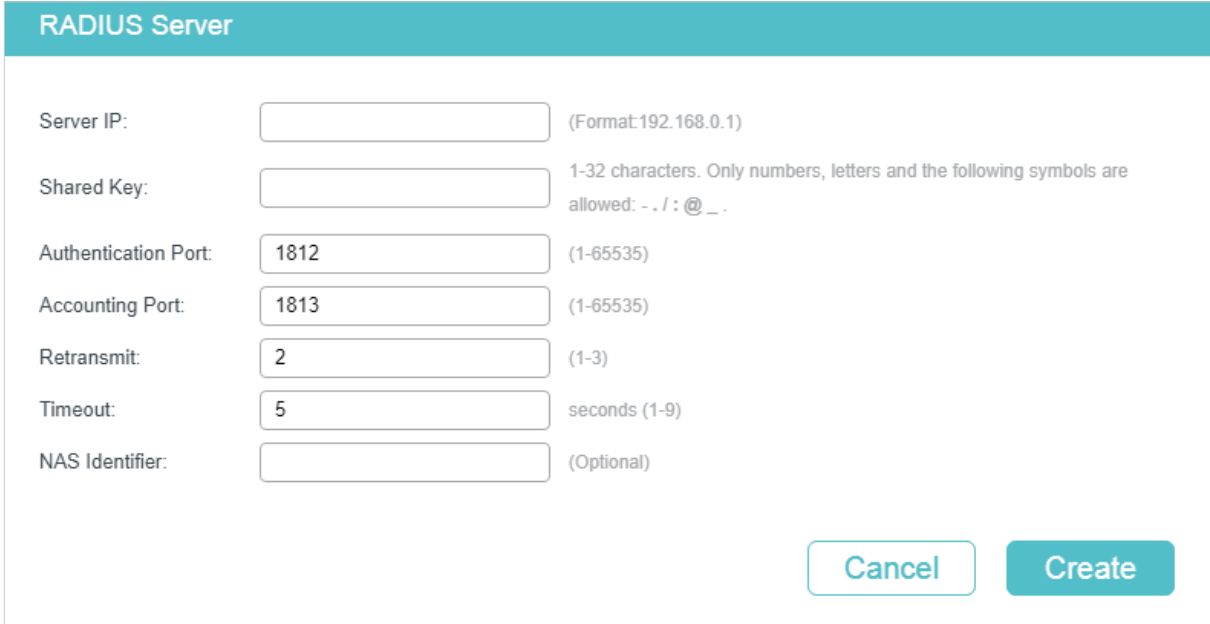

**RADIUS Server**

Server IP:  (Format:192.168.0.1)

Shared Key:  1-32 characters. Only numbers, letters and the following symbols are allowed: - . / : @ \_ .

Authentication Port:  (1-65535)

Accounting Port:  (1-65535)

Retransmit:  (1-3)

Timeout:  seconds (1-9)

NAS Identifier:  (Optional)

Follow these steps to add a RADIUS server:

1) Configure the following parameters.

|                     |   |
|---------------------|---|
| Server IP           | Enter the IP address of the server running the RADIUS secure protocol.  |
| Shared Key          | Enter the shared key between the RADIUS server and the switch. The RADIUS server and the switch use the key string to encrypt passwords and exchange responses. |
| Authentication Port | Specify the UDP destination port on the RADIUS server for authentication requests. The default setting is 1812.   |

|                 |  |
|-----------------|--|
| Accounting Port | Specify the UDP destination port on the RADIUS server for accounting requests. The default setting is 1813. Usually, it is used in the 802.1x feature.   |
| Retransmit      | Specify the number of times a request is resent to the server if the server does not respond. The default setting is 2.  |
| Timeout         | Specify the time interval that the switch waits for the server to reply before resending. The default setting is 5 seconds.  |
| NAS Identifier  | Specify the name of the NAS (Network Access Server) to be contained in RADIUS packets for identification. It ranges from 1 to 31 characters. The default value is the MAC address of the switch. Generally, the NAS indicates the switch itself. |

2) Click **Create** to add the RADIUS server on the switch.

■ Adding TACACS+ Server

Choose the menu **SECURITY > AAA > TACACS+ Config** and click  Add to load the following page.

Figure 2-2 TACACS+ Server Configuration

TACACS+ Server

Server IP:  (Format: 192.168.0.1)

Timeout:  seconds (1-9)

Shared Key:  1-32 characters. Only numbers, letters and the following symbols are allowed: - . / : @ \_ .

Server Port:  (1-65535)

Follow these steps to add a TACACS+ server:

1) Configure the following parameters.

|             |   |
|-------------|---|
| Server IP   | Enter the IP address of the server running the TACACS+ secure protocol.   |
| Timeout     | Specify the time interval that the switch waits for the server to reply before resending. The default setting is 5 seconds.                                       |
| Shared Key  | Enter the shared key between the TACACS+ server and the switch. The TACACS+ server and the switch use the key string to encrypt passwords and exchange responses. |
| Server Port | Specify the TCP port used on the TACACS+ server for AAA. The default setting is 49.   |

2) Click **Create** to add the TACACS+ server on the switch.

## 2.1.2 Configuring Server Groups

The switch has two built-in server groups, one for RADIUS servers and the other for TACACS+ servers. The servers running the same protocol are automatically added to the default server group. You can add new server groups as needed.

Choose the menu **SECURITY > AAA > Server Group** to load the following page.

Figure 2-3 Add New Server Group

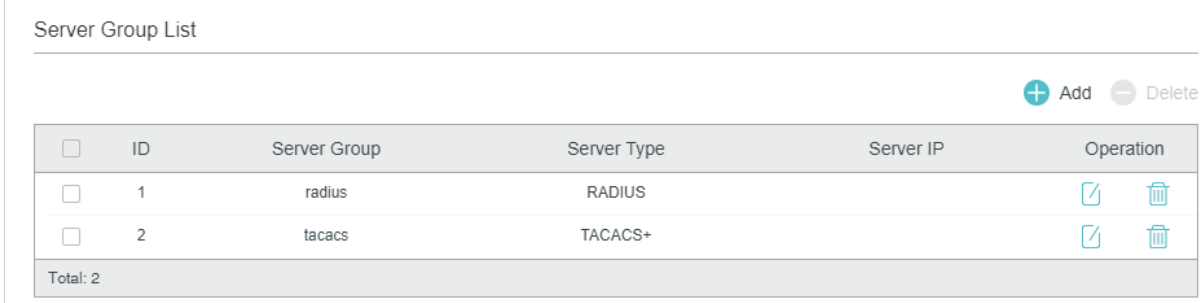

Server Group List

+ Add - Delete

| <input type="checkbox"/> | ID | Server Group | Server Type | Server IP | Operation                                   |
|--------------------------|----|--------------|-------------|-----------|---|
| <input type="checkbox"/> | 1  | radius       | RADIUS      |           | <a href="#">Edit</a> <a href="#">Delete</a> |
| <input type="checkbox"/> | 2  | tacacs       | TACACS+     |           | <a href="#">Edit</a> <a href="#">Delete</a> |
| Total: 2                 |    |              |             |           |   |

There are two default server groups in the list. You can edit the default server groups or follow these steps to configure a new server group:

- 1) Click **+ Add** and the following window will pop up.

Figure 2-4 Add Server Group

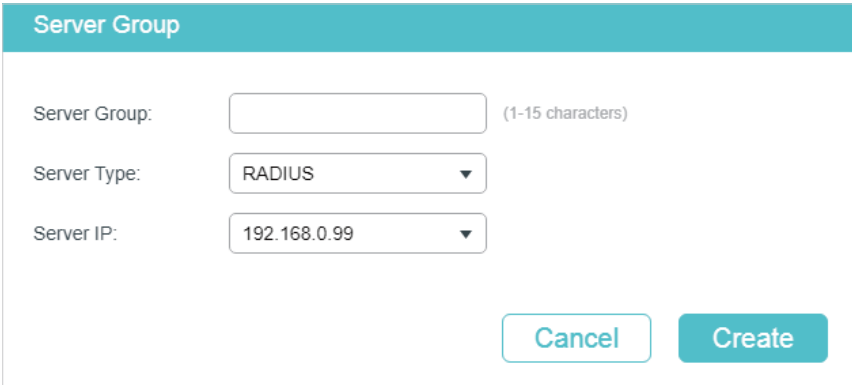

**Server Group**

Server Group:  (1-15 characters)

Server Type:

Server IP:

Configure the following parameters:

|                     |   |
|---------------------|---|
| <b>Server Group</b> | Specify a name for the server group.  |
| <b>Server Type</b>  | Select the server type for the group. The following options are provided: RADIUS and TACACS+. |
| <b>Server IP</b>    | Select the IP address of the server which will be added to the server group.                  |

- 2) Click **Create**.

## 2.1.3 Configuring the Method List

A method list describes the authentication methods and their sequence to authenticate the users. The switch supports Login Method List for users of all types to gain access to the switch, and Enable Method List for guests to get administrative privileges.

Choose the menu **SECURITY > AAA > Method List** to load the following page.

Figure 2-5 Method List

| Authentication Login Method List |    |         |       |      |      |      |                |
|----------------------------------|----|---------|-------|------|------|------|----------------|
|                                  |    |         |       |      |      |      | + Add - Delete |
| <input type="checkbox"/>         | ID | Name    | Pri1  | Pri2 | Pri3 | Pri4 | Operation      |
| <input type="checkbox"/>         | 1  | default | local | --   | --   | --   |                |
| Total: 1                         |    |         |       |      |      |      |                |

| Authentication Enable Method List |    |         |      |      |      |      |                |
|-----------------------------------|----|---------|------|------|------|------|----------------|
|                                   |    |         |      |      |      |      | + Add - Delete |
| <input type="checkbox"/>          | ID | Name    | Pri1 | Pri2 | Pri3 | Pri4 | Operation      |
| <input type="checkbox"/>          | 1  | default | none | --   | --   | --   |                |
| Total: 1                          |    |         |      |      |      |      |                |

There are two default methods respectively for the Login authentication and the Enable authentication.

You can edit the default methods or follow these steps to add a new method:

- 1) Click **+ Add** in the **Authentication Login Method List** section or **Authentication Enable Method List** section to add corresponding type of method list. The following window will pop up.

Figure 2-6 Add New Method

Authentication Login Method

Method List Name:  (1-15 characters)

Pri1:

Pri2:

Pri3:

Pri4:

Configure the parameters for the method to be added.

|                         |                                |
|-------------------------|--------------------------------|
| <b>Method List Name</b> | Specify a name for the method. |
|-------------------------|--------------------------------|



Pri1- Pri4

Specify the authentication methods in order. The method with priority 1 authenticates a user first, the method with priority 2 is tried if the previous method does not respond, and so on.

**local:** Use the local database in the switch for authentication.

**none:** No authentication is used.

**radius:** Use the remote RADIUS server/server groups for authentication.

**tacacs:** Use the remote TACACS+ server/server groups for authentication.

**Other user-defined server groups:** Use the user-defined server groups for authentication.

2) Click **Create** to add the new method.

### 2.1.4 Configuring the AAA Application List

Choose the menu **SECURITY > AAA > Global Config** to load the following page.

Figure 2-7 Configure Application List

| <input type="checkbox"/>            | Index | Module | Login List | Enable List |
|-------------------------------------|-------|--------|------------|-------------|
| <input checked="" type="checkbox"/> | 1     | telnet | default    | default     |
| <input type="checkbox"/>            | 2     | ssh    | default    | default     |
| <input type="checkbox"/>            | 3     | http   | default    | default     |

Total: 3      1 entry selected.     

Follow these steps to configure the AAA application list.

1) In the **AAA Application List** section, select an access application and configure the Login list and Enable list.

**Module**      Displays the configurable applications on the switch: telnet, ssh and http.

**Login List**      Select a previously configured Login method list. This method list will authenticate the users trying to log in to the switch.

**Enable List**      Select a previously configured Enable method list. This method list will authenticate the users trying to get administrative privileges.

2) Click **Apply**.

### 2.1.5 Configuring Login Account and Enable Password

The login account and Enable password can be configured locally on the switch or centrally on the RADIUS/TACACS+ server(s).

### ■ On the Switch

The local username and password for login can be configured in the User Management feature. For details, refer to [Managing System](#).

To configure the local Enable password for getting administrative privileges, choose the menu **SECURITY > AAA > Global Config** to load the following page.

Figure 2-8 Configure Enable Password

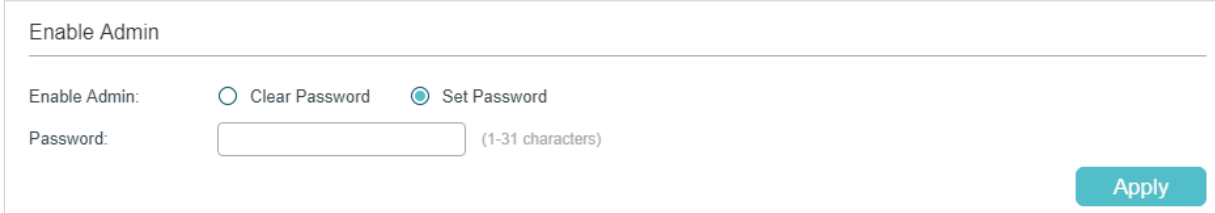

Enable Admin

Enable Admin:  Clear Password  Set Password

Password:  (1-31 characters)

Apply

There are two options: **Clear Password** and **Set Password**. You can choose whether the local Enable password is required when the guests try to get administrative privileges. Click **Apply**.

*Tips:* The logged-in guests can enter the local Enable password on this page to get administrative privileges.

### ■ On the Server

The accounts created by the RADIUS/TACACS+ server can only view the configurations and some network information without the Enable password.

Some configuration principles on the server are as follows:

- For Login authentication configuration, more than one login account can be created on the server. Besides, both the user name and password can be customized.
- For Enable password configuration:

On RADIUS server, the user name should be set as **\$enable\$**, and the Enable password is customizable. All the users trying to get administrative privileges share this Enable password.

On TACACS+ server, configure the value of "enable 15" as the Enable password in the configuration file. All the users trying to get administrative privileges share this Enable password.

## 2.2 Using the CLI

### 2.2.1 Adding Servers

You can add one or more RADIUS/TACACS+ servers on the switch for authentication. If multiple servers are added, the server with the highest priority authenticates the users

trying to access the switch, and the others act as backup servers in case the first one breaks down.

### ■ Adding RADIUS Server

Follow these steps to add RADIUS server on the switch:

|        |   |
|--------|---|
| Step 1 | <b>configure</b><br>Enter global configuration mode.  |
| Step 2 | <p><b>radius-server host ip-address [ auth-port port-id ] [ acct-port port-id ] [ timeout time ] [ retransmit number ] [ nas-id nas-id ] key { [ 0 ] string   7 encrypted-string }</b></p> <p>Add the RADIUS server and configure the related parameters as needed.</p> <p><b>host ip-address:</b> Enter the IP address of the server running the RADIUS protocol.</p> <p><b>auth-port port-id:</b> Specify the UDP destination port on the RADIUS server for authentication requests. The default setting is 1812.</p> <p><b>acct-port port-id:</b> Specify the UDP destination port on the RADIUS server for accounting requests. The default setting is 1813. Usually, it is used in the 802.1X feature.</p> <p><b>timeout time:</b> Specify the time interval that the switch waits for the server to reply before resending. The valid values are from 1 to 9 seconds and the default setting is 5 seconds.</p> <p><b>retransmit number:</b> Specify the number of times a request is resent to the server if the server does not respond. The valid values are from 1 to 3 and the default setting is 2.</p> <p><b>nas-id nas-id:</b> Specify the name of the NAS (Network Access Server) to be contained in RADIUS packets for identification. It ranges from 1 to 31 characters. The default value is the MAC address of the switch. Generally, the NAS indicates the switch itself.</p> <p><b>key { [ 0 ] string   7 encrypted-string }:</b> Specify the shared key. 0 and 7 represent the encryption type. 0 indicates that an unencrypted key will follow. 7 indicates that a symmetric encrypted key with a fixed length will follow. By default, the encryption type is 0. <i>string</i> is the shared key for the switch and the server, which contains 32 characters at most. <i>encrypted-string</i> is a symmetric encrypted key with a fixed length, which you can copy from the configuration file of another switch. The key or encrypted-key you configure here will be displayed in the encrypted form.</p> |
| Step 3 | <b>show radius-server</b><br>Verify the configuration of RADIUS server.   |
| Step 4 | <b>end</b><br>Return to privileged EXEC mode.   |
| Step 5 | <b>copy running-config startup-config</b><br>Save the settings in the configuration file.   |

The following example shows how to add a RADIUS server on the switch. Set the IP address of the server as 192.168.0.10, the authentication port as 1812, the shared key as 123456, the timeout as 8 seconds and the retransmit number as 3.

### Switch#configure

```
Switch(config)#radius-server host 192.168.0.10 auth-port 1812 timeout 8 retransmit 3
key 123456
```

```
Switch(config)#show radius-server
```

| Server Ip    | Auth Port | Acct Port | Timeout | Retransmit | NAS Identifier | Shared key |
|--------------|-----------|-----------|---------|------------|----------------|------------|
| 192.168.0.10 | 1812      | 1813      | 5       | 2          | 000AEB132397   | 123456     |

```
Switch(config)#end
```

```
Switch#copy running-config startup-config
```

### ■ Adding TACACS+ Server

Follow these steps to add TACACS+ server on the switch:

|        |   |
|--------|---|
| Step 1 | <p><b>configure</b></p> <p>Enter global configuration mode.</p>   |
| Step 2 | <p><b>tacacs-server host</b> <i>ip-address</i> [<b>port</b> <i>port-id</i>] [<b>timeout</b> <i>time</i>] [<b>key</b> {[ 0 ] <i>string</i>   7 <i>encrypted-string</i> ]}</p> <p>Add the RADIUS server and configure the related parameters as needed.</p> <p><b>host</b> <i>ip-address</i>: Enter the IP address of the server running the TACACS+ protocol.</p> <p><b>port</b> <i>port-id</i>: Specify the TCP destination port on the TACACS+ server for authentication requests. The default setting is 49.</p> <p><b>timeout</b> <i>time</i>: Specify the time interval that the switch waits for the server to reply before resending. The valid values are from 1 to 9 seconds and the default setting is 5 seconds.</p> <p><b>key</b> {[ 0 ] <i>string</i>   7 <i>encrypted-string</i> }: Specify the shared key. 0 and 7 represent the encryption type. 0 indicates that an unencrypted key will follow. 7 indicates that a symmetric encrypted key with a fixed length will follow. By default, the encryption type is 0. <i>string</i> is the shared key for the switch and the server, which contains 32 characters at most. <i>encrypted-string</i> is a symmetric encrypted key with a fixed length, which you can copy from the configuration file of another switch. The key or encrypted-key you configured here will be displayed in the encrypted form.</p> |
| Step 3 | <p><b>show tacacs-server</b></p> <p>Verify the configuration of TACACS+ server.</p>   |
| Step 4 | <p><b>end</b></p> <p>Return to privileged EXEC mode.</p>  |
| Step 5 | <p><b>copy running-config startup-config</b></p> <p>Save the settings in the configuration file.</p>  |

The following example shows how to add a TACACS+ server on the switch. Set the IP address of the server as 192.168.0.20, the authentication port as 49, the shared key as 123456, and the timeout as 8 seconds.

```
Switch#configure
```

```
Switch(config)#tacacs-server host 192.168.0.20 auth-port 49 timeout 8 key 123456
```

```
Switch(config)#show tacacs-server
```

```
Server Ip      Port  Timeout  Shared key
192.168.0.20  49    8        123456
```

```
Switch(config)#end
```

```
Switch#copy running-config startup-config
```

## 2.2.2 Configuring Server Groups

The switch has two built-in server groups, one for RADIUS and the other for TACACS+. The servers running the same protocol are automatically added to the default server group. You can add new server groups as needed.

The two default server groups cannot be deleted or edited. Follow these steps to add a server group:

|        |  |
|--------|--|
| Step 1 | <b>configure</b><br>Enter global configuration mode.   |
| Step 2 | <b>aaa group { radius   tacacs } group-name</b><br>Create a server group.<br><br><i>radius   tacacs</i> : Specify the group type.<br><br><i>group-name</i> : Specify a name for the group. |
| Step 3 | <b>server ip-address</b><br>Add the existing servers to the server group.<br><br><i>ip-address</i> : Specify IP address of the server to be added to the group.                            |
| Step 4 | <b>show aaa group [ group-name ]</b><br>Verify the configuration of server group.  |
| Step 5 | <b>end</b><br>Return to privileged EXEC mode.  |
| Step 6 | <b>copy running-config startup-config</b><br>Save the settings in the configuration file.  |

The following example shows how to create a RADIUS server group named RADIUS1 and add the existing two RADIUS servers whose IP address is 192.168.0.10 and 192.168.0.20 to the group.

```
Switch#configure
```

```

Switch(config)#aaa group radius RADIUS1

Switch(aaa-group)#server 192.168.0.10

Switch(aaa-group)#server 192.168.0.20

Switch(aaa-group)#show aaa group RADIUS1

192.168.0.10

192.168.0.20

Switch(aaa-group)#end

Switch#copy running-config startup-config

```

## 2.2.3 Configuring the Method List

A method list describes the authentication methods and their sequence to authenticate the users. The switch supports Login Method List for users of all types to gain access to the switch, and Enable Method List for guests to get administrative privileges.

Follow these steps to configure the method list:

|        |   |
|--------|---|
| Step 1 | <p><b>configure</b></p> <p>Enter global configuration mode.</p>   |
| Step 2 | <p><b>aaa authentication login { method-list } { method1 } [ method2 ] [ method3 ] [ method4 ]</b></p> <p>Configure a login method list.</p> <p><i>method-list</i>: Specify a name for the method list.</p> <p><i>method1/method2/method3/method4</i>: Specify the authentication methods in order. The first method authenticates a user first, the second method is tried if the previous method does not respond, and so on. The default methods include radius, tacacs, local and none. None means no authentication is used for login.</p> |
| Step 3 | <p><b>aaa authentication enable { method-list } { method1 } [ method2 ] [ method3 ] [ method4 ]</b></p> <p>Configure an Enable password method list.</p> <p><i>method-list</i>: Specify a name for the method list.</p> <p><i>method1/method2/method3/method4</i>: Specify the authentication methods in order. The default methods include radius, tacacs, local and none. None means no authentication is used for getting administrative privileges.</p>   |
| Step 4 | <p><b>show aaa authentication [ login   enable ]</b></p> <p>Verify the configuration method list.</p>   |
| Step 5 | <p><b>end</b></p> <p>Return to privileged EXEC mode.</p>  |

---

Step 6      **copy running-config startup-config**  
 Save the settings in the configuration file.

---

The following example shows how to create a Login method list named Login1, and configure the method 1 as the default radius server group and the method 2 as local.

**Switch#configure**

**Switch(config)##aaa authentication login Login1 radius local**

**Switch(config)#show aaa authentication login**

| Methodlist | pri1   | pri2  | pri3 | pri4 |
|------------|--------|-------|------|------|
| default    | local  | --    | --   | --   |
| Login1     | radius | local | --   | --   |

**Switch(config)#end**

**Switch#copy running-config startup-config**

The following example shows how to create an Enable method list named Enable1, and configure the method 1 as the default radius server group and the method 2 as local.

**Switch#configure**

**Switch(config)##aaa authentication enable Enable1 radius local**

**Switch(config)#show aaa authentication enable**

| Methodlist | pri1   | pri2  | pri3 | pri4 |
|------------|--------|-------|------|------|
| default    | local  | --    | --   | --   |
| Enable1    | radius | local | --   | --   |

**Switch(config)#end**

**Switch#copy running-config startup-config**

## 2.2.4 Configuring the AAA Application List

You can configure authentication method lists on the following access applications: Telnet, SSH and HTTP.

## ■ Telnet

Follow these steps to apply the Login and Enable method lists for the application Telnet:

|        |  |  |
|--------|--|--|
| Step 1 | <b>configure</b>                             | Enter global configuration mode.   |
| Step 2 | <b>line telnet</b>                           | Enter line configuration mode.   |
| Step 3 | <b>login authentication { method-list }</b>  | Apply the Login method list for the application Telnet.<br><br><i>method-list</i> : Specify the name of the Login method list.   |
| Step 4 | <b>enable authentication { method-list }</b> | Apply the Enable method list for the application Telnet.<br><br><i>method-list</i> : Specify the name of the Enable method list. |
| Step 5 | <b>show aaa global</b>                       | Verify the configuration of application list.  |
| Step 6 | <b>end</b>                                   | Return to privileged EXEC mode.  |
| Step 7 | <b>copy running-config startup-config</b>    | Save the settings in the configuration file.   |

The following example shows how to apply the existing Login method list named Login1 and Enable method list named Enable1 for the application Telnet.

**Switch#configure**

**Switch(config)#line telnet**

**Switch(config-line)#login authentication Login1**

**Switch(config-line)#enable authentication Enable1**

**Switch(config-line)#show aaa global**

| Module | Login List | Enable List |
|--------|------------|-------------|
| Telnet | Login1     | Enable1     |
| Ssh    | default    | default     |
| Http   | default    | default     |

**Switch(config-line)#end**

**Switch#copy running-config startup-config**



## ■ SSH

Follow these steps to apply the Login and Enable method lists for the application SSH:

|        |  |   |
|--------|--|---|
| Step 1 | <b>configure</b>                             | Enter global configuration mode.  |
| Step 2 | <b>line ssh</b>                              | Enter line configuration mode.  |
| Step 3 | <b>login authentication { method-list }</b>  | Apply the Login method list for the application SSH.<br><br><i>method-list</i> : Specify the name of the Login method list.   |
| Step 4 | <b>enable authentication { method-list }</b> | Apply the Enable method list for the application SSH.<br><br><i>method-list</i> : Specify the name of the Enable method list. |
| Step 5 | <b>show aaa global</b>                       | Verify the configuration of application list.   |
| Step 6 | <b>end</b>                                   | Return to privileged EXEC mode.   |
| Step 7 | <b>copy running-config startup-config</b>    | Save the settings in the configuration file.  |

The following example shows how to apply the existing Login method list named Login1 and Enable method list named Enable1 for the application SSH.

**Switch#configure**

**Switch(config)#line ssh**

**Switch(config-line)#login authentication Login1**

**Switch(config-line)#enable authentication Enable1**

**Switch(config-line)#show aaa global**

| Module | Login List | Enable List |
|--------|------------|-------------|
| Telnet | default    | default     |
| Ssh    | Login1     | Enable1     |
| Http   | default    | default     |

**Switch(config-line)#end**

**Switch#copy running-config startup-config**

## ■ HTTP

Follow these steps to apply the Login and Enable method lists for the application HTTP:

|        |  |  |
|--------|--|--|
| Step 1 | <b>configure</b>                                     | Enter global configuration mode.   |
| Step 2 | <b>ip http login authentication { method-list }</b>  | Apply the Login method list for the application HTTP.<br><i>method-list</i> : Specify the name of the Login method list.   |
| Step 3 | <b>ip http enable authentication { method-list }</b> | Apply the Enable method list for the application HTTP.<br><i>method-list</i> : Specify the name of the Enable method list. |
| Step 4 | <b>show aaa global</b>                               | Verify the configuration of application list.  |
| Step 5 | <b>end</b>   | Return to privileged EXEC mode.  |
| Step 6 | <b>copy running-config startup-config</b>            | Save the settings in the configuration file.   |

The following example shows how to apply the existing Login method list named Login1 and Enable method list named Enable1 for the application HTTP:

**Switch#configure**

**Switch(config)#ip http login authentication Login1**

**Switch(config)#ip http enable authentication Enable1**

**Switch(config)#show aaa global**

| Module | Login List | Enable List |
|--------|------------|-------------|
| Telnet | default    | default     |
| Ssh    | default    | default     |
| Http   | Login1     | Enable1     |

**Switch(config)#end**

**Switch#copy running-config startup-config**

## 2.2.5 Configuring Login Account and Enable Password

The login account and Enable password can be configured locally on the switch or centrally on the RADIUS/TACACS+ server(s).

## ■ On the Switch

The local username and password for login can be configured in the User Management feature. For details, refer to [Managing System](#).

To configure the local Enable password for getting administrative privileges, follow these steps:

---

|        |   |
|--------|---|
| Step 1 | <b>configure</b><br>Enter global configuration mode.  |
| Step 2 | <b>enable admin password { [0] password   7 encrypted-password }</b><br>Set the Enable password. This command uses symmetric encryption.<br><br>0 and 7 represent the encryption type. 0 indicates that an unencrypted key will follow. 7 indicates that a symmetric encrypted key with a fixed length will follow. By default, the encryption type is 0.<br><br><i>password</i> is a string with 31 characters at most, which can contain only English letters (case-sensitive), digits and 17 kinds of special characters. The special characters are <code>!\$%()*,-./[]_{}.</code><br><br><i>encrypted-password</i> is a symmetric encrypted key with a fixed length, which you can copy from the configuration file of another switch. The key or encrypted-key you configured here will be displayed in the encrypted form.<br><br><b>enable admin secret { [0] password   5 encrypted-password }</b><br>Set the Enable password. This command uses MD5 encryption.<br><br>0 and 5 are the encryption type. 0 indicates that an unencrypted key will follow. 5 indicates that an MD5 encrypted password with fixed length will follow. By default, the encryption type is 0.<br><br><i>password</i> is a string with 31 characters at most, which can contain only English letters (case-sensitive), digits and 17 kinds of special characters. The special characters are <code>!\$%()*,-./[]_{}.</code><br><br><i>encrypted-password</i> is an MD5 encrypted password with fixed length, which you can copy from another switch's configuration file. |
| Step 3 | <b>end</b><br>Return to privileged EXEC mode.   |
| Step 4 | <b>copy running-config startup-config</b><br>Save the settings in the configuration file.   |

---

## ■ On the Server

The accounts created by the RADIUS/TACACS+ server can only view the configurations and some network information without the Enable password.

Some configuration principles on the server are as follows:

- For Login authentication configuration, more than one login account can be created on the server. Besides, both the user name and password can be customized.

- For Enable password configuration:

On RADIUS server, the user name should be set as **\$enable\$**, and the Enable password is customizable. All the users trying to get administrative privileges share this Enable password.

On TACACS+ server, configure the value of "enable 15" as the Enable password in the configuration file. All the users trying to get administrative privileges share this Enable password.

*Tips:* The logged-in guests can get administrative privileges by using the command **enable-admin** and providing the Enable password.

# 3 Configuration Example

## 3.1 Network Requirements

As shown below, the switch needs to be managed remotely via Telnet. In addition, the senior administrator of the company wants to create an account for the less senior administrators, who can only view the configurations and some network information without the Enable password provided.

Two RADIUS servers are deployed in the network to provide a safer authenticate method for the administrators trying to log in or get administrative privileges. If RADIUS Server 1 breaks down and doesn't respond to the authentication request, RADIUS Server 2 will work, so as to ensure the stability of the authentication system.

Figure 3-1 Network Topology

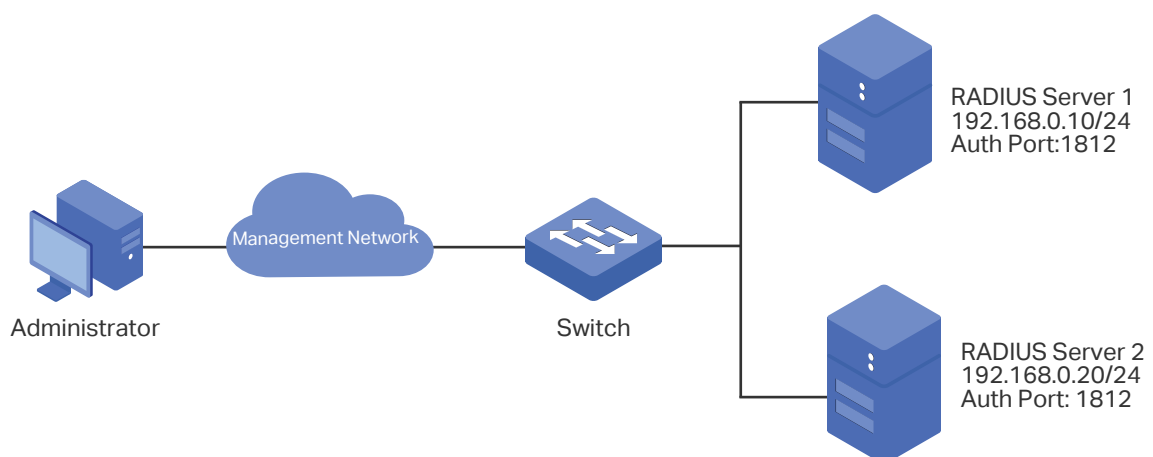

## 3.2 Configuration Scheme

To implement this requirement, the senior administrator can create the login account and the Enable password on the two RADIUS servers, and configure the AAA feature on the switch. The IP addresses of the two RADIUS servers are 192.168.0.10/24 and 192.168.0.20/24; the authentication port number is 1812; the shared key is 123456.

The overview of configuration on the switch is as follows:

- 1) Add the two RADIUS servers on the switch.
- 2) Create a new RADIUS server group and add the two servers to the group. Make sure that RADIUS Server 1 is the first server for authentication.
- 3) Configure the method list.
- 4) Configure the AAA application list.

Demonstrated with T1500-28PCT, the following sections provide configuration procedure in two ways: using the GUI and using the CLI.

### 3.3 Using the GUI

- 1) Choose the menu **SECURITY > AAA > RADIUS Config** and click **+ Add** to load the following page. Configure the Server IP as 192.168.0.10, the Shared Key as 123456, the Authentication Port as 1812, and keep the other parameters as default. Click **Create** to add RADIUS Server 1 on the switch.

Figure 3-2 Add RADIUS Server 1

**RADIUS Server**

|                      |   |   |
|----------------------|---|---|
| Server IP:           | <input type="text" value="192.168.0.10"/> | (Format:192.168.0.1)  |
| Shared Key:          | <input type="text" value="123456"/>       | 1-32 characters. Only numbers, letters and the following symbols are allowed: - . / : @ _ . |
| Authentication Port: | <input type="text" value="1812"/>         | (1-65535)   |
| Accounting Port:     | <input type="text" value="1813"/>         | (1-65535)   |
| Retransmit:          | <input type="text" value="2"/>            | (1-3)   |
| Timeout:             | <input type="text" value="5"/>            | seconds (1-9)   |
| NAS Identifier:      | <input type="text"/>                      | (Optional)  |

- 2) On the same page, click **+ Add** to load the following page. Configure the Server IP as 192.168.0.20, the Shared Key as 123456, the Auth Port as 1812, and keep the other parameters as default. Click **Create** to add RADIUS Server 2 on the switch

Figure 3-3 Add RADIUS Server 2

**RADIUS Server**

|                      |   |   |
|----------------------|---|---|
| Server IP:           | <input type="text" value="192.168.0.20"/> | (Format:192.168.0.1)  |
| Shared Key:          | <input type="text" value="123456"/>       | 1-32 characters. Only numbers, letters and the following symbols are allowed: - . / : @ _ . |
| Authentication Port: | <input type="text" value="1812"/>         | (1-65535)   |
| Accounting Port:     | <input type="text" value="1813"/>         | (1-65535)   |
| Retransmit:          | <input type="text" value="2"/>            | (1-3)   |
| Timeout:             | <input type="text" value="5"/>            | seconds (1-9)   |
| NAS Identifier:      | <input type="text"/>                      | (Optional)  |

- 3) Choose the menu **SECURITY > AAA > Server Group** to load the following page. Click **+ Add**. Specify the group name as RADIUS1 and the server type as RADIUS. Select 192.168.0.10 and 192.168.0.20 to from the drop-down list. Click **Create** to create the server group.

Figure 3-4 Create Server Group

- 4) Choose the menu **SECURITY > AAA > Method List** and click **+ Add** in the **Authentication Login Method List** section. Specify the Method List Name as MethodLogin and select the Pri1 as RADIUS1. Click **Create** to set the method list for the Login authentication.

Figure 3-5 Configure Login Method List

- 5) On the same page, click **+ Add** in the **Authentication Enable Method List** section. Specify the Method List Name as MethodEnable and select the Pri1 as RADIUS1. Click **Create** to set the method list for the Enable password authentication.

Figure 3-6 Configure Enable Method List

**Authentication Enable Method**

Method List Name:  (1-15 characters)

Pri1:  ▼

Pri2:  ▼

Pri3:  ▼

Pri4:  ▼

- 6) Choose the menu **SECURITY > AAA > Global Config** to load the following page. In the **AAA Application List** section, select telnet and configure the Login List as Method-Login and Enable List as Method-Enable. Then click **Apply**.

Figure 3-7 Configure AAA Application List

**AAA Application List**

| <input type="checkbox"/>            | Index | Module | Login List    | Enable List    |
|-------------------------------------|-------|--------|---------------|----------------|
| <input checked="" type="checkbox"/> | 1     | telnet | MethodLogin ▼ | MethodEnable ▼ |
| <input type="checkbox"/>            | 2     | ssh    | default       | default        |
| <input type="checkbox"/>            | 3     | http   | default       | default        |

Total: 3      1 entry selected.     

- 7) Click  Save to save the settings.

### 3.4 Using the CLI

- 1) Add RADIUS Server 1 and RADIUS Server 2 on the switch.

```
Switch(config)#radius-server host 192.168.0.10 auth-port 1812 key 123456
```

```
Switch(config)#radius-server host 192.168.0.20 auth-port 1812 key 123456
```

- 2) Create a new server group named RADIUS1 and add the two RADIUS servers to the server group.

```
Switch(config)#aaa group radius RADIUS1
```

```
Switch(aaa-group)#server 192.168.0.10
```

```
Switch(aaa-group)#server 192.168.0.20
```

```
Switch(aaa-group)#exit
```



- 3) Create two method lists: Method-Login and Method-Enable, and configure the server group RADIUS1 as the authentication method for the two method lists.

```
Switch(config)#aaa authentication login Method-Login RADIUS1
```

```
Switch(config)#aaa authentication enable Method-Enable RADIUS1
```

- 4) Configure Method-Login and Method-Enable as the authentication method for the Telnet application.

```
Switch(config)#line telnet
```

```
Switch(config-line)#login authentication Method-Login
```

```
Switch(config-line)#enable authentication Method-Enable
```

```
Switch(config-line)#end
```

```
Switch#copy running-config startup-config
```

### Verify the Configuration

Verify the configuration of the RADIUS servers:

```
Switch#show radius-server
```

| Server Ip    | Auth Port | Acct Port | Timeout | Retransmit | NAS Identifier | Shared key |
|--------------|-----------|-----------|---------|------------|----------------|------------|
| 192.168.0.10 | 1812      | 1813      | 5       | 2          | 000AEB132397   | 123456     |
| 192.168.0.20 | 1812      | 1813      | 5       | 2          | 000AEB132397   | 123456     |

Verify the configuration of server group RADIUS1:

```
Switch#show aaa group RADIUS1
```

```
192.168.0.10
```

```
192.168.0.20
```

Verify the configuration of the method lists:

```
Switch#show aaa authentication
```

```
Authentication Login Methodlist:
```

| Methodlist   | pri1    | pri2 | pri3 | pri4 |
|--------------|---------|------|------|------|
| default      | local   | --   | --   | --   |
| Method-Login | RADIUS1 | --   | --   | --   |

```
Authentication Enable Methodlist:
```

| Methodlist | pri1 | pri2 | pri3 | pri4 |
|------------|------|------|------|------|
|            |      |      |      |      |

```
default          none      --      --      --
Method-Enable   RADIUS1  --      --      --
...
```

Verify the status of the AAA feature and the configuration of the AAA application list:

```
Switch#show aaa global
```

| Module | Login List   | Enable List   |
|--------|--------------|---------------|
| Telnet | Method-Login | Method-Enable |
| SSH    | default      | default       |
| Http   | default      | default       |

# 4 Appendix: Default Parameters

Default settings of AAA are listed in the following tables.

Table 4-1 AAA

| Parameter   | Default Setting                   |
|---|-----------------------------------|
| Global Config   |                                   |
| AAA Feature   | Enabled                           |
| RADIUS Config   |                                   |
| Server IP   | None                              |
| Shared Key  | None                              |
| Auth Port   | 1812                              |
| Acct Port   | 1813                              |
| Retransmit  | 2                                 |
| Timeout   | 5 seconds                         |
| NAS Identifier  | The MAC address of the switch.    |
| TACACS+ Config  |                                   |
| Server IP   | None                              |
| Timeout   | 5 seconds                         |
| Shared Key  | None                              |
| Port  | 49                                |
| Server Group: There are two default server groups: radius and tacacs. |                                   |
| Method List   |                                   |
| Authentication Login Method List                                      | List name: default<br>Pri1: local |
| Authentication Enable Method List                                     | List name: default<br>Pri1: none  |

| Parameter            | Default Setting      |
|----------------------|----------------------|
| AAA Application List |                      |
| telnet               | Login List: default  |
|                      | Enable List: default |
| ssh                  | Login List: default  |
|                      | Enable List: default |
| http                 | Login List: default  |
|                      | Enable List: default |

# Part 17

## Configuring 802.1x

### CHAPTERS

1. Overview
2. 802.1x Configuration
3. Configuration Example
4. Appendix: Default Parameters

# 1 Overview

802.1x protocol is a protocol for port-based Network Access Control. It is used to authenticate and control access from devices connected to the ports. If the device connected to the port is authenticated by the authentication server successfully, its request to access the LAN will be accepted; if not, its request will be denied.

802.1x authentication uses client-server model which contains three device roles: client/supplicant, authenticator and authentication server. This is described in the figure below:

Figure 1-1 802.1x Authentication Model

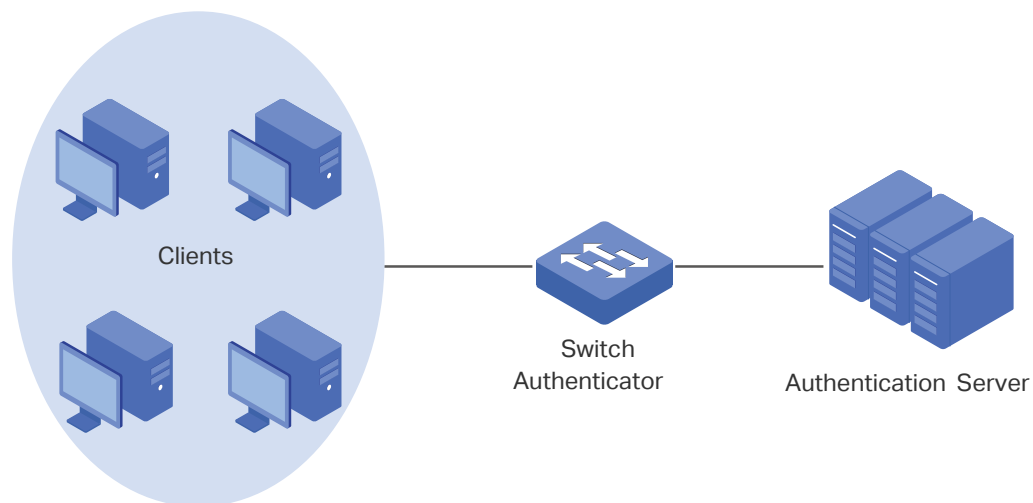

## ■ Client

A client, usually a computer, is connected to the authenticator via a physical port. We recommend that you install TP-Link 802.1x authentication client software on the client hosts, enabling them to request 802.1x authentication to access the LAN.

## ■ Authenticator

An authenticator is usually a network device that supports 802.1x protocol. As the above figure shows, the switch is an authenticator.

The authenticator acts as an intermediate proxy between the client and the authentication server. The authenticator requests user information from the client and sends it to the authentication server; also, the authenticator obtains responses from the authentication server and send them to the client. The authenticator allows authenticated clients to access the LAN through the connected ports but denies the unauthenticated clients.

## ■ Authentication Server

The authentication server is usually the host running the RADIUS server program. It stores information of clients, confirms whether a client is legal and informs the authenticator whether a client is authenticated.

# 2 802.1x Configuration

To complete the 802.1x configuration, follow these steps:

- 1) Configure the RADIUS server.
- 2) Configure 802.1x globally.
- 3) Configure 802.1x on ports.

In addition, you can view the authenticator state.

## Configuration Guidelines

802.1x authentication and Port Security cannot be enabled at the same time. Before enabling 802.1x authentication, make sure that Port Security is disabled.

## 2.1 Using the GUI

### 2.1.1 Configuring the RADIUS Server

Configure the parameters of RADIUS sever and configure the RADIUS server group.

#### ■ Adding the RADIUS Server

Choose the menu **SECURITY > AAA > RADIUS Config** and click  **Add** to load the following page.

Figure 2-1 Adding RADIUS Server

RADIUS Server

|                      |                                   |   |
|----------------------|-----------------------------------|---|
| Server IP:           | <input type="text"/>              | (Format: 192.168.0.1)   |
| Shared Key:          | <input type="text"/>              | 1-32 characters. Only numbers, letters and the following symbols are allowed: - . / : @ _ . |
| Authentication Port: | <input type="text" value="1812"/> | (1-65535)   |
| Accounting Port:     | <input type="text" value="1813"/> | (1-65535)   |
| Retransmit:          | <input type="text" value="2"/>    | (1-3)   |
| Timeout:             | <input type="text" value="5"/>    | seconds (1-9)   |
| NAS Identifier:      | <input type="text"/>              | (Optional)  |

Follow these steps to add a RADIUS server:





## 1) Configure the parameters of the RADIUS server.

|                     |  |
|---------------------|--|
| Server IP           | Enter the IP address of the server running the RADIUS secure protocol.   |
| Shared Key          | Enter the shared key between the RADIUS server and the switch. The RADIUS server and the switch use the key string to encrypt passwords and exchange responses.  |
| Authentication Port | Specify the UDP destination port on the RADIUS server for authentication requests. The default setting is 1812.  |
| Accounting Port     | Specify the UDP destination port on the RADIUS server for accounting requests. The default setting is 1813.  |
| Retransmit          | Specify the number of times a request is resent to the server if the server does not respond. The default setting is 2.  |
| Timeout             | Specify the time interval that the switch waits for the server to reply before resending. The default setting is 5 seconds.  |
| NAS Identifier      | Specify the name of the NAS (Network Access Server) to be contained in RADIUS packets for identification. It ranges from 1 to 31 characters. The default value is the MAC address of the switch. Generally, the NAS indicates the switch itself. |



2) Click **Apply**.■ **Configuring the RADIUS Server Group**

Choose the menu **SECURITY > AAA > Server Group** to load the following page.

Figure 2-2 Adding a Server Group

| Server Group List        |    |              |             |           |   |
|--------------------------|----|--------------|-------------|-----------|---|
| <input type="checkbox"/> | ID | Server Group | Server Type | Server IP | Operation   |
| <input type="checkbox"/> | 1  | radius       | RADIUS      |           |   |
| <input type="checkbox"/> | 2  | tacacs       | TACACS+     |           |   |
| Total: 2                 |    |              |             |           |   |

Follow these steps to add the RADIUS server to a server group:

- 1) Click  to edit the default **radius** server group or click  **Add** to add a new server group.

If you click , the following window will pop up. Select a RADIUS server and click **Save**.



Figure 2-3 Editing Server Group

If you click **+** **Add** , the following window will pop up. Specify a name for the server group, select the server type as RADIUS and select the IP address of the RADIUS server. Click **Save**.

Figure 2-4 Adding Server Group

### ■ Configuring the Dot1x List

Choose the menu **SECURITY > AAA > Dot1x List** to load the following page.

Figure 2-5 Configuring the Dot1x List

Follow these steps to configure RADIUS server groups for 802.1x authentication and accounting:

- 1) In the **Authentication Dot1x Method** section, select an existing RADIUS server group for authentication from the Pri1 drop-down list and click **Apply**.

- 2) In the **Accounting Dot1x Method** section, select an existing RADIUS server group for accounting from the Pri1 drop-down list and click **Apply**.

## 2.1.2 Configuring 802.1x Globally

Choose the menu **SECURITY > 802.1x > Global Config** to load the following page.

Figure 2-6 Global Config

Follow these steps to configure 802.1x global parameters:

- 1) In the **Global Config** section, configure the following parameters.

|                      |  |
|----------------------|--|
| <b>802.1x</b>        | Enable or disable 802.1x globally.   |
| <b>Auth Protocol</b> | Select the 802.1x authentication protocol.<br><br><b>PAP:</b> The 802.1x authentication system uses EAP packets to exchange information between the switch and the client. The transmission of EAP (Extensible Authentication Protocol) packets is terminated at the switch and the EAP packets are converted to other protocol (such as RADIUS) packets, and transmitted to the authentication server.<br><br><b>EAP:</b> The 802.1x authentication system uses EAP packets to exchange information between the switch and the client. The EAP packets with authentication data are encapsulated in the advanced protocol (such as RADIUS) packets, and transmitted to the authentication server. |
| <b>Accounting</b>    | Enable or disable 802.1x accounting feature.   |
| <b>Handshake</b>     | Enable or disable the Handshake feature. The Handshake feature is used to detect the connection status between the TP-Link 802.1x Client and the switch. Please disable Handshake feature if you are using other client softwares instead of TP-Link 802.1x Client.  |

**VLAN Assignment**

Enable or disable the 802.1x VLAN assignment feature. 802.1x VLAN assignment is a technology allowing the RADIUS server to send the VLAN assignment to the port when the port is authenticated.

If the assigned VLAN does not exist on the switch, the switch will create the related VLAN automatically, add the authenticated port to the VLAN and change the PVID based on the assigned VLAN.

If the assigned VLAN exists on the switch, the switch will directly add the authenticated port to the related VLAN and change the PVID instead of creating a new VLAN.

If no VLAN is supplied by the RADIUS server or if 802.1x authentication is disabled, the port will be in its original VLAN after successful authentication.

2) Click **Apply**.

### 2.1.3 Configuring 802.1x on Ports

Choose the menu **SECURITY > 802.1x > Port Config** to load the following page.

Figure 2-7 Port Config

| <input type="checkbox"/> | Port   | Status  | MAB     | Guest VLAN (0-4094) | Port Control | Port Method | Maximum Request (1-9) | Quiet Period (0-999) | Supplicant Timeout (1-60) |
|--------------------------|--------|---------|---------|---------------------|--------------|-------------|-----------------------|----------------------|---------------------------|
| <input type="checkbox"/> | 1/0/1  | Disable | Disable | 0                   | Auto         | MAC Based   | 3                     | 10                   | 30                        |
| <input type="checkbox"/> | 1/0/2  | Disable | Disable | 0                   | Auto         | MAC Based   | 3                     | 10                   | 30                        |
| <input type="checkbox"/> | 1/0/3  | Disable | Disable | 0                   | Auto         | MAC Based   | 3                     | 10                   | 30                        |
| <input type="checkbox"/> | 1/0/4  | Disable | Disable | 0                   | Auto         | MAC Based   | 3                     | 10                   | 30                        |
| <input type="checkbox"/> | 1/0/5  | Disable | Disable | 0                   | Auto         | MAC Based   | 3                     | 10                   | 30                        |
| <input type="checkbox"/> | 1/0/6  | Disable | Disable | 0                   | Auto         | MAC Based   | 3                     | 10                   | 30                        |
| <input type="checkbox"/> | 1/0/7  | Disable | Disable | 0                   | Auto         | MAC Based   | 3                     | 10                   | 30                        |
| <input type="checkbox"/> | 1/0/8  | Disable | Disable | 0                   | Auto         | MAC Based   | 3                     | 10                   | 30                        |
| <input type="checkbox"/> | 1/0/9  | Disable | Disable | 0                   | Auto         | MAC Based   | 3                     | 10                   | 30                        |
| <input type="checkbox"/> | 1/0/10 | Disable | Disable | 0                   | Auto         | MAC Based   | 3                     | 10                   | 30                        |

Total: 28

Follow these steps to configure 802.1x authentication on the desired port:

1) Select one or more ports and configure the following parameters:

**Status** Enable 802.1x authentication on the port.

|                           |  |
|---------------------------|--|
| MAB                       | <p>Select whether to enable the MAB (MAC-Based Authentication Bypass) feature for the port.</p> <p>With MAB feature enabled, the switch automatically sends the authentication server a RADIUS access request frame with the client's MAC address as the username and password. It is also necessary to configure the RADIUS server with the client's information for authentication. You can enable this feature on IEEE 802.1x ports connected to devices without 802.1x capability. For example, most printers, IP phones and fax machines do not have 802.1x capability.</p> <p><b>Note:</b> MAB cannot work if Guest VLAN is enabled.</p> |
| Guest VLAN                | <p>Specify a Guest VLAN ID. 0 means that Guest VLAN is disabled. The configured VLAN must be an existing 802.1Q VLAN.</p> <p>With Guest VLAN enabled, a port can access resources in the guest VLAN even though the port is not yet authenticated; if guest VLAN is disabled and the port is not authenticated, the port cannot visit any resource in the LAN.</p>   |
| Port Control              | <p>Select the control mode for the port. By default, it is Auto.</p> <p><b>Auto:</b> If this option is selected, the port can access the network only when it is authenticated.</p> <p><b>Force-Authorized:</b> If this option is selected, the port can access the network without authentication.</p> <p><b>Force-Unauthenticated:</b> If this option is selected, the port can never be authenticated.</p>  |
| Port Method               | <p>Select the port method. By default, it is MAC Based.</p> <p><b>MAC Based:</b> All clients connected to the port need to be authenticated.</p> <p><b>Port Based:</b> If a client connected to the port is authenticated, other clients can access the LAN without authentication.</p>  |
| Maximum Request (1-9)     | <p>Specify the maximum number of attempts to send the authentication packet. It ranges from 1 to 9 times and the default is 3 times.</p>   |
| Quiet Period (1-999)      | <p>Specify the Quiet Period. It ranges from 1 to 999 seconds and the default time is 10 seconds.</p> <p>The quiet period starts after the authentication fails. During the quiet period, the switch does not process authentication requests from the same client.</p>   |
| Supplicant Timeout (1-60) | <p>Specify the maximum time which the switch waits for a response from the client. It ranges from 1 to 60 seconds and the default time is 30 seconds.</p> <p>If the switch does not receive any reply from the client within the specified time, it will resend the request.</p>   |
| Authorized                | <p>Displays whether the port is authorized or not.</p>   |
| LAG                       | <p>Displays the LAG the port belongs to.</p>   |

2) Click **Apply**.

 **Note:**

If a port is in an LAG, its 802.1x authentication function cannot be enabled. Also, a port with 802.1x authentication enabled cannot be added to any LAG.

## 2.1.4 View the Authenticator State

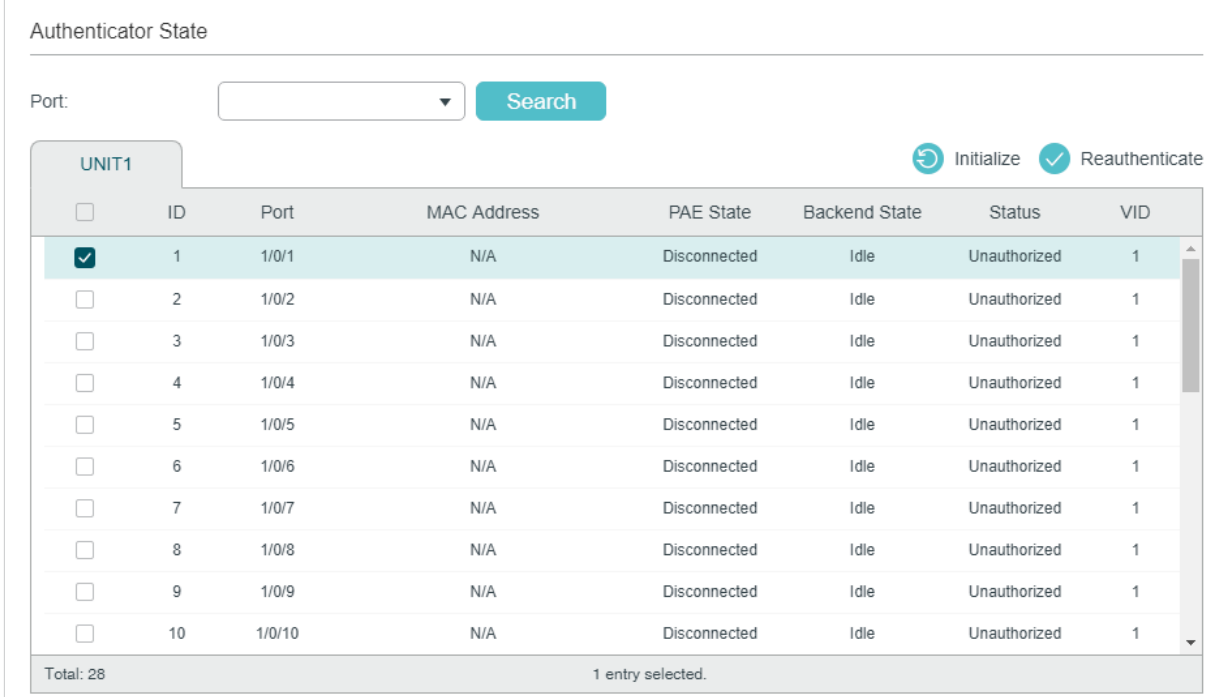

Choose the menu **SECURITY > 802.1x > Authenticator State** to load the following page.

Figure 2-8 View Authenticator State



Authenticator State

Port:

UNIT1  Initialize  Reauthenticate

| <input type="checkbox"/>            | ID | Port   | MAC Address | PAE State    | Backend State | Status       | VID |
|-------------------------------------|----|--------|-------------|--------------|---------------|--------------|-----|
| <input checked="" type="checkbox"/> | 1  | 1/0/1  | N/A         | Disconnected | Idle          | Unauthorized | 1   |
| <input type="checkbox"/>            | 2  | 1/0/2  | N/A         | Disconnected | Idle          | Unauthorized | 1   |
| <input type="checkbox"/>            | 3  | 1/0/3  | N/A         | Disconnected | Idle          | Unauthorized | 1   |
| <input type="checkbox"/>            | 4  | 1/0/4  | N/A         | Disconnected | Idle          | Unauthorized | 1   |
| <input type="checkbox"/>            | 5  | 1/0/5  | N/A         | Disconnected | Idle          | Unauthorized | 1   |
| <input type="checkbox"/>            | 6  | 1/0/6  | N/A         | Disconnected | Idle          | Unauthorized | 1   |
| <input type="checkbox"/>            | 7  | 1/0/7  | N/A         | Disconnected | Idle          | Unauthorized | 1   |
| <input type="checkbox"/>            | 8  | 1/0/8  | N/A         | Disconnected | Idle          | Unauthorized | 1   |
| <input type="checkbox"/>            | 9  | 1/0/9  | N/A         | Disconnected | Idle          | Unauthorized | 1   |
| <input type="checkbox"/>            | 10 | 1/0/10 | N/A         | Disconnected | Idle          | Unauthorized | 1   |

Total: 28 1 entry selected.

On this page, you can view the authentication status of each port:

|                      |   |
|----------------------|---|
| <b>Port</b>          | Displays the port number.   |
| <b>MAC Address</b>   | Displays the MAC address of the authenticated device. When the port method is Port Based, the MAC address of the first authenticated device will be displayed with a suffix "p".  |
| <b>PAE State</b>     | Displays the current state of the authenticator PAE state machine. Possible values are: Initialize, Disconnected, Connecting, Authenticating, Authenticated, Aborting, Held, ForceAuthorized and ForceUnauthorized.     |
| <b>Backend State</b> | Displays the current state of the backend authentication state machine. Possible values are: Request, Response, Success, Fail, Timeout, Initialize and Idle.  |
| <b>Status</b>        | Displays whether the port is authorized or not.   |
| <b>VID</b>           | Displays the VLAN ID assigned by the authenticator to the supplicant device when the related port is authorized. If the related port is unauthorized and there is a Guest VLAN ID, the Guest VLAN ID will be displayed. |

## 2.2 Using the CLI

### 2.2.1 Configuring the RADIUS Server

Follow these steps to configure RADIUS:

|        |   |
|--------|---|
| Step 1 | <p><b>configure</b></p> <p>Enter global configuration mode.</p>   |
| Step 2 | <p><b>radius-server host</b> <i>ip-address</i> [<b>auth-port</b> <i>port-id</i>] [<b>acct-port</b> <i>port-id</i>] [<b>timeout</b> <i>time</i>] [<b>retransmit</b> <i>number</i>] [<b>nas-id</b> <i>nas-id</i>] <b>key</b> { [ 0 ] <i>string</i>   7 <i>encrypted-string</i> }</p> <p>Add the RADIUS server and configure the related parameters as needed.</p> <p><b>host</b> <i>ip-address</i>: Enter the IP address of the server running the RADIUS protocol.</p> <p><b>auth-port</b> <i>port-id</i>: Specify the UDP destination port on the RADIUS server for authentication requests. The default setting is 1812.</p> <p><b>acct-port</b> <i>port-id</i>: Specify the UDP destination port on the RADIUS server for accounting requests. The default setting is 1813. Generally, the accounting feature is not used in the authentication account management.</p> <p><b>timeout</b> <i>time</i>: Specify the time interval that the switch waits for the server to reply before resending. The valid values are from 1 to 9 seconds and the default setting is 5 seconds.</p> <p><b>retransmit</b> <i>number</i>: Specify the number of times a request is resent to the server if the server does not respond. The valid values are from 1 to 3 and the default setting is 2.</p> <p><b>nas-id</b> <i>nas-id</i>: Specify the name of the NAS (Network Access Server) to be contained in RADIUS packets for identification. It ranges from 1 to 31 characters. The default value is the MAC address of the switch. Generally, the NAS indicates the switch itself.</p> <p><b>key</b> { [ 0 ] <i>string</i>   7 <i>encrypted-string</i> }: Specify the shared key. 0 and 7 prevent the encryption type. 0 indicates that an unencrypted key will follow. 7 indicates that a symmetric encrypted key with a fixed length will follow. By default, the encryption type is 0. <i>string</i> is the shared key for the switch and the server, which contains 32 characters at most. <i>encrypted-string</i> is a symmetric encrypted key with a fixed length, which you can copy from the configuration file of another switch. The key or encrypted-key you configured here will be displayed in the encrypted form.</p> |
| Step 3 | <p><b>aaa group radius</b> <i>group-name</i></p> <p>Create a RADIUS server group.</p> <p><b>radius</b>: Specify the group type as radius.</p> <p><b>group-name</b>: Specify a name for the group.</p>   |
| Step 4 | <p><b>server</b> <i>ip-address</i></p> <p>Add the existing servers to the server group.</p> <p><b>ip-address</b>: Specify IP address of the server to be added to the group.</p>  |
| Step 5 | <p><b>exit</b></p> <p>Return to global configuration mode.</p>  |

- 
- Step 6      **aaa authentication dot1x default { method }**  
Select the RADIUS group for 802.1x authentication.  
*method*: Specify the RADIUS group for 802.1x authentication.
- aaa accounting dot1x default { method }**  
Select the RADIUS group for 802.1x accounting.  
*method*: Specify the RADIUS group for 802.1x accounting.
- Note*: If multiple RADIUS servers are available, you are suggested to add them to different server groups respectively for authentication and accounting.
- 
- Step 7      **show radius-server**  
(Optional) Verify the configuration of RADIUS server.
- 
- Step 8      **show aaa group [ group-name ]**  
(Optional) Verify the configuration of server group.
- 
- Step 9      **show aaa authentication dot1x**  
(Optional) Verify the authentication method list.
- 
- Step 10     **show aaa accounting dot1x**  
(Optional) Verify the accounting method list.
- 
- Step 11     **end**  
Return to privileged EXEC mode.
- 
- Step 12     **copy running-config startup-config**  
Save the settings in the configuration file.
- 

The following example shows how to enable AAA, add a RADIUS server to the server group named radius1, and apply this server group to the 802.1x authentication. The IP address of the RADIUS server is 192.168.0.100; the shared key is 123456; the authentication port is 1812; the accounting port is 1813.

```
Switch#configure
```

```
Switch(config)#radius-server host 192.168.0.100 auth-port 1812 acct-port 1813 key
123456
```

```
Switch(config)#aaa group radius radius1
```

```
Switch(aaa-group)#server 192.168.0.100
```

```
Switch(aaa-group)#exit
```

```
Switch(config)#aaa authentication dot1x default radius1
```

```
Switch(config)#aaa accounting dot1x default radius1
```

```
Switch(config)#show radius-server
```

| Server Ip     | Auth Port | Acct Port | Timeout | Retransmit | NAS Identifier | Shared key |
|---------------|-----------|-----------|---------|------------|----------------|------------|
| 192.168.0.100 | 1812      | 1813      | 5       | 2          | 000AEB132397   | 123456     |

```
Switch(config)#show aaa group radius1
```

```
192.168.0.100
```

```
Switch(config)#show aaa authentication dot1x
```

| Methodlist | pri1    | pri2 | pri3 | pri4 |
|------------|---------|------|------|------|
| default    | radius1 | --   | --   | --   |

```
Switch(config)#show aaa accounting dot1x
```

| Methodlist | pri1    | pri2 | pri3 | pri4 |
|------------|---------|------|------|------|
| default    | radius1 | --   | --   | --   |

```
Switch(config)#end
```

```
Switch#copy running-config startup-config
```

## 2.2.2 Configuring 802.1x Globally

Follow these steps to configure 802.1x globally:

- 
- |        |   |
|--------|---|
| Step 1 | <p><b>configure</b></p> <p>Enter global configuration mode.</p> |
|--------|---|
- 
- |        |   |
|--------|---|
| Step 2 | <p><b>dot1x system-auth-control</b></p> <p>Enable 802.1x authentication globally.</p> |
|--------|---|
-



---

|        |   |
|--------|---|
| Step 3 | <b>dot1x auth-protocol { pap   eap }</b><br>Configure the 802.1x authentication protocol.<br><br><b>pap:</b> Specify the authentication protocol as PAP. If this option is selected, the 802.1x authentication system uses EAP (Extensible Authentication Protocol) packets to exchange information between the switch and the client. The transmission of EAP packets is terminated at the switch and the EAP packets are converted to other protocol (such as RADIUS) packets, and transmitted to the authentication server.<br><br><b>eap:</b> Specify the authentication protocol as EAP. If this option is selected, the 802.1x authentication system uses EAP packets to exchange information between the switch and the client. The EAP packets with authentication data are encapsulated in the advanced protocol (such as RADIUS) packets, and transmitted to the authentication server. |
| Step 4 | <b>dot1x accounting</b><br>(Optional) Enable the accounting feature.  |
| Step 5 | <b>dot1x handshake</b><br>(Optional) Enable the Handshake feature. The Handshake feature is used to detect the connection status between the TP-Link 802.1x Client and the switch. Please disable Handshake feature if you are using other client softwares instead of TP-Link 802.1x Client.   |
| Step 6 | <b>dot1x vlan-assignment</b><br>(Optional) Enable or disable the 802.1x VLAN assignment feature. 802.1x VLAN assignment is a technology allowing the RADIUS server to send the VLAN assignment to the port when the port is authenticated.<br><br>If the assigned VLAN does not exist on the switch, the switch will create the related VLAN automatically, add the authenticated port to the VLAN and change the PVID based on the assigned VLAN.<br><br>If the assigned VLAN exists on the switch, the switch will directly add the authenticated port to the related VLAN and change the PVID instead of creating a new VLAN.<br><br>If no VLAN is supplied by the RADIUS server or if 802.1x authentication is disabled, the port will be in its original VLAN after successful authentication.   |
| Step 7 | <b>show dot1x global</b><br>(Optional) Verify global configurations of 802.1x.  |
| Step 8 | <b>end</b><br>Return to privileged EXEC mode.   |
| Step 9 | <b>copy running-config startup-config</b><br>Save the settings in the configuration file.   |

---

The following example shows how to enable 802.1x authentication, configure PAP as the authentication method and keep other parameters as default:

```

Switch#configure
Switch(config)#dot1x system-auth-control
Switch(config)#dot1x auth-protocol pap
Switch(config)#show dot1x global
802.1X State:          Enabled
Authentication Protocol:  PAP
Handshake State:        Enabled
802.1X Accounting State:  Disabled
802.1X VLAN Assignment State:  Disabled
Switch(config)#end
Switch#copy running-config startup-config

```

## 2.2.3 Configuring 802.1x on Ports

Follow these steps to configure the port:

|        |  |
|--------|--|
| Step 1 | <p><b>configure</b></p> <p>Enter global configuration mode.</p>  |
| Step 2 | <p><b>interface {fastEthernet port   range fastEthernet port-list   gigabitEthernet port   range gigabitEthernet port-list   ten-gigabitEthernet port   range ten-gigabitEthernet port-list }</b></p> <p>Enter interface configuration mode.</p> <p><i>port</i>: Enter the ID of the port to be configured.</p>  |
| Step 3 | <p><b>dot1x</b></p> <p>Enable 802.1x authentication for the port.</p>  |
| Step 4 | <p><b>dot1x mab</b></p> <p>Enable the MAB (MAC-Based Authentication Bypass) feature for the port.</p> <p>With MAB feature enabled, the switch automatically sends the authentication server a RADIUS access request frame with the client's MAC address as the username and password. It is also necessary to configure the RADIUS server with the client's information for authentication. You can enable this feature on IEEE 802.1x ports connected to devices without 802.1x capability. For example, most printers, IP phones and fax machines do not have 802.1x capability.</p> <p><b>Note:</b> MAB cannot work if Guest VLAN is enabled.</p> |

---

|         |   |
|---------|---|
| Step 5  | <b>dot1x guest-vlan vid</b><br>(Optional) Configure guest VLAN on the port.<br><br><i>vid</i> : Specify the ID of the VLAN to be configured as the guest VLAN. The valid values are from 0 to 4094. 0 means that Guest VLAN is disabled on the port. The configured VLAN must be an existing 802.1Q VLAN. Clients in the guest VLAN can only access resources from specific VLANs.<br><br><b>Note</b> : To use Guest VLAN, the control type of the port should be configured as port-based. |
| Step 6  | <b>dot1x port-control { auto   authorized-force   unauthorized-force }</b><br>Configure the control mode for the port. By default, it is auto.<br><br><i>auto</i> : If this option is selected, the port can access the network only when it is authenticated.<br><br><i>authorized-force</i> : If this option is selected, the port can access the network without authentication.<br><br><i>unauthorized-force</i> : If this option is selected, the port can never be authenticated.     |
| Step 7  | <b>dot1x port-method { mac-based   port-based }</b><br>Configure the control type for the port. By default, it is mac-based.<br><br><i>mac-based</i> : All clients connected to the port need to be authenticated.<br><br><i>port-based</i> : If a client connected to the port is authenticated, other clients can access the LAN without authentication.  |
| Step 8  | <b>dot1x max-req times</b><br>Specify the maximum number of attempts to send the authentication packet for the client.<br><br><i>times</i> : The maximum attempts for the client to send the authentication packet. It ranges from 1 to 9 and the default is 3.   |
| Step 9  | <b>dot1x quiet-period [time]</b><br>(Optional) Enable the quiet feature for 802.1x authentication and configure the quiet period.<br><br><i>time</i> : Set a value between 1 and 999 seconds for the quiet period. It is 10 seconds by default. The quiet period starts after the authentication fails. During the quiet period, the switch does not process authentication requests from the same client.  |
| Step 10 | <b>dot1x timeout supp-timeout time</b><br>Configure the supplicant timeout period.<br><br><i>time</i> : Specify the maximum time for which the switch waits for response from the client. It ranges from 1 to 60 seconds and the default time is 30 seconds. If the switch does not receive any reply from the client within the specified time, it will resend the request.  |
| Step 11 | <b>show dot1x interface [fastEthernet port   gigabitEthernet port   ten-gigabitEthernet port]</b><br>(Optional) Verify the configurations of 802.1x authentication on the port.<br><br><i>port</i> : Enter the ID of the port to be configured. If no specific port is entered, the switch will show configurations of all ports.   |

---

---

|         |   |
|---------|---|
| Step 12 | <b>end</b><br>Return to privileged EXEC mode.   |
| Step 13 | <b>copy running-config startup-config</b><br>Save the settings in the configuration file. |

---

The following example shows how to enable 802.1x authentication on port 1/0/2, configure the control type as port-based, and keep other parameters as default:

**Switch#configure**

**Switch(config)#interface gigabitEthernet 1/0/2**

**Switch(config-if)#dot1x**

**Switch(config-if)#dot1x port-method port-based**

**Switch(config-if)#show dot1x interface gigabitEthernet 1/0/2**

| Port    | State    | MAB State | GuestVLAN | PortControl | PortMethod |
|---------|----------|-----------|-----------|-------------|------------|
| ----    | -----    | -----     | -----     | -----       | -----      |
| Gi1/0/2 | disabled | disabled  | 0         | auto        | port-based |

| MaxReq | QuietPeriod | SuppTimeout | Authorized   | LAG |
|--------|-------------|-------------|--------------|-----|
| -----  | -----       | -----       | -----        | --- |
| 3      | 10          | 30          | unauthorized | N/A |

**Switch(config-if)#end**

**Switch#copy running-config startup-config**

## 2.2.4 Viewing Authenticator State

You can view the authenticator state. If needed, you can also initialize or reauthenticate the specific client:

---

|        |  |
|--------|--|
| Step 1 | <b>show dot1x auth-state [interface fastEthernet port   interface gigabitEthernet port]</b><br>Displays the authenticator state. |
| Step 2 | <b>configure</b><br>Enter global configuration mode.   |

---

- 
- Step 3      **interface {fastEthernet *port* | range fastEthernet *port-list* | gigabitEthernet *port* | range gigabitEthernet *port-list* | ten-gigabitEthernet *port* | range ten-gigabitEthernet *port-list*}**  
Enter interface configuration mode.  
  
*port*: Enter the ID of the port to be configured.
- 
- Step 4      **dot1x auth-init [ mac *mac-address* ]**  
Initialize the specific client. To access the network, the client needs to provide the correct information to pass the authentication again.  
  
*mac-address*: Enter the MAC address of the client that will be unauthorized.
- 
- Step 5      **dot1x auth-reauth [ mac *mac-address* ]**  
Reauthenticate the specific client.  
  
*mac-address*: Enter the MAC address of the client that will be reauthenticated.
- 
- Step 6      **end**  
Return to privileged EXEC mode.
- 
- Step 7      **copy running-config startup-config**  
Save the settings in the configuration file.
-

# 3 Configuration Example

## 3.1 Network Requirements

The network administrator wants to control access from the end users (clients) in the company. It is required that all clients need to be authenticated separately and only the authenticated clients can access the internet.

## 3.2 Configuration Scheme

- To authenticate clients separately, enable 802.1x authentication, configure the control mode as auto, and set the control type as MAC based.
- Enable 802.1x authentication on the ports connected to clients.
- Keep 802.1x authentication disabled on ports connected to the authentication server and the internet, which ensures unrestricted connections between the switch and the authentication server or the internet.

## 3.3 Network Topology

As shown in the following figure, Switch A acts as the authenticator. Port 1/0/1 is connected to the client, port 1/0/2 is connected to the RADIUS server, and port 1/0/3 is connected to the internet.

Figure 3-1 Network Topology

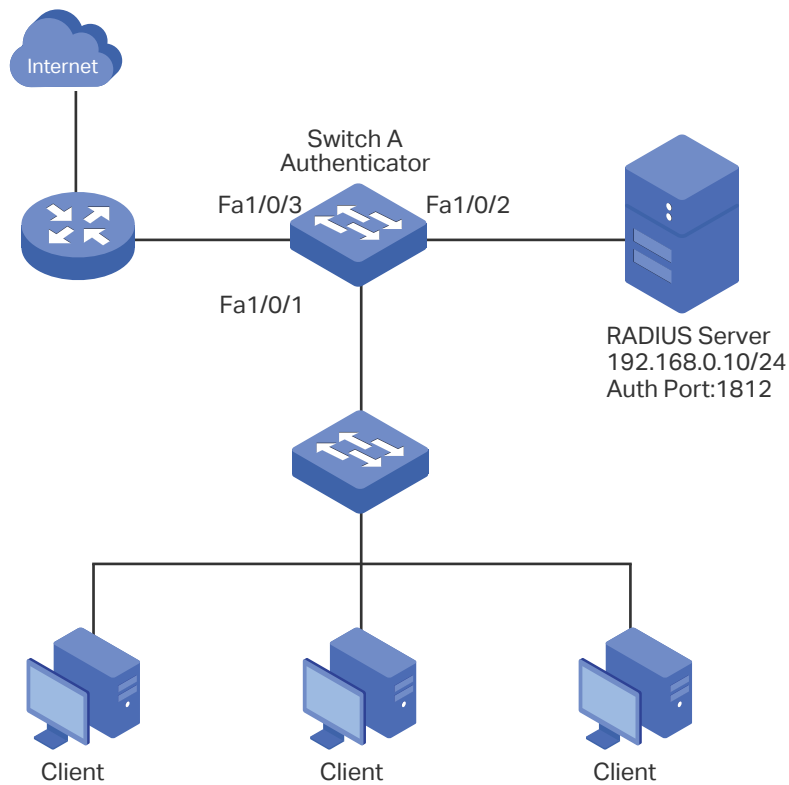

Demonstrated with T1500-28PCT acting as the authenticator, the following sections provide configuration procedure in two ways: using the GUI and using the CLI.

### 3.4 Using the GUI

- 1) Choose the menu **SECURITY > AAA > RADIUS Config** and click **+ Add** to load the following page. Configure the parameters of the RADIUS server and click **Create**.

Figure 3-2 Adding RADIUS Server

RADIUS Server

|                      |   |   |
|----------------------|---|---|
| Server IP:           | <input style="width: 90%;" type="text" value="192.168.0.10"/> | (Format: 192.168.0.1)   |
| Shared Key:          | <input style="width: 90%;" type="text" value="123456"/>       | 1-32 characters. Only numbers, letters and the following symbols are allowed: - . / : @ _ . |
| Authentication Port: | <input style="width: 90%;" type="text" value="1812"/>         | (1-65535)   |
| Accounting Port:     | <input style="width: 90%;" type="text" value="1813"/>         | (1-65535)   |
| Retransmit:          | <input style="width: 90%;" type="text" value="2"/>            | (1-3)   |
| Timeout:             | <input style="width: 90%;" type="text" value="5"/>            | seconds (1-9)   |
| NAS Identifier:      | <input style="width: 90%;" type="text"/>                      | (Optional)  |

- 2) Choose the menu **SECURITY > AAA > Server Group** and click **+ Add** to load the following page. Specify the group name as RADIUS1, select the server type as RADIUS and server IP as 192.168.0.10. Click **Create**.

Figure 3-3 Creating Server Group

The screenshot shows the 'Server Group' configuration page. It has a teal header. Below the header, there are three input fields: 'Server Group:' with a text box containing 'RADIUS1' and '(1-15 characters)' to its right; 'Server Type:' with a dropdown menu showing 'RADIUS'; and 'Server IP:' with a dropdown menu showing '192.168.0.10'. At the bottom right, there are two buttons: 'Cancel' and 'Create'. The 'Create' button is highlighted with a red box.

- 3) Choose the menu **SECURITY > AAA > Dot1x List** to load the following page. In the **Authentication Dot1x Method** section, select RADIUS1 as the RADIUS server group for authentication, and click **Apply**.

Figure 3-4 Configuring Authentication RADIUS Server

The screenshot shows the 'Authentication Dot1x Method' configuration page. It has a teal header. Below the header, there are two input fields: 'Method List:' with a text box containing 'default'; and 'Pri1:' with a dropdown menu showing 'RADIUS1'. At the bottom right, there is an 'Apply' button highlighted with a red box.

- 4) Choose the menu **SECURITY > 802.1x > Global Config** to load the following page. Enable 802.1x authentication and configure the Authentication Method as EAP. Keep the default authentication settings. Click **Apply**.

Figure 3-5 Configuring Global Settings

The screenshot shows the 'Global Config' page. It has a teal header. Below the header, there are five input fields: '802.1x:' with a checked checkbox and 'Enable' text; 'Authentication Protocol:' with a dropdown menu showing 'EAP'; 'Accounting:' with an unchecked checkbox and 'Enable' text; 'Handshake:' with a checked checkbox and 'Enable' text; and 'VLAN Assignment:' with an unchecked checkbox and 'Enable' text. At the bottom right, there is an 'Apply' button highlighted with a red box.

- 5) Choose the menu **SECURITY > 802.1x > Port Config** to load the following page. For port 1/0/1, enable 802.1x authentication, set the Control Mode as auto and set the Control Type as MAC Based; For port 1/0/2 and port 1/0/3, disable 802.1x authentication.



Figure 3-6 Configuring Port

Port Config

UNIT1

| <input type="checkbox"/>            | ID | Port   | Status  | MAB     | Guest VLAN<br>(0-4094) | Port Control | Port Method | Maximum<br>Request<br>(1-9) | Quiet Period<br>(1-999) | Suppl<br>Time<br>(1- |
|-------------------------------------|----|--------|---------|---------|------------------------|--------------|-------------|-----------------------------|-------------------------|----------------------|
| <input checked="" type="checkbox"/> | 1  | 1/0/1  | Enabl   | Disable | 0                      | Auto         | MAC Based   | 3                           | 10                      | 3                    |
| <input type="checkbox"/>            | 2  | 1/0/2  | Disable | Disable | 0                      | Auto         | MAC Based   | 3                           | 10                      | 3                    |
| <input type="checkbox"/>            | 3  | 1/0/3  | Disable | Disable | 0                      | Auto         | MAC Based   | 3                           | 10                      | 3                    |
| <input type="checkbox"/>            | 4  | 1/0/4  | Disable | Disable | 0                      | Auto         | MAC Based   | 3                           | 10                      | 3                    |
| <input type="checkbox"/>            | 5  | 1/0/5  | Disable | Disable | 0                      | Auto         | MAC Based   | 3                           | 10                      | 3                    |
| <input type="checkbox"/>            | 6  | 1/0/6  | Disable | Disable | 0                      | Auto         | MAC Based   | 3                           | 10                      | 3                    |
| <input type="checkbox"/>            | 7  | 1/0/7  | Disable | Disable | 0                      | Auto         | MAC Based   | 3                           | 10                      | 3                    |
| <input type="checkbox"/>            | 8  | 1/0/8  | Disable | Disable | 0                      | Auto         | MAC Based   | 3                           | 10                      | 3                    |
| <input type="checkbox"/>            | 9  | 1/0/9  | Disable | Disable | 0                      | Auto         | MAC Based   | 3                           | 10                      | 3                    |
| <input type="checkbox"/>            | 10 | 1/0/10 | Disable | Disable | 0                      | Auto         | MAC Based   | 3                           | 10                      | 3                    |

Total: 28      1 entry selected.

Cancel      Apply

- 6) Click  Save to save the settings.

### 3.5 Using the CLI

- 1) Configure the RADIUS parameters.

```
Switch_A(config)#radius-server host 192.168.0.10 auth-port 1812 key 123456
```

```
Switch_A(config)#aaa group radius RADIUS1
```

```
Switch_A(aaa-group)#server 192.168.0.10
```

```
Switch_A(aaa-group)#exit
```

```
Switch_A(config)#aaa authentication dot1x default RADIUS1
```

- 2) Globally enable 802.1x authentication and set the authentication protocol.

```
Switch_A(config)#dot1x system-auth-control
```

```
Switch_A(config)#dot1x auth-protocol eap
```

- 3) Disable 802.1x authentication on port 1/0/2 and port 1/0/3. Enable 802.1x authentication on port 1/0/1, set the control mode as auto, and set the control type as MAC based.

```
Switch_A(config)#interface fastEthernet 1/0/2
```

```
Switch_A(config-if)#no dot1x
```

```
Switch_A(config-if)#exit
```

```

Switch_A(config)#interface fastEthernet 1/0/3
Switch_A(config-if)#no dot1x
Switch_A(config-if)#exit
Switch_A(config)#interface fastEthernet 1/0/1
Switch_A(config-if)#dot1x
Switch_A(config-if)#dot1x port-method mac-based
Switch_A(config-if)#dot1x port-control auto
Switch_A(config-if)#exit

```

### Verify the Configurations

Verify the global configurations of 802.1x authentication:

```

Switch_A#show dot1x global
802.1X State:          Enabled
Authentication Protocol:  EAP
Handshake State:       Enabled
802.1X Accounting State:  Disabled
802.1X VLAN Assignment State:  Disabled

```

Verify the configurations of 802.1x authentication on the port:

```

Switch_A#show dot1x interface

```

| Port    | State       | MAB State   | GuestVLAN    | PortControl | PortMethod |
|---------|-------------|-------------|--------------|-------------|------------|
| ----    | -----       | -----       | -----        | -----       | -----      |
| Fa1/0/1 | enabled     | disabled    | 0            | auto        | mac-based  |
| Fa1/0/2 | disabled    | disabled    | 0            | auto        | mac-based  |
| Fa1/0/3 | disabled    | disabled    | 0            | auto        | mac-based  |
| ...     |             |             |              |             |            |
| MaxReq  | QuietPeriod | SuppTimeout | Authorized   | LAG         |            |
| -----   | -----       | -----       | -----        | ---         |            |
| 3       | 10          | 30          | unauthorized | N/A         |            |
| 3       | 10          | 30          | unauthorized | N/A         |            |

```
3          10          30          unauthorized  N/A
...
```

Verify the configurations of RADIUS :

```
Switch_A#show aaa global
```

| Module | Login List | Enable List |
|--------|------------|-------------|
| Telnet | default    | default     |
| Ssh    | default    | default     |
| Http   | default    | default     |

```
Switch_A#show aaa authentication dot1x
```

| Methodlist | pri1    | pri2 | pri3 | pri4 |
|------------|---------|------|------|------|
| default    | RADIUS1 | --   | --   | --   |

```
Switch_A#show aaa group RADIUS1
```

```
192.168.0.10
```

# 4 Appendix: Default Parameters

Default settings of 802.1x are listed in the following table.

Table 4-1 Default Settings of 802.1x

| Parameter                        | Default Setting                    |
|----------------------------------|------------------------------------|
| Global Config                    |                                    |
| 802.1x Authentication            | Disabled                           |
| Authentication Method            | EAP                                |
| Handshake                        | Enabled                            |
| Accounting                       | Disabled                           |
| VLAN Assignment                  | Disabled                           |
| Port Config                      |                                    |
| 802.1x Status                    | Disabled                           |
| MAB                              | Disabled                           |
| Guest VLAN                       | Disabled                           |
| Port Control                     | Auto                               |
| Guest VLAN                       | 0                                  |
| Maximum Request                  | 3                                  |
| Quiet Period                     | 10 seconds                         |
| Supplicant Timeout               | 30 seconds                         |
| Port Method                      | MAC Based                          |
| Dot1X List                       |                                    |
| Authentication Dot1x Method List | List Name: default<br>Pri1: radius |
| Accounting Dot1x Method List     | List Name: default<br>Pri1: radius |

# Part 18

## Configuring Port Security

### CHAPTERS

1. Overview
2. Port Security Configuration
3. Appendix: Default Parameters

# 1 Overview

You can use the Port Security feature to limit the number of MAC addresses that can be learned on each port, thus preventing the MAC address table from being exhausted by the attack packets. In addition, the switch can send a notification if the number of learned MAC addresses on the port exceeds the limit.

# 2 Port Security Configuration

## 2.1 Using the GUI

Choose the menu **SECURITY > Port Security** to load the following page.

Figure 2-1 Port Security

| <input type="checkbox"/>            | Port   | Max Learned Number of MAC | Current Learned Number | Exceed Max Learned Trap | Learn Address Mode | Status  |
|-------------------------------------|--------|---------------------------|------------------------|-------------------------|--------------------|---------|
| <input checked="" type="checkbox"/> | 1/0/1  | 64                        | 0                      | Disable                 | Delete on Timeout  | Disable |
| <input type="checkbox"/>            | 1/0/2  | 64                        | 0                      | Disable                 | Delete on Timeout  | Disable |
| <input type="checkbox"/>            | 1/0/3  | 64                        | 0                      | Disable                 | Delete on Timeout  | Disable |
| <input type="checkbox"/>            | 1/0/4  | 64                        | 0                      | Disable                 | Delete on Timeout  | Disable |
| <input type="checkbox"/>            | 1/0/5  | 64                        | 0                      | Disable                 | Delete on Timeout  | Disable |
| <input type="checkbox"/>            | 1/0/6  | 64                        | 0                      | Disable                 | Delete on Timeout  | Disable |
| <input type="checkbox"/>            | 1/0/7  | 64                        | 0                      | Disable                 | Delete on Timeout  | Disable |
| <input type="checkbox"/>            | 1/0/8  | 64                        | 0                      | Disable                 | Delete on Timeout  | Disable |
| <input type="checkbox"/>            | 1/0/9  | 64                        | 0                      | Disable                 | Delete on Timeout  | Disable |
| <input type="checkbox"/>            | 1/0/10 | 64                        | 0                      | Disable                 | Delete on Timeout  | Disable |

Total: 28      1 entry selected.      Cancel Apply

Follow these steps to configure Port Security:

- 1) Select one or more ports and configure the following parameters.

|                           |   |
|---------------------------|---|
| Port                      | Displays the port number.   |
| Max Learned Number of MAC | Specify the maximum number of MAC addresses that can be learned on the port. When the learned MAC address number reaches the limit, the port will stop learning. It ranges from 0 to 64. The default value is 64. |
| Current Learned MAC       | Displays the current number of MAC addresses that have been learned on the port.  |
| Exceed Max Learned Trap   | Enable Exceed Max Learned, and when the maximum number of learned MAC addresses on the specified port is exceeded, a notification will be generated and sent to the management host.                              |

|                    |   |
|--------------------|---|
| Learn Address Mode | <p>Select the learn mode of the MAC addresses on the port. Three modes are provided:</p> <p><b>Delete on Timeout:</b> The switch will delete the MAC addresses that are not used or updated within the aging time. It is the default setting.</p> <p><b>Delete on Reboot:</b> The learned MAC addresses are out of the influence of the aging time and can only be deleted manually. The learned entries will be cleared after the switch is rebooted.</p> <p><b>Permanent:</b> The learned MAC addresses are out of the influence of the aging time and can only be deleted manually. The learned entries will be saved even the switch is rebooted.</p> |
| Status             | <p>Select the status of Port Security. Three kinds of status can be selected:</p> <p><b>Drop:</b> When the number of learned MAC addresses reaches the limit, the port will stop learning and discard the packets with the MAC addresses that have not been learned.</p> <p><b>Forward:</b> When the number of learned MAC addresses reaches the limit, the port will stop learning but send the packets with the MAC addresses that have not been learned.</p> <p><b>Disable:</b> The number limit on the port is not effective, and the switch follows the original forwarding rules. It is the default setting.</p>                                    |

2) Click **Apply**.

 **Note:**

- Port Security cannot be enabled on the member ports of a LAG, and the port with Port Security enabled cannot be added to a LAG.
- On one port, Port Security and 802.1x cannot be enabled at the same time.

## 2.2 Using the CLI

Follow these steps to configure Port Security:

|        |  |
|--------|--|
| Step 1 | <p><b>configure</b><br/>Enter global configuration mode.</p>   |
| Step 2 | <p><b>interface { fastEthernet port   range fastEthernet port-list   gigabitEthernet port   range gigabitEthernet port-list   ten-gigabitEthernet port   range ten-gigabitEthernet port-list }</b><br/>Enter interface configuration mode.</p> |



- 
- Step 3      **mac address-table max-mac-count { [max-number *num*] [exceed-max-learned enable | disable] [mode { dynamic | static | permanent } ] [ status { forward | drop | disable } ]}**  
 Enable the port security feature of the port and configure the related parameters.  
*num*: The maximum number of MAC addresses that can be learned on the port. The valid values are from 0 to 64. The default value is 64.
- exceed-max-learned:** With exceed-max-learned enabled, when the maximum number of MAC addresses on the specified port is exceeded, a notification will be generated and sent to the management host.
- enable:** Enable exceed-max-learned.  
**disable:** Disable exceed-max-learned.
- mode:** Learn mode of the MAC address. There are three modes:
- dynamic:** The switch will delete the MAC addresses that are not used or updated within the aging time.
- static:** The learned MAC addresses are out of the influence of the aging time and can only be deleted manually. The learned entries will be cleared after the switch is rebooted.
- permanent:** The learned MAC address is out of the influence of the aging time and can only be deleted manually. The learned entries will be saved even the switch is rebooted.
- status:** Status of port security feature. By default, it is disabled.
- drop:** When the number of learned MAC addresses reaches the limit, the port will stop learning and discard the packets with the MAC addresses that have not been learned.
- forward:** When the number of learned MAC addresses reaches the limit, the port will stop learning but send the packets with the MAC addresses that have not been learned.
- disable:** The number limit on the port is not effective, and the switch follows the original forwarding rules. It is the default setting.
- 
- Step 4      **show mac address-table max-mac-count interface { fastEthernet *port* | gigabitEthernet *port* | ten-gigabitEthernet *port* }**  
 Verify the Port Security configuration and the current learned MAC addresses of the port.
- 
- Step 5      **end**  
 Return to privileged EXEC mode.
- 
- Step 6      **copy running-config startup-config**  
 Save the settings in the configuration file.
- 

 **Note:**

- Port Security cannot be enabled on the member port of a LAG, and the port with Port Security enabled cannot be added to a LAG.
- On one port, Port Security and 802.1x cannot be enabled at the same time.

The following example shows how to set the maximum number of MAC addresses that can be learned on port 1/0/1 as 30, enable exceed-max-learned feature and configure the mode as permanent and the status as drop:

**Switch#configure**

**Switch(config)#interface gigabitEthernet 1/0/1**

```
Switch(config-if)#mac address-table max-mac-count max-number 30 exceed-max-learned enable mode permanent status drop
```

```
Switch(config-if)#show mac address-table max-mac-count interface gigabitEthernet 1/0/1
```

| Port    | Max-learn | Current-learn | Exceed Max Limit | Mode      | Status |
|---------|-----------|---------------|------------------|-----------|--------|
| ----    | -----     | -----         | -----            | -----     | -----  |
| Gi1/0/1 | 30        | 0             | disable          | permanent | drop   |

```
Switch(config-if)#end
```

```
Switch#copy running-config startup-config
```

# 3 Appendix: Default Parameters

Default settings of Port Security are listed in the following table.

Table 3-1 Default Parameters of Port Security

| Parameter                 | Default Setting   |
|---------------------------|-------------------|
| Max Learned Number of MAC | 64                |
| Current Learned Number    | 0                 |
| Exceed Max Learned Trap   | Disabled          |
| Learn Address Mode        | Delete on Timeout |
| Status                    | Disabled          |

# Part 19

## Configuring ACL

### CHAPTERS

1. Overview
2. ACL Configuration
3. Configuration Example for ACL
4. Appendix: Default Parameters

# 1 Overview

ACL (Access Control List) filters traffic as it passes through a switch, and permits or denies packets crossing specified interfaces or VLANs. It accurately identifies and processes the packets based on the ACL rules. In this way, ACL helps to limit network traffic, manage network access behaviors, forward packets to specified ports and more.

To configure ACL, follow these steps:

- 1) Configure a time range during which the ACL is in effect.
- 2) Create an ACL and configure the rules to filter different packets.
- 3) Bind the ACL to a port or VLAN to make it effective.

## Configuration Guidelines

- A packet “matches” an ACL rule when it meets the rule’s matching criteria. The resulting action will be either to “permit” or “deny” the packet that matches the rule.
- If no ACL rule is configured, the packets will be forwarded without being processed by the ACL. If there is configured ACL rules and no matching rule is found, the packets will be dropped.

# 2 ACL Configuration

## 2.1 Using the GUI

### 2.1.1 Configuring Time Range

Some ACL-based services or features may need to be limited to take effect only during a specified time period. In this case, you can configure a time range for the ACL. For details about Time Range configuration, please refer to [Managing System](#).

### 2.1.2 Creating an ACL

You can create different types of ACL and define the rules based on source MAC or IP address, destination MAC or IP address, protocol type, port number and so on.

**MAC ACL:** MAC ACL uses source and destination MAC address for matching operations.

**IP ACL:** IP ACL uses source and destination IP address, IP protocols and so on for matching operations.

**Combined ACL:** Combined ACL uses source and destination MAC address, and source and destination IP address for matching operations.

**IPv6 ACL:** IPv6 ACL uses source and destination IPv6 address for matching operations.

Choose the menu **SECURITY > ACL > ACL Config** and click  **Add** to load the following page.

Figure 2-1 Creating an ACL



ACL

ACL Type:

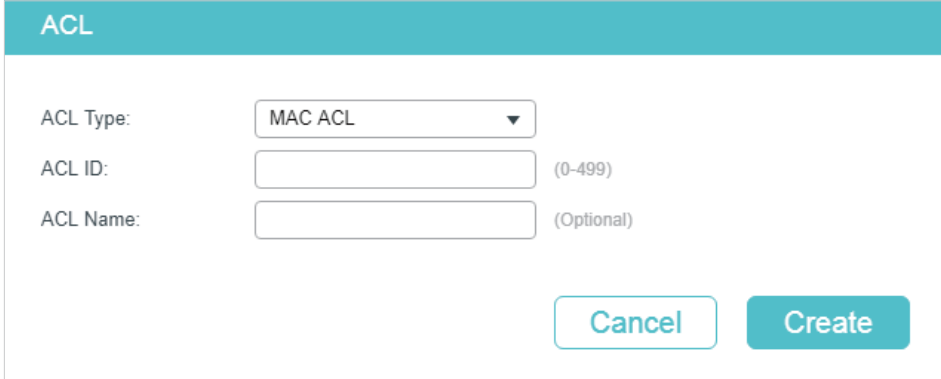
ACL ID:  (0-499)

ACL Name:  (Optional)

Follow these steps to create an ACL:

- 1) Choose one ACL type and enter a number to identify the ACL.
- 2) (Optional) Assign a name to the ACL.
- 3) Click **Create**.

 **Note:**

The supported ACL type and ID range varies on different switch models. Please refer to the on-screen information.

## 2.1.3 Configuring ACL Rules

The created ACL will be displayed on the **SECURITY > ACL > ACL Config** page.

Figure 2-2 Editing ACL

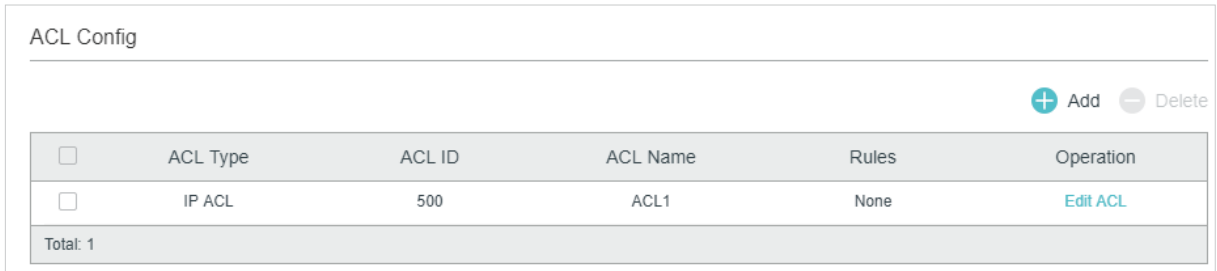

| ACL Config               |          |        |          |       |                          |
|--------------------------|----------|--------|----------|-------|--------------------------|
| <input type="checkbox"/> | ACL Type | ACL ID | ACL Name | Rules | Operation                |
| <input type="checkbox"/> | IP ACL   | 500    | ACL1     | None  | <a href="#">Edit ACL</a> |
| Total: 1                 |          |        |          |       |                          |

Click **Edit ACL** in the **Operation** column. Then you can configure rules for this ACL.





The following sections introduce how to configure MAC ACL, IP ACL, Combined ACL and IPv6 ACL.

### Configuring MAC ACL Rule

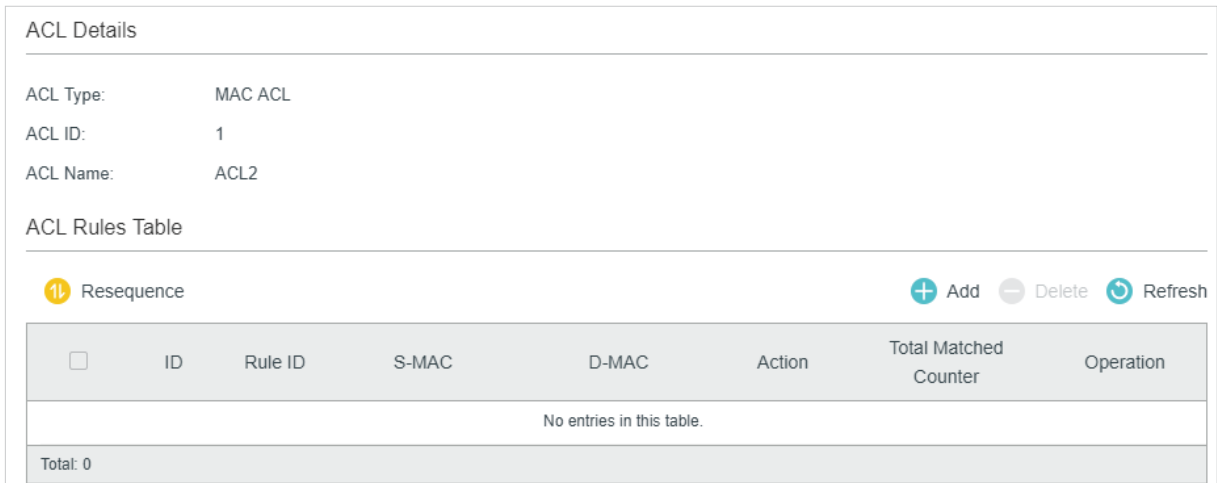
Click **Edit ACL** for a MAC ACL entry to load the following page.

Figure 2-3 Configuring the MAC ACL Rule



| ACL Details  |         |         |       |       |        |                       |   |  |   |
|--|---------|---------|-------|-------|--------|-----------------------|---|--|---|
| ACL Type:  | MAC ACL |         |       |       |        |                       |   |  |   |
| ACL ID:  | 1       |         |       |       |        |                       |   |  |   |
| ACL Name:  | ACL2    |         |       |       |        |                       |   |  |   |
| ACL Rules Table  |         |         |       |       |        |                       |   |  |   |
|  Resequencing |         |         |       |       |        |                       |  Add |  Delete |  Refresh |
| <input type="checkbox"/>   | ID      | Rule ID | S-MAC | D-MAC | Action | Total Matched Counter | Operation   |  |   |
| No entries in this table.  |         |         |       |       |        |                       |   |  |   |
| Total: 0   |         |         |       |       |        |                       |   |  |   |

In **ACL Rules Table** section, click  **Add** and the following page will appear.

Figure 2-4 Configuring the MAC ACL Rule

**MAC ACL Rule**

---

ACL ID: 1

ACL Name: ACL2

Rule ID:   Auto Assign

Operation: Permit ▼

S-MAC:  (Format: FF-FF-FF-FF-FF-FF)

Mask:  (Format: FF-FF-FF-FF-FF-FF)

D-MAC:  (Format: FF-FF-FF-FF-FF-FF)

Mask:  (Format: FF-FF-FF-FF-FF-FF)

VLAN ID:  (1-4094)

EtherType:  (4-hex number)

User Priority: Default ▼

Time Range:  ▼ (Optional)

Logging: Disable ▼

---

**Policy**

Mirroring

Redirect

Rate Limit

QoS Remark

Discard
Apply

Follow these steps to configure the MAC ACL rule:

1) In the **MAC ACL Rule** section, configure the following parameters:

|                   |  |
|-------------------|--|
| <b>Rule ID</b>    | <p>Enter an ID number to identify the rule.</p> <p>It should not be the same as any current rule ID in the same ACL. If you select Auto Assign, the rule ID will be assigned automatically and the interval between rule IDs is 5.</p> |
| <b>Operation</b>  | <p>Select an action to be taken when a packet matches the rule.</p> <p><b>Permit:</b> To forward the matched packets.</p> <p><b>Deny:</b> To discard the matched packets.</p>  |
| <b>S-MAC/Mask</b> | <p>Enter the source MAC address with a mask. A value of 1 in the mask indicates that the corresponding bit in the address will be matched.</p>   |
| <b>D-MAC/Mask</b> | <p>Enter the destination MAC address with a mask. A value of 1 in the mask indicates that the corresponding bit in the address will be matched.</p>  |
| <b>VLAN ID</b>    | <p>Enter the ID number of the VLAN to which the ACL will apply.</p>  |



|                      |  |
|----------------------|--|
| <b>EtherType</b>     | Specify the EtherType to be matched using 4 hexadecimal numbers.   |
| <b>User Priority</b> | Specify the User Priority to be matched.   |
| <b>Time Range</b>    | Select a time range during which the rule will take effect. The default value is No Limit, which means the rule is always in effect. The Time Range referenced here can be created on the <b>SYSTEM &gt; Time Range</b> page.                    |
| <b>Logging</b>       | Enable Logging function for the ACL rule. Then the times that the rule is matched will be logged every 5 minutes and a related trap will be generated. You can refer to Total Matched Counter in the ACL Rules Table to view the matching times. |

- In the **Policy** section, enable or disable the Mirroring feature for the matched packets. With this option enabled, choose a destination port to which the packets will be mirrored.

Figure 2-5 Configuring Mirroring

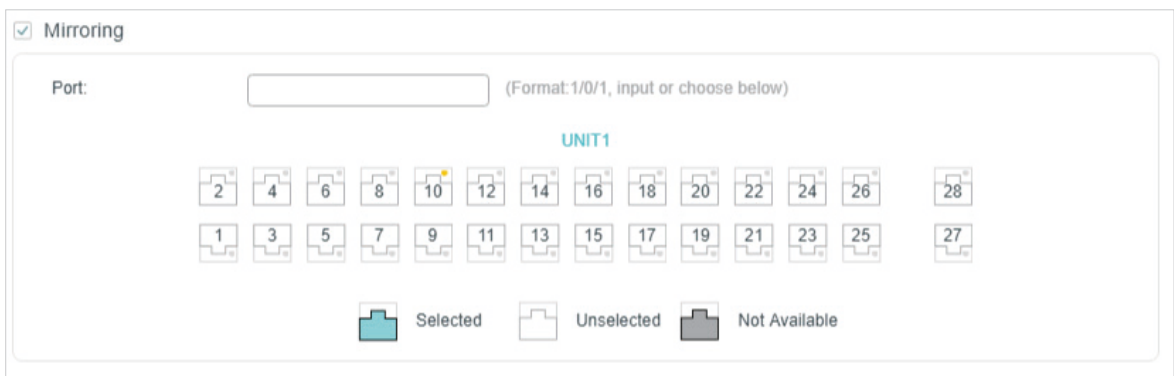

- In the **Policy** section, enable or disable the Redirect feature for the matched packets. With this option enabled, choose a destination port to which the packets will be redirected.

Figure 2-6 Configuring Redirect

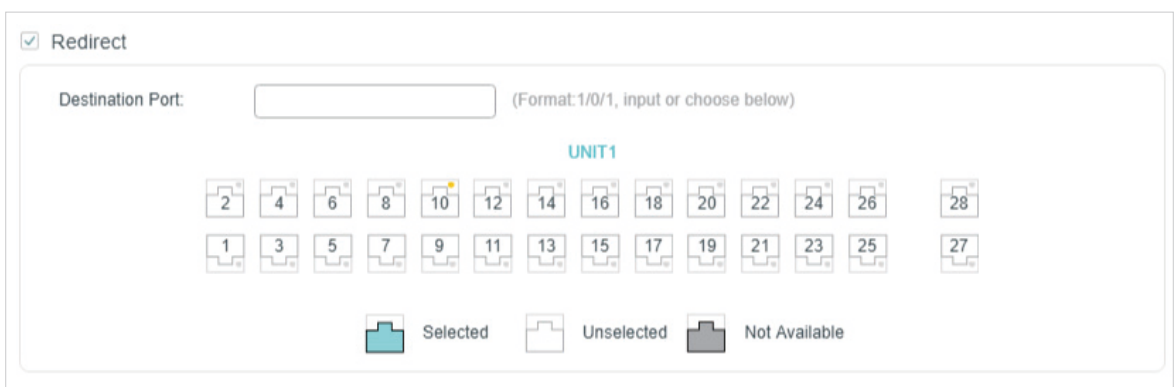

**Note:**

In the Mirroring feature, the matched packets will be copied to the destination port and the original forwarding will not be affected. While in the Redirect feature, the matched packets will be forwarded only on the destination port.

- In the **Policy** section, enable or disable the Rate Limit feature for the matched packets. With this option enabled, configure the related parameters.

Figure 2-7 Configuring Rate Limit

Rate Limit

Rate:  Kbps (1-10000000)

Burst Size:  KB (1-128)

Out of Band:

|                    |   |
|--------------------|---|
| <b>Rate</b>        | Specify the transmission rate for the matched packets.  |
| <b>Burst Size</b>  | Specify the maximum number of bytes allowed in one second.  |
| <b>Out of Band</b> | Select the action for the packets whose rate is beyond the specified rate.<br><b>None:</b> The packets will be forwarded normally.<br><b>Drop:</b> The packets will be discarded. |

- In the **Policy** section, enable or disable the QoS Remark feature for the matched packets. With this option enabled, configure the related parameters, and the remarked values will take effect in the QoS processing on the switch.

Figure 2-8 Configuring QoS Remark

QoS Remark

DSCP:

Local Priority:

802.1p Priority:

|                        |   |
|------------------------|---|
| <b>DSCP</b>            | Specify the DSCP field for the matched packets. The DSCP field of the packets will be changed to the specified one.           |
| <b>Local Priority</b>  | Specify the local priority for the matched packets. The local priority of the packets will be changed to the specified one.   |
| <b>802.1p Priority</b> | Specify the 802.1p priority for the matched packets. The 802.1p priority of the packets will be changed to the specified one. |

- Click **Apply**.

## Configuring IP ACL Rule

Click **Edit ACL** for an IP ACL entry to load the following page.

Figure 2-9 Configuring the IP ACL Rule





ACL Details

---

ACL Type: IP ACL  
ACL ID: 500  
ACL Name: ACL1

ACL Rules Table

---

 Resequence  Add  Delete  Refresh

| <input type="checkbox"/>  | ID | Rule ID | S-IP | D-IP | IP Protocol | Action | Total Matched Counter | Operation |
|---------------------------|----|---------|------|------|-------------|--------|-----------------------|-----------|
| No entries in this table. |    |         |      |      |             |        |                       |           |
| Total: 0                  |    |         |      |      |             |        |                       |           |

In **ACL Rules Table** section, click  **Add** and the following page will appear.

Figure 2-10 Configuring the IP ACL Rule

**IP ACL Rule**

---

ACL ID: 500

ACL Name: ACL1

Rule ID:   Auto Assign

Operation: Permit ▼

S-IP:  (Format: 192.168.0.1)

Mask:  (Format: 255.255.255.0)

D-IP:  (Format: 192.168.0.1)

Mask:  (Format: 255.255.255.0)

IP Protocol: No Limit ▼

DSCP: No Limit ▼

IP ToS:  (Optional, 0-15)

IP Pre:  (Optional, 0-7)

Time Range:  ▼ (Optional)

Logging: Disable ▼

---

**Policy**

Mirroring

Redirect

Rate Limit

QoS Remark

Discard
Apply

Follow these steps to configure the IP ACL rule:

1) In the **IP ACL Rule** section, configure the following parameters:

|                  |  |
|------------------|--|
| <b>Rule ID</b>   | <p>Enter an ID number to identify the rule.</p> <p>It should not be the same as any current rule ID in the same ACL. If you select Auto Assign, the rule ID will be assigned automatically and the interval between rule IDs is 5.</p> |
| <b>Operation</b> | <p>Select an action to be taken when a packet matches the rule.</p> <p><b>Permit:</b> To forward the matched packets.</p> <p><b>Deny:</b> To discard the matched packets.</p>  |
| <b>S-IP/Mask</b> | <p>Enter the source IP address with a mask. A value of 1 in the mask indicates that the corresponding bit in the address will be matched.</p>  |

|                 |   |
|-----------------|---|
| D-IP/Mask       | Enter the destination IP address with a mask. A value of 1 in the mask indicates that the corresponding bit in the address will be matched.   |
| IP Protocol     | Select a protocol type from the drop-down list. The default is No Limit, which indicates that packets of all protocols will be matched. You can also select User-defined to customize the IP protocol.  |
| TCP Flag        | <p>If TCP protocol is selected, you can configure the TCP Flag to be used for the rule's matching operations. There are six flags and each has three options, which are *, 0 and 1. The default is *, which indicates that the flag is not used for matching operations.</p> <p><b>URG:</b> Urgent flag.</p> <p><b>ACK:</b> Acknowledge flag.</p> <p><b>PSH:</b> Push flag.</p> <p><b>RST:</b> Reset flag.</p> <p><b>SYN:</b> Synchronize flag.</p> <p><b>FIN:</b> Finish flag.</p> |
| S-Port / D-Port | <p>If TCP/UDP is selected as the IP protocol, specify the source and destination port number with a mask.</p> <p><b>Value:</b> Specify the port number.</p> <p><b>Mask:</b> Specify the port mask with 4 hexadecimal numbers.</p>   |
| DSCP            | Specify a DSCP value to be matched between 0 and 63. The default is No Limit.   |
| IP ToS          | Specify an IP ToS value to be matched between 0 and 15. The default is No Limit.  |
| IP Pre          | Specify an IP Precedence value to be matched to be matched between 0 and 7. The default is No Limit.  |
| Time Range      | Select a time range during which the rule will take effect. The default value is No Limit, which means the rule is always in effect. The Time Range referenced here can be created on the <b>SYSTEM &gt; Time Range</b> page.   |
| Logging         | Enable Logging function for the ACL rule. Then the times that the rule is matched will be logged every 5 minutes and a related trap will be generated. You can refer to Total Matched Counter in the ACL Rules Table to view the matching times.  |

- 2) In the **Policy** section, enable or disable the Mirroring feature for the matched packets. With this option enabled, choose a destination port to which the packets will be mirrored.

Figure 2-11 Configuring Mirroring

- 3) In the **Policy** section, enable or disable the Redirect feature for the matched packets. With this option enabled, choose a destination port to which the packets will be redirected.

Figure 2-12 Configuring Redirect

**Note:**

In the Mirroring feature, the matched packets will be copied to the destination port and the original forwarding will not be affected. While in the Redirect feature, the matched packets will be forwarded only on the destination port.

- 4) In the **Policy** section, enable or disable the Rate Limit feature for the matched packets. With this option enabled, configure the related parameters.

Figure 2-13 Configuring Rate Limit

**Rate** Specify the transmission rate for the matched packets.

**Burst Size** Specify the maximum number of bytes allowed in one second.

**Out of Band** Select the action for the packets whose rate is beyond the specified rate.  
**None:** The packets will be forwarded normally.  
**Drop:** The packets will be discarded.

- In the **Policy** section, enable or disable the QoS Remark feature for the matched packets. With this option enabled, configure the related parameters, and the remarked values will take effect in the QoS processing on the switch.

Figure 2-14 Configuring QoS Remark

QoS Remark

DSCP: Default ▼

Local Priority: Default ▼

802.1p Priority: Default ▼

**DSCP** Specify the DSCP field for the matched packets. The DSCP field of the packets will be changed to the specified one.

**Local Priority** Specify the local priority for the matched packets. The local priority of the packets will be changed to the specified one.

**802.1p Priority** Specify the 802.1p priority for the matched packets. The 802.1p priority of the packets will be changed to the specified one.

- Click **Apply**.

### Configuring Combined ACL Rule

Click **Edit ACL** for a Combined ACL entry to load the following page.

Figure 2-15 Configuring the Combined ACL Rule

ACL Details

---

ACL Type: Combined ACL  
 ACL ID: 1000  
 ACL Name: ACL\_1000

ACL Rules Table

Resequence

 Add
 Delete
 Refresh

| <input type="checkbox"/>  | ID | Rule ID | S-MAC | D-MAC | S-IP | D-IP | VID | Action | Total Matched Counter | Operation |
|---------------------------|----|---------|-------|-------|------|------|-----|--------|-----------------------|-----------|
| No entries in this table. |    |         |       |       |      |      |     |        |                       |           |
| Total: 0                  |    |         |       |       |      |      |     |        |                       |           |

In **ACL Rules Table** section, click Add and the following page will appear.

Figure 2-16 Configuring the Combined ACL Rule

### Combined ACL Rule

---

ACL ID: 1000  
 ACL Name: ACL\_1000  
 Rule ID:   Auto Assign  
 Operation: Permit ▼

S-MAC:  (Format: FF-FF-FF-FF-FF-FF)  
 Mask:  (Format: FF-FF-FF-FF-FF-FF)  
 D-MAC:  (Format: FF-FF-FF-FF-FF-FF)  
 Mask:  (Format: FF-FF-FF-FF-FF-FF)  
 VLAN ID:  (1-4094)  
 EtherType:  (4-hex number)  
 S-IP:  (Format: 192.168.0.1)  
 Mask:  (Format: 255.255.255.0)  
 D-IP:  (Format: 192.168.0.1)  
 Mask:  (Format: 255.255.255.0)  
 IP Protocol: No Limit ▼  
 DSCP: No Limit ▼  
 IP ToS:  (Optional, 0-15)  
 IP Pre:  (Optional, 0-7)  
 User Priority: Default ▼  
 Time Range:   ▼ (Optional)  
 Logging: Disable ▼

---

Policy

Mirroring  
 Redirect  
 Rate Limit  
 QoS Remark

Discard
Apply

Follow these steps to configure the Combined ACL rule:

- 1) In the **Combined ACL Rule** section, configure the following parameters:

**Rule ID**

Enter an ID number to identify the rule.

It should not be the same as any current rule ID in the same ACL. If you select Auto Assign, the rule ID will be assigned automatically and the interval between rule IDs is 5.



|                 |   |
|-----------------|---|
| Operation       | <p>Select an action to be taken when a packet matches the rule.</p> <p><b>Permit:</b> To forward the matched packets.</p> <p><b>Deny:</b> To discard the matched packets.</p>   |
| S-MAC/Mask      | Enter the source MAC address with a mask. A value of 1 in the mask indicates that the corresponding bit in the address will be matched.   |
| D-MAC/Mask      | Enter the destination IP address with a mask. A value of 1 in the mask indicates that the corresponding bit in the address will be matched.   |
| VLAN ID         | Enter the ID number of the VLAN to which the ACL will apply.  |
| EtherType       | Specify the EtherType to be matched using 4 hexadecimal numbers.  |
| S-IP/Mask       | Enter the source IP address with a mask. A value of 1 in the mask indicates that the corresponding bit in the address will be matched.  |
| D-IP/Mask       | Enter the destination IP address with a mask. A value of 1 in the mask indicates that the corresponding bit in the address will be matched.   |
| IP Protocol     | Select a protocol type from the drop-down list. The default is No Limit, which indicates that packets of all protocols will be matched. You can also select User-defined to customize the IP protocol.  |
| TCP Flag        | <p>If TCP protocol is selected, you can configure the TCP Flag to be used for the rule's matching operations. There are six flags and each has three options, which are *, 0 and 1. The default is *, which indicates that the flag is not used for matching operations.</p> <p><b>URG:</b> Urgent flag.</p> <p><b>ACK:</b> Acknowledge flag.</p> <p><b>PSH:</b> Push flag.</p> <p><b>RST:</b> Reset flag.</p> <p><b>SYN:</b> Synchronize flag.</p> <p><b>FIN:</b> Finish flag.</p> |
| S-Port / D-Port | <p>If TCP/UDP is selected as the IP protocol, specify the source and destination port number with a mask.</p> <p><b>Value:</b> Specify the port number.</p> <p><b>Mask:</b> Specify the port mask with 4 hexadecimal numbers.</p>   |
| DSCP            | Specify a DSCP value to be matched between 0 and 63. The default is No Limit.   |
| IP ToS          | Specify an IP ToS value to be matched between 0 and 15. The default is No Limit.  |
| IP Pre          | Specify an IP Precedence value to be matched to be matched between 0 and 7. The default is No Limit.  |

|                      |  |
|----------------------|--|
| <b>User Priority</b> | Specify the User Priority to be matched.   |
| <b>Time Range</b>    | Select a time range during which the rule will take effect. The default value is No Limit, which means the rule is always in effect. The Time Range referenced here can be created on the <b>SYSTEM &gt; Time Range</b> page.                    |
| <b>Logging</b>       | Enable Logging function for the ACL rule. Then the times that the rule is matched will be logged every 5 minutes and a related trap will be generated. You can refer to Total Matched Counter in the ACL Rules Table to view the matching times. |

- 2) In the **Policy** section, enable or disable the Mirroring feature for the matched packets. With this option enabled, choose a destination port to which the packets will be mirrored.

Figure 2-17 Configuring Mirroring

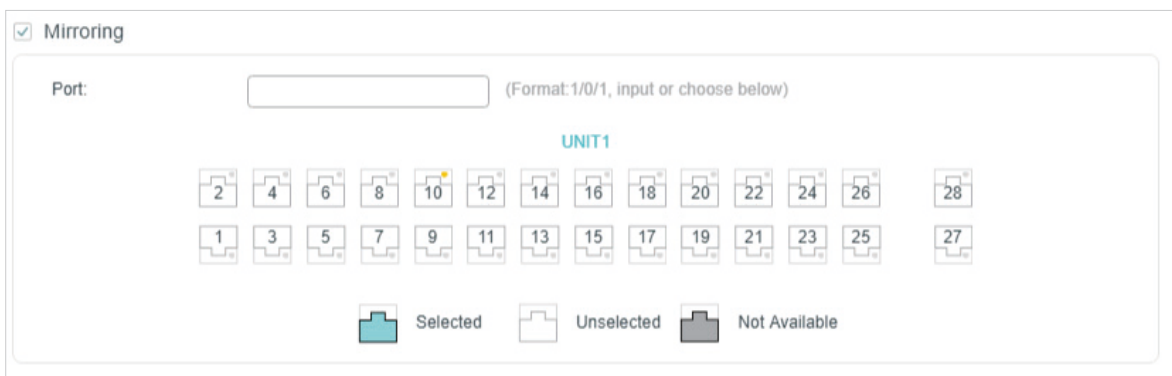

- 3) In the **Policy** section, enable or disable the Redirect feature for the matched packets. With this option enabled, choose a destination port to which the packets will be redirected.

Figure 2-18 Configuring Redirect

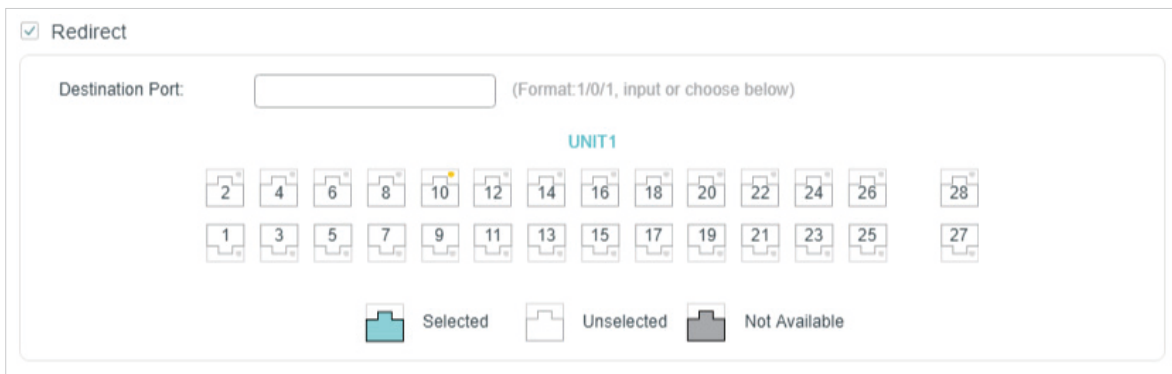

**Note:**

In the Mirroring feature, the matched packets will be copied to the destination port and the original forwarding will not be affected. While in the Redirect feature, the matched packets will be forwarded only on the destination port.

- 4) In the **Policy** section, enable or disable the Rate Limit feature for the matched packets. With this option enabled, configure the related parameters.

Figure 2-19 Configuring Rate Limit

Rate Limit

Rate:  Kbps (1-10000000)

Burst Size:  KB (1-128)

Out of Band:

|                    |  |
|--------------------|--|
| <b>Rate</b>        | Specify the transmission rate for the matched packets.   |
| <b>Burst Size</b>  | Specify the maximum number of bytes allowed in one second.   |
| <b>Out of Band</b> | <p>Select the action for the packets whose rate is beyond the specified rate.</p> <p><b>None:</b> The packets will be forwarded normally.</p> <p><b>Drop:</b> The packets will be discarded.</p> |

- 5) In the **Policy** section, enable or disable the QoS Remark feature for the matched packets. With this option enabled, configure the related parameters, and the remarked values will take effect in the QoS processing on the switch.

Figure 2-20 Configuring QoS Remark

QoS Remark

DSCP:

Local Priority:

802.1p Priority:

|                        |   |
|------------------------|---|
| <b>DSCP</b>            | Specify the DSCP field for the matched packets. The DSCP field of the packets will be changed to the specified one.           |
| <b>Local Priority</b>  | Specify the local priority for the matched packets. The local priority of the packets will be changed to the specified one.   |
| <b>802.1p Priority</b> | Specify the 802.1p priority for the matched packets. The 802.1p priority of the packets will be changed to the specified one. |

- 6) Click **Apply**.

## Configuring the IPv6 ACL Rule

Click **Edit ACL** for an IPv6 ACL entry to load the following page.

Figure 2-21 Configuring the IPv6 ACL Rule

**ACL Details**

---

ACL Type: IPv6 ACL  
 ACL ID: 1500  
 ACL Name: ACL\_1500

**ACL Rules Table**

---

Resequence

 Add
 Delete
 Refresh

| <input type="checkbox"/>  | ID | Rule ID | IPv6 Source IP | IPv6 Destination IP | Action | Total Matched Counter | Operation |
|---------------------------|----|---------|----------------|---------------------|--------|-----------------------|-----------|
| No entries in this table. |    |         |                |                     |        |                       |           |
| Total: 0                  |    |         |                |                     |        |                       |           |

In **ACL Rules Table** section, click **Add** and the following page will appear.

Figure 2-22 Configuring the IPv6 ACL Rule

**IPv6 ACL Rule**

---

ACL ID: 1500  
 ACL Name: ACL\_1500

Rule ID:   Auto Assign

Operation: Permit ▼

IPv6 Class:  (0-63)

Flow Label:  (5-hex number: 0x00000-0xFFFFF)

IPv6 Source IP:  (Format: 2001::)  
 Mask:  (Format: FFFF:FFFF:FFFF:FFFF)

IPv6 Destination IP:  (Format: 2001::)  
 Mask:  (Format: FFFF:FFFF:FFFF:FFFF)

IP Protocol: No Limit ▼

Time Range:  ▼ (Optional)

---

**Policy**

Mirroring

Redirect

Rate Limit

QoS Remark

Discard
Apply

Follow these steps to configure the IPv6 ACL rule:

1) In the **IPv6 ACL Rule** section, configure the following parameters:

|                     |  |
|---------------------|--|
| Rule ID             | <p>Enter an ID number to identify the rule.</p> <p>It should not be the same as any current rule ID in the same ACL. If you select Auto Assign, the rule ID will be assigned automatically and the interval between rule IDs is 5.</p>   |
| Operation           | <p>Select an action to be taken when a packet matches the rule.</p> <p><b>Permit:</b> To forward the matched packets.</p> <p><b>Deny:</b> To discard the matched packets.</p>  |
| IPv6 Class          | <p>Specify an IPv6 class value to be matched. The switch will check the class field of the IPv6 header.</p>  |
| Flow Label          | <p>Specify a Flow Label value to be matched.</p>   |
| IPv6 Source IP      | <p>Enter the source IPv6 address to be matched. All types of IPv6 address will be checked. You may enter a complete 128-bit IPv6 address but only the first 64 bits will be valid.</p>   |
| Mask                | <p>The mask is required if the source IPv6 address is entered. Enter the mask in complete format (for example, FFFF:FFFF:0000:FFFF).</p> <p>The IP address mask specifies which bits in the source IPv6 address to match the rule. A value of 1 in the mask indicates that the corresponding bit in the address will be matched.</p>   |
| IPv6 Destination IP | <p>Enter the destination IPv6 address to be matched. All types of IPv6 address will be checked. You may enter a complete 128-bit IPv6 address but only the first 64 bits will be valid.</p>  |
| Mask                | <p>The mask is required if the destination IPv6 address is entered. Enter the complete mask (for example, FFFF:FFFF:0000:FFFF).</p> <p>The IP address mask specifies which bits in the source IP address to match the rule. A value of 1 in the mask indicates that the corresponding bit in the address will be matched.</p>  |
| IP Protocol         | <p>Select a protocol type from the drop-down list.</p> <p><b>No Limit:</b> Packets of all protocols will be matched.</p> <p><b>UDP:</b> Specify the source port and destination port for the UDP packet to be matched.</p> <p><b>TCP:</b> Specify the source port and destination port for the TCP packet to be matched.</p> <p><b>User-defined:</b> You can customize an IP protocol.</p> |
| S-Port / D-Port     | <p>If TCP/UDP is selected as the IP protocol, specify the source and destination port numbers.</p>   |
| Time Range          | <p>Select a time range during which the rule will take effect. The default value is No Limit, which means the rule is always in effect. The Time Range referenced here can be created on the <b>SYSTEM &gt; Time Range</b> page.</p>   |

- 2) In the **Policy** section, enable or disable the Mirroring feature for the matched packets. With this option enabled, choose a destination port to which the packets will be mirrored.

Figure 2-23 Configuring Mirroring

The screenshot shows the configuration interface for the Mirroring feature. At the top, the 'Mirroring' checkbox is checked. Below it is a 'Port:' input field with a placeholder '(Format: 1/0/1, input or choose below)'. Underneath the input field is a grid of port selection buttons labeled 'UNIT1'. The buttons are arranged in two rows: the first row contains ports 2, 4, 6, 8, 10, 12, 14, 16, 18, 20, 22, 24, 26, and 28; the second row contains ports 1, 3, 5, 7, 9, 11, 13, 15, 17, 19, 21, 23, 25, and 27. Port 10 is highlighted with a blue border and a small yellow star, indicating it is selected. Below the grid are three legend items: a blue square labeled 'Selected', a white square labeled 'Unselected', and a grey square labeled 'Not Available'.

- 3) In the **Policy** section, enable or disable the Redirect feature for the matched packets. With this option enabled, choose a destination port to which the packets will be redirected.

Figure 2-24 Configuring Redirect

The screenshot shows the configuration interface for the Redirect feature. At the top, the 'Redirect' checkbox is checked. Below it is a 'Destination Port:' input field with a placeholder '(Format: 1/0/1, input or choose below)'. Underneath the input field is a grid of port selection buttons labeled 'UNIT1'. The buttons are arranged in two rows: the first row contains ports 2, 4, 6, 8, 10, 12, 14, 16, 18, 20, 22, 24, 26, and 28; the second row contains ports 1, 3, 5, 7, 9, 11, 13, 15, 17, 19, 21, 23, 25, and 27. Port 10 is highlighted with a blue border and a small yellow star, indicating it is selected. Below the grid are three legend items: a blue square labeled 'Selected', a white square labeled 'Unselected', and a grey square labeled 'Not Available'.

**Note:**

In the Mirroring feature, the matched packets will be copied to the destination port and the original forwarding will not be affected. While in the Redirect feature, the matched packets will be forwarded only on the destination port.

- 4) In the **Policy** section, enable or disable the Rate Limit feature for the matched packets. With this option enabled, configure the related parameters.

Figure 2-25 Configuring Rate Limit

The screenshot shows the configuration interface for the Rate Limit feature. At the top, the 'Rate Limit' checkbox is checked. Below it are three configuration fields: 'Rate:' with an input field and the unit 'Kbps (1-10000000)'; 'Burst Size:' with an input field and the unit 'KB (1-128)'; and 'Out of Band:' with a dropdown menu.

**Rate** Specify the transmission rate for the matched packets.

|                    |   |
|--------------------|---|
| <b>Burst Size</b>  | Specify the number of bytes allowed in one second.  |
| <b>Out of Band</b> | Select the action for the packets whose rate is beyond the specified rate.<br><b>None:</b> The packets will be forwarded normally.<br><b>Drop:</b> The packets will be discarded. |

- In the **Policy** section, enable or disable the QoS Remark feature for the matched packets. With this option enabled, configure the related parameters, and the remarked values will take effect in the QoS processing on the switch.

Figure 2-26 Configuring QoS Remark

QoS Remark

DSCP: Default ▼

Local Priority: Default ▼

802.1p Priority: Default ▼

|                        |   |
|------------------------|---|
| <b>DSCP</b>            | Specify the DSCP field for the matched packets. The DSCP field of the packets will be changed to the specified one.           |
| <b>Local Priority</b>  | Specify the local priority for the matched packets. The local priority of the packets will be changed to the specified one.   |
| <b>802.1p Priority</b> | Specify the 802.1p priority for the matched packets. The 802.1p priority of the packets will be changed to the specified one. |

- Click **Apply**.

## Viewing the ACL Rules

The rules in an ACL are listed in ascending order of their rule IDs. The switch matches a received packet with the rules in order. When a packet matches a rule, the switch stops the match process and performs the action defined in the rule.

Click **Edit ACL** for an entry you have created and you can view the rule table. We take IP ACL rules table for example.

Figure 2-27 Viewing ACL Rules Table

ACL Rules Table

Resequenece

 Add
 Delete
 Refresh

| <input type="checkbox"/> | ID | Rule ID | S-IP        | D-IP        | IP Protocol | Action | Total Matched Counter | Operation |  |
|--------------------------|----|---------|-------------|-------------|-------------|--------|-----------------------|-----------|--|
| <input type="checkbox"/> | 1  | 1       | 192.168.1.0 | 192.168.5.0 |             | Permit | 0                     |           |  |
| <input type="checkbox"/> | 2  | 3       | 192.168.7.0 |             |             | Permit | 0                     |           |  |
| <input type="checkbox"/> | 3  | 5       | 192.168.0.0 |             |             | Deny   | 0                     |           |  |
| Total: 3                 |    |         |             |             |             |        |                       |           |  |

Here you can view and edit the ACL rules. You can also click **Resequence** to resequence the rules by providing a Start Rule ID and Step value.

## 2.1.4 Configuring ACL Binding

You can bind the ACL to a port or a VLAN. The received packets on the port or in the VLAN will then be matched and processed according to the ACL rules. An ACL takes effect only after it is bound to a port or VLAN.

### Note:

- Different types of ACLs cannot be bound to the same port or VLAN.
- Multiple ACLs of the same type can be bound to the same port or VLAN. The switch matches the received packets using the ACLs in order. The ACL that is bound earlier has a higher priority.

### ■ Binding the ACL to a Port

Choose the menu **SECURITY > ACL > ACL Binding > Port Binding** and click  **Add** to load the following page.

Figure 2-28 Binding the ACL to a Port

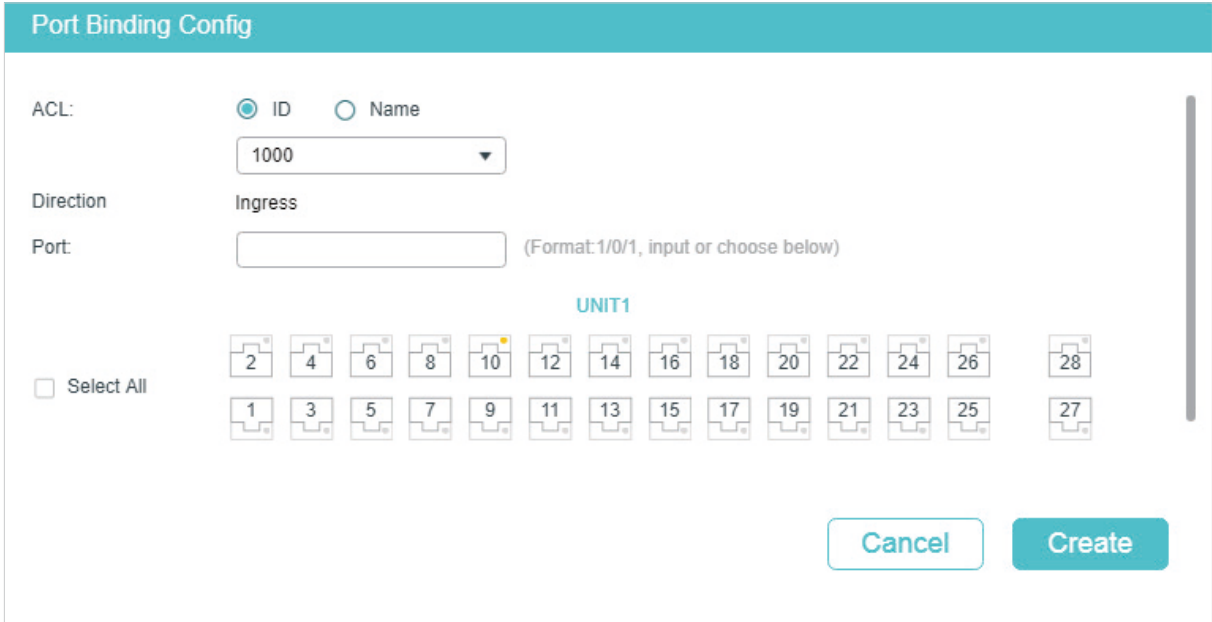

**Port Binding Config**

ACL:  ID  Name  
 1000

Direction: Ingress

Port:  (Format: 1/0/1, input or choose below)

Select All

UNIT1

2 4 6 8 10 12 14 16 18 20 22 24 26 28  
 1 3 5 7 9 11 13 15 17 19 21 23 25 27

Cancel Create

Follow these steps to bind the ACL to a Port:

- 1) Choose ID or Name to be used for matching the ACL. Then select an ACL from the drop-down list.
- 2) Specify the port to be bound.
- 3) Click **Create**.



### ■ Binding the ACL to a VLAN

Choose the menu **SECURITY > ACL > ACL Binding > VLAN Binding** to load the following page.

Figure 2-29 Binding the ACL to a VLAN

Follow these steps to bind the ACL to a VLAN:

- 1) Choose ID or Name to be used for matching the ACL. Then select an ACL from the drop-down list.
- 2) Enter the ID of the VLAN to be bound.
- 3) Click **Create**.

## 2.2 Using the CLI

### 2.2.1 Configuring Time Range

Some ACL-based services or features may need to be limited to take effect only during a specified time period. In this case, you can configure a time range for the ACL. For details about Time Range Configuration, please refer to [Managing System](#).

### 2.2.2 Configuring ACL

Follow the steps to create different types of ACL and configure the ACL rules.

You can define the rules based on source or destination IP address, source or destination MAC address, protocol type, port number and others.

#### ■ MAC ACL

- 
- Step 1     **configure**  
Enter global configuration mode.
-

---

**Step 2** **access-list create** *acl-id* [**name** *acl-name*]

Create a MAC ACL.

*acl-id*: Enter an ACL ID. The ID ranges from 0 to 499.

*acl-name*: Enter a name to identify the ACL.

---

**Step 3** **access-list mac** *acl-id-or-name* **rule** { *auto* | *rule-id* } { *deny* | *permit* } **logging** { *enable* | *disable* } [**smac** *source-mac* **smask** *source-mac-mask* ] [**dmac** *destination-mac* **dmask** *destination-mac-mask* ] [**type** *ether-type*] [**pri** *dot1p-priority*] [**vid** *vlan-id*] [**tseg** *time-range-name*]

Add a MAC ACL Rule.

*acl-id-or-name*: Enter the ID or name of the ACL that you want to add a rule for.

*auto*: The rule ID will be assigned automatically and the interval between rule IDs is 5.

*rule-id*: Assign an ID to the rule.

*deny* | *permit*: Specify the action to be taken with the packets that match the rule. By default, it is set to permit. The packets will be discarded if "deny" is selected and forwarded if "permit" is selected.

**logging** { *enable* | *disable* }: Enable or disable Logging function for the ACL rule. If "enable" is selected, the times that the rule is matched will be logged every 5 minutes. With ACL Counter trap enabled, a related trap will be generated if the matching times changes.

*source-mac*: Enter the source MAC address. The format is FF:FF:FF:FF:FF:FF.

*source-mac-mask*: Enter the mask of the source MAC address. This is required if a source MAC address is entered. The format is FF:FF:FF:FF:FF:FF.

*destination-mac*: Enter the destination MAC address. The format is FF:FF:FF:FF:FF:FF.

*destination-mac-mask*: Enter the mask of the destination MAC address. This is required if a destination MAC address is entered. The format is FF:FF:FF:FF:FF:FF.

*ether-type*: Specify an Ethernet-type with 4 hexadecimal numbers.

*dot1p-priority*: The user priority ranges from 0 to 7. The default is No Limit.

*vlan-id*: The VLAN ID ranges from 1 to 4094.

*time-range-name*: The name of the time-range. The default is No Limit.

---

**Step 4** **exit**

Return to global configuration mode.

---

**Step 5** **show access-list** [*acl-id-or-name* ]

Display the current ACL configuration.

*acl-id-or-name*: The ID number or name of the ACL.

---

**Step 6** **end**

Return to privileged EXEC mode.

---

---

**Step 7**     **copy running-config startup-config**

Save the settings in the configuration file.

---

The following example shows how to create MAC ACL 50 and configure Rule 5 to permit packets with source MAC address 00:34:A2:D4:34:B5:

**Switch#configure**

**Switch(config)#access-list create 50**

**Switch(config-mac-acl)#access-list mac 50 rule 5 permit logging disable smac 00:34:A2:D4:34:B5 smask FF:FF:FF:FF:FF:FF**

**Switch(config-mac-acl)#exit**

**Switch(config)#show access-list 50**

MAC access list 50 name: ACL\_50

rule 5 permit logging disable smac 00:34:a2:d4:34:b5 smask ff:ff:ff:ff:ff:ff

**Switch(config)#end**

**Switch#copy running-config startup-config**

## ■ IP ACL

---

**Step 1**     **configure**

Enter global configuration mode.

---

**Step 2**     **access-list create acl-id [name acl-name]**

Create an IP ACL.

*acl-id*: Enter an ACL ID. The ID ranges from 500 to 999.

*acl-name*: Enter a name to identify the ACL.

---

- 
- Step 3 **access-list ip** *acl-id-or-name* **rule** {auto | *rule-id* } {deny | permit} **logging** {enable | disable} [**sip** *sip-address* **sip-mask** *sip-address-mask* ] [ **dip** *dip-address* **dip-mask** *dip-address-mask* ] [**dscp** *dscp-value*] [**tos** *tos-value*] [**pre** *pre-value*] [**protocol** *protocol*] [**s-port** *s-port-number* **s-port-mask** *s-port-mask*] [**d-port** *d-port-number* **d-port-mask** *d-port-mask*] [**tcpflag** *tcpflag*] [**tseg** *time-range-name*]
- Add rules to the ACL.
- acl-id-or-name*: Enter the ID or name of the ACL that you want to add a rule for.
- auto*: The rule ID will be assigned automatically and the interval between rule IDs is 5.
- rule-id*: Assign an ID to the rule.
- deny | permit**: Specify the action to be taken with the packets that match the rule. Deny means to discard; permit means to forward. By default, it is set to permit.
- logging** {enable | disable}: Enable or disable Logging function for the ACL rule. If "enable" is selected, the times that the rule is matched will be logged every 5 minutes. With ACL Counter trap enabled, a related trap will be generated if the matching times changes.
- sip-address*: Enter the source IP address.
- sip-address-mask*: Enter the mask of the source IP address. This is required if a source IP address is entered.
- dip-address*: Enter the destination IP address.
- dip-address-mask*: Enter the mask of the destination IP address. This is required if a destination IP address is entered.
- dscp-value*: Specify the DSCP value between 0 and 63.
- tos-value*: Specify an IP ToS value to be matched between 0 and 15.
- pre-value*: Specify an IP Precedence value to be matched between 0 and 7.
- protocol*: Specify a protocol number between 0 and 255.
- s-port-number*: With TCP or UDP configured as the protocol, specify the source port number.
- s-port-mask*: With TCP or UDP configured as the protocol, specify the source port mask with 4 hexadecimal numbers.
- d-port-number*: With TCP or UDP configured as the protocol, specify the destination port number.
- d-port-mask*: With TCP or UDP configured as the protocol, specify the destination port mask with 4 hexadecimal numbers.
- tcpflag*: With TCP configured as the protocol, specify the flag value using either binary numbers or \* (for example, 01\*010\*). The default is \*, which indicates that the flag will not be matched.
- The flags are URG (Urgent flag), ACK (Acknowledge Flag), PSH (Push Flag), RST (Reset Flag), SYN (Synchronize Flag) and FIN (Finish Flag).
- time-range-name*: The name of the time-range. The default is No Limit.
- 

- Step 4 **end**
- Return to privileged EXEC mode.
-

---

**Step 5** **copy running-config startup-config**

Save the settings in the configuration file.

---

The following example shows how to create IP ACL 600, and configure Rule 1 to permit packets with source IP address 192.168.1.100:

**Switch#configure**

**Switch(config)#access-list create 600**

**Switch(config)#access-list ip 600 rule 1 permit logging disable sip 192.168.1.100 sip-mask 255.255.255.255**

**Switch(config)#show access-list 600**

IP access list 600 name: ACL\_600

rule 1 permit logging disable sip 192.168.1.100 smask 255.255.255.255

**Switch(config)#end**

**Switch#copy running-config startup-config**

## ■ Combined ACL

---

**Step 1** **configure**

Enter global configuration mode

---

**Step 2** **access-list create acl-id [name acl-name]**

Create a Combined ACL.

*acl-id*: Enter an ACL ID. The ID ranges from 1000 to 1499.

*acl-name*: Enter a name to identify the ACL.

---

---

Step 3 **access-list combined** *acl-id-or-name* **rule** {auto | *rule-id* } {deny | permit} **logging** {enable | disable} [**smac** *source-mac-address* **smask** *source-mac-mask*] [**dmac** *dest-mac-address* **dmask** *dest-mac-mask*] [**vid** *vlan-id*] [**type** *ether-type*] [**pri** *priority*] [**sip** *sip-address* **sip-mask** *sip-address-mask*] [**dip** *dip-address* **dip-mask** *dip-address-mask*] [**dscp** *dscp-value*] [**tos** *tos-value*] [**pre** *pre-value*] [**protocol** *protocol*] [**s-port** *s-port-number* **s-port-mask** *s-port-mask*] [**d-port** *d-port-number* **d-port-mask** *d-port-mask*] [**tcpflag** *tcpflag*] [**tseg** *time-range-name*]

Add rules to the ACL.

*acl-id-or-name*: Enter the ID or name of the ACL that you want to add a rule for.

*auto*: The rule ID will be assigned automatically and the interval between rule IDs is 5.

*rule-id*: Assign an ID to the rule.

*deny* | *permit*: Specify the action to be taken with the packets that match the rule. Deny means to discard; permit means to forward. By default, it is set to permit.

**logging** {*enable* | *disable*}: Enable or disable Logging function for the ACL rule. If "enable" is selected, the times that the rule is matched will be logged every 5 minutes. With ACL Counter trap enabled, a related trap will be generated if the matching times changes.

*source-mac-address*: Enter the source MAC address.

*source-mac-mask*: Enter the source MAC address mask.

*dest-mac-address*: Enter the destination MAC address.

*dest-mac-mask*: Enter the destination MAC address mask. This is required if a destination MAC address is entered.

*vlan-id*: The VLAN ID ranges from 1 to 4094.

*ether-type*: Specify the Ethernet-type with 4 hexadecimal numbers.

*priority*: The user priority ranges from 0 to 7. The default is No Limit.

*sip-address*: Enter the source IP address.

*sip-address-mask*: Enter the mask of the source IP address. It is required if source IP address is entered.

*dip-address*: This is required if a source IP address is entered.

*dip-address-mask*: Enter the destination IP address mask. This is required if a destination IP address is entered.

*dscp-value*: Specify the DSCP value between 0 and 63.

*tos-value*: Specify an IP ToS value to be matched between 0 and 15.

*pre-value*: Specify an IP Precedence value to be matched between 0 and 7.

---

*protocol*: Specify a protocol number between 0 and 255.

*s-port-number*: With TCP or UDP configured as the protocol, specify the source port number.

*s-port-mask*: With TCP or UDP configured as the protocol, specify the source port mask with 4 hexadecimal numbers.

*d-port-number*: With TCP or UDP configured as the protocol, specify the destination port number.

*d-port-mask*: With TCP or UDP configured as the protocol, specify the destination port mask with 4 hexadecimal numbers.

*tcpflag*: With TCP configured as the protocol, specify the flag value using either binary numbers or \* (for example, 01\*010\*). The default is \*, which indicates that the flag will not be matched.

The flags are URG (Urgent flag), ACK (Acknowledge Flag), PSH (Push Flag), RST (Reset Flag), SYN (Synchronize Flag), and FIN (Finish Flag).

*time-range-name*: The name of the time-range. The default is No Limit.

---

Step 4     **end**

Return to privileged EXEC mode.

---

Step 5     **copy running-config startup-config**

Save the settings in the configuration file.

---

The following example shows how to create Combined ACL 1100 and configure Rule 1 to deny packets with source IP address 192.168.3.100 in VLAN 2:

### Switch#configure

**Switch(config)#access-list create 1100**

**Switch(config)#access-list combined 1100 logging disable rule 1 permit vid 2 sip 192.168.3.100 sip-mask 255.255.255.255**

**Switch(config)#show access-list 2600**

Combined access list 2600 name: ACL\_2600

rule 1 permit logging disable vid 2 sip 192.168.3.100 sip-mask 255.255.255.255

**Switch(config)#end**

**Switch#copy running-config startup-config**

## ■ IPv6 ACL

---

Step 1     **configure**

Enter global configuration mode

---

---

**Step 2** **access-list create** *acl-id* [**name** *acl-name*]

Create an IPv6 ACL.

*acl-id*: Enter an ACL ID. The ID ranges from 1500 to 1999.

*acl-name*: Enter a name to identify the ACL.

---

**Step 3** **access-list ipv6** *acl-id-or-name* **rule** {*auto* | *rule-id*} {*deny* | *permit*} **logging** {*enable* | *disable*} [**class** *class-value*] [**flow-label** *flow-label-value*] [**sip** *source-ip-address* **sip-mask** *source-ip-mask*] [**dip** *destination-ip-address* **dip-mask** *destination-ip-mask*] [**s-port** *source-port-number*] [**d-port** *destination-port-number*] [**tseg** *time-range-name*]

Add rules to the ACL.

*acl-id-or-name*: Enter the ID or name of the ACL that you want to add a rule for.

*auto*: The rule ID will be assigned automatically and the interval between rule IDs is 5.

*rule-id*: Assign an ID to the rule.

*deny* | *permit*: Specify the action to be taken with the packets that match the rule. Deny means to discard; permit means to forward. By default, it is set to permit.

**logging** {*enable* | *disable*}: Enable or disable Logging function for the ACL rule. If "enable" is selected, the times that the rule is matched will be logged every 5 minutes. With ACL Counter trap enabled, a related trap will be generated if the matching times changes.

*class-value*: Specify a class value to be matched. It ranges from 0 to 63.

*flow-label-value*: Specify a Flow Label value to be matched.

*source-ip-address*: Enter the source IP address. Enter the destination IPv6 address to be matched. All types of IPv6 address will be checked. You may enter a complete 128-bit IPv6 address but only the first 64 bits will be valid.

*source-ip-mask*: Enter the source IP address mask. The mask is required if the source IPv6 address is entered. Enter the mask in complete format (for example, ffff:fff:0000:fff). The mask specifies which bits in the source IPv6 address to match the rule.

*destination-ip-address*: Enter the destination IPv6 address to be matched. All types of IPv6 address will be checked. You may enter a complete 128-bit IPv6 addresses but only the first 64 bits will be valid.

*destination-ip-mask*: Enter the source IP address mask. The mask is required if the source IPv6 address is entered. Enter the mask in complete format (for example, ffff:fff:0000:fff). The mask specifies which bits in the source IPv6 address to match the rule.

*source-port-number*: Enter the TCP/UDP source port if TCP/UDP protocol is selected.

*destination-port-number*: Enter the TCP/UDP destination port if TCP/UDP protocol is selected.

*time-range-name*: The name of the time-range. The default is No Limit.

---

**Step 4** **end**

Return to privileged EXEC mode.

---

**Step 5** **copy running-config startup-config**

Save the settings in the configuration file.

---



The following example shows how to create IPv6 ACL 1600 and configure Rule 1 to deny packets with source IPv6 address CDCD:910A:2222:5498:8475:1111:3900:2020:

**Switch#configure**

**Switch(config)#access-list create 1600**

**Switch(config)#access-list ipv6 1600 rule 1 deny logging disable sip CDCD:910A:2222:5498:8475:1111:3900:2020 sip-mask ffff:ffff:ffff:ffff**

**Switch(config)#show access-list 1600**

IPv6 access list 1600 name: ACL\_1600

rule 1 deny logging disable sip cdc:910a:2222:5498:8475:1111:3900:2020 sip-mask ffff:ffff:ffff:ffff

**Switch(config)#end**

**Switch#copy running-config startup-config**

## Resequencing Rules

You can resequence the rules by providing a Start Rule ID and Step value.

|        |  |
|--------|--|
| Step 1 | <b>configure</b><br>Enter global configuration mode.   |
| Step 2 | <b>access-list resequence</b> <i>acl-id-or-name</i> <b>start</b> <i>start-rule-id</i> <b>step</b> <i>rule-id-step-value</i><br>Resequencing the rules of the specific ACL.<br><i>acl-id-or-name</i> : Enter the ID or name of the ACL.<br><i>start-rule-id</i> : Enter the start rule ID.<br><i>rule-id-step-value</i> : Enter the Step value. |
| Step 3 | <b>end</b><br>Return to privileged EXEC mode.  |
| Step 4 | <b>copy running-config startup-config</b><br>Save the settings in the configuration file.  |

The following example shows how to resequence the rules of MAC ACL 100: set the start rule ID as 1 and the step value as 10:

**Switch#configure**

**Switch(config)#access-list resequence 100 start 1 step 10**

**Switch(config)#show access-list 100**

MAC access list 100 name: "ACL\_100"

rule 1 deny logging disable smac aa:bb:cc:dd:ee:ff smask ff:ff:ff:ff:ff:ff

```
rule 11 permit logging disable vid 18
```

```
rule 21 permit logging disable dmac aa:cc:ee:ff:dd:33 dmask ff:ff:ff:ff:ff:ff
```

```
Switch(config)#end
```

```
Switch#copy running-config startup-config
```

## 2.2.3 Configuring Policy

Policy allows you to further process the matched packets through operations such as mirroring, rate-limiting, redirecting, or changing priority.

Follow the steps below to configure the policy actions for an ACL rule.

---

Step 1     **configure**

Enter global configuration mode.

---

Step 2     **access-list action *acl-id-or-name* rule *rule-id***

Configure the policy actions for an ACL rule.

*acl-id-or-name*: Enter the ID or name of the ACL.

*rule-id*: Enter the ID of the ACL rule.

---

---

Step 3 **redirect interface { fastEthernet port | gigabitEthernet port | ten-gigabitEthernet port }**

(Optional) Define the policy to redirect the matched packets to the desired port.

*port*: The destination port to which the packets will be redirected. The default is All.

**s-mirror interface { fastEthernet port | gigabitEthernet port | ten-gigabitEthernet port }**

(Optional) Define the policy to mirror the matched packets to the desired port.

*port*: The destination port to which the packets will be mirrored.

**s-condition rate rate burst burst-size osd { none | discard }**

(Optional) Define the policy to monitor the rate of the matched packets.

*rate*: Specify a rate from 1 to 1000000 kbps.

*burst-size*: Specify the number of bytes allowed in one second ranging from 1 to 128.

*osd*: Enter either "none" or "discard" as the action to be taken for the packets whose rate is beyond the specified rate. The default is None.

**qos-remark [dscp dscp] [ priority pri ] [ dot1p pri ]**

(Optional) Define the policy to remark priority for the matched packets.

*dscp*: Specify the DSCP region for the data packets. The value ranges from 0 to 63.

*priority pri*: Specify the local priority for the data packets. The value ranges from 0 to 7.

*dot1p pri*: Specify the 802.1p priority for the data packets. The value ranges from 0 to 7.

---

Step 4 **end**

Return to privileged EXEC mode.

---

Step 5 **copy running-config startup-config**

Save the settings in the configuration file.

---

Redirect the matched packets to port 1/0/4 for rule 1 of MAC ACL 10:

**Switch#configure**

**Switch(config)#access-list action 10 rule 1**

**Switch(config-action)#redirect interface gigabitEthernet 1/0/4**

**Switch(config-action)#exit**

**Switch(config)#show access-list 10**

MAC access list 10 name: ACL\_10

rule 5 permit logging disable action redirect Gi1/0/4

**Switch(config)#end**

**Switch#copy running-config startup-config**

## 2.2.4 Configuring ACL Binding

You can bind the ACL to a port or a VLAN. The received packets on the port or in the VLAN will then be matched and processed according to the ACL rules. An ACL takes effect only after it is bound to a port or VLAN.

### Note:

- Different types of ACLs cannot be bound to the same port or VLAN.
- Multiple ACLs of the same type can be bound to the same port or VLAN. The switch matches the received packets using the ACLs in order. The ACL that is bound earlier has a higher priority.

Follow the steps below to bind ACL to a port or a VLAN:

|        |  |
|--------|--|
| Step 1 | <b>configure</b><br>Enter global configuration mode  |
| Step 2 | <b>access-list bind <i>acl-id-or-name</i> interface { [ <i>vlan</i> <i>vlan-list</i> ]   [ <i>fastEthernet</i> <i>port-list</i> ]   [ <i>gigabitEthernet</i> <i>port-list</i> ]   [ <i>ten-gigabitEthernet</i> <i>port-list</i> ] }</b><br>Bind the ACL to a port or a VLAN.<br><i>acl-id-or-name</i> : Enter the ID or name of the ACL that you want to add a rule for.<br><i>vlan-list</i> : Specify the ID or the ID list of the VLAN(s) that you want to bind the ACL to. The valid values are from 1 to 4094, for example, 2-3,5.<br><i>port-list</i> : Specify the number or the list of the Ethernet port that you want to bind the ACL to. |
| Step 3 | <b>show access-list bind</b><br>View the ACL binding configuration.  |
| Step 4 | <b>end</b><br>Return to privileged EXEC mode.  |
| Step 5 | <b>copy running-config startup-config</b><br>Save the settings in the configuration file.  |

The following example shows how to bind ACL 1 to port 3 and VLAN 4:

**Switch#configure**

**Switch(config)#access-list bind 1 interface vlan 4 gigabitEthernet 1/0/3**

**Switch(config)#show access-list bind**

| ACL ID | ACL NAME | Interface/VID | Direction | Type |
|--------|----------|---------------|-----------|------|
| -----  | -----    | -----         | -----     | ---- |
| 1      | ACL_1    | Gi1/0/3       | Ingress   | Port |
| 1      | ACL_1    | 4             | Ingress   | VLAN |

```
Switch(config)#end
```

```
Switch#copy running-config startup-config
```

## 2.2.5 Viewing ACL Counting

You can use the following command to view the number of matched packets of each ACL in the privileged EXEC mode and any other configuration mode:

---

```
show access-list acl-id-or-name counter
```

View the number of matched packets of the specific ACL.

*acl-id-or-name*: Specify the ID or name of the ACL to be viewed.

---

# 3 Configuration Example for ACL

## 3.1 Network Requirements

As shown below, a company's internal server group can provide different types of services. Computers in the Marketing department are connected to the switch via port 1/0/1, and the internal server group is connected to the switch via port 1/0/2.

Figure 3-1 Network Topology

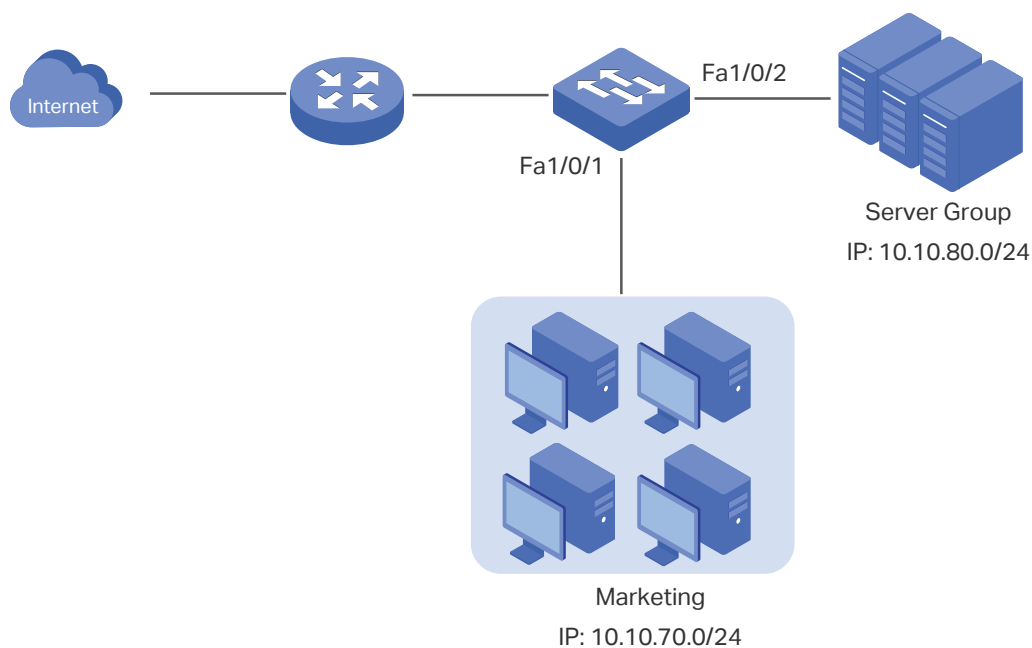

It is required that:

- The Marketing department can only access internal server group in the intranet.
- The Marketing department can only visit http and https websites on the internet.

## 3.2 Configuration Scheme

To meet the requirements above, you can set up packet filtering by creating an IP ACL and configuring rules for it.

### ■ ACL Configuration

Create an IP ACL and configure the following rules for it:

- Configure a permit rule to match packets with source IP address 10.10.70.0/24, and destination IP address 10.10.80.0/24. This rule allows the Marketing department to access internal network servers from intranet.

- Configure four permit rules to match the packets with source IP address 10.10.70.0/24, and destination ports TCP 80, TCP 443 and TCP/UDP 53. These allow the Marketing department to visit http and https websites on the internet.

The switch matches the packets with the rules in order, starting with Rule 1. If a packet matches a rule, the switch stops the matching process and initiates the action defined in the rule. If no rules are matched, the packet will be dropped.

### ■ Binding Configuration

Bind the IP ACL to port 1/0/1 so that the ACL rules will apply to the Marketing department only.

Demonstrated with T1500-28PCT, the following sections explain the configuration procedure in two ways: using the GUI and using the CLI.

## 3.3 Using the GUI

- 1) Choose the menu **SECURITY > ACL > ACL Config** and click  Add to load the following page. Then create an IP ACL for the marketing department.

Figure 3-2 Creating an IP ACL



- 2) Click **Edit ACL** in the Operation column.

Figure 3-3 Editing IP ACL

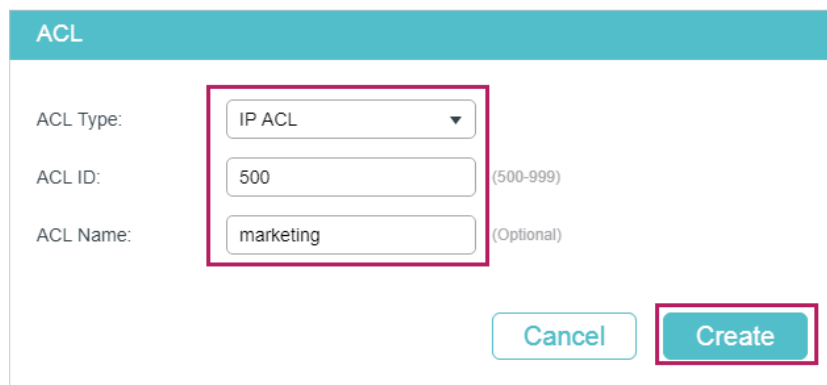
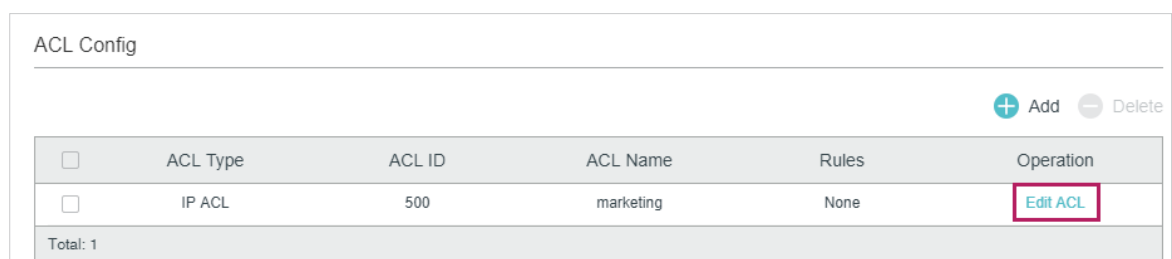

|                          | ACL Type | ACL ID | ACL Name  | Rules | Operation                |
|--------------------------|----------|--------|-----------|-------|--------------------------|
| <input type="checkbox"/> | IP ACL   | 500    | marketing | None  | <a href="#">Edit ACL</a> |

Total: 1

- 3) On the ACL configuration page, click  Add.

Figure 3-4 Editing IP ACL

**ACL Details**

---

ACL Type: IP ACL  
 ACL ID: 500  
 ACL Name: marketing

**ACL Rules Table**

---

🔁 Resequence + Add - Delete 🔄 Refresh

| <input type="checkbox"/>  | ID | Rule ID | S-IP | D-IP | IP Protocol | Action | Total Matched Counter | Operation |
|---------------------------|----|---------|------|------|-------------|--------|-----------------------|-----------|
| No Entries in this table. |    |         |      |      |             |        |                       |           |
| Total: 0                  |    |         |      |      |             |        |                       |           |

- 4) Configure rule 1 to permit packets with the source IP address 10.10.70.0/24 and destination IP address 10.10.80.0/24.

Figure 3-5 Configuring Rule 1

**IP ACL Rule**

---

ACL ID: 500  
 ACL Name: marketing

Rule ID:   Auto Assign

Operation:  ▼

S-IP:  (Format: 192.168.0.1)  
 Mask:  (Format: 255.255.255.0)

D-IP:  (Format: 192.168.0.1)  
 Mask:  (Format: 255.255.255.0)

IP Protocol:  ▼

DSCP:  ▼

IP ToS:  (Optional, 0-15)

IP Pre:  (Optional, 0-7)

- 5) In the same way, configure rule 2 and rule 3 to permit packets with source IP 10.10.70.0 and destination port TCP 80 (http service port) and TCP 443 (https service port).



Figure 3-6 Configuring Rule 2

IP ACL Rule

ACL ID: 500  
ACL Name: marketing

Rule ID:   Auto Assign

Operation:

S-IP:  (Format: 192.168.0.1)  
Mask:  (Format: 255.255.255.0)

D-IP:  (Format: 192.168.0.1)  
Mask:  (Format: 255.255.255.0)

IP Protocol:

URG:  ACK:  PSH:   
RST:  SYN:  FIN:

S-Port  
Value:  (0-65535)  
Mask:  (0000-FFFF)

D-Port  
Value:  (0-65535)  
Mask:  (0000-FFFF)

DSCP:

IP ToS:  (Optional, 0-15)

Figure 3-7 Configuring Rule 3

IP ACL Rule

ACL ID: 500  
ACL Name: marketing

Rule ID:   Auto Assign

Operation:

S-IP:  (Format: 192.168.0.1)  
Mask:  (Format: 255.255.255.0)

D-IP:  (Format: 192.168.0.1)  
Mask:  (Format: 255.255.255.0)

IP Protocol:

URG:  ACK:  PSH:   
RST:  SYN:  FIN:

S-Port  
Value:  (0-65535)  
Mask:  (0000-FFFF)

D-Port  
Value:  (0-65535)  
Mask:  (0000-FFFF)

DSCP:

IP ToS:  (Optional, 0-15)

- 6) In the same way, configure rule 4 and rule 5 to permit packets with source IP 10.10.70.0 and with destination port TCP 53 or UDP 53 (DNS service port).

Figure 3-8 Configuring Rule 4

**IP ACL Rule**

ACL ID: 500  
 ACL Name: marketing

Rule ID:   Auto Assign

Operation:

S-IP:  (Format: 192.168.0.1)  
 Mask:  (Format: 255.255.255.0)

D-IP:  (Format: 192.168.0.1)  
 Mask:  (Format: 255.255.255.0)

IP Protocol:

URG:  ACK:  PSH:   
 RST:  SYN:  FIN:

S-Port  
 Value:  (0-65535)  
 Mask:  (0000-FFFF)

D-Port  
 Value:  (0-65535)  
 Mask:  (0000-FFFF)

DSCP:

IP ToS:  (Optional, 0-15)

Figure 3-9 Configuring Rule 5

IP ACL Rule

ACL ID: 500  
 ACL Name: marketing

Rule ID:   Auto Assign

Operation:

S-IP:  (Format: 192.168.0.1)  
 Mask:  (Format: 255.255.255.0)

D-IP:  (Format: 192.168.0.1)  
 Mask:  (Format: 255.255.255.0)

IP Protocol:

S-Port  
 Value:  (0-65535)  
 Mask:  (0000-FFFF)

D-Port  
 Value:  (0-65535)  
 Mask:  (0000-FFFF)

DSCP:

IP ToS:  (Optional, 0-15)

7) In the same way, configure rule 6 to deny packets with source IP 10.10.70.0.

Figure 3-10 Configuring Rule 6

IP ACL Rule

ACL ID: 500  
 ACL Name: marketing

Rule ID:   Auto Assign

Operation:

Fragment:  Enable

S-IP:  (Format: 192.168.0.1)  
 Mask:  (Format: 255.255.255.0)

D-IP:  (Format: 192.168.0.1)  
 Mask:  (Format: 255.255.255.0)

IP Protocol:

DSCP:

IP ToS:  (Optional, 0-15)

IP Pre:  (Optional, 0-7)

- 8) Choose the menu **SECURITY > ACL > ACL Binding** and click **+ Add** to load the following page. Bind Policy Market to port 1/0/1 to make it take effect.

Figure 3-11 Binding the Policy to Port 1/0/1

The screenshot shows the 'Port Binding Config' window. At the top, there are radio buttons for 'ID' (selected) and 'Name'. Below that is a dropdown menu showing '500'. The 'Direction' is set to 'Ingress'. The 'Port' field contains '1/0/1' with a note '(Format: 1/0/1, input or choose below)'. Below the port field is a grid of ports labeled 'UNIT1', with port '1' highlighted in a red box. At the bottom right, there are 'Cancel' and 'Create' buttons, with the 'Create' button highlighted in a red box.

- 9) Click  Save to save the settings.

### 3.4 Using the CLI

- 1) Create an IP ACL.

```
Switch#configure
```

```
Switch(config)#access-list create 500 name marketing
```

- 2) Configure rule 1 to permit packets with source IP 10.10.70.0/24 and destination IP 10.10.80.0/24.

```
Switch(config)#access-list ip 500 rule 1 permit logging disable sip 10.10.70.0 sip-mask 255.255.255.0 dip 10.10.80.0 dmask 255.255.255.0
```

- 3) Configure rule 2 and Rule 3 to permit packets with source IP 10.10.70.0/24, and destination port TCP 80 (http service port) or TCP 443 (https service port).

```
Switch(config)#access-list ip 500 rule 2 permit logging disable sip 10.10.70.0 sip-mask 255.255.255.0 protocol 6 d-port 80 d-port-mask ffff
```

```
Switch(config)#access-list ip 500 rule 3 permit logging disable sip 10.10.70.0 sip-mask 255.255.255.0 protocol 6 d-port 443 d-port-mask ffff
```

- 4) Configure rule 4 and rule 5 to permit packets with source IP 10.10.70.0/24, and destination port TCP 53 or UDP 53.

```
Switch(config)#access-list ip 500 rule 4 permit logging disable sip 10.10.70.0 sip-mask 255.255.255.0 protocol 6 d-port 53 d-port-mask ffff
```

```
Switch(config)#access-list ip 500 rule 5 permit logging disable sip 10.10.70.0 sip-amask
255.255.255.0 protocol 17 d-port 53 d-port-mask ffff
```

- 5) Configure rule 6 to deny packets with source IP 10.10.70.0/24.

```
Switch(config)#access-list ip 500 rule 2 deny logging disable sip 10.10.70.0 sip-mask
255.255.255.0
```

- 6) Bind ACL500 to port 1.

```
Switch(config)#access-list bind 500 interface fastEthernet 1/0/1
```

```
Switch(config)#end
```

```
Switch#copy running-config startup-config
```

## Verify the Configurations

Verify the IP ACL 500:

```
Switch#show access-list 500
```

```
rule 1 permit logging disable sip 10.10.70.0 smask 255.255.255.0 dip 10.10.80.0 dmask
255.255.255.0
```

```
rule 2 permit logging disable sip 10.10.70.0 smask 255.255.255.0 protocol 6 d-port 80
```

```
rule 3 permit logging disable sip 10.10.70.0 smask 255.255.255.0 protocol 6 d-port 443
```

```
rule 4 permit logging disable sip 10.10.70.0 smask 255.255.255.0 protocol 6 d-port 53
```

```
rule 5 permit logging disable sip 10.10.70.0 smask 255.255.255.0 protocol 17 d-port 53
```

```
rule 6 deny logging disable sip 10.10.70.0 smask 255.255.255.0
```

```
Switch#show access-list bind
```

| ACL ID | ACL NAME  | Interface/VID | Direction | Type |
|--------|-----------|---------------|-----------|------|
| -----  | -----     | -----         | -----     | ---- |
| 500    | marketing | Fa1/0/1       | Ingress   | Port |

# 4 Appendix: Default Parameters

The default settings of ACL are listed in the following tables:

Table 4-1 MAC ACL

| Parameter     | Default Setting |
|---------------|-----------------|
| Operation     | Permit          |
| User Priority | No Limit        |
| Time-Range    | No Limit        |

Table 4-2 IP ACL

| Parameter   | Default Setting |
|-------------|-----------------|
| Operation   | Permit          |
| IP Protocol | All             |
| DSCP        | No Limit        |
| IP ToS      | No Limit        |
| IP Pre      | No Limit        |
| Time-Range  | No Limit        |

Table 4-3 Combined ACL

| Parameter  | Default Setting |
|------------|-----------------|
| Operation  | Permit          |
| Time-Range | No Limit        |

Table 4-4 IPv6 ACL

| Parameter  | Default Setting |
|------------|-----------------|
| Operation  | Permit          |
| Time-Range | No Limit        |

Table 4-5 Policy

| Parameter  | Default Setting |
|------------|-----------------|
| Mirroring  | Disabled        |
| Redirect   | Disabled        |
| Rate Limit | Disabled        |
| QoS Remark | Disabled        |



# Part 20

## Configuring IPv4 IMPB

### CHAPTERS

1. IPv4 IMPB
2. IP-MAC Binding Configuration
3. ARP Detection Configuration
4. IPv4 Source Guard Configuration
5. Configuration Examples
6. Appendix: Default Parameters

# 1 IPv4 IMPB

## 1.1 Overview

IPv4 IMPB (IP-MAC-Port Binding) is used to bind the IP address, MAC address, VLAN ID and the connected port number of the specified host. Basing on the binding table, the switch can prevent the ARP cheating attacks with the ARP Detection feature and filter the packets that don't match the binding entries with the IP Source Guard feature.

## 1.2 Supported Features

### IP-MAC Binding

This feature is used to add binding entries. The binding entries can be manually configured, or learned by ARP scanning or DHCP snooping. The features ARP Detection and IPv4 Source Guard are based on the IP-MAC Binding entries.

### ARP Detection

In an actual complex network, there are high security risks during ARP implementation procedure. The cheating attacks against ARP, such as imitating gateway, cheating gateway, cheating terminal hosts and ARP flooding attack, frequently occur to the network. ARP Detection can prevent the network from these ARP attacks.

- Prevent ARP Cheating Attacks

Based on the IP-MAC Binding entries, the ARP Detection can be configured to detect the ARP packets and filter the illegal ones so as to prevent the network from ARP cheating attacks.

- Prevent ARP Flooding Attack

You can limit the receiving speed of the legal ARP packets on the port to avoid ARP flooding attack.

### IPv4 Source Guard

IPv4 Source Guard is used to filter the IPv4 packets based on the IP-MAC Binding table. Only the packets that match the binding rules are forwarded.

# 2 IP-MAC Binding Configuration

You can add IP-MAC Binding entries in three ways:

- Manual Binding
- Via ARP Scanning
- Via DHCP Snooping

Additionally, you can view, search and edit the entries in the Binding Table.

## 2.1 Using the GUI

### 2.1.1 Binding Entries Manually

You can manually bind the IP address, MAC address, VLAN ID and the Port number together on the condition that you have got the detailed information of the hosts.

Choose the menu **SECURITY > IPv4 IMPB > IP-MAC Binding > Manual Binding** and click  **Add** to load the following page.

Figure 2-1 Manual Binding

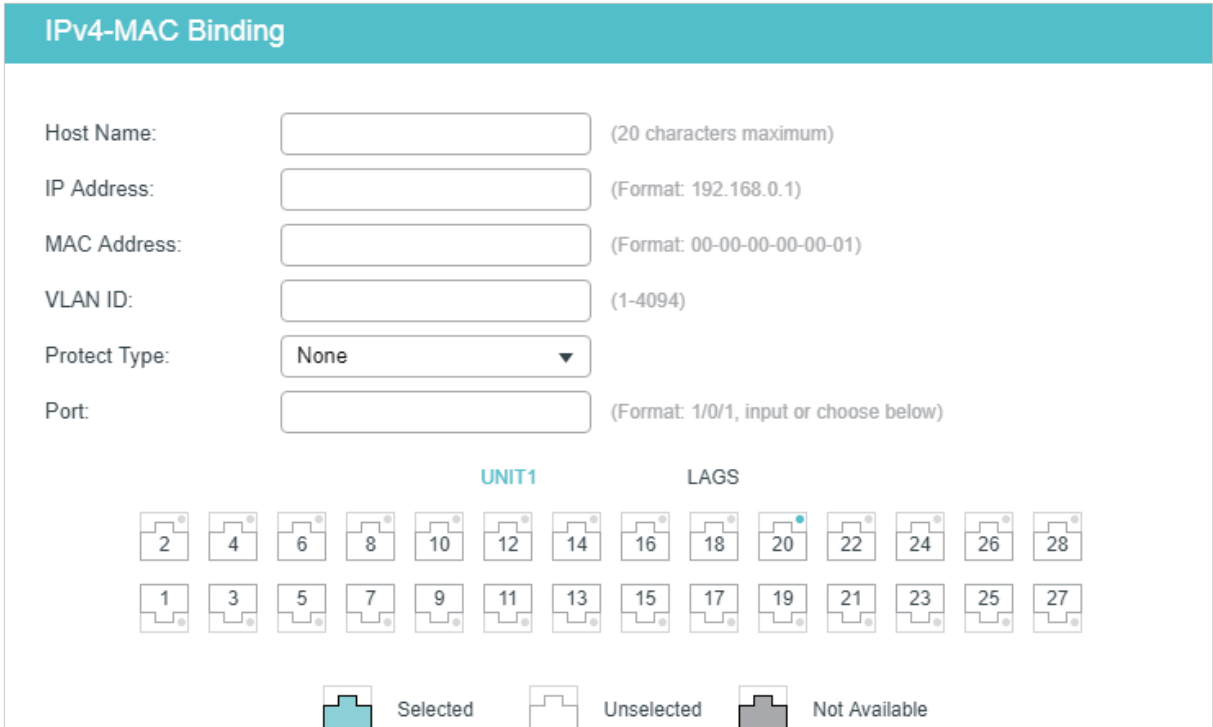

**IPv4-MAC Binding**

Host Name:  (20 characters maximum)

IP Address:  (Format: 192.168.0.1)

MAC Address:  (Format: 00-00-00-00-00-01)

VLAN ID:  (1-4094)

Protect Type:  ▼

Port:  (Format: 1/0/1, input or choose below)

**UNIT1**                      **LAGS**

2    4    6    8    10    12    14    16    18    20    22    24    26    28  
 1    3    5    7    9    11    13    15    17    19    21    23    25    27

Selected    Unselected    Not Available

Follow these steps to manually create an IP-MAC Binding entry:

- 1) Enter the following information to specify a host.

|             |   |
|-------------|---|
| Host Name   | Enter the host name for identification. |
| IP Address  | Enter the IP address.                   |
| MAC Address | Enter the MAC address.                  |
| VLAN ID     | Enter the VLAN ID.                      |

- 2) Select protect type for the entry.

|              |  |
|--------------|--|
| Protect Type | <p>Select the protect type for the entry. The entry will be applied to to the specific feature. The following options are provided:</p> <p><b>None:</b> This entry will not be applied to any feature.</p> <p><b>ARP Detection:</b> This entry will be applied to the ARP Detection feature.</p> <p><b>IP Source Guard:</b> This entry will be applied to the IPv4 Source Guard feature.</p> <p><b>Both:</b> This entry will be applied to both of the features.</p> |
|--------------|--|

- 3) Enter or select the port that is connected to this host.
- 4) Click **Apply**.

## 2.1.2 Binding Entries via ARP Scanning

With ARP Scanning, the switch sends the ARP request packets of the specified IP field to the hosts. Upon receiving the ARP reply packet, the switch can get the IP address, MAC address, VLAN ID and the connected port number of the host. You can bind these entries conveniently.

### Note:

Before using this feature, make sure that your network is safe and the hosts are not suffering from ARP attacks at present; otherwise, you may obtain incorrect IP-MAC Binding entries. If your network is being attacked, it's recommended to bind the entries manually.

Choose the menu **SECURITY > IPv4 IMPB > IP-MAC Binding > ARP Scanning** to load the following page.

Figure 2-2 ARP Scanning

**Scanning Option**

Starting IP Address:  (Format: 192.168.0.1)

Ending IP Address:  (Format: 192.168.0.1)

VLAN ID:  (1-4094)

---

**Scanning Result**

| <input type="checkbox"/>            | Host Name | IP Address    | MAC Address       | VLAN ID | Port   | Protect Type |
|-------------------------------------|-----------|---------------|-------------------|---------|--------|--------------|
| <input checked="" type="checkbox"/> | ---       | 192.168.0.28  | c4-6e-1f-bf-72-51 | 1       | 1/0/20 | None         |
| <input type="checkbox"/>            | ---       | 192.168.0.52  | 00-0a-eb-13-23-7b | 1       | 1/0/20 | None         |
| <input type="checkbox"/>            | ---       | 192.168.0.73  | 00-0a-eb-00-13-01 | 1       | 1/0/20 | None         |
| <input type="checkbox"/>            | ---       | 192.168.0.200 | 00-19-66-35-e1-b0 | 1       | 1/0/20 | None         |
| <input type="checkbox"/>            | ---       | 192.168.0.225 | ea-23-51-06-22-52 | 1       | 1/0/20 | None         |
| <input type="checkbox"/>            | ---       | 192.168.0.226 | 00-0a-eb-13-23-97 | 1       | 1/0/20 | None         |
| <input type="checkbox"/>            | ---       | 192.168.0.253 | 14-cc-20-00-00-13 | 1       | 1/0/20 | None         |

1 entry selected.

Follow these steps to configure IP-MAC Binding via ARP scanning:

- 1) In the **Scanning Option** section, specify an IP address range and a VLAN ID. Then click **Scan** to scan the entries in the specified IP address range and VLAN.

**Starting IP Address/Ending IP Address** Specify an IP range by entering a start and end IP address.

**VLAN ID** Specify a VLAN ID.

- 2) In the **Scanning Result** section, select one or more entries and configure the relevant parameters. Then click **Bind**.

**Host Name** Enter a host name for identification.

**IP Address** Displays the IP address.

**MAC Address** Displays the MAC address.

**VLAN ID** Displays the VLAN ID.

**Port** Displays the port number.

---

|                     |   |
|---------------------|---|
| <b>Protect Type</b> | <p>Select the protect type for the entry. The entry will be applied to to the specific feature. The following options are provided:</p> <p><b>None:</b> This entry will not be applied to any feature.</p> <p><b>ARP Detection:</b> This entry will be applied to the ARP Detection feature.</p> <p><b>IP Source Guard:</b> This entry will be applied to the IP Source Guard feature.</p> <p><b>Both</b> This entry will be applied to both of the features.</p> |
|---------------------|---|

---

### 2.1.3 Binding Entries via DHCP Snooping

With DHCP Snooping enabled, the switch can monitor the IP address obtaining process of the host, and record the IP address, MAC address, VLAN ID and the connected port number of the host.

Choose the menu **SECURITY > IPv4 IMPB > IP-MAC Binding > DHCP Snooping** to load the following page.

Figure 2-3 DHCP Snooping

Global Config

DHCP Snooping:  Enable Apply

VLAN Config

Filter by VLAN: From  To  Apply

| <input checked="" type="checkbox"/> | VLAN ID | Status   |
|-------------------------------------|---------|----------|
| <input checked="" type="checkbox"/> | 1       | Disabled |

Total: 1 1 entry selected. Cancel Apply

Port Config

UNIT1

LAGS

| <input type="checkbox"/>            | Port   | Maximum Entries | LAG |
|-------------------------------------|--------|-----------------|-----|
| <input checked="" type="checkbox"/> | 1/0/1  | 512             | --- |
| <input type="checkbox"/>            | 1/0/2  | 512             | --- |
| <input type="checkbox"/>            | 1/0/3  | 512             | --- |
| <input type="checkbox"/>            | 1/0/4  | 512             | --- |
| <input type="checkbox"/>            | 1/0/5  | 512             | --- |
| <input type="checkbox"/>            | 1/0/6  | 512             | --- |
| <input type="checkbox"/>            | 1/0/7  | 512             | --- |
| <input type="checkbox"/>            | 1/0/8  | 512             | --- |
| <input type="checkbox"/>            | 1/0/9  | 512             | --- |
| <input type="checkbox"/>            | 1/0/10 | 512             | --- |

Total: 28 1 entry selected. Cancel Apply

Follow these steps to configure IP-MAC Binding via DHCP Snooping:

- 1) In the **Global Config** section, globally enable DHCP Snooping. Click **Apply**.
- 2) In the **VLAN Config** section, enable DHCP Snooping on a VLAN or range of VLANs. Click **Apply**.

---

**VLAN ID**                      Displays the VLAN ID.

---

**Status**                        Enable or disable DHCP Snooping on the VLAN.

- 3) In the **Port Config** section, configure the maximum number of binding entries a port can learn via DHCP snooping. Click **Apply**.

---

**Port**                            Displays the port number.

**Maximum Entries** Configure the maximum number of binding entries a port can learn via DHCP snooping

**LAG** Displays the LAG that the port is in.

- 4) The learned entries will be displayed in the Binding Table. You can go to **SECURITY > IPv4 IMPB > IP-MAC Binding > Binding Table** to view or edit the entries.

### 2.1.4 Viewing the Binding Entries

In the Binding Table, you can view, search and edit the specified binding entries.

Choose the menu **SECURITY > IPv4 IMPB > IP-MAC Binding > Binding Table** to load the following page.

Figure 2-4 Binding Table

The screenshot shows the 'Binding Table' interface. At the top, there are search filters: 'Source' set to 'All' and an empty 'IP Address' field with a format hint '(Format: 192.168.0.1)'. A 'Search' button is on the right. Below the filters is a table with the following columns: Host Name, IP Address, MAC Address, VLAN ID, Port, Protect Type, and Source. The table contains two entries: one with a checked checkbox, IP 192.168.0.28, MAC c4-6e-1f-bf-72-51, VLAN 1, Port 1/0/20, Protect Type None, and Source ARP Scanning; and another with an unchecked checkbox, Host Name PC1, IP 192.168.0.98, MAC 74-d4-35-76-a4-d8, VLAN 1, Port 1/0/6, Protect Type None, and Source Manual Binding. A 'Delete' button is located to the right of the table. At the bottom, it says '1 entry selected.' and has 'Cancel' and 'Apply' buttons.

You can specify the search criteria to search your desired entries.

- Source** Select the source of the entry and click **Search**.
  - All:** Displays the entries from all sources.
  - Manual Binding:** Displays the manually bound entries.
  - ARP Scanning:** Displays the binding entries learned from ARP Scanning.
  - DHCP Snooping:** Displays the binding entries learned from DHCP Snooping.

**IP** Enter an IP address and click **Search** to search the specific entry.

Additionally, you select one or more entries to edit the host name and protect type and click **Apply**.

**Host Name** Enter a host name for identification.

**IP Address** Displays the IP address.

**MAC Address** Displays the MAC address.



---

|              |  |
|--------------|--|
| VLAN ID      | Displays the VLAN ID.  |
| Port         | Displays the port number.  |
| Protect Type | Select the protect type for the entry. The entry will be applied to the specific feature. The following options are provided:<br><br><b>None:</b> This entry will not be applied to any feature.<br><br><b>ARP Detection:</b> This entry will be applied to the ARP Detection feature.<br><br><b>IP Source Guard:</b> This entry will be applied to the IP Source Guard feature.<br><br><b>Both:</b> This entry will be applied to both of the features. |
| Source       | Displays the source of the entry.  |

---

## 2.2 Using the CLI

Binding entries via ARP scanning is not supported by the CLI. The following sections introduce how to bind entries manually and via DHCP Snooping and view the binding entries.

### 2.2.1 Binding Entries Manually

You can manually bind the IP address, MAC address, VLAN ID and the Port number together on the condition that you have got the detailed information of the hosts.

Follow these steps to manually bind entries:

---

|        |  |
|--------|--|
| Step 1 | <b>configure</b><br>Enter global configuration mode. |
|--------|--|

---

|        |  |
|--------|--|
| Step 2 | <p><b>ip source binding</b> <i>hostname ip-addr mac-addr vlan vlan-id interface { fastEthernet port   gigabitEthernet port   ten-gigabitEthernet port   port-channel port-channel-id } { none   arp-detection   ip-verify-source   both }</i></p> <p>Manually bind the host name, IP address, MAC address, VLAN ID and port number of the host, and configure the protect type for the host.</p> <p><i>hostname</i>: Specify a name for the host. It contains 20 characters at most.</p> <p><i>ip-addr</i>: Enter the IP address of the host.</p> <p><i>mac-addr</i>: Enter the MAC address of the host, in the format of xx:xx:xx:xx:xx:xx.</p> <p><i>vlan-id</i>: Enter the VLAN ID of the host.</p> <p><i>port</i>: Enter the number of the port on which the host is connected.</p> <p><i>none   arp-detection   ip-verify-source   both</i>: Specify the protect type for the entry. None indicates this entry will not be applied to any feature; arp-detection indicates this entry will be applied to ARP Detection; ip-verify-source indicates this entry will be applied to IPv4 Source Guard.</p> |
| Step 3 | <p><b>show ip source binding</b></p> <p>Verify the binding entry.</p>  |
| Step 4 | <p><b>end</b></p> <p>Return to privileged EXEC mode.</p>   |
| Step 5 | <p><b>copy running-config startup-config</b></p> <p>Save the settings in the configuration file.</p>   |

The following example shows how to bind an entry with the hostname host1, IP address 192.168.0.55, MAC address 74:d4:35:76:a4:d8, VLAN ID 10, port number 1/0/5, and enable this entry for the ARP detection feature.

### Switch#configure

```
Switch(config)#ip source binding host1 192.168.0.55 74:d4:35:76:a4:d8 vlan 10 interface
gigabitEthernet 1/0/5 arp-detection
```

### Switch(config)#show ip source binding

| U | Host  | IP-Addr      | MAC-Addr          | VID | Port    | ACL   | SOURCE |
|---|-------|--------------|-------------------|-----|---------|-------|--------|
| - | ----  | -----        | -----             | --- | ----    | ---   | -----  |
| 1 | host1 | 192.168.0.55 | 74:d4:35:76:a4:d8 | 10  | Gi1/0/5 | ARP-D | Manual |

Notice:

1. Here, 'ARP-D' for 'ARP-Detection', and 'IP-V-S' for 'IP-Verify-Source'.

### Switch(config)#end

### Switch#copy running-config startup-config

## 2.2.2 Binding Entries via DHCP Snooping

Follow these steps to bind entries via DHCP Snooping:

|        |   |
|--------|---|
| Step 1 | <b>configure</b><br>Enter global configuration mode.  |
| Step 2 | <b>ip dhcp snooping</b><br>Globally enable DHCP Snooping.   |
| Step 3 | <b>ip dhcp snooping vlan <i>vlan-range</i></b><br>Enable DHCP Snooping on the specified VLAN.<br><br><i>vlan-range</i> : Enter the vlan range in the format of 1-3, 5.  |
| Step 4 | <b>interface { fastEthernet <i>port</i>   range fastEthernet <i>port-list</i>   gigabitEthernet <i>port</i>   range gigabitEthernet <i>port-list</i>   ten-gigabitEthernet <i>port</i>   range ten-gigabitEthernet <i>port-list</i>   interface port-channel <i>port-channel-id</i>   interface range port-channel <i>port-channel-id-list</i> }</b><br>Enter interface configuration mode. |
| Step 5 | <b>ip dhcp snooping max-entries <i>value</i></b><br>Configure the maximum number of binding entries the port can learn via DHCP snooping.<br><br><i>value</i> : Enter the value of maximum number of entries. The valid values are from 0 to 512.   |
| Step 6 | <b>show ip dhcp snooping</b><br>Verify global configuration of DHCP Snooping.   |
| Step 7 | <b>end</b><br>Return to privileged EXEC mode.   |
| Step 8 | <b>copy running-config startup-config</b><br>Save the settings in the configuration file.   |

The following example shows how to enable DHCP Snooping globally and on VLAN 5, and set the maximum number of binding entries port 1/0/1 can learn via DHCP snooping as 100:

```
Switch#configure
```

```
Switch(config)#ip dhcp snooping
```

```
Switch(config)#ip dhcp snooping vlan 5
```

```
Switch(config)#interface gigabitEthernet 1/0/1
```

```
Switch(config-if)#ip dhcp snooping max-entries 100
```

```
Switch(config-if)#show ip dhcp snooping
```

```
Global Status: Enable
```

VLAN ID: 5

```
Switch(config-if)#show ip dhcp snooping interface gigabitEthernet 1/0/1
```

```
Interface max-entries LAG
```

```
-----
```

```
Gi1/0/1 100 N/A
```

```
Switch(config-if)#end
```

```
Switch#copy running-config startup-config
```

### 2.2.3 Viewing Binding Entries

On privileged EXEC mode or any other configuration mode, you can use the following command to view binding entries:

---

**show ip source binding**

View the information of binding entries, including the host name, IP address, MAC address, VLAN ID, port number and protect type.

---

# 3 ARP Detection Configuration

To complete ARP Detection configuration, follow these steps:

- 1) Add IP-MAC Binding entries.
- 2) Enable ARP Detection.
- 3) Configure ARP Detection on ports.
- 4) View ARP statistics.

## 3.1 Using the GUI

### 3.1.1 Adding IP-MAC Binding Entries

In ARP Detection, the switch detects the ARP packets based on the binding entries in the IP-MAC Binding Table. So before configuring ARP Detection, you need to complete IP-MAC Binding configuration. For details, refer to [IP-MAC Binding Configuration](#).

### 3.1.2 Enabling ARP Detection

Choose the menu **SECURITY > IPv4 IMPB > ARP Detection > Global Config** to load the following page.

Figure 3-1 ARP Detection Global Config

Global Config

ARP Detect:  Enable

Validate Source MAC :  Enable

Validate Destination MAC:  Enable

Validate IP:  Enable

**Apply**

VLAN Config

| <input checked="" type="checkbox"/> | VLAN ID | Status   | Log Status |
|-------------------------------------|---------|----------|------------|
| <input checked="" type="checkbox"/> | 1       | Disabled | Disabled   |

Total: 1      1 entry selected.      **Cancel**      **Apply**

Follow these steps to enable ARP Detection:

- 1) In the **Global Config** section, enable ARP Detection and configure the related parameters. Click **Apply**.

|                          |   |
|--------------------------|---|
| ARP Detect               | Enable or disable ARP Detection globally.   |
| Validate Source MAC      | Enable or disable the switch to check whether the source MAC address and the sender MAC address are the same when receiving an ARP packet. If not, the ARP packet will be discarded.  |
| Validate Destination MAC | Enable or disable the switch to check whether the destination MAC address and the target MAC address are the same when receiving an ARP reply packet. If not, the ARP packet will be discarded.   |
| Validate IP              | Enable or disable the switch to check whether the sender IP address of all ARP packets and the target IP address of ARP reply packets are legal. The illegal ARP packets will be discarded, including broadcast addresses, multicast addresses, Class E addresses, loopback addresses (127.0.0.0/8) and the following address: 0.0.0.0. |

2) In the **VLAN Config** section, enable ARP Detection on the selected VLANs. Click **Apply**.

|            |   |
|------------|---|
| VLAN ID    | Displays the VLAN ID.   |
| Status     | Enable or disable ARP Detection on the VLAN.  |
| Log Status | Enable or disable Log feature on the VLAN. With this feature enabled, the switch generates a log when an illegal ARP packet is discarded. |

### 3.1.3 Configuring ARP Detection on Ports

Choose the menu **SECURITY > IPv4 IMPB > ARP Detection >Port Config** to load the following page.

Figure 3-2 ARP Detection on Port

The screenshot shows the 'Port Config' interface with two tabs: 'UNIT1' and 'LAGS'. Below the tabs is a table with the following columns: Port, Trust Status, Limit Rate pps (0-300), Current Speed (pps), Burst Interval seconds (1-15), Status, Operation, and LAG. The table lists ports 1/0/1 through 1/0/10. Port 1/0/1 is selected, indicated by a checked checkbox in the first column. At the bottom of the table, it says 'Total: 28' and '1 entry selected.' There are 'Cancel' and 'Apply' buttons at the bottom right.

| <input type="checkbox"/>            | Port   | Trust Status | Limit Rate pps (0-300) | Current Speed (pps) | Burst Interval seconds (1-15) | Status | Operation | LAG |
|-------------------------------------|--------|--------------|------------------------|---------------------|-------------------------------|--------|-----------|-----|
| <input checked="" type="checkbox"/> | 1/0/1  | Disabled     | 100                    | 0                   | 1                             | Normal | ---       | --- |
| <input type="checkbox"/>            | 1/0/2  | Disabled     | 100                    | 0                   | 1                             | Normal | ---       | --- |
| <input type="checkbox"/>            | 1/0/3  | Disabled     | 100                    | 0                   | 1                             | Normal | ---       | --- |
| <input type="checkbox"/>            | 1/0/4  | Disabled     | 100                    | 0                   | 1                             | Normal | ---       | --- |
| <input type="checkbox"/>            | 1/0/5  | Disabled     | 100                    | 0                   | 1                             | Normal | ---       | --- |
| <input type="checkbox"/>            | 1/0/6  | Disabled     | 100                    | 0                   | 1                             | Normal | ---       | --- |
| <input type="checkbox"/>            | 1/0/7  | Disabled     | 100                    | 0                   | 1                             | Normal | ---       | --- |
| <input type="checkbox"/>            | 1/0/8  | Disabled     | 100                    | 0                   | 1                             | Normal | ---       | --- |
| <input type="checkbox"/>            | 1/0/9  | Disabled     | 100                    | 0                   | 1                             | Normal | ---       | --- |
| <input type="checkbox"/>            | 1/0/10 | Disabled     | 100                    | 0                   | 1                             | Normal | ---       | --- |

Total: 28      1 entry selected.      Cancel Apply

Follow these steps to configure ARP Detection on ports:

- 1) Select one or more ports and configure the parameters.

|                       |   |
|-----------------------|---|
| <b>Trust Status</b>   | Enable or disable this port to be a trusted port. On a trusted port, the ARP packets are forwarded directly without checked. The specific ports, such as up-link ports and routing ports are suggested to be set as trusted.  |
| <b>Limit Rate</b>     | Specify the maximum number of the ARP packets that can be received on the port per second.  |
| <b>Current Speed</b>  | Displays the current speed of receiving the ARP packets on the port.  |
| <b>Burst Interval</b> | Specify a time range. If the speed of received ARP packets reaches the limit for this time range, the port will be shut down.   |
| <b>Status</b>         | Displays the status of the ARP attack:<br><br><b>Normal:</b> The forwarding of ARP packets on the port is normal.<br><br><b>Down:</b> The transmission speed of the legal ARP packet exceeds the defined value. The port will be shut down for 300 seconds. You can also click the Recovery button to recover |
| <b>Operation</b>      | If Status is changed to Down, there will be a <b>Recover</b> button. You can click the button to restore the port to the normal status.   |
| <b>LAG</b>            | Displays the LAG that the port is in.   |

- 2) Click **Apply**.

### 3.1.4 Viewing ARP Statistics

You can view the number of the illegal ARP packets received on each port, which facilitates you to locate the network malfunction and take the related protection measures.

Choose the menu **SECURITY > IPv4 IMPB > ARP Detection > ARP Statistics** to load the following page.

Figure 3-3 View ARP Statistics

| Auto Refresh        |                                 |                       |
|---------------------|---------------------------------|-----------------------|
| Auto Refresh:       | <input type="checkbox"/> Enable | <a href="#">Apply</a> |
| Illegal ARP Packets |                                 |                       |
|                     | <a href="#">Refresh</a>         | <a href="#">Clear</a> |
| VLAN ID             | Forwarded                       | Dropped               |
| 1                   | 0                               | 0                     |
| Total: 1            |                                 |                       |

In the **Auto Refresh** section, you can enable the auto refresh feature and specify the refresh interval, and thus the web page will be automatically refreshed.

In the **Illegal ARP Packet** section, you can view the number of illegal ARP packets in each VLAN.

|           |  |
|-----------|--|
| VLAN ID   | Displays the VLAN ID.                                      |
| Forwarded | Displays the number of forwarded ARP packets in this VLAN. |
| Dropped   | Displays the number of dropped ARP packets in this VLAN.   |

## 3.2 Using the CLI

### 3.2.1 Adding IP-MAC Binding Entries

In ARP Detection, the switch detects the ARP packets based on the binding entries in the IP-MAC Binding Table. So before configuring ARP Detection, you need to complete IP-MAC Binding configuration. For details, refer to [IP-MAC Binding Configuration](#).

### 3.2.2 Enabling ARP Detection

Follow these steps to enable ARP Detection:

|        |   |
|--------|---|
| Step 1 | <b>configure</b><br>Enter global configuration mode.  |
| Step 2 | <b>ip arp inspection</b><br>Globally enable the ARP Detection feature.  |
| Step 3 | <b>ip arp inspection validate { src-mac   dst-mac   ip }</b><br>Configure the switch to check the IP address or MAC address of the received packets.<br><br><b>src-mac:</b> Enable the switch to check whether the source MAC address and the sender MAC address are the same when receiving an ARP packet. If not, the ARP packet will be discarded.<br><br><b>dst-mac:</b> Enable the switch to check whether the sender IP address of all ARP packets and the target IP address of ARP reply packets are legal. The illegal packets will be discarded.<br><br><b>ip:</b> Enable or disable the switch to check whether the sender IP address of all ARP packets and the target IP address of ARP reply packets are legal. The illegal ARP packets will be discarded, including broadcast addresses, multicast addresses, Class E addresses, loopback addresses (127.0.0.0/8) and the following address: 0.0.0.0. |
| Step 4 | <b>ip arp inspection vlan <i>vlan-list</i></b><br>Enable ARP Detection on one or more 802.1Q VLANs that already exist.<br><br><b>vlan-list:</b> Enter the VLAN ID. The format is 1,5-9.   |



|        |  |
|--------|--|
| Step 5 | <b>ip arp inspection vlan <i>vlan-list</i> logging</b><br>(Optional) Enable the Log feature to make the switch generate a log when an ARP packet is discarded.<br><br><i>vlan-list</i> : Enter the VLAN ID. The format is 1,5-9. |
| Step 6 | <b>show ip arp inspection</b><br>Verify the ARP Detection configuration.   |
| Step 7 | <b>end</b><br>Return to privileged EXEC mode.  |
| Step 8 | <b>copy running-config startup-config</b><br>Save the settings in the configuration file.  |

The following example shows how to enable ARP Detection globally and on VLAN 2, and enable the switch to check whether the source MAC address and the sender MAC address are the same when receiving an ARP packet:

**Switch#configure**

**Switch(config)#ip arp inspection**

**Switch(config)#ip arp inspection validate src-mac**

**Switch(config)#ip arp inspection vlan 2**

**Switch(config)#show ip arp inspection**

Global Status: Enable

Verify SMAC: Enable

Verify DMAC: Disable

Verify IP: Disable

**Switch(config)#show ip arp inspection vlan**

| VID  | Enable status | Log Status |
|------|---------------|------------|
| ---- | -----         | -----      |
| 1    | Disable       | Disable    |
| 2    | Enable        | Disable    |

**Switch(config)#end**

**Switch#copy running-config startup-config**

### 3.2.3 Configuring ARP Detection on Ports

Follow these steps to configure ARP Detection on ports:

|         |  |
|---------|--|
| Step 1  | <b>configure</b><br>Enter global configuration mode.   |
| Step 2  | <b>interface { fastEthernet port   range fastEthernet port-list   gigabitEthernet port   range gigabitEthernet port-list   ten-gigabitEthernet port   range ten-gigabitEthernet port-list }</b><br>Enter interface configuration mode.   |
| Step 3  | <b>ip arp inspection trust</b><br>Configure the port as a trusted port, on which the ARP Detection function will not take effect. The specific ports, such as up-linked ports and routing ports are suggested to be set as trusted ports.  |
| Step 4  | <b>ip arp inspection limit-rate value</b><br>Specify the maximum number of the ARP packets can be received on the port per second.<br><br><i>value</i> : Specify the limit rate value. The valid values are from 0 to 300 pps (packets/second), and the default value is 100.                              |
| Step 5  | <b>ip arp inspection burst-interval value</b><br>Specify a time range. If the speed of received ARP packets reaches the limit for this time range, the port will be shut down.<br><br><i>value</i> : Specify the time range. The valid values are from 1 to 15 seconds, and the default value is 1 second. |
| Step 6  | <b>show ip arp inspection interface</b><br>View the configurations and status of the ports.  |
| Step 7  | <b>show ip arp inspection vlan</b><br>View the configurations and status of the VLANs.   |
| Step 8  | <b>ip arp inspection recover</b><br>(Optional) For ports on which the speed of receiving ARP packets has exceeded the limit, use this command to restore the port from Down status to Normal status.   |
| Step 9  | <b>end</b><br>Return to privileged EXEC mode.  |
| Step 10 | <b>copy running-config startup-config</b><br>Save the settings in the configuration file.  |

The following example shows how to set port 1/0/2 as a trusted port, and set limit-rate as 20 pps and burst interval as 2 seconds on port 1/0/2:

```
Switch#configure
```

```
Switch(config)#interface gigabitEthernet 1/0/2
```

```
Switch(config-if)#ip arp inspection trust
```

```
Switch(config-if)#ip arp inspection limit-rate 20
```

```
Switch(config-if)#ip arp inspection burst-interval 2
```

```
Switch(config-if)#show ip arp inspection interface gigabitEthernet 1/0/2
```

| Interface | Trust state | limit Rate(pps) | Current speed(pps) | Burst Interval | Status | LAG |
|-----------|-------------|-----------------|--------------------|----------------|--------|-----|
| -----     | -----       | -----           | -----              | -----          | -----  | --- |
| Gi1/0/2   | Enable      | 20              | 0                  | 2              | ---    | N/A |

```
Switch(config-if)#end
```

```
Switch#copy running-config startup-config
```

The following example shows how to restore the port 1/0/1 that is in Down status to Normal status:

```
Switch#configure
```

```
Switch(config)#interface gigabitEthernet 1/0/1
```

```
Switch(config-if)#ip arp inspection recover
```

```
Switch(config-if)#end
```

```
Switch#copy running-config startup-config
```

### 3.2.4 Viewing ARP Statistics

On privileged EXEC mode or any other configuration mode, you can use the following command to view ARP statistics:

---

#### **show ip arp inspection statistics**

View the ARP statistics on each port, including the number of forwarded ARP packets and the number of dropped ARP packets.

---

# 4 IPv4 Source Guard Configuration

To complete IPv4 Source Guard configuration, follow these steps:

- 1) Add IP-MAC Binding entries.
- 2) Configure IPv4 Source Guard.

## 4.1 Using the GUI

### 4.1.1 Adding IP-MAC Binding Entries

In IPv4 Source Guard, the switch filters the packets that do not match the rules of IPv4-MAC Binding Table. So before configuring ARP Detection, you need to complete IP-MAC Binding configuration. For details, refer to [IP-MAC Binding Configuration](#).

### 4.1.2 Configuring IPv4 Source Guard

Choose the menu **SECURITY > IPv4 IMPB > IPv4 Source Guard** to load the following page.

Figure 4-1 IPv4 Source Guard Config

Global Config

---

IPv4 Source Guard Log:  Enable Apply

---

Port Config

UNIT1

LAGS

|                                     | Port   | Security Type | LAG |
|-------------------------------------|--------|---------------|-----|
| <input checked="" type="checkbox"/> | 1/0/1  | Disable       | --- |
| <input type="checkbox"/>            | 1/0/2  | Disable       | --- |
| <input type="checkbox"/>            | 1/0/3  | Disable       | --- |
| <input type="checkbox"/>            | 1/0/4  | Disable       | --- |
| <input type="checkbox"/>            | 1/0/5  | Disable       | --- |
| <input type="checkbox"/>            | 1/0/6  | Disable       | --- |
| <input type="checkbox"/>            | 1/0/7  | Disable       | --- |
| <input type="checkbox"/>            | 1/0/8  | Disable       | --- |
| <input type="checkbox"/>            | 1/0/9  | Disable       | --- |
| <input type="checkbox"/>            | 1/0/10 | Disable       | --- |

Total: 28
1 entry selected.

Cancel
Apply

Follow these steps to configure IPv4 Source Guard:

- 1) In the **Global Config** section, choose whether to enable the Log feature. Click **Apply**.

|                      |   |
|----------------------|---|
| Pv4 Source Guard Log | Enable or disable IPv4 Source Guard Log feature. With this feature enabled, the switch generates a log when illegal packets are received. |
|----------------------|---|

- 2) In the **Port Config** section, configure the protect type for ports and click **Apply**.

|               |   |
|---------------|---|
| Port          | Displays the port number.   |
| Security Type | <p>Select Security Type on the port for IPv4 packets. The following options are provided:</p> <p><b>Disable:</b> The IP Source Guard feature is disabled on the port.</p> <p><b>SIP+MAC:</b> Only the packet with its source IP address, source MAC address and port number matching the IPv4-MAC binding rules can be processed, otherwise the packet will be discarded.</p> <p><b>SIP:</b> Only the packet with its source IP address and port number matching the IPv4-MAC binding rules can be processed, otherwise the packet will be discarded.</p> |
| LAG           | Displays the LAG that the port is in.   |

## 4.2 Using the CLI

### 4.2.1 Adding IP-MAC Binding Entries

In IPv4 Source Guard, the switch filters the packets that do not match the rules of IPv4-MAC Binding Table. So before configuring ARP Detection, you need to complete IP-MAC Binding configuration. For details, refer to [IP-MAC Binding Configuration](#).

### 4.2.2 Configuring IPv4 Source Guard

Follow these steps to configure IPv4 Source Guard:

|        |   |
|--------|---|
| Step 1 | <p><b>configure</b></p> <p>Enter global configuration mode.</p>   |
| Step 2 | <p><b>interface { fastEthernet port   range fastEthernet port-list   gigabitEthernet port   range gigabitEthernet port-list   ten-gigabitEthernet port   range ten-gigabitEthernet port-list }</b></p> <p>Enter interface configuration mode.</p> |

- 
- Step 3      **ip verify source { sip+mac | sip }**  
 Enable IP Source Guard for IPv4 packets.
- sip+mac:** Only the packet with its source IP address, source MAC address and port number matching the IP-MAC binding rules can be processed, otherwise the packet will be discarded.
- sip:** Only the packet with its source IP address and port number matching the IP-MAC binding rules can be processed, otherwise the packet will be discarded.
- 
- Step 4      **show ip verify source [ interface { fastEthernet port | gigabitEthernet port | ten-gigabitEthernet port | port-channel port-channel-id } ]**  
 Verify the IP Source Guard configuration for IPv4 packets.
- 
- Step 5      **end**  
 Return to privileged EXEC mode.
- 
- Step 6      **copy running-config startup-config**  
 Save the settings in the configuration file.
- 

The following example shows how to enable IPv4 Source Guard on port 1/0/1:

**Switch#configure**

**Switch(config)#interface gigabitEthernet 1/0/1**

**Switch(config-if)#ip verify source sip+mac**

**Switch(config-if)#show ip verify source interface gigabitEthernet 1/0/1**

| Port    | Security-Type | LAG  |
|---------|---------------|------|
| ----    | -----         | ---- |
| Gi1/0/1 | SIP+MAC       | N/A  |

**Switch(config-if)#end**

**Switch#copy running-config startup-config**

# 5 Configuration Examples

## 5.1 Example for ARP Detection

### 5.1.1 Network Requirements

As shown below, User 1 and User 2 are legal users in the LAN and connected to port 1/0/1 and port 1/0/2. Both of them are in the default VLAN 1. The router has been configured with security feature to prevent attacks from the WAN. Now the network administrator wants to configure Switch A to prevent ARP attacks from the LAN.

Figure 5-1 Network Topology

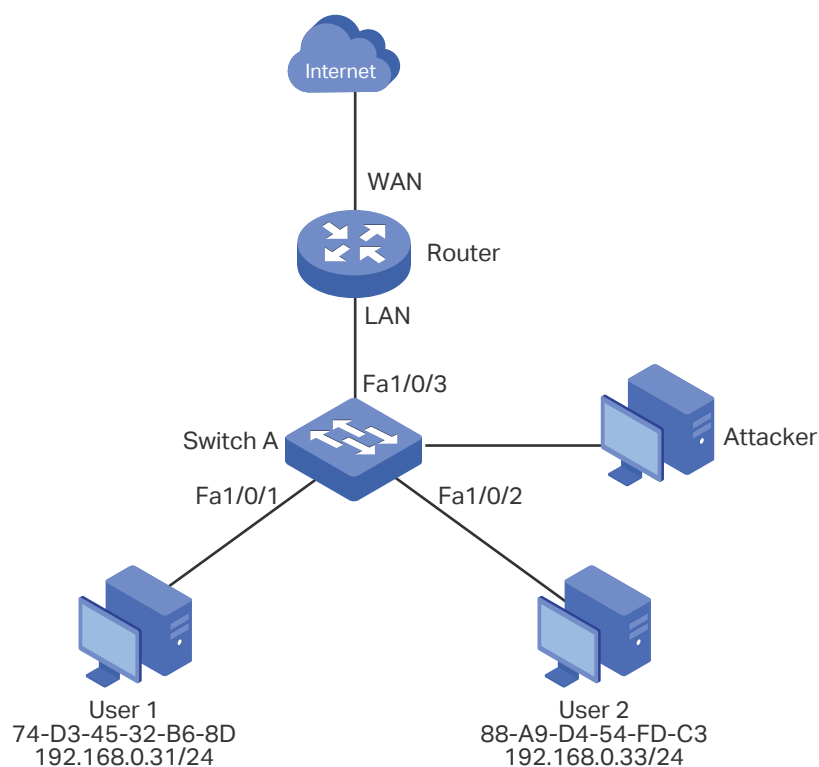

### 5.1.2 Configuration Scheme

To meet the requirement, you can configure ARP Detection to prevent the network from ARP attacks in the LAN.

The overview of configurations on the switch is as follows:

- 1) Configure IP-MAC Binding. The binding entries for User 1 and User 2 should be manually bound.
- 2) Configure ARP Detection globally.

- Configure ARP Detection on ports. Since port 1/0/3 is connected to the gateway router, set port 1/0/3 as trusted port. To prevent ARP flooding attacks, limit the speed of receiving the legal ARP packets on all ports.

Demonstrated with T1500-28PCT, the following sections provide configuration procedure in two ways: using the GUI and using the CLI.

### 5.1.3 Using the GUI

- Choose the menu **SECURITY > IPv4 IMPB > IP-MAC Binding > Manual Binding** and click **+ Add** to load the following page. Enter the host name, IP address, MAC address and VLAN ID of User 1, select the protect type as ARP Detection, and select port 1/0/1 on the panel. Click **Apply**.

Figure 5-2 Binding Entry for User 1

**IPv4-MAC Binding**

Host Name:  (20 characters maximum)

IP Address:  (Format: 192.168.0.1)

MAC Address:  (Format: 00-00-00-00-00-01)

VLAN ID:  (1-4094)

Protect Type:  ▼

Port:  (Format: 1/0/1, input or choose below)

**UNIT1**      **LAGS**

|   |   |   |   |    |    |    |    |    |    |    |    |    |    |
|---|---|---|---|----|----|----|----|----|----|----|----|----|----|
| 2 | 4 | 6 | 8 | 10 | 12 | 14 | 16 | 18 | 20 | 22 | 24 | 26 | 28 |
| 1 | 3 | 5 | 7 | 9  | 11 | 13 | 15 | 17 | 19 | 21 | 23 | 25 | 27 |

Selected      Unselected      Not Available

- On the same page, add a binding entry for User 2. Enter the host name, IP address, MAC address and VLAN ID of User 2, select the protect type as ARP Detection, and select port 1/0/2 on the panel. Click **Apply**.



Figure 5-3 Binding Entry for User 2

**IPv4-MAC Binding**

Host Name:  (20 characters maximum)

IP Address:  (Format: 192.168.0.1)

MAC Address:  (Format: 00-00-00-00-00-01)

VLAN ID:  (1-4094)

Protect Type:  ▼

Port:  (Format: 1/0/1, input or choose below)

UNIT1 LAGS

Selected Unselected Not Available

- 3) Choose the menu **SECURITY > IPv4 IMPB > ARP Detection > Global Config** to load the following page. Enable APP Detect, Validate Source MAC, Validate Destination MAC and Validate IP, and click **Apply**. Select VLAN 1, change Status as Enabled and click **Apply**.

Figure 5-4 Enable ARP Detection

**Global Config**

ARP Detect:  Enable

Validate Source MAC:  Enable

Validate Destination MAC:  Enable

Validate IP:  Enable

**Apply**

**VLAN Config**

| <input checked="" type="checkbox"/> | VLAN ID | Status  | Log Status |
|-------------------------------------|---------|---------|------------|
| <input checked="" type="checkbox"/> | 1       | Enabled | Disabled   |

Total: 1 1 entry selected. **Cancel** **Apply**

- 4) Choose the menu **SECURITY > IPv4 IMPB > ARP Detection > Port Config** to load the following page. By default, all ports are enabled with ARP Detection and ARP flooding defend. Configure port 1/0/3 as trusted port and keep other defend parameters as default. Click **Apply**.

Figure 5-5 Port Config

Port Config

UNIT1 LAGS

| <input type="checkbox"/>            | Port   | Trust Status | Limit Rate<br>pps (0-300) | Current Speed<br>(pps) | Burst Interval<br>seconds (1-15) | Status | Operation | LAG |
|-------------------------------------|--------|--------------|---------------------------|------------------------|----------------------------------|--------|-----------|-----|
|                                     |        | Enable ▾     |                           |                        |                                  |        |           |     |
| <input type="checkbox"/>            | 1/0/1  | Disabled     | 100                       | 0                      | 1                                | Normal | ---       | --- |
| <input type="checkbox"/>            | 1/0/2  | Disabled     | 100                       | 0                      | 1                                | Normal | ---       | --- |
| <input checked="" type="checkbox"/> | 1/0/3  | Enabled      | 100                       | 0                      | 1                                | Normal | ---       | --- |
| <input type="checkbox"/>            | 1/0/4  | Disabled     | 100                       | 0                      | 1                                | Normal | ---       | --- |
| <input type="checkbox"/>            | 1/0/5  | Disabled     | 100                       | 0                      | 1                                | Normal | ---       | --- |
| <input type="checkbox"/>            | 1/0/6  | Disabled     | 100                       | 0                      | 1                                | Normal | ---       | --- |
| <input type="checkbox"/>            | 1/0/7  | Disabled     | 100                       | 0                      | 1                                | Normal | ---       | --- |
| <input type="checkbox"/>            | 1/0/8  | Disabled     | 100                       | 0                      | 1                                | Normal | ---       | --- |
| <input type="checkbox"/>            | 1/0/9  | Disabled     | 100                       | 0                      | 1                                | Normal | ---       | --- |
| <input type="checkbox"/>            | 1/0/10 | Disabled     | 100                       | 0                      | 1                                | Normal | ---       | --- |

Total: 28 1 entry selected.

Cancel Apply

- 5) Click  Save to save the settings.

### 5.1.4 Using the CLI

- 1) Manually bind the entries for User 1 and User 2.

```
Switch_A#configure
```

```
Switch_A(config)#ip source binding User1 192.168.0.31 74:d3:45:32:b6:8d vlan 1
interface fastEthernet 1/0/1 arp-detection
```

```
Switch_A(config)#ip source binding User1 192.168.0.32 88:a9:d4:54:fd:c3 vlan 1
interface fastEthernet 1/0/2 arp-detection
```

- 2) Enable ARP Detection globally and on VLAN 1.

```
Switch_A(config)#ip arp inspection
```

```
Switch_A(config)#ip arp inspection vlan 1
```

- 3) Configure port 1/0/3 as trusted port.

```
Switch_A(config)#interface fastEthernet 1/0/3
```

```
Switch_A(config-if)#ip arp inspection trust
```

```
Switch_A(config-if)#end
```

```
Switch_A#copy running-config startup-config
```

## Verify the Configuration

Verify the IP-MAC Binding entries:

```
Switch_A#show ip source binding
```

| U | Host  | IP-Addr      | MAC-Addr          | VID | Port    | ACL   | SOURCE |
|---|-------|--------------|-------------------|-----|---------|-------|--------|
| - | ----  | -----        | -----             | --- | ----    | ---   | -----  |
| 1 | User1 | 192.168.0.31 | 74:d3:45:32:b6:8d | 1   | Fa1/0/1 | ARP-D | Manual |
| 1 | User2 | 192.168.0.33 | 88:a9:d4:54:fd:c3 | 1   | Fa1/0/2 | ARP-D | Manual |

Notice:

1.Here, 'ARP-D' for 'ARP-Detection',and'IP-V-S' for 'IP-Verify-Source'.

Verify the global configuration of ARP Detection:

```
Switch_A#show ip arp inspection
```

Global Status: Enable

Verify SMAC: Enable

Verify DMAC: Enable

Verify IP: Enable

Verify the ARP Detection configuration on VLAN:

```
Switch_A#show ip arp inspection vlan
```

| VID  | Enable status | Log Status |
|------|---------------|------------|
| ---- | -----         | -----      |
| 1    | Enable        | Disable    |

Verify the ARP Detection configuration on ports:

```
Switch_A#show ip arp inspection interface
```

| Interface | Trust state | limit Rate(pps) | Current speed(pps) | Burst Interval | Status | LAG |
|-----------|-------------|-----------------|--------------------|----------------|--------|-----|
| -----     | -----       | -----           | -----              | -----          | -----  | --- |
| Fa1/0/1   | Disable     | 100             | 0                  | 1              | ---    | N/A |
| Fa1/0/2   | Disable     | 100             | 0                  | 1              | ---    | N/A |
| Fa1/0/3   | Enable      | 100             | 0                  | 1              | ---    | N/A |
| ...       |             |                 |                    |                |        |     |

## 5.2 Example for IP Source Guard

### 5.2.1 Network Requirements

As shown below, the legal host connects to the switch via port 1/0/1 and belongs to the default VLAN 1. It is required that only the legal host can access the network via port 1/0/1, and other unknown hosts will be blocked when trying to access the network via ports 1/0/1-3.

Figure 5-6 Network Topology

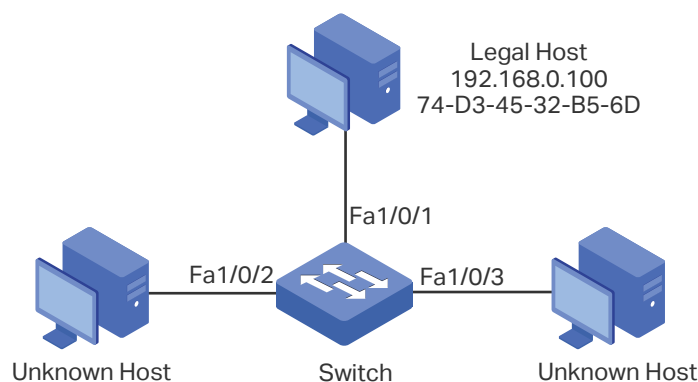

### 5.2.2 Configuration Scheme

To implement this requirement, you can use IP-MAC Binding and IP Source Guard to filter out the packets received from the unknown hosts. The overview of configuration on the switch is as follows:

- 1) Bind the MAC address, IP address, connected port number and VLAN ID of the legal host with IP-MAC Binding.
- 2) Enable IP Source Guard on ports 1/0/1-3.

Demonstrated with T1500-28PCT, the following sections provide configuration procedure in two ways: using the GUI and using the CLI.

## 5.2.3 Using the GUI

- 1) Choose the menu **SECURITY > IPv4 IMPB > IP-MAC Binding > Manual Binding** and click **+ Add** to load the following page. Enter the host name, IP address, MAC address and VLAN ID of the legal host, select the protect type as , and select port 1/0/1 on the panel. Click **Apply**.

Figure 5-7 Manual Binding

**IPv4-MAC Binding**

Host Name: LegalHost (20 characters maximum)

IP Address: 192.168.0.100 (Format: 192.168.0.1)

MAC Address: 74-D3-45-32-B5-6D (Format: 00-00-00-00-00-01)

VLAN ID: 1 (1-4094)

Protect Type: IP Source Guard ▼

Port: 1/0/1 (Format: 1/0/1, input or choose below)

UNIT1 LAGS

2 4 6 8 10 12 14 16 18 20 22 24 26 28

1 3 5 7 9 11 13 15 17 19 21 23 25 27

Selected Unselected Not Available

- 2) Choose the menu **SECURITY > IPv4 IMPB > IPv4 Source Guard** to load the following page. Enable IPv4 Source Guard Logging to make the switch generate logs when receiving illegal packets, and click **Apply**. Select ports 1/0/1-3, configure the Security Type as SIP+MAC, and click **Apply**.

Figure 5-8 IPv4 Source Guard

Global Config

IPv4 Source Guard Logging:  Enable Apply

Port Config

UNIT1 LAGS

| <input type="checkbox"/>            | Port   | Security Type | LAG |
|-------------------------------------|--------|---------------|-----|
| <input checked="" type="checkbox"/> | 1/0/1  | SIP+SMAC      | --- |
| <input checked="" type="checkbox"/> | 1/0/2  | SIP+SMAC      | --- |
| <input checked="" type="checkbox"/> | 1/0/3  | SIP+SMAC      | --- |
| <input type="checkbox"/>            | 1/0/4  | Disable       | --- |
| <input type="checkbox"/>            | 1/0/5  | Disable       | --- |
| <input type="checkbox"/>            | 1/0/6  | Disable       | --- |
| <input type="checkbox"/>            | 1/0/7  | Disable       | --- |
| <input type="checkbox"/>            | 1/0/8  | Disable       | --- |
| <input type="checkbox"/>            | 1/0/9  | Disable       | --- |
| <input type="checkbox"/>            | 1/0/10 | Disable       | --- |

Total: 28 3 entries selected. Cancel Apply

- 3) Click  Save to save the settings.

## 5.2.4 Using the CLI

- 1) Manually bind the IP address, MAC address, VLAN ID and connected port number of the legal host, and apply this entry to the IP Source Guard feature.

```
Switch#configure
```

```
Switch(config)#ip source binding legal-host 192.168.0.100 74:d3:45:32:b5:6d vlan 1
interface fastEthernet 1/0/1 ip-verify-source
```

- 2) Enable the log feature and IP Source Guard on ports 1/0/1-3.

```
Switch(config)# ip verify source logging
```

```
Switch(config)# interface range fastEthernet 1/0/1-3
```

```
Switch(config-if-range)#ip verify source sip+mac
```

```
Switch(config-if-range)#end
```

```
Switch#copy running-config startup-config
```

### Verify the Configuration

Verify the binding entry:

```
Switch#show ip source binding
```

| U | Host  | IP-Addr       | MAC-Addr          | VID | Port    | ACL    | SOURCE |
|---|-------|---------------|-------------------|-----|---------|--------|--------|
| - | ----  | -----         | -----             | --- | ----    | ---    | -----  |
| 1 | User1 | 192.168.0.100 | 74:d3:45:32:b5:6d | 1   | Fa1/0/1 | IP-V-S | Manual |

Notice:

1. Here, 'ARP-D' for 'ARP-Detection', and 'IP-V-S' for 'IP-Verify-Source'.

Verify the configuration of IP Source Guard:

```
Switch#show ip verify source
```

```
IP Source Guard log: Enabled
```

| Port    | Security-Type | LAG |
|---------|---------------|-----|
| Fa1/0/1 | SIP+MAC       | N/A |
| Fa1/0/2 | SIP+MAC       | N/A |
| Fa1/0/3 | SIP+MAC       | N/A |

...

# 6 Appendix: Default Parameters

Default settings of DHCP Snooping are listed in the following table:

Table 6-1 DHCP Snooping

| Parameter     | Default Setting |
|---------------|-----------------|
| Global Config |                 |
| DHCP Snooping | Disabled        |
| VLAN Config   |                 |
| Status        | Disabled        |
| Port Config   |                 |
| Maximum Entry | 512             |

Default settings of ARP Detection are listed in the following table:

Table 6-2 ARP Detection

| Parameter                | Default Setting |
|--------------------------|-----------------|
| Global Config            |                 |
| ARP Detect               | Disabled        |
| Validate Source MAC      | Disabled        |
| Validate Destination MAC | Disabled        |
| Validate IP              | Disabled        |
| VLAN Config              |                 |
| Status                   | Disabled        |
| Log Status               | Disabled        |
| Port Config              |                 |
| Trust Status             | Disabled        |
| Limit Rate               | 100 pps         |



| Parameter        | Default Setting |
|------------------|-----------------|
| Burst Interval   | 1 second        |
| ARP Statistics   |                 |
| Auto Refresh     | Disabled        |
| Refresh Interval | 5 seconds       |

Default settings of IPv4 Source Guard are listed in the following table:

Table 6-3 ARP Detection

| Parameter              | Default Setting |
|------------------------|-----------------|
| Global Config          |                 |
| IPv4 Source Guard Log: | Disabled        |
| Port Config            |                 |
| Security Type          | Disabled        |

# Part 21

## Configuring IPv6 IMPB

### CHAPTERS

1. IPv6 IMPB
2. IPv6-MAC Binding Configuration
3. ND Detection Configuration
4. IPv6 Source Guard Configuration
5. Configuration Examples
6. Appendix: Default Parameters

# 1 IPv6 IMPB

## 1.1 Overview

IPv6 IMPB (IP-MAC-Port Binding) is used to bind the IPv6 address, MAC address, VLAN ID and the connected port number of the specified host. Basing on the binding table, the switch can prevent ND attacks with the ND Detection feature and filter the packets that don't match the binding entries with the IPv6 Source Guard feature.

## 1.2 Supported Features

### IPv6-MAC Binding

This feature is used to add binding entries. The binding entries can be manually configured, or learned by ND Snooping or DHCPv6 snooping. The features ND Detection and IPv6 Source Guard are based on the IPv6-MAC Binding entries.

### ND Detection

Because of the absence of security mechanism, IPv6 ND (Neighbor Discovery) protocol is easy to be exploited by attackers. ND detection feature uses the entries in the IPv6-MAC binding table to filter the forged ND packets and prevent the ND attacks.

The application topology of ND Detection is as the following figure shows. The port that is connected to the gateway should be configured as trusted port, and other ports should be configured as untrusted ports. The forwarding principles of ND packets are as follows:

- All ND packets received on the trusted port will be forwarded without checked.
- RS (Router Solicitation) and NS (Neighbor Solicitation) packets with their source IPv6 addresses unspecified, such as the RS packet for IPv6 address request and the NS packet for duplicate address detection, will not be checked on both kinds of ports.
- RA (Router Advertisement) and RR (Router Redirect) packets received on the untrusted port will be discarded directly, and other ND packets will be checked: The switch will use the IPv6-MAC binding table to compare the IPv6 address, MAC address, VLAN ID and receiving port between the entry and the ND packet. If a match is found, the ND packet is considered legal and will be forwarded; if no match is found, the ND packet is considered illegal and will be discarded.

Figure 1-1 Network Topology of ND Detection

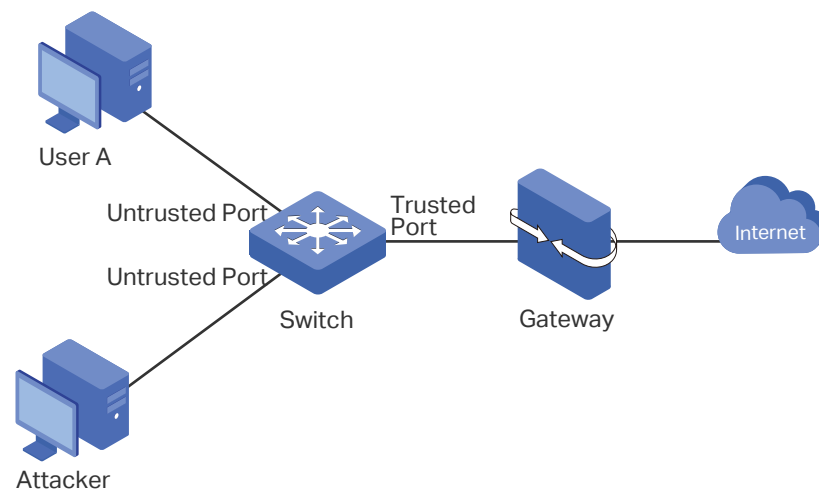

### IPv6 Source Guard

IPv6 Source Guard is used to filter the IPv6 packets based on the IPv6-MAC Binding table. Only the packets that match the binding rules are forwarded.

# 2 IPv6-MAC Binding Configuration

You can add IPv6-MAC Binding entries in three ways:

- Manual Binding
- Via ND Snooping
- Via DHCPv6 Snooping

Additionally, you can view, search and edit the entries in the Binding Table.

## 2.1 Using the GUI

### 2.1.1 Binding Entries Manually

You can manually bind the IPv6 address, MAC address, VLAN ID and the Port number together on the condition that you have got the detailed information of the hosts.

Choose the menu **SECURITY > IPv6 IMPB > IPv6-MAC Binding > Manual Binding** and click  **Add** to load the following page.

Figure 2-1 Manual Binding

IPv4-MAC Binding

Host Name:  (20 characters maximum)

IPv6 Address:  (Format: 2001::1)

MAC Address:  (Format: 00-00-00-00-00-01)

VLAN ID:  (1-4094)

Protect Type:  ▼

Port:  (Format: 1/0/1, input or choose below)

UNIT1
LAGS

2

4

6

8

10

12

14

16

18

20

22

24

26

28

1

3

5

7

9

11

13

15

17

19

21

23

25

27

Selected

Unselected

Not Available

Follow these steps to manually create an IPv6-MAC Binding entry:

User Guide ■ 666

- 1) Enter the following information to specify a host.

|              |   |
|--------------|---|
| Host Name    | Enter the host name for identification. |
| IPv6 Address | Enter the IPv6 address.                 |
| MAC Address  | Enter the MAC address.                  |
| VLAN ID      | Enter the VLAN ID.                      |

- 2) Select protect type for the entry.

|              |   |
|--------------|---|
| Protect Type | Select the protect type for the entry. The entry will be applied to to the specific feature. The following options are provided:<br><br><b>None:</b> This entry will not be applied to any feature.<br><br><b>ND Detection:</b> This entry will be applied to the ND Detection feature.<br><br><b>IPv6 Source Guard:</b> This entry will be applied to the IPv6 Source Guard feature.<br><br><b>Both:</b> This entry will be applied to both of the features. |
|--------------|---|

- 3) Enter or select the port that is connected to this host.
- 4) Click **Apply**.

## 2.1.2 Binding Entries via ND Snooping

With ND Snooping, the switch monitors the ND packets, and records the IPv6 addresses, MAC addresses, VLAN IDs and the connected port numbers of the IPv6 hosts. You can bind these entries conveniently.

---

### Note:

Before using this feature, make sure that your network is safe and the hosts are not suffering from ND attacks at present; otherwise, you may obtain incorrect IPv6-MAC Binding entries. If your network is being attacked, it's recommended to bind the entries manually.

---

Choose the menu **SECURITY > IPv6 IMPB > IPv6-MAC Binding > ND Snooping** to load the following page.

Figure 2-2 ND Snooping

**ND Snooping**

ND Snooping:  Enable Apply

---

**VLAN Config**

Filter by VLAN: From  To  Apply

| <input type="checkbox"/>            | VLAN ID | Status   |
|-------------------------------------|---------|--|
| <input checked="" type="checkbox"/> | 1       | Disabled   |
| <input type="checkbox"/>            | 6       | Disabled   |
| Total: 2                            |         | 1 entry selected. <span style="float: right; border: 1px solid #00a651; padding: 2px 10px; color: white;">Cancel</span> <span style="border: 1px solid #00a651; padding: 2px 10px; color: white;">Apply</span> |

---

**Port Config**

UNIT1

LAGS

| <input type="checkbox"/>            | Port   | Maximum Entries   | LAG   |
|-------------------------------------|--------|-------------------|---|
| <input checked="" type="checkbox"/> | 1/0/1  | 512               | ---   |
| <input type="checkbox"/>            | 1/0/2  | 512               | ---   |
| <input type="checkbox"/>            | 1/0/3  | 512               | ---   |
| <input type="checkbox"/>            | 1/0/4  | 512               | ---   |
| <input type="checkbox"/>            | 1/0/5  | 512               | ---   |
| <input type="checkbox"/>            | 1/0/6  | 512               | ---   |
| <input type="checkbox"/>            | 1/0/7  | 512               | ---   |
| <input type="checkbox"/>            | 1/0/8  | 512               | ---   |
| <input type="checkbox"/>            | 1/0/9  | 512               | ---   |
| <input type="checkbox"/>            | 1/0/10 | 512               | ---   |
| Total: 28                           |        | 1 entry selected. | Cancel <span style="border: 1px solid #00a651; padding: 2px 10px; color: white;">Apply</span> |

Follow these steps to configure IPv6-MAC Binding via ND Snooping:

- 1) In the **ND Snooping** section, enable ND Snooping and click **Apply**.
- 2) In the **VLAN Config** section, select one or more VLANs and enable ND Snooping. Click **Apply**.

|                |  |
|----------------|--|
| <b>VLAN ID</b> | Displays the VLAN ID.                      |
| <b>Status</b>  | Enable or disable ND Snooping on the VLAN. |

- 3) In the **Port Config** section, configure the maximum number of entries a port can learn via ND snooping. Click **Apply**.

|             |                           |
|-------------|---------------------------|
| <b>Port</b> | Displays the port number. |
|-------------|---------------------------|

**Maximum Entries** Configure the maximum number of binding entries a port can learn via ND snooping.

**LAG** Displays the LAG that the port is in.

- 4) The learned entries will be displayed in the Binding Table. You can go to **SECURITY > IPv6 IMPB > IPv6-MAC Binding > Binding Table** to view or edit the entries.

### 2.1.3 Binding Entries via DHCPv6 Snooping

With DHCPv6 Snooping enabled, the switch can monitor the IP address obtaining process of the host, and record the IPv6 address, MAC address, VLAN ID and the connected port number of the host.

Choose the menu **SECURITY > IPv6 IMPB > IPv6-MAC Binding > DHCPv6 Snooping** to load the following page.

Figure 2-3 DHCPv6 Snooping

Global Config

DHCPv6 Snooping:  Enable Apply

VLAN Config

Filter by VLAN: From  To  Apply

| <input type="checkbox"/>            | VLAN ID | Status   |
|-------------------------------------|---------|----------|
| <input checked="" type="checkbox"/> | 1       | Disabled |
| <input type="checkbox"/>            | 6       | Disabled |

Total: 2 1 entry selected. Cancel Apply

Port Config

UNIT1

LAGS

| <input type="checkbox"/>            | Port   | Maximum Entries | LAG |
|-------------------------------------|--------|-----------------|-----|
| <input checked="" type="checkbox"/> | 1/0/1  | 512             | --- |
| <input type="checkbox"/>            | 1/0/2  | 512             | --- |
| <input type="checkbox"/>            | 1/0/3  | 512             | --- |
| <input type="checkbox"/>            | 1/0/4  | 512             | --- |
| <input type="checkbox"/>            | 1/0/5  | 512             | --- |
| <input type="checkbox"/>            | 1/0/6  | 512             | --- |
| <input type="checkbox"/>            | 1/0/7  | 512             | --- |
| <input type="checkbox"/>            | 1/0/8  | 512             | --- |
| <input type="checkbox"/>            | 1/0/9  | 512             | --- |
| <input type="checkbox"/>            | 1/0/10 | 512             | --- |

Total: 28 1 entry selected. Cancel Apply



Follow these steps to configure IPv6-MAC Binding via DHCPv6 Snooping:

- 1) In the **Global Config** section, globally enable DHCPv6 Snooping. Click **Apply**.
- 2) In the **VLAN Config** section, enable DHCPv6 Snooping on a VLAN or range of VLANs. Click **Apply**.

|         |  |
|---------|--|
| VLAN ID | Displays the VLAN ID.                          |
| Status  | Enable or disable DHCPv6 Snooping on the VLAN. |

- 3) In the **Port Config** section, configure the maximum number of binding entries a port can learn via DHCPv6 snooping. Click **Apply**.

|                 |   |
|-----------------|---|
| Port            | Displays the port number.   |
| Maximum Entries | Configure the maximum number of binding entries a port can learn via DHCPv6 snooping. |
| LAG             | Displays the LAG that the port is in.   |

- 4) The learned entries will be displayed in the Binding Table. You can go to **SECURITY > IPv6 IMPB > IPv6-MAC Binding > Binding Table** to view or edit the entries.

### 2.1.4 Viewing the Binding Entries

In the Binding Table, you can view, search and edit the specified binding entries.

Choose the menu **SECURITY > IPv6 IMPB > IPv6-MAC Binding > Binding Table** to load the following page.

Figure 2-4 Binding Table

Binding Table

Source:

IP Address:  (Format: 2001::1)

| <input checked="" type="checkbox"/> | Host Name | IP Address | MAC Address       | VLAN ID | Port  | Protect Type | Source |
|-------------------------------------|-----------|------------|-------------------|---------|-------|--------------|--------|
| <input checked="" type="checkbox"/> | host1     | 2001::3    | aa-bb-cc-dd-ee-ff | 1       | 1/0/2 | ND Detection | Manual |

1 entry selected.

You can specify the search criteria to search your desired entries.

|        |   |
|--------|---|
| Source | Select the source of the entry and click <b>Search</b> .<br><br><b>All:</b> Displays the entries from all sources.<br><br><b>Manual Binding:</b> Displays the manually bound entries.<br><br><b>ND Snooping:</b> Displays the binding entries learned from ND Snooping.<br><br><b>DHCPv6 Snooping:</b> Displays the binding entries learned from DHCP Snooping. |
| IP     | Enter an IP address and click <b>Search</b> to search the specific entry.   |

Additionally, you select one or more entries to edit the host name and protect type and click **Apply**.

|              |   |
|--------------|---|
| Host Name    | Enter a host name for identification.   |
| IP Address   | Displays the IPv6 address.  |
| MAC Address  | Displays the MAC address.   |
| VLAN ID      | Displays the VLAN ID.   |
| Port         | Displays the port number.   |
| Protect Type | Select the protect type for the entry. The entry will be applied to to the specific feature. The following options are provided:<br><br><b>None:</b> This entry will not be applied to any feature.<br><br><b>ND Detection:</b> This entry will be applied to the ND Detection feature.<br><br><b>IPv6 Source Guard:</b> This entry will be applied to the IP Source Guard feature.<br><br><b>Both:</b> This entry will be applied to both of the features. |
| Source       | Displays the source of the entry.   |

## 2.2 Using the CLI

The following sections introduce how to bind entries manually and via ND Snooping and DHCP Snooping, and how to view the binding entries.

### 2.2.1 Binding Entries Manually

You can manually bind the IPv6 address, MAC address, VLAN ID and the Port number together on the condition that you have got the detailed information of the hosts.

Follow these steps to manually bind entries:

|        |   |
|--------|---|
| Step 1 | <b>configure</b><br>Enter global configuration mode.  |
| Step 2 | <b>ipv6 source binding</b> <i>hostname ipv6-addr mac-addr</i> <b>vlan</b> <i>vlan-id</i> <b>interface</b> { <b>fastEthernet</b> <i>port</i>   <b>gigabitEthernet</b> <i>port</i>   <b>ten-gigabitEthernet</b> <i>port</i>   <b>port-channel</b> <i>port-channel-id</i> } { <b>none</b>   <b>nd-detection</b>   <b>ipv6-verify-source</b>   <b>both</b> }<br><br>Manually bind the host name, IP address, MAC address, VLAN ID and port number of the host, and configure the protect type for the host.<br><br><i>hostname</i> : Specify a name for the host. It contains 20 characters at most.<br><br><i>ipv6-addr</i> : Enter the IPv6 address of the host.<br><br><i>mac-addr</i> : Enter the MAC address of the host, in the format of xx:xx:xx:xx:xx:xx.<br><br><i>vlan-id</i> : Enter the VLAN ID of the host.<br><br><i>port</i> : Enter the number of the port on which the host is connected.<br><br><b>none</b>   <b>nd-detection</b>   <b>ipv6-verify-source</b>   <b>both</b> : Specify the protect type for the entry. None indicates this entry will not be applied to any feature; nd-detection indicates this entry will be applied to ND Detection; ipv6-verify-source indicates this entry will be applied to IP Source Guard; both indicates this entry will be applied to both ND Detection and IP Source Guard. |
| Step 3 | <b>show ip source binding</b><br>Verify the binding entry.  |
| Step 4 | <b>end</b><br>Return to privileged EXEC mode.   |
| Step 5 | <b>copy running-config startup-config</b><br>Save the settings in the configuration file.   |

The following example shows how to bind an entry with the hostname host1, IPv6 address 2001:0:9d38:90d5::34, MAC address AA-BB-CC-DD-EE-FF, VLAN ID 10, port number 1/0/5, and enable this entry for ND Detection.

### Switch#configure

```
Switch(config)#ipv6 source binding host1 2001:0:9d38:90d5::34 aa:bb:cc:dd:ee:ff vlan 10
interface gigabitEthernet 1/0/5 nd-detection
```

### Switch(config)#show ipv6 source binding

| U | Host  | IP-Addr              | MAC-Addr          | VID | Port    | ACL  | Source |
|---|-------|----------------------|-------------------|-----|---------|------|--------|
| - | ----  | -----                | -----             | --- | ----    | ---  | -----  |
| 1 | host1 | 2001:0:9d38:90d5::34 | aa:bb:cc:dd:ee:ff | 10  | Gi1/0/5 | ND-D | Manual |

### Switch(config)#end

### Switch#copy running-config startup-config

## 2.2.2 Binding Entries via ND Snooping

Follow these steps to bind entries via ND Snooping:

|        |   |
|--------|---|
| Step 1 | <b>configure</b><br>Enter global configuration mode.  |
| Step 2 | <b>ipv6 nd snooping</b><br>Globally enable ND Snooping.   |
| Step 3 | <b>ipv6 nd snooping vlan <i>vlan-range</i></b><br>Enable ND Snooping on the specified VLAN.<br><br><i>vlan-range</i> : Enter the vlan range in the format of 1-3, 5.  |
| Step 4 | <b>interface { fastEthernet <i>port</i>   range fastEthernet <i>port-list</i>   gigabitEthernet <i>port</i>   range gigabitEthernet <i>port-list</i>   ten-gigabitEthernet <i>port</i>   range ten-gigabitEthernet <i>port-list</i>}</b><br>Enter interface configuration mode.                               |
| Step 5 | <b>ipv6 nd snooping max-entries <i>value</i></b><br>Configure the maximum number of ND binding entries a port can learn via ND snooping.<br><br><i>value</i> : Enter the maximum number of ND binding entries a port can learn via ND snooping. The valid values are from 0 to 1024, and the default is 1024. |
| Step 6 | <b>show ipv6 nd snooping</b><br>Verify the global configuration of IPv6 ND Snooping   |
| Step 7 | <b>show ipv6 nd snooping interface { fastEthernet <i>port</i>   gigabitEthernet <i>port</i>   ten-gigabitEthernet <i>port</i> }</b><br>Verify the IPv6 ND Snooping configuration of the specific port.  |
| Step 8 | <b>end</b><br>Return to privileged EXEC mode.   |
| Step 9 | <b>copy running-config startup-config</b><br>Save the settings in the configuration file.   |

The following example shows how to enable ND Snooping globally and on VLAN 1.

```
Switch#configure
```

```
Switch(config)#ipv6 nd snooping
```

```
Switch(config)#ipv6 nd snooping vlan 1
```

```
Switch(config)#show ipv6 nd snooping
```

```
Global Status: Enable
```

```
VLAN ID: 1
```

```
Switch(config)#end
```

```
Switch#copy running-config startup-config
```

The following example shows how to configure the maximum number of entries that can be learned on port 1/0/1:

```
Switch#configure
```

```
Switch(config)#interface gigabitEthernet 1/0/1
```

```
Switch(config-if)#ipv6 nd snooping max-entries 1000
```

```
Switch(config-if)#show ipv6 nd snooping interface gigabitEthernet 1/0/1
```

```
Interface  max-entries  LAG
-----  -
Gi1/0/1    1000             N/A
```

```
Switch(config-if)#end
```

```
Switch#copy running-config startup-config
```

## 2.2.3 Binding Entries via DHCPv6 Snooping

Follow these steps to bind entries via DHCP Snooping:

|        |   |
|--------|---|
| Step 1 | <b>configure</b><br>Enter global configuration mode.  |
| Step 2 | <b>ipv6 dhcp snooping</b><br>Globally enable DHCPv6 Snooping.   |
| Step 3 | <b>ipv6 dhcp snooping vlan <i>vlan-range</i></b><br>Enable DHCPv6 Snooping on the specified VLAN.<br><br><i>vlan-range</i> : Enter the vlan range in the format of 1-3, 5.  |
| Step 4 | <b>interface { fastEthernet <i>port</i>   range fastEthernet <i>port-list</i>   gigabitEthernet <i>port</i>   range gigabitEthernet <i>port-list</i>   ten-gigabitEthernet <i>port</i>   range ten-gigabitEthernet <i>port-list</i>   interface port-channel <i>port-channel-id</i>   interface range port-channel <i>port-channel-id-list</i> }</b><br>Enter interface configuration mode. |
| Step 5 | <b>ipv6 dhcp snooping max-entries <i>value</i></b><br>Configure the maximum number of binding entries the port can learn via DHCPv6 snooping.<br><br><i>value</i> : Enter the value of maximum number of entries. The valid values are from 0 to 512.   |
| Step 6 | <b>show ip dhcp snooping</b><br>Verify global configuration of DHCPv6 Snooping.   |

---

|        |   |
|--------|---|
| Step 7 | <b>end</b><br>Return to privileged EXEC mode.   |
| Step 8 | <b>copy running-config startup-config</b><br>Save the settings in the configuration file. |

---

The following example shows how to enable DHCPv6 Snooping globally and on VLAN 5, and set the maximum number of binding entries port 1/0/1 can learn via DHCPv6 snooping as 100:

**Switch#configure**

**Switch(config)#ipv6 dhcp snooping**

**Switch(config)#ipv6 dhcp snooping vlan 5**

**Switch(config)#interface gigabitEthernet 1/0/1**

**Switch(config-if)#ipv6 dhcp snooping max-entries 100**

**Switch(config-if)#show ipv6 dhcp snooping**

Global Status: Enable

VLAN ID: 5

**Switch(config-if)#show ipv6 dhcp snooping interface gigabitEthernet 1/0/1**

Interface max-entries LAG

```
-----
-----
-----
Gi1/0/1  100      N/A
```

**Switch(config-if)#end**

**Switch#copy running-config startup-config**

## 2.2.4 Viewing Binding Entries

On privileged EXEC mode or any other configuration mode, you can use the following command to view binding entries:

---

**show ipv6 source binding**

View the information of binding entries, including the host name, IP address, MAC address, VLAN ID, port number and protect type.

---

# 3 ND Detection Configuration

To complete ND Detection configuration, follow these steps:

- 1) Add IPv6-MAC Binding entries.
- 2) Enable ND Detection.
- 3) Configure ND Detection on ports.
- 4) View ND statistics.

## 3.1 Using the GUI

### 3.1.1 Adding IPv6-MAC Binding Entries

The ND Detection feature allows the switch to detect the ND packets based on the binding entries in the IPv6-MAC Binding Table and filter out the illegal ND packets. Before configuring ND Detection, complete IPv6-MAC Binding configuration. For details, refer to [IPv6-MAC Binding Configuration](#).

### 3.1.2 Enabling ND Detection

Choose the menu **SECURITY > IPv6 IMPB > ND Detection > Global Config** to load the following page.

Figure 3-1 ND Detection Global Config

| <input type="checkbox"/>            | VLAN ID | Status            | Log Status |
|-------------------------------------|---------|-------------------|------------|
| <input checked="" type="checkbox"/> | 1       | Disabled          | Disabled   |
| <input type="checkbox"/>            | 8       | Disabled          | Disabled   |
| Total: 2                            |         | 1 entry selected. |            |

Follow these steps to enable ND Detection:

- 1) In the **Global Config** section, enable ND Detection and configure the related parameters. Click **Apply**.

**ND Detection**      Enable or disable ND Detection globally.

- 2) In the **VLAN Config** section, enable ND Detection on the selected VLANs. Click **Apply**.

|            |  |
|------------|--|
| VLAN ID    | Displays the VLAN ID.  |
| Status     | Enable or disable ND Detection on the VLAN.  |
| Log Status | Enable or disable Log feature on the VLAN. With this feature enabled, the switch generates a log when an illegal ND packet is discarded. |

### 3.1.3 Configuring ND Detection on Ports

Choose the menu **SECURITY > IPv6 IMPB > ND Detection >Port Config** to load the following page.

Figure 3-2 ND Detection on Port

Port Config

UNIT1 LAGS

| <input type="checkbox"/>            | Port   | Trust Status | LAG |
|-------------------------------------|--------|--------------|-----|
| <input checked="" type="checkbox"/> | 1/0/1  | Disabled     | --- |
| <input type="checkbox"/>            | 1/0/2  | Disabled     | --- |
| <input type="checkbox"/>            | 1/0/3  | Disabled     | --- |
| <input type="checkbox"/>            | 1/0/4  | Disabled     | --- |
| <input type="checkbox"/>            | 1/0/5  | Disabled     | --- |
| <input type="checkbox"/>            | 1/0/6  | Disabled     | --- |
| <input type="checkbox"/>            | 1/0/7  | Disabled     | --- |
| <input type="checkbox"/>            | 1/0/8  | Disabled     | --- |
| <input type="checkbox"/>            | 1/0/9  | Disabled     | --- |
| <input type="checkbox"/>            | 1/0/10 | Disabled     | --- |

Total: 28 1 entry selected. Cancel Apply

Follow these steps to configure ND Detection on ports:

- 1) Select one or more ports and configure the parameters.

|              |   |
|--------------|---|
| Port         | Displays the port number.   |
| Trust Status | Enable or disable this port to be a trusted port. On a trusted port, the ND packets are forwarded directly without checked. The specific ports, such as up-link ports and routing ports are suggested to be set as trusted. |
| LAG          | Displays the LAG that the port is in.   |

- 2) Click **Apply**.

### 3.1.4 Viewing ND Statistics

You can view the number of the illegal ND packets received on each port, which facilitates you to locate the network malfunction and take the related protection measures.



Choose the menu **SECURITY > IPv6 IMPB > ND Detection > ND Statistics** to load the following page.

Figure 3-3 View ND Statistics



Auto Refresh

---

Auto Refresh:  Enable Apply

---

Illegal ND Packets

 Refresh
 Clear

| VLAN ID  | Forwarded | Dropped |
|----------|-----------|---------|
| 1        | 0         | 0       |
| 8        | 0         | 0       |
| Total: 2 |           |         |

In the **Auto Refresh** section, you can enable the auto refresh feature and specify the refresh interval, and thus the web page will be automatically refreshed.

In the **Illegal ND Packet** section, you can view the number of illegal ND packets in each VLAN.

|                  |   |
|------------------|---|
| <b>VLAN ID</b>   | Displays the VLAN ID.                                     |
| <b>Forwarded</b> | Displays the number of forwarded ND packets in this VLAN. |
| <b>Dropped</b>   | Displays the number of dropped ND packets in this VLAN.   |

## 3.2 Using the CLI

### 3.2.1 Adding IPv6-MAC Binding Entries

The ND Detection feature allows the switch to detect the ND packets based on the binding entries in the IPv6-MAC Binding Table and filter out the illegal ND packets. Before configuring ND Detection, complete IPv6-MAC Binding configuration. For details, refer to [IPv6-MAC Binding Configuration](#).

### 3.2.2 Enabling ND Detection

Follow these steps to enable ND Detection:

|        |  |
|--------|--|
| Step 1 | <p><b>configure</b></p> <p>Enter global configuration mode.</p>                  |
| Step 2 | <p><b>ipv6 nd detection</b></p> <p>Globally enable the ND Detection feature.</p> |

- 
- Step 3      **ipv6 nd detection vlan *vlan-range***  
 Enable ND Detection on the specified VLAN.  
*vlan-range*: Enter the vlan range in the format of 1-3, 5.
- 
- Step 4      **ipv6 nd detection vlan *vlan-range* logging**  
 (Optional) Enable the Log feature to make the switch generate a log when an ND packet is discarded.  
*vlan-range*: Enter the vlan range in the format of 1-3, 5.
- 
- Step 5      **show ipv6 nd detection**  
 Verify the global ND Detection configuration.
- 
- Step 6      **end**  
 Return to privileged EXEC mode.
- 
- Step 7      **copy running-config startup-config**  
 Save the settings in the configuration file.
- 

The following example shows how to enable ND Detection globally and on VLAN 1:

**Switch#configure**

**Switch(config)#ipv6 nd detection**

**Switch(config)#ipv6 nd detection vlan 1**

**Switch(config)#show ipv6 nd detection**

Global Status: Enable

**Switch(config)#show ipv6 nd detection vlan**

| VID  | Enable status | Log Status |
|------|---------------|------------|
| ---- | -----         | -----      |
| 1    | Enable        | Disable    |

**Switch(config)#end**

**Switch#copy running-config startup-config**

### 3.2.3 Configuring ND Detection on Ports

Follow these steps to configure ND Detection on ports:

- 
- Step 1      **configure**  
 Enter global configuration mode.
-

|        |  |
|--------|--|
| Step 2 | <b>interface { fastEthernet port   range fastEthernet port-list   gigabitEthernet port   range gigabitEthernet port-list   ten-gigabitEthernet port   range ten-gigabitEthernet port-list }</b><br>Enter interface configuration mode. |
| Step 3 | <b>ipv6 nd detection trust</b><br>Configure the port as a trusted port, on which the ND packets will not be checked. The specific ports, such as up-linked ports and routing ports are suggested to be set as trusted ports.           |
| Step 4 | <b>show ipv6 nd detection interface { fastEthernet port   gigabitEthernet port   ten-gigabitEthernet port   port-channel port-channel-id }</b><br>Verify the global ND Detection configuration of the port.                            |
| Step 5 | <b>end</b><br>Return to privileged EXEC mode.  |
| Step 6 | <b>copy running-config startup-config</b><br>Save the settings in the configuration file.  |

The following example shows how to configure port 1/0/1 as trusted port:

**Switch#configure**

**Switch(config)#interface gigabitEthernet 1/0/1**

**Switch(config-if)#ipv6 nd detection trust**

**Switch(config-if)#show ipv6 nd detection interface gigabitEthernet 1/0/1**

```
Interface Trusted LAG
```

```
-----
```

```
Gi1/0/1 Enable N/A
```

**Switch(config-if)#end**

**Switch#copy running-config startup-config**

### 3.2.4 Viewing ND Statistics

On privileged EXEC mode or any other configuration mode, you can use the following command to view ND statistics:

**show ipv6 nd detection statistics**

View the ND statistics on each port, including the number of forwarded ND packets and the number of dropped ND packets.

# 4 IPv6 Source Guard Configuration

To complete IPv6 Source Guard configuration, follow these steps:

- 1) Add IP-MAC Binding entries.
- 2) Configure IPv6 Source Guard.

## 4.1 Using the GUI

### 4.1.1 Adding IPv6-MAC Binding Entries

The ND Detection feature allows the switch to detect the ND packets based on the binding entries in the IPv6-MAC Binding Table and filter out the illegal ND packets. Before configuring ND Detection, complete IPv6-MAC Binding configuration. For details, refer to [IPv6-MAC Binding Configuration](#).

### 4.1.2 Configuring IPv6 Source Guard

Before configuring IPv6 Source Guard, you need to configure the SDM template as EnterpriseV6.

Choose the menu **SECURITY > IPv6 IMPB > IPv6 Source Guard** to load the following page.

Figure 4-1 IPv6 Source Guard Config

| <input type="checkbox"/>            | Port   | Security Type | LAG |
|-------------------------------------|--------|---------------|-----|
| <input checked="" type="checkbox"/> | 1/0/1  | Disable       | --  |
| <input type="checkbox"/>            | 1/0/2  | Disable       | --  |
| <input type="checkbox"/>            | 1/0/3  | Disable       | --  |
| <input type="checkbox"/>            | 1/0/4  | Disable       | --  |
| <input type="checkbox"/>            | 1/0/5  | Disable       | --  |
| <input type="checkbox"/>            | 1/0/6  | Disable       | --  |
| <input type="checkbox"/>            | 1/0/7  | Disable       | --  |
| <input type="checkbox"/>            | 1/0/8  | Disable       | --  |
| <input type="checkbox"/>            | 1/0/9  | Disable       | --  |
| <input type="checkbox"/>            | 1/0/10 | Disable       | --  |

Total: 28      1 entry selected.      Cancel Apply

Follow these steps to configure IPv6 Source Guard:

- 1) Select one or more ports and configure the protect type for ports.

|               |   |
|---------------|---|
| Port          | Displays the port number.   |
| Security Type | <p>Select Security Type on the port for IPv6 packets. The following options are provided:</p> <p><b>Disable:</b> The IP Source Guard feature is disabled on the port.</p> <p><b>SIPv6+MAC:</b> Only the packet with its source IPv6 address, source MAC address and port number matching the IPv6-MAC binding rules can be processed, otherwise the packet will be discarded.</p> <p><b>SIPv6:</b> Only the packet with its source IPv6 address and port number matching the IPv6-MAC binding rules can be processed, otherwise the packet will be discarded.</p> |
| LAG           | Displays the LAG that the port is in.   |

2) Click **Apply**.

## 4.2 Using the CLI

### 4.2.1 Adding IPv6-MAC Binding Entries

The ND Detection feature allows the switch to detect the ND packets based on the binding entries in the IPv6-MAC Binding Table and filter out the illegal ND packets. Before configuring ND Detection, complete IPv6-MAC Binding configuration. For details, refer to [IPv6-MAC Binding Configuration](#).

### 4.2.2 Configuring IPv6 Source Guard

Before configuring IPv6 Source Guard, you need to configure the SDM template as EnterpriseV6.

Follow these steps to configure IPv6 Source Guard:

|        |  |
|--------|--|
| Step 1 | <p><b>configure</b></p> <p>Enter global configuration mode.</p>  |
| Step 2 | <p><b>interface { fastEthernet port   range fastEthernet port-list   gigabitEthernet port   range gigabitEthernet port-list   ten-gigabitEthernet port   range ten-gigabitEthernet port-list }</b></p> <p>Enter interface configuration mode.</p>  |
| Step 3 | <p><b>ipv6 verify source { sipv6+mac   sipv6 }</b></p> <p>Enable IPv6 Source Guard for IPv6 packets.</p> <p><b>sipv6+mac:</b> Only the packet with its source IP address, source MAC address and port number matching the IPv6-MAC binding rules can be processed, otherwise the packet will be discarded.</p> |

---

Step 4      **show ipv6 verify source [ interface { fastEthernet port | gigabitEthernet port | ten-gigabitEthernet port | port-channel port-channel-id } ]**

Verify the IP Source Guard configuration for IPv6 packets.

---

Step 5      **end**

Return to privileged EXEC mode.

---

Step 6      **copy running-config startup-config**

Save the settings in the configuration file.

---

The following example shows how to enable IPv6 Source Guard on port 1/0/1:

**Switch#configure**

**Switch(config)#interface gigabitEthernet 1/0/1**

**Switch(config-if)#ipv6 verify source sipv6+mac**

**Switch(config-if)#show ipv6 verify source interface gigabitEthernet 1/0/1**

| Port    | Security-Type | LAG  |
|---------|---------------|------|
| ----    | -----         | ---- |
| Gi1/0/1 | SIPv6+MAC     | N/A  |

**Switch(config-if)#end**

**Switch#copy running-config startup-config**

# 5 Configuration Examples

## 5.1 Example for ND Detection

### 5.1.1 Network Requirements

As shown below, User 1 and User 2 are legal IPv6 users in the LAN and connected to port 1/0/1 and port 1/0/2. Both of them are in the default VLAN 1. The router has been configured with security feature to prevent attacks from the WAN. Now the network administrator wants to configure Switch A to prevent ND attacks from the LAN.

Figure 5-1 Network Topology

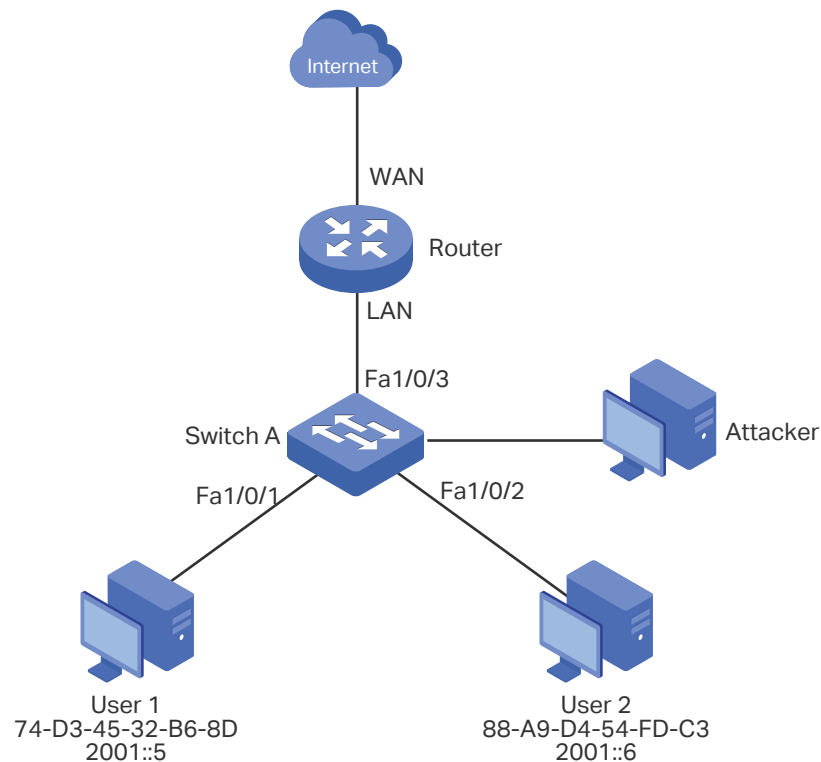

### 5.1.2 Configuration Scheme

To meet the requirement, you can configure ND Detection to prevent the network from ND attacks in the LAN.

The overview of configurations on the switch is as follows:

- 1) Configure IPv6-MAC Binding. The binding entries for User 1 and User 2 should be manually bound.
- 2) Configure ND Detection globally.

- Configure ND Detection on ports. Since port 1/0/3 is connected to the gateway router, set port 1/0/3 as trusted port.

Demonstrated with T1500-28PCT, the following sections provide configuration procedure in two ways: using the GUI and using the CLI.

### 5.1.3 Using the GUI

- Choose the menu **SECURITY > IPv6 IMPB > IPv6-MAC Binding > Manual Binding** and click **+ Add** to load the following page. Enter the host name, IPv6 address, MAC address and VLAN ID of User 1, select the protect type as ND Detection, and select port 1/0/1 on the panel. Click **Apply**.

Figure 5-2 Binding Entry for User 1

The screenshot shows the 'IPv6-MAC Binding' configuration page. The form fields are as follows:

- Host Name: User1 (20 characters maximum)
- IPv6 Address: 2001::5 (Format: 2001::1)
- MAC Address: 74-D3-45-32-B6-8D (Format: 00-00-00-00-00-01)
- VLAN ID: 1 (1-4094)
- Protect Type: ND Detection
- Port: 1/0/1 (Format: 1/0/1, input or choose below)

Below the form, there is a port selection grid. The grid is divided into 'UNIT1' and 'LAGS'. The 'UNIT1' section shows ports 2 through 28. Port 1 is highlighted in blue, indicating it is selected. The 'LAGS' section shows ports 3 through 27. A legend below the grid indicates that a blue square represents 'Selected', a white square represents 'Unselected', and a grey square represents 'Not Available'. The 'Apply' button is highlighted in red.

- In the same way, add a binding entry for User 2. Enter the host name, IPv6 address, MAC address and VLAN ID of User 2, select the protect type as ND Detection, and select port 1/0/2 on the panel. Click **Apply**.



Figure 5-3 Binding Entry for User 2

**IPv6-MAC Binding**

Host Name:  (20 characters maximum)

IPv6 Address:  (Format: 2001::1)

MAC Address:  (Format: 00-00-00-00-00-01)

VLAN ID:  (1-4094)

Protect Type:  ▼

Port:  (Format: 1/0/1, input or choose below)

UNIT1 LAGS

2
  4
  6
  8
  10
  12
  14
  16
  18
  20
  22
  24
  26
  28

1
  3
  5
  7
  9
  11
  13
  15
  17
  19
  21
  23
  25
  27

Selected
  Unselected
  Not Available

- Choose the menu **SECURITY > IPv6 IMPB > ND Detection > Global Config** to load the following page. Enable ND Detection and click **Apply**. Select VLAN 1, change Status as Enabled and click **Apply**.

Figure 5-4 Enable ND Detection

**Global Config**

ND Detection:  Enable

**VLAN Config**

| <input checked="" type="checkbox"/> | VLAN ID | Status  | Log Status |
|-------------------------------------|---------|---------|------------|
| <input checked="" type="checkbox"/> | 1       | Enabled | Disabled   |

Total: 1 1 entry selected.

- Choose the menu **SECURITY > IPv6 IMPB > ND Detection > Port Config** to load the following page. By default, all ports are enabled with ND Detection. Since port 1/0/3 is connected to the gateway router, configure port 1/0/3 as trusted port. Click **Apply**.

Figure 5-5 Port Config

Port Config

UNIT1 LAGS

| <input type="checkbox"/>            | Port   | Trust Status | LAG |
|-------------------------------------|--------|--------------|-----|
| <input type="checkbox"/>            | 1/0/1  | Disabled     | --- |
| <input type="checkbox"/>            | 1/0/2  | Disabled     | --- |
| <input checked="" type="checkbox"/> | 1/0/3  | Enabled      | --- |
| <input type="checkbox"/>            | 1/0/4  | Disabled     | --- |
| <input type="checkbox"/>            | 1/0/5  | Disabled     | --- |
| <input type="checkbox"/>            | 1/0/6  | Disabled     | --- |
| <input type="checkbox"/>            | 1/0/7  | Disabled     | --- |
| <input type="checkbox"/>            | 1/0/8  | Disabled     | --- |
| <input type="checkbox"/>            | 1/0/9  | Disabled     | --- |
| <input type="checkbox"/>            | 1/0/10 | Disabled     | --- |

Total: 28 1 entry selected. Cancel Apply

- 5) Click  Save to save the settings.

### 5.1.4 Using the CLI

- 1) Manually bind the entries for User 1 and User 2.

```
Switch_A#configure
```

```
Switch_A(config)#ipv6 source binding User1 2001::5 74:d3:45:32:b6:8d vlan 1 interface
fastEthernet 1/0/1 nd-detection
```

```
Switch_A(config)#ip source binding User1 2001::6 88:a9:d4:54:fd:c3 vlan 1 interface
fastEthernet 1/0/2 nd-detection
```

- 2) Enable ND Detection globally and on VLAN 1.

```
Switch_A(config)#ipv6 nd detection vlan 1
```

- 3) Configure port 1/0/3 as trusted port.

```
Switch_A(config)#interface fastEthernet 1/0/3
```

```
Switch_A(config-if)#ipv6 nd detection trust
```

```
Switch_A(config-if)#end
```

```
Switch_A#copy running-config startup-config
```

### Verify the Configuration

Verify the IPv6-MAC Binding entries:

```
Switch_A#show ipv6 source binding
```

| U | Host  | IP-Addr | MAC-Addr          | VID | Port    | ACL  | SOURCE |
|---|-------|---------|-------------------|-----|---------|------|--------|
| - | ----  | -----   | -----             | --- | ----    | ---  | -----  |
| 1 | User1 | 2001::5 | 74:d3:45:32:b6:8d | 1   | Fa1/0/1 | ND-D | Manual |
| 1 | User2 | 2001::6 | 88:a9:d4:54:fd:c3 | 1   | Fa1/0/2 | ND-D | Manual |

Notice:

1.Here, 'ND-D' for 'ND-Detection',and'IP-V-S' for 'IP-Verify-Source'.

Verify the global configuration of ND Detection:

```
Switch_A#show ipv6 nd detection
```

Global Status: Enable

Verify the ND Detection configuration on VLAN:

```
Switch_A#show ipv6 nd detection vlan
```

| VID  | Enable status | Log Status |
|------|---------------|------------|
| ---- | -----         | -----      |
| 1    | Enable        | Disable    |

Verify the ND Detection configuration on ports:

```
Switch_A#show ipv6 nd detection interface
```

| Interface | Trusted | LAG |
|-----------|---------|-----|
| -----     | -----   | --- |
| Gi1/0/1   | Disable | N/A |
| Gi1/0/2   | Disable | N/A |
| Gi1/0/3   | Enable  | N/A |

...

## 5.2 Example for IPv6 Source Guard

### 5.2.1 Network Requirements

As shown below, the legal IPv6 host connects to the switch via port 1/0/1 and belongs to the default VLAN 1. It is required that only the legal host can access the network via port

1/0/1, and other unknown hosts will be blocked when trying to access the network via ports 1/0/1-3.

Figure 5-6 Network Topology

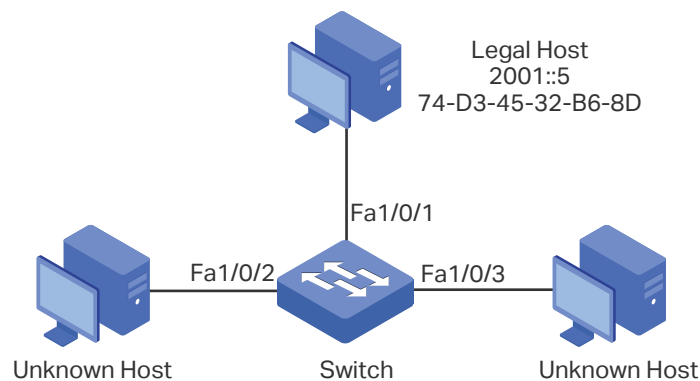

## 5.2.2 Configuration Scheme

To implement this requirement, you can use IPv6-MAC Binding and IPv6 Source Guard to filter out the packets received from the unknown hosts. The overview of configuration on the switch is as follows:

- 1) Bind the MAC address, IPv6 address, connected port number and VLAN ID of the legal host with IPv6-MAC Binding.
- 2) Enable IPv6 Source Guard on ports 1/0/1-3.

Demonstrated with T1500-28PCT, the following sections provide configuration procedure in two ways: using the GUI and using the CLI.

## 5.2.3 Using the GUI

- 1) Choose the menu **SECURITY > IPv6 IMPB > IPv6-MAC Binding > Manual Binding** and click **+ Add** to load the following page. Enter the host name, IPv6 address, MAC address and VLAN ID of the legal host, select the protect type as , and select port 1/0/1 on the panel. Click **Apply**.

Figure 5-7 Manual Binding

**IPv6-MAC Binding**

Host Name: LegalHost (20 characters maximum)

IPv6 Address: 2001::5 (Format: 2001::1)

MAC Address: 74-D3-45-32-B6-8D (Format: 00-00-00-00-00-01)

VLAN ID: 1 (1-4094)

Protect Type: IPv6 Source Guard

Port: 1/0/1 (Format: 1/0/1, input or choose below)

UNIT1 LAGS

2 4 6 8 10 12 14 16 18 20 22 24 26 28

1 3 5 7 9 11 13 15 17 19 21 23 25 27

Selected Unselected Not Available

Cancel Apply

- 2) Choose the menu **SECURITY > IPv6 IMPB > IPv6 Source Guard** to load the following page. Select ports 1/0/1-3, configure the Security Type as SIPv6+MAC, and click **Apply**.

Figure 5-8 IPv6 Source Guard

**IPv6 Source Guard Config**

UNIT1 LAGS

| <input type="checkbox"/>            | Port   | Security Type | LAG |
|-------------------------------------|--------|---------------|-----|
| <input checked="" type="checkbox"/> | 1/0/1  | SIPv6+MAC     | --- |
| <input checked="" type="checkbox"/> | 1/0/2  | SIPv6+MAC     | --- |
| <input checked="" type="checkbox"/> | 1/0/3  | SIPv6+MAC     | --- |
| <input type="checkbox"/>            | 1/0/4  | Disable       | --- |
| <input type="checkbox"/>            | 1/0/5  | Disable       | --- |
| <input type="checkbox"/>            | 1/0/6  | Disable       | --- |
| <input type="checkbox"/>            | 1/0/7  | Disable       | --- |
| <input type="checkbox"/>            | 1/0/8  | Disable       | --- |
| <input type="checkbox"/>            | 1/0/9  | Disable       | --- |
| <input type="checkbox"/>            | 1/0/10 | Disable       | --- |

Total: 28 3 entries selected. Cancel Apply

- 3) Click  Save to save the settings.

## 5.2.4 Using the CLI

- 1) Manually bind the IPv6 address, MAC address, VLAN ID and connected port number of the legal host, and apply this entry to the IPv6 Source Guard feature.

```
Switch#configure
```

```
Switch(config)#ipv6 source binding legal-host 2001::5 74:d3:45:32:b6:8d vlan 1
interface fastEthernet 1/0/1 ipv6-verify-source
```

- 2) Enable IPv6 Source Guard on ports 1/0/1-3.

```
Switch(config)# ipv6 verify source
```

```
Switch(config)# interface range fastEthernet 1/0/1-3
```

```
Switch(config-if-range)#ipv6 verify source sipv6+mac
```

```
Switch(config-if-range)#end
```

```
Switch#copy running-config startup-config
```

### Verify the Configuration

Verify the binding entry:

```
Switch#show ip source binding
```

| U | Host       | IP-Addr | MAC-Addr          | VID | Port    | ACL    | SOURCE |
|---|------------|---------|-------------------|-----|---------|--------|--------|
| - | ----       | -----   | -----             | --- | ----    | ---    | -----  |
| 1 | legal-host | 2001::5 | 74:d3:45:32:b6:8d | 1   | Fa1/0/1 | IP-V-S | Manual |

Notice:

1. Here, 'ND-D' for 'ND-Detection', and 'IP-V-S' for 'IP-Verify-Source'.

Verify the configuration of IPv6 Source Guard:

```
Switch#show ipv6 verify source
```

| Port    | Security-Type | LAG |
|---------|---------------|-----|
| Gi1/0/1 | SIPv6+MAC     | N/A |
| Gi1/0/2 | SIPv6+MAC     | N/A |
| Gi1/0/3 | SIPv6+MAC     | N/A |

...

# 6 Appendix: Default Parameters

Default settings of DHCP Snooping are listed in the following table:

Table 6-1 DHCPv6 Snooping

| Parameter       | Default Setting |
|-----------------|-----------------|
| Global Config   |                 |
| DHCPv6 Snooping | Disabled        |
| VLAN Config     |                 |
| Status          | Disabled        |
| Port Config     |                 |
| Maximum Entry   | 512             |

Default settings of ND Detection are listed in the following table:

Table 6-2 ND Detection

| Parameter        | Default Setting |
|------------------|-----------------|
| Global Config    |                 |
| ND Detection     | Disabled        |
| VLAN Config      |                 |
| Status           | Disabled        |
| Log Status       | Disabled        |
| Port Config      |                 |
| Trust Status     | Disabled        |
| ND Statistics    |                 |
| Auto Refresh     | Disabled        |
| Refresh Interval | 5 seconds       |

Default settings of IPv6 Source Guard are listed in the following table:

Table 6-3 ND Detection

| Parameter     | Default Setting |
|---------------|-----------------|
| Port Config   |                 |
| Security Type | Disabled        |



# Part 22

## Configuring DHCP Filter

### CHAPTERS

1. DHCP Filter
2. DHCPv4 Filter Configuration
3. DHCPv6 Filter Configuration
4. Configuration Examples
5. Appendix: Default Parameters

# 1 DHCP Filter

## 1.1 Overview

During the working process of DHCP, generally there is no authentication mechanism between the DHCP server and the clients. If there are several DHCP servers on the network, security problems and network interference will happen. DHCP Filter resolves this problem.

With DHCP Filter configured, the switch can check whether the received DHCP packets are legal and discard the illegal ones. In this way, DHCP Filter ensures that users get IP addresses only from the legal DHCP server and enhances the network security.

As the following figure shows, there are both legal and illegal DHCP servers on the network. You can configure DHCP Server1 as a legal DHCP server by providing the IP address and port number of DHCP Server1. When receiving the DHCP respond packets, the switch will forward the packets from the legal DHCP server.

Figure 1-1 Network Topology

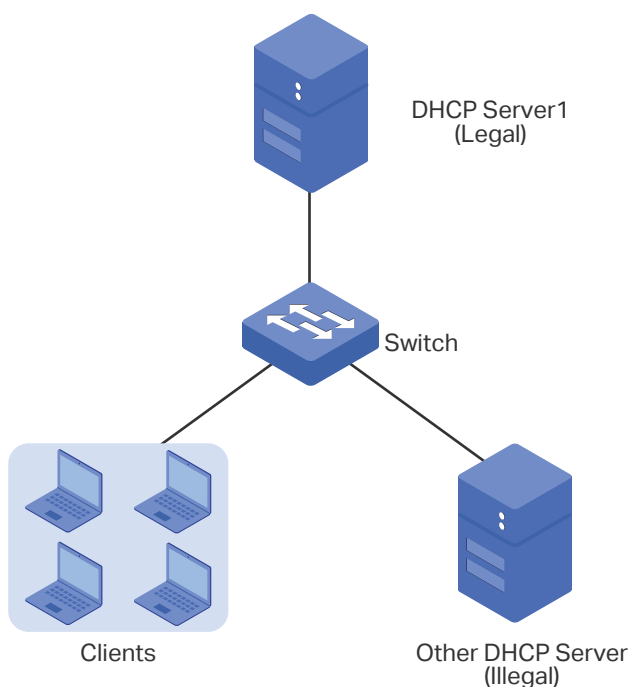

Additionally, you can limit the forwarding rate of DHCP packets on each port.

## 1.2 Supported Features

The switch supports DHCPv4 Filter and DHCPv6 Filter.

**DHCPv4 Filter**

DHCPv4 Filter is used for DHCPv4 servers and IPv4 clients.

**DHCPv6 Filter**

DHCPv6 Filter is used for DHCPv6 servers and IPv6 clients.

# 2 DHCPv4 Filter Configuration

To complete DHCPv4 Filter configuration, follow these steps:

- 1) Configure the basic DHCPv4 Filter parameters.
- 2) Configure legal DHCPv4 servers.

## 2.1 Using the GUI

### 2.1.1 Configuring the Basic DHCPv4 Filter Parameters

Choose the menu **SECURITY > DHCP Filter > DHCPv4 Filter > Basic Config** to load the following page.

Figure 2-1 DHCPv4 Filter Basic Config

The screenshot shows the DHCPv4 Filter Basic Config GUI. It is divided into two main sections: Global Config and Port Config.

**Global Config:** The 'DHCPv4 Filter' checkbox is checked, and the text 'Enable' is displayed. An 'Apply' button is located to the right.

**Port Config:** This section is divided into two tabs: 'UNIT1' (selected) and 'LAGS'. Below the tabs is a table with the following columns: Port, Status, MAC Verify, Rate Limit, Decline Protect, and LAG. The table lists ports 1/0/1 through 1/0/10. The first row (1/0/1) is selected, indicated by a checkmark in the first column. All other rows have an unchecked checkbox. The status for all ports is 'Disabled'. The MAC Verify, Rate Limit, and Decline Protect columns have dropdown arrows. The LAG column contains dashes ('--').

At the bottom of the table, there is a summary bar: 'Total: 28' on the left, '1 entry selected.' in the center, and 'Cancel' and 'Apply' buttons on the right.

| Port                                      | Status   | MAC Verify | Rate Limit | Decline Protect | LAG |
|---|----------|------------|------------|-----------------|-----|
| <input checked="" type="checkbox"/> 1/0/1 | Disabled | Disabled   | Disabled   | Disabled        | --  |
| <input type="checkbox"/> 1/0/2            | Disabled | Disabled   | Disabled   | Disabled        | --  |
| <input type="checkbox"/> 1/0/3            | Disabled | Disabled   | Disabled   | Disabled        | --  |
| <input type="checkbox"/> 1/0/4            | Disabled | Disabled   | Disabled   | Disabled        | --  |
| <input type="checkbox"/> 1/0/5            | Disabled | Disabled   | Disabled   | Disabled        | --  |
| <input type="checkbox"/> 1/0/6            | Disabled | Disabled   | Disabled   | Disabled        | --  |
| <input type="checkbox"/> 1/0/7            | Disabled | Disabled   | Disabled   | Disabled        | --  |
| <input type="checkbox"/> 1/0/8            | Disabled | Disabled   | Disabled   | Disabled        | --  |
| <input type="checkbox"/> 1/0/9            | Disabled | Disabled   | Disabled   | Disabled        | --  |
| <input type="checkbox"/> 1/0/10           | Disabled | Disabled   | Disabled   | Disabled        | --  |

Follow these steps to complete the basic settings of DHCPv4 Filter:

- 1) In the **Global Config** section, enable DHCPv4 globally.
- 2) In the **Port Config** section, select one or more ports and configure the related parameters.

|                 |   |
|-----------------|---|
| Port            | Displays the port number.   |
| Status          | Enable or disable DHCPv4 Filter feature on the port.  |
| MAC Verify      | <p>Enable or disable the MAC Verify feature. There are two fields in the DHCPv4 packet that contain the MAC address of the host. The MAC Verify feature compares the two fields of a DHCPv4 packet and discards the packet if the two fields are different.</p> <p>This prevents the IP address resource on the DHCPv4 server from being exhausted by forged MAC addresses.</p> |
| Rate Limit      | Select to enable the rate limit feature and specify the maximum number of DHCPv4 packets that can be forwarded on the port per second. The excessive DHCPv4 packets will be discarded.  |
| Decline Protect | Select to enable the decline protect feature and specify the maximum number of Decline packets that can be forwarded on the port per second. The excessive Decline packets will be discarded.   |
| LAG             | Displays the LAG that the port is in.   |

3) Click **Apply**.

 **Note:**

The member port of an LAG (Link Aggregation Group) follows the configuration of the LAG and not its own. The configurations of the port can take effect only after it leaves the LAG.

## 2.1.2 Configuring Legal DHCPv4 Servers

Choose the menu **SECURITY > DHCP Filter > DHCPv4 Filter > Legal DHCPv4 Servers** and click  **Add** to load the following page.

Figure 2-2 Adding Legal DHCPv4 Server

Add Legal DHCPv4 Server

Server IP Address:  (Format: 192.168.0.1)

Client MAC Address:  (Format: 00-00-00-00-00-01)

Server Port:  Cancel (Format: 1/0/1, input or choose below)

**UNIT1**                      **LAGS**

2

4

6

8

10

12

14

16

18

20

22

24

26

28

1

3

5

7

9

11

13

15

17

19

21

23

25

27

Selected

Unselected

Not Available

User Guide ■ 698

Follow these steps to add a legal DHCPv4 server:

1) Configure the following parameters:

|                    |   |
|--------------------|---|
| Server IP Address  | Specify the IP address of the legal DHCPv4 server.  |
| Client MAC Address | (Optional) Specify the MAC address of the DHCP Client. You can also keep this field empty, which represents for all DHCP clients. |
| Server Port        | Select the port that the legal DHCPv4 server is connected.  |

2) Click **Create**.

## 2.2 Using the CLI

### 2.2.1 Configuring the Basic DHCPv4 Filter Parameters

Follow these steps to complete the basic settings of DHCPv4 Filter:

|        |   |
|--------|---|
| Step 1 | <b>configure</b><br>Enter global configuration mode.  |
| Step 2 | <b>ip dhcp filter</b><br>Enable DHCPv4 Filter globally.   |
| Step 3 | <b>interface { fastEthernet port   range fastEthernet port-list   gigabitEthernet port   range gigabitEthernet port-list   ten-gigabitEthernet port   range ten-gigabitEthernet port-list   interface port-channel port-channel-id   interface range port-channel port-channel-id-list }</b><br>Enter interface configuration mode.   |
| Step 4 | <b>ip dhcp filter</b><br>Enable DHCPv4 Filter on the port.  |
| Step 5 | <b>ip dhcp filter mac-verify</b><br>Enable the MAC Verify feature. There are two fields in the DHCP packet that contain the MAC address of the host. The MAC Verify feature compares the two fields of a DHCP packet and discards the packet if the two fields are different. This prevents the IP address resource on the DHCP server from being exhausted by forged MAC addresses.                                |
| Step 6 | <b>ip dhcp filter limit rate value</b><br>Enable the limit rate feature and specify the maximum number of DHCP messages that can be forwarded on the port per second. The excessive DHCP packets will be discarded.<br><br><i>value</i> : Specify the limit rate value. The following options are provided: 0, 5,10,15,20,25 and 30 (packets/second). The default value is 0, which indicates disabling limit rate. |

- 
- Step 7      **ip dhcp filter decline rate value**
- Enable the decline protect feature and specify the maximum number of Decline packets can be forwarded per second on the port. The excessive Decline packets will be discarded.
- value*: Specify the limit rate value of Decline packets. The following options are provided: 0, 5, 10, 15, 20, 25 and 30 (packets/second). The default value is 0, which indicates disabling this feature.
- 
- Step 8      **show ip dhcp filter**
- Verify the global DHCPv4 Filter configuration.
- 
- Step 9      **show ip dhcp filter interface [ fastEthernet port | gigabitEthernet port | ten-gigabitEthernet port | port-channel port-channel-id ]**
- Verify the DHCPv4 Filter configuration of the port.
- 
- Step 10     **end**
- Return to privileged EXEC mode.
- 
- Step 11     **copy running-config startup-config**
- Save the settings in the configuration file.
- 

 **Note:**

The member port of an LAG (Link Aggregation Group) follows the configuration of the LAG and not its own. The configurations of the port can take effect only after it leaves the LAG.

---

The following example shows how to enable DHCPv4 Filter globally and how to enable DHCPv4 Filter, enable the MAC verify feature, set the limit rate as 10 pps and set the decline rate as 20 pps on port 1/0/1:

**Switch#configure**

**Switch(config)#ip dhcp filter**

**Switch(config)#interface gigabitEthernet 1/0/1**

**Switch(config-if)#ip dhcp filter**

**Switch(config-if)#ip dhcp filter mac-verify**

**Switch(config-if)#ip dhcp filter limit rate 10**

**Switch(config-if)#ip dhcp filter decline rate 20**

**Switch(config-if)##show ip dhcp filter**

Global Status: Enable

**Switch(config-if)#show ip dhcp filter interface gigabitEthernet 1/0/1**

| Interface | state  | MAC-Verify | Limit-Rate | Dec-rate | LAG |
|-----------|--------|------------|------------|----------|-----|
| -----     | -----  | -----      | -----      | -----    | --- |
| Gi1/0/1   | Enable | Enable     | 10         | 20       | N/A |

**Switch(config-if)#end**

**Switch#copy running-config startup-config**

## 2.2.2 Configuring Legal DHCPv4 Servers

Follow these steps configure legal DHCPv4 servers:

|        |   |
|--------|---|
| Step 1 | <b>configure</b><br>Enter global configuration mode.  |
| Step 2 | <b>ip dhcp filter server permit-entry server-ip <i>ipAddr</i> client-mac <i>macAddr</i> interface { <i>fastEthernet port-list</i>   <i>gigabitEthernet port-list</i>   <i>ten-gigabitEthernet port-list</i>   <i>port-channel port-channel-id</i> }</b><br>Create an entry for the legal DHCPv4 server.<br><br><i>ipAddr</i> : Specify the IP address of the legal DHCPv4 server.<br><br><i>macAddr</i> : Specify the MAC address of the DHCP Client. The value "all" means all client mac addresses.<br><br><i>port-list</i>   <i>port-channel-id</i> : Specify the port that the legal DHCPv4 server is connected to. |
| Step 3 | <b>show ip dhcp filter server permit-entry</b><br>Verify configured legal DHCPv4 server information.  |
| Step 4 | <b>end</b><br>Return to privileged EXEC mode.   |
| Step 5 | <b>copy running-config startup-config</b><br>Save the settings in the configuration file.   |

The following example shows how to create an entry for the legal DHCPv4 server whose IP address is 192.168.0.100 and connected port number is 1/0/1 without client MAC address restricted:

**Switch#configure**

**Switch(config)#ip dhcp filter server permit-entry server-ip 192.168.0.100 client-mac all interface gigabitEthernet 1/0/1**

**Switch(config)#show ip dhcp filter server permit-entry**

| Server IP     | Client MAC | Interface |
|---------------|------------|-----------|
| -----         | -----      | -----     |
| 192.168.0.100 | all        | Gi1/0/1   |



```
Switch(config)#end
```

```
Switch#copy running-config startup-config
```

# 3 DHCPv6 Filter Configuration

To complete DHCPv6 Filter configuration, follow these steps:

- 1) Configure the basic DHCPv6 Filter parameters.
- 2) Configure legal DHCPv6 servers.

## 3.1 Using the GUI

### 3.1.1 Configuring the Basic DHCPv6 Filter Parameters

Choose the menu **SECURITY > DHCP Filter > DHCPv6 Filter > Basic Config** to load the following page.

Figure 3-1 DHCPv6 Filter Basic Config

Global Config

DHCPv6 Filter:  Enable Apply

Port Config

| UNIT1                               | LAGS | Port   | Status   | Rate Limit | Decline Protect | LAG |
|-------------------------------------|------|--------|----------|------------|-----------------|-----|
| <input checked="" type="checkbox"/> |      | 1/0/1  | Disabled | Disabled   | Disabled        | --  |
| <input type="checkbox"/>            |      | 1/0/2  | Disabled | Disabled   | Disabled        | --  |
| <input type="checkbox"/>            |      | 1/0/3  | Disabled | Disabled   | Disabled        | --  |
| <input type="checkbox"/>            |      | 1/0/4  | Disabled | Disabled   | Disabled        | --  |
| <input type="checkbox"/>            |      | 1/0/5  | Disabled | Disabled   | Disabled        | --  |
| <input type="checkbox"/>            |      | 1/0/6  | Disabled | Disabled   | Disabled        | --  |
| <input type="checkbox"/>            |      | 1/0/7  | Disabled | Disabled   | Disabled        | --  |
| <input type="checkbox"/>            |      | 1/0/8  | Disabled | Disabled   | Disabled        | --  |
| <input type="checkbox"/>            |      | 1/0/9  | Disabled | Disabled   | Disabled        | --  |
| <input type="checkbox"/>            |      | 1/0/10 | Disabled | Disabled   | Disabled        | --  |

Total: 28 1 entry selected. Cancel Apply

Follow these steps to complete the basic settings of DHCPv6 Filter:

- 1) In the **Global Config** section, enable DHCPv6 globally.
- 2) In the **Port Config** section, select one or more ports and configure the related parameters.

**Port** Displays the port number.

|                        |   |
|------------------------|---|
| <b>Status</b>          | Enable or disable DHCPv6 Filter feature on the port.  |
| <b>Rate Limit</b>      | Select to enable the rate limit feature and specify the maximum number of DHCPv6 packets that can be forwarded on the port per second. The excessive DHCPv6 packets will be discarded.                      |
| <b>Decline Protect</b> | Select to enable the decline protect feature and specify the maximum number of DHCPv6 Decline packets that can be forwarded on the port per second. The excessive DHCPv6 Decline packets will be discarded. |
| <b>LAG</b>             | Displays the LAG that the port is in.   |

3) Click **Apply**.

 **Note:**

The member port of an LAG (Link Aggregation Group) follows the configuration of the LAG and not its own. The configurations of the port can take effect only after it leaves the LAG.

### 3.1.2 Configuring Legal DHCPv6 Servers

Choose the menu **SECURITY > DHCP Filter > DHCPv6 Filter > Legal DHCPv6 Servers** and click  **Add** to load the following page.

Figure 3-2 Adding Legal DHCPv6 Server

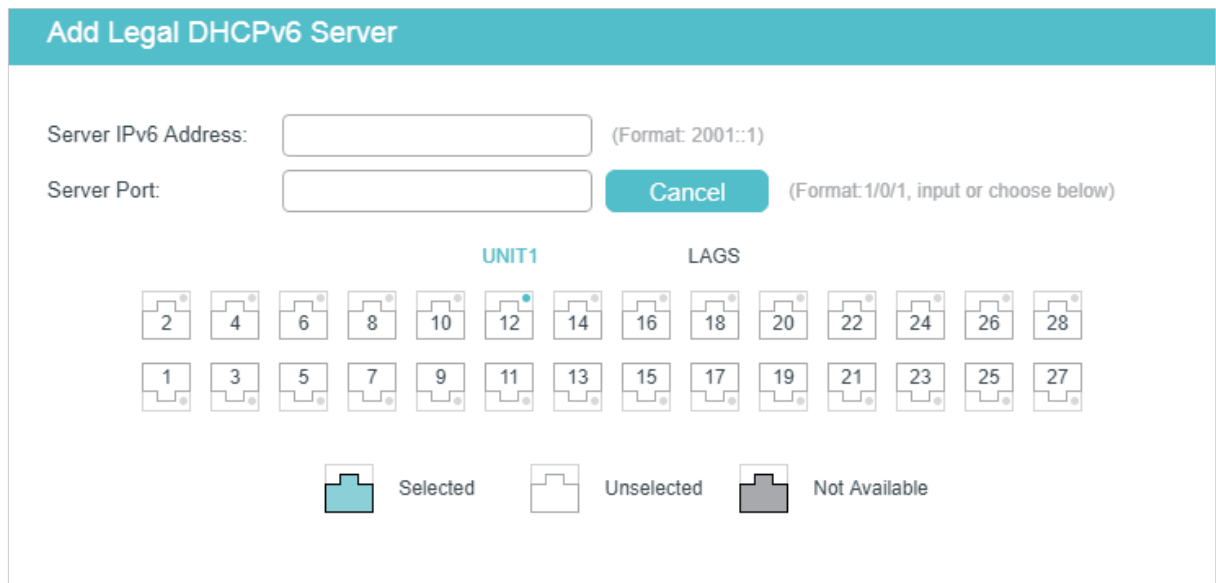

Follow these steps to add a legal DHCPv6 server:

1) Configure the following parameters:

|                            |  |
|----------------------------|--|
| <b>Server IPv6 Address</b> | Specify the IP address of the legal DHCPv6 server.         |
| <b>Server Port</b>         | Select the port that the legal DHCPv6 server is connected. |

2) Click **Create**.

## 3.2 Using the CLI

### 3.2.1 Configuring the Basic DHCPv6 Filter Parameters

Follow these steps to complete the basic settings of DHCPv6 Filter:

|         |   |
|---------|---|
| Step 1  | <b>configure</b><br>Enter global configuration mode.  |
| Step 2  | <b>ipv6 dhcp filter</b><br>Enable DHCPv6 Filter globally.   |
| Step 3  | <b>interface { fastEthernet port   range fastEthernet port-list   gigabitEthernet port   range gigabitEthernet port-list   ten-gigabitEthernet port   range ten-gigabitEthernet port-list   interface port-channel port-channel-id   interface range port-channel port-channel-id-list }</b><br>Enter interface configuration mode.   |
| Step 4  | <b>ipv6 dhcp filter</b><br>Enable DHCPv6 Filter on the port.  |
| Step 5  | <b>ipv6 dhcp filter limit rate value</b><br>Enable the limit rate feature and specify the maximum number of DHCP messages that can be forwarded on the port per second. The excessive DHCP packets will be discarded.<br><br><i>value</i> : Specify the limit rate value. The following options are provided: 0, 5,10,15,20,25 and 30 (packets/second). The default value is 0, which indicates disabling limit rate.                             |
| Step 6  | <b>ipv6 dhcp filter decline rate value</b><br>Enable the decline protect feature and specify the maximum number of Decline packets can be forwarded per second on the port. The excessive Decline packets will be discarded.<br><br><i>value</i> : Specify the limit rate value of Decline packets. The following options are provided: 0, 5,10,15,20,25 and 30 (packets/second). The default value is 0, which indicates disabling this feature. |
| Step 7  | <b>show ipv6 dhcp filter</b><br>Verify the global DHCPv6 Filter configuration.  |
| Step 8  | <b>show ipv6 dhcp filter interface [ fastEthernet port   gigabitEthernet port   ten-gigabitEthernet port   port-channel port-channel-id ]</b><br>Verify the DHCPv6 Filter configuration of the port.  |
| Step 9  | <b>end</b><br>Return to privileged EXEC mode.   |
| Step 10 | <b>copy running-config startup-config</b><br>Save the settings in the configuration file.   |

 **Note:**

The member port of an LAG (Link Aggregation Group) follows the configuration of the LAG and not its own. The configurations of the port can take effect only after it leaves the LAG.

The following example shows how to enable DHCPv6 Filter globally and how to enable DHCPv6 Filter, set the limit rate as 10 pps and set the decline rate as 20 pps on port 1/0/1:

```
Switch#configure
```

```
Switch(config)#ipv6 dhcp filter
```

```
Switch(config)#interface gigabitEthernet 1/0/1
```

```
Switch(config-if)#ipv6 dhcp filter
```

```
Switch(config-if)#ipv6 dhcp filter limit rate 10
```

```
Switch(config-if)#ipv6 dhcp filter decline rate 20
```

```
Switch(config-if)##show ipv6 dhcp filter
```

```
Global Status: Enable
```

```
Switch(config-if)#show ip dhcp filter interface gigabitEthernet 1/0/1
```

| Interface | state  | Limit-Rate | Dec-rate | LAG |
|-----------|--------|------------|----------|-----|
| -----     | -----  | -----      | -----    | --- |
| Gi1/0/1   | Enable | 10         | 20       | N/A |

```
Switch(config-if)#end
```

```
Switch#copy running-config startup-config
```

### 3.2.2 Configuring Legal DHCPv6 Servers

Follow these steps configure legal DHCPv6 servers:

|        |  |
|--------|--|
| Step 1 | <p><b>configure</b></p> <p>Enter global configuration mode.</p>  |
| Step 2 | <p><b>ipv6 dhcp filter server permit-entry server-ip <i>ipAddr</i> interface { fastEthernet <i>port-list</i>   gigabitEthernet <i>port-list</i>   ten-gigabitEthernet <i>port-list</i>   port-channel <i>port-channel-id</i> }</b></p> <p>Create an entry for the legal DHCPv6 server.</p> <p><i>ipAddr</i>: Specify the IPv6 address of the legal DHCPv6 server.</p> <p><i>port-list</i>   <i>port-channel-id</i>: Specify the port that the legal DHCPv6 server is connected to.</p> |
| Step 3 | <p><b>show ip dhcp filter server permit-entry</b></p> <p>Verify configured legal DHCPv6 server information.</p>  |

- 
- Step 4      **end**  
Return to privileged EXEC mode.
- 
- Step 5      **copy running-config startup-config**  
Save the settings in the configuration file.
- 

The following example shows how to create an entry for the legal DHCPv6 server whose IPv6 address is 2001::54 and connected port number is 1/0/1:

**Switch#configure**

**Switch(config)#ipv6 dhcp filter server permit-entry server-ip 2001::54 interface gigabitEthernet 1/0/1**

**Switch(config)#show ipv6 dhcp filter server permit-entry**

| Server IP | Interface |
|-----------|-----------|
| -----     | -----     |
| 2001::54  | Gi1/0/1   |

**Switch(config)#end**

**Switch#copy running-config startup-config**

# 4 Configuration Examples

## 4.1 Example for DHCPv4 Filter

### 4.1.1 Network Requirements

As shown below, all the DHCPv4 clients get IP addresses from the legal DHCPv4 server, and any other DHCPv4 server in the LAN is regarded as illegal. Now it is required that only the legal DHCPv4 server is allowed to assign IP addresses to the clients.

Figure 4-1 Network Topology

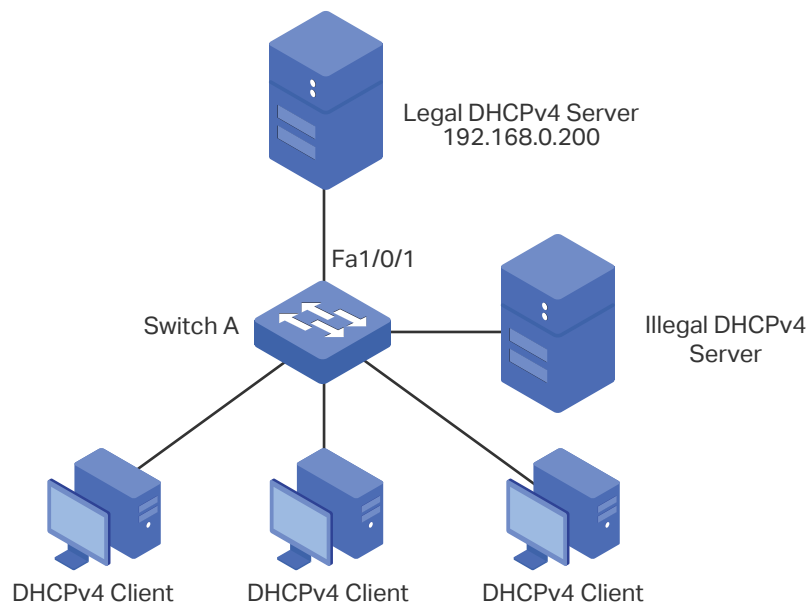

### 4.1.2 Configuration Scheme

To meet the requirements, you can configure DHCPv4 Filter to filter the DHCPv4 packets from the illegal DHCPv4 server.

The overview of configuration is as follows:

- 1) Enable DHCPv4 Filter globally and on all ports.
- 2) Create an entry for the legal DHCPv4 server.

Demonstrated with T1500-28PCT, the following sections provide configuration procedure in two ways: using the GUI and using the CLI.

### 4.1.3 Using the GUI

- 1) Choose the menu **SECURITY > DHCP Filter > DHCPv4 Filter > Basic Config** to load the following page. Enable DHCPv4 Filter globally and click **Apply**. Select all ports, change Status as Enable, and click **Apply**.

Figure 4-2 Basic Config

Global Config

DHCPv4 Filter:  Enable

Port Config

| UNIT1                               |        | LAGS    |            |            |                 |     |  |
|-------------------------------------|--------|---------|------------|------------|-----------------|-----|--|
| <input checked="" type="checkbox"/> | Port   | Status  | MAC Verify | Rate Limit | Decline Protect | LAG |  |
|                                     |        | Enable  |            |            |                 |     |  |
| <input checked="" type="checkbox"/> | 1/0/1  | Enabled | Disabled   | Disabled   | Disabled        | --- |  |
| <input checked="" type="checkbox"/> | 1/0/2  | Enabled | Disabled   | Disabled   | Disabled        | --- |  |
| <input checked="" type="checkbox"/> | 1/0/3  | Enabled | Disabled   | Disabled   | Disabled        | --- |  |
| <input checked="" type="checkbox"/> | 1/0/4  | Enabled | Disabled   | Disabled   | Disabled        | --- |  |
| <input checked="" type="checkbox"/> | 1/0/5  | Enabled | Disabled   | Disabled   | Disabled        | --- |  |
| <input checked="" type="checkbox"/> | 1/0/6  | Enabled | Disabled   | Disabled   | Disabled        | --- |  |
| <input checked="" type="checkbox"/> | 1/0/7  | Enabled | Disabled   | Disabled   | Disabled        | --- |  |
| <input checked="" type="checkbox"/> | 1/0/8  | Enabled | Disabled   | Disabled   | Disabled        | --- |  |
| <input checked="" type="checkbox"/> | 1/0/9  | Enabled | Disabled   | Disabled   | Disabled        | --- |  |
| <input checked="" type="checkbox"/> | 1/0/10 | Enabled | Disabled   | Disabled   | Disabled        | --- |  |

Total: 28 28 entries selected.

- 2) Choose the menu **SECURITY > DHCP Filter > DHCPv4 Filter > Legal DHCPv4 Servers** and click **+ Add** to load the following page. Specify the IP address and connected port number of the legal DHCPv4 server. Click **Create**.



Figure 4-3 Create Entry for Legal DHCPv4 Server

- 3) Click  Save to save the settings.

#### 4.1.4 Using the CLI

- 1) Enable DHCPv4 Filter globally and on all pots:

```
Switch_A#configure
```

```
Switch_A(config)#ip dhcp filter
```

```
Switch_A(config)#interface range fastEthernet 1/0/1-24
```

```
Switch_A(config-if-range)#ip dhcp filter
```

```
Switch_A(config)#interface range gigabitEthernet 1/0/25-28
```

```
Switch_A(config-if-range)#ip dhcp filter
```

```
Switch_A(config-if-range)#exit
```

- 2) Create an entry for the legal DHCPv4 server:

```
Switch_A(config)#ip dhcp filter server permit-entry server-ip 192.168.0.200 client-mac  
all interface fastEthernet 1/0/1
```

```
Switch_A(config)#end
```

```
Switch_A#copy running-config startup-config
```

#### Verify the Configuration

Verify the global DHCPv4 Filter configuration:

```
Switch_A#show ip dhcp filter
```

Global Status: Enable

Verify the DHCPv4 Filter configuration on ports:

Switch\_A#show ip dhcp filter interface

| Interface | state  | MAC-Verify | Limit-Rate | Dec-rate | LAG |
|-----------|--------|------------|------------|----------|-----|
| -----     | -----  | -----      | -----      | -----    | --- |
| Fa1/0/1   | Enable | Disable    | Disable    | Disable  | N/A |
| Fa1/0/2   | Enable | Disable    | Disable    | Disable  | N/A |
| Fa1/0/3   | Enable | Disable    | Disable    | Disable  | N/A |
| Fa1/0/4   | Enable | Disable    | Disable    | Disable  | N/A |
| ...       |        |            |            |          |     |

Verify the legal DHCPv4 server configuration:

Switch\_A#show ip dhcp filter server permit-entry

| Server IP     | Client MAC | Interface |
|---------------|------------|-----------|
| -----         | -----      | -----     |
| 192.168.0.200 | all        | Fa1/0/1   |

## 4.2 Example for DHCPv6 Filter

### 4.2.1 Network Requirements

As shown below, all the DHCPv6 clients get IP addresses from the legal DHCPv6 server, and any other DHCPv6 server in the LAN is regarded as illegal. Now it is required that only the legal DHCPv6 server is allowed to assign IP addresses to the clients.

Figure 4-1 Network Topology

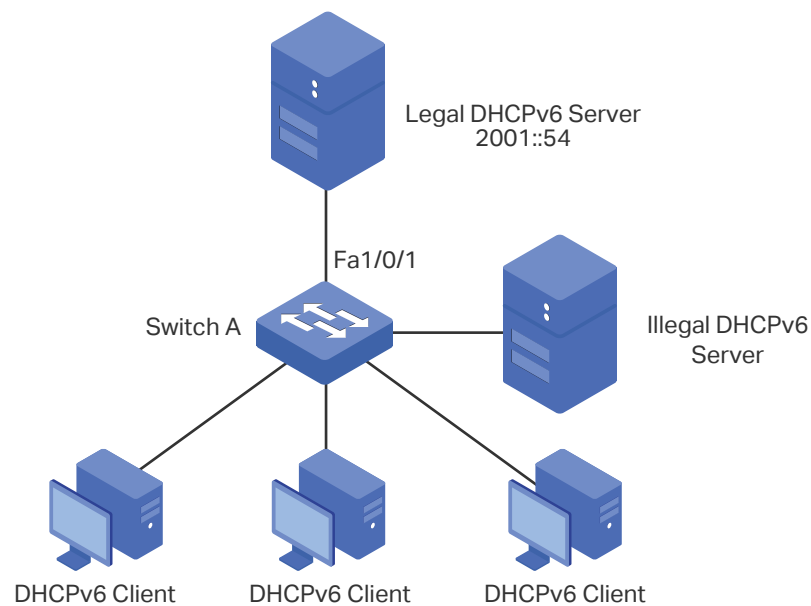

## 4.2.2 Configuration Scheme

To meet the requirements, you can configure DHCPv6 Filter to filter the DHCPv6 packets from the illegal DHCPv6 server.

The overview of configuration is as follows:

- 1) Enable DHCPv6 Filter globally and on all ports.
- 2) Create an entry for the legal DHCPv6 server.

Demonstrated with T1500-28PCT, the following sections provide configuration procedure in two ways: using the GUI and using the CLI.

## 4.2.3 Using the GUI

- 1) Choose the menu **SECURITY > DHCP Filter > DHCPv6 Filter > Basic Config** to load the following page. Enable DHCPv6 Filter globally and click **Apply**. Select all ports, change Status as Enable, and click **Apply**.

Figure 4-2 Basic Config

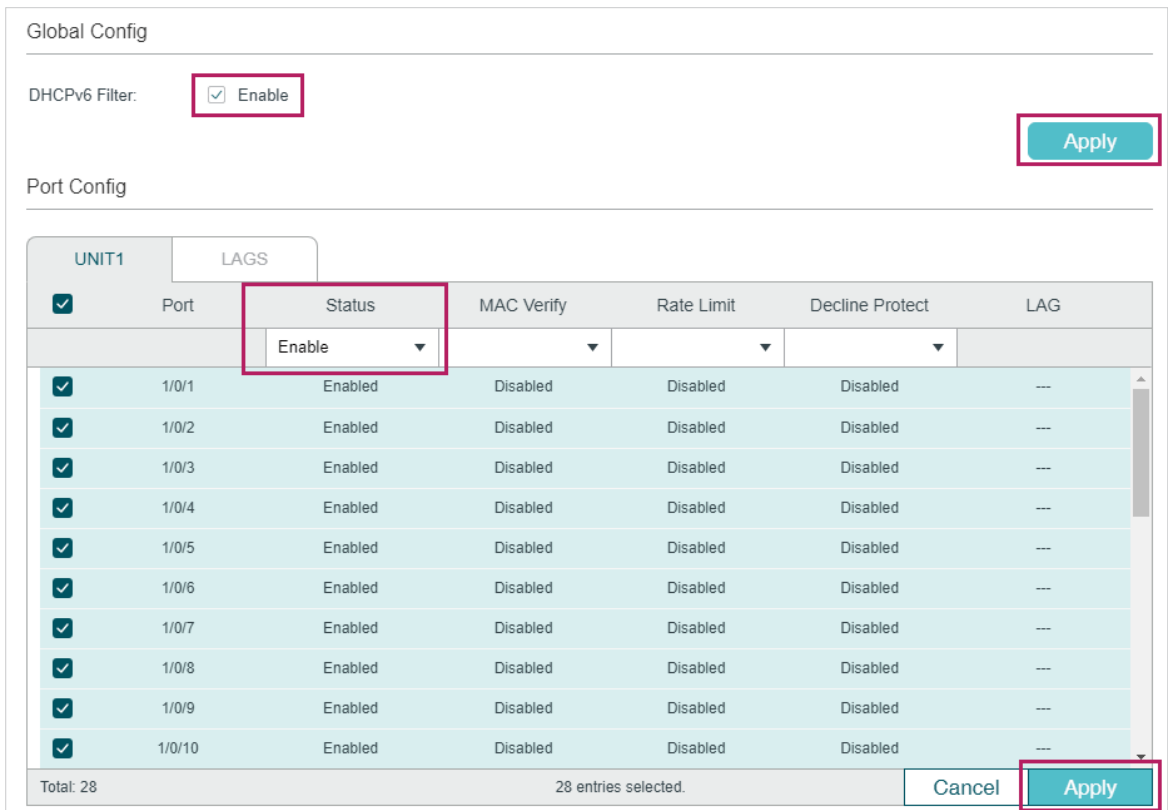

- 2) Choose the menu **SECURITY > DHCP Filter > DHCPv6 Filter > Legal DHCPv6 Servers** and click **+** Add to load the following page. Specify the IP address and connected port number of the legal DHCPv6 server. Click **Create**.

Figure 4-3 Create Entry for Legal DHCPv6 Server

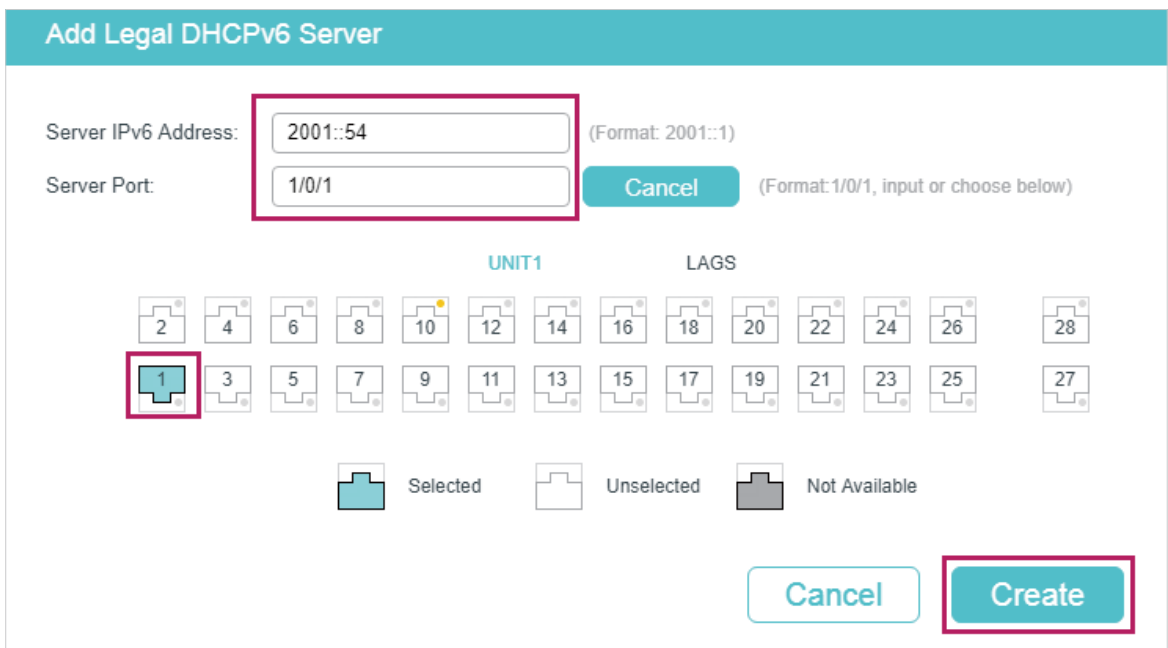

- 3) Click **Save** to save the settings.

## 4.2.4 Using the CLI

- 1) Enable DHCPv6 Filter globally and on all ports:

```
Switch_A#configure
Switch_A(config)#ipv6 dhcp filter
Switch_A(config)#interface range fastEthernet 1/0/1-24
Switch_A(config-if-range)#ip dhcpv6 filter
Switch_A(config)#interface range gigabitEthernet 1/0/25-28
Switch_A(config-if-range)#ip dhcpv6 filter
Switch_A(config-if-range)#exit
```

- 2) Create an entry for the legal DHCPv6 server:

```
Switch_A(config)#ipv6 dhcp filter server permit-entry server-ip 2001::54 interface
fastEthernet 1/0/1
Switch_A(config)#end
Switch_A#copy running-config startup-config
```

### Verify the Configuration

Verify the global DHCPv6 Filter configuration:

```
Switch_A#show ipv6 dhcp filter
Global Status: Enable
```

Verify the DHCPv6 Filter configuration on ports:

```
Switch_A#show ipv6 dhcp filter interface
```

| Interface | state  | Limit-Rate | Dec-rate | LAG |
|-----------|--------|------------|----------|-----|
| -----     | -----  | -----      | -----    | --- |
| Fa1/0/1   | Enable | Disable    | Disable  | N/A |
| Fa1/0/2   | Enable | Disable    | Disable  | N/A |
| Fa1/0/3   | Enable | Disable    | Disable  | N/A |
| Fa1/0/4   | Enable | Disable    | Disable  | N/A |
| ...       |        |            |          |     |

Verify the legal DHCPv6 server configuration:

```
Switch_A#show ipv6 dhcp filter server permit-entry
```

| Server IP | Interface |
|-----------|-----------|
| -----     | -----     |
| 2001::54  | Fa1/0/1   |

# 5 Appendix: Default Parameters

Default settings of DHCPv4 Filter are listed in the following table:

Table 5-1 DHCPv4 Filter

| Parameter       | Default Setting |
|-----------------|-----------------|
| Global Config   |                 |
| DHCPv4 Filter   | Disabled        |
| Port Config     |                 |
| Status          | Disabled        |
| MAC Verify      | Disabled        |
| Rate Limit      | Disabled        |
| Decline Protect | Disabled        |

Table 5-2 DHCPv6 Filter

| Parameter       | Default Setting |
|-----------------|-----------------|
| Global Config   |                 |
| DHCPv6 Filter   | Disabled        |
| Port Config     |                 |
| Status          | Disabled        |
| Rate Limit      | Disabled        |
| Decline Protect | Disabled        |

# Part 23

## Configuring DoS Defend

### CHAPTERS

1. Overview
2. DoS Defend Configuration
3. Appendix: Default Parameters



# 1 Overview

The DoS (Denial of Service) defend feature provides protection against DoS attacks. DoS attacks occupy the network bandwidth maliciously by sending numerous service requests to the hosts. It results in an abnormal service or breakdown of the network.

With DoS Defend feature, the switch can analyze the specific fields of the IP packets, distinguish the malicious DoS attack packets and discard them directly. Also, DoS Defend feature can limit the transmission rate of legal packets. When the number of legal packets exceeds the threshold value and may incur a breakdown of the network, the switch will discard the packets.

# 2 DoS Defend Configuration

## 2.1 Using the GUI

Choose the menu **SECURITY > DoS Defend** to load the following page.

Figure 2-1 DoS Defend

Follow these steps to configure DoS Defend:

- 1) In the **DoS Defend** section, enable DoS Protection and click **Apply**.
- 2) In the **DoS Defend Config** section, select one or more defend types according to your needs and click **Apply**. The following table introduces each type of DoS attack.

|                    |   |
|--------------------|---|
| <b>Land Attack</b> | The attacker sends a specific fake SYN (synchronous) packet to the destination host. Because both of the source IP address and the destination IP address of the SYN packet are set to be the IP address of the host, the host will be trapped in an endless circle of building the initial connection. |
| <b>Scan SYNFIN</b> | The attacker sends the packet with its SYN field and the FIN field set to 1. The SYN field is used to request initial connection whereas the FIN field is used to request disconnection. Therefore, the packet of this type is illegal.   |
| <b>Xmascan</b>     | The attacker sends the illegal packet with its TCP index, FIN, URG and PSH field set to 1.  |

|                             |  |
|-----------------------------|--|
| <b>NULL Scan</b>            | The attacker sends the illegal packet with its TCP index and all the control fields set to 0. During the TCP connection and data transmission, the packets with all control fields set to 0 are considered illegal.  |
| <b>SYN sPort less 1024</b>  | The attacker sends the illegal packet with its TCP SYN field set to 1 and source port smaller than 1024.   |
| <b>Blat Attack</b>          | The attacker sends the illegal packet with the same source port and destination port on Layer 4 and with its URG field set to 1. Similar to the Land Attack, the system performance of the attacked host is reduced because the Host circularly attempts to build a connection with the attacker.  |
| <b>Ping Flooding</b>        | The attacker floods the destination system with Ping packets, creating a broadcast storm that makes it impossible for the system to respond to legal communication.  |
| <b>SYN/SYN-ACK Flooding</b> | The attacker uses a fake IP address to send TCP request packets to the server. Upon receiving the request packets, the server responds with SYN-ACK packets. Since the IP address is fake, no response will be returned. The server will keep on sending SYN-ACK packets. If the attacker sends overflowing fake request packets, the network resource will be occupied maliciously and the requests of the legal clients will be denied.  |
| <b>WinNuke Attack</b>       | Because the Operation System with bugs cannot correctly process the URG (Urgent Pointer) of TCP packets, the attacker sends this type of packets to the TCP port 139 (NetBIOS) of the host with the Operation System bugs, which will cause the host with a blue screen.   |
| <b>Ping of Death</b>        | Ping of Death attack means that the attacker sends abnormal ping packets larger than 65535 bytes to cause system crash on the target computer.   |
| <b>Smurf Attack</b>         | Smurf attack is a distributed denial-of-service attack in which large numbers of Internet Control Message Protocol (ICMP) packets with the intended victim's spoofed source IP are broadcast to a computer network using an IP broadcast address. Most devices on a network will, by default, respond to this by sending a reply to the source IP address. If the number of machines on the network that receive and respond to these packets is very large, the victim's computer will be flooded with traffic. |

3) Click **Apply**.

## 2.2 Using the CLI

Follow these steps to configure DoS Defend:

|        |  |
|--------|--|
| Step 1 | <b>configure</b><br>Enter global configuration mode.             |
| Step 2 | <b>ip dos-prevent</b><br>Globally enable the DoS defend feature. |

## Step 3

**ip dos-prevent type { land | scan-synfin | xma-scan | null-scan | port-less-1024 | blat | ping-flood | syn-flood | win-nuke | ping-of-death | smurf }**

Configure one or more defend types according to your needs. The types of DoS attack are introduced as follows.

**land:** The attacker sends a specific fake SYN (synchronous) packet to the destination host. Because both the source IP address and the destination IP address of the SYN packet are set to be the IP address of the host, the host will be trapped in an endless circle of building the initial connection.

**scan-synfin:** The attacker sends the packet with its SYN field and the FIN field set to 1. The SYN field is used to request initial connection whereas the FIN field is used to request disconnection. Therefore, a packet of this type is illegal.

**xma-scan:** The attacker sends the illegal packet with its TCP index, FIN, URG and PSH field set to 1.

**null-scan:** The attacker sends the illegal packet with its TCP index and all the control fields set to 0. During the TCP connection and data transmission, the packets with all the control fields set to 0 are considered as the illegal packets.

**port-less-1024:** The attacker sends the illegal packet with its TCP SYN field set to 1 and source port smaller than 1024.

**blat:** The attacker sends the illegal packet with the same source port and destination port on Layer 4 and with its URG field set to 1. Similar to the Land Attack, the system performance of the attacked host is reduced because the Host circularly attempts to build a connection with the attacker.

**ping-flood:** The attacker floods the destination system with Ping packets, creating a broadcast storm that makes it impossible for system to respond to legal communication.

**syn-flood:** The attacker uses a fake IP address to send TCP request packets to the server. Upon receiving the request packets, the server responds with SYN-ACK packets. Since the IP address is fake, no response will be returned. The server will keep on sending SYN-ACK packets. If the attacker sends overflowing fake request packets, the network resource will be occupied maliciously and the requests of the legal clients will be denied.

**win-nuke:** An Operation System with bugs cannot process the URG (Urgent Pointer) of TCP packets. If the attacker sends TCP packets to port 139 (NetBIOS) of the host with Operation System bugs, it will cause blue screen.

**ping-of-death:** Ping of Death attack means that the attacker sends abnormal ping packets larger than 65535 bytes to cause system crash on the target computer.

**smurf:** Smurf attack is a distributed denial-of-service attack in which large numbers of Internet Control Message Protocol (ICMP) packets with the intended victim's spoofed source IP are broadcast to a computer network using an IP broadcast address. Most devices on a network will, by default, respond to this by sending a reply to the source IP address. If the number of machines on the network that receive and respond to these packets is very large, the victim's computer will be flooded with traffic.

## Step 4

**show ip dos-prevent**

Verify the DoS Defend configuration.

- 
- Step 5      **end**  
Return to privileged EXEC mode.
- 
- Step 6      **copy running-config startup-config**  
Save the settings in the configuration file.
- 

The following example shows how to enable the DoS Defend type named land:

**Switch#configure**

**Switch(config)#ip dos-prevent**

**Switch(config)#ip dos-prevent type land**

**Switch(config)#show ip dos-prevent**

```
DoS Prevention State:   Enabled
Type                   Status
----                 -
Land Attack            Enabled
Scan SYNFIN            Disabled
Xmascan                Disabled
NULL Scan              Disabled
SYN sPort less 1024    Disabled
Blat Attack            Disabled
Ping Flooding          Disabled
SYN/SYN-ACK Flooding   Disabled
WinNuke Attack         Disabled
Smurf Attack           Disabled
Ping Of Death          Disabled
```

**Switch(config)#end**

**Switch#copy running-config startup-config**

# 3 Appendix: Default Parameters

Default settings of Network Security are listed in the following tables.

Table 3-1 DoS Defend

| Parameter  | Default Setting |
|------------|-----------------|
| DoS Defend | Disabled        |

# Part 24

## Monitoring the System

### CHAPTERS

1. Overview
2. Monitoring the CPU
3. Monitoring the Memory

# 1 Overview

With System Monitor function, you can:

- Monitor the CPU utilization of the switch.
- Monitor the memory utilization of the switch.

The CPU utilization should be always under 80%, and excessive use may result in switch malfunctions. For example, the switch fails to respond to management requests (ICMP ping, SNMP timeouts, slow Telnet or SSH sessions). You can monitor the system to verify a CPU utilization problem.



# 2 Monitoring the CPU

## 2.1 Using the GUI

Choose the menu **MAINTENANCE > System Monitor > CPU Monitor** to load the following page.

Figure 2-1 Monitoring the CPU

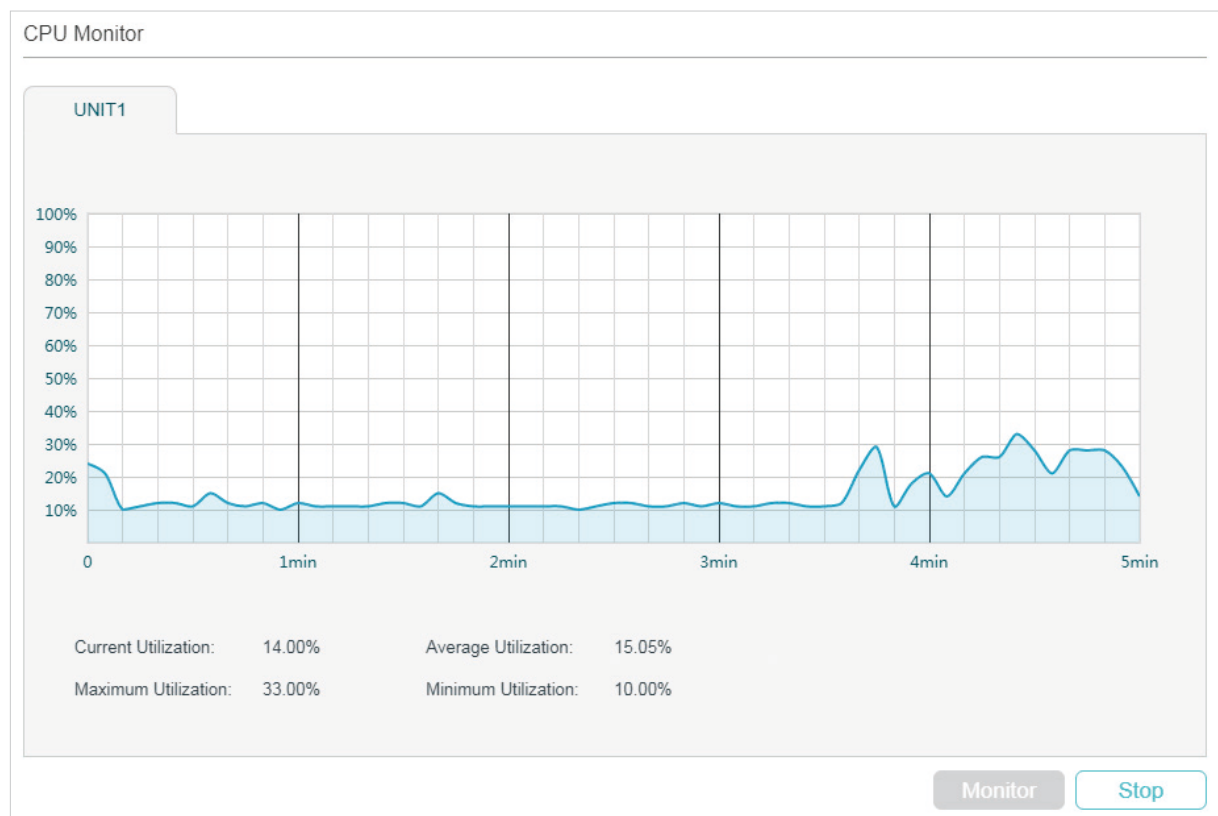

Click **Monitor** to enable the switch to monitor and display its CPU utilization rate every five seconds.

## 2.2 Using the CLI

On privileged EXEC mode or any other configuration mode, you can use the following command to view the CPU utilization:

### **show cpu-utilization**

View the memory utilization of the switch in the last 5 seconds, 1minute and 5minutes.

The following example shows how to monitor the CPU:

**Switch#show cpu-utilization**

| Unit        | CPU Utilization |            |              |
|-------------|-----------------|------------|--------------|
| No.         | Five-Seconds    | One-Minute | Five-Minutes |
| -----+----- |                 |            |              |
| 1           | 13%             | 13%        | 13%          |

# 3 Monitoring the Memory

## 3.1 Using the GUI

Choose the menu **MAINTENANCE > System Monitor > Memory Monitor** to load the following page.

Figure 3-1 Monitoring the Memory

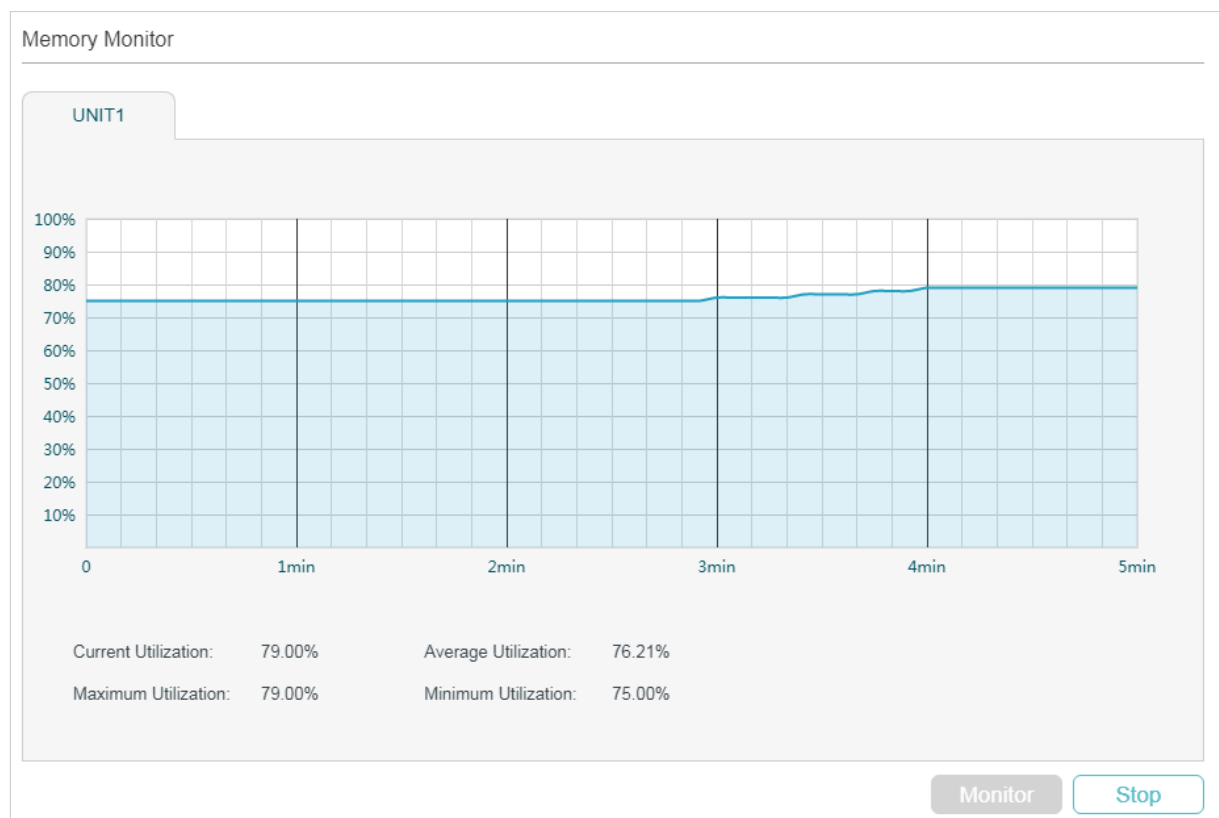

Click **Monitor** to enable the switch to monitor and display its memory utilization rate every five seconds.

## 3.2 Using the CLI

On privileged EXEC mode or any other configuration mode, you can use the following command to view the memory utilization:

```
show memory-utilization
```

View the current memory utilization of the switch.

The following example shows how to monitor the memory:

```
Switch#show memory-utilization
```

Unit | Current Memory Utilization

-----+-----

1 | 74%

# Part 25

## Monitoring Traffic

### CHAPTERS

1. Traffic Monitor
2. Appendix: Default Parameters

# 1 Traffic Monitor

With Traffic Monitor function, you can monitor each port's traffic information, including the traffic summary and traffic statistics in detail.

## 1.1 Using the GUI

Choose the menu **MAINTENANCE > Traffic Monitor** to load the following page.

Figure 1-1 Traffic Summary

| Statistics                   |         |                    |         |
|------------------------------|---------|--------------------|---------|
| Port1/0/12                   |         |                    |         |
| Received                     |         | Sent               |         |
| Broadcast:                   | 106     | Broadcast:         | 15      |
| Multicast:                   | 81      | Multicast:         | 7       |
| Unicast:                     | 14279   | Unicast:           | 15994   |
| Jumbo:                       | 0       | Jumbo:             | 0       |
| Alignment Errors:            | 0       | Pkts:              | 16016   |
| Undersize Packets:           | 0       | Bytes:             | 6838693 |
| 64-Octets Packets:           | 9606    | Collisions Errors: | 0       |
| 65-to-127-Octets Packets:    | 2400    |                    |         |
| 128-to-255-Octets Packets:   | 81      |                    |         |
| 256-to-511-Octets Packets:   | 234     |                    |         |
| 512-to-1023-Octets Packets:  | 2145    |                    |         |
| 1023-to-1518-Octets Packets: | 0       |                    |         |
| Pkts:                        | 14466   |                    |         |
| Bytes:                       | 2241191 |                    |         |

Follow these steps to view the traffic summary of each port:

- 1) To get the real-time traffic summary, enable **Auto Refresh**, or click **Refresh**.

**Auto Refresh:** With this option enabled, the switch will automatically refresh the traffic summary.

**Refresh Interval:** Specify the time interval for the switch to refresh the traffic summary.

- 2) In the **Traffic Summary** section, click **UNIT1** to show the information of the physical ports, and click **LAGS** to show the information of the LAGs.

**Packets Rx:** Displays the number of packets received on the port. Error packets are not counted.

|                    |  |
|--------------------|--|
| <b>Packets Tx:</b> | Displays the number of packets transmitted on the port. Error packets are not counted. |
| <b>Octets Rx:</b>  | Displays the number of octets received on the port. Error octets are counted.          |
| <b>Octets Tx:</b>  | Displays the number of octets transmitted on the port. Error octets are counted.       |

To view a port's traffic statistics in detail, click **Statistics** on the right side of the entry.

Figure 1-2 Traffic Statistics

| Statistics <span style="float: right;">✕</span> |         |                    |         |
|---|---------|--------------------|---------|
| Port1/0/12                                      |         |                    |         |
| Received  |         | Sent               |         |
| Broadcast:                                      | 106     | Broadcast:         | 15      |
| Multicast:                                      | 81      | Multicast:         | 7       |
| Unicast:  | 14279   | Unicast:           | 15994   |
| Jumbo:  | 0       | Jumbo:             | 0       |
| Alignment Errors:                               | 0       | Pkts:              | 16016   |
| Undersize Packets:                              | 0       | Bytes:             | 6838693 |
| 64-Octets Packets:                              | 9606    | Collisions Errors: | 0       |
| 65-to-127-Octets Packets:                       | 2400    |                    |         |
| 128-to-255-Octets Packets:                      | 81      |                    |         |
| 256-to-511-Octets Packets:                      | 234     |                    |         |
| 512-to-1023-Octets Packets:                     | 2145    |                    |         |
| 1023-to-1518-Octets Packets:                    | 0       |                    |         |
| Pkts:   | 14466   |                    |         |
| Bytes:  | 2241191 |                    |         |

---

**Received:**

Displays the detailed information of received packets.

**Broadcast:** Displays the number of valid broadcast packets received on the port. Error frames are not counted.

**Multicast:** Displays the number of valid multicast packets received on the port. Error frames are not counted.

**Unicast:** Displays the number of valid unicast packets received on the port. Error frames are not counted.

**Jumbo:** Displays the number of valid jumbo packets received on the port. Error frames are not counted.

**Alignment Errors:** Displays the number of the received packets that have a Frame Check Sequence (FCS) with a non-integral octet (Alignment Error). The size of the packet is between 64 bytes and 1518 bytes.

**Undersize Packets:** Displays the number of the received packets (excluding error packets) that are less than 64 bytes long.

**64-Octets Packets:** Displays the number of the received packets (including error packets) that are 64 bytes long.

**65-to-127-Octets Packets:** Displays the number of the received packets (including error packets) that are between 65 and 127 bytes long.

**128-to-255-Octets Packets:** Displays the number of the received packets (including error packets) that are between 128 and 255 bytes long.

**256-to-511-Octets Packets:** Displays the number of the received packets (including error packets) that are between 256 and 511 bytes long.

**512-to-1023-Octets Packets:** Displays the number of the received packets (including error packets) that are between 512 and 1023 bytes long.

**1023-to-1518-Octets Packets:** Displays the number of the received packets (including error packets) that are between 512 and 1023 bytes long.

**Pkts:** Displays the number of packets received on the port. Error packets are not counted.

**Bytes:** Displays the number of bytes received on the port. Error packets are not counted.

---



**Sent:**

Displays the detailed information of sent packets.

Broadcast: Displays the number of valid broadcast packets transmitted on the port. Error frames are not counted.

Multicast: Displays the number of valid multicast packets transmitted on the port. Error frames are not counted.

Unicast: Displays the number of valid unicast packets transmitted on the port. Error frames are not counted.

Pkts: Displays the number of packets transmitted on the port. Error packets are not counted.

Bytes: Displays the number of bytes transmitted on the port. Error packets are not counted.

Collisions: Displays the number of collisions experienced by a half-duplex port during packet transmissions.

---

## 1.2 Using the CLI

On privileged EXEC mode or any other configuration mode, you can use the following command to view the traffic information of each port or LAG:

---

```
show interface counters [ fastEthernet port | gigabitEthernet port | ten-gigabitEthernet port | port-channel port-channel-id ]
```

*port-channel-id* : The group number of the LAG.

If you enter no port number or group number, the information of all ports and LAGs will be displayed.

The displaying information includes:

**Tx Collisions:** Displays the number of collisions experienced by a port during packet transmissions.

**Tx Ucast / Tx Mcast / Tx Bcast / Tx Jumbo:** Displays the number of valid unicast / multicast / broadcast / jumbo packets transmitted on the port. Error frames are not counted.

**Tx Pkts:** Displays the number of packets transmitted on the port. Error packets are not counted.

**Tx Bytes:** Displays the number of bytes transmitted on the port. Error packets are not counted.

**Rx Ucast / Rx Mcast / Rx Bcast / Rx Jumbo:** Displays the number of valid unicast / multicast / broadcast / jumbo packets received on the port. Error frames are not counted.

**Rx Alignment:** Displays the number of the received packets that have a Frame Check Sequence (FCS) with a non-integral octet (Alignment Error). The size of the packet is between 64 bytes and 1518 bytes.

**Rx UnderSize:** Displays the number of the received packets (excluding error packets) that are less than 64 bytes long.

**Rx 64Pkts:** Displays the number of the received packets (including error packets) that are 64 bytes long.

**Rx 65-127Pkts:** Displays the number of the received packets (including error packets) that are between 65 and 127 bytes long.

**Rx 128-255Pkts:** Displays the number of the received packets (including error packets) that are between 128 and 255 bytes long.

**Rx 256-511Pkts:** Displays the number of the received packets (including error packets) that are between 256 and 511 bytes long.

**Rx 512-1023Pkts:** Displays the number of the received packets (including error packets) that are between 512 and 1023 bytes long.

**Rx 1024-1518Pkts:** Displays the number of the received packets (including error packets) that are between 1024 and 1518 bytes long.

**Rx Pkts:** Displays the number of packets received on the port. Error packets are not counted.

**Rx Bytes:** Displays the number of bytes received on the port. Error packets are not counted.

---

# 2 Appendix: Default Parameters

Table 2-1 Traffic Statistics Monitoring

| Parameter       | Default Setting |
|-----------------|-----------------|
| Traffic Summary |                 |
| Auto Refresh    | Disabled        |
| Refresh Rate    | 10 seconds      |

# Part 26

## Mirroring Traffic

### CHAPTERS

1. Mirroring
2. Configuration Examples
3. Appendix: Default Parameters

# 1 Mirroring

You can analyze network traffic and troubleshoot network problems using Mirroring. Mirroring allows the switch to send a copy of the traffic that passes through specified sources (ports, LAGs or the CPU) to a destination port. It does not affect the switching of network traffic on source ports, LAGs or the CPU.

## 1.1 Using the GUI

Choose the menu **MAINTENANCE > Mirroring** to load the following page.

Figure 1-1 Port Mirroring Session List

| Port Mirroring Session List |                  |                                     |                   |  |
|-----------------------------|------------------|-------------------------------------|-------------------|--|
| Session                     | Destination Port | Mode                                | Source Interfaces | Operation                                  |
| 1                           |                  | Ingress Only<br>Egress Only<br>Both |                   | <a href="#">Edit</a> <a href="#">Clear</a> |
| Total: 1                    |                  |                                     |                   |  |

The above page displays a mirroring session, and no more session can be created. Click **Edit** to configure this mirroring session on the following page.

Figure 1-2 Configure the Mirroring Session

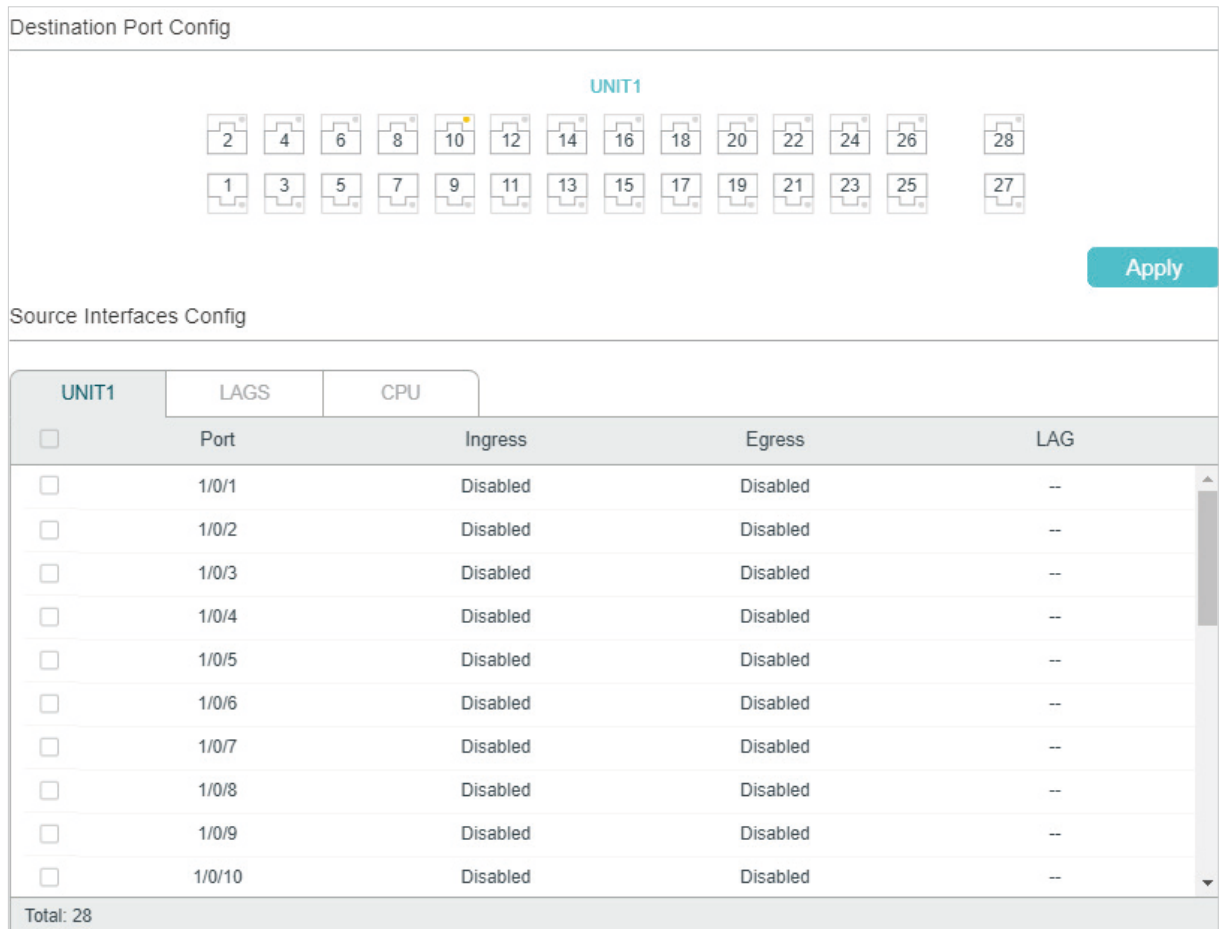

Follow these steps to configure the mirroring session:

- 1) In the **Destination Port Config** section, specify a destination port for the mirroring session, and click **Apply**.
- 2) In the **Source Interfaces Config** section, specify the source interfaces and click **Apply**. Traffic passing through the source interfaces will be mirrored to the destination port. There are three source interface types: port, LAG, and CPU. Choose one or more types according to your need.

**UNIT1** Select the desired ports as the source interfaces. The switch will send a copy of traffic passing through the port to the destination port.

**LAGS** Select the desired LAGs as the source interfaces. The switch will send a copy of traffic passing through the LAG members to the destination port.

**CPU** When selected, the switch will send a copy of traffic passing through the CPU to the destination port.

**Ingress** With this option enabled, the packets received by the corresponding interface (port, LAG or CPU) will be copied to the destination port. By default, it is disabled.

**Egress** With this option enabled, the packets sent by the corresponding interface (port, LAG or CPU) will be copied to the destination port. By default, it is disabled.

---

 Note:

- The member ports of an LAG cannot be set as a destination port or source port.
  - A port cannot be set as the destination port and source port at the same time.
- 

## 1.2 Using the CLI

Follow these steps to configure Mirroring.

|        |   |
|--------|---|
| Step 1 | <p><b>configure</b></p> <p>Enter global configuration mode.</p>   |
| Step 2 | <p><b>monitor session <i>session_num</i> destination interface { fastEthernet <i>port</i>   gigabitEthernet <i>port</i>   ten-gigabitEthernet <i>port</i> }</b></p> <p>Enable the port mirror function and set the destination port.</p> <p><i>session_num</i>: The monitor session number. It can only be specified as 1.</p> <p><i>port</i>: The destination port number. You can specify only one destination port for the mirror session.</p>   |
| Step 3 | <p><b>monitor session <i>session_num</i> source { cpu <i>cpu_numbr</i>   interface { fastEthernet <i>port-list</i>   gigabitEthernet <i>port-list</i>   ten-gigabitEthernet <i>port-list</i>   port-channel <i>port-channel-id</i> } mode</b></p> <p>Configure ports or LAGs as the monitored interfaces.</p> <p><i>session_num</i>: The monitor session number. It can only be specified as 1.</p> <p><i>cpu_number</i>: The CPU number. It can only be specified as 1.</p> <p><i>port-list</i>: List of source ports. It is multi-optional.</p> <p><i>mode</i>: The monitor mode. There are three options: <b>rx</b>, <b>tx</b> and <b>both</b>:</p> <p><b>rx</b>: The incoming packets of the source port will be copied to the destination port.</p> <p><b>tx</b>: The outgoing packets of the source port will be copied to the destination port.</p> <p><b>both</b>: Both of the incoming and outgoing packets on source port can be copied to the destination port.</p> <p><b>Note:</b></p> <p>You can configure one or more source interface types (ports, LAGs and the CPU) according to your needs.</p> |
| Step 4 | <p><b>show monitor session</b></p> <p>Verify the Port Mirror configuration.</p>   |
| Step 5 | <p><b>end</b></p> <p>Return to privileged EXEC mode.</p>  |
| Step 6 | <p><b>copy running-config startup-config</b></p> <p>Save the settings in the configuration file.</p>  |

The following example shows how to copy the received and transmitted packets on port 1/0/1,2,3 and the CPU to port 1/0/10.

**Switch#configure**

**Switch(config)#monitor session 1 destination interface gigabitEthernet 1/0/10**

```
Switch(config)#monitor session 1 source interface gigabitEthernet 1/0/1-3 both
```

```
Switch(config)#monitor session 1 source cpu 1 both
```

```
Switch(config)#show monitor session
```

```
Monitor Session:          1
Destination Port:         Gi1/0/10
Source Ports(Ingress):    Gi1/0/1-3
Source Ports(Egress):     Gi1/0/1-3
Source CPU(Ingress):      cpu1
Source CPU(Egress):       cpu1
```

```
Switch(config-if)#end
```

```
Switch#copy running-config startup-config
```



# 2 Configuration Examples

## 2.1 Network Requirements

As shown below, several hosts and a network analyzer are directly connected to the switch. For network security and troubleshooting, the network manager needs to use the network analyzer to monitor the data packets from the end hosts.

Figure 2-1 Network Topology

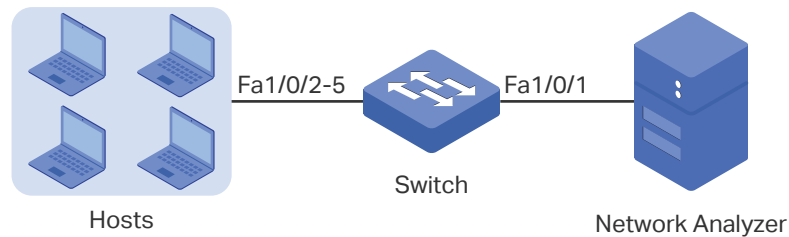

## 2.2 Configuration Scheme

To implement this requirement, you can use Mirroring feature to copy the packets from ports 1/0/2-5 to port 1/0/1. The overview of configuration is as follows:

- 1) Specify ports 1/0/2-5 as the source ports, allowing the switch to copy the packets from the hosts.
- 2) Specify port 1/0/1 as the destination port so that the network analyzer can receive mirrored packets from the hosts.

Demonstrated with T1500-28PCT, the following sections provide configuration procedure in two ways: using the GUI and using the CLI.

## 2.3 Using the GUI

- 1) Choose the menu **MAINTENANCE > Mirroring** to load the following page. It displays the information of the mirroring session.

Figure 2-2 Mirror Session List

| Port Mirroring Session List |                  |                                     |                   |  |
|-----------------------------|------------------|-------------------------------------|-------------------|--|
| Session                     | Destination Port | Mode                                | Source Interfaces | Operation                                  |
| 1                           |                  | Ingress Only<br>Egress Only<br>Both |                   | <a href="#">Edit</a> <a href="#">Clear</a> |
| Total: 1                    |                  |                                     |                   |  |

- Click **Edit** on the above page to load the following page. In the **Destination Port Config** section, select port 1/0/1 as the destination port and click **Apply**.

Figure 2-3 Destination Port Configuration

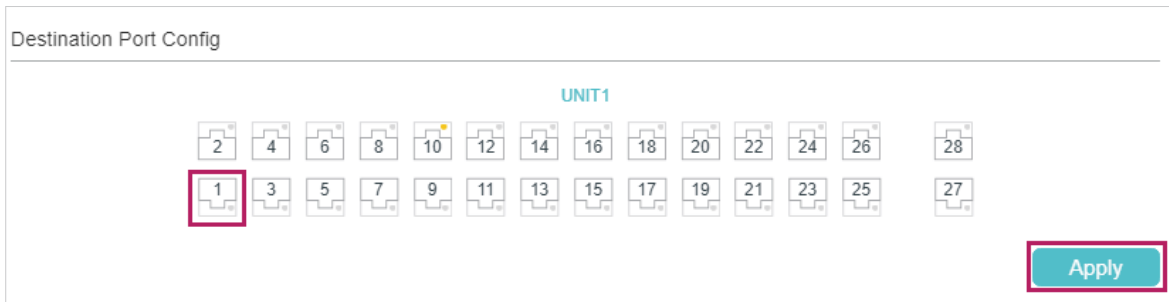

- In the **Source Interfaces Config** section, select ports 1/0/2-5 as the source ports, and enable **Ingress** and **Egress** to allow the received and sent packets to be copied to the destination port. Then click **Apply**.

Figure 2-4 Source Port Configuration

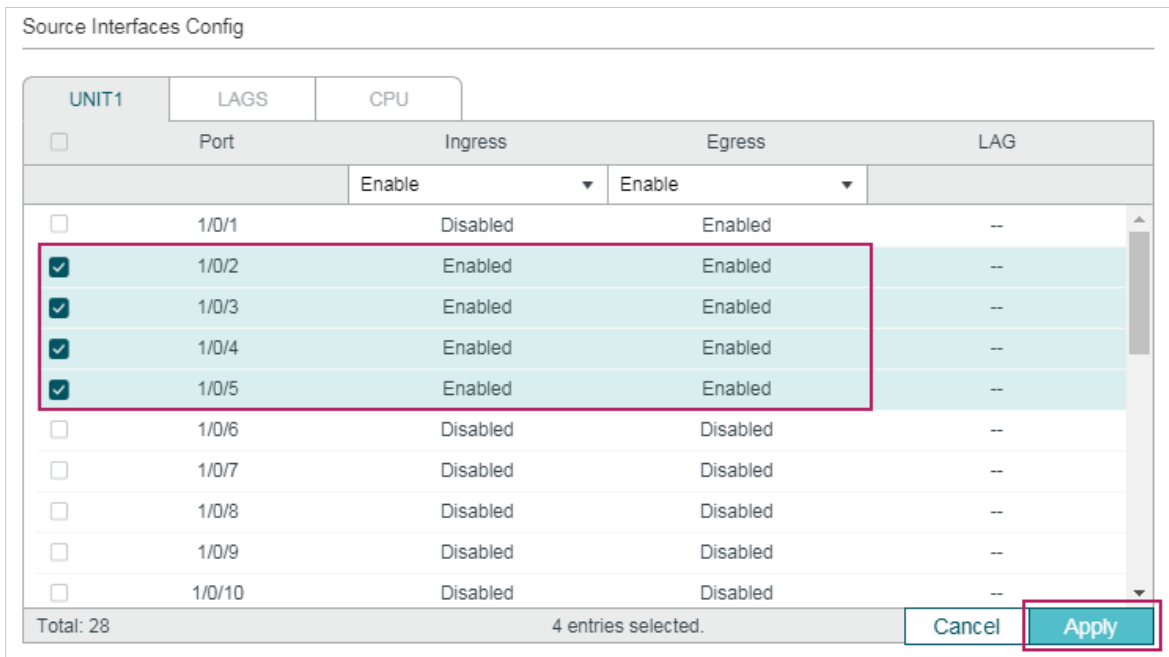

- Click  to save the settings.

## 2.4 Using the CLI

```
Switch#configure
```

```
Switch(config)#monitor session 1 destination interface fastEthernet 1/0/1
```

```
Switch(config)#monitor session 1 source interface fastEthernet 1/0/2-5 both
```

```
Switch(config)#end
```

```
Switch#copy running-config startup-config
```

## Verify the Configuration

```
Switch#show monitor session 1
```

```
Monitor Session:      1
Destination Port:     Fa1/0/1
Source Ports(Ingress): Fa1/0/2-5
Source Ports(Egress): Fa1/0/2-5
```

# 3 Appendix: Default Parameters

Default settings of Switching are listed in the following tables.

Table 3-1 Configurations for Ports

| Parameter | Default Setting |
|-----------|-----------------|
| Ingress   | Disabled        |
| Egress    | Disabled        |

# Part 27

## Configuring DLDP

### CHAPTERS

1. Overview
2. DLDP Configuration
3. Appendix: Default Parameters

# 1 Overview

DLDP (Device Link Detection Protocol) is a Layer 2 protocol that enables devices connected through fiber or twisted-pair Ethernet cables to detect whether a unidirectional link exists.

A unidirectional link occurs whenever traffic sent by a local device is received by its peer device but traffic from the peer device is not received by the local device.

Unidirectional links can cause a variety of problems, such as spanning-tree topology loops. Once detecting a unidirectional link, DLDP can shut down the related port automatically or inform users.

# 2 DLDP Configuration

## Configuration Guidelines

- A DLDP-capable port cannot detect a unidirectional link if it is connected to a DLDP-incapable port of another switch.
- To detect unidirectional links, make sure DLDP is enabled on both sides of the links.

## 2.1 Using the GUI

Choose the menu **MAINTENANCE > DLDP** to load the following page.

Figure 2-1 Configure DLDP

**Global Config**

DLDP:  Enable

Advertisement Interval:  seconds (1-30)

Shut Mode:  Auto  Manual

Auto Refresh:  Enable

Refresh Interval:  seconds (1-100)

[Apply](#)

---

**Port Config**

**UNIT1**

|                                     | Port   | DLDP     | Protocol State | Link State | Neighbour State |
|-------------------------------------|--------|----------|----------------|------------|-----------------|
| <input checked="" type="checkbox"/> | 1/0/1  | Disabled | Initial        | Link-Down  | N/A             |
| <input type="checkbox"/>            | 1/0/2  | Disabled | Initial        | Link-Down  | N/A             |
| <input type="checkbox"/>            | 1/0/3  | Disabled | Initial        | Link-Down  | N/A             |
| <input type="checkbox"/>            | 1/0/4  | Disabled | Initial        | Link-Down  | N/A             |
| <input type="checkbox"/>            | 1/0/5  | Disabled | Initial        | Link-Down  | N/A             |
| <input type="checkbox"/>            | 1/0/6  | Disabled | Initial        | Link-Down  | N/A             |
| <input type="checkbox"/>            | 1/0/7  | Disabled | Initial        | Link-Down  | N/A             |
| <input type="checkbox"/>            | 1/0/8  | Disabled | Initial        | Link-Down  | N/A             |
| <input type="checkbox"/>            | 1/0/9  | Disabled | Initial        | Link-Down  | N/A             |
| <input type="checkbox"/>            | 1/0/10 | Disabled | Initial        | Link-Down  | N/A             |

Total: 28 1 entry selected.

[Cancel](#) [Apply](#)

Follow these steps to configure DLDP:

- 1) In the **Global Config** section, enable DLDP and configure the relevant parameters. Click **Apply**.

|                        |  |
|------------------------|--|
| DLDP State             | Enable or disable DLDP globally.   |
| Advertisement Interval | Configure the interval to send advertisement packets. Valid values are from 1 to 30 seconds, and the default value is 5 seconds.   |
| Shut Mode              | Choose how to shut down the port when a unidirectional link is detected:<br><br><b>Auto:</b> When a unidirectional link is detected on a port, DLDP will generate logs and traps then shut down the port, and DLDP on this port will change to Disabled.<br><br><b>Manual:</b> When a unidirectional link is detected on a port, DLDP will generate logs and traps, and then users can manually shut down the unidirectional link ports. |
| Auto Refresh           | With this option enabled, the switch will automatically refresh the DLDP information.  |
| Refresh Interval       | Specify the time interval at which the switch will refresh the DLDP information. Valid values are from 1 to 100 seconds, and the default value is 3 seconds.   |

- 2) In the **Port Config** section, select one or more ports, enable DLDP and click **Apply**. Then you can view the relevant DLDP information in the table.

|                 |  |
|-----------------|--|
| DLDP            | Enable or disable DLDP on the port.  |
| Protocol State  | Displays the DLDP protocol state.<br><br><b>Initial:</b> DLDP is disabled.<br><br><b>Inactive:</b> DLDP is enabled but the link is down.<br><br><b>Active:</b> DLDP is enabled and the link is up, or the neighbor entries in this device are empty.<br><br><b>Advertisement:</b> No unidirectional link is detected (the device has established bidirectional links with all its neighbors) or DLDP has remained in an Active status for more than 5 seconds.<br><br><b>Probe:</b> In this state, the device will send out Probe packets to detect whether the link is unidirectional. The port enters this state from the Active state if it receives a packet from an unknown neighbor.<br><br><b>Disable:</b> A unidirectional link is detected. |
| Link State      | Displays the link state.<br><br><b>Link-Down:</b> The link is down.<br><br><b>Link-Up:</b> The link is up.   |
| Neighbour State | Displays the neighbour state.<br><br><b>Unknown:</b> Link detection is in progress.<br><br><b>Unidirectional:</b> The link between the port and the neighbor is unidirectional.<br><br><b>Bidirectional:</b> The link between the port and the neighbor is bidirectional.  |



## 2.2 Using the CLI

Follow these steps to configure DLDP:

---

|        |   |   |
|--------|---|---|
| Step 1 | <b>configure</b>  | Enter global configuration mode.  |
| Step 2 | <b>dldp</b>   | Globally enable DLDP.   |
| Step 3 | <b>dldp interval <i>interval-time</i></b>   | Configure the interval of sending advertisement packets on ports that are in the advertisement state.<br><br><i>interval-time</i> : Specify the interval time. The valid values are from 1 to 30 seconds. By default, it is 5 seconds.  |
| Step 3 | <b>dldp shut-mode { auto   manual }</b>   | Configure the DLDP shutdown mode when a unidirectional link is detected.<br><br><i>auto</i> : The switch automatically shuts down ports when a unidirectional link is detected. It is the default setting.<br><br><i>manual</i> : The switch displays an alert when a unidirectional link is detected. Then the users can manually shut down the unidirectional link ports. |
| Step 4 | <b>interface {fastEthernet <i>port</i>   range fastEthernet <i>port-list</i>   gigabitEthernet <i>port</i>   range gigabitEthernet <i>port-list</i>   ten-gigabitEthernet <i>port</i>   range ten-gigabitEthernet <i>port-list</i>}</b> | Enter interface configuration mode.   |
| Step 5 | <b>dldp</b>   | Enable DLDP on the specified port.  |
| Step 6 | <b>show dldp</b>  | Verify the global DLDP configuration.   |
| Step 7 | <b>show dldp interface</b>  | Verify the DLDP configuration of the ports.   |
| Step 8 | <b>end</b>  | Return to privileged EXEC mode.   |
| Step 9 | <b>copy running-config startup-config</b>   | Save the settings in the configuration file.  |

---

The following example shows how to enable DLDP globally, configure the DLDP interval as 10 seconds and specify the shutdown mode as auto.

**Switch#configure**

```

Switch(config)#dldp
Switch(config)#dldp interval 10
Switch(config)#dldp shut-mode auto
Switch(config)#show dldp
DLDP Global State: Enable
DLDP Message Interval: 10
DLDP Shut Mode: Auto
Switch(config)#end
Switch#copy running-config startup-config

```

The following example shows how to enable DLDP on port 1/0/1.

```

Switch#configure
Switch(config)#interface gigabitEthernet 1/0/1
Switch(config-if)#dldp
Switch(config-if)#show dldp interface

```

| Port    | DLDP State | Protocol State | Link State | Neighbor State |
|---------|------------|----------------|------------|----------------|
| ----    | -----      | -----          | -----      | -----          |
| Gi1/0/1 | Enable     | Inactive       | Link-Down  | N/A            |
| Gi1/0/2 | Disable    | Initial        | Link-Down  | N/A            |
| ...     |            |                |            |                |

```

Switch(config-if)#end
Switch#copy running-config startup-config

```

# 3 Appendix: Default Parameters

Default settings of DLDP are listed in the following table.

Table 3-1 Default Settings of DLDP

| Parameter              | Default Setting |
|------------------------|-----------------|
| Global Config          |                 |
| DLDP State             | Disabled        |
| Advertisement Interval | 5 seconds       |
| Shut Mode              | Auto            |
| Auto Refresh           | Disabled        |
| Refresh Interval       | 3 seconds       |
| Port Config            |                 |
| DLDP                   | Disabled        |

# Part 28

## Configuring SNMP & RMON

### CHAPTERS

1. SNMP
2. SNMP Configurations
3. Notification Configurations
4. RMON
5. RMON Configurations
6. Configuration Example
7. Appendix: Default Parameters

# 1 SNMP

## 1.1 Overview

SNMP (Simple Network Management Protocol) is a standard network management protocol, widely used on TCP/IP networks. It facilitates device management using NMS (Network Management System) applications. With SNMP, network managers can view or modify the information of network devices, and timely troubleshoot according to notifications sent by those devices.

As the following figure shows, the SNMP system consists of an SNMP manager, an SNMP agent, and a MIB (Management Information Base).

The SNMP manager is a host that runs NMS applications. The agent and MIB reside on the managed device, such as the switch, router, host or printer. By configuring SNMP on the switch, you define the relationship between the manager and the agent.

Figure 1-1 SNMP System

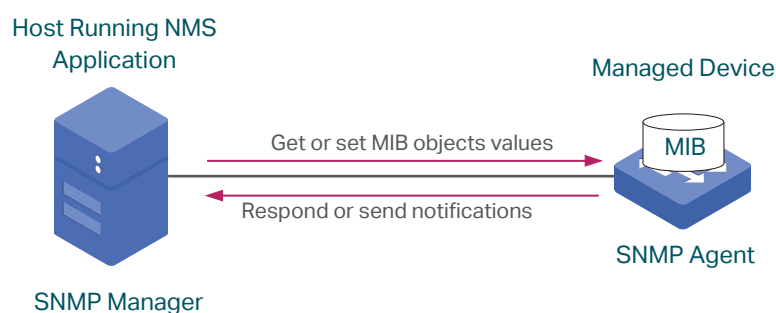

## 1.2 Basic Concepts

The following basic concepts of SNMP will be introduced: SNMP manager, SNMP agent, MIB (Management Information Base), SNMP entity, SNMP engine, Notification types and SNMP version.

### SNMP Manager

The SNMP manager uses SNMP to monitor and control SNMP agents, providing a friendly management interface for the administrator to manage network devices conveniently. It can get values of MIB objects from an agent or set values for them. Also, it receives notifications from the agents so as to learn the condition of the network.

### SNMP Agent

An SNMP agent is a process running on the managed device. It contains MIB objects whose values can be requested or set by the SNMP manager. An agent can send unsolicited trap messages to notify the SNMP manager that a significant event has occurred on the agent.

## MIB

A MIB is a collection of managed objects that is organized hierarchically. The objects define the attributes of the managed device, including the names, status, access rights, and data types. Each object can be addressed through an object identifier (OID).

As the following figure shows, the MIB hierarchy can be depicted as a tree with a nameless root, the levels of which are assigned by different organizations. The top-level MIB object IDs belong to different standard organizations, while lower-level object IDs are allocated by associated organizations. Vendors can define private branches that include managed objects for their own products.

Figure 1-2 MIB Tree

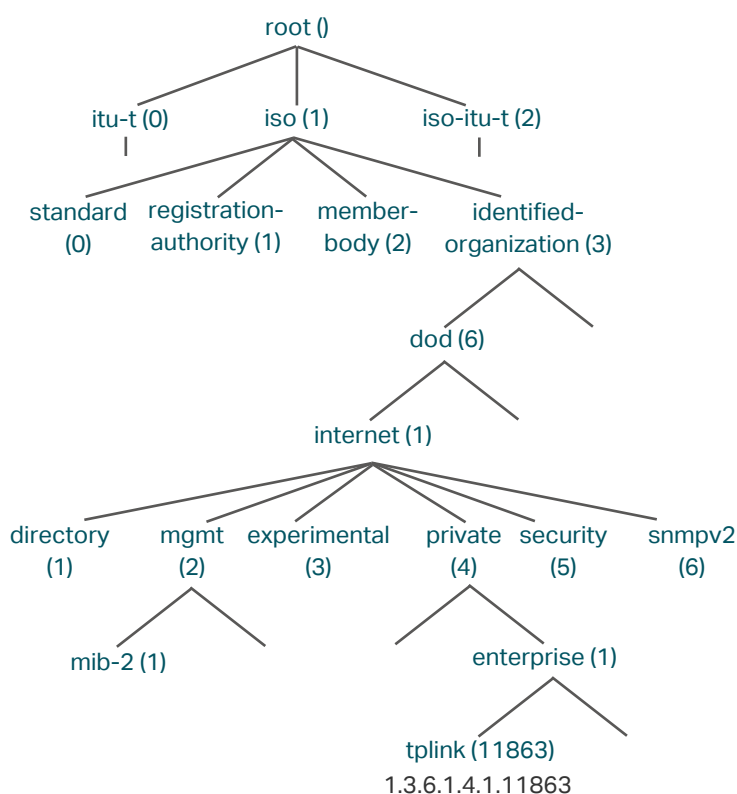

TP-Link switches provide private MIBs that can be identified by the OID 1.3.6.1.4.1.11863. The MIB file can be found on the provided CD or in the download center of our official website: <https://www.tp-link.com/download-center.html>.

Also, TP-Link switches support the following public MIBs:

- LLDP.mib
- LLDP-Ext-Dot1.mib
- LLDP-Ext-MED.mib
- RFC1213.mib
- RFC1493-Bridge.mib
- RFC1757-RMON.mib
- RFC2618-RADIUS-Auth-Client.mib

- RFC2620-RADIUS-Acc-Client.mib
- RFC2674-pBridge.mib
- RFC2674-qBridge.mib
- RFC2863-pBridge.mib
- RFC2925-Disman-Ping.mib
- RFC2925-Disman-Traceroute.mib

For detail information about the supported public MIBs, see *Supported Public MIBs for TP-Link Switches*.

## SNMP Entity

An SNMP entity is a device running the SNMP protocol. Both the SNMP manager and SNMP agent are SNMP entities.

## SNMP Engine

An SNMP engine is a part of the SNMP entity. Every SNMP entity has one and only one engine. An SNMP engine provides services for sending and receiving messages, authenticating and encrypting messages, and controlling access to managed objects.

An SNMP engine can be uniquely identified by an engine ID within an administrative domain. Since there is a one-to-one association between SNMP engines and SNMP entities, we can also use the engine ID to uniquely identify the SNMP entity within that administrative domain.

## Notification Types

Notifications are messages that the switch sends to the NMS host when important events occur. Notifications facilitate the monitoring and management of the NMS. There are two types of notifications:

- **Trap:** When the NMS host receives a Trap message, it will not send a response to the switch. Thus the switch cannot tell whether a message is received or not, and the messages that are not received will not be resent.
- **Inform:** When the NMS host receives an Inform message, it sends a response to the switch. If the switch does not receive any response within the timeout interval, it will resend the Inform message. Therefore, Inform is more reliable than Trap.

## SNMP Version

The device supports three SNMP versions with the security level from low to high: SNMPv1, SNMPv2c and SNMPv3. *Table 1-1* lists features supported by different SNMP versions, and *Table 1-2* shows corresponding application scenarios.

Table 1-1 Features Supported by Different SNMP Versions

| Feature                    | SNMPv1                               | SNMPv2c                              | SNMPv3  |
|----------------------------|--------------------------------------|--------------------------------------|---|
| Access Control             | Based on SNMP Community and MIB View | Based on SNMP Community and MIB View | Based on SNMP User, Group, and MIB View   |
| Authentication and Privacy | Based on Community Name              | Based on Community Name              | Supported authentication and privacy modes are as follows:<br>Authentication: MD5/SHA<br>Privacy: DES |
| Trap                       | Supported                            | Supported                            | Supported   |
| Inform                     | Not supported                        | Supported                            | Supported   |

Table 1-2 Application Scenarios of Different Versions

| Version | Application Scenario  |
|---------|---|
| SNMPv1  | SNMPv1 is applicable to small-scale networks with simple networking, good stability and low security requirements, such as campus networks and small enterprise networks.   |
| SNMPv2c | SNMPv2c is applicable to medium and large-scale networks with low security requirements (or are already secure enough like VPN networks) and heavy traffic. The added feature Inform helps to ensure that the notifications from the switch are received by the NMS host even when network congestion occurs. |
| SNMPv3  | SNMPv3 is applicable to networks of various scales, particularly those that have high security requirements and require devices to be managed by authenticated administrators (such as when data needs to be transferred on public networks).   |



# 2 SNMP Configurations

To complete the SNMP configuration, choose an SNMP version according to network requirements and supportability of the NMS application, and then follow these steps:

- Choose SNMPv1 or SNMPv2c

- 1) Enable SNMP.
- 2) Create an SNMP view for managed objects.
- 3) Create a community, specify the accessible view and the corresponding access rights.

- Choose SNMPv3

- 1) Enable SNMP.
- 2) Create an SNMP view for managed objects.
- 3) Create an SNMP group, and specify the security level and accessible view.
- 4) Create SNMP users, and configure the authentication mode, privacy mode and corresponding passwords.

## 2.1 Using the GUI

### 2.1.1 Enabling SNMP

Choose the **MAINTENANCE > SNMP > Global Config** to load the following page.

Figure 2-1 Configuring Global Parameters

Follow these steps to configure SNMP globally:

- 1) In the **Global Config** section, enable SNMP and configure the local and remote engine ID.

| SNMP | Enable or disable SNMP globally. |
|------|----------------------------------|
|------|----------------------------------|

**Local Engine ID** Set the engine ID of the local SNMP agent (the switch) with 10 to 64 hexadecimal digits. A valid engine ID must contain an even number of characters. By default, the switch generates the engine ID using TP-Link's enterprise number (80002e5703) and its own MAC address.

The local engine ID is a unique alphanumeric string used to identify the SNMP engine. As an SNMP agent contains only one SNMP engine, the local engine ID can uniquely identify the SNMP agent.

**Remote Engine ID** Set the engine ID of the remote SNMP manager with 10 to 64 hexadecimal digits. A valid engine ID must contain an even number of characters. If no remote SNMP manager is needed, you can leave this field empty.

The remote engine ID is a unique alphanumeric string. It is used to identify the SNMP engine on the remote device that receives Inform messages from the switch.

## 2) Click **Apply**.

### Note:









In SNMPv3, changing the value of the SNMP engine ID has important side effects. A user's password is converted to an MD5 or SHA security digest based on the password itself and the engine ID. If the value of local engine ID changes, the switch will automatically delete all SNMPv3 local users as their security digests become invalid. Similarly, all SNMPv3 remote users will be deleted if the value of remote engine ID changes.

## 2.1.2 Creating an SNMP View

An SNMP view is a subnet of a MIB. NMS manages MIB objects based on the view. The system has a default view named viewDefault. You can create a new one or edit the default view according to your needs.

Choose the menu **MAINTENANCE > SNMP > Global Config** to load the following page.

Figure 2-2 SNMP View Config

| SNMP View Config         |       |             |           |                |   |
|--------------------------|-------|-------------|-----------|----------------|---|
| <input type="checkbox"/> | Index | View Name   | View Type | MIB Object ID  | Operation   |
| <input type="checkbox"/> | 1     | viewDefault | Include   | 1              |   |
| <input type="checkbox"/> | 2     | viewDefault | Exclude   | 1.3.6.1.6.3.15 |   |
| <input type="checkbox"/> | 3     | viewDefault | Exclude   | 1.3.6.1.6.3.16 |   |
| <input type="checkbox"/> | 4     | viewDefault | Exclude   | 1.3.6.1.6.3.18 |   |
| Total: 4                 |       |             |           |                |   |

Follow these steps to create an SNMP view:

- 1) Click  **Add** to load the following page. Enter a view name, and specify the view type and a MIB object ID that is related to the view.

Figure 2-3 Creating an SNMP View



The image shows a web form titled "SNMP View Config". It contains three input fields: "View Name" with a text box and "(16 characters maximum)" label; "View Type" with two radio buttons, "Include" (selected) and "Exclude"; and "MIB Object ID" with a text box and "(61 characters maximum)" label. At the bottom right are two buttons: "Cancel" and "Create".

**View Name** Set the view name with 1 to 16 characters. A complete view consists of all MIB objects that have the same view name.

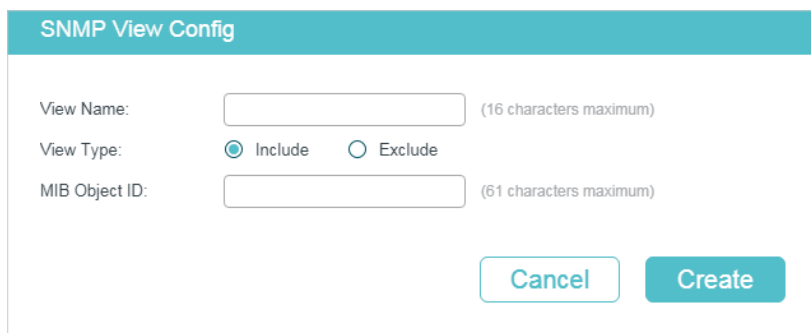
**View Type** Set the view to include or exclude the related MIB object.

**Include:** The NMS can view or manage the function indicated by the object.

**Exclude:** The NMS cannot view or manage the function indicated by the object.

**MIB Object ID** Enter a MIB Object ID to specify a specific function of the device. When a MIB Object ID is specified, all its child Object IDs are specified. For specific ID rules, refer to the device related MIBs.

2) Click **Create**.

### 2.1.3 Creating SNMP Communities (For SNMP v1/v2c)

Choose the menu **MAINTENANCE > SNMP > SNMP v1/v2c** and click  **Add** to load the following page.

Figure 2-4 Creating an SNMP Community



The image shows a web form titled "SNMP Community Config". It contains three input fields: "Community Name" with a text box and "(16 characters maximum)" label; "Access Mode" with two radio buttons, "Read Only" (selected) and "Read & Write"; and "MIB View" with a dropdown menu showing "viewDefault". At the bottom right are two buttons: "Cancel" and "Create".

Follow these steps to create an SNMP community:

1) Set the community name, access rights and the related view.

**Community Name** Configure the community name. This community name is used like a password and the NMS can access the specified MIB objects of the switch using the same community name.

|                    |  |
|--------------------|--|
| <b>Access Mode</b> | Specify the access right to the related view.<br><br><b>Read Only:</b> The NMS can view but not modify parameters of the specified view.<br><br><b>Read &amp; Write:</b> The NMS can view and modify parameters of the specified view. |
| <b>MIB View</b>    | Choose an SNMP view that allows the community to access.   |

2) Click **Create**.

## 2.1.4 Creating an SNMP Group (For SNMP v3)

Choose the menu **MAINTENANCE > SNMP > SNMP v3 > SNMP Group** and click  Add to load the following page.

Figure 2-5 Creating an SNMP Group

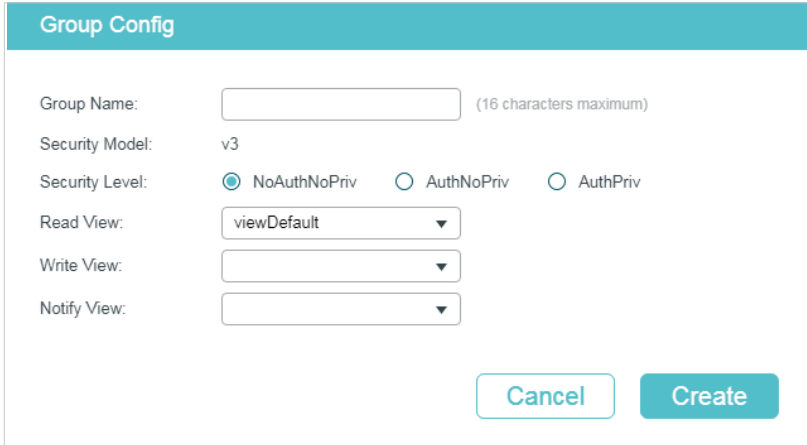

**Group Config**

Group Name:  (16 characters maximum)

Security Model: v3

Security Level:  NoAuthNoPriv  AuthNoPriv  AuthPriv

Read View:

Write View:

Notify View:

Follow these steps to create an SNMP Group and configure related parameters.

1) Assign a name to the group, then set the security level and the read view, write view and notify view.

|                       |  |
|-----------------------|--|
| <b>Group Name</b>     | Set the SNMP group name using 1 to 16 characters.<br><br>The identifier of a group consists of a group name, security model and security level. Groups of the same identifier are recognized as being in the same group.   |
| <b>Security Model</b> | Displays the security model. SNMPv3 uses v3, the most secure model.  |
| <b>Security Level</b> | Set the security level for the SNMPv3 group.<br><br><b>NoAuthNoPriv:</b> No authentication algorithm but a user name match is applied to check packets, and no privacy algorithm is applied to encrypt them.<br><br><b>AuthNoPriv:</b> An authentication algorithm is applied to check packets, but no privacy algorithm is applied to encrypt them.<br><br><b>AuthPriv:</b> An authentication algorithm and a privacy algorithm are applied to check and encrypt packets. |

|                    |  |
|--------------------|--|
| <b>Read View</b>   | Choose a view to allow parameters to be viewed but not modified by the NMS. The view is necessary for any group.       |
| <b>Write View</b>  | Choose a view to allow parameters to be modified by the NMS. The view in Write View should also be added to Read View. |
| <b>Notify View</b> | Choose a view to allow it to send notifications to the NMS.  |

2) Click **Create**.

## 2.1.5 Creating SNMP Users (For SNMP v3)

Choose the menu **MAINTENANCE > SNMP > SNMP v3 > SNMP User** and click  Add to load the following page.

Figure 2-6 Creating an SNMP User

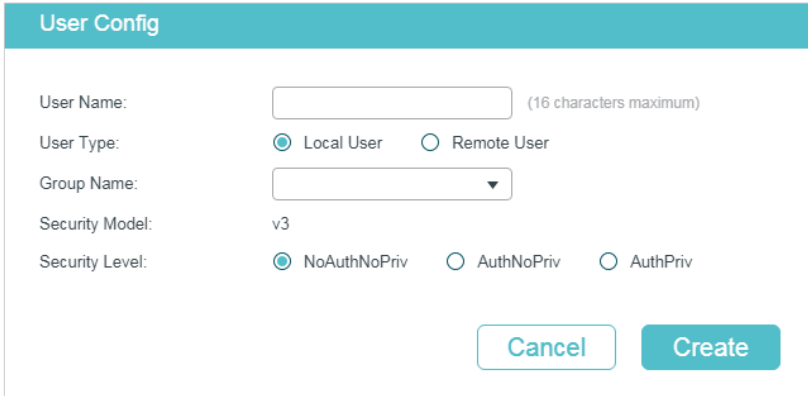

The screenshot shows the 'User Config' form with the following fields and options:

- User Name:** A text input field with a placeholder and '(16 characters maximum)' to its right.
- User Type:** Two radio buttons: 'Local User' (selected) and 'Remote User'.
- Group Name:** A dropdown menu.
- Security Model:** A text input field containing 'v3'.
- Security Level:** Three radio buttons: 'NoAuthNoPriv' (selected), 'AuthNoPriv', and 'AuthPriv'.

At the bottom right of the form are two buttons: 'Cancel' and 'Create'.

Follow these steps to create an SNMP user:

1) Specify the user name and user type as well as the group which the user belongs to. Then configure the security level.

|                       |   |
|-----------------------|---|
| <b>User Name</b>      | Set the SNMP user name using 1 to 16 characters. For different entries, user names cannot be the same.  |
| <b>User Type</b>      | Choose a user type based on the location of the user.<br><br><b>Local User:</b> The user resides on the local engine, which is the SNMP agent of the switch.<br><br><b>Remote User:</b> The user resides on the NMS. Before configuring a remote user, you need to set the remote engine ID first. The remote engine ID and user password are used when computing the authentication and privacy digests. |
| <b>Group Name</b>     | Choose the name of the group that the user belongs to. Users with the same Group Name, Security Model and Security Level will be in the same group.   |
| <b>Security Model</b> | Displays the security model. SNMPv3 uses v3, the most secure model.   |

|                       |   |
|-----------------------|---|
| <b>Security Level</b> | <p>Set the security level. The security level from lowest to highest is: NoAuthNoPriv, AuthNoPriv, AuthPriv. The security level of the user should not be lower than the group it belongs to.</p> <p><b>NoAuthNoPriv:</b> No authentication algorithm but a user name match is applied to check packets, and no privacy algorithm is applied to encrypt them.</p> <p><b>AuthNoPriv:</b> An authentication algorithm is applied to check packets, but no privacy algorithm is applied to encrypt them.</p> <p><b>AuthPriv:</b> An authentication algorithm and a privacy algorithm are applied to check and encrypt packets.</p> |
|-----------------------|---|

- 2) If you have chosen **AuthNoPriv** or **AuthPriv** as the security level, you need to set corresponding Authentication Mode or Privacy Mode. If not, skip this step.

|                            |  |
|----------------------------|--|
| <b>Authentication Mode</b> | <p>With AuthNoPriv or AuthPriv selected, configure the authentication mode and password for authentication. Two authentication modes are provided:</p> <p><b>MD5:</b> Enable the HMAC-MD5 algorithm for authentication.</p> <p><b>SHA:</b> Enable the SHA (Secure Hash Algorithm) algorithm for authentication. SHA algorithm is securer than MD5 algorithm.</p> |
|----------------------------|--|

|                                |                                      |
|--------------------------------|--------------------------------------|
| <b>Authentication Password</b> | Set the password for authentication. |
|--------------------------------|--------------------------------------|

|                     |  |
|---------------------|--|
| <b>Privacy Mode</b> | With AuthPriv selected, configure the privacy mode and password for encryption. The switch uses the DES (Data Encryption Standard) algorithm for encryption. |
|---------------------|--|

|                         |                                  |
|-------------------------|----------------------------------|
| <b>Privacy Password</b> | Set the password for encryption. |
|-------------------------|----------------------------------|

- 3) Click **Create**.

## 2.2 Using the CLI

### 2.2.1 Enabling SNMP

|        |   |
|--------|---|
| Step 1 | <p><b>configure</b></p> <p>Enter Global Configuration Mode.</p> |
|--------|---|

|        |   |
|--------|---|
| Step 2 | <p><b>snmp-server</b></p> <p>Enabling SNMP.</p> |
|--------|---|

---

Step 3 **snmp-server engineID** {[ *local local-engineID*] [*remote remote-engineID*]}

Configure the local engine ID and the remote engine ID.

*local-engineID*: Enter the engine ID of the local SNMP agent (the switch) with 10 to 64 hexadecimal digits. A valid engine ID must contain an even number of characters. By default, the switch generates the engine ID using TP-Link's enterprise number (80002e5703) and its own MAC address.

The local engine ID is a unique alphanumeric string used to identify the SNMP engine. As an SNMP agent contains only one SNMP engine, the local engine ID can uniquely identify the SNMP agent.

*remote-engineID*: Enter the remote engine ID with 10 to 64 hexadecimal digits. A valid engine ID must contain an even number of characters. The remote engine ID is a unique alphanumeric string. It is used to identify the SNMP engine on the remote device that receives inform messages from switch.

*Note:*

In SNMPv3, changing the value of the SNMP engine ID has important side effects. A user's password is converted to an MD5 or SHA security digest based on the password itself and the engine ID. If the value of local engine ID changes, the switch will automatically delete all SNMPv3 local users as their security digests become invalid. Similarly, all SNMPv3 remote users will be deleted if the value of remote engine ID changes.

---

Step 4 **show snmp-server**

Displays the global settings of SNMP.

---

Step 5 **show smnp-server engineID**

Displays the engine ID of SNMP.

---

Step 6 **end**

Return to Privileged EXEC Mode.

---

Step 7 **copy running-config startup-config**

Save the settings in the configuration file.

---

The following example shows how to enable SNMP and set 123456789a as the remote engine ID:

**Switch#configure**

**Switch(config)#snmp-server**

**Switch(config)#snmp-server engineID remote 123456789a**

**Switch(config)#show snmp-server**

SNMP agent is enabled.

0 SNMP packets input

0 Bad SNMP version errors

- 0 Unknown community name
- 0 Illegal operation for community name supplied
- 0 Encoding errors
- 0 Number of requested variables
- 0 Number of altered variables
- 0 Get-request PDUs
- 0 Get-next PDUs
- 0 Set-request PDUs
- 0 SNMP packets output
  - 0 Too big errors (Maximum packet size 1500)
  - 0 No such name errors
  - 0 Bad value errors
  - 0 General errors
  - 0 Response PDUs
  - 0 Trap PDUs

**Switch(config)#show snmp-server engineID**

Local engine ID: 80002e5703000aeb13a23d

Remote engine ID: 123456789a

**Switch(config)#end****Switch#copy running-config startup-config**

## 2.2.2 Creating an SNMP View

Specify the OID (Object Identifier) of the view to determine objects to be managed.

- 
- |        |                                  |
|--------|----------------------------------|
| Step 1 | <b>configure</b>                 |
|        | Enter Global Configuration Mode. |
-



---

Step 2      **snmp-server view** *name mib-oid* {include | exclude}

Configure the view.

*name*: Enter a view name with 1 to 16 characters. You can create multiple entries with each associated to a MIB object. A complete view consists of all MIB objects that have the same view name.

*mib-oid*: Enter the MIB object ID with 1 to 61 characters. When a MIB Object ID is specified, all its child Object IDs are specified. For specific ID rules, refer to the device related MIBs.

*include | exclude*: Specify a view type. Include indicates that objects of the view can be managed by the NMS, while exclude indicates that objects of the view cannot be managed by the NMS.

---

Step 3      **show snmp-server view**

Displays the view table.

---

Step 4      **end**

Return to Privileged EXEC Mode.

---

Step 5      **copy running-config startup-config**

Save the settings in the configuration file.

---

The following example shows how to set a view to allow the NMS to manage all function. Name the view as View:

**Switch#configure**

**Switch(config)#snmp-server view** View 1 include

**Switch(config)#show snmp-server view**

| No. | View Name   | Type    | MOID           |
|-----|-------------|---------|----------------|
| --- | -----       | -----   | ----           |
| 1   | viewDefault | include | 1              |
| 2   | viewDefault | exclude | 1.3.6.1.6.3.15 |
| 3   | viewDefault | exclude | 1.3.6.1.6.3.16 |
| 4   | viewDefault | exclude | 1.3.6.1.6.3.18 |
| 5   | View        | include | 1              |

**Switch(config)#end**

**Switch#copy running-config startup-config**

### 2.2.3 Creating SNMP Communities (For SNMP v1/v2c)

For SNMPv1 and SNMPv2c the Community Name is used for authentication, functioning as the password.

|        |  |
|--------|--|
| Step 1 | <b>configure</b><br>Enter Global Configuration Mode.   |
| Step 2 | <b>snmp-server community</b> <i>name</i> { read-only   read-write } [ <i>mib-view</i> ]<br>Configure the community.<br><i>name</i> : Enter a group name with 1 to 16 characters.<br><i>read-only</i>   <i>read-write</i> : Choose an access permissions for the community. Read-only indicates that the NMS can view but cannot modify parameters of the view, while read-write indicates that the NMS can both view and modify.<br><i>mib-view</i> : Enter a view to allow it to be accessed by the community. The name contains 1 to 61 characters. The default view is viewDefault. |
| Step 3 | <b>show snmp-server community</b><br>Displays community entries.   |
| Step 4 | <b>end</b><br>Return to Privileged EXEC Mode.  |
| Step 5 | <b>copy running-config startup-config</b><br>Save the settings in the configuration file.  |

The following example shows how to set an SNMP community. Name the community as the nms-monitor, and allow the NMS to view and modify parameters of View:

**Switch#configure**

**Switch(config)#snmp-server community** nms-monitor read-write View

**Switch(config)#show snmp-server community**

| Index | Name        | Type       | MIB-View |
|-------|-------------|------------|----------|
| ----- | -----       | -----      | -----    |
| 1     | nms-monitor | read-write | View     |

**Switch(config)#end**

**Switch#copy running-config startup-config**

## 2.2.4 Creating an SNMP Group (For SNMPv3)

Create an SNMP group and set user access control with read, write and notify views. Meanwhile, set the authentication and privacy modes to secure the communication between the NMS and managed devices.

|        |  |
|--------|--|
| Step 1 | <b>configure</b><br>Enter Global Configuration Mode. |
|--------|--|

- 
- Step 2      **snmp-server group** *name* [ **smode** v3 ] [ **slev** {noAuthNoPriv | authNoPriv | authPriv}] [ **read** *read-view* ] [ **write** *write-view* ] [ **notify** *notify-view* ]
- Create an SNMP group.
- name*: Enter the group name with 1 to 16 characters. The identifier of a group consists of a group name, security model and security level. Groups of the same identifier are recognized as being in the same group.
- v3**: Configure the security model for the group. v3 indicates SNMPv3, the most secure model.
- noAuthNoPriv | authNoPriv | authPriv**: Choose a security level. The security levels are sorted from low to high, and the default is noAuthNoPriv.
- noAuthNoPriv** indicates no authentication algorithm but a user name match is applied to check packets, and no privacy algorithm is applied to encrypt them. **authNoPriv** indicates an authentication algorithm is applied to check packets, but no privacy algorithm is applied to encrypt them. **authPriv** indicates an authentication algorithm and a privacy algorithm are applied to check and encrypt packets.
- read-view*: Set the view to be the Read view. Then the NMS can view parameters of the specified view.
- write-view*: Set the view to be the Write view. Then the NMS can modify parameters of the specified view. Note that the view in the Write view should also be in the Read view.
- notify-view*: Set the view to be the Notify view. Then the NMS can get notifications of the specified view from the agent.
- 
- Step 3      **show snmp-server group**
- Displays SNMP group entries.
- 
- Step 4      **end**
- Return to Privileged EXEC Mode.
- 
- Step 5      **copy running-config startup-config**
- Save the settings in the configuration file.
- 

The following example shows how to create an SNMPv3 group with the group name as nms1, the security level as authPriv, and the Read and Notify view are both View:

**Switch#configure**

**Switch(config)#snmp-server group** nms1 **smode** v3 **slev** authPriv **read** View **notify** View

**Switch(config)#show snmp-server group**

| No. | Name  | Sec-Mode | Sec-Lev  | Read-View | Write-View | Notify-View |
|-----|-------|----------|----------|-----------|------------|-------------|
| --- | ----- | -----    | -----    | -----     | -----      | -----       |
| 1   | nms1  | v3       | authPriv | View      |            | View        |

**Switch(config)#end**

**Switch#copy running-config startup-config**

## 2.2.5 Creating SNMP Users (For SNMPv3)

Create SNMP users and add them to the SNMP group. Users in the same group have the same access rights which are controlled by the read, write and notify views of the group.

|        |  |
|--------|--|
| Step 1 | <p><b>configure</b></p> <p>Enter Global Configuration Mode.</p>  |
| Step 2 | <p>Choose a security level for the user and run the corresponding command to create the user. The security levels from low to high are NoAuthNoPriv, AuthNoPriv, and AuthPriv. The security level of a user should not be lower than that of the group it belongs to.</p> <p>To create a user with the security level as NoAuthNoPriv:</p> <pre><b>snmp-server user</b> <i>name</i> { <i>local</i>   <i>remote</i> } <i>group-name</i> [ <b>smode</b> v3 ] <b>slev</b> noAuthNoPriv</pre> <p><i>name</i>: Enter the user name with 1 to 16 characters.</p> <p><i>local</i>   <i>remote</i>: Choose a user type based on the location of the user. Local indicates that the user resides on the local SNMP engine (the switch), while remote indicates that the user resides on the NMS. Before configuring a remote user, you need to set the remote engine ID first. The remote engine ID and user password are used when computing the authentication and privacy digests.</p> <p><i>group-name</i>: Enter the name of the group which the user belongs to. Users with the same Group Name, Security Model and Security Level will be in the same group.</p> <p><i>v3</i>: Configure the security model for the user. v3 indicates SNMPv3, the most secure model.</p> <p><i>noAuthNoPriv</i>: Configure the security level as noAuthNoPriv. For this level, no authentication algorithm but a user name match is applied to check packets, and no privacy algorithm is applied to encrypt them.</p> <p>To create a user with the security level as AuthNoPriv:</p> <pre><b>snmp-server user</b> <i>name</i> { <i>local</i>   <i>remote</i> } <i>group-name</i> [ <b>smode</b> v3 ] <b>slev</b> authNoPriv <b>cmode</b> {MD5   SHA } <b>cpwd</b> <i>confirm-pwd</i></pre> <p><i>authNoPriv</i>: Configure the security level as authNoPriv. For this level, an authentication algorithm is applied to check packets, but no privacy algorithm is applied to encrypt them.</p> <p><i>MD5</i>   <i>SHA</i>: Choose an authentication algorithm when the security level is set as <b>authNoPriv</b> or <b>authPriv</b>. SHA authentication mode has a higher security than MD5 mode. By default, the Authentication Mode is none.</p> <p><i>confirm-pwd</i>: Enter an authentication password with 1 to 16 characters excluding question mark and space. This password in the configuration file will be displayed in the symmetric encrypted form.</p> <p>To create a user with the security as AuthPriv:</p> <pre><b>snmp-server user</b> <i>name</i> { <i>local</i>   <i>remote</i> } <i>group-name</i> [ <b>smode</b> v3 ] <b>slev</b> authPriv <b>cmode</b> {MD5   SHA } <b>cpwd</b> <i>confirm-pwd</i> <b>emode</b> DES <b>epwd</b> <i>encrypt-pwd</i></pre> <p><i>authPriv</i>: Configure the security level as authPriv. For this level, an authentication algorithm and a privacy algorithm are applied to check and encrypt packets.</p> <p><i>DES</i>: Configure the privacy mode as DES. The switch will use the DES algorithm to encrypt the packets. By default, the Privacy Mode is none.</p> <p><i>encrypt-pwd</i>: Enter a privacy password with 1 to 16 characters excluding question mark and space. This password in the configuration file will be displayed in the symmetric encrypted form.</p> |

|        |   |
|--------|---|
| Step 3 | <b>show snmp-server user</b><br>Displays the information of SNMP users.                   |
| Step 4 | <b>end</b><br>Return to Privileged EXEC Mode.   |
| Step 5 | <b>copy running-config startup-config</b><br>Save the settings in the configuration file. |

The following example shows how to create a remote SNMP user named admin and add it to group nms1. The security settings are as *Table 2-1*:

Table 2-1 Security Settings for the User

| Parameter               | Value |
|-------------------------|-------|
| Security Level          | v3    |
| Authentication Mode     | SHA   |
| Authentication Password | 1234  |
| Privacy Mode            | DES   |
| Privacy Password        | 5678  |

### Switch#configure

```
Switch(config)#snmp-server user admin remote nms1 smode v3 slev authPriv cmode
SHA cpwd 1234 emode DES epwd 5678
```

### Switch(config)#show snmp-server user

```
No. U-Name  U-Type  G-Name  S-Mode  S-Lev  A-Mode  P-Mode
--- -----  -----  -----  -----  -----  -----
1  admin    remote  nms1    v3      authPriv  SHA    DES
```

### Switch(config)#end

### Switch#copy running-config startup-config

# 3 Notification Configurations

With Notification enabled, the switch can send notifications to the NMS about important events relating to the device's operation. This facilitates the monitoring and management of the NMS.

To configure SNMP notification, follow these steps:

- 1) Configure the information of NMS hosts.
- 2) Enable SNMP traps.

## Configuration Guidelines

To guarantee the communication between the switch and the NMS, ensure the switch and the NMS can reach one another.

## 3.1 Using the GUI

### 3.1.1 Configuring the Information of NMS Hosts

Choose the menu **MAINTENANCE > SNMP > Notification > Notification Config** and click  **Add** to load the following page.

Figure 3-1 Adding an NMS Host

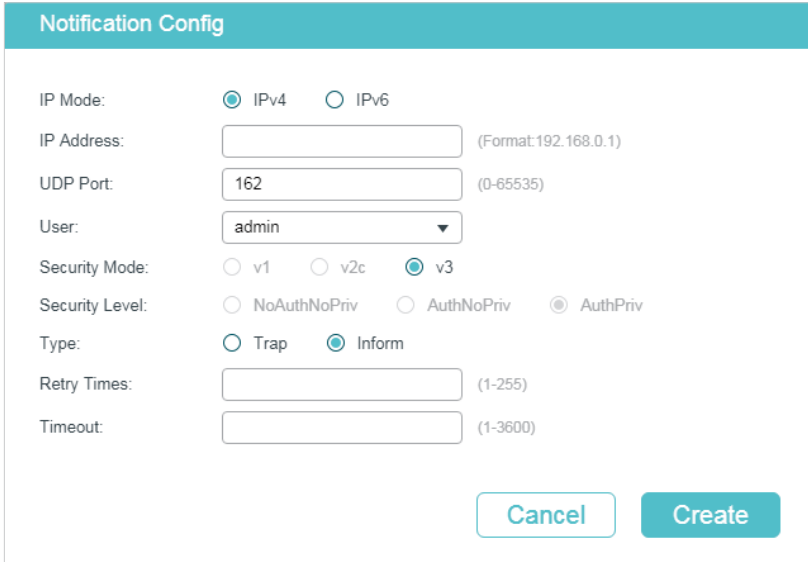

**Notification Config**

IP Mode:  IPv4  IPv6

IP Address:  (Format:192.168.0.1)

UDP Port:  (0-65535)

User:

Security Mode:  v1  v2c  v3

Security Level:  NoAuthNoPriv  AuthNoPriv  AuthPriv

Type:  Trap  Inform

Retry Times:  (1-255)

Timeout:  (1-3600)

Follow these steps to add an NMS host:

- 1) Choose the IP mode according to the network environment, and specify the IP address of the NMS host and the UDP port that receives notifications.

|            |  |
|------------|--|
| IP Mode    | Choose an IP mode for the NMS host.  |
| IP Address | If you set IP Mode as IPv4, specify an IPv4 address for the NMS host.<br>If you set IP Mode as IPv6, specify an IPv6 address for the NMS host.   |
| UDP Port   | Specify a UDP port on the NMS host to receive notifications. For security, we recommend that you change the port number under the condition that communications on other UDP ports are not affected. |

- 2) Specify the user name or community name used by the NMS host, and configure the security model and security level based on the user or community.

|                |   |
|----------------|---|
| User           | Choose the user name or community name used by the NMS host.  |
| Security Model | If a community name (created for SNMPv1/v2c) is selected in User, specify the security model as v1 or v2c. If a user name (created for SNMPv3) is selected in User, here displays the security model as v3.<br><br><i>Note:</i> The NMS host should use the corresponding SNMP version. |
| Security Level | If Security model is v3, here displays the security level of the user.  |

- 3) Choose a notification type based on the SNMP version. If you choose the Inform type, you need to set retry times and timeout interval.

|         |  |
|---------|--|
| Type    | Choose a notification type for the NMS host. For SNMPv1, the supported type is Trap. For SNMPv2c and SNMPv3, you can configure the type as Trap or Inform.<br><br><b>Trap:</b> The switch will send Trap messages to the NMS host when certain events occur. When the NMS host receives a Trap message, it will not send a response to the switch. Thus the switch cannot tell whether a message is received or not, and the messages that are not received will not be resent.<br><br><b>Inform:</b> The switch will send Inform messages to the NMS host when certain events occur. When the NMS host receives an Inform message, it sends a response to the switch. If the switch does not receive any response within the timeout interval, it will resend the Inform message. Therefore, Inform is more reliable than Trap. |
| Retry   | Set the retry times for Informs. The switch will resend the Inform message if it does not receive any response from the NMS host within the timeout interval. It will stop sending Inform messages when the retry time reaches the limit.  |
| Timeout | Set the time that the switch waits for a response from the NMS host after sending an inform message.   |

- 4) Click **Create**.

### 3.1.2 Enabling SNMP Traps

Choose the menu **MAINTENANCE > SNMP > Notification > Trap Config** to load the following page.

Figure 3-2 Enabling SNMP Traps

SNMP Traps

|   |   |   |
|---|---|---|
| <input checked="" type="checkbox"/> SNMP Authentication | <input checked="" type="checkbox"/> Coldstart | <input checked="" type="checkbox"/> Warmstart |
| <input checked="" type="checkbox"/> Link Status         | <input type="checkbox"/> CPU Utilization      | <input type="checkbox"/> Memory Utilization   |
| <input type="checkbox"/> Flash Operation                | <input type="checkbox"/> VLAN Create/Delete   | <input type="checkbox"/> IP Change            |
| <input type="checkbox"/> Storm Control                  | <input type="checkbox"/> Rate Limit           | <input type="checkbox"/> LLDP                 |
| <input type="checkbox"/> Loopback Detection             | <input type="checkbox"/> Spanning Tree        | <input type="checkbox"/> PoE                  |
| <input type="checkbox"/> IP-MAC Binding                 | <input type="checkbox"/> IP Duplicate         | <input type="checkbox"/> DHCP Filter          |
| <input type="checkbox"/> ACL Counter                    |   |   |

Apply

Follow these steps to enable some or all of the supported traps:

- 1) Select the traps to be enabled according to your needs. With a trap enabled, the switch will send the corresponding trap message to the NMS when the trap is triggered.

|                            |  |
|----------------------------|--|
| <b>SNMP Authentication</b> | Triggered when a received SNMP request fails the authentication.   |
| <b>Coldstart</b>           | Indicates that the SNMP entity is reinitializing itself such that its configurations may be changed. The trap can be triggered when you reboot the switch.   |
| <b>Warmstart</b>           | Indicates that the SNMP entity is reinitializing itself with its configurations unchanged. For a switch running SNMP, the trap can be triggered if you disable and then enable SNMP without changing any parameters.   |
| <b>Link Status</b>         | <p>Enable or disable Link Status Trap globally. The trap includes the following two sub-traps:</p> <p><b>Linkup Trap:</b> Indicates that a port status changes from linkdown to linkup.</p> <p><b>Linkdown Trap:</b> Indicates that a port status changes from linkup to linkdown.</p> <p>Link Status Trap can be triggered when it is enabled both globally and on the port, and you connect a new device to the port or disconnect a device from the port.</p> <p>To enable the trap on a port, run the command <b>snmp-server traps link-status</b> in Interface Configuration Mode of the port. To disable it, run the corresponding no command.</p> <p>By default, the trap is enabled both globally and on all ports, which means that link status changes on any ports will trigger the trap. If you do not want to receive notification messages about some specific ports, disable the trap on those ports.</p> |



|                    |   |
|--------------------|---|
| CPU Utilization    | Triggered when the CPU utilization exceeds 80%.   |
| Memory Utilization | Triggered when the memory utilization exceeds 80%.  |
| Flash Operation    | Triggered when flash is modified during operations such as backup, reset, firmware upgrade, and configuration import.   |
| VLAN Create/Delete | Triggered when certain VLANs are created or deleted successfully.   |
| IP Change          | Monitors the changes of interfaces' IP addresses. The trap can be triggered when the IP address of any interface is changed.  |
| Storm Control      | Monitors whether the storm rate has reached the limit that you have set. The trap can be triggered when the Storm Control feature is enabled and broadcast/multicast/unknown-unicast frames are sent to the port with a rate higher than what you have set.   |
| Rate Limit         | Monitors whether the bandwidth has reached the limit you have set. The trap can be triggered when the Rate Limit feature is enabled and packets are sent to the port with a rate higher than what you have set.   |
| LLDP               | <p>The trap includes the following sub-traps:</p> <p><b>LLDP RemTablesChange:</b> Indicates that the switch senses an LLDP topology change. The trap can be triggered when adding or removing a remote device, and when the information of some remote devices is aged out or cannot be stored into the switch because of insufficient resources. This trap can be used by an NMS to trigger LLDP remote systems table maintenance polls.</p> <p><b>LLDP TopologyChange:</b> Indicates that the switch senses an LLDP-MED topology change (the topology change of media endpoints). The trap can be triggered when adding or removing a media endpoint that supports LLDP, such as an IP Phone. An LLDP Remtableschange trap will be also triggered every time LLDP Topologychange trap is triggered.</p> |
| Loopback Detection | Triggered when the Loopback Detection feature is enabled and a loopback is detected or cleared.   |
| Spanning Tree      | Indicates spanning tree changes. The trap can be triggered in the following situations: a port changes from non-forwarding state to forwarding state or the other way round; a port receives a TCN (Topology Change Notification) BPDU or a Configuration BPDU with the TC (Topology Change) bit set.   |

|                |  |
|----------------|--|
| PoE            | <p>Only for products that support PoE. The trap includes the following sub-traps:</p> <p><b>Over-max-pwr-budget:</b> Triggered when the total power required by the connected PDs exceeds the maximum power the PoE switch can supply.</p> <p><b>Port-pwr-change:</b> Triggered when a port starts to supply power or stops supplying power.</p> <p><b>Port-pwr-deny:</b> Triggered when the switch powers off PDs on low-priority PoE ports. The switch powers off them to ensure stable running of the other PDs when the total power required by the connected PDs exceeds the system power limit.</p> <p><b>Port-pwr-over-30w:</b> Triggered when the power required by the connected PD exceeds 30 watts.</p> <p><b>Port-pwr-overload:</b> Triggered when the power required by the connected PD exceeds the maximum power the port can supply.</p> <p><b>Port-short-circuit:</b> Triggered when a short circuit is detected on a port.</p> <p><b>Thermal-shutdown:</b> Triggered when the PSE chip overheats. The switch will stop supplying power in this case.</p> |
| IP-MAC Binding | Triggered in the following two situations: the ARP Inspection feature is enabled and the switch receives an illegal ARP packet; or the IPv4 Source Guard feature is enabled and the switch receives an illegal IP packet.  |
| IP Duplicate   | Triggered when the switch detects an IP conflict.  |
| DHCP Filter    | Triggered when the DHCPv4 Filter feature is enabled and the switch receives DHCP packets from an illegal DHCP server.  |
| ACL Counter    | Monitors matched ACL information, including the matched ACL ID, rule ID and the number of the matched packets. With both this trap and the Logging feature in the ACL rule settings enabled, the switch will check the matched ACL information every five minutes and send SNMP traps if there is any updated information.   |

2) Click **Apply**.

## 3.2 Using the CLI

### 3.2.1 Configuring the NMS Host

Configure parameters of the NMS host and packet handling mechanism.

|        |   |
|--------|---|
| Step 1 | <p><b>configure</b></p> <p>Enter Global Configuration Mode.</p> |
|--------|---|

Step 2

**snmp-server host** *ip udp-port user-name* [**smode** { v1 | v2c | v3 }] [**slev** {noAuthNoPriv | authNoPriv | authPriv }] [**type** { trap | inform}] [**retries** *retries*] [**timeout** *timeout*]

Configure parameters of the NMS host and packet handling mechanism.

*ip*: Specify the IP address of the NMS host in IPv4 or IPv6. Make sure the NMS host and the switch can reach each other.

*udp-port*: Specify a UDP port on the NMS host to receive notifications. The default is port 162. For communication security, we recommend that you change the port number under the condition that communications on other UDP ports are not affected.

*user-name*: Enter the name used by the NMS host. When the NMS host uses SNMPv1 or SNMPv2c, enter the Community Name; when the NMS host uses SNMPv3, enter the User Name of the SNMP Group.

**v1 | v2c | v3**: Choose the security model used by the user from the following: SNMPv1, SNMPv2c, SNMPv3. The NMS host should use the corresponding SNMP version.

**noAuthNoPriv | authNoPriv | authPriv**: For SNMPv3 groups, choose a security level from noAuthNoPriv (no authorization and no encryption), authNoPriv (authorization and no encryption), authPriv (authorization and encryption). The default is noAuthNoPriv. Note that if you have chosen v1 or v2c as the security model, the security level cannot be configured.

**trap | inform**: Choose a notification type for the NMS host. For SNMPv1, the supported type is Trap. For SNMPv2c and SNMPv3, you can configure the type as Trap or Inform.

**Trap**: The switch will send Trap messages to the NMS host when certain events occur. When the NMS host receives a Trap message, it will not send a response to the switch. Thus the switch cannot tell whether a message is received or not, and the messages that are not received will not be resent.

**Inform**: The switch will send Inform messages to the NMS host when certain events occur. When the NMS host receives an Inform message, it sends a response to the switch. If the switch does not receive any response within the timeout interval, it will resend the Inform message. Therefore, Inform is more reliable than Trap.

*retries*: Set the retry times for Inform messages. The range is between 1 to 255 and the default is 3. The switch will resend the Inform message if it does not receive any response from the NMS host within the timeout interval. And it will stop sending Inform message when the retry times reaches the limit.

*timeout*: Set the time that the switch waits for a response. Valid values are from 1 to 3600 seconds; the default is 100 seconds. The switch will resend the Inform message if it does not receive a response from the NMS host within the timeout interval.

Step 3

**show snmp-server host**

Verify the information of the host.

Step 4

**end**

Return to Privileged EXEC Mode.

Step 5

**copy running-config startup-config**

Save the settings in the configuration file.

The following example shows how to configure an NMS host with the parameters shown in *Table 3-1*.

Table 3-1 Parameters for the NMS Hosts

| Parameter         | Value        |
|-------------------|--------------|
| IP Address        | 172.16.1.222 |
| UDP Port          | 162          |
| User Name         | admin        |
| Security Model    | v3           |
| Security Level    | authPriv     |
| Notification Type | Inform       |
| Retry Times       | 3            |
| Timeout Interval  | 100 seconds  |

### Switch#configure

```
Switch(config)#snmp-server host 172.16.1.222 162 admin smode v3 slev authPriv type
inform retries 3 timeout 100
```

### Switch(config)#show snmp-server host

| No. | Des-IP       | UDP   | Name  | SecMode | SecLev   | Type   | Retry | Timeout |
|-----|--------------|-------|-------|---------|----------|--------|-------|---------|
| --- | -----        | ----- | ----  | -----   | -----    | ----   | ----- | -----   |
| 1   | 172.16.1.222 | 162   | admin | v3      | authPriv | inform | 3     | 100     |

### Switch(config)#end

### Switch#copy running-config startup-config

## 3.2.2 Enabling SNMP Traps

The switch supports many types of SNMP traps, like SNMP standard traps, ACL traps, and VLAN traps, and the corresponding commands are different. With a trap enabled, the switch will send the corresponding trap message to the NMS when the trap is triggered. Follow these steps to enable the traps according to your needs.

### ■ Enabling the SNMP Standard Traps Globally

- 
- Step 1      **configure**  
Enter Global Configuration Mode.
-

---

|        |   |
|--------|---|
| Step 2 | <p><b>snmp-server traps snmp [ linkup   linkdown   warmstart   coldstart   auth-failure ]</b></p> <p>Enable the corresponding SNMP standard traps. The command without any parameter enables all SNMP standard traps. By default, all SNMP standard traps are enabled.</p> <p><b>linkup   linkdown:</b> Enable Linkup Trap and Linkdown Trap globally.</p> <p>Linkup Trap indicates that a port status changes from linkdown to linkup. The trap can be triggered when you connect a new device to the port, and the trap is enabled both globally and on the port.</p> <p>Linkdown Trap indicates that a port status changes from linkup to linkdown. The trap can be triggered when you disconnect a device from the port, and the trap is enabled both globally and on the port.</p> <p>To enable Linkup Trap and Linkdown Trap on a port, run the command <b>snmp-server traps link-status</b> in Interface Configuration Mode of the port. To disable them, run the corresponding no command.</p> <p>By default, the traps are enabled both globally and on all ports, which means that the traps will be triggered when a device is connected to or disconnected from any port of the switch. If you do not want to receive notification messages about some specific ports, disable the traps on those ports.</p> <p><b>warmstart:</b> Indicates that the SNMP entity is reinitializing itself with its configurations unchanged. For a switch running SNMP, the trap can be triggered if you disable and then enable SNMP without changing any parameters.</p> <p><b>coldstart:</b> Indicates that the SNMP entity is reinitializing itself such that its configurations may be changed. The trap can be triggered when you reboot the switch.</p> <p><b>auth-failure:</b> Triggered when a received SNMP request fails the authentication.</p> |
|--------|---|

---

|        |  |
|--------|--|
| Step 3 | <p><b>end</b></p> <p>Return to Privileged EXEC Mode.</p> |
|--------|--|

---

|        |  |
|--------|--|
| Step 4 | <p><b>copy running-config startup-config</b></p> <p>Save the settings in the configuration file.</p> |
|--------|--|

---

The following example shows how to configure the switch to send linkup traps:

```

Switch#configure
Switch(config)#snmp-server traps snmp linkup
Switch(config)#end
Switch#copy running-config startup-config

```

#### ■ Enabling the SNMP Extended Traps Globally

|        |   |
|--------|---|
| Step 1 | <p><b>configure</b></p> <p>Enter Global Configuration Mode.</p> |
|--------|---|

---

---

|        |  |
|--------|--|
| Step 2 | <p><b>snmp-server traps</b> { rate-limit   cpu   flash   lldp remtableschange   lldp topologychange   loopback-detection   storm-control   spanning-tree   memory }</p> <p>Enable the corresponding SNMP extended traps. By default, all SNMP extended traps are disabled.</p> <p><b>rate-limit:</b> Monitors whether the bandwidth has reached the limit you have set. The trap can be triggered when the Rate Limit feature is enabled and packets are sent to the port with a rate higher than what you have set.</p> <p><b>cpu:</b> Monitors the load status of the switch CPU. The trap can be triggered when the utilization rate of the CPU exceeds 80%.</p> <p><b>flash:</b> Triggered when flash is modified during operations such as backup, reset, firmware upgrade, and configuration import.</p> <p><b>lldp remtableschange:</b> Indicates that the switch senses an LLDP topology change. The trap can be triggered when adding or removing a remote device, and when the information of some remote devices is aged out or cannot be stored into the switch because of insufficient resources. This trap can be used by an NMS to trigger LLDP remote systems table maintenance polls.</p> <p><b>lldp topologychange:</b> Indicates that the switch senses an LLDP-MED topology change (the topology change of media endpoints). The trap can be triggered when adding or removing a media endpoint that supports LLDP, such as an IP Phone. An LLDP Remtableschange trap will be also triggered every time LLDP Topologychange trap is triggered.</p> <p><b>loopback-detection:</b> Triggered when the Loopback Detection feature is enabled and a loopback is detected or cleared.</p> <p><b>storm-control:</b> Monitors whether the storm rate has reached the limit that you have set. The trap can be triggered when the Storm Control feature is enabled and broadcast/multicast/unknown-unicast frames are sent to the port with a rate higher than what you have set.</p> <p><b>spanning-tree:</b> Indicates spanning tree changes. The trap can be triggered in the following situations: a port changes from non-forwarding state to forwarding state or the other way round; a port receives a TCN (Topology Change Notification) BPDU or a Configuration BPDU with the TC (Topology Change) bit set.</p> <p><b>memory:</b> Monitors the load status of the switch memory. The trap can be triggered when the memory utilization exceeds 80%.</p> |
| Step 3 | <p><b>end</b></p> <p>Return to Privileged EXEC Mode.</p>   |
| Step 4 | <p><b>copy running-config startup-config</b></p> <p>Save the settings in the configuration file.</p>   |

---

The following example shows how to configure the switch to enable bandwidth-control traps:

**Switch#configure**

**Switch(config)#snmp-server traps** bandwidth-control

**Switch(config)#end**

**Switch#copy running-config startup-config**

## ■ Enabling the VLAN Traps Globally

|        |   |
|--------|---|
| Step 1 | <b>configure</b><br>Enter Global Configuration Mode.  |
| Step 2 | <b>snmp-server traps vlan [ create   delete ]</b><br>Enable the corresponding VLAN traps. The command without parameter enables all SNMP VLAN traps. By default, all VLAN traps are disabled.<br><b>create:</b> Triggered when certain VLANs are created successfully.<br><b>delete:</b> Triggered when certain VLANs are deleted successfully. |
| Step 3 | <b>end</b><br>Return to Privileged EXEC Mode.   |
| Step 4 | <b>copy running-config startup-config</b><br>Save the settings in the configuration file.   |

The following example shows how to configure the switch to enable all the SNMP VLAN traps:

```
Switch#configure
```

```
Switch(config)#snmp-server traps vlan
```

```
Switch(config)#end
```

```
Switch#copy running-config startup-config
```

## ■ Enabling the SNMP Security Traps Globally

|        |  |
|--------|--|
| Step 1 | <b>configure</b><br>Enter Global Configuration Mode.   |
| Step 2 | <b>snmp-server traps security { dhcp-filter   ip-mac-binding }</b><br>Enable the corresponding security traps. By default, all security traps are disabled.<br><b>dhcp-filter:</b> Triggered when the DHCPv4 Filter feature is enabled and the switch receives DHCP packets from an illegal DHCP server.<br><b>ip-mac-binding:</b> Triggered when the ARP Inspection feature is enabled and the switch receives an illegal ARP packet, or the IPv4 Source Guard feature is enabled and the switch receives an illegal IP packet. |
| Step 3 | <b>end</b><br>Return to Privileged EXEC Mode.  |
| Step 4 | <b>copy running-config startup-config</b><br>Save the settings in the configuration file.  |

The following example shows how to configure the switch to enable DHCP filter trap:

```
Switch#configure
```

```
Switch(config)#snmp-server traps security dhcp-filter
```

```
Switch(config)#end
```

```
Switch#copy running-config startup-config
```

#### ■ Enabling the ACL Trap Globally

|        |  |
|--------|--|
| Step 1 | <b>configure</b><br>Enter Global Configuration Mode.   |
| Step 2 | <b>snmp-server traps security acl</b><br>Enable the ACL trap. By default, it is disabled.<br><br>The trap monitors matched ACL information, including the matched ACL ID, rule ID and the number of the matched packets. With both this trap and the Logging feature in the ACL rule settings enabled, the switch will check the matched ACL information every five minutes and send SNMP traps if there is any updated information. |
| Step 3 | <b>end</b><br>Return to Privileged EXEC Mode.  |
| Step 4 | <b>copy running-config startup-config</b><br>Save the settings in the configuration file.  |

The following example shows how to configure the switch to enable ACL trap:

```
Switch#configure
```

```
Switch(config)#snmp-server traps acl
```

```
Switch(config)#end
```

```
Switch#copy running-config startup-config
```

#### ■ Enabling the IP Traps Globally

|        |   |
|--------|---|
| Step 1 | <b>configure</b><br>Enter Global Configuration Mode.  |
| Step 2 | <b>snmp-server traps ip { change   duplicate }</b><br>Enable the IP traps. By default, all IP traps are disabled.<br><br><b>change:</b> Monitors the changes of interfaces' IP addresses. The trap can be triggered when the IP address of any interface is changed.<br><br><b>duplicate:</b> Triggered when the switch detects an IP conflict. |



- 
- |        |   |
|--------|---|
| Step 3 | <b>end</b><br>Return to Privileged EXEC Mode. |
|--------|---|
- 
- |        |   |
|--------|---|
| Step 4 | <b>copy running-config startup-config</b><br>Save the settings in the configuration file. |
|--------|---|
- 

The following example shows how to configure the switch to enable IP-Change trap:

**Switch#configure**

**Switch(config)#snmp-server traps ip change**

**Switch(config)#end**

**Switch#copy running-config startup-config**

#### ■ Enabling the SNMP PoE Traps Globally

##### Note:

Only T1500-28PCT, TL-SG2210MP and TL-SG2210P support PoE traps.

- 
- |        |  |
|--------|--|
| Step 1 | <b>configure</b><br>Enter Global Configuration Mode. |
|--------|--|
- 
- |        |  |
|--------|--|
| Step 2 | <p><b>snmp-server traps power</b> [over-max-pwr-budget   port-pwr-change   port-pwr-deny   port-pwr-over-30w   port-pwr-overload   port-short-circuit   thermal-shutdown ]</p> <p>Enable the PoE traps. The command without any parameter enables all PoE traps. By default, all PoE traps are disabled.</p> <p><b>over-max-pwr-budget:</b> Triggered when the total power required by the connected PDs exceeds the maximum power the PoE switch can supply.</p> <p><b>port-pwr-change:</b> Triggered when the total power required by the connected PDs exceeds the maximum power the PoE switch can supply.</p> <p><b>port-pwr-deny:</b> Triggered when the switch powers off PDs on low-priority PoE ports. The switch powers off them to ensure stable running of the other PDs when the total power required by the connected PDs exceeds the system power limit.</p> <p><b>port-pwr-over-30w:</b> Triggered when the power required by the connected PD exceeds 30 watts.</p> <p><b>port-pwr-overload:</b> Triggered when the power required by the connected PD exceeds the maximum power the port can supply.</p> <p><b>port-short-circuit:</b> Triggered when a short circuit is detected on a port.</p> <p><b>thermal-shutdown:</b> Triggered when the PSE chip overheats. The switch will stop supplying power in this case.</p> |
|--------|--|
- 
- |        |   |
|--------|---|
| Step 3 | <b>end</b><br>Return to Privileged EXEC Mode. |
|--------|---|
-

- 
- Step 4      **copy running-config startup-config**  
Save the settings in the configuration file.
- 

The following example shows how to configure the switch to enable all PoE traps:

**Switch#configure**

**Switch(config)#snmp-server traps power**

**Switch(config)#end**

**Switch#copy running-config startup-config**

#### ■ Enabling the Link-status Trap for Ports

- 
- Step 1      **configure**  
Enter Global Configuration Mode.
- 

- Step 2      **interface {fastEthernet *port* | range fastEthernet *port-list* | gigabitEthernet *port* | range gigabitEthernet *port-list* | ten-gigabitEthernet *port* | range ten-gigabitEthernet *port-list* }**  
Configure notification traps on the specified ports.

*port/port-list*: The number or the list of the Ethernet ports that you desire to configure notification traps. To configure multiple ports, enter a list of port numbers separated by commas, or use a hyphen to indicate a range of port numbers. For example, 1-3, 5 indicates port 1, 2, 3, 5.

- 
- Step 3      **snmp-server traps link-status**  
Enable Link Status Trap for the port. By default, it is enabled. Link Status Trap (including Linkup Trap and Linkdown Trap) can be triggered when the link status of a port changes, and the trap is enabled both globally and on the port.  
  
To enable Linkup Trap and Linkdown Trap globally, run the command **snmp-server traps snmp [ linkup | linkdown ]** in Global Configuration Mode. To disable it, run the corresponding no command.
- 

- Step 4      **end**  
Return to Privileged EXEC Mode.
- 

- Step 5      **copy running-config startup-config**  
Save the settings in the configuration file.
- 

The following example shows how to configure the switch to enable link-status trap:

**Switch#configure**

**Switch(config)#interface gigabitEthernet 1/0/1**

**Switch(config-if)#snmp-server traps link-status**

**Switch(config-if)#end**

**Switch#copy running-config startup-config**

# 4 RMON

RMON (Remote Network Monitoring) together with the SNMP system allows the network manager to monitor remote network devices efficiently. RMON reduces traffic flow between the NMS and managed devices, which is convenient to manage large networks.

RMON includes two parts: the NMS and the Agents running on every network device. The NMS is usually a host that runs the management software to manage Agents of network devices. The Agent is usually a switch or router that collects traffic statistics (such as the total number of packets on a network segment during a certain time period, or total number of correct packets that are sent to a host). Based on SNMP protocol, the NMS collects network data by communicating with Agents. However, the NMS cannot obtain every datum of RMON MIB because the device resources are limited. Generally, the NMS can only get information of the following four groups: Statistics, History, Event and Alarm.

- **Statistics:** Collects Ethernet statistics (like the total received bytes, the total number of broadcast packets, and the total number of packets with specified size) on an interface.
- **History:** Collects a history group of statistics on Ethernet ports for a specified polling interval.
- **Event:** Specifies the action to be taken when an event is triggered by an alarm. The action can be to generate a log entry or an SNMP trap.
- **Alarm:** Monitors a specific MIB object for a specified interval, and triggers an event at a specified value (rising threshold or falling threshold).

# 5 RMON Configurations

With RMON configurations, you can:

- Configuring the Statistics group.
- Configuring the History group.
- Configuring the Event group.
- Configuring the Alarm group.

## Configuration Guidelines

To ensure that the NMS receives notifications normally, complete configurations of SNMP and SNMP Notification before configuring RMON.

## 5.1 Using the GUI

### 5.1.1 Configuring the Statistics Group

Choose the menu **MAINTENANCE > SNMP > RMON > Statistics** and click  Add to load the following page.

Figure 5-1 Creating a Statistics Entry

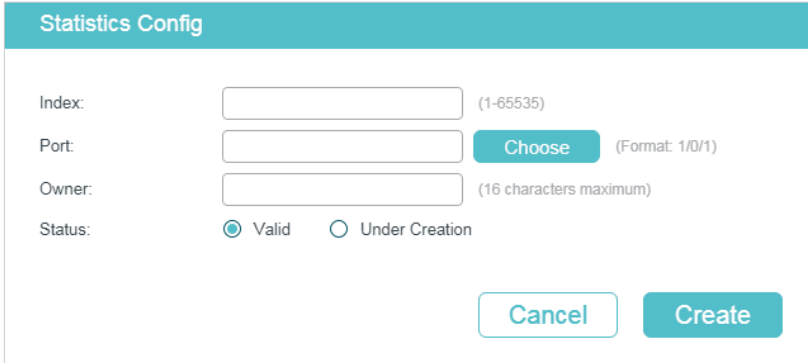

Follow these steps to configure the Statistics group:

- 1) Specify the entry index, the port to be monitored, and the owner name of the entry. Set the entry as Valid or Under Creation.

|       |   |
|-------|---|
| Index | Enter the index of the entry.   |
| Port  | Specify an Ethernet port to be monitored in the entry. You can click <b>Choose</b> to choose a port from the list or manually enter the port number, for example, 1/0/1 in the input box. |
| Owner | Enter the owner name of the entry with 1 to 16 characters.  |

**Status** Set the entry as Valid or Under Creation. By default, it is Valid. The switch starts to collect Ethernet statistics for a Statistics entry since the entry status is configured as valid.

**Valid:** The entry is created and valid.

**Under Creation:** The entry is created but invalid.

2) Click **Create**.

## 5.1.2 Configuring History Group

Choose the menu **MAINTENANCE > SNMP > RMON > History** to load the following page.

Figure 5-2 Configuring the History Entry

| History Control Config              |       |       |                    |                 |                                       |                                      |
|-------------------------------------|-------|-------|--------------------|-----------------|---------------------------------------|--------------------------------------|
| <input type="checkbox"/>            | Index | Port  | Interval (seconds) | Maximum Buckets | Owner                                 | Status                               |
| <input checked="" type="checkbox"/> | 1     | 1/0/1 | 1800               | 50              | monitor                               | Disabled                             |
| <input type="checkbox"/>            | 2     | 1/0/1 | 1800               | 50              | monitor                               | Disabled                             |
| <input type="checkbox"/>            | 3     | 1/0/1 | 1800               | 50              | monitor                               | Disabled                             |
| <input type="checkbox"/>            | 4     | 1/0/1 | 1800               | 50              | monitor                               | Disabled                             |
| <input type="checkbox"/>            | 5     | 1/0/1 | 1800               | 50              | monitor                               | Disabled                             |
| <input type="checkbox"/>            | 6     | 1/0/1 | 1800               | 50              | monitor                               | Disabled                             |
| <input type="checkbox"/>            | 7     | 1/0/1 | 1800               | 50              | monitor                               | Disabled                             |
| <input type="checkbox"/>            | 8     | 1/0/1 | 1800               | 50              | monitor                               | Disabled                             |
| <input type="checkbox"/>            | 9     | 1/0/1 | 1800               | 50              | monitor                               | Disabled                             |
| <input type="checkbox"/>            | 10    | 1/0/1 | 1800               | 50              | monitor                               | Disabled                             |
| Total: 12                           |       |       | 1 entry selected.  |                 | <input type="button" value="Cancel"/> | <input type="button" value="Apply"/> |

Follow these steps to configure the History group:

1) Select a History entry, and specify a port to be monitored.

**Index** Displays the index of History entries. The switch supports up to 12 History entries.

**Port** Specify a port to be monitored.

2) Set the sample interval and the maximum buckets of History entries.

**Interval (seconds)** Specify the number of seconds in each polling cycle. Valid values are from 10 to 3600 seconds. Every history entry has its own timer. For the monitored port, the switch samples packet information and generates a record in every interval.

**Maximum Buckets** Set the maximum number of records for the History entry. Valid values are from 10 to 130. When the number of records exceeds the limit, the earliest record will be overwritten.

- 3) Enter the owner name, and set the status of the entry. Click **Apply**.

|               |  |
|---------------|--|
| <b>Owner</b>  | Enter the owner name of the entry with 1 to 16 characters. By default, it is monitor.  |
| <b>Status</b> | Enable or disable the entry. By default, it is disabled.<br><br><b>Enable:</b> The entry is enabled.<br><br><b>Disable:</b> The entry is disabled. |

 **Note:**

To change the parameters of a History entry, enable the entry at the same time; otherwise, the change cannot take effect.

### 5.1.3 Configuring Event Group

Choose the menu **MAINTENANCE > SNMP > RMON > Event** to load the following page.

Figure 5-3 Configuring the Event Entry

| <input type="checkbox"/>            | Index | User   | Description | Action Mode | Owner   | Status   |
|-------------------------------------|-------|--------|-------------|-------------|---------|----------|
| <input checked="" type="checkbox"/> | 1     | public |             | None        | monitor | Disabled |
| <input type="checkbox"/>            | 2     | public |             | None        | monitor | Disabled |
| <input type="checkbox"/>            | 3     | public |             | None        | monitor | Disabled |
| <input type="checkbox"/>            | 4     | public |             | None        | monitor | Disabled |
| <input type="checkbox"/>            | 5     | public |             | None        | monitor | Disabled |
| <input type="checkbox"/>            | 6     | public |             | None        | monitor | Disabled |
| <input type="checkbox"/>            | 7     | public |             | None        | monitor | Disabled |
| <input type="checkbox"/>            | 8     | public |             | None        | monitor | Disabled |
| <input type="checkbox"/>            | 9     | public |             | None        | monitor | Disabled |
| <input type="checkbox"/>            | 10    | public |             | None        | monitor | Disabled |

Total: 12      1 entry selected.     

Follow these steps to configure the Event group:

- 1) Choose an Event entry, and specify an SNMP User for the entry.

|              |  |
|--------------|--|
| <b>Index</b> | Displays the index of Event entries. The switch supports up to 12 Event entries.   |
| <b>User</b>  | Choose an SNMP user name or community name for the entry. Only the specified user can access the log messages or receive the notification messages related to the event. |

- 2) Set the description and action to be taken when the event is triggered.

|                    |  |
|--------------------|--|
| <b>Description</b> | Enter an brief description of this event to make it easier to be identified. |
|--------------------|--|

**Action Mode** Specify the action for the switch to take when the event is triggered.

**None:** No action.

**Log:** The switch records the event in the log, and the NMS should initiate requests to get notifications.

**Notify:** The switch sends notifications to the NMS.

**Log & Notify:** The switch records the event in the log and sends notifications to the NMS.

3) Enter the owner name, and set the status of the entry. Click **Apply**.

**Owner** Enter the owner name of the entry with 1 to 16 characters.

**Status** Enable or disable the entry.

**Enable:** The entry is enabled.

**Disable:** The entry is disabled.

## 5.1.4 Configuring Alarm Group

Before you begin, complete configurations of Statistics entries and Event entries, because the Alarm entries must be associated with Statistics and Event entries.

Choose the menu **MAINTENANCE > SNMP > RMON > Alarm** to load the following page.

Figure 5-4 Configuring the Alarm Entry

| <input type="checkbox"/>            | Index | Variable | Statistics | Sample Type | Rising Threshold | Rising Event | Falling Threshold | Falling Event |
|-------------------------------------|-------|----------|------------|-------------|------------------|--------------|-------------------|---------------|
| <input checked="" type="checkbox"/> | 1     | RecBytes | 0          | Absolute    | 100              | 0            | 100               | 0             |
| <input type="checkbox"/>            | 2     | RecBytes | 0          | Absolute    | 100              | 0            | 100               | 0             |
| <input type="checkbox"/>            | 3     | RecBytes | 0          | Absolute    | 100              | 0            | 100               | 0             |
| <input type="checkbox"/>            | 4     | RecBytes | 0          | Absolute    | 100              | 0            | 100               | 0             |
| <input type="checkbox"/>            | 5     | RecBytes | 0          | Absolute    | 100              | 0            | 100               | 0             |
| <input type="checkbox"/>            | 6     | RecBytes | 0          | Absolute    | 100              | 0            | 100               | 0             |
| <input type="checkbox"/>            | 7     | RecBytes | 0          | Absolute    | 100              | 0            | 100               | 0             |
| <input type="checkbox"/>            | 8     | RecBytes | 0          | Absolute    | 100              | 0            | 100               | 0             |
| <input type="checkbox"/>            | 9     | RecBytes | 0          | Absolute    | 100              | 0            | 100               | 0             |
| <input type="checkbox"/>            | 10    | RecBytes | 0          | Absolute    | 100              | 0            | 100               | 0             |

Total: 12      1 entry selected.

Follow these steps to configure the Alarm group:

- 1) Select an alarm entry, choose a variable to be monitored, and associate the entry with a statistics entry.

|                   |   |
|-------------------|---|
| <b>Index</b>      | Displays the index of Alarm entries. The switch supports up to 12 Alarm entries.  |
| <b>Variable</b>   | <p>Set the alarm variable to be monitored. The switch will monitor the specified variable in sample intervals and act in the set way when the alarm is triggered.</p> <p><b>RecBytes:</b> Total number of received bytes.</p> <p><b>RecPackets:</b> Total number of received packets.</p> <p><b>BPackets:</b> Total number of broadcast packets.</p> <p><b>MPackets:</b> Total number of multicast packets.</p> <p><b>CRC&amp;Align ERR:</b> Packets that contain FCS Error or Alignment Error, within a size of 64 to 1518 bytes.</p> <p><b>Undersize:</b> Packets that are smaller than 64 bytes.</p> <p><b>Oversize:</b> Packets that are larger than 1518 bytes.</p> <p><b>Jabbers:</b> Packets that are sent when port collisions occur.</p> <p><b>Collisions:</b> Collision times in the network segment.</p> <p><b>64, 65-127, 128-255, 256-511, 512-1023, 1024-1518:</b> Total number of packets of the specified size.</p> |
| <b>Statistics</b> | Associate the Alarm entry with a Statistics entry. Then the switch monitors the specified variable of the Statistics entry.   |

- 2) Set the sample type, the rising and falling threshold, the corresponding event entries, and the alarm type of the entry.

|                         |   |
|-------------------------|---|
| <b>Sample Type</b>      | <p>Specify the sampling method of the specified variable.</p> <p><b>Absolute:</b> Compare the sampling value against the preset threshold.</p> <p><b>Delta:</b> The switch obtains the difference between the sampling values of the current interval and the previous interval, and then compares the difference against the preset threshold.</p> |
| <b>Rising Threshold</b> | <p>Specify the rising threshold of the variable. Valid values are from 1 to 2147483647. When the sampling value or the difference value exceeds the threshold, the system will trigger the corresponding Rising Event.</p> <p><i>Note:</i> The rising threshold should be larger than the falling threshold.</p>                                    |
| <b>Rising Event</b>     | Specify the index of the Event entry that will be triggered when the sampling value or the difference value exceeds the preset threshold. The Event entry specified here should be enabled first.   |



|                   |  |
|-------------------|--|
| Falling Threshold | Set the falling threshold of the variable. Valid values are from 1 to 2147483647. When the sampling value or the difference value is below the threshold, the system will trigger the corresponding Falling Event.<br><br><i>Note:</i> The falling threshold should be less than the rising threshold.   |
| Falling Event     | Specify the index of the Event entry that will be triggered when the sampling value or the difference value is below the preset threshold. The Event entry specified here should be enabled first.   |
| Alarm Type        | Specify the alarm type for the entry.<br><br><b>Rising:</b> The alarm is triggered only when the sampling value or the difference value exceeds the rising threshold.<br><br><b>Falling:</b> The alarm is triggered only when the sampling value or the difference value is below the falling threshold.<br><br><b>All:</b> The alarm is triggered when the sampling value or the difference value exceeds the rising threshold or is below the falling threshold. |

3) Enter the owner name, and set the status of the entry. Click **Apply**.

|                    |  |
|--------------------|--|
| Interval (seconds) | Set the sampling interval. Valid values are from 10 to 3600 seconds.   |
| Owner              | Enter the owner name of the entry with 1 to 16 characters.   |
| Status             | Enable or disable the entry.<br><br><b>Enable:</b> The entry is enabled.<br><br><b>Disable:</b> The entry is disabled. |

## 5.2 Using the CLI

### 5.2.1 Configuring Statistics

|        |  |
|--------|--|
| Step 1 | <b>configure</b><br>Enter Global Configuration Mode. |
|--------|--|

---

Step 2      **rmon statistics** *index* **interface** { **fastEthernet** *port* | **gigabitEthernet** *port* | **ten-gigabitEthernet** *port* } [ **owner** *owner-name* ] [ **status** { **underCreation** | **valid** } ]

Configure RMON Statistic entries.

*index*: Specify the index of the Statistics entry, which ranges from 1 to 65535. To configure multiple indexes, enter a list of indexes separated by commas, or use a hyphen to indicate a range of indexes. For example, 1-3, 5 indicates 1, 2, 3, 5.

*port*: Specify the port to be bound to the entry.

*owner-name*: Enter the owner name of the entry with 1 to 16 characters. The default name is monitor.

**underCreation** | **valid**: Enter the status of the entry. UnderCreation indicates that the entry is created but invalid, while Valid indicates the entry is created and valid. By default, it is valid.

The switch starts to collect Ethernet statistics for a Statistics entry since the entry status is configured as valid.

---

Step 3      **show rmon statistics** [ *index* ]

Displays the statistics entries and their configurations.

*index*: Enter the index of statistics entry that you want to view. Valid values are from 1 to 65535. The command without any parameters displays all existing statistics entries.

---

Step 4      **end**

Return to Privileged EXEC Mode.

---

Step 5      **copy running-config startup-config**

Save the settings in the configuration file.

---

The following example shows how to create Statistics entries 1 and 2 on the switch to monitor port 1/0/1 and 1/0/2, respectively. The owner of the entries are both monitor and the status are both valid:

**Switch#configure**

**Switch(config)#rmon statistics 1 interface gigabitEthernet 1/0/1 owner monitor status valid**

**Switch(config)#rmon statistics 2 interface gigabitEthernet 1/0/2 owner monitor status valid**

**Switch(config)#show rmon statistics**

| Index | Port    | Owner   | State |
|-------|---------|---------|-------|
| ----- | ----    | -----   | ----- |
| 1     | Gi1/0/1 | monitor | valid |
| 2     | Gi1/0/2 | monitor | valid |

**Switch(config)#end**

**Switch#copy running-config startup-config****5.2.2 Configuring History**

|        |  |
|--------|--|
| Step 1 | <b>configure</b><br>Enter Global Configuration Mode.   |
| Step 2 | <p><b>rmon history</b> <i>index</i> <b>interface</b> { <b>fastEthernet</b> <i>port</i>   <b>gigabitEthernet</b> <i>port</i>   <b>ten-gigabitEthernet</b> <i>port</i> } [<b>interval</b> <i>seconds</i>] [<b>owner</b> <i>owner-name</i>] [<b>buckets</b> <i>number</i>]</p> <p>Configuring RMON History entries.</p> <p><i>index</i>: Specify the index of the History entry, which ranges from 1 to 12. To configure multiple indexes, enter a list of indexes separated by commas, or use a hyphen to indicate a range of indexes. For example, 1-3, 5 indicates 1, 2, 3, 5.</p> <p><i>port</i>: Specify the port to be bound to the entry.</p> <p><i>seconds</i>: Set the sample interval. The values are from 10 to 3600 seconds, and the default is 1800 seconds.</p> <p><i>owner-name</i>: Enter the owner name of the entry with 1 to 16 characters. The default name is monitor.</p> <p><i>number</i>: Set the maximum number of records for the history entry. When the number of records exceeds the limit, the earliest record will be overwritten. The values are from 10 to 130; the default is 50.</p> |
| Step 3 | <p><b>show rmon history</b> [<i>index</i>]</p> <p>Displays the specified History entry and related configurations. To show multiple entries, enter a list of indexes separated by commas, or use a hyphen to indicate a range of indexes. For example, 1-3, 5 indicates 1, 2, 3, 5.</p> <p><i>index</i>: Enter the index of History entry that you want to view. Valid values are from 1 to 12. The command without any parameters displays all existing statistics entries.</p>   |
| Step 4 | <b>end</b><br>Return to Privileged EXEC Mode.  |
| Step 5 | <b>copy running-config startup-config</b><br>Save the settings in the configuration file.  |

The following example shows how to create a History entry on the switch to monitor port 1/0/1. Set the sample interval as 100 seconds, maximum buckets as 50, and the owner as monitor:

**Switch#configure**

```
Switch(config)#rmon history 1 interface gigabitEthernet 1/0/1 interval 100 owner monitor buckets 50
```

**Switch(config)#show rmon history**

| Index | Port    | Interval | Buckets | Owner   | State  |
|-------|---------|----------|---------|---------|--------|
| 1     | Gi1/0/1 | 100      | 50      | monitor | Enable |

```
Switch(config)#end
```

```
Switch#copy running-config startup-config
```

## 5.2.3 Configuring Event

|        |  |
|--------|--|
| Step 1 | <p><b>configure</b></p> <p>Enter Global Configuration Mode.</p>  |
| Step 2 | <p><b>rmon event</b> <i>index</i> [ <b>user</b> <i>user-name</i> ] [ <b>description</b> <i>description</i> ] [ <b>type</b> { none   log   notify   log-notify } ] [ <b>owner</b> <i>owner-name</i> ]</p> <p>Configuring RMON Event entries.</p> <p><i>index</i>: Specify the index of the Event entry, which ranges from 1 to 12. To configure multiple indexes, enter a list of indexes separated by commas, or use a hyphen to indicate a range of indexes. For example, 1-3, 5 indicates 1, 2, 3, 5.</p> <p><i>user-name</i>: Enter the SNMP user name or community name of the entry. The name should be what you have set in SNMP previously. The default name is public.</p> <p><i>description</i>: Give a description to the entry with 1 to 16 characters. By default, the description is empty.</p> <p><b>none   log   notify   log-notify</b>: Specify the action type of the event; then the switch will take the specified action to deal with the event. By default, the type is none. None indicates the switch takes no action, log indicates the switch records the event only, notify indicates the switch sends notifications to the NMS only, and log-notify indicates the switch records the event and sends notifications to the NMS.</p> <p><i>owner-name</i>: Enter the owner name of the entry with 1 to 16 characters. The default name is monitor.</p> |
| Step 3 | <p><b>show rmon event</b> [ <i>index</i> ]</p> <p>Displays the specified Event entry and related configurations. To show multiple entries, enter a list of indexes separated by commas, or use a hyphen to indicate a range of indexes. For example, 1-3, 5 indicates 1, 2, 3, 5.</p> <p><i>index</i>: Enter the index of Event entry that you want to view. Valid values are from 1 to 12. The command without any parameters displays all existing statistics entries.</p>   |
| Step 4 | <p><b>end</b></p> <p>Return to Privileged EXEC Mode.</p>   |
| Step 5 | <p><b>copy running-config startup-config</b></p> <p>Save the settings in the configuration file.</p>   |

The following example shows how to create an Event entry on the switch. Set the user name as admin, the event type as Notify (set the switch to initiate notifications to the NMS), and the owner as monitor:

### Switch#configure

```
Switch(config)#rmon event 1 user admin description rising-notify type notify owner monitor
```

### Switch(config)#show rmon event

| Index | User  | Description   | Type   | Owner   | State  |
|-------|-------|---------------|--------|---------|--------|
| ----- | ----  | -----         | ----   | -----   | -----  |
| 1     | admin | rising-notify | Notify | monitor | Enable |

### Switch(config)#end

```
Switch#copy running-config startup-config
```

## 5.2.4 Configuring Alarm

Step 1

### configure

Enter Global Configuration Mode.

Step 2

```
rmon alarm index stats-index sindex [alarm-variable { revbyte | revpkt | bpkt | mpkt | crc-align | undersize | oversize | jabber | collision | 64 | 65-127 | 128-255 | 256-511 | 512-1023 | 1024-1518}] [s-type {absolute | delta}] [rising-threshold r-threshold] [rising-event-index r-event] [falling-threshold f-threshold] [falling-event-index f-event] [a-type {rise | fall | all}] [owner owner-name] [interval interval]
```

Configuring RMON alarm entries.

*index*: Specify the index of the Alarm entry, which ranges from 1 to 12. To configure multiple indexes, enter a list of indexes separated by commas, or use a hyphen to indicate a range of indexes. For example, 1-3, 5 indicates 1, 2, 3, 5.

*sindex*: Specify the index of the related Statistics entry, which ranges from 1 to 65535.

*revbyte | revpkt | bpkt | mpkt | crc-align | undersize | oversize | jabber | collision | 64 | 65-127 | 128-255 | 256-511 | 512-1023 | 1024-1518*: Choose an alarm variable to monitor. The switch will monitor the specified variable in sample intervals and act in the set way when the alarm is triggered. The default variable is revbyte.

*revbyte* means total number of received bytes; *revpkt* means total number of received packets; *bpkt* means total number of broadcast packets. *mpkt* means total number of multicast packets; *crc-align* means packets that contain FCS Error or Alignment Error, within a size of 64 to 1518 bytes; *undersize* means packets that are smaller than 64 bytes; *oversize* means packets that are larger than 1518 bytes; *jabber* means packets that are sent when port collisions occur; *collision* means the collision times in the network segment; *64 | 65-127 | 128-255 | 256-511 | 512-1023 | 1024-1518* means total number of packets of the specified size.

**absolute | delta:** Choose the sampling method of the specified variable. The default is absolute. In the absolute mode, the switch compares the sampling value against the preset threshold; in the delta mode, the switch obtains the difference between the sampling values of the current interval and the previous interval, and then compares the difference against the preset threshold.

**r-threshold:** Enter the rising threshold. Valid values are from 1 to 2147483647, and the default is 100. The rising threshold should be larger than the falling threshold.

**r-event:** Enter the index of the Event entry that will be triggered when the sampling value or the difference value exceeds the preset threshold. Valid values are from 1 to 12. The Event entry specified here should be enabled first.

**f-threshold:** Enter a falling threshold. Valid values are from 1 to 2147483647, and the default is 100. The falling threshold should be less than the rising threshold.

**f-event:** Enter the index of the Event entry that will be triggered when the sampling value or the difference value is below the preset threshold. Valid values are from 1 to 12. The Event entry specified here should be enabled first.

**rise | fall | all:** Choose an alarm type; the default is all. Rise indicates that the alarm is triggered only when the sampling value or difference value exceeds the rising threshold. Fall indicates that the alarm is triggered only when the sampling value or difference value is below the falling threshold. All indicates that the alarm is triggered when the sampling value or difference value either exceeds the rising threshold or is below the falling threshold.

**owner-name:** Enter the owner name of the entry using 1 to 16 characters. The default name is monitor.

**interval:** Set the sampling interval. The value ranges from 10 to 3600 seconds; the default is 1800 seconds.

---

Step 3      **show rmon alarm [index]**

Displays the specified alarm entry and related configurations. To show multiple entries, enter a list of indexes separated by commas, or use a hyphen to indicate a range of indexes. For example, 1-3, 5 indicates 1, 2, 3, 5.

**index:** Enter the index of Alarm entry that you want to view. Valid values are from 1 to 12. The command without any parameters displays all existing statistics entries.

---

Step 4      **end**

Return to Privileged EXEC Mode.

---

Step 5      **copy running-config startup-config**

Save the settings in the configuration file.

---

The following example shows how to set an alarm entry to monitor BPPackets on the switch. Set the related Statistics entry index as 1, the sample type as Absolute, the rising threshold as 3000, the related rising event entry index as 1, the falling threshold as 2000, the related falling event index as 2, the alarm type as all, the notification interval as 10 seconds, and the owner of the entry as monitor:

### Switch#configure

```
Switch(config)#rmon alarm 1 stats-index 1 alarm-variable bpkt s-type absolute rising-  
threshold 3000 rising-event-index 1 falling-threshold 2000 falling-event-index 2 a-type  
all interval 10 owner monitor
```

```
Switch(config)#show rmon alarm
```

```
Index-State:    1-Enabled  
Statistics index: 1  
Alarm variable: BPkt  
Sample Type:   Absolute  
RHold-REvent:  3000-1  
FHold-FEvent:  2000-2  
Alarm startup: All  
Interval:      10  
Owner:         monitor
```

```
Switch(config)#end
```

```
Switch#copy running-config startup-config
```

# 6 Configuration Example

## 6.1 Network Requirements

The following figure shows the network topology of a company. The company has requirements as follows:

- 1) Monitor storm traffic of ports 1/0/1 and 1/0/2 on Switch A, and send notifications to the NMS when the actual rate of broadcast, multicast or unknown-unicast packets exceeds the preset threshold.
- 2) Monitor the traffic of ports 1/0/1 and 1/0/2 on Switch A, and regularly collect and save data for follow-up checks. Specifically, Switch A should notify the NMS when the number of packets transmitted and received on the ports during the sample interval exceeds the preset rising threshold, and should record but not notify the NMS when that is below the preset falling threshold.

The NMS host with IP address 192.168.1.222 is connected to the core switch, Switch B. Switch A is connected to Switch B via port 1/0/3. Port 1/0/3 and the NMS can reach one another.

Figure 6-1 Network Topology

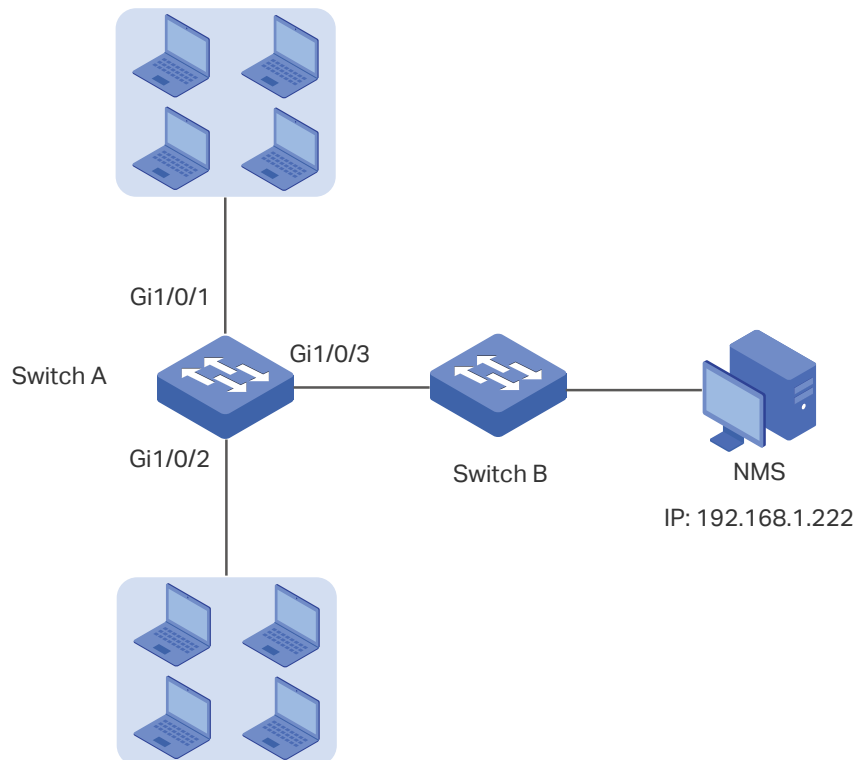



## 6.2 Configuration Scheme

- 1) On Switch A, set thresholds for broadcast, multicast and unknown-unicast packets on ports 1/0/1 and 1/0/2. Enable SNMP and configure the corresponding parameters. Enable Trap notifications on the ports. Switch A can then send notifications to the NMS when the rate of storm traffic exceeds the preset threshold.
- 2) After SNMP and Notification configurations, create Statistic entries on the ports to monitor the real-time transmitting and receiving of packets and create History entries to regularly collect and save related data. Create two Event entries: one is the Notify type used to notify the NMS, and the other is the Log type used to record related events.
- 3) Create an Alarm entry to monitor RecPackets (Received Packets). Configure the rising and falling thresholds. Configure the rising event as the Notify event entry, and the falling event as the Log event entry.

Demonstrated with T2600G-28TS, this chapter provides configuration procedures in two ways: using the GUI and using the CLI.

## 6.3 Using the GUI

### ■ Configuring Storm Control on Ports

Configure Storm Control on the required ports. For detailed configuration, refer to *Configuring QoS*.

### ■ Configuring SNMP

- 1) Choose **MAINTENANCE > SNMP > Global Config** to load the following page. In the **Global Config** section, enable SNMP, and set the Remote Engine ID as 123456789a. Click **Apply**.

Figure 6-2 Enabling SNMP

Global Config

SNMP:  Enable

Local Engine ID:  Default ID (10-64 Hex)

Remote Engine ID:  (Null or 10-64 Hex)

- 2) In the **SNMP View Config** section, click **+ Add** to load the following page. Name the SNMP view as View, set the view type as Include, and set MIB Object ID as 1 (which means all functions). Click **Create**.

Figure 6-3 Creating an SNMP View

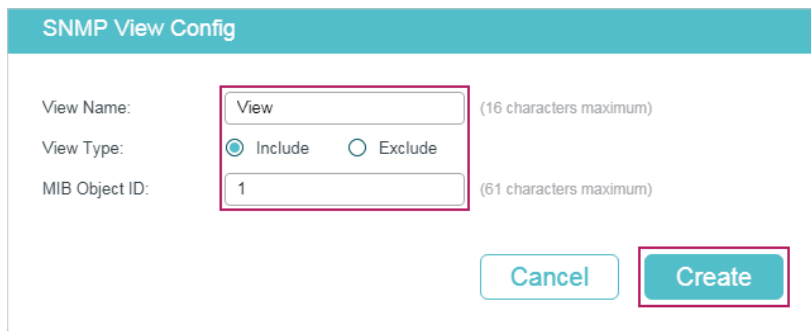

The image shows the 'SNMP View Config' form. It has a teal header. Below the header, there are three rows of input fields: 'View Name' with a text box containing 'View' and '(16 characters maximum)' to its right; 'View Type' with two radio buttons, 'Include' (which is selected) and 'Exclude'; and 'MIB Object ID' with a text box containing '1' and '(61 characters maximum)' to its right. At the bottom right, there are two buttons: 'Cancel' and 'Create'. A red rectangular box highlights the 'View Name', 'View Type', and 'MIB Object ID' fields.

- 3) Choose **MAINTENANCE > SNMP > SNMP v3 > SNMP Group** and click **+** Add to load the following page. Create a group named nms-monitor, enable authentication and privacy, and add View to Read View and Notify View. Click **Create**.

Figure 6-4 Configuring an SNMP Group

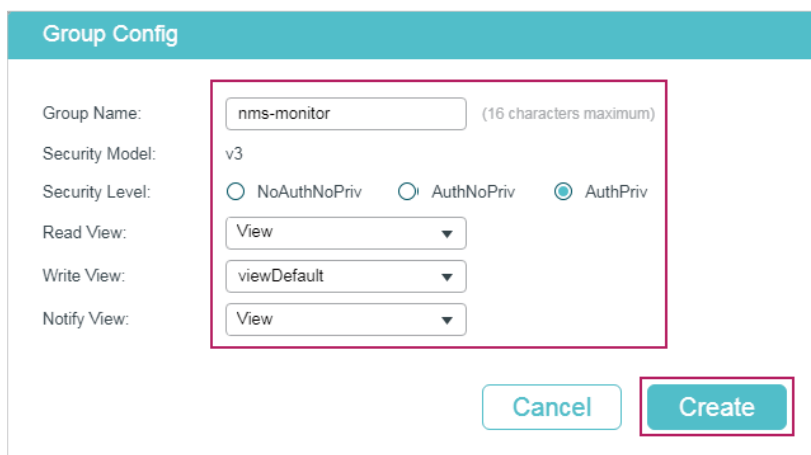

The image shows the 'Group Config' form. It has a teal header. Below the header, there are six rows of input fields: 'Group Name' with a text box containing 'nms-monitor' and '(16 characters maximum)' to its right; 'Security Model' with a text box containing 'v3'; 'Security Level' with three radio buttons, 'NoAuthNoPriv', 'AuthNoPriv', and 'AuthPriv' (which is selected); 'Read View' with a dropdown menu showing 'View'; 'Write View' with a dropdown menu showing 'viewDefault'; and 'Notify View' with a dropdown menu showing 'View'. At the bottom right, there are two buttons: 'Cancel' and 'Create'. A red rectangular box highlights the 'Group Name', 'Security Model', 'Security Level', 'Read View', 'Write View', and 'Notify View' fields.

- 4) Choose **MAINTENANCE > SNMP > SNMP v3 > SNMP User** and click **+** Add to load the following page. Create a user named admin for the NMS, set the user type as Remote User and specify the group name. Set the Security Level in accordance with that of the group nms-monitor. Choose SHA authentication algorithm and DES privacy algorithm, and set corresponding passwords. Click **Create**.

Figure 6-5 Creating an SNMP User

The screenshot shows the 'User Config' form with the following fields and values:

- User Name: admin (16 characters maximum)
- User Type:  Local User  Remote User
- Group Name: nms-monitor
- Security Model: v3
- Security Level:  NoAuthNoPriv  AuthNoPriv  AuthPriv
- Authentication Mode:  MD5  SHA
- Authentication Password: .... (16 characters maximum)
- Privacy Mode:  DES
- Privacy Password: .... (16 characters maximum)

Buttons: Cancel, Create

- 5) Choose **MAINTENANCE > SNMP > Notification > Notification Config** and click Add to load the following page. Choose the IP Mode as IPv4, and specify the IP address of the NMS host and the port of the host for transmitting notifications. Specify the User as admin and choose the type as Inform. Set the retry times as 3, with the timeout period as 100 seconds. Click **Create**.

Figure 6-6 Creating an SNMP Notification Entry

The screenshot shows the 'Notification Config' form with the following fields and values:

- IP Mode:  IPv4  IPv6
- IP Address: 192.168.1.222 (Format: 192.168.0.1)
- UDP Port: 162 (0-65535)
- User: admin
- Security Mode:  v1  v2c  v3
- Security Level:  NoAuthNoPriv  AuthNoPriv  AuthPriv
- Type:  Trap  Inform
- Retry Times: 3 (1-255)
- Timeout: 100 (1-3600)

Buttons: Cancel, Create

- 6) Choose **MAINTENANCE > SNMP > Notification > Trap Config** to load the following page. Enable Storm Control trap and click **Apply**.

Figure 6-7 Enabling Storm Control Trap

SNMP Traps

|   |   |   |
|---|---|---|
| <input checked="" type="checkbox"/> SNMP Authentication | <input checked="" type="checkbox"/> Coldstart | <input checked="" type="checkbox"/> Warmstart |
| <input checked="" type="checkbox"/> Link Status         | <input type="checkbox"/> CPU Utilization      | <input type="checkbox"/> Memory Utilization   |
| <input type="checkbox"/> Flash Operation                | <input type="checkbox"/> VLAN Create/Delete   | <input type="checkbox"/> IP Change            |
| <input checked="" type="checkbox"/> Storm Control       | <input type="checkbox"/> Rate Limit           | <input type="checkbox"/> LLDP                 |
| <input type="checkbox"/> Loopback Detection             | <input type="checkbox"/> Spanning Tree        | <input type="checkbox"/> IP-MAC Binding       |
| <input type="checkbox"/> IP Duplicate                   | <input type="checkbox"/> DHCP Filter          | <input type="checkbox"/> DDM Temperature      |
| <input type="checkbox"/> DDM Voltage                    | <input type="checkbox"/> DDM Bias Current     | <input type="checkbox"/> DDM TX Power         |
| <input type="checkbox"/> DDM RX Power                   | <input type="checkbox"/> ACL Counter          |   |

**Apply**

7) Click  Save to save the settings.

## ■ Configuring RMON

1) Choose **MAINTENANCE > SNMP > RMON > Statistics** and click  Add to load the following page. Create Statistics entries 1 and 2, and bind them to ports 1/0/1 and 1/0/2, respectively. Set the owner of the entries as monitor and the status as Valid.

Figure 6-8 Configuring Statistics Entry 1

Statistics Config

Index:  (1-65535)

Port:  **Choose** (Format: 1/0/1)

Owner:  (16 characters maximum)

Status:  Valid  Under Creation

**Cancel** **Create**

Figure 6-9 Configuring Statistics Entry 2

Statistics Config

Index:  (1-65535)

Port:  **Choose** (Format: 1/0/1)

Owner:  (16 characters maximum)

Status:  Valid  Under Creation

**Cancel** **Create**

2) Choose the menu **MAINTENANCE > SNMP > RMON > History** to load the following page. Configure entries 1 and 2. Bind entries 1 and 2 to ports 1/0/1 and 1/0/2, respectively. Set the Interval as 100 seconds, Maximum Buckets as 50, the owner of the entries as monitor, and the status as enabled.

Figure 6-10 Configuring the History Entries

| History Control Config   |       |       |                    |                 |         |          |
|--------------------------|-------|-------|--------------------|-----------------|---------|----------|
| <input type="checkbox"/> | Index | Port  | Interval (seconds) | Maximum Buckets | Owner   | Status   |
| <input type="checkbox"/> | 1     | 1/0/1 | 100                | 50              | monitor | Enabled  |
| <input type="checkbox"/> | 2     | 1/0/2 | 100                | 50              | monitor | Enabled  |
| <input type="checkbox"/> | 3     | 1/0/1 | 1800               | 50              | monitor | Disabled |
| <input type="checkbox"/> | 4     | 1/0/1 | 1800               | 50              | monitor | Disabled |
| <input type="checkbox"/> | 5     | 1/0/1 | 1800               | 50              | monitor | Disabled |
| <input type="checkbox"/> | 6     | 1/0/1 | 1800               | 50              | monitor | Disabled |
| <input type="checkbox"/> | 7     | 1/0/1 | 1800               | 50              | monitor | Disabled |
| <input type="checkbox"/> | 8     | 1/0/1 | 1800               | 50              | monitor | Disabled |
| <input type="checkbox"/> | 9     | 1/0/1 | 1800               | 50              | monitor | Disabled |
| <input type="checkbox"/> | 10    | 1/0/1 | 1800               | 50              | monitor | Disabled |
| Total: 12                |       |       |                    |                 |         |          |

- 3) Choose the menu **MAINTENANCE > SNMP > RMON > Event** to load the following page. Configure entries 1 and 2. For entry 1, set the SNMP user name as admin, type as Notify, description as "rising\_notify", owner as monitor, and status as enable. For entry 2, set the SNMP user name as admin, type as Log, description as "falling\_log", owner as monitor, and status as enabled.

Figure 6-11 Configuring the Event Entries

| Event Config             |       |        |               |             |         |          |
|--------------------------|-------|--------|---------------|-------------|---------|----------|
| <input type="checkbox"/> | Index | User   | Description   | Action Mode | Owner   | Status   |
| <input type="checkbox"/> | 1     | admin  | rising_notify | Notify      | monitor | Enabled  |
| <input type="checkbox"/> | 2     | admin  | falling_log   | Log         | monitor | Enabled  |
| <input type="checkbox"/> | 3     | public |               | None        | monitor | Disabled |
| <input type="checkbox"/> | 4     | public |               | None        | monitor | Disabled |
| <input type="checkbox"/> | 5     | public |               | None        | monitor | Disabled |
| <input type="checkbox"/> | 6     | public |               | None        | monitor | Disabled |
| <input type="checkbox"/> | 7     | public |               | None        | monitor | Disabled |
| <input type="checkbox"/> | 8     | public |               | None        | monitor | Disabled |
| <input type="checkbox"/> | 9     | public |               | None        | monitor | Disabled |
| <input type="checkbox"/> | 10    | public |               | None        | monitor | Disabled |
| Total: 12                |       |        |               |             |         |          |

- 4) Choose **MAINTENANCE > SNMP > RMON > Alarm** to load the following page. Configure entries 1 and 2. For entry 1, set the alarm variable as RecPackets, related statistics entry ID as 1 (bound to port 1/0/1), the sample type as Absolute, the rising threshold as 3000, associated rising event entry ID as 1 (which is the notify type), the falling threshold as 2000, the associated falling event entry ID as 2 (which is the log type), the alarm type as All, the interval as 10 seconds, the owner name as monitor. For entry 2, set the associated statistics entry ID as 2 (bound to port 1/0/2). Other configurations are the same as those of entry 1.

Figure 6-12 Configuring the Alarm Entries

| <input type="checkbox"/> | Index | Variable   | Statistics | Sample Type | Rising Threshold | Rising Event | Falling Threshold | Falling Event | Alarm Type | Interval (seconds) | Owner   | Status   |
|--------------------------|-------|------------|------------|-------------|------------------|--------------|-------------------|---------------|------------|--------------------|---------|----------|
| <input type="checkbox"/> | 1     | RecPackets | 1          | Absolute    | 3000             | 1            | 2000              | 2             | All        | 10                 | monitor | Enabled  |
| <input type="checkbox"/> | 2     | RecPackets | 2          | Absolute    | 3000             | 1            | 2000              | 2             | All        | 10                 | monitor | Enabled  |
| <input type="checkbox"/> | 3     | RecBytes   | 0          | Absolute    | 100              | 0            | 100               | 0             | All        | 1800               | monitor | Disabled |
| <input type="checkbox"/> | 4     | RecBytes   | 0          | Absolute    | 100              | 0            | 100               | 0             | All        | 1800               | monitor | Disabled |
| <input type="checkbox"/> | 5     | RecBytes   | 0          | Absolute    | 100              | 0            | 100               | 0             | All        | 1800               | monitor | Disabled |
| <input type="checkbox"/> | 6     | RecBytes   | 0          | Absolute    | 100              | 0            | 100               | 0             | All        | 1800               | monitor | Disabled |
| <input type="checkbox"/> | 7     | RecBytes   | 0          | Absolute    | 100              | 0            | 100               | 0             | All        | 1800               | monitor | Disabled |
| <input type="checkbox"/> | 8     | RecBytes   | 0          | Absolute    | 100              | 0            | 100               | 0             | All        | 1800               | monitor | Disabled |
| <input type="checkbox"/> | 9     | RecBytes   | 0          | Absolute    | 100              | 0            | 100               | 0             | All        | 1800               | monitor | Disabled |
| <input type="checkbox"/> | 10    | RecBytes   | 0          | Absolute    | 100              | 0            | 100               | 0             | All        | 1800               | monitor | Disabled |

Total: 12

- 5) Click  to save settings.

## 6.4 Using the CLI

### ■ Configuring Storm Control on ports

Configure the Storm Control on the required ports of Switch A. For detailed configuration, refer to *Configuring QoS*.

### ■ Configuring SNMP

- 1) Enable SNMP and specify the remote engine ID.

```
Switch_A#configure
```

```
Switch_A(config)#snmp-server
```

```
Switch_A(config)#snmp-server engineID remote 123456789a
```

- 2) Create a view with the name View; set the MIB Object ID as 1 (which represents all functions), and the view type as Include.

```
Switch_A(config)#snmp-server view View 1 include
```

- 3) Create a group of SNMPv3 with the name of nms-monitor. Enable Auth Mode and Privacy Mode, and set both the Read and Notify views as View.

```
Switch_A(config)#snmp-server group nms-monitor smode v3 slev authPriv read View notify View
```

- 4) Create an SNMP user named admin. Set the user as a remote user and configure the security model and security level based on the group. Set the Auth Mode as SHA algorithm, password as 1234, the Privacy Mode as DES, and password as 1234.

```
Switch_A(config)#snmp-server user admin remote nms-monitor smode v3 slev authPriv cmode SHA cpwd 1234 emode DES epwd 1234
```

- 5) To configure Notification, specify the IP address of the NMS host and UDP port. Set the User, Security Model and Security Level according to configurations of the SNMP User.

Choose the type as Inform, and set the retry times as 3, and the timeout period as 100 seconds.

```
Switch_A(config)#snmp-server host 192.168.1.222 162 admin smode v3 slev authPriv
type inform retries 3 timeout 100
```

#### ■ Enable storm-control Trap

```
Switch_A(config)#snmp-server traps storm-control
```

#### ■ Configuring RMON

- 1) Create Statistics entries 1 and 2 to monitor ports 1/0/1 and 1/0/2, respectively. The owner of the entries is set as monitor, and the status is set as valid.

```
Switch_A(config)#rmon statistics 1 interface gigabitEthernet 1/0/1 owner monitor
status valid
```

```
Switch_A(config)#rmon statistics 2 interface gigabitEthernet 1/0/2 owner monitor
status valid
```

- 2) Create History entries 1 and 2 and bind them to ports 1/0/1 and 1/0/2, respectively. Set the sample interval as 100 seconds, max buckets as 50, and the owner as monitor.

```
Switch_A(config)#rmon history 1 interface gigabitEthernet 1/0/1 interval 100 owner
monitor buckets 50
```

```
Switch_A(config)#rmon history 2 interface gigabitEthernet 1/0/2 interval 100 owner
monitor buckets 50
```

- 3) Create Event entries 1 and 2 for the SNMP user admin. Set entry 1 as the Notify type and its description as "rising\_notify". Set entry 2 as the Log type and its description as "falling\_log". Set the owner of them as monitor.

```
Switch_A(config)#rmon event 1 user admin description rising_notify type notify owner
monitor
```

```
Switch_A(config)#rmon event 2 user admin description falling_log type log owner
monitor
```

- 4) Create Alarm entries 1 and 2. For entry 1, set the alarm variable as RecPackets, associated Statistics entry ID as 1 (bound to port 1/0/1), the sample type as Absolute, the rising threshold as 3000, the associated rising event entry ID as 1 (Notify type), the falling threshold as 2000, the associated falling event entry ID as 2 (the log type), the alarm type as all, the interval as 10 seconds, and the owner name as monitor. For entry 2, set the associated statistics entry ID as 2 (bound to port 1/0/2), while all other configurations are the same as those of entry 1.

```
Switch_A(config)#rmon alarm 1 stats-index 1 alarm-variable revpkt s-type absolute
rising-threshold 3000 rising-event-index 1 falling-threshold 2000 falling-event-index 2
a-type all interval 10 owner monitor
```

```
Switch_A(config)#rmon alarm 2 stats-index 2 alarm-variable revpkt s-type absolute  
rising-threshold 3000 rising-event-index 1 falling-threshold 2000 falling-event-index 2  
a-type all interval 10 owner monitor
```

## Verify the Configurations

Verify global SNMP configurations:

```
Switch_A(config)#show snmp-server
```

SNMP agent is enabled.

```
0  SNMP packets input
   0  Bad SNMP version errors
   0  Unknown community name
   0  Illegal operation for community name supplied
   0  Encoding errors
   0  Number of requested variables
   0  Number of altered variables
   0  Get-request PDUs
   0  Get-next PDUs
   0  Set-request PDUs
0  SNMP packets output
   0  Too big errors(Maximum packet size 1500)
   0  No such name errors
   0  Bad value errors
   0  General errors
   0  Response PDUs
   0  Trap PDUs
```

Verify SNMP engine ID:

```
Switch_A(config)#show snmp-server engineID
```

Local engine ID: 80002e5703000aeb13a23d

Remote engine ID: 123456789a



Verify SNMP view configurations:

Switch\_A(config)#show snmp-server view

| No. | View Name   | Type    | MOID           |
|-----|-------------|---------|----------------|
| 1   | viewDefault | include | 1              |
| 2   | viewDefault | exclude | 1.3.6.1.6.3.15 |
| 3   | viewDefault | exclude | 1.3.6.1.6.3.16 |
| 4   | viewDefault | exclude | 1.3.6.1.6.3.18 |
| 5   | View        | include | 1              |

Verify SNMP group configurations:

Switch\_A(config)#show snmp-server group

| No. | Name        | Sec-Mode | Sec-Lev  | Read-View | Write-View | Notify-View |
|-----|-------------|----------|----------|-----------|------------|-------------|
| 1   | nms-monitor | v3       | authPriv | View      |            | View        |

Verify SNMP user configurations:

Switch\_A(config)#show snmp-server user

| No. | U-Name | U-Type | G-Name      | S-Mode | S-Lev    | A-Mode | P-Mode |
|-----|--------|--------|-------------|--------|----------|--------|--------|
| 1   | admin  | remote | nms-monitor | v3     | authPriv | SHA    | DES    |

Verify SNMP host configurations:

Switch\_A(config)#show snmp-server host

| No. | Des-IP        | UDP | Name  | SecMode | SecLev   | Type   | Retry | Timeout |
|-----|---------------|-----|-------|---------|----------|--------|-------|---------|
| 1   | 172.168.1.222 | 162 | admin | v3      | authPriv | inform | 3     | 100     |

Verify RMON statistics configurations:

Switch\_A(config)#show rmon statistics

| Index | Port    | Owner   | State |
|-------|---------|---------|-------|
| 1     | Gi1/0/1 | monitor | valid |
| 2     | Gi1/0/2 | monitor | valid |

Verify RMON history configurations:

Switch\_A(config)#show rmon history

| Index | Port    | Interval | Buckets | Owner   | State  |
|-------|---------|----------|---------|---------|--------|
| 1     | Gi1/0/1 | 100      | 50      | monitor | Enable |
| 2     | Gi1/0/2 | 100      | 50      | monitor | Enable |

Verify RMON event configurations:

Switch\_A(config)#show rmon event

| Index | User  | Description   | Type   | Owner   | State  |
|-------|-------|---------------|--------|---------|--------|
| 1     | admin | rising_notify | Notify | monitor | Enable |
| 2     | admin | falling_log   | Log    | monitor | Enable |

Verify RMON alarm configurations:

Switch\_A(config)#show rmon alarm

```

Index-State:      1-Enabled
Statistics index: 1
Alarm variable:   RevPkt
Sample Type:     Absolute
RHold-REvent:    3000-1
FHold-FEvent:    2000-2
Alarm startup:    All
Interval:        10
Owner:           monitor

```

Index-State: 2-Enabled  
Statistics index: 2  
Alarm variable: RevPkt  
Sample Type: Absolute  
RHold-REvent: 3000-1  
FHold-FEvent: 2000-2  
Alarm startup: All  
Interval: 10  
Owner: monitor

# 7 Appendix: Default Parameters

Default settings of SNMP are listed in the following tables.

Table 7-1 Default Global Config Settings

| Parameter        | Default Setting |
|------------------|-----------------|
| SNMP             | Disabled        |
| Local Engine ID  | Automatically   |
| Remote Engine ID | None            |

Table 7-2 Default SNMP View Table Settings

| View Name   | View Type | MIB Object ID  |
|-------------|-----------|----------------|
| viewDefault | Include   | 1              |
| viewDefault | Exclude   | 1.3.6.1.6.3.15 |
| viewDefault | Exclude   | 1.3.6.1.6.3.16 |
| viewDefault | Exclude   | 1.3.6.1.6.3.18 |

Table 7-3 Default SNMP v1/v2c Settings

| Parameter       | Default Setting |
|-----------------|-----------------|
| Community Entry | No entries      |
| Community Name  | None            |
| Access          | Read-only       |
| MIB View        | viewDefault     |

Table 7-4 Default SNMP v3 Settings

| Parameter      | Default Setting |
|----------------|-----------------|
| SNMP Group     |                 |
| Group Entry    | No entries      |
| Group Name     | None            |
| Security Model | v3              |
| Security Level | NoAuthNoPriv    |
| Read View      | viewDefault     |
| Write View     | None            |
| Notify View    | None            |

| Parameter               | Default Setting   |
|-------------------------|---|
| SNMP User               |   |
| User Entry              | No entries  |
| User Name               | None  |
| User Type               | Local User  |
| Group Name              | None  |
| Security Model          | v3  |
| Security Level          | noAuthNoPriv  |
| Authentication Mode     | MD5 (when Security Level is configured as AuthNoPriv or AuthPriv) |
| Authentication Password | None  |
| Privacy Mode            | DES (when Security Level is configured as AuthPriv)               |
| Privacy Password        | None  |

Default settings of Notification are listed in the following table.

Table 7-5 Default Notification Settings

| Parameter           | Default Setting  |
|---------------------|--|
| Notification Config |  |
| Notification Entry  | No entries   |
| IP Mode             | IPv4   |
| IP Address          | None   |
| UDP Port            | 162  |
| User                | None   |
| Security Model      | v1   |
| Security Level      | noAuthNoPriv   |
| Type                | Trap   |
| Retry               | None   |
| Timeout             | None   |
| Trap Config         |  |
| Enabled SNMP Traps  | SNMP Authentication, Coldstart, Warmstart, Link Status |

Default settings of RMON are listed in the following tables.

Table 7-6 Default Statistics Config Settings

| Parameter        | Default Setting |
|------------------|-----------------|
| Statistics Entry | No entries      |
| ID               | None            |
| Port             | None            |
| Owner            | None            |
| IP Mode          | Valid           |

Table 7-7 Default Settings for History Entries

| Parameter   | Default Setting |
|-------------|-----------------|
| Port        | 1/0/1           |
| Interval    | 1800 seconds    |
| Max Buckets | 50              |
| Owner       | monitor         |
| Status      | Disabled        |

Table 7-8 Default Settings for Event Entries

| Parameter   | Default Setting |
|-------------|-----------------|
| User        | public          |
| Description | None            |
| Type        | None            |
| Owner       | monitor         |
| Status      | Disabled        |

Table 7-9 Default Settings for Alarm Entries

| Parameter         | Default Setting                           |
|-------------------|---|
| Variable          | RecBytes                                  |
| Statistics        | 0, means no Statistics entry is selected. |
| Sample Type       | Absolute                                  |
| Rising Threshold  | 100                                       |
| Rising Event      | 0, means no event is selected.            |
| Falling Threshold | 100                                       |
| Falling Event     | 0, means no event is selected.            |
| Alarm Type        | All                                       |

| Parameter | Default Setting |
|-----------|-----------------|
| Interval  | 1800 seconds    |
| Owner     | monitor         |
| Status    | Disabled        |

# Part 29

## Diagnosing the Device & Network

### CHAPTERS

1. Diagnosing the Device
2. Diagnosing the Network
3. Appendix: Default Parameters



# 1 Diagnosing the Device

The device diagnostics feature provides cable testing, which allows you to troubleshoot based on the connection status, cable length and fault location.

## 1.1 Using the GUI

Choose the menu **MAINTENANCE > Device Diagnostics** to load the following page.

Figure 1-1 Diagnosing the Cable

The screenshot shows the 'Cable Test' interface for 'UNIT1'. It features a grid of 28 RJ45 port icons arranged in two rows. The top row contains ports 2, 4, 6, 8, 10, 12, 14, 16, 18, 20, 22, and 24. The bottom row contains ports 1, 3, 5, 7, 9, 11, 13, 15, 17, 19, 21, and 23. Ports 26, 28, 25, and 27 are shown in a greyed-out state. A legend below the grid identifies three states: 'Selected' (blue icon), 'Unselected' (white icon), and 'Not Available' (grey icon). Below the grid is a table with the following data:

| Result |        |                 |                         |
|--------|--------|-----------------|-------------------------|
| Pair   | Status | Length (meters) | Fault Location (meters) |
| A      | --     | --              | --                      |
| B      | --     | --              | --                      |
| C      | --     | --              | --                      |
| D      | --     | --              | --                      |

An 'Apply' button is located at the bottom right of the interface.

Follow these steps to diagnose the cable:

- 1) Select your desired port for the test and click **Apply**.
- 2) Check the test results in the **Result** section.

|      |                           |
|------|---------------------------|
| Pair | Displays the Pair number. |
|------|---------------------------|

|                       |   |
|-----------------------|---|
| <b>Status</b>         | Displays the cable status. Test results include normal, closed, open and crosstalk.<br><br>Normal : The cable is connected normally.<br><br>Closed: A short circuit is being caused by abnormal contact of wires in the cable.<br><br>Open: No device is connected to the other end or the connection is broken.<br><br>Crosstalk: Impedance mismatch due to the poor quality of the cable. |
| <b>Length</b>         | If the connection status is normal, the length range of the cable is displayed.   |
| <b>Fault Location</b> | If the connection status is short, close or crosstalk, here displays the length from the port to the trouble spot.  |

## 1.2 Using the CLI

On privileged EXEC mode or any other configuration mode, you can use the following command to check the connection status of the cable that is connected to the switch.

```
show cable-diagnostics interface { fastEthernet port | gigabitEthernet port | ten-gigabitEthernet port }
```

View the cable diagnostics of the connected Ethernet Port.

*port*: Enter the port number in 1/0/1 format to check the result of the cable test.

```
show cable-diagnostics careful interface { fastEthernet port | gigabitEthernet port | ten-gigabitEthernet port }
```

View the cable diagnostics of the connected Ethernet Port. When taking the careful cable test, the switch will only test the cable for the port which is in the link-down status.

*port*: Enter the port number in 1/0/1 format to check the result of the cable test.

The following example shows how to check the cable diagnostics of port 1/0/2:

```
Switch#show cable-diagnostics interface gigabitEthernet 1/0/2
```

| Port    | Pair   | Status | Length      | Error |
|---------|--------|--------|-------------|-------|
| Gi1/0/2 | Pair-A | Normal | 2 (+/- 10m) | ---   |
|         | Pair-B | Normal | 2 (+/- 10m) | ---   |
|         | Pair-C | Normal | 0 (+/- 10m) | ---   |
|         | Pair-D | Normal | 2 (+/- 10m) | ---   |

# 2 Diagnosing the Network

The network diagnostics feature provides Ping testing and Tracert testing. You can test connectivity to remote hosts, or to the gateways from the switch to the destination.

With Network Diagnostics, you can:

- Troubleshoot with Ping testing.
- Troubleshoot with Tracert testing.

## 2.1 Using the GUI

### 2.1.1 Troubleshooting with Ping Testing

You can use the Ping tool to test connectivity to remote hosts.

Choose the menu **MAINTENANCE > Network Diagnostics > Ping** to load the following page.

Figure 2-1 Troubleshooting with Ping Testing

The screenshot displays the 'Ping Config' interface. It features four input fields for configuration: 'Destination IP' (192.168.0.26), 'Ping Times' (4), 'Data Size' (64), and 'Interval' (1000). A 'Ping' button is located on the right. Below the configuration is a 'Ping Result' section with a teal header. The results show four successful replies from 192.168.0.26 with varying times and TTL values. A 'Ping statistics' section shows 4 packets sent, 4 received, and 0% loss. An 'Approximate round trip times' section shows a maximum of 19ms, minimum of 3ms, and average of 7ms.

| Destination IP | Ping Times | Data Size | Interval |
|----------------|------------|-----------|----------|
| 192.168.0.26   | 4          | 64        | 1000     |

**Ping Result**

**Pinging 192.168.0.26 with 64 bytes of data:**

- Reply from 192.168.0.26 : bytes=64 time=19ms TTL=64
- Reply from 192.168.0.26 : bytes=64 time=3ms TTL=64
- Reply from 192.168.0.26 : bytes=64 time=3ms TTL=64
- Reply from 192.168.0.26 : bytes=64 time=3ms TTL=64

**Ping statistics for 192.168.0.26 :**

Packets: Sent=4, Received=4, Loss=0 (0%Loss)

**Approximate round trip times in milliseconds:**

Maximum=19ms, Minimum=3ms, Average=7ms

Follow these steps to test the connectivity between the switch and another device in the network:

- 1) In the **Ping Config** section, enter the IP address of the destination device for Ping test, set Ping times, data size and interval according to your needs, and then click **Ping** to start the test.

|                       |  |
|-----------------------|--|
| <b>Destination IP</b> | Enter the IP address of the destination node for Ping test. Both IPv4 and IPv6 are supported.                                  |
| <b>Ping Times</b>     | Enter the number of times test data will be sent for Ping testing. It is recommended to use the default value of 4.            |
| <b>Data Size</b>      | Enter the size of the data sent for Ping testing. It is recommended to keep the default value of 64 bytes.                     |
| <b>Interval</b>       | Specify the interval at which ICMP request packets are sent. It is recommended to keep the default value of 1000 milliseconds. |

- 2) In the **Ping Result** section, check the test results.

## 2.1.2 Troubleshooting with Tracert Testing

You can use the Tracert tool to find the path from the switch to the destination, and test connectivity between the switch and routers along the path.

Choose the menu **MAINTENANCE > Network Diagnostics > Tracert** to load the following page.

Figure 2-1 Troubleshooting with Tracert Testing

**Tracert Config**

Destination IP:  (Format: 192.168.0.1 or 2001::1)

Maximum Hops:  hops (1-30)

**Tracert**

---

**Tracert Result**

Tracing route to [192.168.0.26] over a maximum of 4 hops

|   |     |     |     |              |
|---|-----|-----|-----|--------------|
| 1 | 3ms | 3ms | 3ms | 192.168.0.26 |
|---|-----|-----|-----|--------------|

Follow these steps to test connectivity between the switch and routers along the path from the source to the destination:

- 1) In the **Tracert Config** section, enter the IP address of the destination, set the max hop, and then click **Tracert** to start the test.

|                       |   |
|-----------------------|---|
| <b>Destination IP</b> | Enter the IP address of the destination device. Both IPv4 and IPv6 are supported. |
| <b>Maximum Hops</b>   | Specify the maximum number of the route hops the test data can pass through.      |

2) In the **Tracert Result** section, check the test results.

## 2.2 Using the CLI

### 2.2.1 Configuring the Ping Test

On privileged EXEC mode, you can use the following command to test the connectivity between the switch and one node of the network.

---

```
ping [ ip | ipv6 ] { ip_addr } [ -n count ] [ -l size ] [ -i interval ]
```

Test the connectivity between the switch and destination device.

**ip:** The type of the IP address for ping test should be IPv4.

**ipv6:** The type of the IP address for ping test should be IPv6.

**ip\_addr:** The IP address of the destination node for ping test. If the parameter ip/ipv6 is not selected, both IPv4 and IPv6 addresses are supported, such as 192.168.0.100 or fe80::1234.

**count:** Specify the amount of times to send test data for Ping testing. The values are from 1 to 10 times; the default is 4 times.

**size:** Specify the size of the sending data for ping testing. The values are from 1 to 1500 bytes; the default is 64 bytes.

**interval:** Specify the interval to send ICMP request packets. The values are from 100 to 1000 milliseconds; the default is 1000 milliseconds.

---

The following example shows how to test the connectivity between the switch and the destination device with the IP address 192.168.0.10. Specify the ping times as 3, the data size as 1000 bytes and the interval as 500 milliseconds:

```
Switch#ping ip 192.168.0.10 -n 3 -l 1000 -i 500
```

Pinging 192.168.0.10 with 1000 bytes of data :

Reply from 192.168.0.10 : bytes=1000 time<16ms TTL=64

Reply from 192.168.0.10 : bytes=1000 time<16ms TTL=64

Reply from 192.168.0.10 : bytes=1000 time<16ms TTL=64

Ping statistics for 192.168.0.10:

Packets: Sent = 3 , Received = 3 , Lost = 0 (0% loss)

Approximate round trip times in milli-seconds:

Minimum = 0ms , Maximum = 0ms , Average = 0ms

## 2.2.2 Configuring the Tracert Test

On privileged EXEC mode, you can use the following command to test the connectivity between the switch and routers along the path from the source to the destination:

---

```
tracert [ ip | ipv6 ] ip_addr [ maxHops ]
```

Test the connectivity of the gateways along the path from the source to the destination.

**ip:** The type of the IP address for tracert test should be IPv4.

**ipv6:** The type of the IP address for tracert test should be IPv6.

**ip\_addr:** Enter the IP address of the destination device. If the parameter ip/ipv6 is not selected, both IPv4 and IPv6 addresses are supported, such as 192.168.0.100 or fe80::1234.

**maxHops:** Specify the maximum number of the route hops the test data can pass through. The range is 1 to 30 hops; the default is 4 hops.

---

The following example shows how to test the connectivity between the switch and the network device with the IP address 192.168.0.100. Set the maxhops as 2:

```
Switch#tracert 192.168.0.100 2
```

```
Tracing route to 192.168.0.100 over a maximum of 2 hops
```

```
 1    8 ms   1 ms   2 ms   192.168.1.1
 2    2 ms   2 ms   2 ms   192.168.0.100
```

```
Trace complete.
```

# 3 Appendix: Default Parameters

Default settings of Network Diagnostics are listed in the following tables.

Table 3-1 Default Settings of Ping Config

| Parameter      | Default Setting   |
|----------------|-------------------|
| Destination IP | 192.168.0.1       |
| Ping Times     | 4                 |
| Data Size      | 64 bytes          |
| Interval       | 1000 milliseconds |

Table 3-2 Default Settings of Tracert Config

| Parameter      | Default Setting |
|----------------|-----------------|
| Destination IP | 192.168.0.100   |
| Maximum Hops   | 4 hops          |

# Part 30

## Configuring System Logs

### CHAPTERS

1. Overview
2. System Logs Configurations
3. Configuration Example
4. Appendix: Default Parameters



# 1 Overview

The switch generates messages in response to events, faults, or errors occurred, as well as changes in configuration or other occurrences. You can check system messages for debugging and network management.

System logs can be saved in various destinations, such as the log buffer, log file or remote log servers, depending on your configuration. Logs saved in the log buffer and log file are called local logs, and logs saved in remote log servers are called remote logs. Remote logs facilitate you to remotely monitor the running status of the network.

You can set the severity level of the log messages to control the type of log messages saved in each destination.

# 2 System Logs Configurations

System logs configurations include:

- Configure the local logs.
- Configure the remote logs.
- Backing up the logs.
- Viewing the log table.

## Configuration Guidelines

Logs are classified into the following eight levels. Messages of levels 0 to 4 mean the functionality of the switch is affected. Please take actions according to the log message.

Table 2-1 Levels of Logs

| Severity      | Level | Description  | Example   |
|---------------|-------|--|---|
| Emergencies   | 0     | The system is unusable and you have to reboot the switch.  | Software malfunctions affect the functionality of the switch. |
| Alerts        | 1     | Actions must be taken immediately.   | The memory utilization reaches the limit.                     |
| Critical      | 2     | Cause analysis or actions must be taken immediately.   | The memory utilization reaches the warning threshold.         |
| Errors        | 3     | Error operations or unusual processing that will not affect subsequent operations but that should be noted and analyzed. | Wrong command or password is entered.                         |
| Warnings      | 4     | Conditions that may cause process failure and that should be noted.  | Error protocol packets are detected.                          |
| Notifications | 5     | Normal but significant conditions.   | The <b>shutdown</b> command is applied to a port.             |
| Informational | 6     | Normal messages for your information.  | The <b>display</b> command is used.                           |
| Debugging     | 7     | Debug-level messages that you can ignore.  | General operational information.                              |

## 2.1 Using the GUI

### 2.1.1 Configuring the Local Logs

Choose the menu **MAINTENANCE > Logs > Local Logs** to load the following page.

Figure 2-1 Configuring the Local Logs

| <input type="checkbox"/>            | Channel    | Severity          | Status  | Sync-Period  |
|-------------------------------------|------------|-------------------|---------|--|
| <input checked="" type="checkbox"/> | Log Buffer | level_6           | Enable  | Immediately  |
| <input type="checkbox"/>            | Log File   | level_3           | Disable | 24hour(s)  |
| Total: 2                            |            | 1 entry selected. |         | <input type="button" value="Cancel"/> <input type="button" value="Apply"/> |

Follow these steps to configure the local logs:

- 1) Select your desired channel and configure the corresponding severity and status.

|                      |   |
|----------------------|---|
| <b>Channel</b>       | <p>Local logs includes 2 channels: log buffer and log file.</p> <p>Log buffer indicates the RAM for saving system logs. The channel is enabled by default. Information in the log buffer is displayed on the <b>MAINTENANCE &gt; Logs &gt; Logs Table</b> page. It will be lost when the switch is restarted.</p> <p>Log file indicates the flash sector for saving system logs. Information in the log file will not be lost after the switch is restarted and can be exported on the <b>MAINTENANCE &gt; Logs &gt; Back Up Logs</b> page.</p> |
| <b>Severity</b>      | Specify the severity level of the log messages that are saved to the selected channel. Only log messages with a severity level value that is the same or lower than this will be saved. There are eight severity levels marked from 0 to 7. A lower value indicates a higher severity.  |
| <b>Status</b>        | Enable or disable the channel.  |
| <b>Sync-Periodic</b> | By default, the log information is saved in the log buffer immediately, and synchronized to the log file every 24 hours. If necessary, you can modify the log synchronization frequency using the CLI.  |

- 2) Click **Apply**.

### 2.1.2 Configuring the Remote Logs

You can configure up to four hosts to receive the switch's system logs. These hosts are called Log Servers. The switch will forward the log message to the servers once a log

message is generated. To display the logs, the servers should run a log server software that complies with the syslog standard.

Choose the menu **MAINTENANCE > Logs > Remote Logs** to load the following page.

Figure 2-2 Configuring the Remote Logs

| Log Server Config        |       |           |          |          |         |  |
|--------------------------|-------|-----------|----------|----------|---------|--|
| <input type="checkbox"/> | Index | Server IP | UDP Port | Severity | Status  |  |
| <input type="checkbox"/> | 1     | 0.0.0.0   | 514      | level_6  | Disable |  |
| <input type="checkbox"/> | 2     | 0.0.0.0   | 514      | level_6  | Disable |  |
| <input type="checkbox"/> | 3     | 0.0.0.0   | 514      | level_6  | Disable |  |
| <input type="checkbox"/> | 4     | 0.0.0.0   | 514      | level_6  | Disable |  |
| Total: 4                 |       |           |          |          |         |  |

Follow these steps to configure the information of remote log servers:

- 1) Select an entry to enable the server, and then set the server IP address and severity.

|                  |  |
|------------------|--|
| <b>Server IP</b> | Specify an IP address of the log server.   |
| <b>UDP Port</b>  | Displays the UDP port used by the server to receive the log messages. The switch uses standard port 514 to send log messages.  |
| <b>Severity</b>  | Specify the severity level of the log messages sent to the selected log server. Only log messages with a severity level value that is the same or lower than this will be saved. |
| <b>Status</b>    | Enable or disable the log server.  |

- 2) Click **Apply**.

### 2.1.3 Backing up the Logs

Choose the menu **MAINTENANCE > Logs > Back Up Logs** to load the following page.

Figure 2-3 Backing up the Log File

Back Up Logs

---

Click this button to back up the log file.

[Back Up Logs](#)

Click **Back Up Logs** to save the system logs as a file on your computer. If the switch system breaks down, you can check the file for troubleshooting.

## 2.1.4 Viewing the Log Table

Choose the menu **MAINTENANCE > Logs > Log Table** to load the following page.

Figure 2-4 View the Log Table

Log Info  Refresh

| UNIT1      |                     |               |              |  |
|------------|---------------------|---------------|--------------|--|
| Index      | Time                | Module        | Severity     | Content  |
|            |                     | All Modules ▼ | All Levels ▼ |  |
| 1          | 2006-01-03 05:04:59 | QoS           | level_6      | Disable broadcast rate limit of port 5 by admin on web (192.168.0.200).  |
| 2          | 2006-01-03 05:04:59 | QoS           | level_6      | Config storm control exceed mode of port 5. The current exceed mode is "drop" by admin on web (192.168.0.200). |
| 3          | 2006-01-03 05:04:59 | QoS           | level_6      | Config storm control mode of port 5. The current storm rate mode is kbps by admin on web (192.168.0.200).      |
| 4          | 2006-01-03 05:01:21 | User          | level_5      | Logout the CLI.  |
| 5          | 2006-01-03 04:54:32 | User          | level_5      | Login the CLI by admin on vty0 (192.168.0.200).  |
| 6          | 2006-01-03 04:27:59 | User          | level_5      | Logout the CLI.  |
| 7          | 2006-01-03 04:10:36 | User          | level_5      | Login the CLI by admin on vty0 (192.168.0.200).  |
| 8          | 2006-01-03 03:59:32 | User          | level_5      | Logout the CLI.  |
| 9          | 2006-01-03 03:48:02 | User          | level_5      | Login the CLI by admin on vty0 (192.168.0.200).  |
| 10         | 2006-01-03 03:40:56 | User          | level_5      | Logout the CLI.  |
| 11         | 2006-01-03 03:30:17 | NDDetec       | level_6      | Enable Gi1/0/2 as trusted port by admin on vty0 (192.168.0.200).   |
| 12         | 2006-01-03 03:23:08 | User          | level_5      | Login the CLI by admin on vty0 (192.168.0.200).  |
| 13         | 2006-01-03 03:18:54 | VLAN          | level_6      | Deleted VLAN 8 by admin on web (192.168.0.200).  |
| Total: 245 |                     |               |              |  |

Select a module and a severity to view the corresponding log information.

|                 |  |
|-----------------|--|
| <b>Time</b>     | Displays the time the log event occurred. To get the exact time when the log event occurs, you need to configure the system time on the <b>SYSTEM &gt; System Info &gt; System Time</b> Web management page. |
| <b>Module</b>   | Select a module from the drop-down list to display the corresponding log information.  |
| <b>Severity</b> | Select a severity level to display the log information whose severity level value is the same or smaller.  |
| <b>Content</b>  | Displays the detailed information of the log event.  |

## 2.2 Using the CLI

### 2.2.1 Configuring the Local Logs

Follow these steps to configure the local logs:

---

|        |  |
|--------|--|
| Step 1 | <b>configure</b><br>Enter global configuration mode.   |
| Step 2 | <b>logging buffer</b><br>Configure the switch to save system messages in log buffer. Log buffer indicates the RAM for saving system logs. Information in the log buffer will be lost when the switch is restarted. You can view the logs with <b>show logging buffer</b> command.  |
| Step 3 | <b>logging buffer level level</b><br>Specify the severity level of the log information that should be saved to the buffer.<br><i>level</i> : Enter the severity level ranging from 0 to 7. A lower value indicates a higher severity. Only log messages with a severity level value that is the same or lower than this will be saved. The default level is 6, indicating that the log information of levels 0 to 6 will be saved in the log buffer.                                       |
| Step 4 | <b>logging file flash</b><br>Configure the switch to save system messages in log file. Log file indicates the flash sector for saving system logs. Information in the log file will not be lost after the switch is restarted. You can view the logs with <b>show logging flash</b> command.   |
| Step 5 | <b>logging file flash frequency { periodic periodic   immediate }</b><br>Specify the frequency to synchronize the system logs in the log buffer to the flash.<br><i>periodic</i> : Specify the frequency ranging from 1 to 48 hours. By default, the synchronization process takes place every 24 hours.<br><i>immediate</i> : The system log file in the buffer will be synchronized to the flash immediately. This option means frequent operations on the flash and is not recommended. |
| Step 6 | <b>logging file flash level level</b><br>Specify the severity level of the log information that should be saved to the flash.<br><i>level</i> : Enter the severity level ranging from 0 to 7. A lower value indicates a higher severity. Only log messages with a severity level value that is the same or lower than this will be saved to the flash. The default level is 3, indicating that the log messages of levels 0 to 3 will be saved in the log flash.                           |
| Step 7 | <b>show logging local-config</b><br>View the configuration information of the local logs.  |
| Step 8 | <b>end</b><br>Return to privileged EXEC mode.  |
| Step 9 | <b>copy running-config startup-config</b><br>Save the settings in the configuration file.  |

---

The following example shows how to configure the local logs on the switch. Save logs of levels 0 to 5 to the log buffer, and synchronize logs of levels 0 to 2 to the flash every 10 hours:

```
Switch#configure
```

```
Switch(config)#logging buffer
```

```
Switch(config)#logging buffer level 5
```

```
Switch(config)#logging file flash
```

```
Switch(config)#logging file flash frequency periodic 10
```

```
Switch(config)#logging file flash level 2
```

```
Switch(config)#show logging local-config
```

| Channel | Level | Status | Sync-Periodic |
|---------|-------|--------|---------------|
| -----   | ----- | -----  | -----         |
| Buffer  | 5     | enable | Immediately   |
| Flash   | 2     | enable | 10 hour(s)    |
| Console | 5     | enable | Immediately   |
| Monitor | 5     | enable | Immediately   |

```
Switch(config)#end
```

```
Switch#copy running-config startup-config
```

## 2.2.2 Configuring the Remote Logs

You can configure up to four hosts to receive the switch's system logs. These hosts are called Log Servers. The switch will forward the log message to the servers once a log message is generated. To display the logs, the servers should run a log server software that complies with the syslog standard.

Follow these steps to set the remote log:

- 
- Step 1     **configure**  
           Enter global configuration mode.
-

- 
- Step 2     **logging host index *idx* host-ip level**
- Configure a remote host to receive the switch's system logs. The host is called Log Server. You can remotely monitor the settings and operation status of the switch through the log server.
- idx*: Enter the index of the log server. The switch supports 4 log servers at most.
- host-ip*: Enter the IP address of the log server.
- level*: Specify the severity level of the log messages sent to the log server. The range is from 0 to 7, and a lower value indicates a higher severity. Only log messages with a severity level value that is the same or lower than this will be sent. The default is 6, indicating that the log information of levels 0 to 6 will be sent to the log server.
- 
- Step 3     **show logging loghost [ *index* ]**
- View the configuration information of the log server.
- index*: Enter the index of the log server to view the corresponding configuration information. If no value is specified, information of all log hosts will be displayed.
- 
- Step 4     **end**
- Return to privileged EXEC mode.
- 
- Step 5     **copy running-config startup-config**
- Save the settings in the configuration file.
- 

The following example shows how to set the remote log on the switch. Enable log server 2, set its IP address as 192.168.0.148, and allow logs of levels 0 to 5 to be sent to the server:

**Switch#configure**

**Switch(config)# logging host index 2 192.168.0.148 5**

**Switch(config)# show logging loghost**

| Index | Host-IP       | Severity | Status  |
|-------|---------------|----------|---------|
| ----- | -----         | -----    | -----   |
| 1     | 0.0.0.0       | 6        | disable |
| 2     | 192.168.0.148 | 5        | enable  |
| 3     | 0.0.0.0       | 6        | disable |
| 4     | 0.0.0.0       | 6        | disable |

**Switch(config)#end**

**Switch#copy running-config startup-config**



# 3 Configuration Example

## 3.1 Network Requirements

The company network manager needs to monitor network of department A for troubleshooting.

Figure 3-1 Network Topology

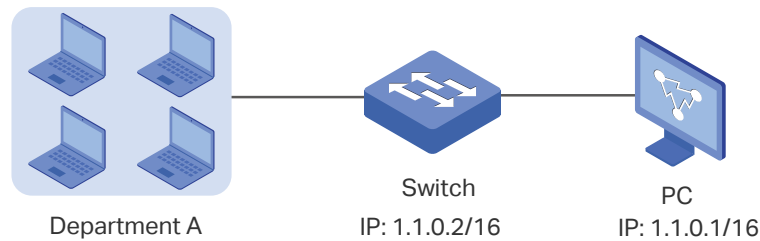

## 3.2 Configuration Scheme

The network manager can configure the PC as a log server to receive the switch’s system logs. Make sure the switch and the PC are reachable to each other; configure a log server that complies with the syslog standard on the PC and set the PC as the log server.

Demonstrated with T1500-28PCT, this chapter provides configuration procedures in two ways: using the GUI and Using the CLI.

## 3.3 Using the GUI

- 1) Choose the menu **MAINTENANCE > Logs > Remote Logs** to load the following page. Enable host 1, and set the PC’s IP address 1.1.0.1 as the server IP address, and the severity as level\_5; click **Apply**.

Figure 3-2 Configuring the Log Server

| Log Server Config                   |       |                   |          |                                       |                                      |
|-------------------------------------|-------|-------------------|----------|---------------------------------------|--------------------------------------|
| <input type="checkbox"/>            | Index | Server IP         | UDP Port | Severity                              | Status                               |
| <input type="checkbox"/>            |       | 1.1.0.1           |          | level_6                               | Enable                               |
| <input checked="" type="checkbox"/> | 1     | 1.1.0.1           | 514      | level_6                               | Enable                               |
| <input type="checkbox"/>            | 2     | 0.0.0.0           | 514      | level_6                               | Disable                              |
| <input type="checkbox"/>            | 3     | 0.0.0.0           | 514      | level_6                               | Disable                              |
| <input type="checkbox"/>            | 4     | 0.0.0.0           | 514      | level_6                               | Disable                              |
| Total: 4                            |       | 1 entry selected. |          | <input type="button" value="Cancel"/> | <input type="button" value="Apply"/> |

- 2) Click  to save the settings.

## 3.4 Using the CLI

Configure the remote log host.

```
Switch#configure
```

```
Switch(config)# logging host index 1 1.1.0.1 5
```

```
Switch(config)#end
```

```
Switch#copy running-config startup-config
```

### Verify the Configurations

```
Switch# show logging loghost
```

| Index | Host-IP | Severity | Status  |
|-------|---------|----------|---------|
| ----- | -----   | -----    | -----   |
| 1     | 1.1.0.1 | 5        | enable  |
| 2     | 0.0.0.0 | 6        | disable |
| 3     | 0.0.0.0 | 6        | disable |
| 4     | 0.0.0.0 | 6        | disable |

# 4 Appendix: Default Parameters

Default settings of maintenance are listed in the following tables.

Table 4-1 Default Settings of Local Logs

| Parameter                   | Default Setting |
|-----------------------------|-----------------|
| Status of Log Buffer        | Enabled         |
| Severity of Log Buffer      | Level_6         |
| Sync-Periodic of Log Buffer | Immediately     |
| Status of Log File          | Disabled        |
| Severity of Log File        | Level_3         |
| Sync-Periodic of Log File   | 24 hours        |

Table 4-2 Default Settings of Remote Logs

| Parameter | Default Setting |
|-----------|-----------------|
| Server IP | 0.0.0.0         |
| UDP Port  | 514             |
| Severity  | Level_6         |
| Status    | Disabled        |

# FCC Compliance Information Statement



Product Name: Gigabit Smart Switch

Model Number: T1500G-8T (TL-SG2008) / T1500-28PCT (TL-SL2428P) / TL-SG2210MP / TL-SG2210P

Responsible party:

TP-Link USA Corporation, d/b/a TP-Link North America, Inc.

Address: 145 South State College Blvd. Suite 400, Brea, CA 92821

Website: <https://www.tp-link.com/us/>

Tel: +1 626 333 0234

Fax: +1 909 527 6803

E-mail: [sales.usa@tp-link.com](mailto:sales.usa@tp-link.com)

This equipment has been tested and found to comply with the limits for a Class A digital device, pursuant to part 15 of the FCC Rules. These limits are designed to provide reasonable protection against harmful interference when the equipment is operated in a commercial environment. This equipment generates, uses, and can radiate radio frequency energy and, if not installed and used in accordance with the instruction manual, may cause harmful interference to radio communications. Operation of this equipment in a residential area is likely to cause harmful interference in which case the user will be required to correct the interference at his own expense.

This device complies with part 15 of the FCC Rules. Operation is subject to the following two conditions:

- 1) This device may not cause harmful interference.
- 2) This device must accept any interference received, including interference that may cause undesired operation.

Any changes or modifications not expressly approved by the party responsible for compliance could void the user's authority to operate the equipment.

We, **TP-Link USA Corporation**, has determined that the equipment shown as above has been shown to comply with the applicable technical standards, FCC part 15. There is no unauthorized change is made in the equipment and the equipment is properly maintained and operated.

Issue Date: 2020/01/01

## CE Mark Warning



This is a class A product. In a domestic environment, this product may cause radio interference, in which case the user may be required to take adequate measures.

## EU declaration of conformity

TP-Link hereby declares that the device is in compliance with the essential requirements and other relevant provisions of directives 2014/30/EU, 2014/35/EU, 2009/125/EC, 2011/65/EU and (EU)2015/863.

The original EU declaration of conformity may be found at <https://www.tp-link.com/en/ce>

## Industry Canada Statement

CAN ICES-3 (A)/NMB-3(A)

This device contains licence-exempt transmitter(s)/receiver(s) that comply with Innovation, Science and Economic Development Canada's licence-exempt RSS(s). Operation is subject to the following two conditions:

- (1) This device may not cause interference.
- (2) This device must accept any interference, including interference that may cause undesired operation of the device.

L'émetteur/récepteur exempt de licence contenu dans le présent appareil est conforme aux CNR d'Innovation, Sciences et Développement économique Canada applicables aux appareils radio exempts de licence. L'exploitation est autorisée aux deux conditions suivantes :

- 1) L'appareil ne doit pas produire de brouillage;
- 2) L'appareil doit accepter tout brouillage radioélectrique subi, même si le brouillage est susceptible d'en compromettre le fonctionnement.

## BSMI Notice

安全諮詢及注意事項

- 請使用原裝電源供應器或只能按照本產品注明的電源類型使用本產品。
- 清潔本產品之前請先拔掉電源線。請勿使用液體、噴霧清潔劑或濕布進行清潔。
- 注意防潮，請勿將水或其他液體潑灑到本產品上。
- 插槽與開口供通風使用，以確保本產品的操作可靠並防止過熱，請勿堵塞或覆蓋開口。

- 請勿將本產品置放於靠近熱源的地方。除非有正常的通風，否則不可放在密閉位置中。
- 請不要私自打開機殼，不要嘗試自行維修本產品，請由授權的專業人士進行此項工作。

此為甲類資訊技術設備，于居住環境中使用時，可能會造成射頻擾動，在此種情況下，使用者會被要求採取某些適當的對策。

#### 限用物質含有情況標示聲明書

| 產品元件名稱  | 限用物質及其化學符號 |         |         |             |             |               |
|---|------------|---------|---------|-------------|-------------|---------------|
|   | 鉛<br>Pb    | 鎘<br>Cd | 汞<br>Hg | 六價鉻<br>CrVI | 多溴聯苯<br>PBB | 多溴二苯醚<br>PBDE |
| PCB   | ○          | ○       | ○       | ○           | ○           | ○             |
| 外殼  | ○          | ○       | ○       | ○           | ○           | ○             |
| 電源供應板   | —          | ○       | ○       | ○           | ○           | ○             |
| 備考1. "超出0.1 wt %" 及 "超出0.01 wt %" 系指限用物質之百分比含量超出百分比含量基準值。<br>備考2. "○" 系指該項限用物質之百分比含量未超出百分比含量基準值。<br>備考3. "—" 系指該項限用物質為排除項目。 |            |         |         |             |             |               |



Продукт сертифіковано згідно с правилами системи УкрСЕПРО на відповідність вимогам нормативних документів та вимогам, що передбачені чинними законодавчими актами України.



## Korea Warning Statements

당해 무선설비는 운용중 전파혼신 가능성이 있음 .







## Safety Information

- Keep the device away from water, fire, humidity or hot environments.
- Do not attempt to disassemble, repair, or modify the device.
- Place the device with its bottom surface downward.

Please read and follow the above safety information when operating the device. We cannot guarantee that no accidents or damage will occur due to improper use of the device. Please use this product with care and operate at your own risk.

この装置は、クラス A 情報技術装置です。この装置を家庭環境で使用すると電波妨害を引き起こすことがあります。この場合には使用者が適切な対策を講ずるよう要求されることがあります。

## Explanation of the symbols on the product label

| Symbol  | Explanation   |
|---|---|
|    | AC voltage  |
|    | DC voltage  |
|    | Indoor use only.  |
|    | Polarity of output terminals  |
|    | Energy efficiency marking (Level VI)  |
|   | <b>RECYCLING</b><br>This product bears the selective sorting symbol for Waste electrical and electronic equipment (WEEE). This means that this product must be handled pursuant to European directive 2012/19/EU in order to be recycled or dismantled to minimize its impact on the environment. |
|  | User has the choice to give his product to a competent recycling organization or to the retailer when he buys a new electrical or electronic equipment.   |

## COPYRIGHT & TRADEMARKS

Specifications are subject to change without notice.  tp-link is a registered trademark of TP-Link Technologies Co., Ltd. Other brands and product names are trademarks or registered trademarks of their respective holders.

No part of the specifications may be reproduced in any form or by any means or used to make any derivative such as translation, transformation, or adaptation without permission from TP-Link Technologies Co., Ltd. Copyright © 2020 TP-Link Technologies Co., Ltd. All rights reserved.

<https://www.tp-link.com>