

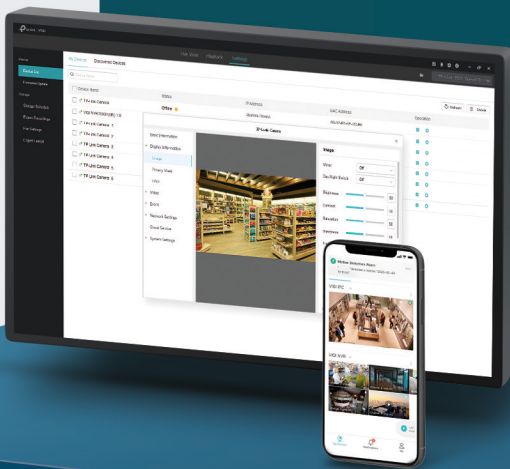

Security Never Shuts Down

VIGI Surveillance Solution

Retail | Education | Hospitality | Office | Accommodation | and More



VIGI Solution for Your Security

The VIGI professional surveillance system by TP-Link is dedicated to protecting the business that you've worked hard to build—whenever, wherever. Outstanding functions, reliable quality guarantees, and simplified installation work together to ensure your business safe and sound.

► Products / Management



Network Camera

Provides a myriad of easy-to-use surveillance options and smart detection features for vigilant security.



Network Video Recorder (NVR)

The nerve center of any surveillance system with extensive storage, simultaneous viewing, and more advanced features.



NVR UI / VIGI Security Manager / VIGI App

Seamlessly manage the NVR and cameras. Customize the management systems to suit your specific needs.

► Typical Application

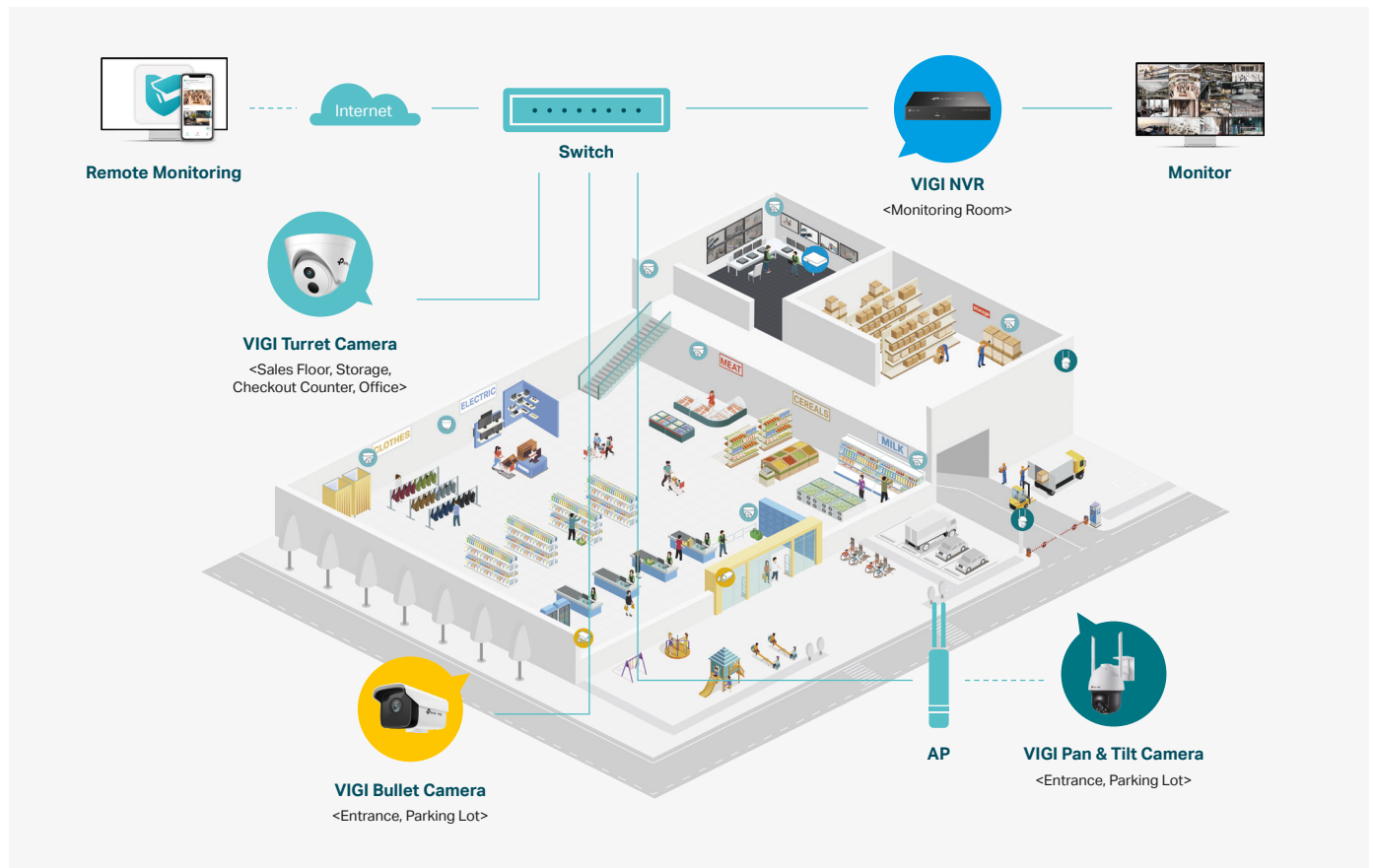

Note: For detailed industry solutions, please go to www.tp-link.com/business-networking/solution/

► Solution Features

Higher Security

Catch every detail with high resolution images and configure devices to detect events and abnormalities to instantly improve security.

Higher Efficiency

Simplifies monitoring and management by comprehensive functions and advanced coding technologies.

Wider Applicability

Multiple products and optional deployment methods suit every commercial application.

Higher Security

► Clear Images Under Any Conditions

Super High Definition

Upgraded from 2MP, VIGI provides 3MP or above definition to clearly view every details in the area.

Smart Video Enhancement

VIGI's professional technologies process image to greatly improve the image quality that is vital to your monitoring, including Smart IR, WDR, 3D DNR, and Night Vision.



3D DNR off



3D DNR on

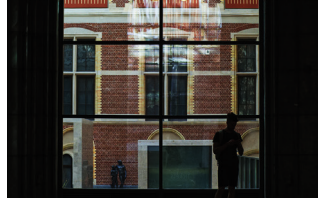

WDR off



WDR on



Night Vision off



Night Vision on



Smart IR off



Smart IR on

Colorful Night Vision*

Starlight: Provides clearer vision and more detail under low-light conditions via high-sensitivity sensor and large-aperture lens.

Full-Color: Obtains 24-hour detailed color even in pitch dark conditions via light compensation.



Night Vision



Starlight



Night Vision



Full-Color

► Smart Detection and Instant Notifications Let You Respond Quickly



Motion Detection

Get instant notifications when your camera detects motion.



Line-Crossing

Set a boundary and receive an alert anytime a person crosses it from either or both directions.



Human Detection*

Smarter security alerts focus on human movement instead of flying insects and leaves.

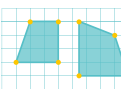

Area Intrusion

Set customized activity zones around key areas for more focused monitoring.



Camera Tampering

Receive alerts when someone obstructs the camera.

► Two-Way Audio* Lets You Greet Visitors and Ward Off Invaders

With voice intercom support, carry two-way conversations with the visitors and alert intruders without having to leave your chair.

*These features may be being developed and may vary in different models. Please check the details in Product Specifications.

Higher Efficiency

Comprehensive Monitoring for Easier Security Management

Real-Time Live View

Sharp image resolution up to 5/8MP and an 8/16-channel display ensure you capture every detail, from every angle.

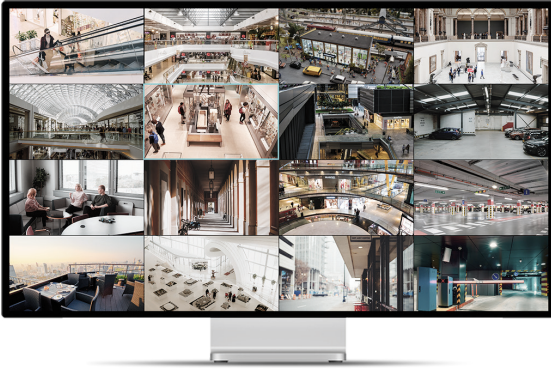

24/7 Continuous Recording

Stores up to 10 TB of footage from connected cameras to secure your data for quick, convenient access.†

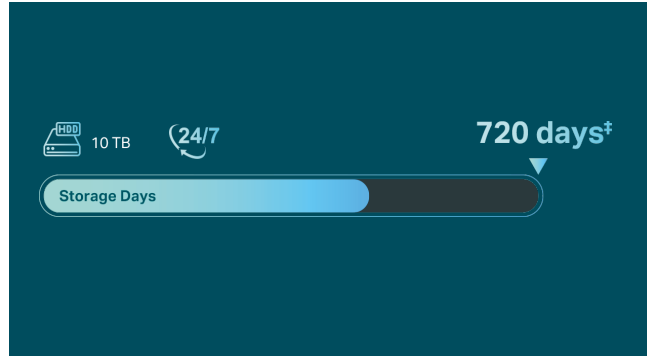

Quick Lookup and Playback

Find the target footage easily by date, event types, and tags. Replay with variable playback speeds to quickly review footage.

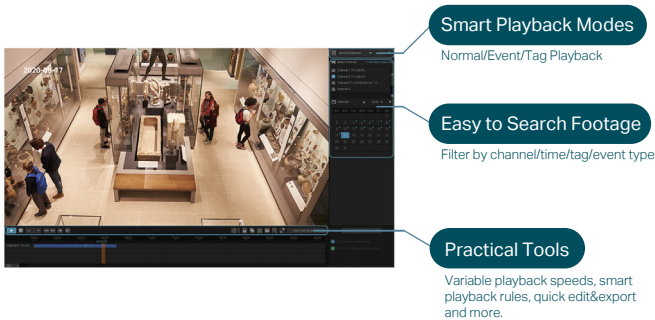

Smart Video Coding^Δ

Processes compressed crystal-clear video faster, which also saves disk space, eases your network load, and reduces networking cost without sacrificing image quality.

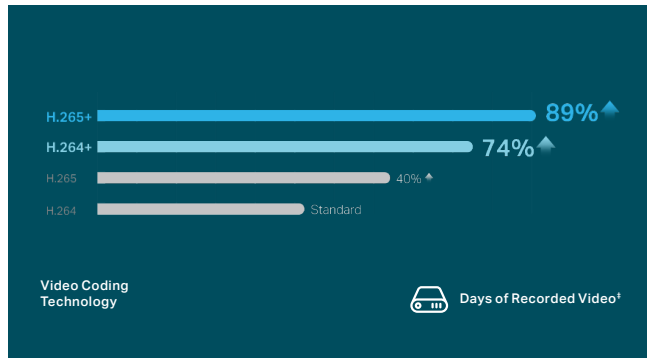

Seamless Management for Local and Remote Monitoring

Customize the management systems to suit your specific needs, and seamlessly manage the NVR and cameras via the NVR user interface, VIGI app, and VIGI Security Manager.

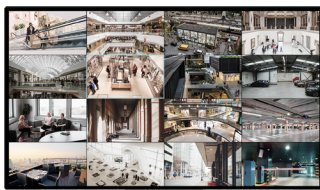

VIGI NVR UI



VIGI Security Manager

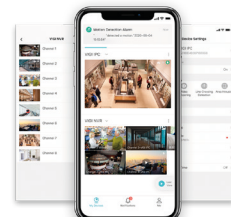

VIGI App

†HDD is not included.

‡Calculations based on laboratory testing using a 3MP VIGI camera and an 8-channel VIGI NVR. Actual performance may vary according to the amount of activity recorded, resolution, and other variables.

ΔThe standards VIGI products support vary from models. For more information, please contact local TP-Link representative.

Wider Applicability

► Varied Focal Lengths for Different Applications*

VIGI cameras come with multiple lens versions to better suit your security needs, whether you need a wide angle lens to cover an enclosed space or a high millimeter lens for longer distances in open spaces like a parking lot.

Field of View:

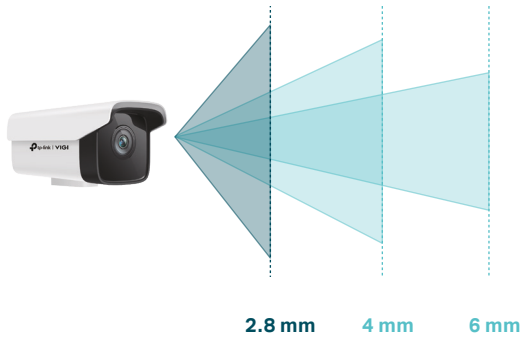

Distance and Detail

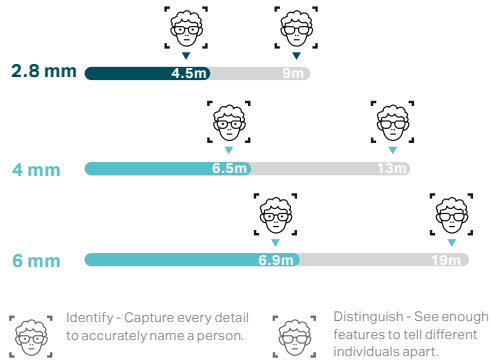

► Flexible Network Deployment & Power Supply for Diverse Scenarios

PoE/DC*

VIGI cameras offer more flexible deployment, making your wiring easy and convenient.

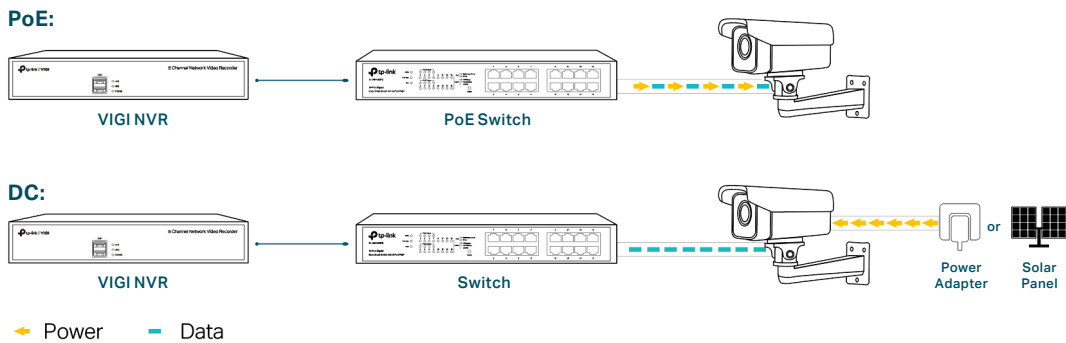

Wi-Fi/4G*

Enjoy more options to build up your surveillance network and adapt to various scenarios.

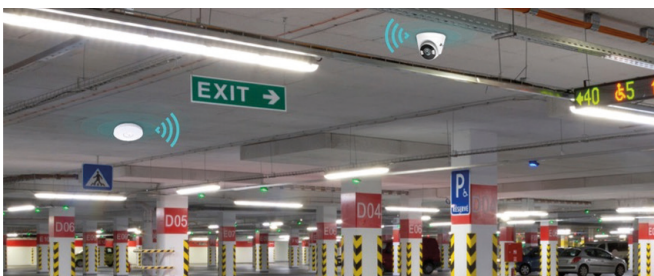

► High Compatibility with ONVIF Supported

With ONVIF supported, you can easily coordinate VIGI cameras and NVR with products from other brands to establish a powerful and varied surveillance network.**

*These features may be being developed and may vary in different models. Please check the details in Product Specifications.
**We recommend using VIGI NVR with VIGI cameras for the best performance.

Scenario-Based Solution Design

VIGI supports a variety of business scenarios, including hospitality, retail, education and office. VIGI surveillance system provides many scenario-based projects and rich benefits that can satisfy different needs in various environments, with our high-quality technologies, outstanding functions, and simplified installation and management.



Outdoor Area (e.g. Parking Lot)

- ✓ Super HD Video
- ✓ Event Detection
- ✓ Flexible Cruise Scan
- ✓ Wi-Fi/4G Connections
- ✓ Two-Way Audio
- ✓ IP66/67

Recommended Products	Specifications
VIGI C300HP*	3MP; 4mm/6mm Lens; PoE ; IP67; ONVIF
VIGI C340HPWSM*	4MP; 4mm/6mm Lens; PoE ; IP67; Starlight ; Full-Color ; Built-In Mic; ONVIF
VIGI C340HWSM-W*	4MP; 4mm/6mm Lens; Wi-Fi ; IP67; Starlight ; Full-Color ; Built-In Mic; ONVIF
VIGI C540HPWSM	4MP; 4mm Lens; Pan & Tilt ; PoE ; IP66; Starlight ; Full-Color ; Built-In Mic; ONVIF
VIGI C540HWSM-W	4MP; 4mm Lens; Pan & Tilt ; Wi-Fi ; IP66; Starlight ; Full-Color ; Built-In Mic; ONVIF
VIGI C540HWSA-G	4MP; 4mm Lens; Pan & Tilt ; 4G ; IP66; Starlight ; Full-Color ; Built- In Mic&Speaker ; ONVIF
VIGI C542HPWSA	4MP; 4mm Lens; Pan & Tilt ; PoE ; IP66; Starlight ; Full-Color ; Built- In Mic&Speaker ; ONVIF



Indoor Area (e.g. Storage)

- ✓ Super HD Video
- ✓ Event Detection
- ✓ Wi-Fi Connections
- ✓ Flexible Power Supply

Recommended Products	Specifications
VIGI C400HP*	3MP; 2.8mm/4mm Lens; PoE ; ONVIF
VIGI C440HWSM-W*	4MP; 2.8mm/4mm Lens; Wi-Fi ; Starlight ; Full-Color ; Built- In Mic ; ONVIF



Monitoring Room





- ✓ Real-Time Live View
- ✓ Mass Storage
- ✓ Remote Management
- ✓ Practical Playback
- ✓ Two-Way Audio

Recommended Products	Specifications
VIGI NVR1008H	8 Channels ; 1 HDD (10TB); 5MP; Live View; Playback; ONVIF
VIGI NVR1016H	16 Channels ; 1 HDD (10TB); 8MP ; Live View; Playback; ONVIF

*These cameras have multiple models based on varied focal lengths. For more information, please contact your local TP-Link representative.

Product Specifications

VIGI Network Camera*



	VIGI Bullet Camera			VIGI Turret Camera	
Product**	VIGI C300HP	VIGI C340HPWSM	VIGI C340HWSM-W	VIGI C400HP	VIGI C440HWSM-W
Product Image					
Pixels	3MP	4MP	4MP	3MP	4MP
Focal Length	4mm/6mm	4mm/6mm	4mm/6mm	2.8mm/4mm	2.8mm/4mm
Video Compression	H.265+/H.264+/H.265/H.264	H.265+/H.264+/H.265/H.264	H.265/H.264	H.265+/H.264+/H.265/H.264	H.265/H.264
IR Range	30 m				
Min. Illumination	Color: 0.1 Lux; 0 Lux with IR	Color: 0.04 Lux; 0 Lux with IR	Color: 0.04 Lux; 0 Lux with IR	Color: 0.1 Lux; 0 Lux with IR	Color: 0.04 Lux; 0 Lux with IR
Power Supply	DC 12V; PoE (802.3af/at, class 0)	DC 12V; PoE (802.3af/at, class 0)	DC 12V	DC 12V; PoE (802.3af/at, class 0)	DC 12V
Built-In Mic&Speaker	-	Mic	Mic	-	Mic
Wi-Fi/4G	-	-	Wi-Fi	-	Wi-Fi
Protection Level	IP67	IP67	IP67	-	-
ONVIF	•				
Starlight	-	•	•	-	•
Full-Color	-	•	•	-	•
SmartVid	Smart IR/WDR/3D DNR/Night Vision				
Smart Detection	Motion Detection, Line-Crossing, Area Intrusion, Camera Tampering	Human Detection, Motion Detection, Line-Crossing, Area Intrusion, Camera Tampering		Motion Detection, Line-Crossing, Area Intrusion, Camera Tampering	Human Detection, Motion Detection, Line-Crossing, Area Intrusion, Camera Tampering

	VIGI Pan & Tilt Camera			
Product	VIGI C540HPWSM	VIGI C540HWSM-W	VIGI C540HWSA-G	VIGI C542HPWSA
Product Image				
Pixels	4MP			
Focal Length	4mm			
Video Compression	H.265+/H.264+/H.265/H.264	H.265/H.264	H.265/H.264	H.265+/H.264+/H.265/H.264
IR Range	30 m			
Min. Illumination	Color: 0.04 Lux; 0 Lux with IR			
Power Supply	DC 12V; PoE (802.3at, class 4)	DC 12V	DC 12V	DC 12V; PoE (802.3at, class 4)
Built-In Mic&Speaker	Mic	Mic	•	•
Wi-Fi/4G	-	Wi-Fi	4G	-
Protection Level	IP66			
ONVIF	•			
Starlight	•			
Full-Color	•			
SmartVid	Smart IR/WDR/3D DNR/Night Vision			
Smart Detection	Human Detection, Motion Detection, Line-Crossing, Area Intrusion, Camera Tampering			

*Products may be being developed. The images and specifications are for reference only.

**These cameras have multiple models based on varied focal lengths. For more information, please contact your local TP-Link representative.

VIGI Network Video Recorder

	Network Video Recorder	
Product	VIGI NVR1008H	VIGI NVR1016H
Product Image		
Network Video Input	8 channels	16 channels
Network Incoming Bandwidth	80 Mbps	80 Mbps
Video Compression	H.265+/H.265/H.264+/H.264	H.265+/H.265/H.264+/H.264
Recorded Resolution	Up to 5MP	Up to 8MP
Video Interface	1 HDMI; 1 VGA	1 HDMI; 1 VGA
Hard Drive	1 SATA interface (Up to 10TB)	1 SATA interface (Up to 10TB)
Power Supply	DC 12 V, 1.5 A	DC 12 V, 1.5 A

More Information

VIGI continues to develop advanced features for safer, more reliable and professional surveillance solutions. We will be releasing more products with powerful features in the near future.

► More Products Coming Soon*



Dome Camera

Indoor cameras with vandal-proof and flexible pan & tilt functions.



Panoramic Camera

Indoor cameras for all-around monitoring.



Outdoor Camera

Outdoor cameras with digital zoom and deep-learning AI.



32/48/64-Channel NVR

NVRs support more channels and larger storage.

► More Features Coming Soon*



People Counting (AI)

Counts crowds to better understand your consumers and customize your strategy.



Perimeter Protection (AI)

Maximize the efficiency of your perimeter security by intelligently filtering false alerts.



Varifocal Lens

High-magnification zoom to view details in the whole area.



License Plate Recognition (AI)

Recognizes license plates automatically and accurately for effective access control and parking management.



Face Recognition (AI)

Smart facial AI systems improve access management and support better operational goals.



Vandal-Proof

Durable outer shells provide more reliable and focused security protection.

*Products and features are being developed. The information is for reference only.

TP-Link Corporation Limited

E-Mail: info@tp-link.com
Homepage: www.tp-link.com

Specifications are subject to change without notice. TP-Link and VIGI are trademarks of TP-Link Corporation Limited. Other brands and product names are trademarks or registered trademarks of their respective holders. Copyright © 2021 TP-Link Corporation Limited. All rights reserved.

Actual products may vary from image.

PN: 8392501121