

# User Guide

## EAP Controller Software

# Content

<b>1 Quick Start</b> .....	<b>1</b>
<b>1.1 Determine the Network Topology</b> .....	<b>2</b>
Manage EAPs in the LAN .....	2
Manage EAPs in Different Network Segment .....	2
<b>1.2 Install the EAP Controller</b> .....	<b>3</b>
System Requirements.....	3
Install the EAP Controller.....	3
<b>1.3 Inform the EAPs of the Controller Host's Address</b> .....	<b>4</b>
<b>1.4 Basic Configurations and Login</b> .....	<b>5</b>
Launch the EAP Controller .....	5
Do the Basic Configurations.....	5
Log into the Management Interface .....	7
<b>1.5 Create Sites and Adopt EAPs</b> .....	<b>7</b>
Create Sites .....	8
Adopt the EAPs .....	8
<b>1.6 Monitor and Manage the EAPs</b> .....	<b>9</b>
<b>2 Monitor and Manage the Network</b> .....	<b>11</b>
<b>2.1 Monitor the Network with Map</b> .....	<b>12</b>
Add a Map.....	12
Monitor the EAPs on the Map.....	14
<b>2.2 View the Statistics of the Network</b> .....	<b>15</b>
View the Client Distribution on SSID.....	15
Have a Quick Look at EAPs and Clients .....	16
View Current Usage-Top APs .....	16
View Recent Activities.....	16
<b>2.3 Monitor and Manage the EAPs</b> .....	<b>17</b>
Manage the EAPs in Different Status .....	17

View the Detailed Information of EAPs .....	18
Manage the EAPs in the Action Column .....	18
<b>2.4 Monitor and Manage Clients.....</b>	<b>19</b>
View the Current Information of Clients .....	19
Manage Clients in the Action Column.....	20
<b>2.5 View Clients Statistics During the Specified Period .....</b>	<b>20</b>
Select a Specified Period .....	20
View the History Information of Clients .....	21
Manage Clients in the Action Column.....	21
<b>2.6 Manage the Rogue APs List.....</b>	<b>21</b>
Manage the Untrusted Rogue APs List.....	22
Manage the Trusted Rogue APs List.....	22
<b>2.7 View Past Guest Authorization .....</b>	<b>23</b>
<b>2.8 View Logs.....</b>	<b>24</b>
<b>2.9 View Alerts.....</b>	<b>24</b>
<b>3 Configure the EAPs Globally.....</b>	<b>25</b>
<b>3.1 Wireless Network.....</b>	<b>26</b>
Add Wireless Networks .....	26
Configure Advanced Wireless Parameters.....	30
Configure Band Steering .....	32
<b>3.2 Access Control.....</b>	<b>33</b>
<b>3.3 Portal Authentication .....</b>	<b>34</b>
No Authentication .....	35
Simple Password .....	36
Hotspot .....	37
External Radius Server .....	41
External Portal Server.....	42
<b>3.4 Free Authentication Policy .....</b>	<b>43</b>
<b>3.5 MAC Filter .....</b>	<b>44</b>

3.6	Scheduler .....	46
3.7	QoS .....	48
3.8	System .....	51
	Reboot Schedule .....	51
	Log Setting .....	51
	Device Account .....	53
	LED .....	53
	Country/Region .....	54
	Backup&Restore .....	54
	Batch Upgrade .....	54
<b>4</b>	<b>Configure the EAPs Separately.....</b>	<b>56</b>
4.1	View the Information of the EAP .....	57
	Overview .....	57
	LAN .....	57
	Radio .....	58
4.2	View Clients Connecting to the EAP .....	58
	User .....	58
	Guest .....	59
4.3	Configure the EAP .....	59
	Basic Config .....	59
	IP Setting .....	60
	Radio .....	60
	Load Balance .....	62
	WLANs .....	62
	Rouge AP Detection .....	63
	Forget this AP .....	63
<b>5</b>	<b>Manage the EAP Controller.....</b>	<b>64</b>
5.1	Information About the Software .....	65

5.2	User Account .....	65
5.3	Controller Settings .....	66
	Configure Controller Hostname/IP .....	66
	Configure Mail Server .....	67
<b>6</b>	<b>Application Example .....</b>	<b>68</b>
6.1	Basic Configuration .....	69
6.2	Advanced Settings .....	69
	Monitor the EAPs with Map.....	69
	Configure Portal Authentication .....	70
	Create a SSID for the Employees.....	72
	Configure Scheduler .....	73

# 1 Quick Start

The EAP Controller is a management software for the TP-LINK EAP devices. It allows you to centrally manage your EAP devices using a web browser. You can configure EAPs in batches and conduct real-time monitoring of each EAP in the network.

Follow the steps below to complete the basic settings of the EAP Controller.

- 1. Determine the Network Topology*
- 2. Install the EAP Controller Software*
- 3. Inform the EAPs of the Controller Host's Address*
- 4. Basic Configurations and Login*
- 5. Create Sites and Adopt the EAPs*
- 6. Monitor and Manage the EAPs*

# 1.1 Determine the Network Topology

You can use the EAP Controller to centrally manage the EAPs in the LAN or in different network segment.

## Manage EAPs in the LAN

If you want to manage the EAPs with a host in the LAN, refer to the following network topology.

A router acts as a DHCP server to assign IP addresses to EAPs and clients. In the LAN, only one host needs to install EAP Controller. The host is called as Controller Host. And the other hosts in the same LAN can access the Controller Host to manage the network. In this topology, you can visit EAP Controller interface from Host B by entering "192.168.0.100: 8043" in a web browser. It's recommended to set a static IP address to the Controller Host for the convenient login to the EAP Controller interface.

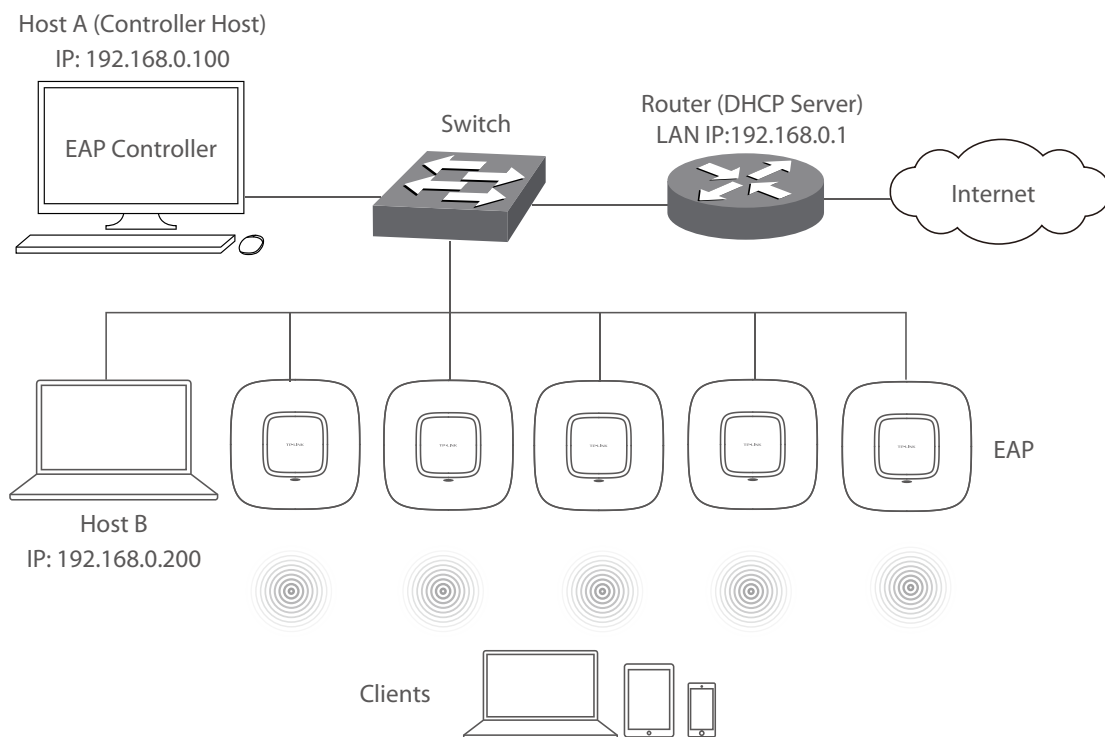

**Note:**

The EAP Controller must be running all the time when you manage the network.

## Manage EAPs in Different Network Segment

If the Controller Host needs to manage EAPs in different network segment, refer to the following topology.

A router acts as a DHCP server to assign IP addresses to EAPs and clients. The Controller Host and the EAP devices are connected to the Router's different network segments. To

help the EAPs find the Controller Host and be managed, EAP Discover Utility should be installed in the Host B which is in the same LAN with the EAPs. Please refer to [1.3 Inform the EAPs the Controller Host's Address](#) for detailed instructions.

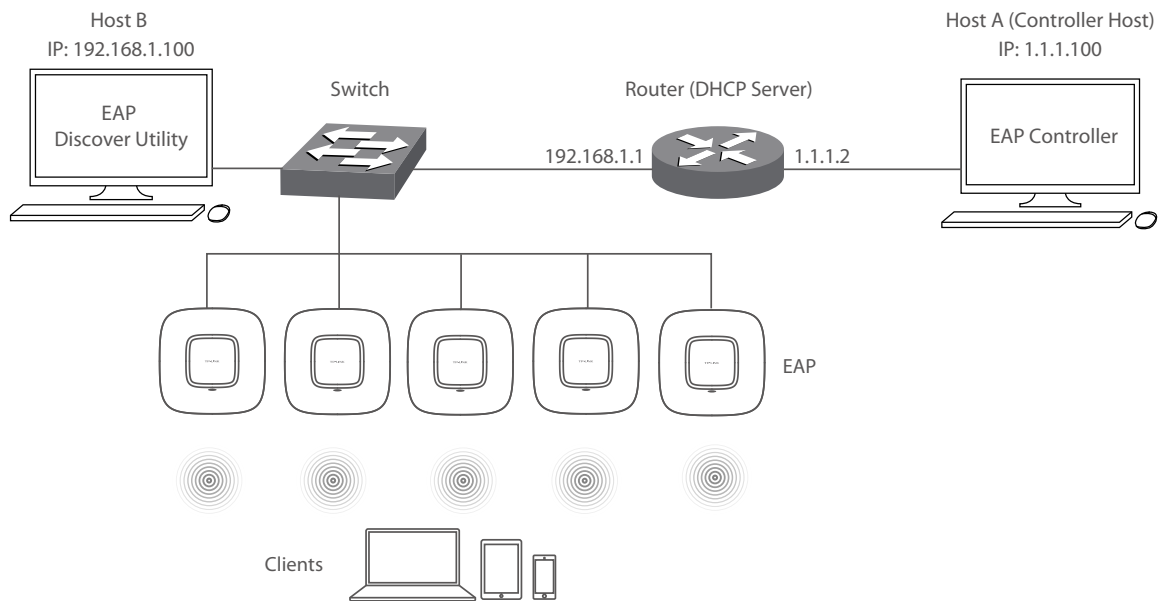

## 1.2 Install the EAP Controller

Make sure the Controller host meets the following system requirements and properly install the EAP Controller software.

### System Requirements

**Operating System:** Microsoft Windows XP/Vista/7/8/10.

**Web Browser:** Mozilla Firefox 32 (or above), Google Chrome 37 (or above), Opera 24 (or above), or Microsoft Internet Explorer 8-11.

#### Note

We recommend you deploy the EAP controller on a 64-bit operating system to guarantee the software stability.

### Install the EAP Controller

Get the installation file of EAP Controller on the resource CD provided with your EAP device or download it from our website <http://www.tp-link.com/en/support/download/>. Then follow the on-screen instructions to properly install the EAP Controller software. After successful installation, a shortcut icon  of the EAP Controller will be created on your desktop.



## 1.3 Inform the EAPs of the Controller Host's Address

If your Controller Host is in the same LAN with the EAPs, you can skip this section.

If you want to manage EAPs in different network segment with your Controller Host, please follow the steps below to help the EAPs find the Controller Host.

1. Install the EAP Controller on the computer that is in the same LAN with the EAPs. The EAP Discover Utility is installed automatically in the EAP Controller installation process.
2. Go to the installation path of the EAP Controller to find the EAP Discover Utility.
3. Open the EAP Discovery Utility and the following window will pop up. This window shows the information of all EAPs in the same LAN.

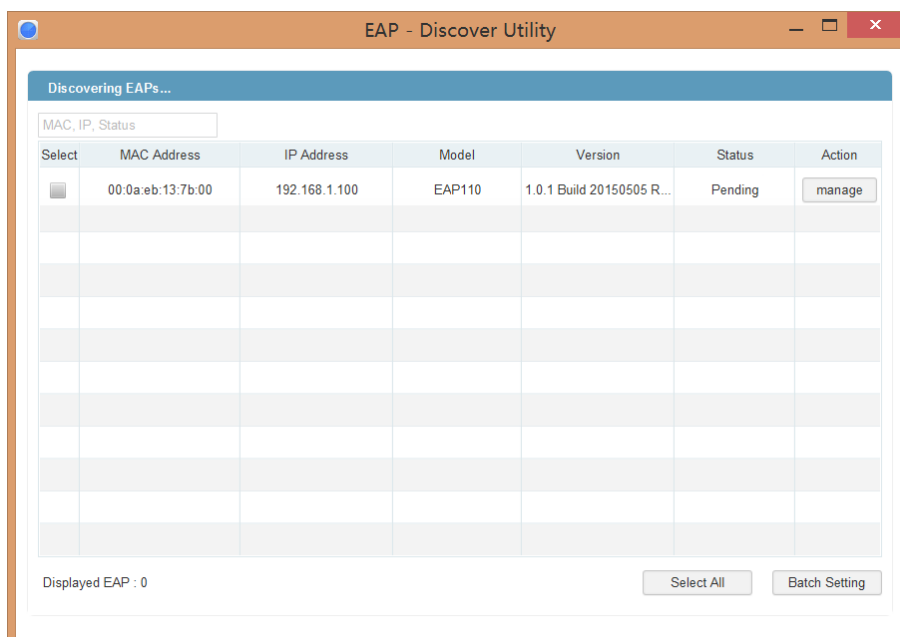

4. Click **manage** in the **Action** column or select multiple EAPs and click **Batch Setting**.

The screenshot shows a dialog box titled "Device Information". It contains the following fields and values:

- Status: Pending
- Model: EAP110
- IP Address: 192.168.1.100
- MAC Address: 00:0a:eb:13:7b:00
- Controller Hostname/IP:
- Username:
- Password:

At the bottom of the dialog box, there are two buttons: "Apply" and "Cancel".

5. Enter the Controller hostname or IP address.

6. Enter the EAP's username and password (both are admin by default).
7. Click **Apply** to inform the EAP of the Controller's hostname or IP address.

## 1.4 Basic Configurations and Login

Launch the software on the Controller Host and follow the instructions to complete the basic configurations, and then you can log in to the management interface.

### Launch the EAP Controller

Launch the EAP Controller and the following window will pop up. You can click **Hide** to hide this window but do not close it. After a while, your web browser will automatically open.

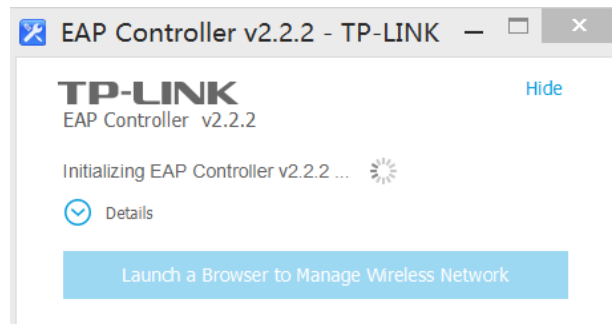

#### Note:

- If your browser does not open, please click **Launch a Browser to Manage Wireless Network**.
- If it opens but prompts a problem with the website's security certificate, please click **Continue to this website**.

### Do the Basic Configurations

In the web browser you can see the configuration page. Follow the steps below and provide the information required.

1. Select your country or region and click **Next**.

A configuration wizard interface showing a progress bar with four steps: 1. Region, 2. Wireless Settings, 3. User Account, and 4. Summary. Step 1 is highlighted with a blue circle and arrow. Below the progress bar, there is a label 'Region:' followed by a dropdown menu with 'China' selected. At the bottom right, there is a blue button labeled 'Next'.

2. Set the SSID name (wireless network name) and password for the EAPs which will be managed. The EAP Controller will create two wireless networks, a 2.4GHz one and a 5GHz one both encrypted in the WPA2-PSK mode. Click **Next**.

A configuration wizard interface showing a progress bar with four steps: 1. Region, 2. Wireless Settings, 3. User Account, and 4. Summary. Step 2 is highlighted with a blue circle and arrow. Below the progress bar, there are two input fields: 'SSID Name:' with the value 'SSID1' and '(1-32 characters)' to its right, and 'Password:' with the value '12345678' and '(WPA2-PSK)' to its right. At the bottom, there are two blue buttons: 'Back' and 'Next'.

3. Configure the admin name and password to create an administrator account. Specify the email address to receive the notification emails and reset your password if necessary. Click **Next**.

A configuration wizard interface showing a progress bar with four steps: 1. Region, 2. Wireless Settings, 3. User Account, and 4. Summary. Step 3 is highlighted with a blue circle and arrow. Below the progress bar, there are four input fields: 'Admin Name:' with the value 'Administrator1' and '(4-32 characters)' to its right; 'E-mail:' with the value 'Admin1@example.com' and '(user@example.com)' to its right; 'Password:' with a masked value '\*\*\*\*\*' and '(6-32 characters, only numbers and letters.)' to its right; and 'Confirm:' with a masked value '\*\*\*\*\*' and '(repeat password)' to its right. At the bottom, there are two blue buttons: 'Back' and 'Next'.

**Note:**

After logging into the EAP Controller, please set a mail server so that you can receive the notification emails and reset your password if necessary. Please refer to [Configure Mail Server](#).

4. Review your settings and click **Finish** to save the configurations.

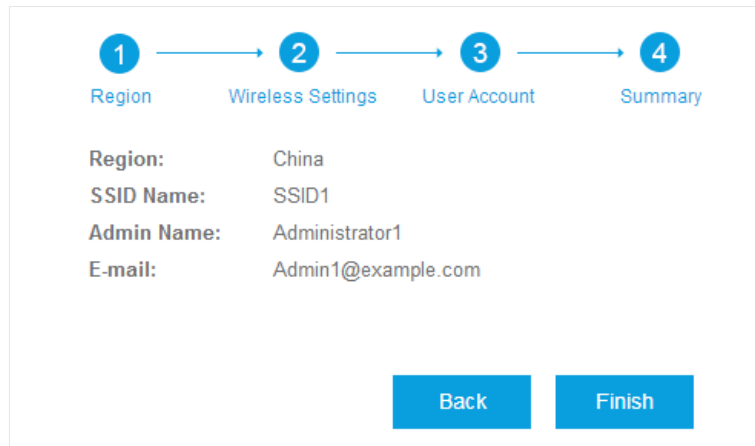

## Log into the Management Interface

Once the basic configuration is finished, the browser will be redirected to the following page. Please log into the management interface of EAP Controller with the username and password you have set in the basic configuration.

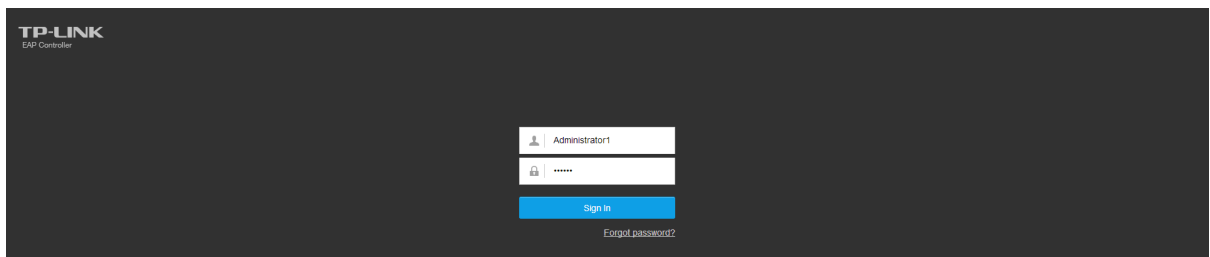

**Note:**

In addition to the Controller Host, other computers in the same LAN can also manage EAP devices via remote access to the Controller Host. For example, when the IP address of the Controller Host is 192.168.0.100 and the EAP Controller is running normally on this host, you can enter **https://192.168.0.100:8043/login**, or **https://192.168.0.100:8043**, or **http://192.168.0.100:8088** in the web browser of other computers in the same LAN to log into the management interface and manage EAP devices.

## 1.5 Create Sites and Adopt EAPs

The EAP Controller can manage multiple EAP networks, which are called sites. Each site has its own configurations. The multiple sites are logically separated, and the initial site is named **Default**. If you have no need to manage EAPs on different sites, you can use the default site and skip the **Create Sites** section. However, adopting the pending EAPs is a necessary step to manage the EAPs.

## Create Sites

Follow the steps below to add sites.

1. Click **Sites: Default** in the top left corner of the page and select **Add/Edit Site**, and then the following window will pop up.



The 'Configure Site' dialog box shows a table with one row for 'Default'. There is an 'Add' button in the top right corner and a 'GO' button at the bottom right.

Site Name	Action
Default	

2. Click **+ Add** and set a name for the site.

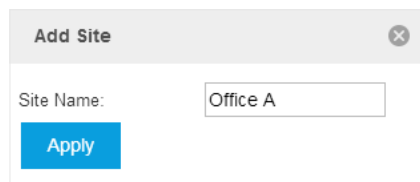

The 'Add Site' dialog box has a text input field for 'Site Name' containing 'Office A' and an 'Apply' button.

3. Click **Apply** to create the site.

## Adopt the EAPs

The EAP Controller can discover all EAP devices currently connected in the network and display their connection statuses on the management interface. As shown below, all the EAPs are in the **Pending** status by default. Only the **Connected** EAPs could be managed, so you need to adopt the **Pending** ones to change their status to **Connected**.

Follow the steps below to adopt EAPs on a specific site.

1. Select a site and go to **Access Points > Pending**.

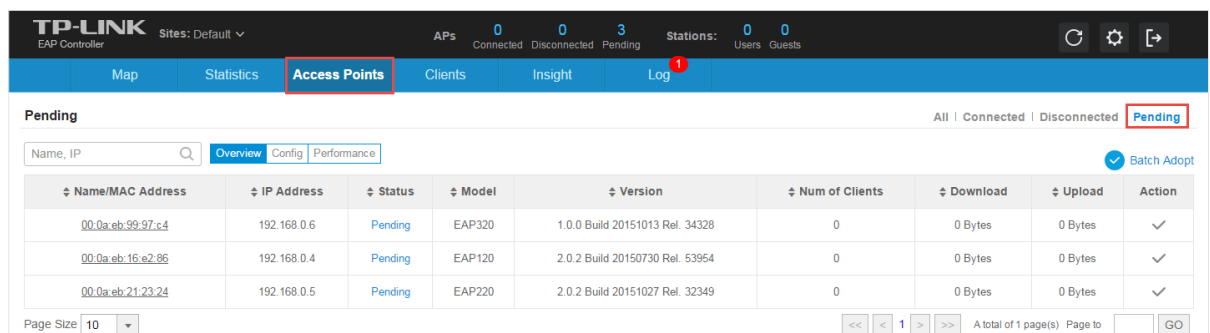

The screenshot shows the TP-LINK EAP Controller interface. The 'Access Points' tab is selected, and the 'Pending' sub-tab is active. A table lists three EAP devices with their MAC addresses, IP addresses, and status (all Pending). The 'Batch Adopt' button is visible in the top right of the table area.

Name/MAC Address	IP Address	Status	Model	Version	Num of Clients	Download	Upload	Action
00:0a:eb:99:97:c4	192.168.0.6	Pending	EAP320	1.0.0 Build 20151013 Rel. 34328	0	0 Bytes	0 Bytes	✓
00:0a:eb:16:e2:86	192.168.0.4	Pending	EAP120	2.0.2 Build 20150730 Rel. 53954	0	0 Bytes	0 Bytes	✓
00:0a:eb:21:23:24	192.168.0.5	Pending	EAP220	2.0.2 Build 20151027 Rel. 32349	0	0 Bytes	0 Bytes	✓

2. Click ✓ in the **Action** column and enter the username and password of the EAPs (both admin by default). You can also click  **Batch Adopt** to adopt all the **Pending** EAPs.

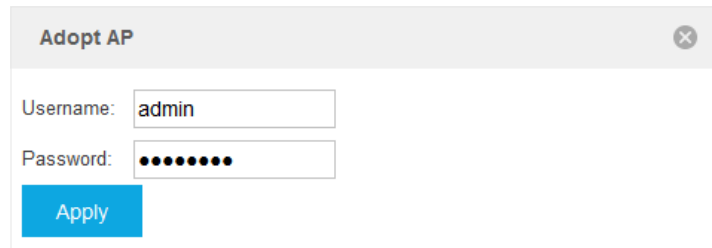

The 'Adopt AP' dialog box contains the following fields and controls:

- Username:** Input field containing 'admin'
- Password:** Input field containing 10 dots
- Apply:** Blue button

3. Click **Apply** to adopt the EAPs.
4. After a while, the EAPs will be successfully adopted. The EAPs' username and password will become the same as those of the Controller's administrator account you created in the [Basic Configuration](#).

 **Note**



If you want to change the EAPs' username and password, please refer to [Device Account](#).

## 1.6 Monitor and Manage the EAPs

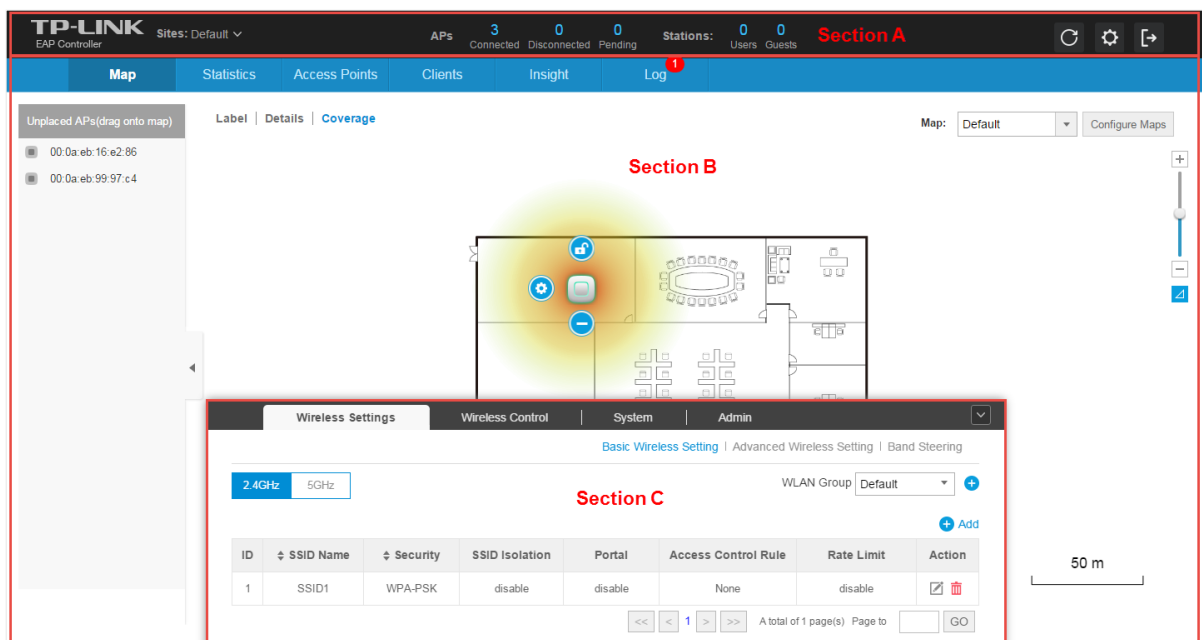
When all the configurations above are finished, you can centrally monitor and manage the EAPs via the EAP Controller's management interface. The management interface is mainly divided into three sections as the following screen.





The screenshot shows the TP-LINK EAP Controller management interface. It features a top navigation bar with 'Map', 'Statistics', 'Access Points', 'Clients', 'Insight', and 'Log'. A central map area displays a floor plan with a highlighted area labeled 'Section B'. A bottom panel, labeled 'Section C', shows the 'Basic Wireless Setting' configuration for the 2.4GHz band. The table below lists the configuration details:

ID	SSID Name	Security	SSID Isolation	Portal	Access Control Rule	Rate Limit	Action
1	SSID1	WPA-PSK	disable	disable	None	disable	 

---

### Section A

In Section A, you can check the status of EAPs and clients in the network. Also, you can click  to refresh the current page, click  to globally configure the wireless network, and click  to sign out from the management interface.

Furthermore, the **Sites** allows you to group your EAPs and manage them in batches. To configure sites, refer to [Create Sites](#).

---

### Section B

In Section B, you can centrally monitor and manage the EAPs and clients.

---

### Section C

In Section C, you can globally configure the wireless network. The global configuration results will take effect on all the adopted EAPs.

---

## 2 Monitor and Manage the Network

With the EAP Controller you can monitor the EAP devices and centrally manage your wireless network. This chapter includes the following sections:

- *Monitor the Network with the Map*
- *View the Statistics of the Network*
- *Monitor and Manage EAPs*
- *Monitor and Manage Clients*
- *View Clients Statistics during the Specified Period*
- *Manage the Rogue APs List*
- *View Past Guest Authorization*
- *View Logs*
- *View Alerts*



## 2.1 Monitor the Network with the Map

The EAP Controller allows you to upload your local map images and monitor the status and coverage range of each EAP device with the map. When you initially launch the EAP Controller, a default map is displayed. The legend at the bottom of the map shows the scale of the map.

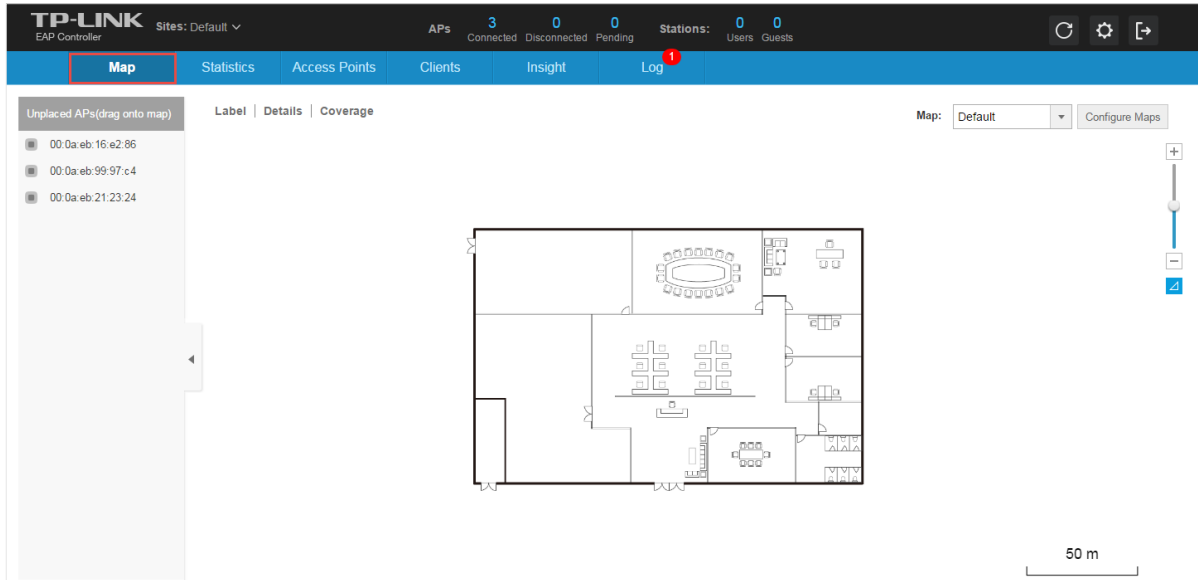

### Add a Map

To add a custom map, you must first create the image in .jpg, .gif, or .png file format. And then follow the steps below to add a map.

1. Click **Configure Maps** on the upper right corner of map and click **Add**.

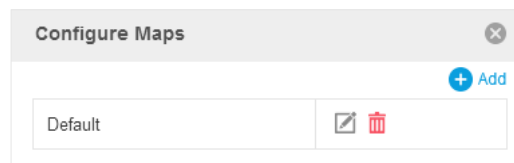

2. Enter the map description, select your customized map image, and click **Create**.

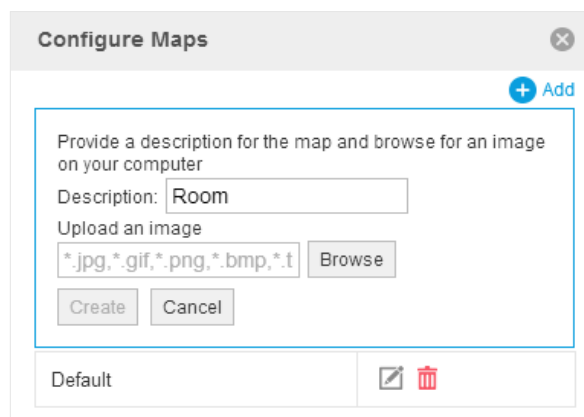

3. Select your local map from the drop-down list on the upper right corner of map area.

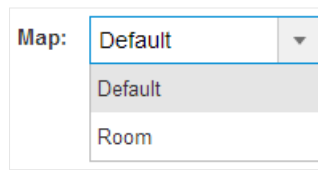

4. Click . Draw a line on the map and enter the distance that the line represents. Then the EAP Controller will compute and generate the map scale automatically based on your configuration.

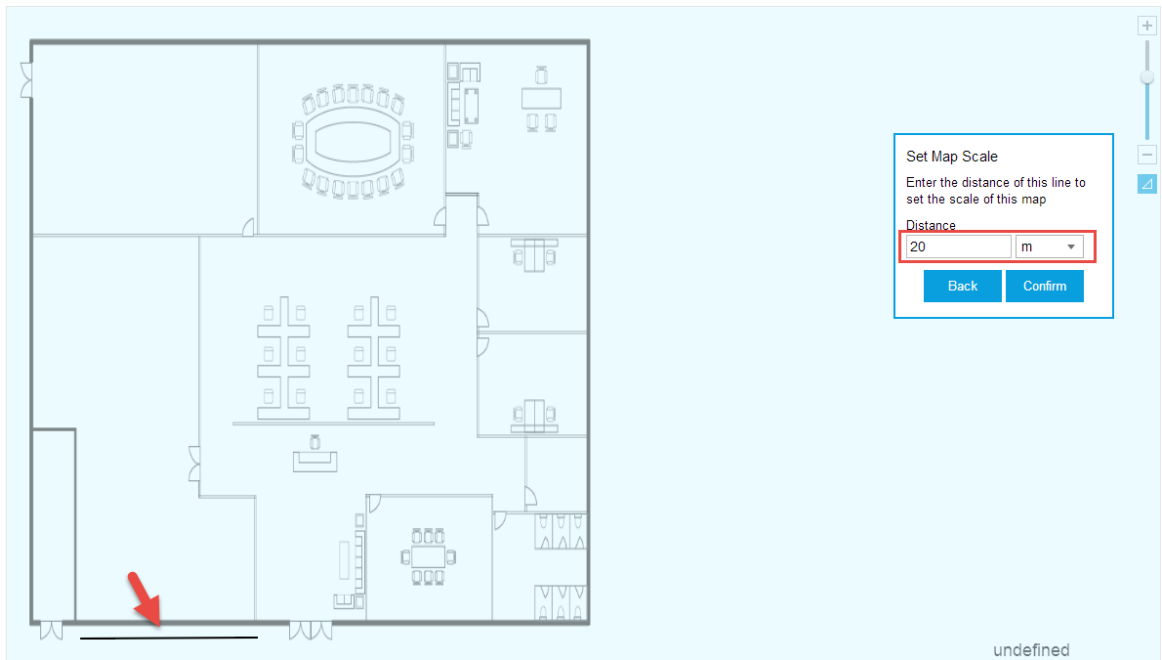



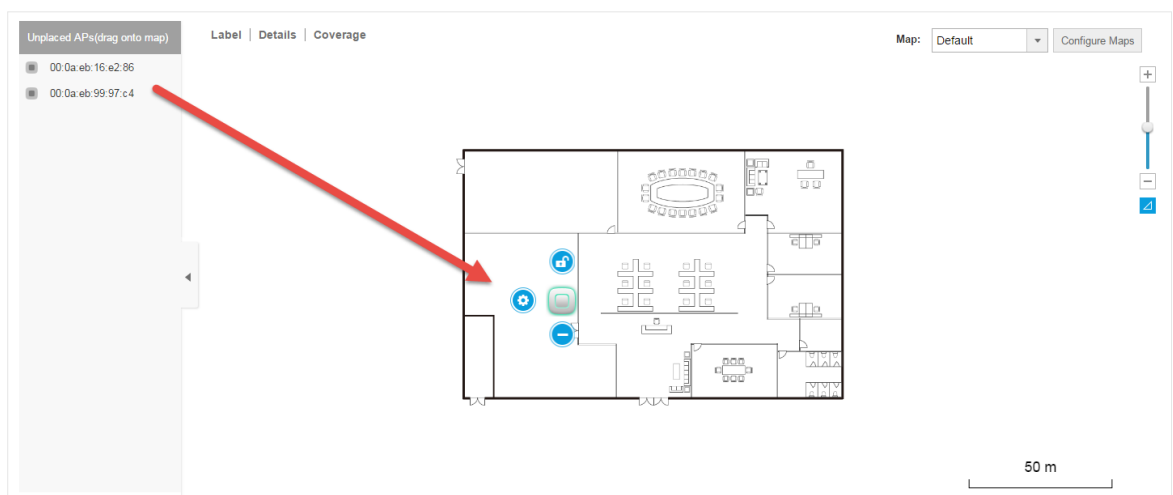

5. Drag the unplaced EAPs from the **Unplaced APs** list to appropriate locations on the map according to their actual locations.



You can click  to reveal additional options:



	Lock the selected EAP in the current location on the map.
	Unlock the selected EAP and you can drag it to another location.
	Display the EAP's details and configure the wireless parameters. Refer to <a href="#">Configure the EAPs Separately</a> .
	Remove the selected EAP back into the Unplaced APs list.

## Monitor the EAPs on the Map

Click any of the following options to display EAP Label, Details, and Coverage on the map.

**Label** | **Details** | **Coverage**

<b>Label</b>	Display the EAP's name. The default name is EAP's MAC address.
<b>Details</b>	Display the EAP's name, MAC address, IP address, transmitting/receiving channel, number of connected users, and number of connected guests.
<b>Coverage</b>	Display a visual representation of the wireless range covered by EAPs. The actual signal coverage may be smaller than the visual coverage on the map because the obstacles around the EAPs will weaken the signal.

## 2.2 View the Statistics of the Network

The EAP Controller collects all the statistics of the managed EAPs and displays the statistical information via graphs, pie charts and tables, providing an overview of your wireless network.

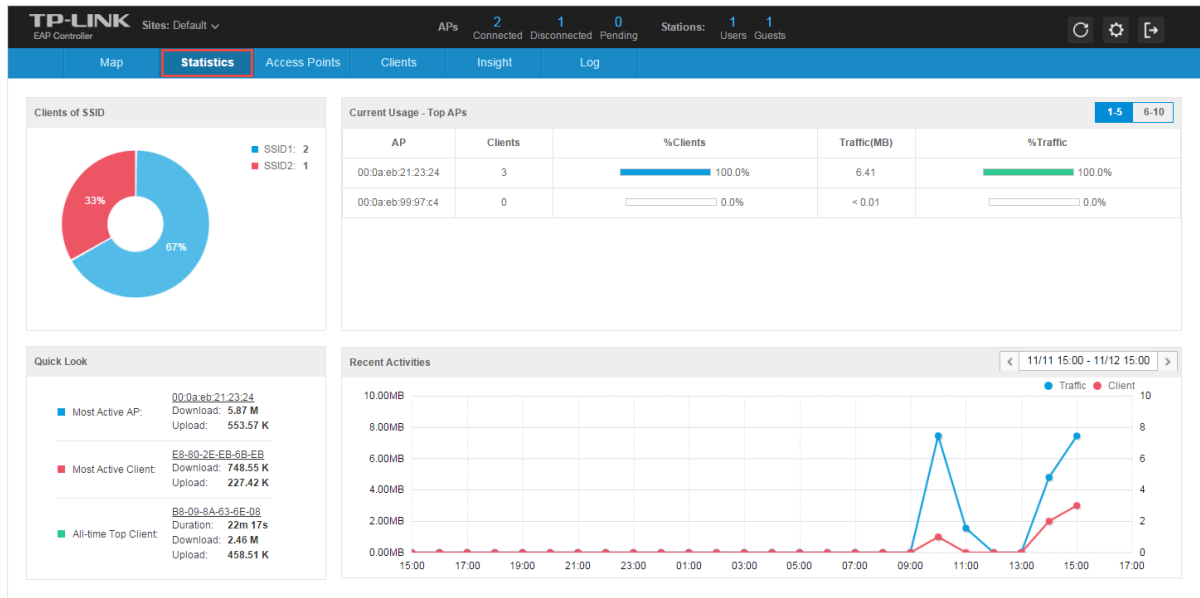

### View the Client Distribution on SSID

A visual pie chart represents the client distribution on each SSID. For example, the SSID 1 has 2 clients, which occupies 67% of all the clients.

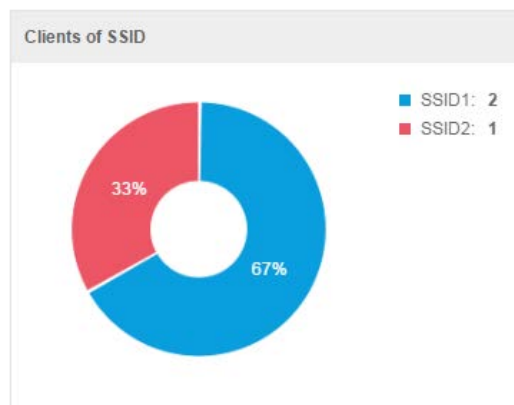

## Have a Quick Look at EAPs and Clients

This tab displays the **Most Active AP**, the **Most Active Clients** and the **All-Time Top Client**. You can click the MAC address of the EAP or the client to see more details.

Quick Look	
■ Most Active AP:	<a href="#">00:0a:eb:21:23:24</a> Download: <b>5.87 M</b> Upload: <b>553.57 K</b>
■ Most Active Client:	<a href="#">E8-80-2E-EB-6B-EB</a> Download: <b>748.55 K</b> Upload: <b>227.42 K</b>
■ All-time Top Client:	<a href="#">B8-09-8A-63-6E-08</a> Duration: <b>22m 17s</b> Download: <b>2.46 M</b> Upload: <b>458.51 K</b>

<a href="#">Most Active AP</a>	The current connected AP with the maximum traffic.
<a href="#">Most Active Client</a>	The current connected client with the maximum traffic.
<a href="#">All-time Top Client</a>	The client with the maximum traffic among all the clients that have ever accessed the EAP network.

## View Current Usage-Top APs

This tab lists the hostname, the number of connected clients and the data traffic condition of the ten APs with the most traffic currently.

Current Usage - Top APs				
AP	Clients	%Clients	Traffic(MB)	%Traffic
00:0a:eb:21:23:24	3	<div style="width: 100%;"><div style="width: 100%;"></div></div> 100.0%	6.41	<div style="width: 100%;"><div style="width: 100%;"></div></div> 100.0%
00:0a:eb:99:97:c4	0	<div style="width: 0%;"><div style="width: 0%;"></div></div> 0.0%	< 0.01	<div style="width: 0%;"><div style="width: 0%;"></div></div> 0.0%

<a href="#">Clients</a>	The amount of clients connected to this AP.
<a href="#">%Clients</a>	The proportion of current connected clients to the Top APs' total client amount.
<a href="#">Traffic</a>	The total amount of data transmitted by this AP, which equals the sum of the transmission traffic of all the current clients that connect to the AP.
<a href="#">%Traffic</a>	The proportion of the AP's current data transmission amount to the Top APs' total transmission amount.

## View Recent Activities

The **Recent Activities** statistics can be toggled between a view for the past specific 24 hours and one for the past specific 30 days.

The left ordinate axis indicates the traffic and the right one represents the number of the clients. The abscissa axis shows the selected time period. **Traffic** indicates a visual graph of the network traffic during the selected time period. **Client** indicates a visual graph of the number of the connected clients during the selected time period. For example, the statistics information at 10:00 indicates the traffic size and client number from 9:00 to 10:00. In the following figure, at 10 o'clock, the traffic is about 8 and there is 1 client connected to the AP.

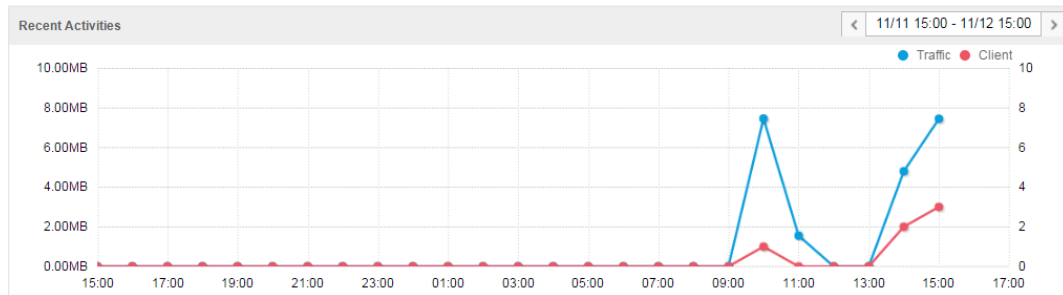

## 2.3 Monitor and Manage the EAPs

The EAP Controller can discover all the EAP devices currently connected to the network and display the information about them on the **Access Points** page.

Name/MAC Address	IP Address	Status	Model	Version	Num of Clients	Download	Upload	Action
00:0a:eb:99:97:c4	192.168.0.6	Connected	EAP320	1.0.0 Build 20151013 Rel. 34328	0	0 Bytes	0 Bytes	🔍 ⚙️ ↑ 🗑️
00:0a:eb:21:23:24	192.168.0.5	Connected	EAP220	2.0.2 Build 20151027 Rel. 32349	0	524.42 K	0 Bytes	🔍 ⚙️ ↑ 🗑️
00:0a:eb:16:e2:86	192.168.0.4	Connected	EAP120	2.0.2 Build 20150730 Rel. 53954	0	594.19 K	0 Bytes	🔍 ⚙️ ↑ 🗑️

### Manage the EAPs in Different Status

According to their connection status, all the EAPs are divided into three categories: connected, disconnected and pending. You can view the EAPs in different status on different pages:

[All](#) | [Connected](#) | [Disconnected](#) | [Pending](#)

<a href="#">All</a>	Displays the information of all the EAPs in different status.
<a href="#">Pending</a>	Displays the pending EAPs.  All the EAPs are in pending state by default when first discovered by the EAP Controller, and only after they are adopted and connected, you can monitor and manage them. To adopt pending EAPs, please refer to <a href="#">Adopt EAPs</a> .

<b>Connected</b>	<p>Displays the connected EAPs.</p> <p>Only connected EAPs can be managed. After you adopt a pending EAP, its status will become provisioning and then connected. A connected EAP will turn into a pending one after you forget this EAP. You can refer to <a href="#">Forget this AP</a> to forget a EAP or click <b>Forget All</b> on the page to forget all the connected EAPs.</p>
<b>Disconnected</b>	<p>Displays the disconnected EAPs.</p> <p>If a connected or pending EAP powers off, it will be disconnected. When a disconnected EAP is reset to factory default settings or you forget it, it will turn into a pending one again. You can refer to <a href="#">Forget this AP</a> to forget a EAP or click <b>Forget All</b> on the page to forget all the disconnected EAPs.</p>

## View the Detailed Information of EAPs

You can click **Overview**, **Config**, and **Performance** tab to view different detailed information of EAPs.





<b>Overview</b>	<b>Overview</b> displays the EAP's name/MAC address, IP address, status, model, software version, number of connected clients and download/upload bytes.
<b>Config</b>	<b>Config</b> displays the EAP's name/MAC address, IP address, status, model, software version, WLAN Group bounded with the 2G and 5G of the EAP, and radio of the 2G and 5G.
<b>Performance</b>	<b>Performance</b> displays the EAP's name/MAC address, IP address, status, model, software version, number of connected 2G clients and 5G clients, TX(Downloaded Traffic), RX(Uploaded Traffic), TX 2G and TX 5G.

## Manage the EAPs in the Action Column

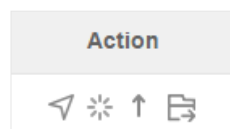
You can execute the corresponding operation to the EAP by clicking an icon in the **Action** column.



	Locate the EAP in the map.
	Reboot the EAP.



Upgrade the EAP.

Click **Browse** to locate and choose the upgrade file in your computer, then click **Upgrade** to install the latest EAP firmware. The Status will appear as **Upgrading** until the process is complete and the EAP reconnects to the EAP Controller.

**Upgrade(00:0a:eb:13:7f:00)**

Model: EAP110

Upgrade File:  **Browse** Upgrade



Move the EAP to a site.

Select a site that has been created and click **Apply**. You can group all the EAPs by this way and centrally manage them on each site.

**Move to Site(00:0a:eb:99:97:c7)**

Move to Site: 

- Default
- Office
- Rest Room

**Apply**

#### Note

- Only managed EAPs can be rebooted or upgraded.
- If you want to login to the EAP's own management interface, you need to forget the EAP before that.

## 2.4 Monitor and Manage Clients

The **Clients** tab displays the clients connected to the EAP network.

**TP-LINK** EAP Controller Sites: Default

APs: 3 Connected, 0 Disconnected, 0 Pending Stations: 1 Users, 0 Guests

Map | Statistics | Access Points | **Clients** | Insight | Log

**Users** All Clients | **Users** | Guests

MAC, Name, IP, AP, SSID

MAC Address	Hostname	IP Address	Access Point	SSID	User/Guest	2G/5G	Download	Upload	Rate(Mbps)	Active Time	Signal	Action
B8-09-8A-63-6F-08	iPhone	192.168.0.7	00:0a:eb:21:23:24	SSID1	User	5G	262 Bytes	3.24 K	0.0	5s		

Page Size: 10 << < 1 > >> A total of 1 page(s) Page to:  GO

### View the Current Information of Clients

The clients are divided into two types: User and Guest. Users are the clients connected to the EAP wireless network without the [Portal Authentication](#). Guests are the clients connected to the EAP wireless network with the [Portal Authentication](#).

You can click the following tabs to respectively view the detailed information of users and guests.

[All Clients](#) | [Users](#) | [Guests](#)

**All Clients** The page will display the information of all clients including users and guests.





<b>Users</b>	The page will display the information of Users.
<b>Guests</b>	The page will display the information of Guests.

## Manage Clients in the Action Column

You can execute the corresponding operation to the EAP by clicking an icon in the **Action** column:



	Reconnect the client to the network.
	Restrict the client's access to the network.
	If the client is Guest, you can click this icon to cancel the authorization for it.

## 2.5 View Clients Statistics During the Specified Period

The **Clients Statistics** page under the **Insight** tab displays the information of clients that have connected to the EAPs network during a specified period.

**TP-LINK EAP Controller** Sites: Default ▾ APs: 3 Connected, 0 Disconnected, 0 Pending Stations: 1 Users, 0 Guests

Map Statistics Access Points Clients **Insight** Log 1

**Clients Statistics** Clients Statistics Untrusted Rogue APs | Trusted Rogue APs | Past Guest Authorization

MAC Address, Hostname Q All User Guest Blocked All Offline Only Last Seen: 1 Day ▾

MAC Address	Hostname	Download	Upload	Duration	Last Seen	Action
C4-E9-84-0B-D0-EE	--	262 Bytes	10.44 K	5m 57s	2015-11-12 14:46:32	⊘
B8-09-8A-63-6E-08	iPhone	2.32 K	45.44 K	3m 9s	2015-11-12 14:52:28	🔄

Page Size 10 ▾ << < 1 > >> A total of 1 page(s) Page to  GO

### Select a Specified Period

Select a period from the drop-down menu. Then the page will display clients that have connected to the EAPs network during the period.

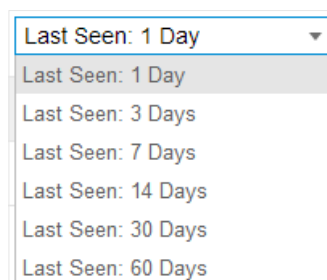

## View the History Information of Clients

You can click the client's MAC address to get its connection history or click the following tabs to view the information of different types of clients:





All	The page will display the history information of all the clients.
User	The page will display the history information of Users. Users are the clients connected to the EAP wireless network without the <a href="#">Portal Authentication</a> .
Guest	The page will display the history information of Guests. Guests are the clients connected to the EAP wireless network with the <a href="#">Portal Authentication</a> .
Blocked	The page will display the clients that have been blocked.



All	The page will display the history information of all clients.
Offline Only	The page will display the history information of the offline clients.

## Manage Clients in the Action Column

You can execute the corresponding operation to the EAP by clicking an icon in the **Action** column:

	Block the client's access to the network.
	Resume the client's access.

## 2.6 Manage the Rogue APs List

A Rogue AP is an access point that has been installed on a secure network without explicit authorization from a system administrator. The EAP Controller can scan all channels to detect all nearby EAPs. If rogue APs are detected, they will be shown on the **Untrusted Rogue APs** list. Besides, you can move the untrusted rogue APs to the **Trusted Rogue APs** list.

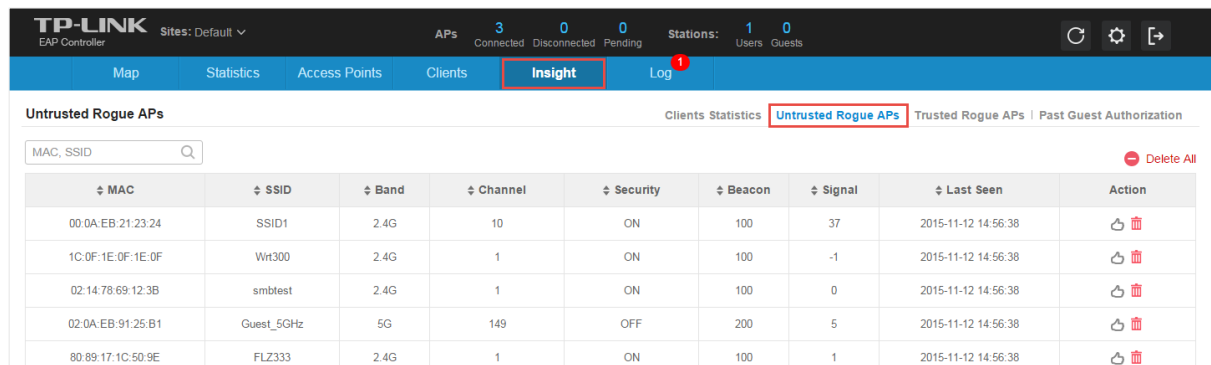

## Manage the Untrusted Rogue APs List

The **Untrusted Rogue APs** page displays the detailed information of untrusted rogue APs.



MAC	SSID	Band	Channel	Security	Beacon	Signal	Last Seen	Action
00:0A:EB:21:23:24	SSID1	2.4G	10	ON	100	37	2015-11-12 14:56:38	
1C:0F:1E:0F:1E:0F	Wrt300	2.4G	1	ON	100	-1	2015-11-12 14:56:38	
02:14:78:69:12:3B	smblest	2.4G	1	ON	100	0	2015-11-12 14:56:38	
02:0A:EB:91:25:B1	Guest_5GHz	5G	149	OFF	200	5	2015-11-12 14:56:38	
80:89:17:1C:50:9E	FLZ333	2.4G	1	ON	100	1	2015-11-12 14:56:38	

You can execute the corresponding operation to the EAP by clicking an icon in the **Action** column:

-  Move the untrusted rogue AP to the Trusted Rogue APs list.
-  Delete this record.
-  **Delete All** Delete all records.

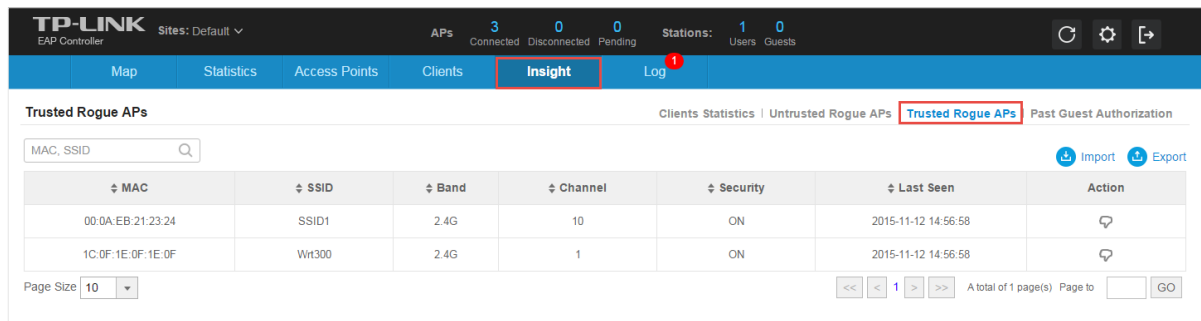

## Manage the Trusted Rogue APs List

The **Trusted Rogue APs** page displays the detailed information of trusted rogue APs.



MAC	SSID	Band	Channel	Security	Last Seen	Action
00:0A:EB:21:23:24	SSID1	2.4G	10	ON	2015-11-12 14:56:58	
1C:0F:1E:0F:1E:0F	Wrt300	2.4G	1	ON	2015-11-12 14:56:58	

You can execute the corresponding operation to the EAP by clicking an icon in the **Action** column:

-  Move the trusted rogue AP to the Untrusted Rogue APs list.
-  **Export** Export and download the current Trusted Rogue APs list and save it on your PC.



Import a saved Trusted Rogue APs list. If the MAC address of an AP appears in list, it will not be detected as a rogue AP.

**Import Trusted AP List** ✕

Import Mode:  Replace  Merge

Import Source File:

Please follow the steps below:

1. Select **Replace** (replace the current Trusted Rogue APs list with the one you import) or **Merge** (add the APs in the file to the current Trusted Rogue APs list).
2. Click **Browse** to locate the file and choose it.
3. Click **Import** to import the Trusted Rogue APs list.

## 2.7 View Past Guest Authorization

The Past Guest Authorization page displays the details about all the clients that accessed the network during a certain time period. You can select a period in the drop-down list.

TP-LINK EAP Controller Sites: Default

APs: 2 Connected, 1 Disconnected, 0 Pending. Stations: 1 Users, 1 Guests.

Map | Statistics | Access Points | Clients | **Insight** | Log

Past Guest Authorization Clients Statistics | Untrusted Rogue APs | Trusted Rogue APs | **Past Guest Authorization**

MAC, SSID  within 1 Day

MAC Address	SSID	Radio	Authorized By	Authorized Start Time	Download	Upload
e8:80:2e:eb:6b:eb	SSID1	5GHz	Simple Password	2015-11-12 15:46:03	748.41 K	227.02 K

Page Size: 10

<< < 1 > >> A total of 1 page(s) Page to  GO

## 2.8 View Logs

The logs of the EAP Controller can effectively record, classify and manage the system information of the managed EAPs, providing powerful support for network administrator to monitor network operation and diagnose malfunctions. The Logs page displays EAP's MAC address, level, occurred time and content.

The screenshot shows the TP-LINK EAP Controller interface. The top navigation bar includes 'Map', 'Statistics', 'Access Points', 'Clients', 'Insight', and 'Log' (highlighted with a red box). The 'Log' page displays a table of logs with the following columns: AP MAC, Level, Time, Content, and Action. The table contains 10 rows of log entries. The 'Log' tab is highlighted in the top navigation bar.

AP MAC	Level	Time	Content	Action
00:0a:eb:21:23:24	WARNING	2015-11-12 14:32:43	LAN IP and mask changed to 192.168.0.254 255.255.255.0	
00:0a:eb:21:23:24	INFO	2015-11-12 14:32:43	System started	
00:0a:eb:21:23:24	WARNING	2015-11-12 14:32:43	LAN IP and mask changed to 192.168.0.254 255.255.255.0	
00:0a:eb:21:23:24	WARNING	2015-11-12 14:32:43	LAN IP and mask changed to 192.168.0.5 255.255.255.0	
00:0a:eb:21:23:24	WARNING	2015-11-12 14:32:43	Username and password are successfully updated	
00:0a:eb:21:23:24	WARNING	2015-11-12 14:32:43	LAN IP and mask changed to 192.168.0.5 255.255.255.0	
00:0a:eb:16:e2:86	INFO	2015-11-12 14:32:36	System started	
00:0a:eb:16:e2:86	WARNING	2015-11-12 14:32:36	LAN IP and mask changed to 192.168.0.4 255.255.255.0	
00:0a:eb:16:e2:86	WARNING	2015-11-12 14:32:36	LAN IP and mask changed to 192.168.0.254 255.255.255.0	
00:0a:eb:16:e2:86	WARNING	2015-11-12 14:32:36	LAN IP and mask changed to 192.168.0.4 255.255.255.0	

## 2.9 View Alerts

You can see the status change of your EAPs on the **Unarchived Alerts** page. You can click or [Archive All](#) to move unarchived alerts to the Archived Alerts page.

The screenshot shows the TP-LINK EAP Controller interface. The top navigation bar includes 'Map', 'Statistics', 'Access Points', 'Clients', 'Insight', and 'Log' (highlighted with a red box). The 'Unarchived Alerts' page displays a table of unarchived alerts with the following columns: AP MAC, Model, Time, Content, and Action. The table contains 1 row of alert entries. The 'Log' tab is highlighted in the top navigation bar.

AP MAC	Model	Time	Content	Action
00:0a:eb:99:97:c4	EAP320	2015-11-12 10:09:13	AP [00:0a:eb:99:97:c4] was disconnected	

As follows, the Archived Alerts page displays the alerts archived by you. You can click or [Delete All](#) to delete the records.

The screenshot shows the TP-LINK EAP Controller interface. The top navigation bar includes 'Map', 'Statistics', 'Access Points', 'Clients', 'Insight', and 'Log' (highlighted with a red box). The 'Archived Alerts' page displays a table of archived alerts with the following columns: AP MAC, Model, Time, Content, and Action. The table contains 1 row of alert entries. The 'Log' tab is highlighted in the top navigation bar.

AP MAC	Model	Time	Content	Action
00:0a:eb:99:97:c4	EAP320	2015-11-12 10:09:13	AP [00:0a:eb:99:97:c4] was disconnected	

# 3

## Configure the EAPs Globally

This chapter introduces the global configuration that will be applied to all the managed EAPs. If you need to configure a specified EAP, please refer to [Chapter 4 Configure the EAPs Separately](#).

You can configure the following items:

- *Wireless Network*
- *Access Control*
- *Portal Authentication*
- *Free Authentication Policy*
- *MAC Filter*
- *Scheduler*
- *System*

## 3.1 Wireless Network

In addition to the wireless network you created in Quick Start, you can add more wireless networks and configure advanced wireless parameters to improve the quality of the wireless network.



### Add Wireless Networks

To add wireless networks, follow the steps below.

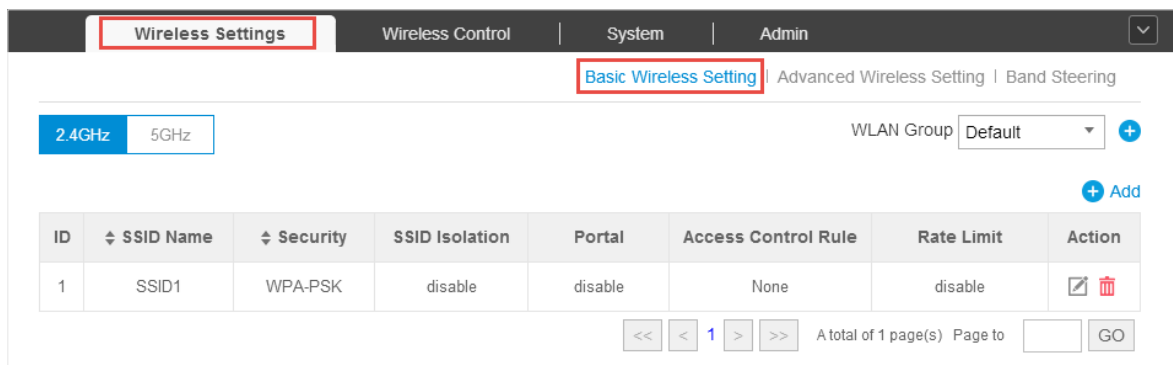
1. Go to **Wireless Settings > Basic Wireless Setting**.



The screenshot shows the 'Basic Wireless Setting' page. At the top, there are tabs for 'Wireless Settings', 'Wireless Control', 'System', and 'Admin'. Below the tabs, there are buttons for '2.4GHz' and '5GHz'. To the right, there is a 'WLAN Group' dropdown menu set to 'Default' with a '+' icon. Below this is a table with the following columns: ID, SSID Name, Security, SSID Isolation, Portal, Access Control Rule, Rate Limit, and Action. The table contains one row with ID '1', SSID Name 'SSID1', Security 'WPA-PSK', SSID Isolation 'disable', Portal 'disable', Access Control Rule 'None', and Rate Limit 'disable'. At the bottom of the table, there are navigation buttons and a 'GO' button.

ID	SSID Name	Security	SSID Isolation	Portal	Access Control Rule	Rate Limit	Action
1	SSID1	WPA-PSK	disable	disable	None	disable	 

2. Select a band frequency **2.4GHz** **5GHz** and click **+** at the right of **WLAN Group** **Default** to add a WLAN group. If you have no need to group your wireless networks, you can use the default WLAN group and skip this step.

Specify a name for the group and click **Apply**.



The screenshot shows a 'WLAN Group' dialog box. It has a title bar with 'WLAN Group' and a close button. Inside the dialog, there is a 'Name' label and a text input field containing 'Group1'. Below the input field is a blue 'Apply' button.

3. Select the brand frequency **2.4GHz** **5GHz** and WLAN group **WLAN Group** **Default**.
4. Click **+** **Add** to add a SSID to the specific WLAN group.
5. Configure the parameters in the following window.

Add 2.4GHz SSID
✕

**Basic Info** ⤴

---

SSID Name:

Wireless VLAN ID:  (0-4094, 0 is used to disable VLAN tagging.)

SSID Broadcast:  Enable

Security Mode:

Version:  Auto  WPA-PSK  WPA2-PSK

Encryption:  Auto  TKIP  AES

Wireless Password:

Group Key Update Period:  seconds(30-8640000,0 means no upgrade).

Portal:  Enable

SSID Isolation:  Enable

Access Control Rule:

---

**Rate Limit** ⤵

<b>SSID Name</b>	Enter a SSID name contains up to 32 characters.
<b>Wireless VLAN ID</b>	Set a VLAN ID for the wireless network. Wireless networks with the same VLAN ID are grouped to a VLAN. The value ranges from 0 to 4094. 0 means VLAN function is disabled.
<b>SSID Broadcast</b>	With the option enabled, EAPs will broadcast the SSID to the nearby hosts, so that those hosts can find the wireless network identified by this SSID. If this option is disabled, users must enter the SSID manually to connect to the EAP. Enabled by default.
<b>Security Mode</b>	Select the security mode of the wireless network. <b>None:</b> The hosts can access the wireless network without authentication. <b>WEP/WPA-Enterprise/WPA-PSK:</b> The hosts need to get authenticated before accessing the wireless network. For the network security, you are suggested to encrypt your wireless network. Settings vary in different security modes and the details are in the following introduction.
<b>Portal</b>	With the option enabled, the configurations in <a href="#">Portal</a> will be applied. Portal provides authentication service for the clients who just need temporary access to the wireless network, such as the customers in shopping mall and restaurant. Disabled by default.
<b>SSID Isolation</b>	With the option enabled, the devices connected in the same SSID cannot communicate with each other. Disabled by default.
<b>Access Control</b>	Select an Access Control rule for this SSID. For more information, refer to <a href="#">Access Control</a> .



Following is the detailed introduction of **WEP**, **WPA-Enterprise** and **WPA-PSK**.

- **WEP**

WEP is based on the IEEE 802.11 standard and less safe than WPA-Enterprise and WPA-PSK.

**Note**

WEP is not supported in 802.11n mode or 802.11ac mode. If WEP is applied in 802.11n, 802.11 ac or 802.11n/ac mixed mode, the clients may not be able to access the wireless network. If WEP is applied in 11b/g/n mode (2.4GHz) or 11a/n (5GHz), the EAP device may work at a low transmission rate.

Security Mode:	WEP
Type:	<input checked="" type="radio"/> Auto <input type="radio"/> Open System <input type="radio"/> Shared Key
Key Selected:	Key1
WEP Key Format:	<input checked="" type="radio"/> ASCII <input type="radio"/> Hexadecimal
Key Type:	<input checked="" type="radio"/> 64Bit <input type="radio"/> 128Bit <input type="radio"/> 152Bit
Key Value:	wepw

Type	Select the authentication type for WEP. <b>Auto:</b> The EAP Controller can select Open System or Shared Key automatically based on the wireless station's capability and request. <b>Open System:</b> Clients can pass the authentication and associate with the wireless network without password. However, correct password is necessary for data transmission. <b>Shared Key:</b> Clients have to input password to pass the authentication, otherwise it cannot associate with the wireless network or transmit data.
Key Selected	Select one key to specify. You can configure four keys at most.
WEP Key Format	Select <b>ASCII</b> or <b>Hexadecima</b> as the WEP key format. <b>ASCII:</b> ASCII format stands for any combination of keyboard characters of the specified length. <b>Hexadecimal:</b> Hexadecimal format stands for any combination of hexadecimal digits (0-9, a-f, A-F) with the specified length.
Key Type	Select the WEP key length for encryption. <b>64Bit:</b> Enter 10 hexadecimal digits or 5 ASCII characters. <b>128Bit:</b> Enter 26 hexadecimal digits or 13 ASCII characters. <b>152Bit:</b> Enter 32 hexadecimal digits or 16 ASCII characters.
Key Value	Enter the WEP keys. The length and valid characters are affected by key type.

- **WPA-Enterprise**

The WPA-Enterprise mode requires a RADIUS server to authenticate clients. Since the WPA-Enterprise can generate different passwords for different clients, it is much safer than WPA-PSK. However, it costs much more to maintain and is usually used by enterprise.

Security Mode:	WPA-Enterprise	
Version:	<input type="radio"/> Auto <input type="radio"/> WPA <input checked="" type="radio"/> WPA2	
Encryption:	<input type="radio"/> Auto <input type="radio"/> TKIP <input checked="" type="radio"/> AES	
Radius Server IP:	0.0.0.0	
Radius Port:	0	(1-65535,0 means default port 1812.)
Radius Password:		
Group Key Update Period:	0	seconds(30-8640000,0 means no upgrade).

<b>Version</b>	<p>Select the version of WPA-Enterprise.</p> <p><b>Auto:</b> The EAP will automatically choose the version used by each client device.</p> <p><b>WPA/WPA2:</b> Two versions of Wi-Fi Protected Access.</p>
<b>Encryption</b>	<p>Select the Encryption type.</p> <p><b>Auto:</b> The default setting is Auto and the EAP will select TKIP or AES automatically based on the client device's request.</p> <p><b>TKIP:</b> Temporal Key Integrity Protocol. TKIP is not supported in 802.11n mode, 802.11ac mode or 802.11n/ac mixed mode. If TKIP is applied in 802.11n, 802.11ac or 802.11n/ac mixed mode, the clients may not be able to access the wireless network of the EAP. If TKIP is applied in 11b/g/n mode (2.4GHz) or 11a/n mode(5GHz), the device may work at a low transmission rate.</p> <p><b>AES:</b> Advanced Encryption Standard. We recommend you select AES as the encryption type because it is more secure than TKIP.</p>
<b>Radius Server IP</b>	Enter the IP address of the Radius Server.
<b>Radius Port</b>	Enter the port number of the Radius Server.
<b>Radius Password</b>	Enter the shared secret key of the Radius server.
<b>Group Key Update Period</b>	Specify a group key update period, which instructs the EAP how often it should change the encryption keys. The value can be either 0 or 30~8640000 seconds. 0 means no change of the encryption key anytime.

- WPA-PSK**

Based on a pre-shared key, WPA-PSK is characterized by high safety and simple settings and is mostly used by common households and small businesses.

Security Mode:	WPA-PSK	
Version:	<input type="radio"/> Auto <input type="radio"/> WPA-PSK <input checked="" type="radio"/> WPA2-PSK	
Encryption:	<input type="radio"/> Auto <input type="radio"/> TKIP <input checked="" type="radio"/> AES	
Wireless Password:	12345678	
Group Key Update Period:	0	seconds(30-8640000,0 means no upgrade).

<b>Version</b>	<p>Select the version of WPA-Enterprise.</p> <p><b>Auto:</b> The EAP will automatically choose the version for each client device.</p> <p><b>WPA-PSK:</b> Pre-shared key of WPA.</p> <p><b>WAP2-PSK:</b> Pre-shared key of WPA2.</p>
<b>Encryption</b>	<p>Select the Encryption type.</p> <p><b>Auto:</b> The default setting is Auto and the EAP will select TKIP or AES automatically based on the client request.</p> <p><b>TKIP:</b> Temporal Key Integrity Protocol. TKIP is not supported in 802.11n mode, 802.11ac mode or 802.11n/ac mixed mode. If TKIP is applied in 802.11n, 802.11 ac or 802.11n/ac mixed mode, the clients may not be able to access the wireless network of the EAP. If TKIP is applied in 11b/g/n mode (2.4GHz) or 11a/n mode(5GHz), the device may work at a low transmission rate.</p> <p><b>AES:</b> Advanced Encryption Standard. We recommend you select AES as the encryption type for it is more secure than TKIP.</p>
<b>Wireless Password</b>	<p>Configure the wireless password with ASCII or Hexadecimal characters.</p> <p>For ASCII, the length should be between 8 and 63 characters with combination of numbers, letters (case-sensitive) and common punctuations. For Hexadecimal, the length should be 64 characters (case-insensitive, 0-9, a-f, A-F).</p>
<b>Group Key Update Period</b>	<p>Specify a group key update period, which instructs the EAP how often it should change the encryption keys. The value can be either 0 or 30~8640000 seconds. 0 means the encryption keys will not be changed all the time.</p>

6. Enable **Rate Limit** for the clients to guarantee the network balance. Enter the value for **Download Limit** and **Upload Limit**. 0 means unlimited.

7. Click **Apply** to add the new SSID.

## Configure Advanced Wireless Parameters

Proper wireless parameters can improve the network's stability, reliability and communication efficiency. The advanced wireless parameters consist of **Beacon Interval**, **DTIM Period**, **RTS Threshold**, **Fragmentation Threshold** and **Airtime Fairness**.

To configure the advanced wireless parameters, follow the steps below.

## 1. Go to Wireless Settings > Advanced Wireless Setting.

Wireless Settings | Wireless Control | System | Admin

Basic Wireless Setting | **Advanced Wireless Setting** | Band Steering

2.4GHz | 5GHz

Beacon Interval:  ms(40-100)

DTIM Period:  (1-255)

RTS Threshold:  (1-2347)

Fragmentation Threshold:  (256-2346, works only in 11b/g mode)

Airtime Fairness:  Enable

## 2. Select the band frequency .

## 3. Configure the following parameters.

### Beacon Interval

Beacons are transmitted periodically by the EAP device to announce the presence of a wireless network for the clients. **Beacon Interval** value determines the time interval of the beacons sent by the device.

You can specify a value between 40 and 100ms. The default is 100ms.

### DTIM Period

The DTIM (Delivery Traffic Indication Message) is contained in some Beacon frames. It indicates whether the EAP device has buffered data for client devices. The **DTIM Period** indicates how often the clients served by this EAP device should check for buffered data still on the EAP device awaiting pickup.

You can specify the value between 1-255 Beacon Intervals. The default value is 1, indicating clients check for buffered data on the EAP device at every beacon. An excessive DTIM interval may reduce the performance of multicast applications, so we recommend you keep it by default.

### RTS Threshold

RTS (Request to Send) can ensure efficient data transmission. When RTS is activated, the client will send a RTS packet to EAP to inform that it will send data before it send packets. After receiving the RTS packet, the EAP notices other clients in the same wireless network to delay their transmitting of data and informs the requesting client to send data, thus avoiding the conflict of packet. If the size of packet is larger than the **RTS Threshold**, the RTS mechanism will be activated.

If you specify a low threshold value, RTS packets are sent more frequently and help the network recover from interference or collisions that might occur on a busy network. However, it also consumes more bandwidth and reduces the throughput of the packet. We recommend you keep it by default. The recommended and default value is 2347.

### Fragmentation Threshold

The fragmentation function can limit the size of packets transmitted over the network. If a packet exceeds the **Fragmentation Threshold**, the fragmentation function is activated and the packet will be fragmented into several packets.

Fragmentation helps improve network performance if properly configured. However, too low fragmentation threshold may result in poor wireless performance caused by the extra work of dividing up and reassembling of frames and increased message traffic. The recommended and default value is 2346 bytes.

#### Airtime Fairness

With this option enabled, each client connecting to the EAP can get the same amount of time to transmit data, avoiding low-data-rate clients to occupy too much network bandwidth and improving the network throughput. We recommend you enable this function under multirate wireless networks.

4. Click **Apply** to save the configurations.

## Configure Band Steering

A client device that is capable of communicating on both the 2.4GHz and 5GHz frequency bands will typically connect to the 2.4 GHz band. However, if too many client devices are connected to an EAP on the 2.4 GHz band, the efficiency of communication will be diminished. Band Steering can steer clients capable of communication on both bands to the 5GHz frequency band which supports higher transmission rates and more client devices, and thus to greatly improve the network quality.

To configure Band Steering, follow the steps below.

1. Go to **Wireless Settings > Band Steering**.

The screenshot shows a web interface for configuring wireless settings. At the top, there are tabs for 'Wireless Settings', 'Wireless Control', 'System', and 'Admin'. The 'Wireless Settings' tab is selected and highlighted with a red box. Below the tabs, there are links for 'Basic Wireless Setting', 'Advanced Wireless Setting', and 'Band Steering', with 'Band Steering' highlighted by a red box. The main content area shows the 'Band Steering' configuration options: 'Band Steering' (unchecked checkbox), 'Connection Threshold' (input field with '20' and range '(2-40)'), 'Difference Threshold' (input field with '4' and range '(1-8)'), and 'Max Failures' (input field with '10' and range '(0-100)'). An 'Apply' button is located at the bottom left of the configuration area.

2. Check the box to enable the Band Steering function.
3. Configure the following parameters to balance the clients on both frequency bands:

#### Connection Threshold/ Difference Threshold

When the number of clients on the 5GHz band reaches the value of **Connection Threshold** and the difference value between the number of clients on the 2.4GHz band and the 5GHz band reaches the value of **Difference Threshold**, EAPs will refuse the requests of communication on the 5GHz band from other clients and no longer steer other clients to the 5GHz band.

The value of **Connection Threshold** is from 2 to 40, and the default is 20.

The value of **Difference Threshold** is from 1 to 8, and the default is 4.

#### Max Failures

If a client repeatedly attempts to associate with the EAP on the 5GHz band and the number of rejections reaches the value of **Max Failures**, the EAP will accept the request.

The value is from 0 to 100, and the default is 10.

4. Click **Apply** to save the configurations.

## 3.2 Access Control

Access Control is used to block or allow the clients to access specific subnets. To configure Access Control rules, follow the steps below.

1. Go to **Wireless Control > Access Control**.

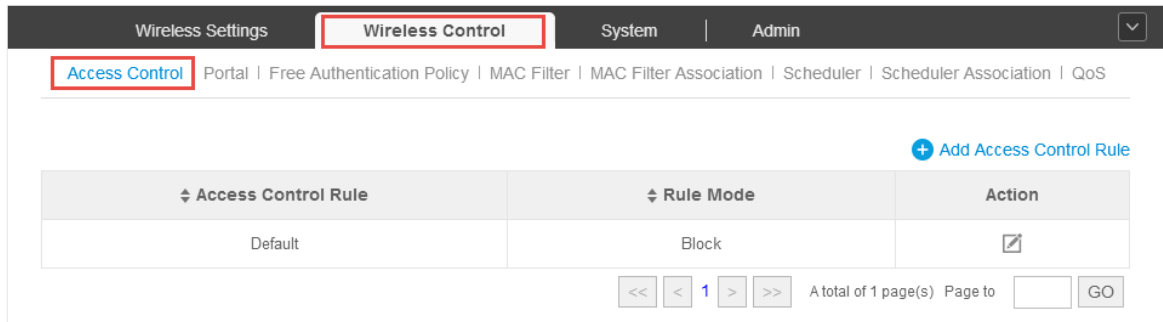

2. Click **+ Add Access Control Rule** to add a new Access Control rule.

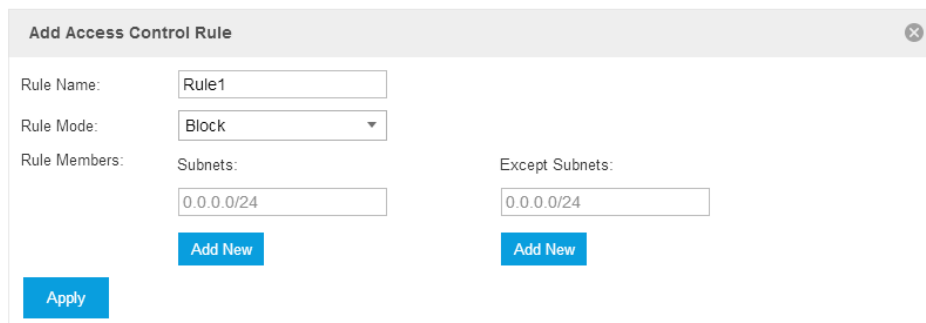

3. Configure the following parameters.

<b>Rule Name</b>	Specify a name for this rule.
<b>Rule Mode</b>	Select the mode for this rule. <b>Block:</b> Select this mode to block the rule members to access the network. <b>Allow:</b> Select this mode to allow the rule members to access the network.
<b>Rule Memembers</b>	<b>Subnets:</b> Clients of the subnet will be controlled by the rule. Enter the subnet for this rule in the format X.X.X.X/X and click <a href="#">Add New</a> . Up to 16 subnets can be added. <b>Except Subnets:</b> Clients of the subnet will be controlled by the rule. Enter the subnet that does not follow this rule in the format X.X.X.X/X and click <a href="#">Add New</a> . Up to 16 subnets can be added.  The rule will not apply to the subnets that is in both the Subnets list and the Except Subnets list.

4. Click **Apply** to save the configurations.
5. Go to **Wireless Settings > Basic Wireless Setting** and enable Access Control function of a selected SSID.

### 3.3 Portal Authentication

Portal authentication enhances the network security by providing authentication service to the clients that just need temporary access to the wireless network. Such clients have to log into a web page to establish verification, after which they will access the network as guests. What's more, you can customize the authentication login page and specify a URL which the newly authenticated clients will be redirected to.

To configure Portal Authentication, go to **Wireless Control > Portal**.

The screenshot shows the configuration interface for Portal Authentication. The top navigation bar includes 'Wireless Settings', 'Wireless Control' (highlighted), 'System', and 'Admin'. Below the navigation bar, there are tabs for 'Access Control', 'Portal' (highlighted), 'Free Authentication Policy', 'MAC Filter', 'MAC Filter Association', 'Scheduler', 'Scheduler Association', and 'QoS'. The main configuration area includes the following fields and options:

- Authentication Type: No Authentication (dropdown)
- Authentication Timeout: 1 Hour (dropdown)
- Redirect:  Enable
- Redirect URL: (text input field)
- Section: **Login Page** (with an expand/collapse icon)
- Portal Title: Welcome (text input field)
- Term of Use: By using it, you are agreeing to these Terms of Use. (text area)
- Logo Image: Best aspect ratio 1:1; Size 100KB; [Choose] [Upload] [Restore]
- Background Image: Best aspect ratio 3:5; Size 2MB; [Choose] [Upload] [Restore]
- Preview Login Page: [Preview Login Page](#)
- [Apply] button

Five different types of authentication methods are available: No Authentication, Simple Password, Hotspot, External Radius Server, and External Portal Server. Please refer to the following instructions to configure Portal.

## No Authentication

When this option is selected, clients can access the network without any authentication and just need to accept the term of use.

Authentication Type:

Authentication Timeout:

Redirect:  Enable

Redirect URL:

**Login Page**

Portal Title:

Term of Use:

Logo Image:

Background Image:

Preview Login Page: [Preview Login Page](#)

Configure the following parameters and provide the required information.

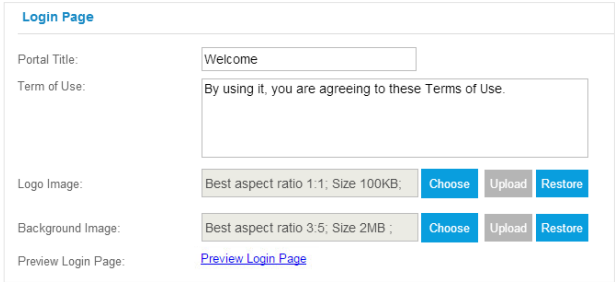
<b>Authentication Type</b>	Select <b>No Authentication</b> .
<b>Authentication Timeout</b>	The client's authentication will expire after the time period you set and the client needs to log in the web authentication page again to access the network. Options include: <b>1 Hour, 8 Hours, 24 Hours, 7 Days, Custom</b> . <b>Custom</b> allows you to define the time in days, hours, and minutes. The default value is one hour.
<b>Redirect</b>	If you enable this function, the portal will redirect the newly authenticated clients to the configured URL. Disabled by default.
<b>Redirect URL</b>	If the Redirect function above is enabled, enter the URL that a newly authenticated client will be redirected to.
<b>Login Page</b>	Customize the login page:  <ol style="list-style-type: none"><li>1. Configure the title and terms of the login page in the <b>Portal Title</b> and <b>Term of Use</b> boxes.</li><li>2. Upload a logo image and a background image from your local PC.</li><li>3. Preview the login page.</li></ol>



## Simple Password

When this option is selected, clients are required to enter the password and accept the term of use.

The screenshot shows a configuration form for the 'Simple Password' authentication type. The form is divided into two main sections. The top section contains: 'Authentication Type' (Simple Password), 'Password' (text input), 'Authentication Timeout' (1 Hour), 'Redirect' (checkbox, disabled), and 'Redirect URL' (text input). Below this is a 'Login Page' section with: 'Portal Title' (Welcome), 'Term of Use' (By using it, you are agreeing to these Terms of Use), 'Logo Image' (Best aspect ratio 1:1; Size 100KB; Choose, Upload, Restore), 'Background Image' (Best aspect ratio 3.5; Size 2MB; Choose, Upload, Restore), and 'Preview Login Page' (Preview Login Page). An 'Apply' button is at the bottom left.

Configure the following parameters and provide the required information.

Authentication Type	Select <b>Simple Password</b> .
Password	Specify the password for the authentication.
Authentication Timeout	The client's authentication will expire after the time period you set and the client needs to log in the web authentication page again to access the network. Options include: <b>1 Hour, 8 Hours, 24 Hours, 7 Days, Custom</b> . <b>Custom</b> allows you to define the time in days, hours, and minutes. The default value is one hour.
Redirect	If you enable this function, the portal will redirect the newly authenticated clients to the configured URL. Disabled by default.
Redirect URL	If the Redirect function above is enabled, enter the URL that a newly authenticated client will be redirected to.

## Login Page

Customize the login page:

**Login Page**

Portal Title:

Term of Use:

Logo Image:  [Choose](#) [Upload](#) [Restore](#)

Background Image:  [Choose](#) [Upload](#) [Restore](#)

Preview Login Page: [Preview Login Page](#)

1. Configure the title and terms of the login page in the **Portal Title** and **Term of Use** boxes.
2. Upload a logo image and a background image from your local PC.
3. Preview the login page.

## Hotspot

With this option selected, distribute the vouchers automatically generated by the EAP Controller to the clients, who can use the vouchers to access the network. In addition, the clients that access the network by hotspot authentication type can be managed by the hotspot manager.

Authentication Type:

[Hotspot Manager](#)

Redirect:  Enable

Redirect URL:

**Login Page**

Portal Title:

Term of Use:

Logo Image:  [Choose](#) [Upload](#) [Restore](#)

Background Image:  [Choose](#) [Upload](#) [Restore](#)

Preview Login Page: [Preview Login Page](#)

[Apply](#)

Configure the following parameters and provide the required information.

### Authentication Type

Select **Hotspot**.

### Hotspot Manager

Click **Hotspot Manager** to create vouchers and manage the hotspot authentication.  
For detailed instructions, please refer to the content below.

### Redirect

Disabled by default. If you enable this function, the portal will redirect the newly authenticated clients to the configured URL.

---

### Redirect URL

If the Redirect function above is enabled, enter the URL that a newly authenticated client will be redirected to.

---

### Login Page

Customize the login page:

**Login Page**

Portal Title:

Term of Use:

Logo Image:

Background Image:

Preview Login Page: [Preview Login Page](#)

1. Configure the title and terms of the login page in the **Portal Title** and **Term of Use** boxes.
  2. Upload a logo image and a background image from your local PC.
  3. Preview the login page.
- 

After you click **Hotspot Manager**, a new window will open automatically. On the page, you can create and print Vouchers, manage the guests and create the Operator account to help manage your network.

- **Create and Print Vouchers**

Please follow these steps to create and print vouchers.

1. Go to the **Voucher** page.

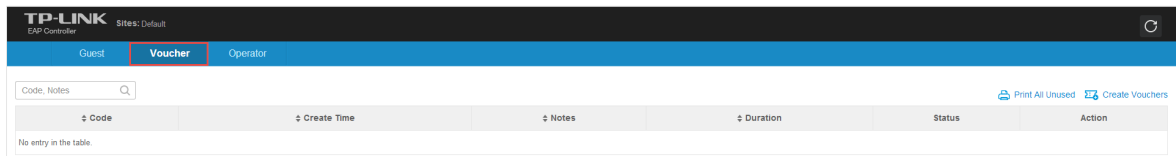

2. Click **Create Vouchers** and the following window will pop up.

**Create Vouchers**

Amount:

Type:

Duration:

Notes:

3. Configure the parameters as follows:
- 

### Amount

Enter the voucher amount to be generated.

---

## Type

Select **Single Use** or **Multi Use**.

Single Use means one voucher can only be distributed to one client. Multi Use means one voucher can be distributed to several clients, who can use the same voucher to access the network at the same time.

If you select Multi Use, enter the value of **Max Users**. When the number of clients who are connected to the network with the same voucher reaches the value, no more clients can use this voucher to access the network.

## Duration

Select the period of validity of the Voucher.

The options include: **8 hours**, **2 days** and **User-defined**. The period of valid of the voucher is reckoned from the time when it is used for the first time.

## Notes

Enter a description for the Voucher (optional).

4. Click **Apply**. The Vouchers will be generated and displayed on the page.

Code	Notes	Create Time	Duration	Status	Action
64318-78801	Vouchers For Guests	2015-10-22 17:00:57	8h	Valid for single use	
17718-21929	Vouchers For Guests	2015-10-22 17:00:57	8h	Valid for single use	
28198-11913	Vouchers For Guests	2015-10-22 17:00:57	8h	Valid for single use	
46785-05228	Vouchers For Guests	2015-10-22 17:00:57	8h	Valid for single use	
10464-70928	Vouchers For Guests	2015-10-22 17:00:57	8h	Valid for single use	
23231-30232	Vouchers For Guests	2015-10-22 17:00:57	8h	Valid for single use	
16913-62422	Vouchers For Guests	2015-10-22 17:00:57	8h	Valid for single use	
65696-61596	Vouchers For Guests	2015-10-22 17:00:57	8h	Valid for single use	
59055-12076	Vouchers For Guests	2015-10-22 17:00:57	8h	Valid for single use	
99655-51498	Vouchers For Guests	2015-10-22 17:00:57	8h	Valid for single use	

5. Click or **Print All Unused** to print and save the Vouchers.



Code	Code	Code
08530-10315	05513-54611	59000-20906
66376-36221	22403-84003	44957-12560
09335-92563	86371-85105	59427-48048
23717-34814	99655-51498	59055-12076
65696-61596	16913-62422	23231-30232
10464-70928	46785-05228	28198-11913
17718-21929	64318-78801	

6. Distribute the Vouchers to clients, and then they can use the **Code** to pass authentication for network access.



7. When the Vouchers are invalid, you can click to delete the Voucher or to delete all of them.

- **Manage the Guests**

Guest page allows you to view the information of clients that have passed the portal authentication and manage the clients.

MAC Address	SSID	WLAN Group	Radio	Authorized By	Download	Upload	Status	Action
b8:09:8a:63:6e:08	test-aaaaaa	Default	2.4GHz	Hotspot (8482943191)	0 Bytes	0 Bytes	Valid until 2015-11-17 18:42:05	 

You can select an icon to execute the corresponding operation:

-  Restrict the client to access the network.
-  Extend the effective time.

- **Create Operator Account**

Operator account can be used to remotely manage the hotspot. Other users can visit the URL **https://EAP Controller Host's IP Address:8043/hotspot** (For example: **https://192.168.0.64:8043/hotspot**) and use the Operator account to enter the Hotspot administrative system.

**Note**

The users who enter the hotspot administrative system by Operator account can only generate vouchers and manage the clients.

Follow the steps below to create Operator account.

1. Go to the **Operator** page and click  **Create Operator** .

**Create Operator**

Name:

Password:

Notes:

Site Privileges:  Default  Office A

2. Specify the **Name**, **Password** and **Notes** of the Operator account.
3. Choose **Site Privileges** (You can choose more than one options) for the Operator account.

- Click **Apply** to create an Operator account. Then other users can use this account to enter the hotspot administrative system.

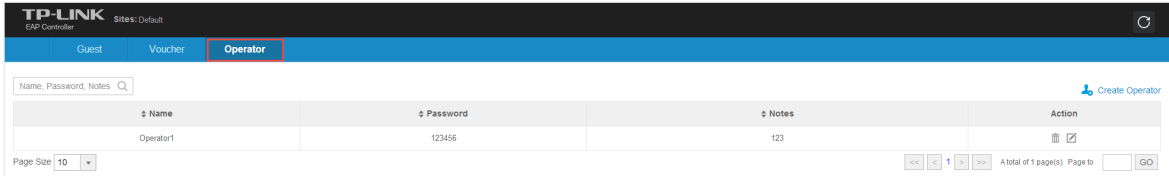

## External Radius Server

If you have a Radius Server, select External Radius Server. You can get two types of portal customization: Local Web Portal and External Web Portal. The authentication login page of Local Web Portal is provided by the built-in portal server of the EAP. The External Web Portal is provided by external portal server.

Authentication Type:	External Radius Server
Radius Server IP:	<input type="text"/>
Port:	<input type="text"/>
Radius Password:	<input type="text"/>
Authentication Timeout:	1 Hour
Redirect:	<input type="checkbox"/> Enable
Redirect URL:	<input type="text"/>
Portal Customization:	Local Web Portal
<b>Login Page</b>	
Portal Title:	Welcome
Term of Use:	By using it, you are agreeing to these Terms of Use.
Logo Image:	Best aspect ratio 1:1; Size 100KB; <input type="button" value="Choose"/> <input type="button" value="Upload"/> <input type="button" value="Restore"/>
Background Image:	Best aspect ratio 3:5; Size 2MB ; <input type="button" value="Choose"/> <input type="button" value="Upload"/> <input type="button" value="Restore"/>
Preview Login Page:	<a href="#">Preview Login Page</a>
<input type="button" value="Apply"/>	

Configure the parameters and provide the required information as follows:

<b>Authentication Type</b>	Select <b>External Radius Server</b> .
<b>Radius Server IP</b>	Enter the IP address of Radius Server.
<b>Port</b>	Enter the port the Radius Server used.
<b>Radius Password</b>	Enter the password you have set on the Radius Server. Clients will be required to enter the password when they attempt to access the network.

<b>Authentication Timeout</b>	<p>The client's authentication will expire after the time period you set and the client needs to log in the web authentication page again to access the network.</p> <p>Options include: 1 Hour, 8 Hours, 24 Hours, 7 Days, Custom. Custom allows you to define the time in days, hours, and minutes. The default is one hour.</p>
<b>Redirect</b>	<p>Disabled by default. If you enable this function, the portal will redirect the newly authenticated clients to the configured URL.</p>
<b>Redirect URL</b>	<p>If the Redirect function above is enabled, enter the URL that a newly authenticated client will be redirected to.</p>
<b>Portal Customization</b>	<p>Select Local Web Portal or External Web Portal.</p> <p><b>Local Web Portal:</b> If this option is selected, configure the Login Page.</p> <p><b>External Web Portal:</b> If this option is selected, follow the steps below.</p> <ol style="list-style-type: none"> <li>1. Configure the external radius server.</li> <li>2. Enter the authentication login page's URL provided by the external portal server on the page.</li> </ol> <div data-bbox="544 860 1023 936" data-label="Form"> <p>Portal Customization: <input type="text" value="External Web Portal"/></p> <p>External Web Portal URL: <input type="text"/></p> </div> <ol style="list-style-type: none"> <li>3. Put the external web portal server to a whitelist of <a href="#">Free Authentication Policy</a>, otherwise clients cannot access it before authenticated.</li> </ol>

<b>Login Page</b>	<p>If you select Local Web Portal, customize the login page:</p> <div data-bbox="544 1111 1160 1393" data-label="Form"> <p><b>Login Page</b></p> <p>Portal Title: <input type="text" value="Welcome"/></p> <p>Term of Use: <input type="text" value="By using it, you are agreeing to these Terms of Use."/></p> <p>Logo Image: <input type="text" value="Best aspect ratio 1:1; Size 100KB;"/> <input type="button" value="Choose"/> <input type="button" value="Upload"/> <input type="button" value="Restore"/></p> <p>Background Image: <input type="text" value="Best aspect ratio 3:5; Size 2MB;"/> <input type="button" value="Choose"/> <input type="button" value="Upload"/> <input type="button" value="Restore"/></p> <p>Preview Login Page: <a href="#">Preview Login Page</a></p> </div> <ol style="list-style-type: none"> <li>1. Configure the title and terms of the login page in the <b>Portal Title</b> and <b>Term of Use</b> boxes.</li> <li>2. Upload a logo image and a background image from your local PC.</li> <li>3. Preview the login page.</li> </ol>
-------------------	--

## External Portal Server

The option of External Portal Server is designed for the developers. They can customized their own authentication type according to the interface provided by EAP Controller, e.g. message authentication and WeChat authentication etc.

Authentication Type:

External Portal Server:

Authentication Type	Select <b>External Portal Server</b> .
Radius Server IP	Enter the complete authentication URL that redirect to an external portal server, for example:  http://192.168.0.147:8880/portal/index.php or http://192.168.0.147/portal/index.html

### 3.4 Free Authentication Policy

Free Authentication Policy allows some specified clients to access the network resources without authentication. Follow the steps below to add free authentication policy.

1. Go to **Wireless Control > Free Authentication Policy**.

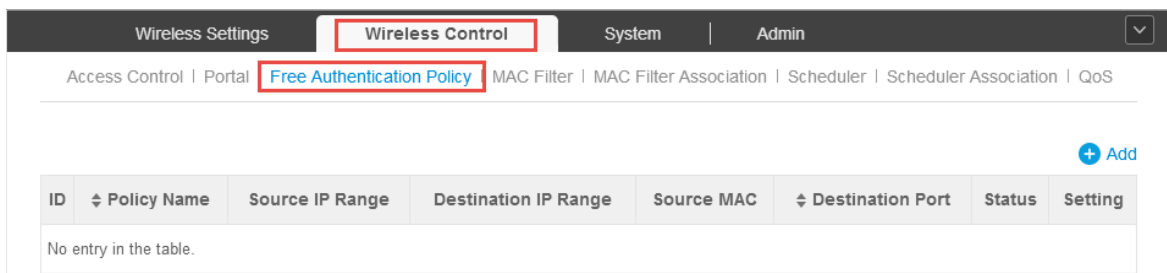

2. Click **+ Add** and the following window will pop up.

**Add Policy** ✕

Policy Name:

Source IP Range:  /  (Optional)

Destination IP Range:  /  (Optional)

Source MAC:  (Optional)

Destination Port:  (Optional)

Status:  Enable

**Apply**

3. Configure the following parameters. When all conditions are met, the client can access the network without authentication.

<b>Policy Name</b>	Specify a name for the policy.
<b>Source IP Range</b>	Set the Source IP Range with the subnet and mask length of the clients.
<b>Destination IP Range</b>	Set the Destination IP Range with the subnet and mask length of the server.
<b>Source MAC</b>	Set the MAC address of client.
<b>Destination Port</b>	Enter the port the service uses.
<b>Status</b>	Check the box to enable the policy.

4. Click **Apply** and the policy is successfully added.



## 3.5 MAC Filter

MAC filter can be used to allow or block the listed clients to access the network. Thereby it can effectively control client's access to the wireless network.

Follow the steps below to configure MAC Filter.

1. Go to **Wireless Control > MAC Filter** to add MAC Filter group and group members.

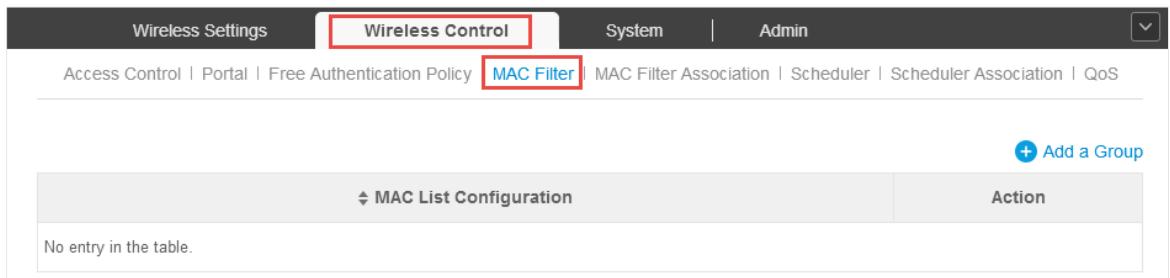

- 1) Click **+ Add a Group** and specify a name for the group.

The 'Add a Group' dialog box is shown with a text input field for 'MAC Filter Name' containing the value 'Group1' and an 'Apply' button below it.

- 2) Click **Apply** and the group will be successfully added as shown below.

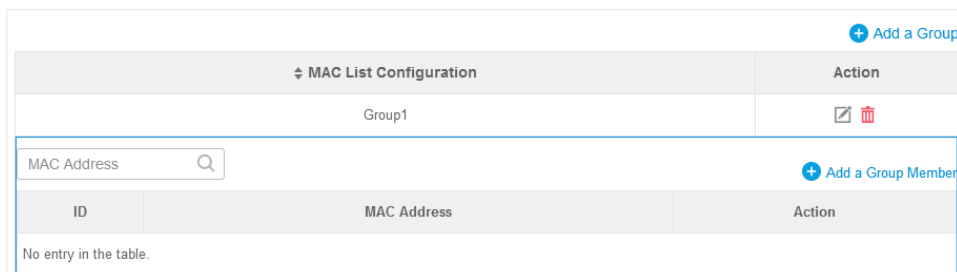

- 3) Click **+ Add a Group Member** and enter a MAC address in the format as shown below.

The 'Add a Group Member' dialog box is shown with a text input field for 'MAC Address' containing the value 'AA-BB-CC-DD-EE-FF' and an 'Apply' button below it.

4) Click **Apply** to add the MAC address into the MAC filter group.

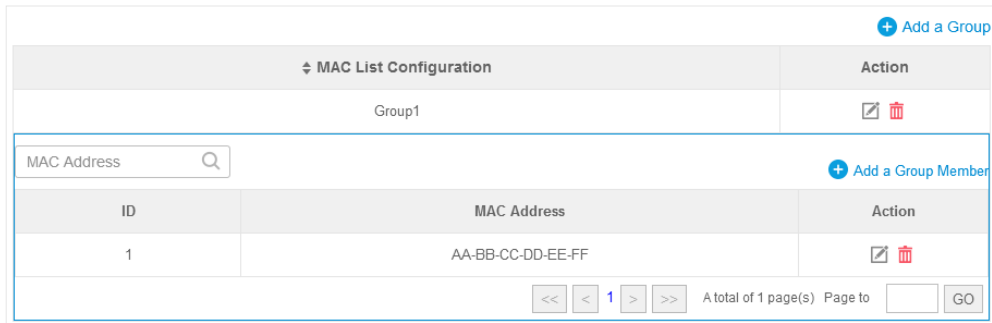

2. You can add more groups or members according to your need.

3. Go to **Wireless Control > MAC Filter Association** to associate the added MAC Filter group with SSID.

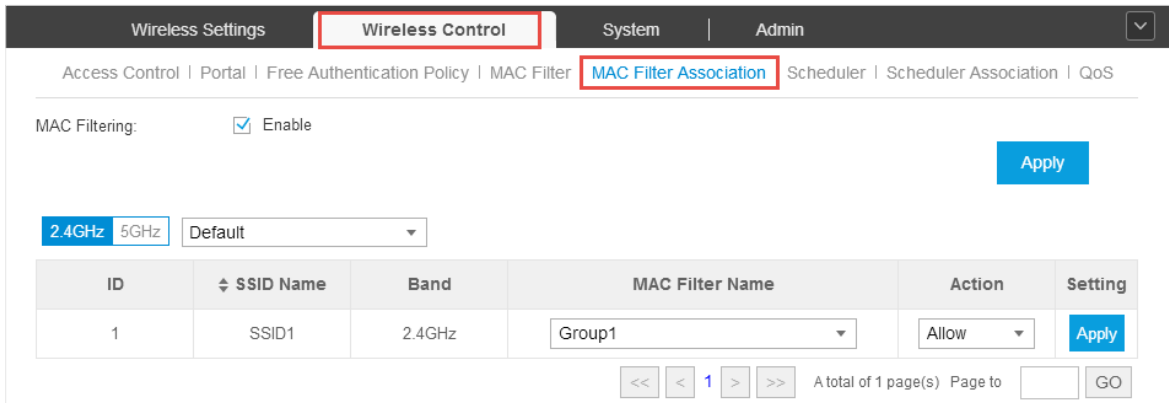

1) Check the box and click **Apply** to enable MAC Filtering function.

2) Select a band frequency (2.4GHz or 5GHz) and a WLAN group.

3) In the MAC Filter Name column of the specified SSID, select a MAC Filter group in the drop-down list. Then select **Allow/Deny** in the Action column to allow/deny the clients in the MAC Filter group to access the network.

4) Click **Apply** in the Setting column to save the configurations.

## 3.6 Scheduler

With the Scheduler, the EAPs or its' wireless network can automatically turn on or off at the time you set. For example, you can use this feature to schedule the radio to operate only during the office working time in order to achieve security goals and reduce power consumption. You can also use the Scheduler to make clients can only access the wireless network during the time period you set in the day.

Follow the steps below to configure Scheduler.

1. Go to **Wireless Control > Scheduler**.

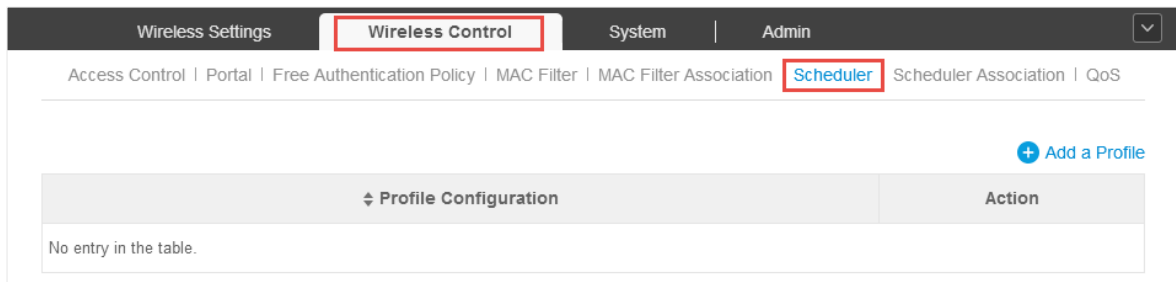

- 1) Click **+ Add a Profile** and specify a name for the profile.

The 'Add a Profile' dialog box is shown. It has a title bar with a close button. Below the title bar, there is a 'Profile Name:' label and a text input field containing 'Profile1'. At the bottom of the dialog is a blue 'Apply' button.

- 2) Click **Apply** and the profile will be added.

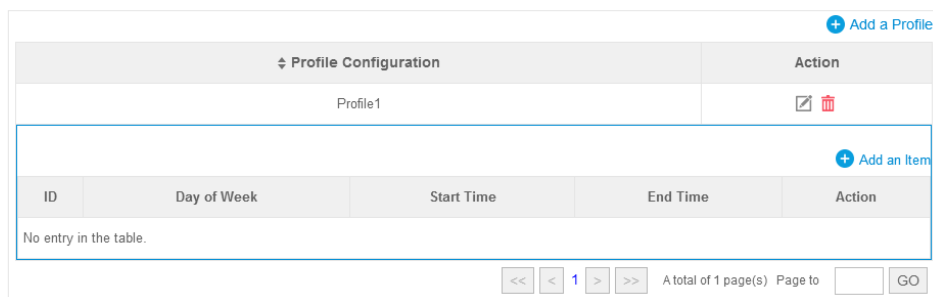

- 3) Click **+ Add an Item** and configure the parameters to specify a period of time.

The 'Edit Profile Time' dialog box is shown. It has a title bar with a close button. Below the title bar, there are radio buttons for 'Day Mode': 'Weekday' (selected), 'Weekend', 'Everyday', and 'Custom'. Below these are checkboxes for days of the week: 'Mon', 'Tue', 'Wed', 'Thu', 'Fri', 'Sat', and 'Sun'. Below the day mode is a 'Time:' section with a checkbox for 'all day-24 hours'. Below that are 'Start Time' and 'End Time' fields, each with a dropdown for hours and minutes. The start time is set to 08:00 and the end time is set to 21:00. At the bottom is a blue 'Apply' button.

- 4) Click **Apply** and the profile is successfully added in the list.

## 2. Go to Wireless Control > Scheduler Association.

The screenshot shows the 'Scheduler Association' configuration page. At the top, there are navigation tabs: 'Wireless Settings', 'Wireless Control' (highlighted with a red box), 'System', and 'Admin'. Below the tabs is a breadcrumb trail: 'Access Control | Portal | Free Authentication Policy | MAC Filter | MAC Filter Association | Scheduler | Scheduler Association' (highlighted with a red box) | QoS. The main configuration area includes a 'Scheduler' section with an 'Enable' checkbox checked. Below it is an 'Association Mode' dropdown menu with three options: 'Associated with SSID' (selected), 'Associated with SSID', and 'Associated with AP'. To the right of this dropdown is a blue 'Apply' button. Below the dropdown are two radio buttons for '2.4GHz' and '5GHz', and a 'Default' dropdown menu. At the bottom of the configuration area is a table with the following columns: 'ID', 'SSID Name', 'Band', 'Profile Name', 'Action', and 'Setting'. The table contains one row with ID '1', SSID Name 'SSID1', Band '2.4GHz', Profile Name 'Profile1', and Action 'Radio On'. There is a blue 'Apply' button in the 'Setting' column for this row. At the bottom right of the page, there are navigation controls: '<<', '<', '1', '>', '>>', 'A total of 1 page(s) Page to', a text input field, and a 'GO' button.

- 1) Check the box to enable Scheduler function.
- 2) Select **Associated with SSID** (the profile will be applied to the specific SSID on all the EAPs) or **Associated with AP** (the profile will be applied to all SSIDs on the specific EAP). Then click **Apply**.
- 3) Select a band frequency (2.GHz or 5GHz) and a WLAN group.
- 4) In the Profile Name column of the specified SSID or AP, select a profile you added before in the drop-down list. Select **Radio Off/Radio On** to turn on or off the wireless network during the time interval set for the profile.
- 5) Click **Apply** in the Setting column to save the configurations.

## 3.7 QoS

The EAP Controller software allows you to configure the quality of service (QoS) on the EAP device for optimal throughput and performance when handling differentiated wireless traffic, such as Voice-over-IP (VoIP), other types of audio, video, streaming media, and traditional IP data.

To configure QoS on the EAP device, you should set parameters on the transmission queues for different types of wireless traffic and specify minimum and maximum wait times (through contention windows) for transmission. In normal use, we recommend you keep the default values for the EAP devices and station EDCA (Enhanced Distributed Channel Access).

Follow the steps below to configure QoS.

### 1. Go to **Wireless Control > QoS**.

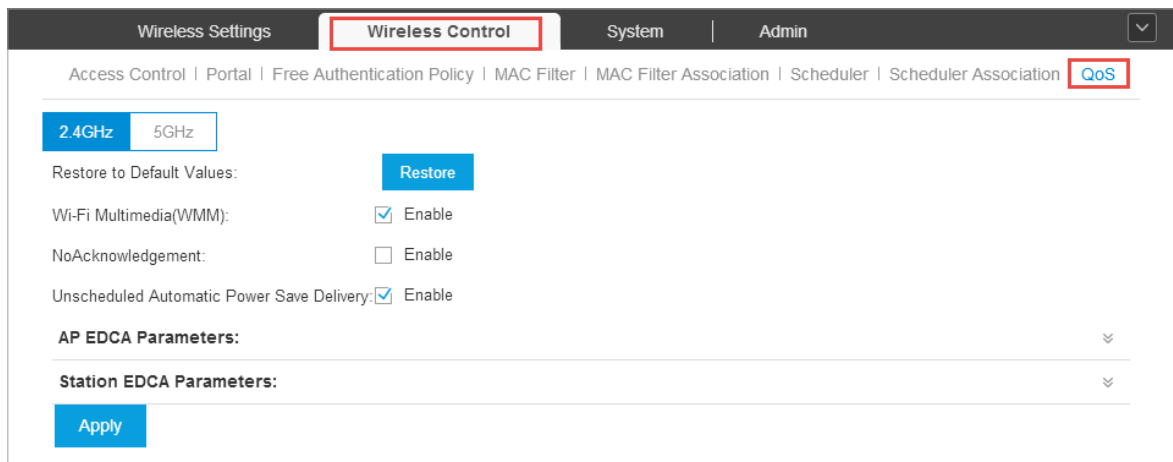

### 2. Enable or disable the following features.

<b>Wi-Fi Multimedia (WMM)</b>	By default enabled. With WMM enabled, the EAP devices have the QoS function to guarantee the high priority of the transmission of audio and video packets.  If 802.11n only mode is selected in 2.4GHz (or 802.11n only, 802.11ac only, or 802.11 n/ac mixed mode in 5GHz), the WMM should be enabled. If WMM is disabled, the 802.11n only mode cannot be selected in 2.4GHz (or 802.11n only, 802.11ac only, or 802.11 n/ac mixed mode in 5GHz).
<b>NoAcknowledgement</b>	By default disabled. You can enable this function to specify that the EAP devices should not acknowledge frames with QoSNoAck. NoAcknowledgement is recommended if VoIP phones access the network through the EAP device.
<b>Unscheduled Automatic Power Save Delivery</b>	By default enabled. As a power management method, it can greatly improve the energy-saving capacity of clients.

- Click **AP EDCA Parameters** and the following page will appear. AP EDCA parameters affect traffic flowing from the EAP device to the client station. We recommend you use the defaults.

**AP EDCA Parameters:**

Queue	Arbitration Inter_Frame Space	Minimum Contention Window	Maximum Contention Window	Maximum Burst
Data 0(Voice)	1	3	7	1504
Data 1(Video)	1	7	15	3008
Data 2(Best Effort)	3	15	63	0
Data 3(Background)	7	15	1023	0

### Queue

**Queue** displays the transmission queue. By default, the priority from high to low is Data 0, Data 1, Data 2, and Data 3. The priority may be changed if you reset the EDCA parameters.

**Data 0 (Voice)**—Highest priority queue, minimum delay. Time-sensitive data such as VoIP and streaming media are automatically sent to this queue.

**Data 1 (Video)**—High priority queue, minimum delay. Time-sensitive video data is automatically sent to this queue.

**Data 2 (Best Effort)**—Medium priority queue, medium throughput and delay. Most traditional IP data is sent to this queue.

**Data 3 (Background)**—Lowest priority queue, high throughput. Bulk data that requires maximum throughput and is not time-sensitive is sent to this queue (FTP data, for example).

### Arbitration Inter-Frame Space

A wait time for data frames. The wait time is measured in slots. Valid values for **Arbitration Inter-Frame Space** are from 0 to 15.

### Minimum Contention Window

A list to the algorithm that determines the initial random backoff wait time (window) for retry of a transmission.

This value can not be higher than the value for the **Maximum Contention Window**.

### Maximum Contention Window

The upper limit (in milliseconds) for the doubling of the random backoff value. This doubling continues until either the data frame is sent or the Maximum Contention Window size is reached.

This value must be higher than the value for the **Minimum Contention Window**.

### Maximum Burst

The **TXOP Limit** is a station EDCA parameter and only applies to traffic flowing from the client station to the EAP device. The Transmission Opportunity (TXOP) is an interval of time, in milliseconds, when a WME client station has the right to initiate transmissions onto the wireless medium (WM) towards the EAP device.

The valid values are multiples of 32 between 0 and 8192.

4. Click **Station EDCA Parameters** and the following page will appear. Station EDCA parameters affect traffic flowing from the client station to the EAP device. We recommend you use the defaults.

**Station EDCA Parameters:**

Queue	Arbitration Inter_Frame Space	Minimum Contention Window	Maximum Contention Window	TXOP Limit
Data 0(Voice)	2	3	7	1504
Data 1(Video)	2	7	15	3008
Data 2(Best Effort)	3	15	1023	0
Data 3(Background)	7	15	1023	0

#### Queue

**Queue** displays the transmission queue. By default, the priority from high to low is Data 0, Data 1, Data 2, and Data 3. The priority may be changed if you reset the EDCA parameters.

**Data 0 (Voice)**—Highest priority queue, minimum delay. Time-sensitive data such as VoIP and streaming media are automatically sent to this queue.

**Data 1 (Video)**—High priority queue, minimum delay. Time-sensitive video data is automatically sent to this queue.

**Data 2 (Best Effort)**—Medium priority queue, medium throughput and delay. Most traditional IP data is sent to this queue.

**Data 3 (Background)**—Lowest priority queue, high throughput. Bulk data that requires maximum throughput and is not time-sensitive is sent to this queue (FTP data, for example).

#### Arbitration Inter-Frame Space

A wait time for data frames. The wait time is measured in slots. Valid values for **Arbitration Inter-Frame Space** are from 0 to 15.

#### Minimum Contention Window

A list to the algorithm that determines the initial random backoff wait time (window) for retry of a transmission. This value can not be higher than the value for the **Maximum Contention Window**.

#### Maximum Contention Window

The upper limit (in milliseconds) for the doubling of the random backoff value. This doubling continues until either the data frame is sent or the Maximum Contention Window size is reached.

This value must be higher than the value for the **Minimum Contention Window**.

#### TXOP Limit

The **TXOP Limit** is a station EDCA parameter and only applies to traffic flowing from the client station to the EAP device. The Transmission Opportunity (TXOP) is an interval of time, in milliseconds, when a WME client station has the right to initiate transmissions onto the wireless medium (WM) towards the EAP device. The valid values are multiples of 32 between 0 and 8192.

5. Click **Apply** to save the configurations.

## 3.8 System

### Reboot Schedule

You can reboot all the EAPs in the network periodically as needed. Follow the steps below to configure Reboot Schedule.

1. Go to **System > Reboot Schedule**.

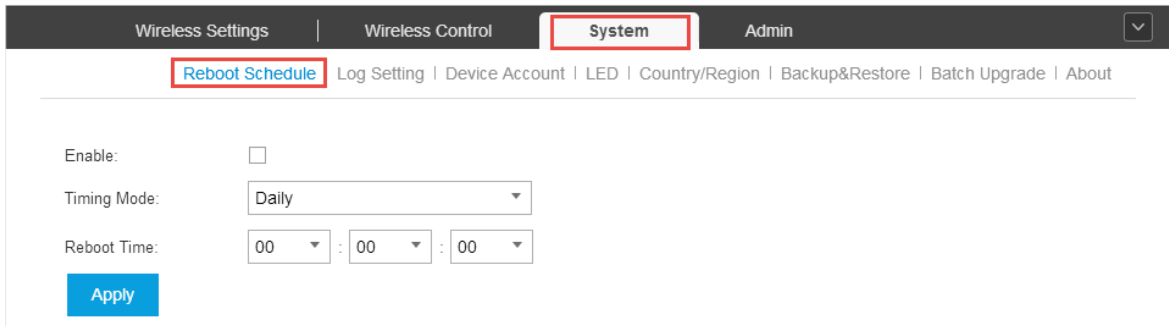

The screenshot shows the 'System' configuration page with the 'Reboot Schedule' sub-menu highlighted. The 'Enable' checkbox is unchecked. The 'Timing Mode' is set to 'Daily'. The 'Reboot Time' is set to 00:00:00. An 'Apply' button is visible at the bottom left.

2. Check the box to enable the function.
3. Choose **Daily, Weekly or Monthly** in the **Timing Mode** drop-down list and set a specific time to reboot the EAPs.
4. Click **Apply** to save the configurations.

### Log Setting

Follow the steps below to choose the way to receive system logs.

1. Go to **System > Log Setting**.

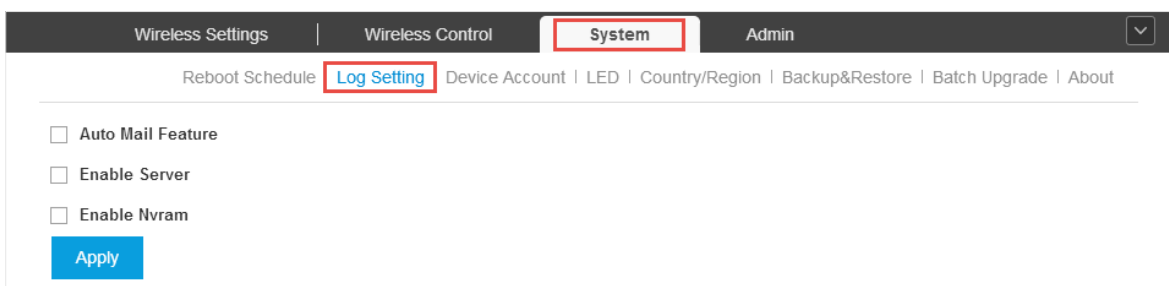

The screenshot shows the 'System' configuration page with the 'Log Setting' sub-menu highlighted. Three options are listed: 'Auto Mail Feature', 'Enable Server', and 'Enable Nvram', all with unchecked checkboxes. An 'Apply' button is visible at the bottom left.

2. Check the box to choose the way to receive system logs (you can choose more than one). Three ways are available: **Auto Mail Feature, Server and Nvram**.



- **Auto Mail Feature**

If Auto Mail Feature is enabled, system logs will be sent to a specified mailbox. Check the box to enable the feature and configure the parameters.

**Auto Mail Feature**

From Address:

To Address:

SMTP Server:

Enable Authentication

Username:

Password:

Confirm Password:

Time Mode:  Fixation Time  Period Time

Fixation Time:  :  (HH:MM)

<b>From Address</b>	Enter the sender's E-mail address.
<b>To Address</b>	Enter the receiver's E-mail address.
<b>SMTP Server</b>	Enter the IP address of the SMTP server.
<b>Enable Authentication</b>	You can check the box to enable mail server authentication. Enter the sender's mail account name and password.
<b>Time Mode</b>	Select Time Mode. System logs can be sent at specific time or time interval.
<b>Fixation Time</b>	If you select Fixation Time, specify a fixed time to send the system log mails. For example, 08:30 indicates that the mail will be sent at 8:30 am everyday. <div style="border: 1px solid #ccc; padding: 5px; margin: 5px 0;"> <p>Time Mode: <input checked="" type="radio"/> Fixation Time <input type="radio"/> Period Time</p> <p>Fixation Time: <input type="text" value="08"/> : <input type="text" value="30"/> (HH:MM)</p> </div>
<b>Period Time</b>	If you select Period Time, specify a period time to regularly send the system log mail. For example, 6 indicates that the mail will be sent every six hours. <div style="border: 1px solid #ccc; padding: 5px; margin: 5px 0;"> <p>Time Mode: <input type="radio"/> Fixation Time <input checked="" type="radio"/> Period Time</p> <p>Period Time: <input type="text" value="6"/> Hours(1-24)</p> </div>

- **Server**

If Server is enabled, system logs will be sent to a server. You can enable the feature and enter its IP address and port.

**Enable Server**

System Log Server IP:

System Log Server Port:

- **Nvram**

Nvram (Non-volatile Random Access Memory) is a RAM that can still save data even if a device is power off. All TP-LINK EAPs are equipped with Nvram. With this option enabled, the Nvram feature can help reserve the system logs when an EAP device is power off.

3. Click **Apply** to save the configurations.

## Device Account

When the EAP devices are adopted at the first time, their username and password will become the same as those of the EAP Controller which are specified at Basic Configurations. You can specify a new username and password for the adopted EAPs in batches.

Follow the steps below to change EAP devices' username and password.

1. Go to **System > Device Account**.

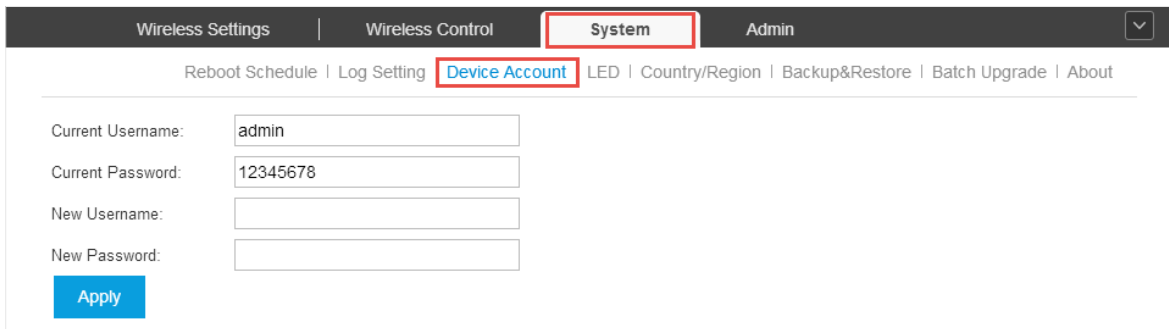

The screenshot shows the 'System' menu with 'Device Account' selected. The page contains the following fields and controls:

- Current Username:
- Current Password:
- New Username:
- New Password:
- 

2. Specify a new username and password for the EAP devices.

3. Click **Apply** to save the configurations.

### Note:

The new account will be applied to EAP devices but not the EAP Controller. To change the EAP Controller's username and password, please refer to [User Account](#).

## LED

Follow the steps below to turn on or off the LED lights of the EAPs.

1. Go to **System > LED**.

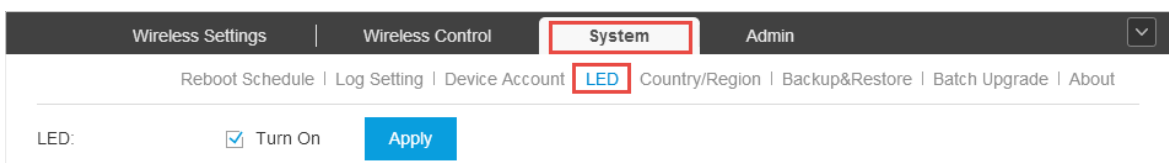

The screenshot shows the 'System' menu with 'LED' selected. The page contains the following controls:

- LED:  Turn On

2. By default, the LED lights are on. You can check the box to change the light status.

3. Click **Apply** to save the configurations.

## Country/Region

On the Country/Region page, you can re-select your country or region. Please comply with local laws. Incorrect selection may violate local regulations.

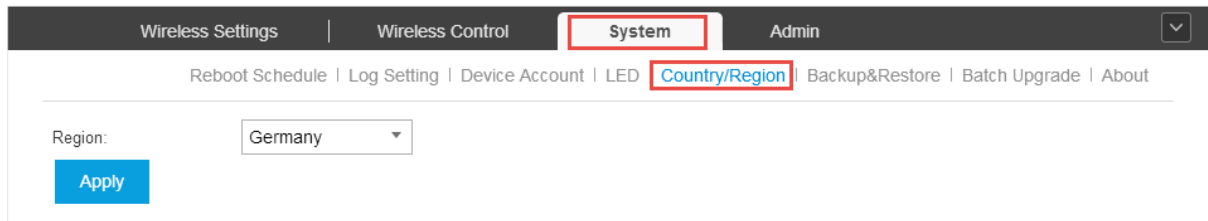

The screenshot shows the 'System' menu with 'Country/Region' highlighted. Below the navigation bar, there is a 'Region:' label and a dropdown menu currently set to 'Germany'. An 'Apply' button is located below the dropdown.

## Backup&Restore

You can save the current configuration of the EAPs as a backup file and if necessary, and restore the configuration using the backup file. We recommend you back up the settings before upgrading the device.

Follow the steps below to backup and restore the configuration.

1. Go to **System > Backup&Restore**.

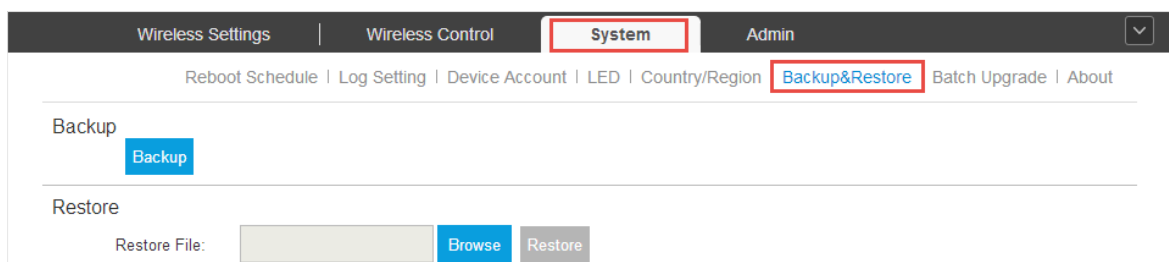

The screenshot shows the 'System' menu with 'Backup&Restore' highlighted. The page is divided into two sections: 'Backup' and 'Restore'. In the 'Backup' section, there is a 'Backup' button. In the 'Restore' section, there is a 'Restore File:' label, a text input field, a 'Browse' button, and a 'Restore' button.

2. Click **Backup** and save the backup file.
3. If necessary, click **Browse** to locate and choose the backup file. Then click **Restore** to restore the configuration.

## Batch Upgrade

Follow the steps below to upgrade the EAP devices in batches according to their model.

1. Visit <http://www.tp-link.com/en/support/download/> to download the latest firmware file of the corresponding model.
2. Go to **System > Batch Upgrade**.

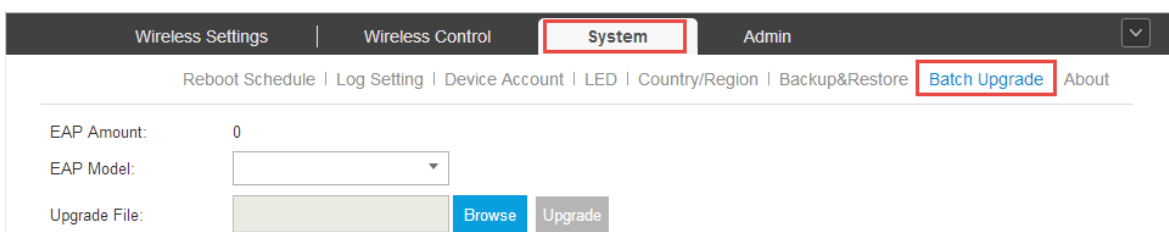

The screenshot shows the 'System' menu with 'Batch Upgrade' highlighted. The page contains the following fields: 'EAP Amount:' with a value of '0', 'EAP Model:' with a dropdown menu, and 'Upgrade File:' with a text input field, a 'Browse' button, and an 'Upgrade' button.

3. Select the EAP model.
4. Click **Browse** to locate and choose the proper firmware file for the model.
5. Click **Upgrade** to upgrade the device.
6. After upgrading, the device will reboot automatically.

 **Note:**

To avoid damage, please do not turn off the device while upgrading.

# 4 Configure the EAPs Separately

In addition to global configuration, you can configure the EAPs separately and the configuration results will be applied to a specified EAP device.

To configure a specified EAP, please click the EAP's name on the **Access Points** tab or click  of connected EAP on the map. Then you can view the EAP's detailed information and configure the EAP on the pop-up window.

This chapter includes the following contents:

- [View the Information of the EAP](#)
- [View Clients Connecting to the EAP](#)
- [Configure the EAP](#)

## 4.1 View the Information of the EAP

### Overview

Click **Overview** to view the basic information including EAP's MAC address (or name you set), IP address, model, firmware version, the usage rate of CPU and Memory and uptime (indicates how long the EAP has been running without interruption).

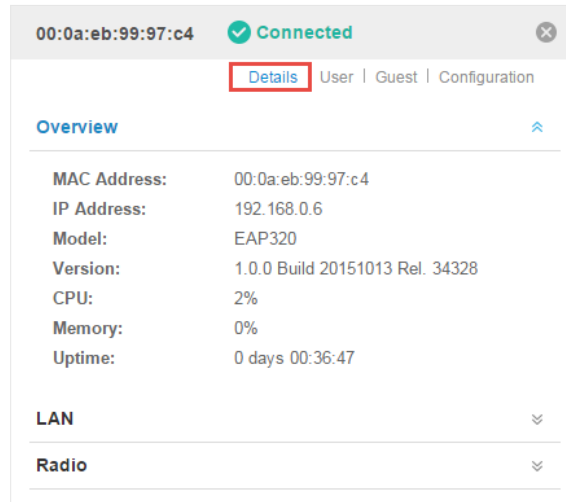

### LAN

Click **LAN** to view the traffic information of the LAN port, including the total number of packets, the total size of data, the total number of packets loss, and the total size of error data in the process of receiving and transmitting data.

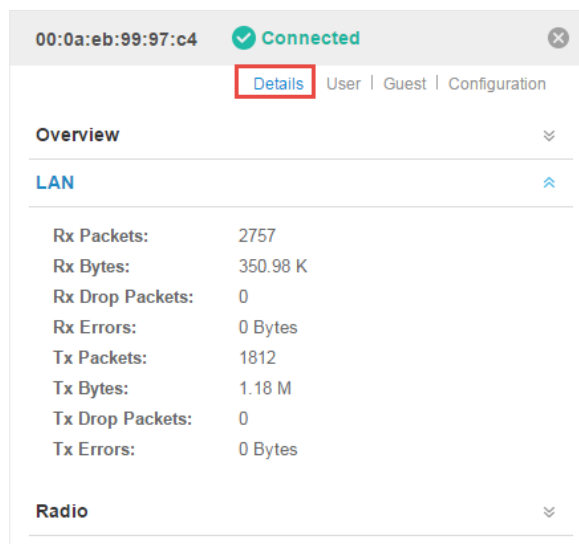

## Radio

Click **Radio** to view the radio information including the frequency band, the wireless mode, the channel width, the channel, and the transmitting power. At 2.4GHz, you can also view parameters of receiving/transmitting data.

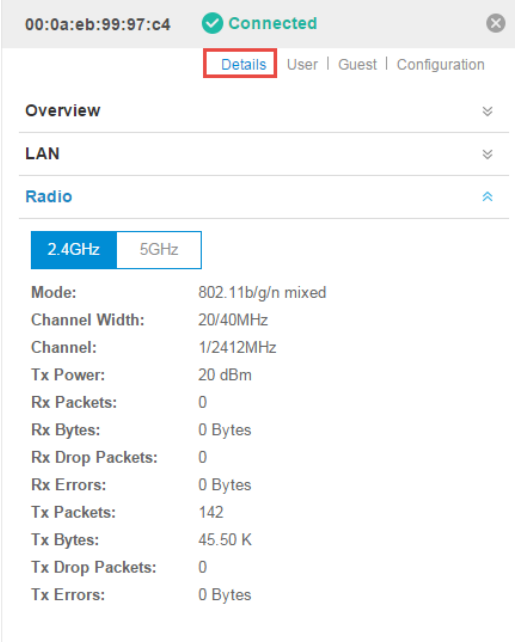

The screenshot shows a web interface for a network device. At the top, the MAC address is 00:0a:eb:99:97:c4 and the status is 'Connected'. There are tabs for 'Details', 'User', 'Guest', and 'Configuration', with 'Details' selected. Below the tabs are sections for 'Overview', 'LAN', and 'Radio'. The 'Radio' section has two tabs: '2.4GHz' (selected) and '5GHz'. The '2.4GHz' section displays the following information:

- Mode: 802.11b/g/n mixed
- Channel Width: 20/40MHz
- Channel: 1/2412MHz
- Tx Power: 20 dBm
- Rx Packets: 0
- Rx Bytes: 0 Bytes
- Rx Drop Packets: 0
- Rx Errors: 0 Bytes
- Tx Packets: 142
- Tx Bytes: 45.50 K
- Tx Drop Packets: 0
- Tx Errors: 0 Bytes

## 4.2 View Clients Connecting to the EAP

### User

The **User** page displays the information of clients connecting to the SSID with Portal disabled, including their MAC addresses and connected SSIDs. You can click the client's MAC address to get its connection history.

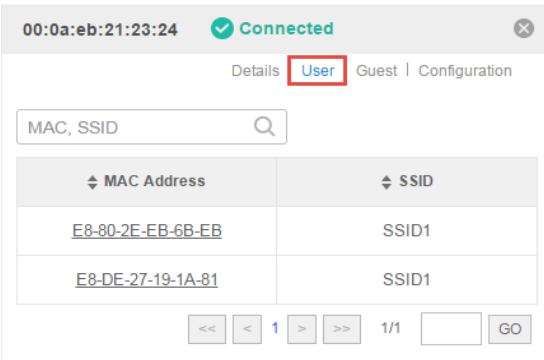

The screenshot shows a web interface for a network device. At the top, the MAC address is 00:0a:eb:21:23:24 and the status is 'Connected'. There are tabs for 'Details', 'User', 'Guest', and 'Configuration', with 'User' selected. Below the tabs is a search bar labeled 'MAC, SSID'. Below the search bar is a table with two columns: 'MAC Address' and 'SSID'. The table contains two rows of data:

MAC Address	SSID
<a href="#">E8-80-2E-EB-6B-EB</a>	SSID1
<a href="#">E8-DE-27-19-1A-81</a>	SSID1

At the bottom of the table, there are navigation controls: '<<', '<', '1', '>', '>>', '1/1', and a 'GO' button.

## Guest

The **Guest** page displays the information of clients connecting to the SSID with Portal enabled, including their MAC addresses and connected SSIDs. You can click the client's MAC address to get its connection history.

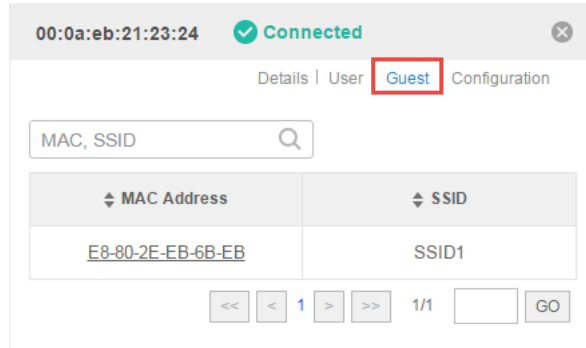

## 4.3 Configure the EAP

The **Configuration** page allows you to configure the EAP. All the configurations will only take effect on this device.

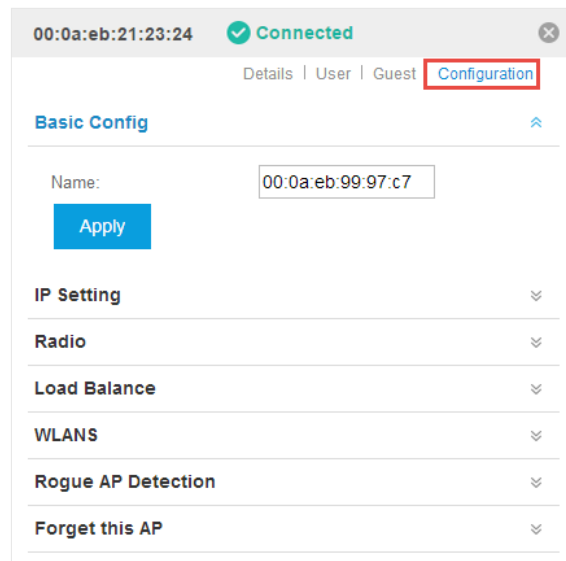

### Basic Config

Here you can change the name of the EAP.

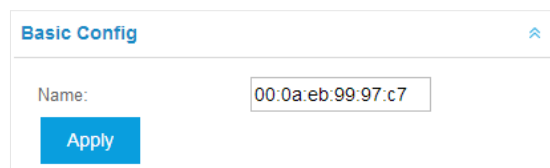



## IP Setting

You can configure an IP address for this EAP. Two options are provided: DHCP and Static.

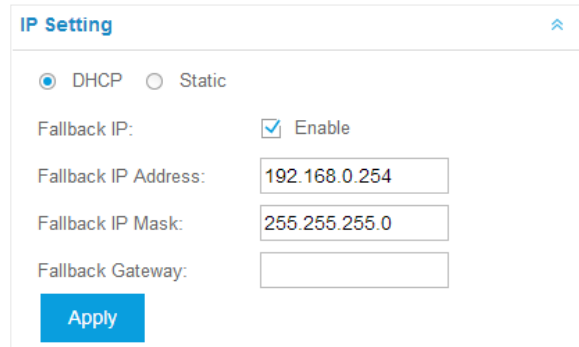

**IP Setting**

DHCP  Static

Fallback IP:  Enable

Fallback IP Address:

Fallback IP Mask:

Fallback Gateway:

**Apply**

- **Get a Dynamic IP Address From the DHCP Server**

1. Configure your DHCP server.
2. Select **DHCP** on the page above.
3. Enable the Fallback IP feature. When the device cannot get a dynamic IP address, the fallback IP address will be used.
4. Set IP address, IP mask and gateway for the fallback address and click **Apply**.

- **Manually Set a Static IP Address for the EAP**

1. Select **Static**.
2. Set the IP address, IP mask and gateway for the static address and click **Apply**.

## Radio

Radio settings directly control the behavior of the radio in the EAP device and its interaction with the physical medium; that is, how and what type of signal the EAP device emits.

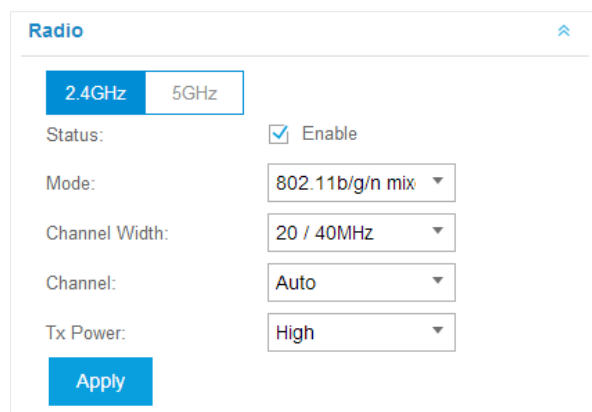

**Radio**

2.4GHz  5GHz

Status:  Enable

Mode:

Channel Width:

Channel:

Tx Power:

**Apply**

Select the frequency band (2.4GHz/5GHz) and configure the following parameters.

<b>Status</b>	Enabled by default. If you disable the option, the radio on the frequency band will turn off.
<b>Mode</b>	<p>Select the IEEE 802.11 mode the radio uses.</p> <p>When the frequency of 2.4GHz is selected, 802.11b/g/n mixed, 802.11b/g mixed, and 802.11n only modes are available:</p> <p><b>802.11b/g/n mixed:</b> All of 802.11b, 802.11g, and 802.11n clients operating in the 2.4GHz frequency can connect to the EAP device. We recommend you select the 802.11b/g/n mixed mode.</p> <p><b>802.11b/g mixed:</b> Both 802.11b and 802.11g clients can connect to the EAP device.</p> <p><b>802.11n only:</b> Only 802.11n clients can connect to the EAP device.</p> <p>When the frequency of 5GHz is selected, 802.11 n/ac mixed, 802.11a/n mixed, 802.11 ac only, 802.11a only, and 802.11n only modes are available:</p> <p><b>802.11n/ac mixed:</b> Both 802.11n clients and 802.11ac clients operating in the 5GHz frequency can connect to the EAP device.</p> <p><b>802.11a/n mixed:</b> Both 802.11a clients and 802.11n clients operating in the 5GHz frequency can connect to the EAP device.</p> <p><b>802.11ac only:</b> Only 802.11ac clients can connect to the EAP device.</p> <p><b>802.11a only:</b> Only 802.11a clients can connect to the EAP device.</p> <p><b>802.11n only:</b> Only 802.11n clients can connect to the EAP device.</p>
<b>Channel Width</b>	<p>Select the channel width of the EAP device.</p> <p>For EAP 110/120/220, the options includes <b>20MHz, 40MHz and 20/40MHz</b>.</p> <p>For EAP 320, the options includes <b>20MHz, 40MHz, 80MHz and 20/40/80MHz</b>.</p> <p>The 20/40 MHz and 20/40/80MHz channels enable higher data rates but leave fewer channels available for use by other 2.4GHz and 5GHz devices. When the radio mode includes 802.11n, we recommend you set the channel bandwidth to 20/40 MHz or 20/40/80MHz to improve the transmission speed.</p>
<b>Channel</b>	<p>Select the channel used by the EAP device to improve wireless performance. The range of available channels is determined by the radio mode and the country setting. If you select Auto for the channel setting, the EAP device scans available channels and selects a channel where the least amount of traffic is detected.</p>
<b>Tx Power</b>	<p>Select the TX Power (transmit power) in the 4 options: <b>Low, Medium, High</b> and <b>Custom</b>. Low, Medium and High are based on the Max TxPower (maximum transmit power). It may vary among different countries and regions).</p> <p><b>Low:</b> Max TxPower * 20% (round off the value)</p> <p><b>Medium:</b> Max TxPower * 60% (round off the value)</p> <p><b>High:</b> Max TxPower</p> <p><b>Custom:</b> Enter a value manually.</p>

## Load Balance

By setting the maximum number of clients accessing the EAPs, Load Balance helps to achieve rational use of network resources.

Load Balance

2.4GHz 5GHz

Max Associated Clients:  Enable

1 (1-99)

RSSI Threshold:

0 (-95-0 dBm)

Apply

Select the frequency band (2.4GHz/5GHz) and configure the parameters.

---

Max Associated Clients	Enable this function and specify the maximum number of connected clients. While more clients requesting to connect, the EAP will disconnect those with weaker signals.
RSSI Threshold	Enable this function and enter the threshold of RSSI (Received Signal Strength Indication). When the clients' signal is weaker than the <b>RSSI Threshold</b> you've set, the clients will be disconnected from the EAP.

---

## WLANS

You can specify a different SSID name and password to override the previous SSID. After that, clients can only see the new SSID and use the new password to access the network. Follow the steps below to override the SSID.

WLANS

2.4GHz 5GHz

WLAN Group: Default

Name	Overrides	Action
SSID1		

1. Select the frequency band and WLAN group.

2. Click  and the following window will pop up.

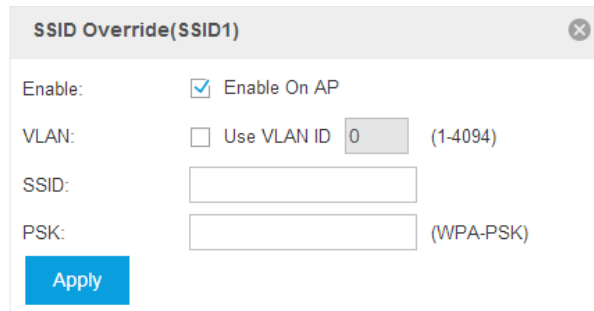

The image shows a configuration window titled "SSID Override(SSID1)". It contains the following fields and options:

- Enable:** A checked checkbox labeled "Enable On AP".
- VLAN:** An unchecked checkbox labeled "Use VLAN ID" followed by a text input field containing "0" and "(1-4094)".
- SSID:** A text input field.
- PSK:** A text input field followed by "(WPA-PSK)".
- Apply:** A blue button at the bottom left.

3. Check the box to enable the feature.

4. You can join the overridden SSID in to a VLAN. Check the **Use VLAN ID** box and specify a VLAN ID.

5. Specify a new name and password for the SSID.

6. Click **Apply** to save the configuration.

### Rouge AP Detection

With this option enabled, the EAP device will detect rouge APs in all channels.

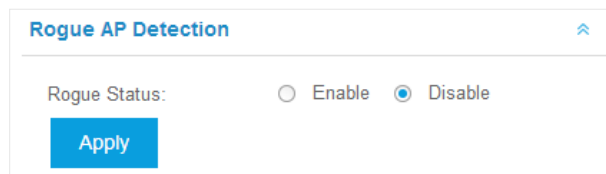

The image shows a configuration window titled "Rogue AP Detection". It contains the following options:

- Rogue Status:** Two radio buttons, "Enable" (unselected) and "Disable" (selected).
- Apply:** A blue button at the bottom left.

### Forget this AP

If you no longer want to manage this EAP, you may remove it. All the configurations and history about this EAP will be deleted. It is recommended to back up the configurations of this EAP before you forget it.

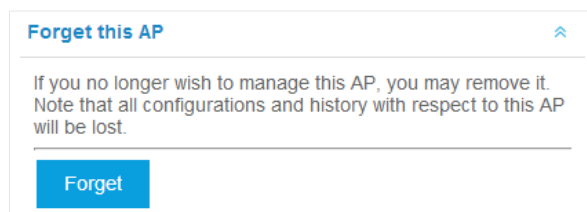

The image shows a confirmation window titled "Forget this AP". It contains the following text:

If you no longer wish to manage this AP, you may remove it. Note that all configurations and history with respect to this AP will be lost.

**Forget**

# 5 **Manage the EAP Controller**

This chapter mainly introduces how to manage the user account and configure system settings. This chapter includes the following contents.

- *Information About the Software*
- *User Account*
- *Controller Settings*

## 5.1 Information About the Software

You can view the EAP Controller's version and copyright information on the **About** page.

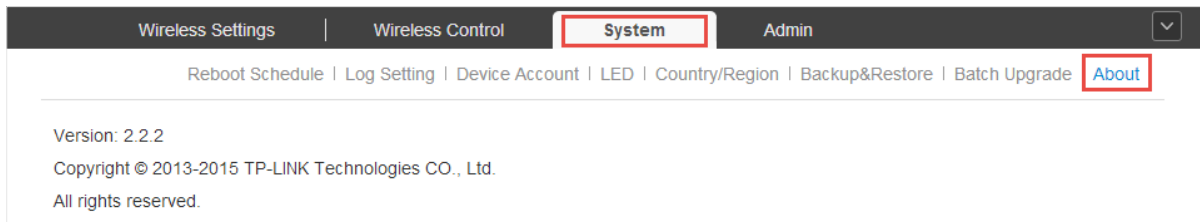

## 5.2 User Account

You can use different user account to log in to the EAP Controller. User has three roles: administrator, operator and observer. The administration authority varies among different roles.

<b>Administrator</b>	The first administrator account is created in the Basic Configuration process and this account can not be deleted. An administrator can change the settings of the EAP network and create and delete user accounts.
<b>Operator</b>	An operator account can be created or deleted by the administrator. The operator can change the settings of the EAP network.
<b>Observer</b>	An observer account can be created or deleted by the administrator. The observer can only view the status and settings of the EAP network but not change the settings.

Follow the steps below to add user account.

### 1. Go to Admin > User Setting.

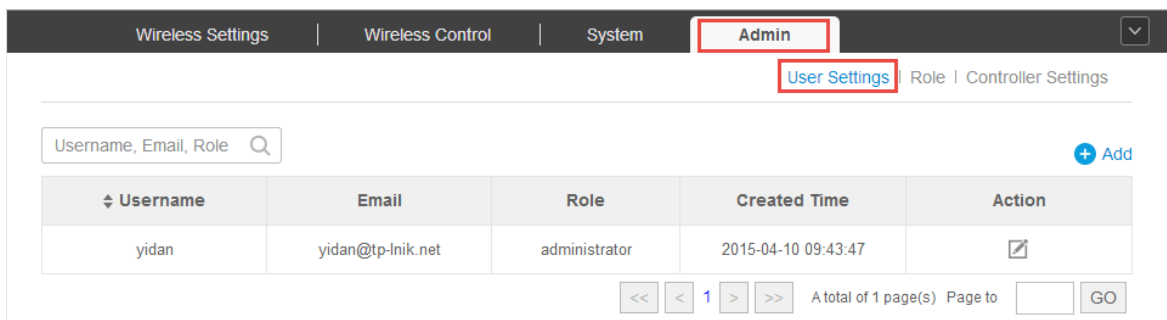

2. Click **+ Add** and the following window will pop up.

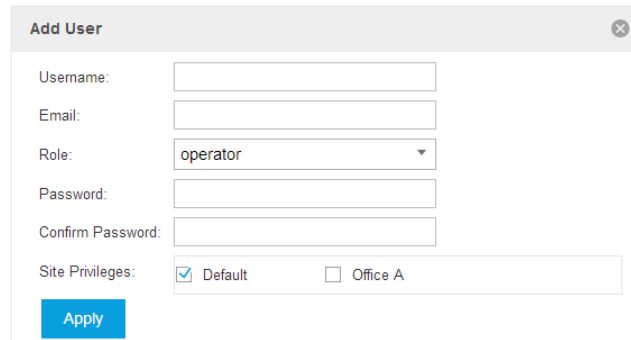

3. Specify the username, Email and password of the account.

4. Select the role from the drop-down list.

- If you select **operator** or **observer**, you also need to select the **Site Privileges**.
- If you select **administrator**, the **Site Privileges** option will not appear and all sites are available for the administrator user.

5. Click **Apply** to add the user account.

**Note:**

You can refer to the **Role** page to view the user role's type, description information, permission scope and created time.

## 5.3 Controller Settings

You can configure the EAP Controller's hostname and IP address. In addition, we recommend you configure the Mail server to reset your login password when you forget it.

### Configure Controller Hostname/IP

Follow the steps below to configure the hostname or IP address of the EAP Controller.

1. Go to **Admin > Controller Settings** and click **EAP Controller**.

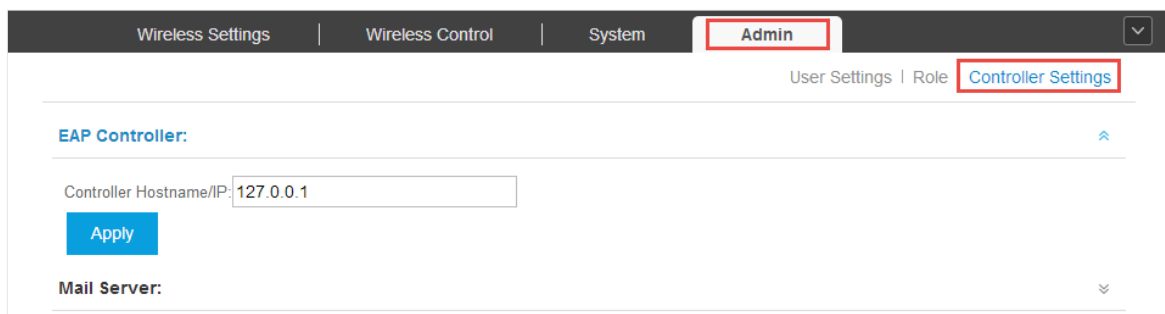

2. Enter the hostname or IP address of the EAP Controller.

3. Click **Apply** to save the configuration.

## Configure Mail Server

With the Mail Server, you can reset the password of the user account and receive notifications from the EAP Controller. It is different from the SMTP Server, which is just for the syslog emails sending.

Follow the steps below to configure mail server.

1. Go to **Admin > Controller Settings**.
2. Click **Mail Server**, check the box to enable SMTP Server, and then the following screen will appear.

The screenshot shows the 'Admin' tab selected in the top navigation bar. Below it, 'Controller Settings' is highlighted. The 'Mail Server' section is expanded, showing the following configuration options:

- Enable SMTP Server
- Mail Server: [Text Input Field]
- Port: [Text Input Field with value 25]
- Enable SSL
- Enable Auth
- Username: [Text Input Field]
- Password: [Text Input Field]
- Specify Sender Address: [Text Input Field]
- [Apply Button]

3. Configure the following parameters.

<a href="#">Mail Server</a>	Enter the IP address or domain of SMTP Server.
<a href="#">Port</a>	The default is 25. You can enable SSL (Security Socket Layer) to enhance secure communications over the Internet. If SSL is enabled, the port number will automatically change to 465.
<a href="#">Enable Auth</a>	Select this option to enable authentication.
<a href="#">Username/Password</a>	If you enable authentication, enter the username and password required by the mail server.
<a href="#">Specify Sender Address</a>	Specify the sender's mail address. Enter the email address that will appear as the sender of the warning email.

4. Click **Apply** to save the configuration.

### Note

Specify the account email address based on the Mail server to receive the notifications.



# 6 Application Example

A restaurant has a wireless network with three EAPs managed by the EAP Controller. The network administrator wants to :

- Monitor the EAPs with the Map.
- Enable Portal function to drive customers' attention to the ads of the supermarket when customers attempt to access the wireless network. The costumers need to use a simple password to pass the authentication.
- Allow the employees of the restaurant to access the network resources without portal authentication.
- Schedule the radio to operate only during the working time (8:00 am to 22:00 pm) in order to reduce power consumption.

Follow the steps below to achieve the requirements above.

## 6.1 Basic Configuration

Follow the steps below to do the basic configuration.

1. Connect the hardware by referring to the following topology.

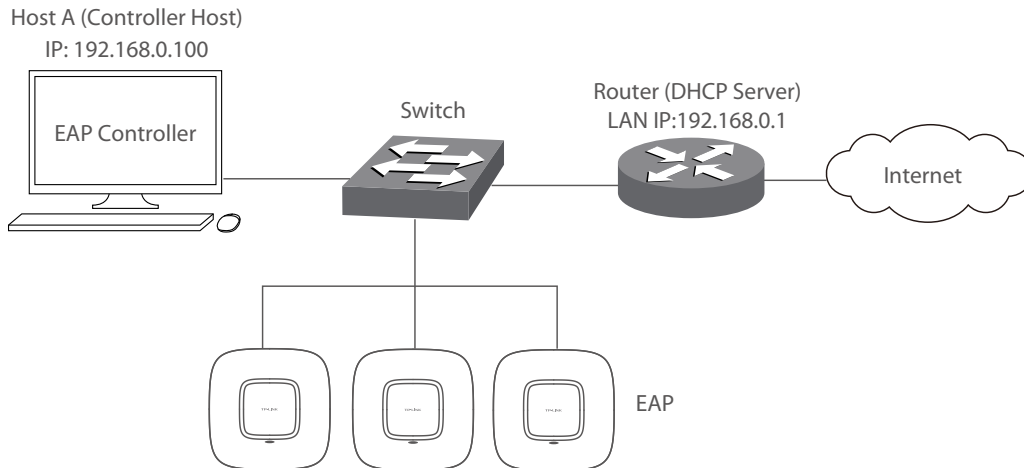

2. Install the EAP Controller on Host A.
3. Launch the software and follow the instructions to complete some initial configurations.
4. Log into the management interface.
5. Adopt the pending EAP devices.

## 6.2 Advanced Settings

After the basic configuration, refer to the following content to meet the network administrator's requirements.

### Monitor the EAPs with Map

Follow the steps below to create a map and monitor the EAPs with the map.

1. Go to the **Map**.
2. Import a local map and set the map scale.
3. Drag the EAPs to the appropriate locations on the map.

4. Click **Coverage** and you can see the representation of the EAPs' wireless coverage.

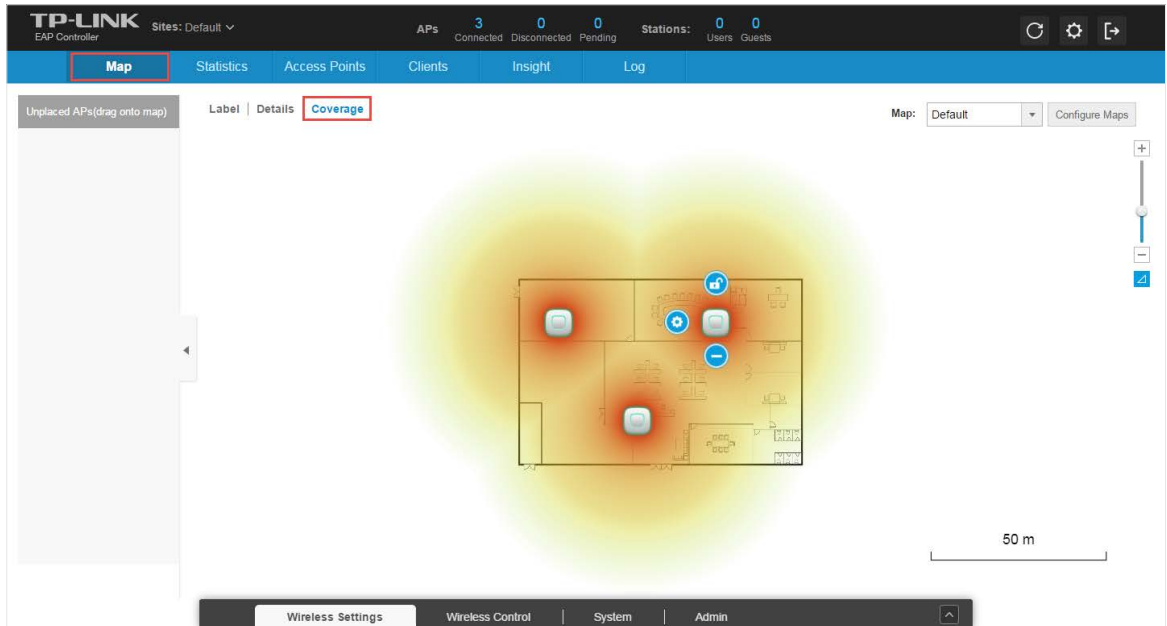

## Configure Portal Authentication

Follow the steps below to configure Portal function.

1. Open the global configuration window and go to **Portal**.

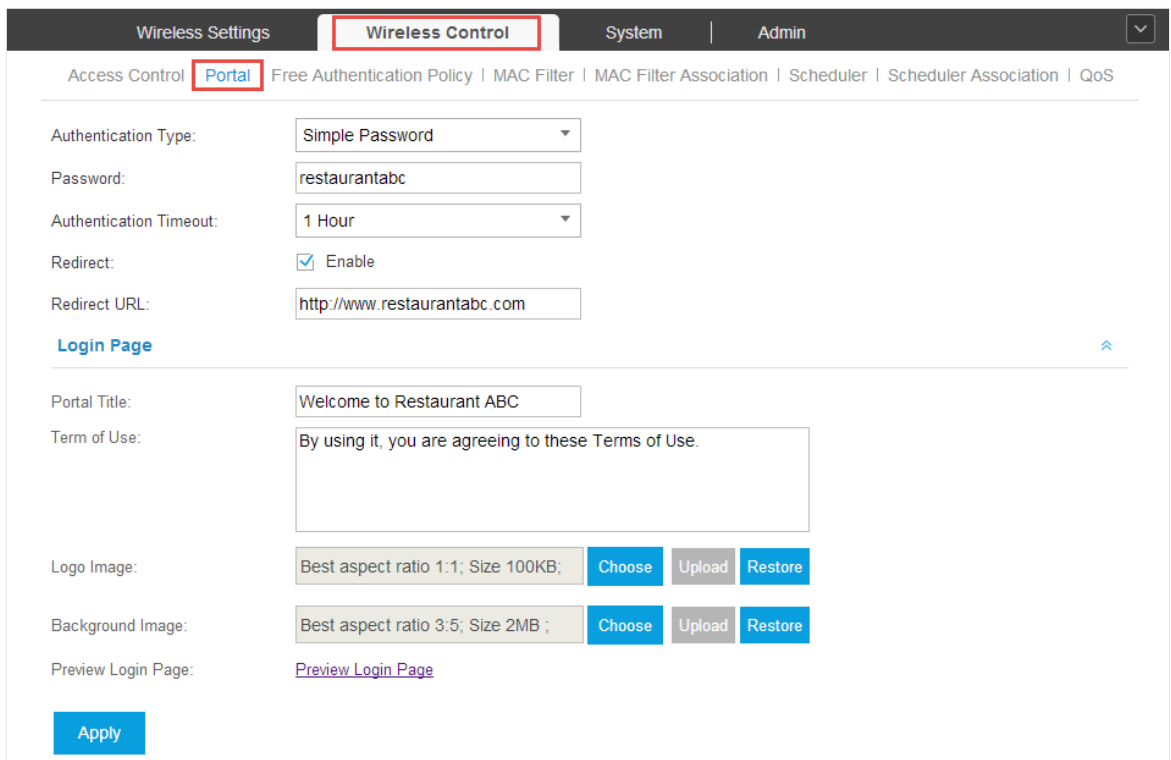

Configure the parameters.

- 1) Specify a simple password for the guests.
  - 2) Select the **Authentication Timeout**. For example, 1 Hour is suitable for the customers at the restaurant.
  - 3) Enable the **Redirect** to drive the costumers to the restaurant's homepage after successful login. We can put some promotion information on the page.
  - 4) Configure the **Login Page**.
2. Click **Apply** to save the configuration.
  3. Click **Preview Login Page** and you can preview the login page for the customers.

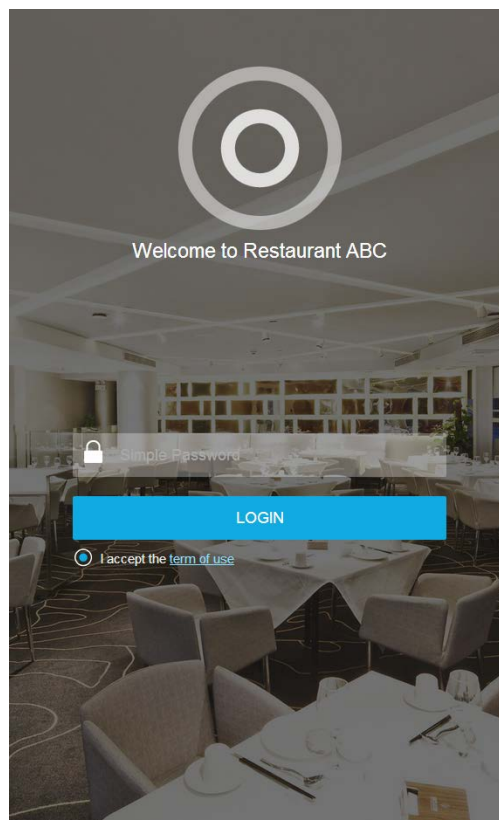

4. Go to **Basic Wireless Setting** and edit the SSID we created in the basic configuration.

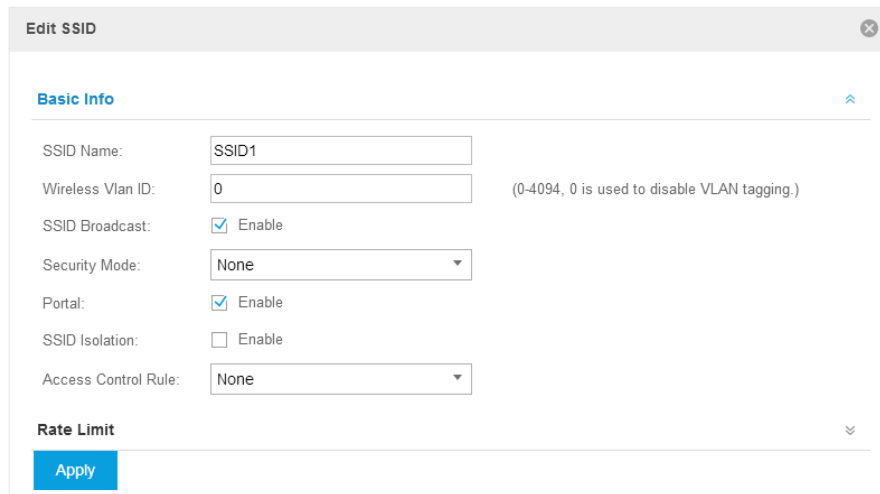

5. Edit the parameters as follows.

- 1) To make it easier for customers to connect, change the **Security Mode** from **WPA-PSK** to **None**. Customers can connect to the EAPs without password and be redirected to the Portal Authentication where the correct password will be required.
- 2) Enable **Portal**.

6. Click **Apply** to save the configuration.

### Create a SSID for the Employees

We have created a SSID in the basic configuration for the customers. Here we need to create another SSID for the employees to allow them to access the network without portal authentication. In addition, the new SSID should be invisible for the customers.

Follow the steps below to create a SSID for the employees.

1. Open the global configuration window and go to **Basic Wireless Setting**.
2. Click **Add** to add a new SSID.

Configure the parameters.

- 1) Disable the **SSID Broadcast** to hide this SSID from the customers.
- 2) Specify the **SSID Name**, **Security Mode** and **Wireless Password**. Let the employees manually enter the SSID name and password, and choose the security mode you set to access the network.
- 3) Keep the **Portal** disabled for this SSID.
- 4) Click **Apply** to save the configuration.

## Configure Scheduler

Follow the steps below to schedule the radio to operate only during the working time (from 8:00 to 22:00).

1. Open the global configuration window and go to **Scheduler**.
  - 1) Add a profile.

2) Add an item for the profile. The parameters are set as shown on the following screen.

**Add an Item**

Day Mode:  Weekday  Weekend  Everyday  Custom

Mon  Tue  Wed  Thu  Fri  Sat  Sun

Time:  all day-24 hours

Start Time: 08 : 00

End Time: 22 : 00

**Apply**

2. Go to **Scheduler Association** tab.

Wireless Settings | **Wireless Control** | System | Admin

Access Control | Portal | Free Authentication Policy | MAC Filter | MAC Filter Association | Scheduler | **Scheduler Association** | QoS

Scheduler:  Enable

Association Mode: Associated with SSID

**Apply**

2.4GHz 5GHz Default

ID	SSID Name	Band	Profile Name	Action	Setting
1	SSID1	2.4GHz	Working-time on	Radio On	<b>Apply</b>
2	SSID2	2.4GHz	Working-time on	Radio On	<b>Apply</b>

<< < 1 > >> A total of 1 page(s) Page to  **GO**

- 1) Enable the function and select **Associated with SSID**. Click **Apply**.
- 2) In the **Profile Name** column of both SSIDs, select the profile we just created.
- 3) In the **Action** column of both SSIDs, select **Radio On**.
- 4) Click **Apply** in the **Setting** column of both SSIDs.
- 5) Select **5GHz** and do the same configurations as above.