

## Quick Installation Guide

300Mbps Wireless N Router

MODEL NO. TL-WR940N/TL-WR941ND

## Package Contents

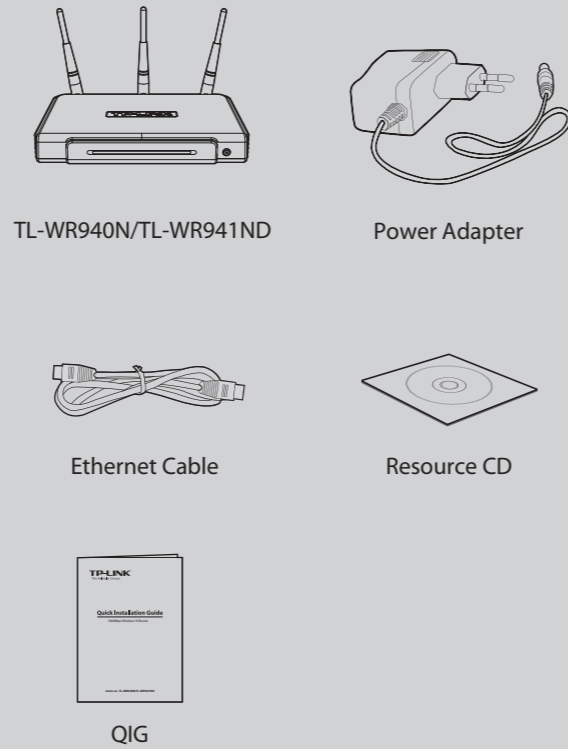

## 1 Hardware Connection

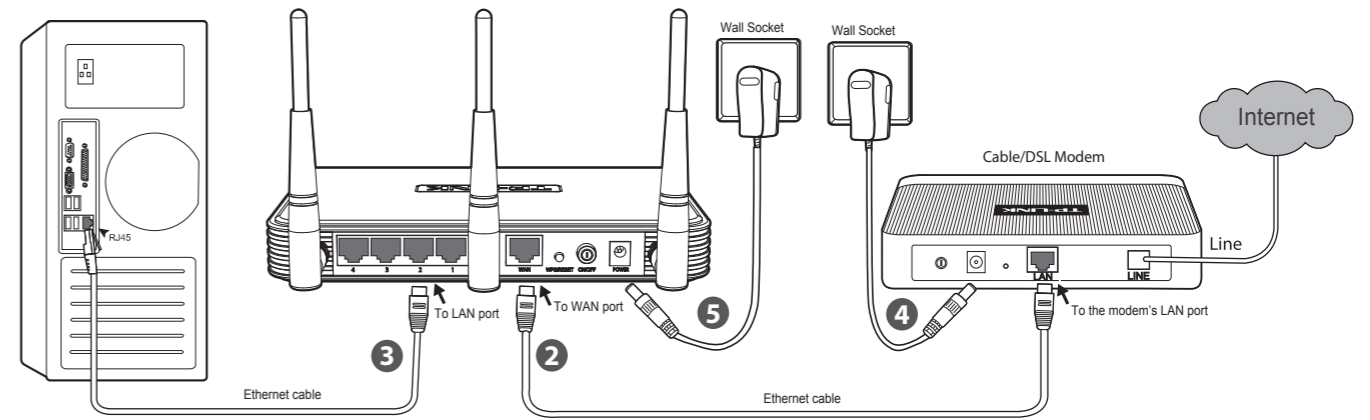

- 1 Power off your modem.
- 2 Connect the **WAN** port on your router to the modem's **LAN** port with an Ethernet cable.
- 3 Connect your computer to one of the LAN ports labeled **1~4** on the router with an Ethernet cable.
- 4 Power on the modem and wait for one minute.
- 5 Plug the provided power adapter into the **POWER** jack on the back of the router and the other end to a standard electrical wall socket. Press the **ON/OFF** button to power on the router.



1. Please confirm that the **Wireless** button (in the front panel) is **ON** so that client devices can connect to the router wirelessly.
2. The product model shown in this QIG is TL-WR941ND, as an example.

## 2 Configuration for Windows with Setup Wizard



If you are using a MAC/Linux or a windows computer without a CD drive to run the mini CD, please refer to **Appendix 1** for configuration.

- 1 Insert the TP-LINK Resource CD into the CD-ROM drive.

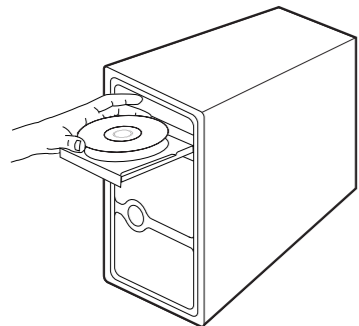

- 2 Select **TL-WR941ND** and click **Easy Setup Assistant**.



- 3 Please choose your language and click **START** to continue.



- 4 After confirming the hardware connection and the status of LEDs, please click **NEXT** to continue.

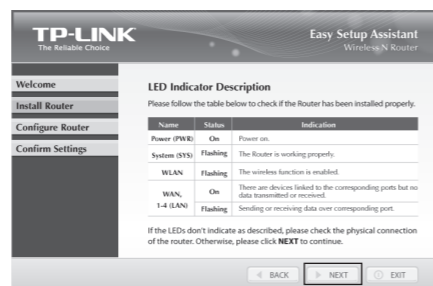

- 5 After the connectivity is checked successfully, please click **NEXT**.

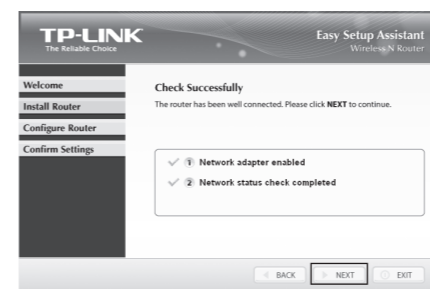

- 6 Select the connection type your ISP provides and click **NEXT**. Here we take **Dynamic IP** for example.



- 7 You can rename your wireless network on this page. The default wireless name is TP-LINK\_XXXXXX. Click **NEXT** to continue.

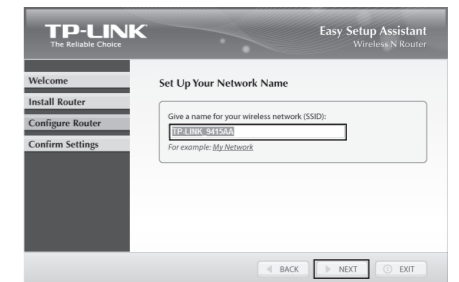

- 8 You are recommended to select **Most Security (WPA2-PSK)** to secure your wireless network.

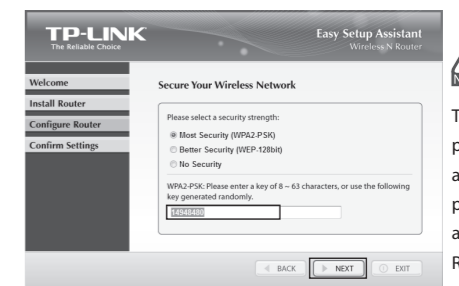

The Router is pre-encrypted. The default wireless password, the same as the PIN code, is printed on the label at the bottom of the Router.

(To be continued)

## 2 Configuration for Windows with Setup Wizard

- 9 After confirming the configurations, click **NEXT** to continue.

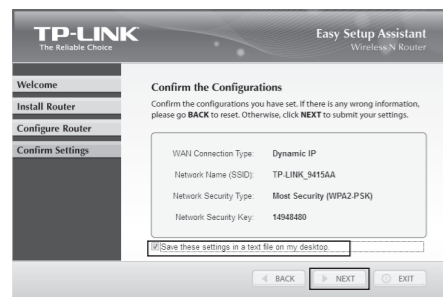

**Note** You can save these settings in a text file on your desktop. If you forget the Network Security Key, you can check the **Router Settings.txt**.

- 10 After the configuration is completed successfully, please click **NEXT**.

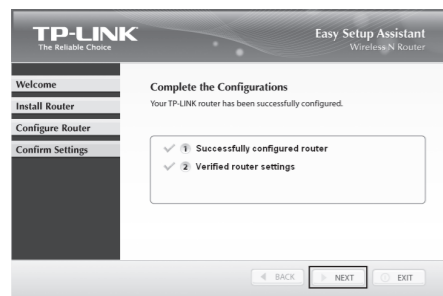

- 11 If your client devices support WPS(Wi-Fi Protected Setup), you can add your device to the network by pushing the WPS button. Then click **NEXT**.

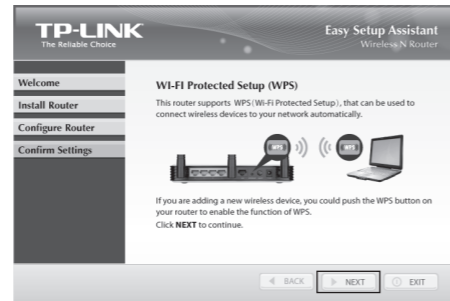

- 12 Click **FINISH** to complete the setup.

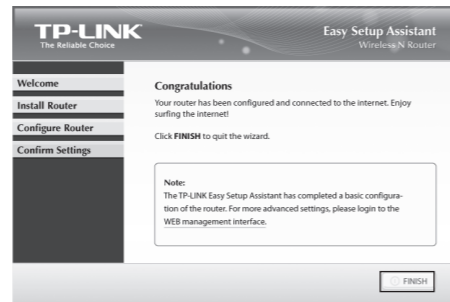

**Note** You can click **WEB management interface** for more advanced settings.

## Appendix 1: Configuring the Router via Web Management Page (for Mac OS X/Linux users or Windows users who can't run the mini CD)

- 1 Open your browser and type <http://tplinklogin.net> in the address field, then use the user name **admin** and password **admin** to log in.



- 2 Click **Quick Setup** in the main menu and click **Next**.

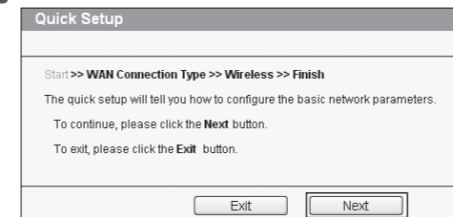

- 3 Select the WAN connection type provided by your ISP. You can select **Auto-Detect** and click **Next** to continue. Here we take **Dynamic IP** as an example.

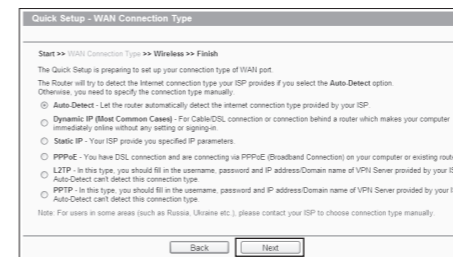

- 4 You can rename your wireless network and create your own password on this page. The default wireless name is TP-LINK\_XXXXXX, and the default wireless password, the same as the PIN code, is printed on the bottom label. Click **Next** to continue.

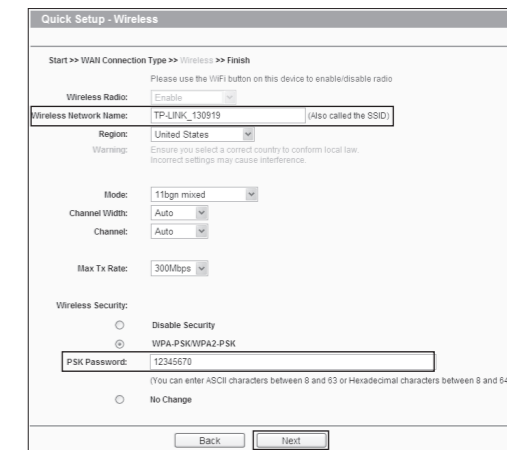

- 5 Click **Finish** or **Reboot** to make your settings take effect.



## Appendix 2: Troubleshooting

### 1. What can I do if I cannot access the Internet?

- Check to verify all connections are connected properly. Try with different Ethernet cables to ensure they are working properly.
- Check to see if you are able to access the Router's web management page. If not, please refer to "What can I do if I cannot open the web management window?".
- Please log in the web management page (<http://tplinklogin.net>), click the menu "Network > WAN", and ensure that the WAN Connection Type is Dynamic IP; this is the suitable connection type for most DSL/Cable modems and other networks.
- For cable modem users, please click menu "Network > MAC Clone". Click **Clone MAC Address** button and then click **Save**. Reboot the modem first and then the Router, try to access the Internet from your computer. If the problem persists, please go to the next step.

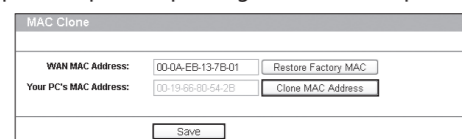

- Connect your computer directly to your modem and attempt to access the Internet. If you are still unable to access the Internet, please contact your internet provider for further assistance.

### 2. What can I do if I cannot open the web management window?

#### 1) For Windows 7/Vista

Go to 'Start > Settings > Control Panel'. Click 'View network status and tasks > View status > Properties' and double-click 'Internet Protocol Version 4 (TCP/IPv4)'. Select 'Obtain an IP address automatically', choose 'Obtain DNS server address automatically' and click 'OK'.

#### 2) For Windows XP/2000

Go to 'Start > Control Panel'. Click 'Network and Internet Connections > Network Connections'. Right-click 'Local Area Connection', select 'Properties' and then double-click 'Internet Protocol (TCP/IP)'. Select 'Obtain an IP address automatically', choose 'Obtain DNS server address automatically' and click 'OK'.

### 3. What can I do if I forget my password?

- For default wireless password: Please refer to the "Wireless Password/PIN" labeled on the bottom of the Router.
- For the web management page password: Reset the Router first and then use the default user name and password: admin, admin.

### 4. How do I restore my Router's configuration to its factory default settings?

If your router does not work properly, you can reset it and then configure it again. With the Router powered on, press and hold the **WPS/RESET** button on the rear panel for approximately 8 seconds before releasing it.

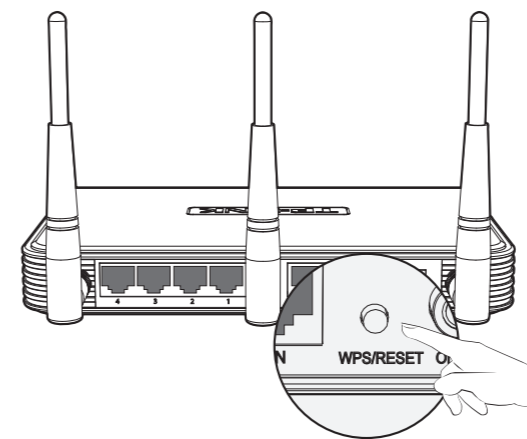

## Technical Support

- For more troubleshooting help, go to <http://www.tp-link.com/en/support/faq>
- To download the latest Firmware, Driver, Utility and User Guide, go to <http://www.tp-link.com/en/support/download>
- For all other technical support, please contact us by using the following details:

#### Global

Tel: +86 755 2650 4400  
E-mail: support@tp-link.com  
Service time: 24hrs, 7days a week

#### Singapore

Tel: +65 6284 0493  
E-mail: support.sg@tp-link.com  
Service time: 24hrs, 7days a week

#### France

Tel: +33 (0) 820 800 860 (French service)  
Email: support.fr@tp-link.com  
Fee: 0.118 EUR/min from France  
Service time: Monday to Friday 09:00 to 18:00 \*Except French Bank holidays

#### USA/Canada

Toll Free: +1 866 225 8139  
E-mail: support.usa@tp-link.com  
Service time: 24hrs, 7days a week

#### Malaysia

Tel: 1300 88 875 465 (1300 88TP-LINK)  
E-mail: support.my@tp-link.com  
Service time: 24 hrs a day, 7days a week

#### Turkey

Tel: 444 1925 (Turkish Service)  
E-mail: support.tr@tp-link.com  
Service time: 09:00 to 21:00, 7days a week

#### Poland

Tel: +48 (0) 801 080 618/+48 227 217 563 (if calls from mobile phone)  
E-mail: support.pl@tp-link.com  
Service time: Monday to Friday 09:00 to 17:00, GMT+1 or GMT+2 (Daylight Saving Time)

#### Germany/Austria

Tel: +49 1805 875 465 (German Service) +49 1805 TPLINK +43 820 820 360  
E-mail: support.de@tp-link.com  
Fee: 0.14 EUR/min from the German fixed phone network and up to 0.42 EUR/min from mobile phone  
Service Time: Monday to Friday, 09:00 to 12:30 and 13:30 to 17:30, GMT+1 or GMT+2 (Daylight Saving Time in Germany) \* Except bank holidays in Hesse

#### Australia & New Zealand

Tel: AU 1300 87 5465  
NZ 0800 87 5465  
E-mail: support.au@tp-link.com (Australia)  
E-mail: support.nz@tp-link.com (New Zealand)  
Service time: 24hrs, 7 days a week

#### UK

Tel: +44 (0) 845 147 0017  
E-mail: support.uk@tp-link.com  
Service time: 24hrs, 7 days a week

#### Italy

Tel: +39 023 051 9020  
E-mail: support.it@tp-link.com  
Service time: Monday to Friday 09:00 to 13:00; 14:00 to 18:00

#### Ukraine

Tel: 0800 505 508  
E-mail: support.ua@tp-link.com  
Service time: Monday to Friday 10:00 to 22:00

#### Brazil

Toll Free: 0800 608 9799 (Portuguese Service)  
E-mail: suporte.br@tp-link.com  
Service time: Monday to Friday, 09:00 to 20:00; Saturday, 09:00 to 15:00

#### Indonesia

Tel: +62 021 6386 1936  
E-mail: support.id@tp-link.com  
Service time: Monday to Friday 09:00 to 18:00

#### Switzerland

Tel: +41 (0) 848 800 998 (German Service)  
E-mail: support.ch@tp-link.com  
Fee: 4-8 Rp/min, depending on rate of different time  
Service time: Monday to Friday, 09:00 to 12:30 and 13:30 to 17:30, GMT+1 or GMT+2 (Daylight Saving Time)

#### Russian Federation

Tel: 8 (499) 754 5560  
8 (800) 250 5560 (toll-free call from any RF region)  
E-mail: support.ru@tp-link.com  
Service time: From 10:00 to 18:00 (Moscow time) \*Except weekends and holidays in Russian Federation