

# TP-LINK®

## User Guide

**TL-PA511**

**AV500 Mini Powerline Adapter**



Rev: 1.0.0

1910010503

## **COPYRIGHT & TRADEMARKS**

Specifications are subject to change without notice. **TP-LINK®** is a registered trademark of TP-LINK TECHNOLOGIES CO., LTD. Other brands and product names are trademarks or registered trademarks of their respective holders.

No part of the specifications may be reproduced in any form or by any means or used to make any derivative such as translation, transformation, or adaptation without permission from TP-LINK TECHNOLOGIES CO., LTD. Copyright © 2011 TP-LINK TECHNOLOGIES CO., LTD. All rights reserved.

<http://www.tp-link.com>

## FCC STATEMENT



This equipment has been tested and found to comply with the limits for a Class B digital device, pursuant to part 15 of the FCC Rules. These limits are designed to provide reasonable protection against harmful interference in a residential installation. This equipment generates, uses and can radiate radio frequency energy and, if not installed and used in accordance with the instructions, may cause harmful interference to radio communications. However, there is no guarantee that interference will not occur in a particular installation. If this equipment does cause harmful interference to radio or television reception, which can be determined by turning the equipment off and on, the user is encouraged to try to correct the interference by one or more of the following measures:

- Reorient or relocate the receiving antenna.
- Increase the separation between the equipment and receiver.
- Connect the equipment into an outlet on a circuit different from that to which the receiver is connected.
- Consult the dealer or an experienced radio/ TV technician for help.

This device complies with part 15 of the FCC Rules. Operation is subject to the following two conditions:

- 1) This device may not cause harmful interference.
- 2) This device must accept any interference received, including interference that may cause undesired operation.

Any changes or modifications not expressly approved by the party responsible for compliance could void the user's authority to operate the equipment.

## CE Mark Warning



This is a class B product. In a domestic environment, this product may cause radio interference, in which case the user may be required to take adequate measures.

## Important Safety Instructions

1. Do not open this product or attempt to service it; it may expose you to dangerous high voltage or other risks.
2. Do not operate this product near water.
3. Do not place or operate this product near a radiator or a heat register.
4. Do not expose this product to dampness, dust or corrosive liquids.
5. Do not connect this product or disconnect it from a wall socket during a lightning or a thunderstorm
6. Do not block the ventilation slots of this product, for insufficient airflow may harm it.
7. Do not put anything on this product.
8. Plug this product directly into a wall socket (100V~240V, 50~60Hz). Do not use an extension cord between this product and the AC power source.
9. When plugging this product into a wall socket, make sure that the electrical socket is not damaged, and that there is no gas leakage.
10. Place the connecting cables properly so that people won't stumble or walk on it.
11. This product should be operated from the type of power indicated on the marking label. If you are not sure of the type of power available, consult the qualified technician.
12. Unplug this product from the mains and refer the product to qualified service personnel for the following conditions:
  - If liquid has been spilled on the product
  - If the product has been exposed to rain or water
13. Unplug this product from the wall socket before cleaning. Use a damp cloth for cleaning. Do not use liquid cleaners or aerosol cleaners.
14. The specification of the fuse is **T2.5AL250V**. To avoid damage, please do not change the fuse.
15. The Operating temperature is 0°C~40°C (32°F~104°F).
16. The Storage temperature is -40°C~70°C (-40°F~158°F).

# CONTENTS

<b>Chapter 1 Introduction</b> .....	<b>1</b>
1.1 LED Indicator.....	2
1.2 Physical Interface.....	3
<b>Chapter 2 Connecting Mechanism</b> .....	<b>4</b>
2.1 Introduction.....	4
2.2 Connection Instruction.....	4
2.3 Hardware Connection – Computer.....	4
2.4 Hardware Connection – Internet.....	5
<b>Chapter 3 Installing Management Utility</b> .....	<b>7</b>
<b>Chapter 4 Using the Management Utility</b> .....	<b>11</b>
4.1 Main.....	11
4.1.1 Rename.....	13
4.1.2 Enter Password.....	14
4.1.3 Add Device.....	15
4.1.4 Reset.....	16
4.2 Privacy.....	16
4.3 QoS.....	18
4.4 Diagnostics.....	18
4.5 About.....	20
<b>Chapter 5 Advanced Feature: How to Use the Pair Buttons</b> .....	<b>21</b>
5.1 Pair (Secure with 128 bits-AES).....	21
5.2 Set Up a Secured Powerline AV Network with the Pair Button.....	21
<b>Appendix A: Troubleshooting Guide</b> .....	<b>23</b>
<b>Appendix B: Specifications</b> .....	<b>24</b>

## Chapter 1 Introduction

This device is an AV500 Mini Powerline Adapter which transforms your house's existing electrical wiring into a ubiquitous networking infrastructure. Simply plug this AV500 Mini Powerline Adapter into an ordinary AC power outlet which will easily extend your Cable/xDSL broadband connection or existing Ethernet (LAN) network to any other electrical outlet in any room of a house without the need of any new cabling.

This Mini Powerline Adapter supports up to 500Mbps data rate over the existing household power circuit. With data rates of 500Mbps, full multimedia application can easily be supported throughout the whole house in addition to Internet access. This Mini Powerline Adapter uses the existing power lines installed in a home as a path to transmit digital data, voice, audio and video between devices.

To ensure data communication's security and multimedia applications, this Mini Powerline Adapter support built-in 128-bit AES encryption. With minimum setup, you can install and use this Mini Powerline Adapter within minutes. The adapter adds two useful functions.

1. Existing connection with a new unassociated device added via the **Pair Button**.
2. Reset to default setting via the **Management Utility**.

### A. System Requirement

- a) At least two AC 100V ~ 240V (50~60Hz) power outlets with standard home power wiring
- b) A computer with the following:
  - Operating System with TCP/IP installed
  - Pentium III compatible processor and above
  - Ethernet LAN card installed with TCP/IP protocol
  - 64 MB RAM or more
  - 50 MB of free disk space (Minimum)
  - CD-ROM Drive

### B. Package Contents

The AV500 Mini Powerline Adapter package contains the following items:



- One AV500 Mini Powerline Adapter (There are two AV500 Mini Powerline Adapters in Starter Kit)
- One CAT-5 Ethernet Cable (There are two CAT-5 Ethernet Cables in Starter Kit)
- One Quick Installation Guide
- One Resource CD (Management Utility and User Guide)

If any of the above items is damaged or missing, please contact your dealer immediately.

### 1.1 LED Indicator

The LED indicator displays information about the device's status.



Item	Status	Indication
 Power LED	On	The adapter is on.
	Blinking	The adapter is in power-saving mode.
	Off	The adapter is off.
 Powerline LED	Green	Data rate is more than or equal to 80Mbps.
	Orange	Data rate is between 48Mbps and 80Mbps.
	Red	Data rate is less than or equal to 48Mbps.
	Off	The adapter isn't connected to any powerline network or is in power-saving mode.
 Ethernet LED	On	The Ethernet port is connected, but there is no data being transferred.
	Blinking	The Ethernet port is transferring data.
	Off	The Ethernet port isn't connected.

 **Note:**

5 minutes after the device connected to the adapter is turned off, the adapter will automatically switch to the power-saving Mode.

## 1.2 Physical Interface

There are four physical interfaces on this Mini Powerline Adapter.



Interface	Description
Ethernet Port	A 10/100Mbps Ethernet port for connecting the adapter to the PC or the broadband device with a network cable.
Power Plug*	A Power Plug for connecting the adapter to a 100V ~ 240V (50~60Hz) AC power socket.
Pair Button	Pair buttons are used to secure a powerline network. To secure your network, please follow the steps below. Firstly, plug in a new adapter, and press its pair button for one second; then plug in another adapter and press its pair button for one second as well. The two buttons should be pressed within 2 minutes of each other. After that, wait about 60 seconds so that the two adapters can finish connecting.

\* The provided power plug may differ from the picture due to different regional power specifications. Here we take the EU version as an example.

**Note:**

1. If you press the pair button for more than 10 seconds, the powerline adapter will leave the network which it has joined and its new network name assumes a random value. The Power LED turns off when it disconnects from the powerline network.
2. For detailed information about the pair button, please refer to [Chapter 5 Advanced Feature: How to Use the Pair buttons](#).



## Chapter 2 Connecting Mechanism

### 2.1 Introduction

The Powerline Adapter supports up to 500Mbps data rate. With this high speed connection rate, this Powerline Adapter allows you to set up a high speed home network by using your home existing electrical wiring. Simply plug this Powerline Adapter into an ordinary power outlet to extend your Cable/xDSL broadband connection or existing LAN network to any other electrical outlet in any room of your house.

Note that this Powerline Adapter works in pairs. You need to plug one Powerline Adapter into a power outlet for each computer and connect the Powerline Adapter to the computer's LAN card with an Ethernet cable; you will also need another Powerline Adapter connected to your Cable/xDSL broadband so as to extend your broadband connection or Internet surfing. With clean power line, the distance between two Powerline Adapters can reach 300 meters at lease, but the actual distance may vary due to the environment.

Section below describes the connection instructions and hardware connection mechanism.

### 2.2 Connection Instruction

To ensure the optimum performance of the Powerline Adapter and significantly improve the transmission capacity of the network, we recommend that you comply with the following connection rule:

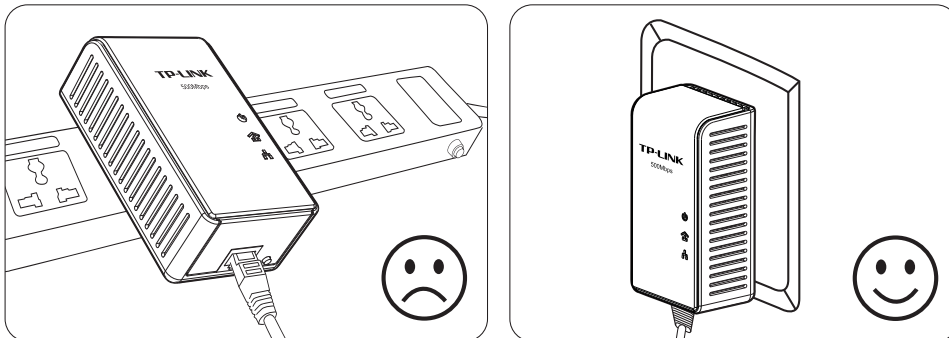

- Plug the Powerline Adapter directly into a wall socket but not the multiple sockets.



### 2.3 Hardware Connection – Computer

For those computers you wish to be networked by Powerline Adapter, each of the computers must be properly connected with a Powerline Adapter through an Ethernet (RJ-45) cable.

Following are the steps to properly connect the Powerline Adapter to your computer:

1. Connect one end of the provided Ethernet (RJ-45) cable to the Powerline Adapter's Ethernet port.
2. Connect the other end of the Ethernet (RJ-45) cable to you computer's LAN port.
3. Plug the Powerline Adapter into a wall socket next to the computer.
4. Turn on your computer.
5. Check and confirm that the Power LED  and Ethernet LED  on the Powerline Adapter are ON.

The hardware connection mechanism is shown below:

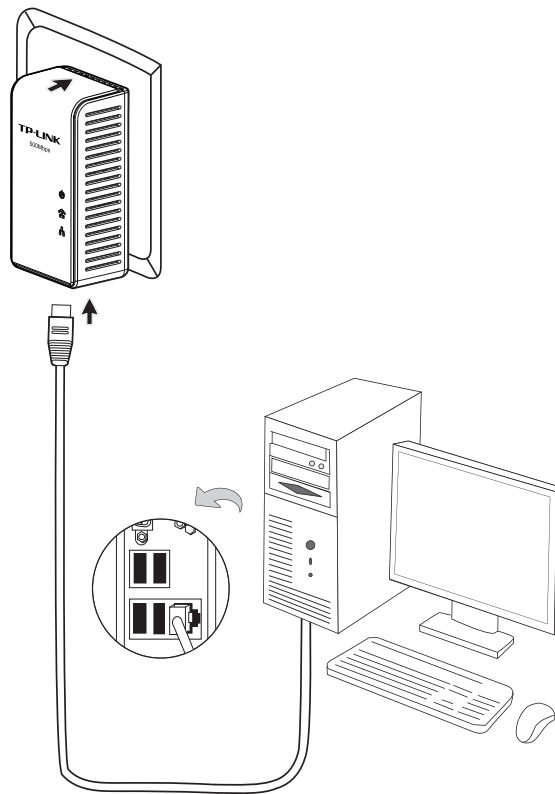



**Note:**

Do not connect the Powerline adapter to any extension lead, power strip, extension cord or surge protector, as this may degrade the network performance.

## 2.4 Hardware Connection – Internet

This section describes how to connect the Powerline Adapter into your existing ADSL broadband connection via ADSL Ethernet port. Follow the procedures described below to connect the Powerline Adapter to your ADSL broadband connection:

1. Connect one end of the provided Ethernet (RJ-45) cable to the Powerline Adapter's Ethernet port.
2. Connect the other end of the Ethernet (RJ-45) cable to an available Ethernet port of your ADSL broadband Router.
3. Plug the Powerline Adapter into a wall socket next to the computer.
4. Turn on your computer.
5. Check and confirm that the Power LED , Ethernet LED , and Powerline LED  on the Powerline Adapter are **ON**.

The hardware connection mechanism is shown below:

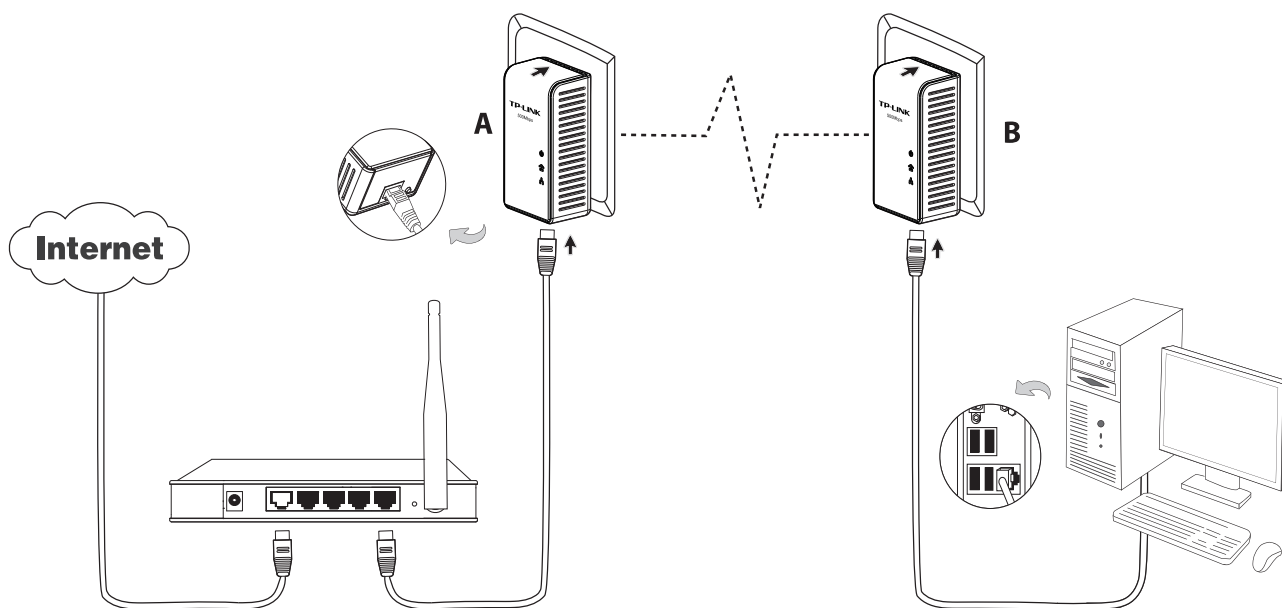

## Chapter 3 Installing Management Utility

Please verify that no other Powerline Adapter or any Encryption Management Utilities are installed before installing the provided software. If other Powerline Utilities are installed, uninstall them and restart your personal computer before installing this provided software.

 **Note:**

Please make sure that you have installed the **WinPcap** (the version of which should be beyond 4.1.1 inclusive) on your computer before installing the Management Utility. The **WinPcap** can be found on the provided Resource CD.

Take the following steps to properly install the provided Management Utility:

Step 1: Insert the Resource CD into your CD-ROM drive, and then the following Setup Wizard will automatically pop up on your computer's screen.



Step 2: Click **Management Utility** and the program installation process will carry out and copy all the necessary files to your system. Follow the instruction step by step to finish the installation.

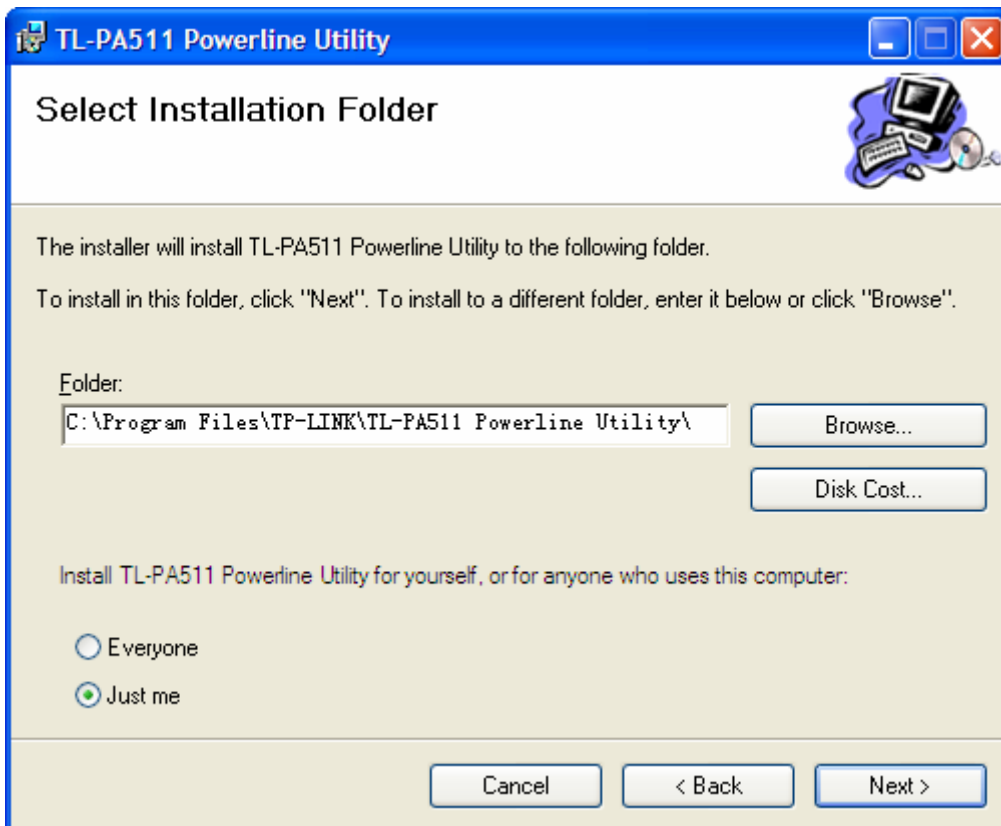
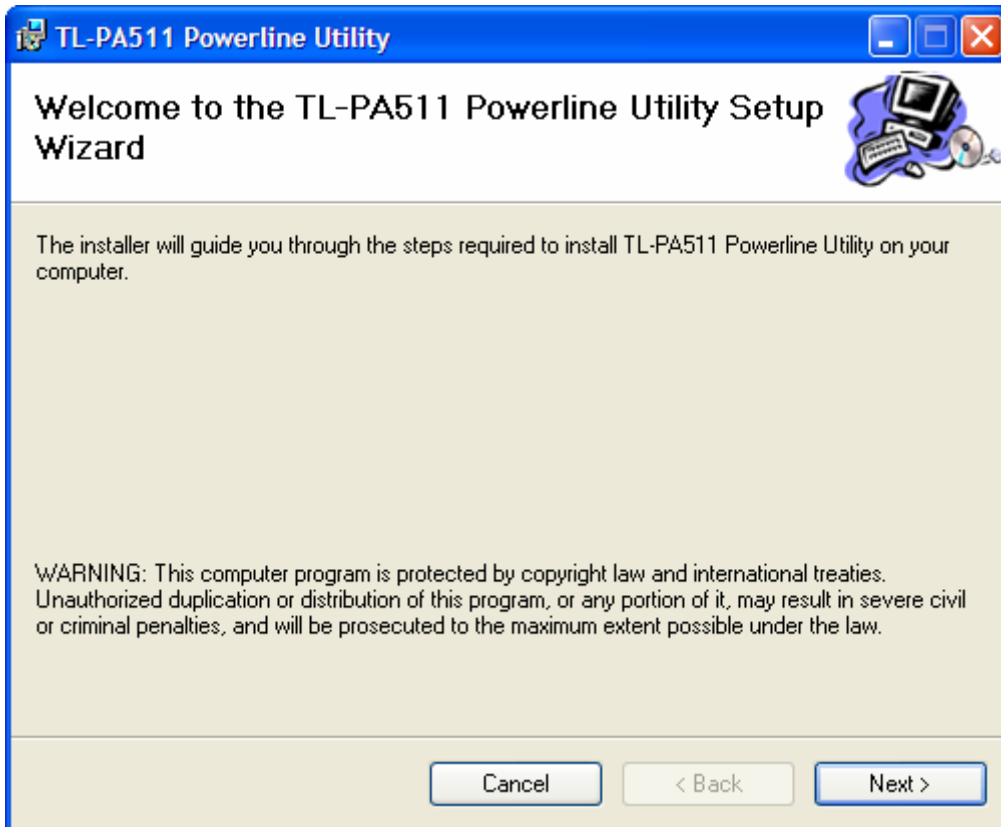

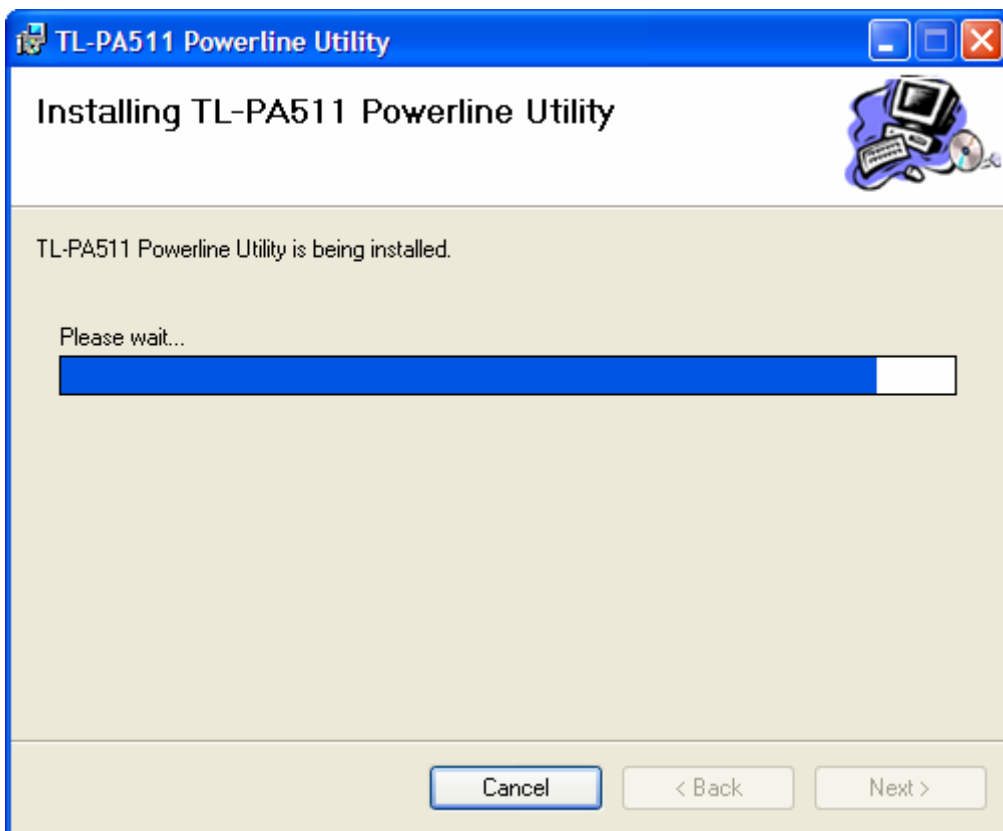
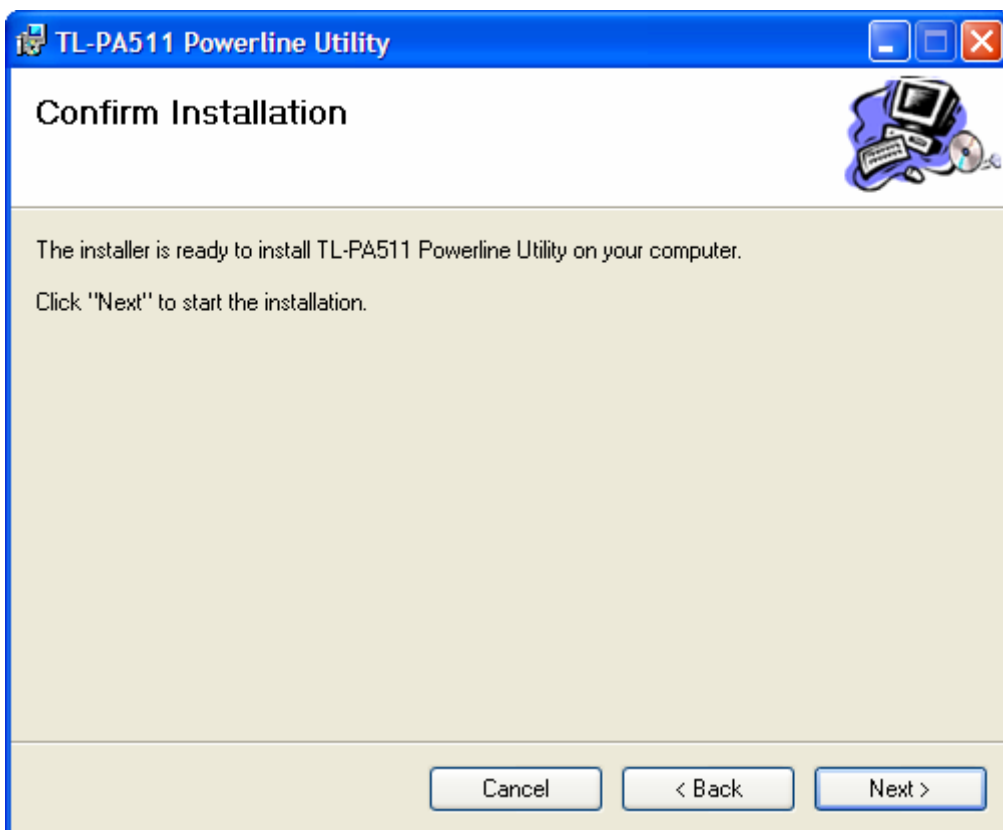

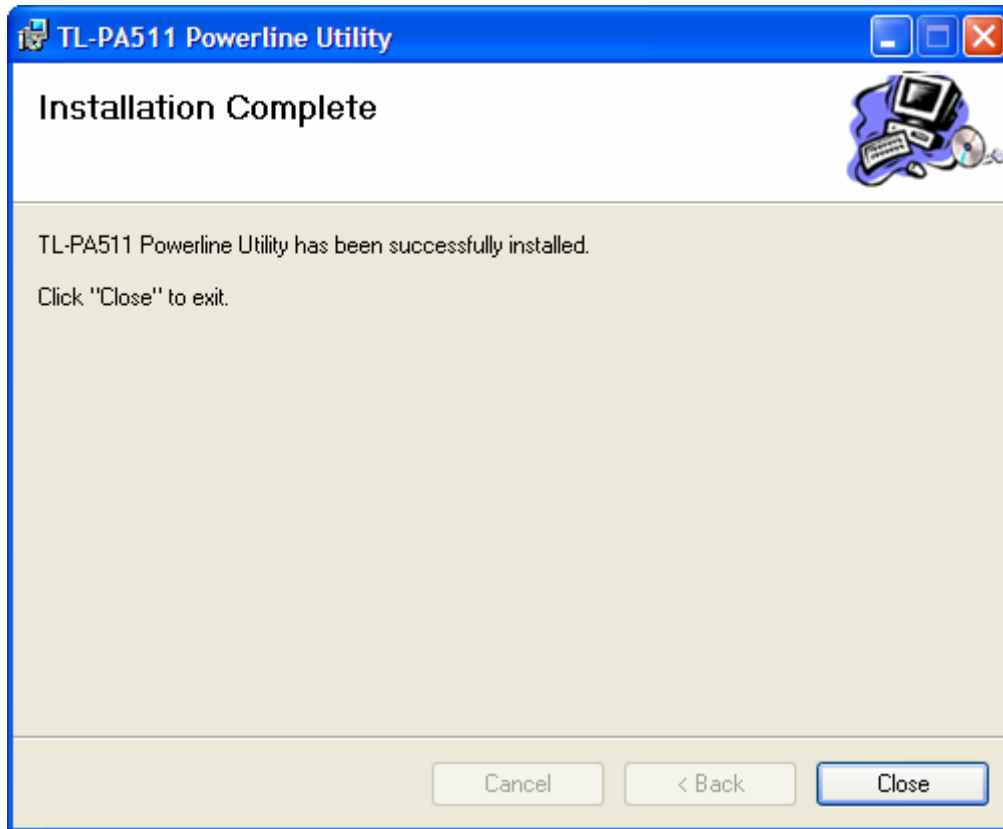

Step 3: After the installation, a shortcut to the “**TL-PA511 Powerline Utility**” application icon is provided on the windows desktop.

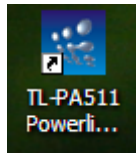

## Chapter 4 Using the Management Utility

After you'd successfully installed the Powerline Adapter hardware and Management Utility software, you can set up or configure the devices according to your need.

This Powerline Adapter Configuration Utility enables the users to identify powerline devices on the powerline network, measure data rate performance, ensure privacy and perform diagnostics by setting user-defined secure powerline networks.

Double click on the “**TL-PA511 Powerline Utility**” from your windows desktop, and the following screen will display. This Management Utility consists of five property sheets, i.e., “**Main**”, “**Privacy**”, “**QoS**”, “**Diagnostics**” and “**About**”.

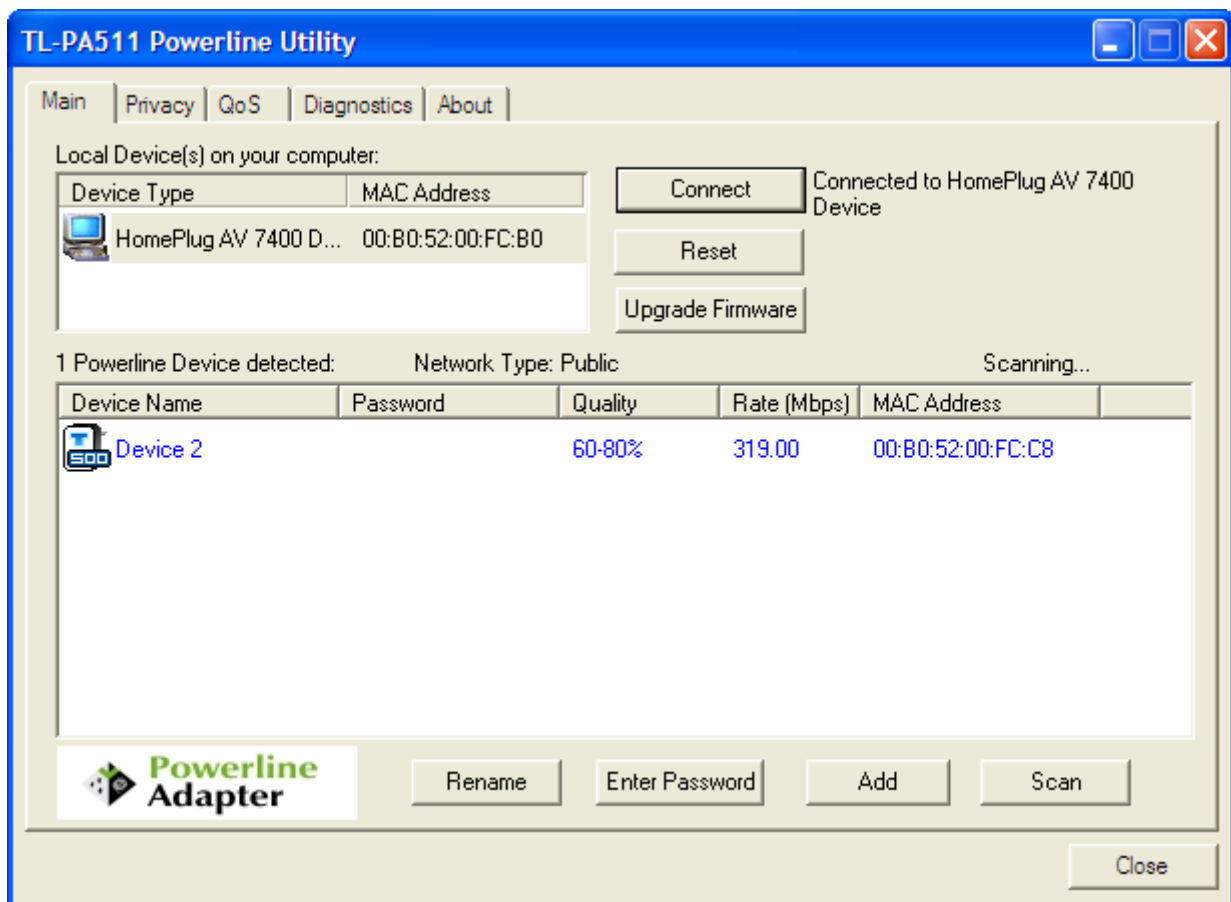

### 4.1 Main

The **Main** tab shows all the Powerline Adapters that are logically connected to the current computer where the Management Utility is running.



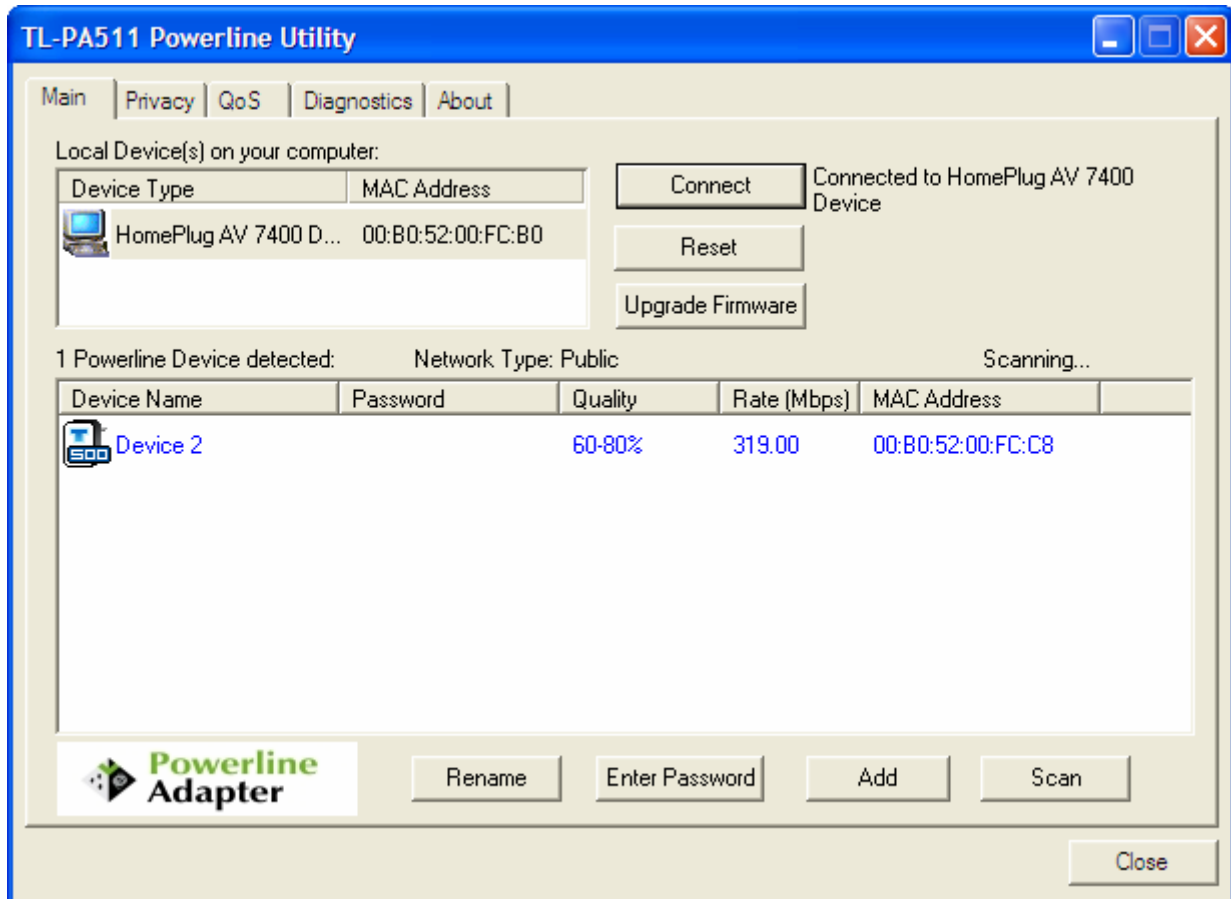

- **Local Device(s) on your computer:** This shows all local Powerline Ethernet Adapter found connected to the computer's LAN card. In most cases, only one device will display in this panel. Click and select the local device shown on the screen then click "**Connect**" tab to manage the Powerline Ethernet Adapter. The status message shown above the "**Connect**" button indicates that your PC is connected to the same device. Once the chosen Powerline Ethernet Adapter is properly connected, this Management Utility will automatically scan the power line periodically for any other existing powerline devices. You can upgrade the version of firmware for the device by clicking the **Upgrade Firmware** button which is shown as below.

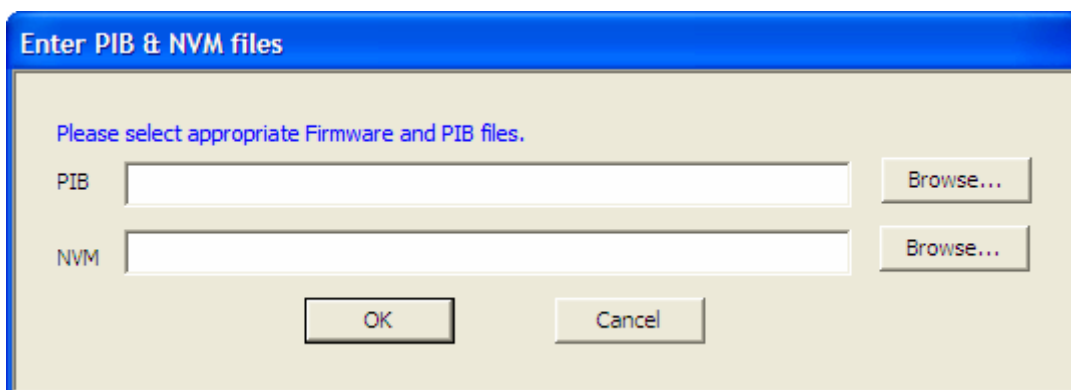

- **PIB:** Parameter Information Block. It contains configuration values that establish device network identity, general capabilities and operational modes.
- **NVM:** None-volatile memory. It is used for upgrading the firmware.

If you want to upgrade the version of firmware for the device, please select appropriate Firmware and PIB files together. New firmware versions and PIB files are posted at <http://www.tp-link.com> and can be downloaded for free.

 **Note:**

The parameter information of PIB will restore to the factory defaults after resetting the Powerline Adapter.

**To upgrade the device's firmware, follow these instructions:**

1. Download PIB file and firmware upgrade file from TP-LINK website (<http://www.tp-link.com>).
2. Enter the path name or click **Browse...** to select the downloaded files on the computer into the corresponding blanks.
3. Click the **OK** button.

 **Note:**

Do not turn off the device while the firmware is being upgraded. The device will reboot after the upgrading has been finished.

- **“x” Powerline Devices detected:** This display all the Powerline Adapter found on the current logical network. “x” shows the number of remote Powerline Adapter discovered by this Management Utility.
- **Network Type:** Displayed the type of logical network: **“Public”** or **“Private”**.
- **Autoscan:** Shows the scanning status (Default is **“ON”**).
  - **Device Name:** Shows the default device name. You can redefine or change the name by clicking on the name and editing in place or by clicking the **“Rename”** button.
  - **Password:** Shows the current password of the Powerline Adapter.
  - **Quality:** Shows the quality of the Powerline Adapter connection.
  - **Rate (Mbps):** Shows the current transmission rate of the selected Powerline Adapter.
  - **MAC Address:** Shows the Powerline Adapter’s MAC address.
- **Rename:** Click to change the name of the selected Powerline Adapter.
- **Enter Password:** Shows the supplied Powerline Adapter’s password (Initially left blank). To set the Powerline Adapter password (Which is required when creating a private network), click and select the device shown in the lower panel and click on the **“Enter Password”** button. Follow the pop-up dialog box to complete your password setting.
- **Add:** Click this button to add a remote Powerline Adapter to your network that is not on the lower panel displayed list. You will advice to locate the passwords for all Powerline Adapter you wish to manage and add them to the local logical network by clicking the **“Add”** button. Follow the pop-up dialog box to complete your setting.
- **Scan:** Click the **“Scan”** button to perform an immediate search of the Powerline Adapter connected to the computer. The Management Utility will automatically perform the scanning process and update the display every few seconds by default.

**4.1.1 Rename**

This Management Utility allows you to change the name of the listed Powerline Adapter. Click and select the Powerline Adapter you wish to change from the list, then click on the **“Rename”** tab and edit in-place to change the name.

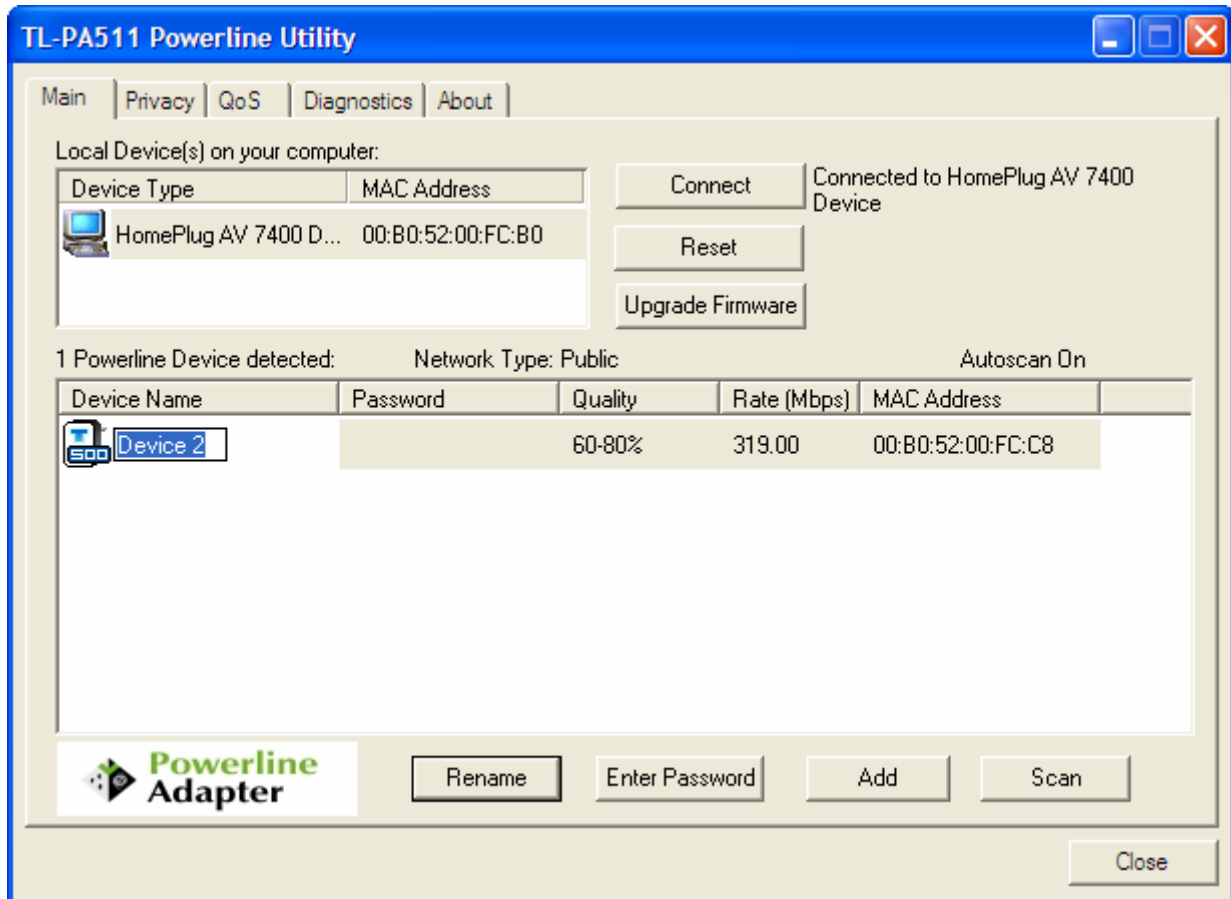

#### 4.1.2 Enter Password

To set or change your Powerline Adapter’s password, click and select the Powerline Adapter you wish to change from the list, then click on the “**Enter Password**” tab, and the following screen will display.

Enter your **Password** (Take note of the password format) and click “**OK**” after setup.



 **Note:**

The Powerline Adapter device must be present on the power line (plugged in) in order for the password to be confirmed and added to the network. If the Powerline Adapter device could not be located, a warning message will be shown.

### 4.1.3 Add Device

The following dialog box will pop up when clicking the “Add” button under the **Main** configuration homepage. The dialog box allows you to enter both the selected device’s name and password. Note that the Powerline Adapter must be present on the power grid in order to activate the set password and added to the local network.

Enter your **Device Name** and **Password** (Take note of the password format) and click “OK” after setup.



The following screen will display after the naming and password setting process, which is also the **Diagnostics** configuration homepage.

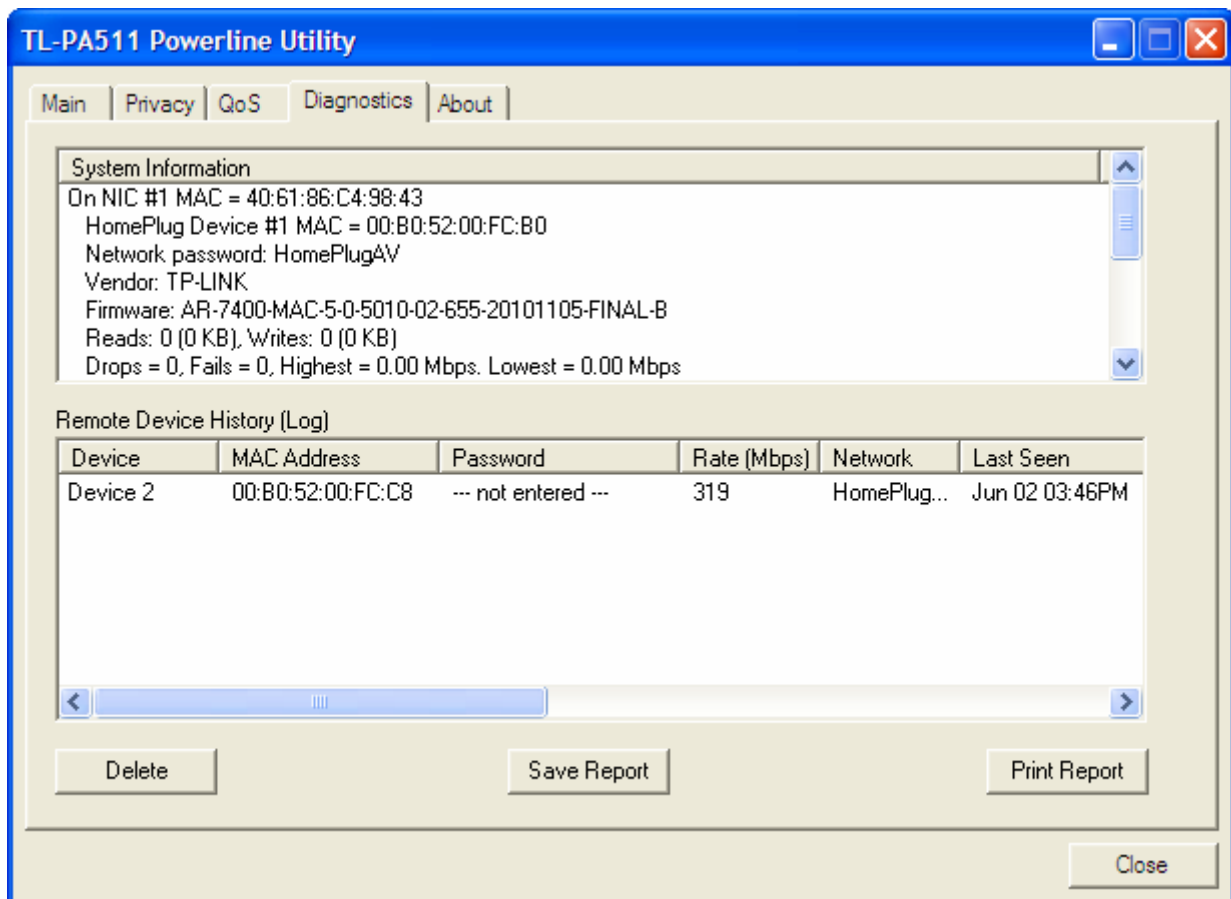

#### 4.1.4 Reset

This Management Utility allows you to reset the Powerline Adapter to its default settings by clicking the **Reset** button on the **Main** page.

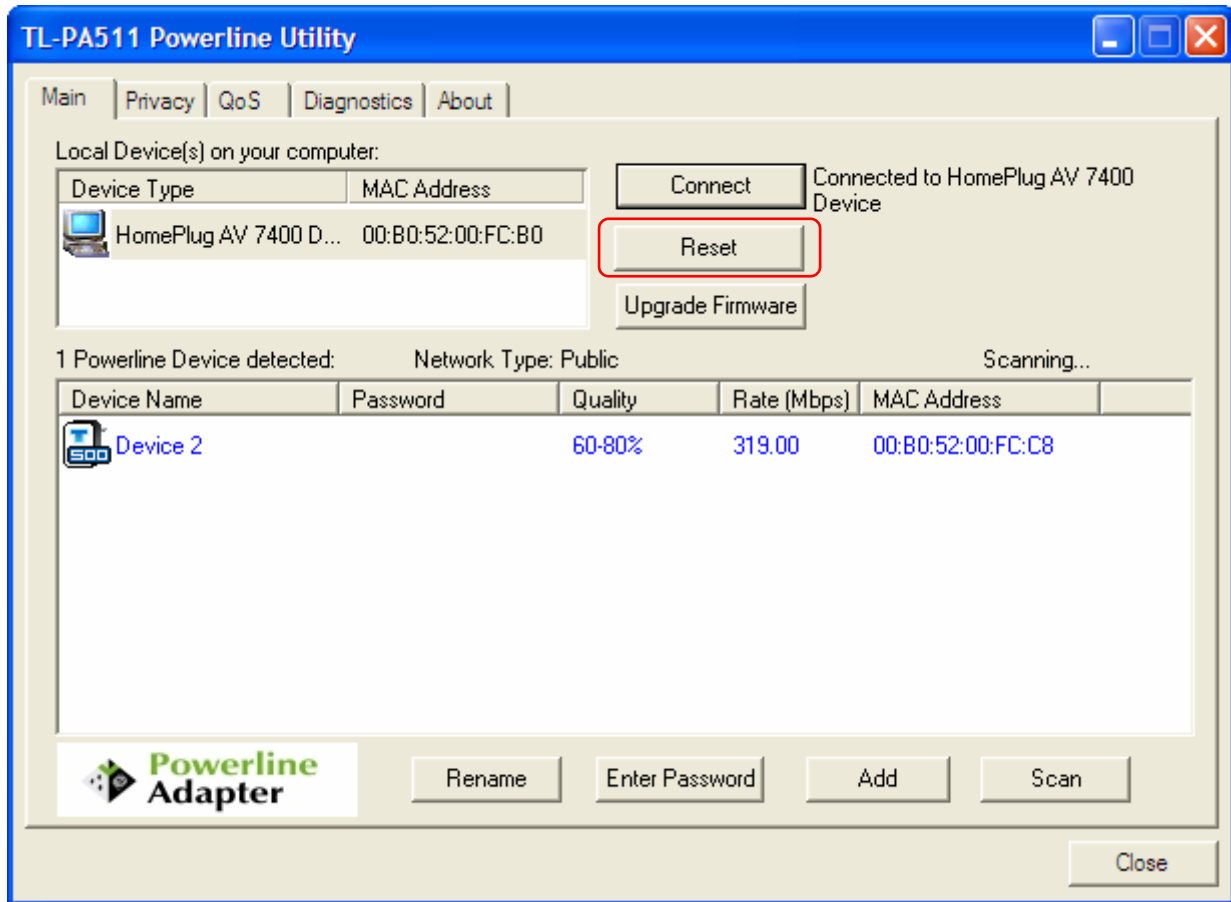

## 4.2 Privacy

The **Privacy** configuration page provides a means for managing the local network and providing additional security for the logical network and also to select the devices that has to be included in the network. All Powerline devices are shipped using a default logical network (network name), which is normally **“HomePlugAV”**.

The **Privacy** configuration homepage allows you to change the **Network Name** of the Powerline Adapter that is currently connected to this computer into a private network. Reset the private network to universal public network by clicking on the **“Use Default (Public Network)”** or entering/editing **“HomePlugAV”** under column of **“Private Network Name”** is always available.

Note that every Powerline Adapter on your home network **MUST** have the same **Network Password** for connectivity to be established throughout your home.

 **Note:**

Changing the network name to anything other than **“HomePlugAV”** will show the network type on the Main configuration screen as **“Private”**.

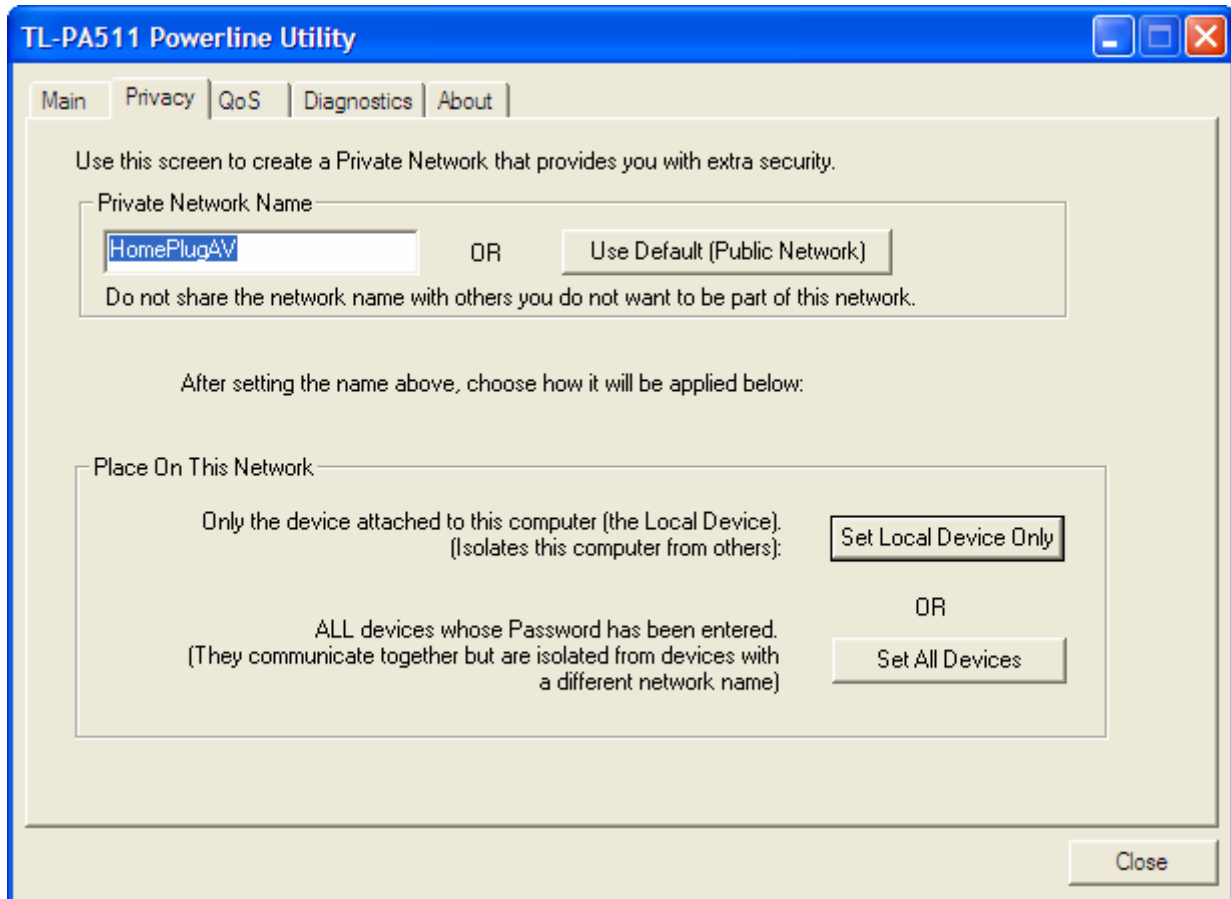

- **Set Local Device Only:** Click this tab to change the network name of the local Powerline Adapter device only. All Powerline Adapter devices seen on the **Main** configuration homepage prior to this will be no longer present in the new network, effectively making the local devices not to communicate to the devices which were in the old logical network. Devices previously set up with the same logical network (same network name) will appear in the device list after selecting this option.
- **Set All Devices:** The **Set All Devices** button is used to change the logical network of all devices that appear on the **Main** configuration homepage whose Device's Password had been entered for the same logical network. A dialog window will appear to report the success of this operation. For devices whose device passwords were not entered, this operation will fail and will report a failure message.

### 4.3 QoS

The third tabbed window, labeled “QoS” for Quality of Service, is shown in the following figure.

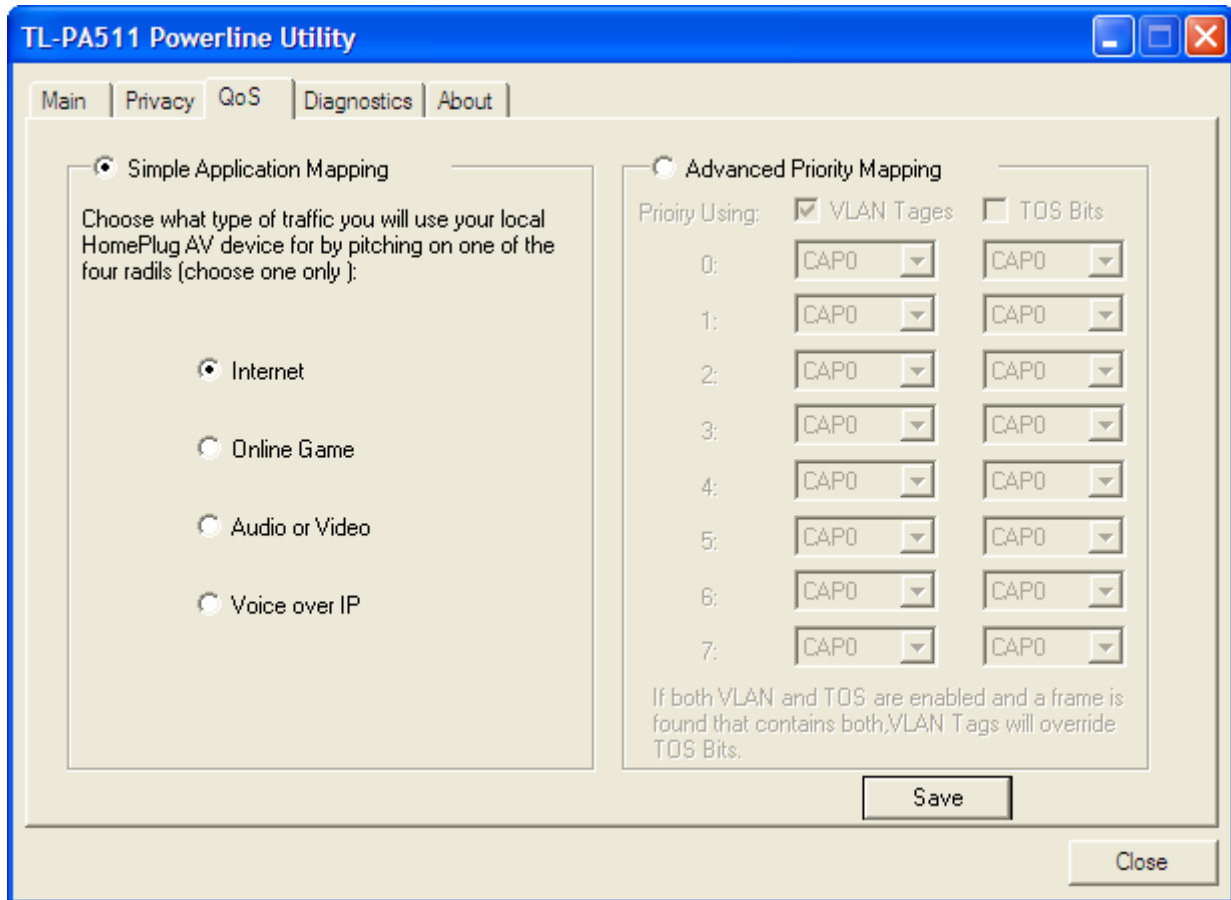

QoS requirements are different for various data types such as streaming video or music, voice and raw data. To provide higher QoS for streaming data, priority levels can be set using tags at the beginning of data frames. Virtual Local Area Network (Vlan) 802.1p priority tags on Ethernet frames are used to specify 8 (0~7) levels of “user priority”. Homeplug AV powerline allows for 4 levels of Channel Access Priority CAP (0-3)). Therefore, the 8 levels of VLAN Ethernet tags must be mapped to the 4 levels of CAP priority, where CAP 3 is the highest priority and CAP 0 is the lowest. CAP 3 priority might be used for voice and network management frames, CAP 2 is used for streaming video, while CAP 1 and CAP 0 are used for data. Mapping VLAN tags to CAP levels is easily done using the VLAN Priority Mapping function on the QoS tab window.

**Simple Application Mapping:** The group allows you to choose what type of traffic with the highest user priority you will use your local HomePlug device for by pitching on one of the following three radios. Please select the radio type according to your demand.

**Advanced VLAN Priority Mapping:** The group sets VLAN priority to CAP mapping and default priority. Note that in HomePlug, CAP 3 is the highest priority while CAP 0 is the lowest priority. The values shown in VLAN Tags Priority are the default settings for the first running.

### 4.4 Diagnostics

The **Diagnostics** homepage shows the **System Information** and **Remote Device History** of all remote devices seen over a period of time which are only readable. Click on the “**Diagnostics**” tab and the following screen will display.

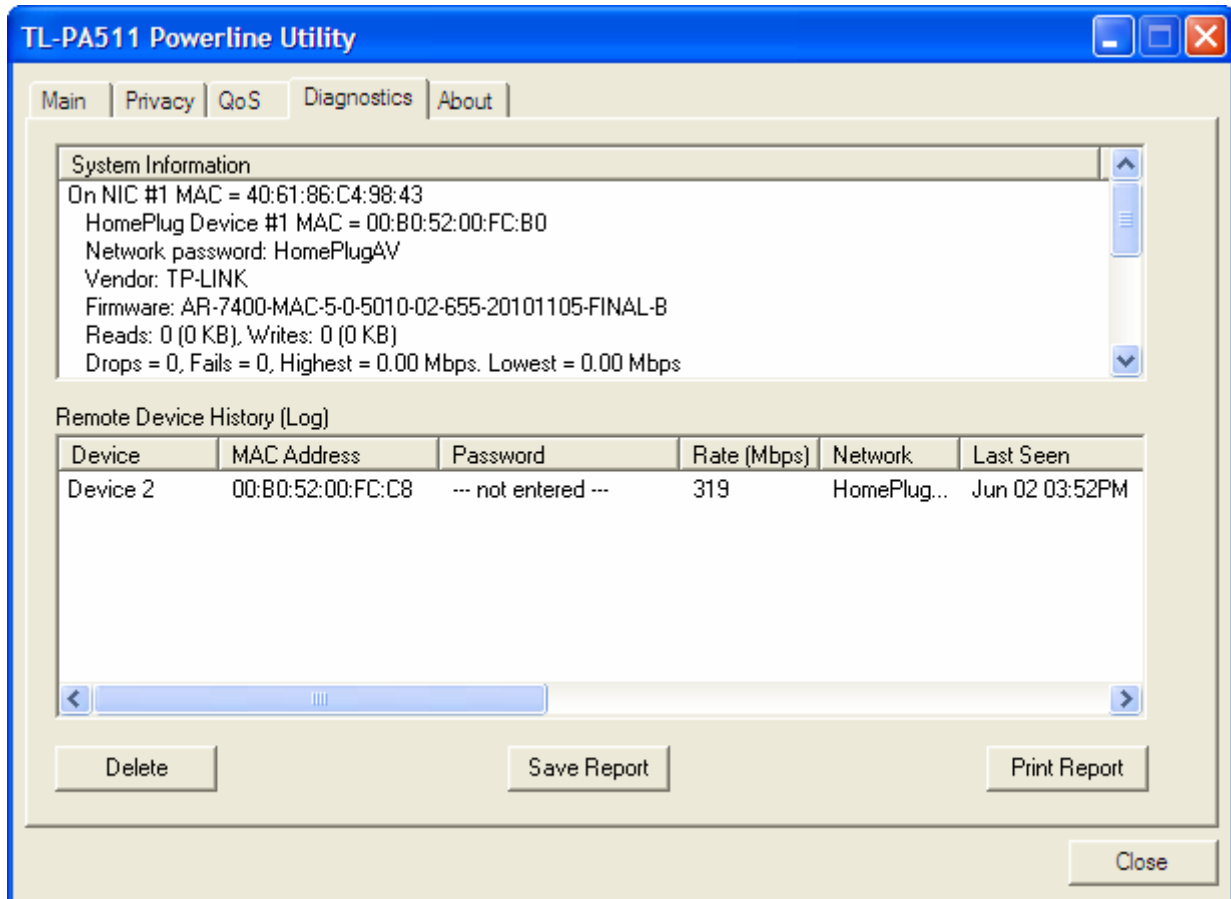

The **Diagnostics** information displayed can be saved to a text file. One can email the saved text file to the local supplier when there's technical support required or print the saved text file as reference during a technical support conference.

The **Upper Panel** shows the technical data concerning software and hardware present on the host computer which were used to communicate over Powerline Adapter on the Powerline network. It may include the following:

- Operating System Platform/Version
- Host Network Name
- User Name
- MAC Address of all NICs (Network interface card) connected to the host
- Identify versions of all Driver DLLs and Libraries used (NDIS) and optionally
- MAC addresses of all devices connected locally to the host

Click the **“Delete”** tab to delete the Powerline Adapter device which is no longer part of the network.

The **Lower Panel** contains a history of all remote Powerline Adapter devices seen on the computer over a certain period of time. All devices that were on the powerline network are listed here along with a few other parameters. Powerline Adapter devices that are active on the current logical network will show a transfer rate in the Rate column; devices on other networks, or devices that may no longer exist are shown with a “?” in the Rate column. The following remote Powerline Adapter devices information is available from the diagnostics screen:

- Device Name
- Device MAC Address
- Device Password



- Device Last known rate
- Device Last Known Network name
- Device last seen date on the network

The diagnostics information displayed can be saved to a text file for later use, or can be printed as a reference for a technical support call. Powerline Adapter devices, which are not part of the network anymore, can be deleted using the delete button. A confirmation dialog window will pop up if we try to delete a device whose password has been entered.

## 4.5 About

The **About** homepage shows the Management Utility software version.

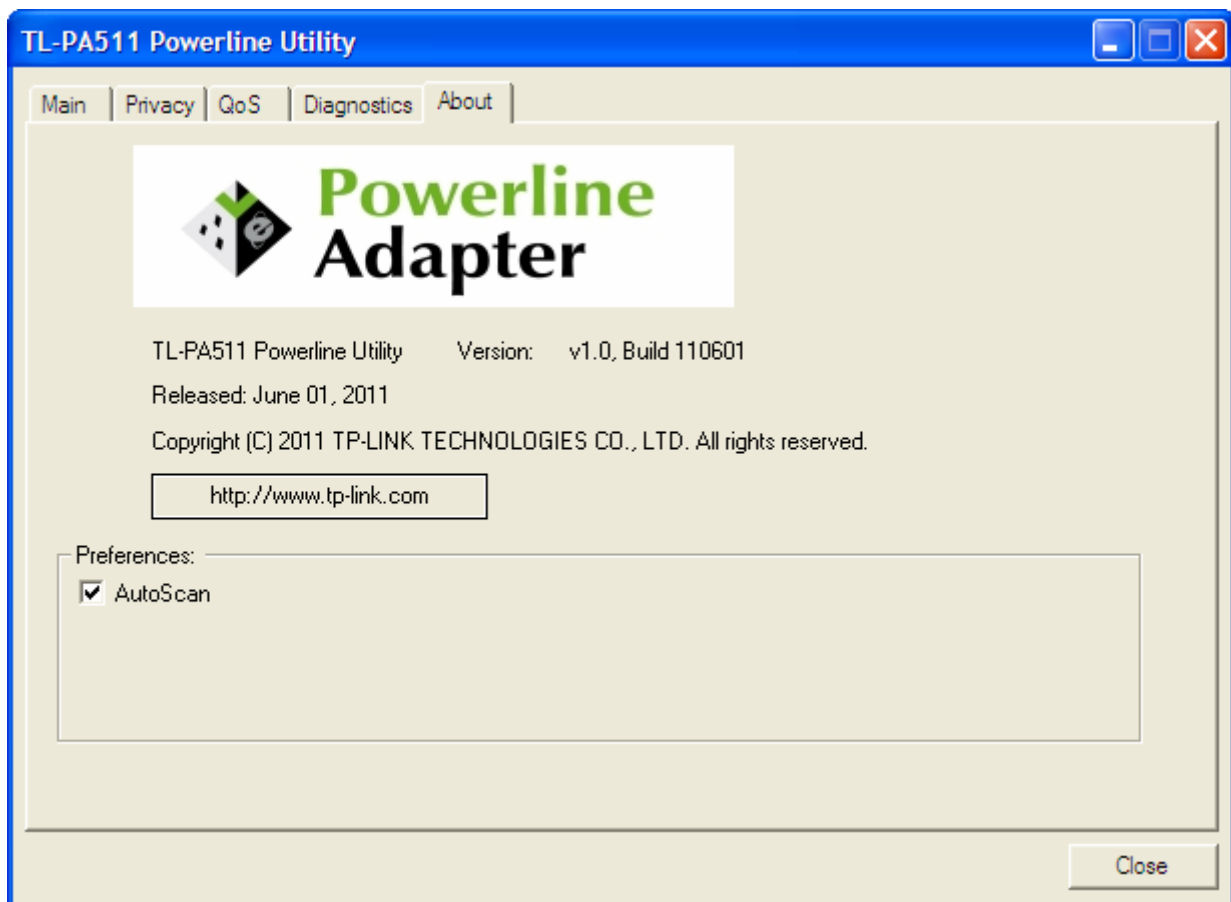

- **AutoScan:** When it is enabled (Place a check), the Management Utility will automatically scan for Powerline Adapter devices on the local network every few seconds and updated the scanning information on the **Main** configuration homepage.

## Chapter 5 Advanced Feature: How to Use the Pair Buttons

### 5.1 Pair (Secure with 128 bits-AES)

The Homeplug AV standard uses 128-bit AES (Advanced Encryption Standard) to safely transmit data between powerline adapters. For the powerline adapters to communicate with each other they all need to use the same Network Membership Key (NMK). Otherwise, they cannot unscramble the encrypted data sent in the powerline network.

The **Pair** button allows you to set up a secure powerline connection with another HomePlug AV compliant powerline devices which also support the **Pair** feature.

### 5.2 Set Up a Secured Powerline AV Network with the Pair Button

You can connect a number of devices on a powerline network, but you can only use the Pair button on two devices at a time.

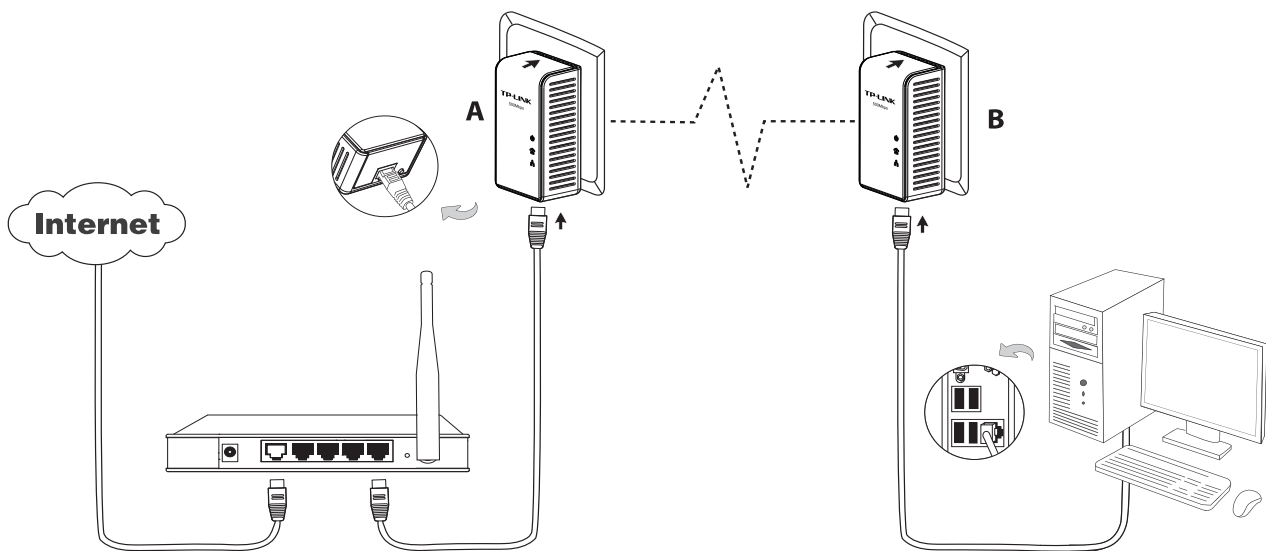

#### Create a secured Powerline network using the Pair button:

- Step 1.** Press the Pair button of Powerline adapter A for one second, the Power LED will start flashing.
- Step 2.** Press the Pair button of Powerline adapter B for one second, the Power LED will start flashing. (This must be done within 120 seconds after pressing the pair button of powerline adapter A.)
- Step 3.** Wait for about 60 seconds while your Powerline adapter A and B are connecting. The Power LED on both adapters will stop flashing and become solid light when the connection is made.

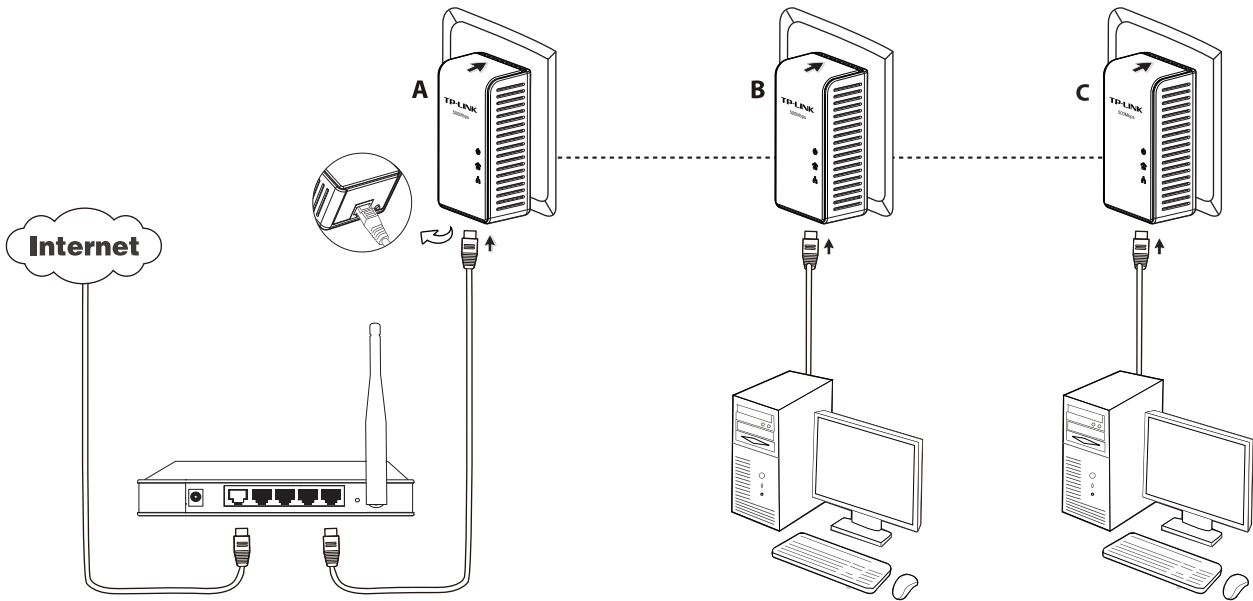

**Join an existing secured Powerline AV Network:**

Powerline adapter A and Powerline adapter B form a HomeplugAV Network, Powerline adapter C wants to join this network.

- Step 1.** Press and hold the Pair button on Powerline adapter C for one second.
- Step 2.** Press and hold the Pair button on Powerline adapter A/B for one second. (This step must be taken within 120 seconds after step 1 is finished.)
- Step 3.** Wait for about 60 seconds while your Powerline adapters are connecting. The Power LED on Powerline adapter A/B and C will stop flashing and become solid light when the connection is made.

 **Note:**

The sequence of Step 1 and Step 2 can be exchanged.

**Leave an existing secured Powerline AV Network:**

As the figure above shown, Powerline adapter A, B and C have formed a HomeplugAV Network. The user wants to remove one device (Powerline adapter A) from this network.

- Step 1.** Press and hold the Pair button on Powerline adapter A for at least 10 seconds. Powerline adapter A will reset and restart. (The Power LED of Powerline adapter A will momentarily extinguish during resetting, flash during restarting then illuminate steadily.)
- Step 2.** Wait for the reset to complete.

## Appendix A: Troubleshooting Guide

The Troubleshooting Guide provides answers to common problems regarding the Powerline Adapter.

### 1. The Power LED does not light up.

**Ans.** Check the following:

- a) Make sure that the Powerline Adapter is properly plugged into a power outlet.
- b) Make sure the power outlet is active (working) by plugging another electric device into it.
- c) Re-plug the Powerline Adapter to the power outlet again. If the Power LED still fails to light up, contact your local dealer for technical support.

### 2. The Ethernet LED does not light up.

**Ans.** Check the following:

1. Make sure that the Ethernet cable (RJ-45) is properly connected to the Powerline Adapter's Ethernet port.
2. Make sure that the other end of the Ethernet cable (RJ-45) is properly connected to the computer LAN card or to your Cable/xDSL Ethernet port.
3. Make sure your computer LAN card is properly installed and configured.
4. Make sure your Cable/xDSL broadband access is working and configured correctly.
5. Contact your local dealer for technical support if the Ethernet LED still fails to light up after the above procedures.

### 3. The Powerline LED does not light up.

**Ans.** Check the following:

1. Double click to enable the Management Utility and click the “**Scan**” tab under the **Main** configuration homepage. The Management Utility will automatically detect all other Powerline Adapter on your power line network.
2. Try to plug a second Powerline Adapter into a nearby power outlet and check whether the Powerline LED lights up or not.
3. Contact your local dealer for technical support if the Powerline LED still fails to light up after the above procedures.

## Appendix B: Specifications

General	
Standards	HomePlug AV, IEEE802.3, IEEE802.3u
Modulation Technology	OFDM, 1024/256/64/16/8-QAM, QPSK, BPSK and ROBO
Data Rate	500Mbps
Range	300meters in house
LEDs	Power, Powerline, Ethernet
Interface	1 Ethernet LAN Port
Encryption	128-bit AES
Power Consumption	6W
Physical and Environment	
Dimensions (L×W×H)	4.1x2.3x1.6 inch (105×58×40 mm) (exclude power plug) 4.1x2.3x3.0 inch (105×58×77 mm) (include power plug)
Operating Temperature	0°C~40°C (32°F~104°F)
Operating Humidity	10%~90%RH, Non-condensing