



# User Guide

Kasa Smart Wi-Fi Dimmer Switch, Motion-Activated

# Contents

About This Guide .....	1	Manage Device Settings .....	25
Introduction .....	2	Reset Your Smart Dimmer Switch .....	35
Appearance .....	3	Create Groups .....	38
Set Up Your Smart Dimmer Switch .....	4	Create Scenes .....	42
Main Device Controls .....	10	Smart Actions .....	44
Adjust Brightness .....	11	Discover Kasa .....	55
Set Preset Brightness .....	12	Authentication .....	56
Configure Smart Control .....	13		
Set Schedules .....	20		
Set Timer .....	23		
Set Away Mode .....	24		

# About This Guide

This guide provides a brief introduction to Kasa Smart Wi-Fi Dimmer Switch and the Kasa Smart app, as well as regulatory information.

Features available in Kasa Smart Wi-Fi Dimmer Switch may vary by model and software version. Kasa Smart Wi-Fi Dimmer Switch availability may also vary by region. All images, steps, and descriptions in this guide are only examples and may not reflect your actual experience.

## Conventions

In this guide, the following convention is used:

Convention	Description
Teal	Key information appears in teal, including management page text such as menus, items, buttons and so on.
<u>Underline</u>	Hyperlinks are in teal and underlined. You can click to redirect to a website.

## More Info

- Specifications can be found on the product page at <https://www.tp-link.com>.
- Our Technical Support and troubleshooting information can be found at <https://www.tp-link.com/support>.
- A TP-Link Community is provided for you to discuss our products at <https://community.tp-link.com>.
- Frequently Asked Questions (FAQs) can be found at <https://www.tp-link.com/support/faq/>.

# Introduction

Built-in motion and ambient light sensors work together for true hands-free control. Our smart dimmer conveniently auto-adjusts your room's brightness. With Smart Control, further customize your light settings to follow your routine with the easy-to-use app. Just set it then forget it. The Kasa Smart app also provides easy step-by-step installation instructions and enables convenient remote control from anywhere, anytime.



**Advanced  
Sensing**



**Smart  
Control**



**Easy  
Installation**



**Customized  
Dimming**



**Energy  
Saving**



**Control from  
Anywhere**



**No Hub  
Required**



**Set  
Schedules**



- **Advanced Sensing** - The equipped sensors detect motion and ambient lighting so your lights only trigger on at night.
- **Smart Control** - Set different light triggers based on your routine for effortless control.
- **Easy Installation** - The detailed in-app guide and unique circuit design make installation simple.
- **Customized Dimming** - Experience a full range of brightness before fading them off for bedtime.
- **Energy Saving** - Turn off the light automatically after you leave the room for a set time.
- **Control from Anywhere** - Control anything connected to your smart light switch, like lights, ceiling fans or other fixtures, from anywhere using the Kasa Smart app.
- **No Hub Required** - Connect to your existing Wi-Fi router.
- **Scheduling** - Set lights to automatically turn on and off throughout the day or night whether you're home or away.

# Appearance

The Smart Dimmer Switch is compatible with incandescent, LED, Halogen, and compact fluorescent light bulbs. The dimmer switch also includes two brightness adjustment buttons, and an LED indicator to easily locate the dimmer switch at night. See the explanation below:

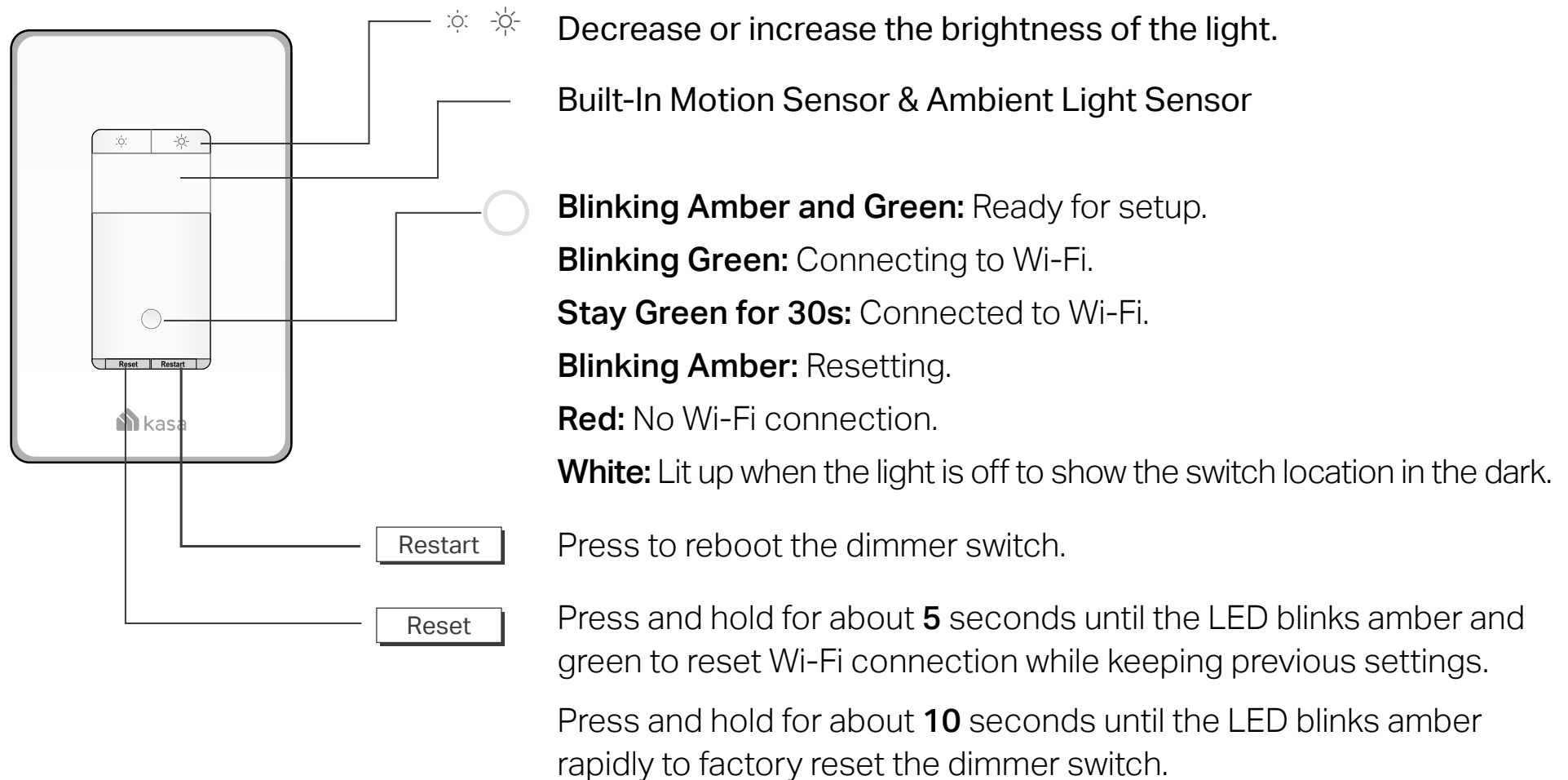

# Set Up Your Smart Dimmer Switch

Follow the steps below to set up your Smart Dimmer Switch via [Kasa Smart](#) app.

## 1. Download and install Kasa app

Go to App Store or Google Play or scan the QR code below to download the [Kasa Smart](#) app on your Android or iOS device.



OR



## 2. Log in or sign up

Open the app. Use your TP-Link ID to log in. If you don't have a TP-Link ID, tap [Create Account](#) and the Kasa app will guide you through the rest.

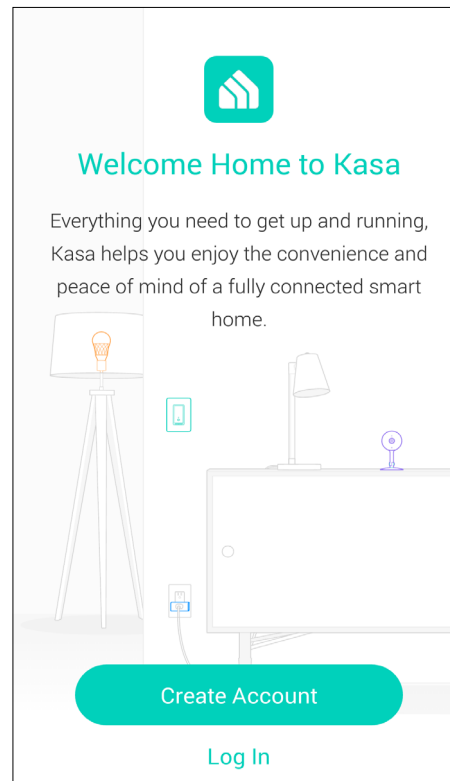

## 3. Add Device

Tap the + button in the Kasa app, select [Smart Switches](#).

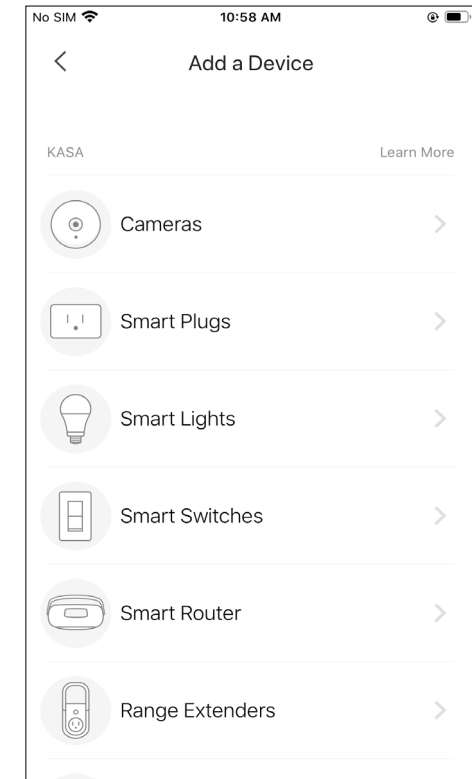

## 4. Install the Dimmer Switch

1. Turn off the circuit breaker first.

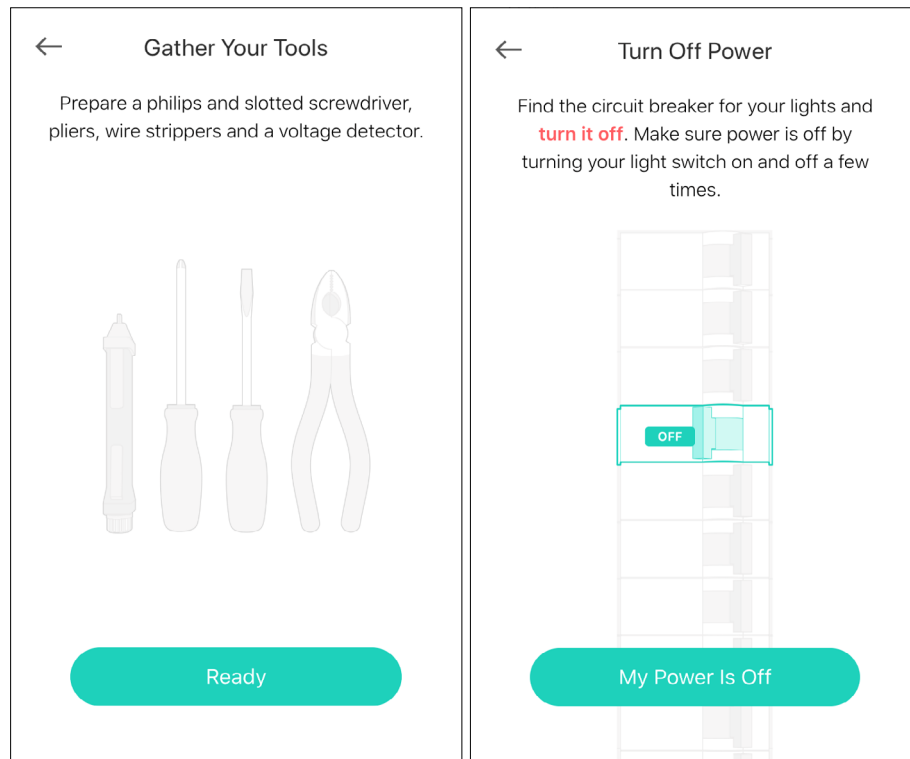

2. Remove the old wallplate and expose the wiring.

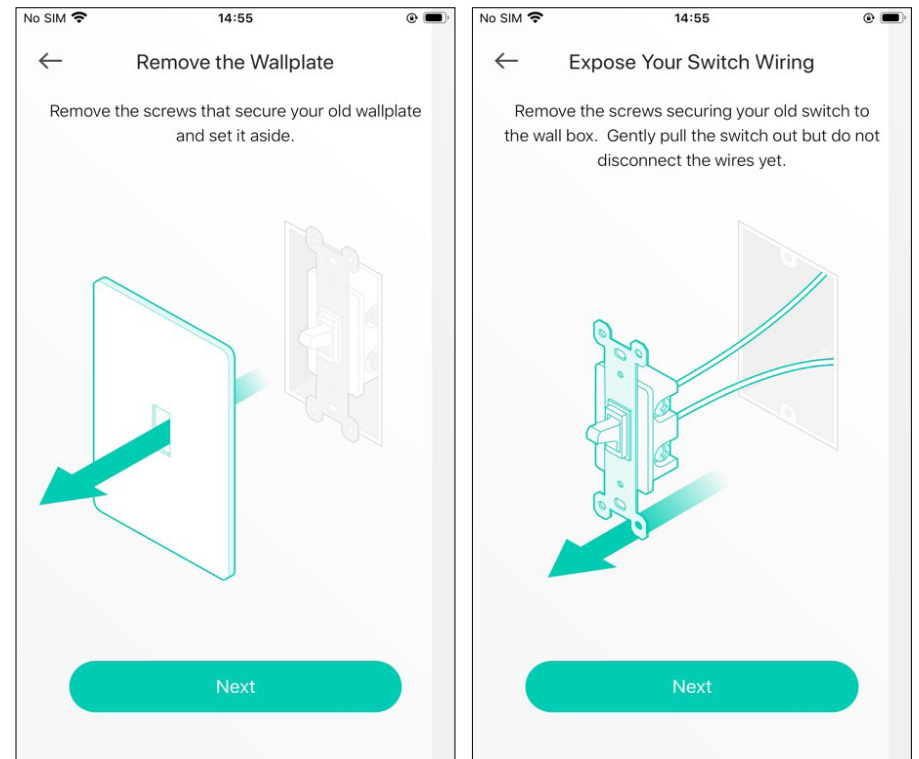

## 4. Install the Dimmer Switch

3. Look for a bundle of white wires, and label one of it as **Neutral**.

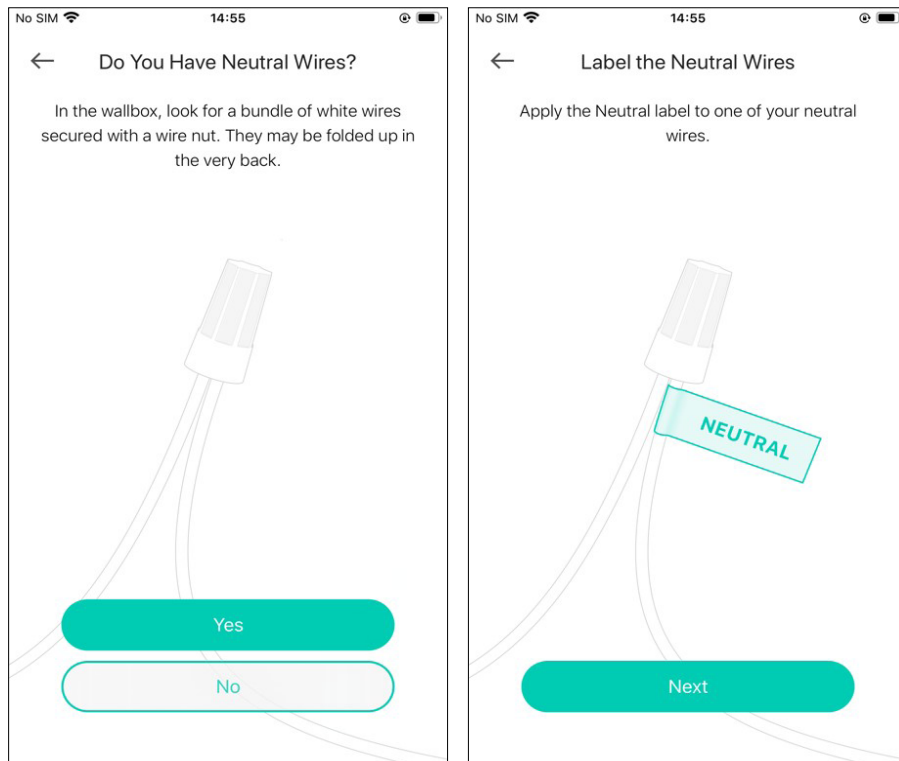

4. Look for a green or copper wire, and label it as **Ground**.

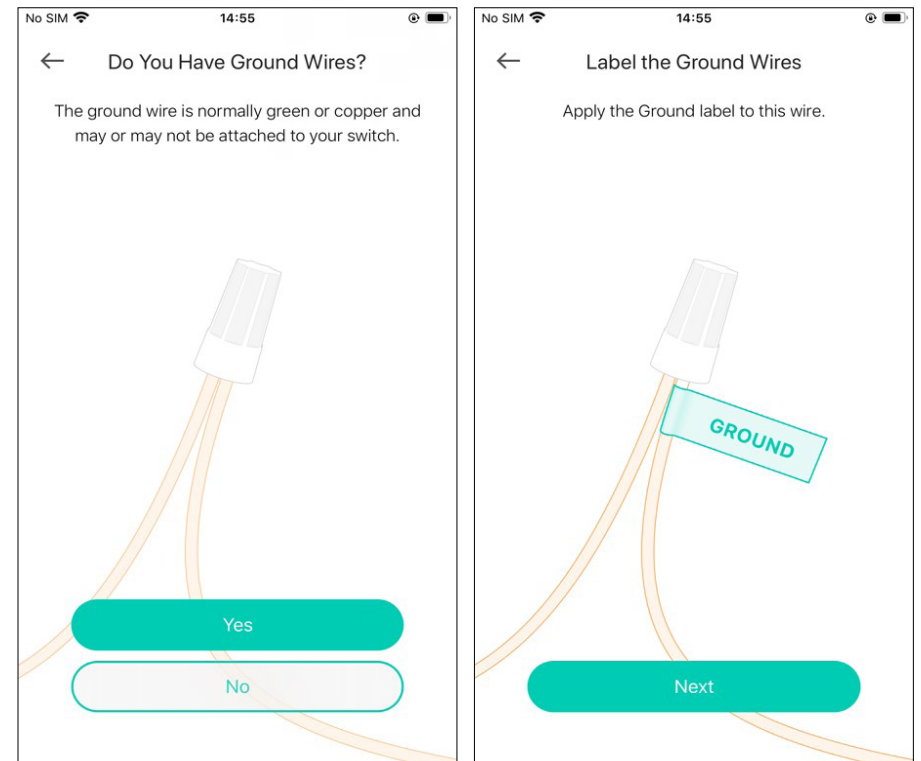



## 4. Install the Dimmer Switch

5. Turn on power.

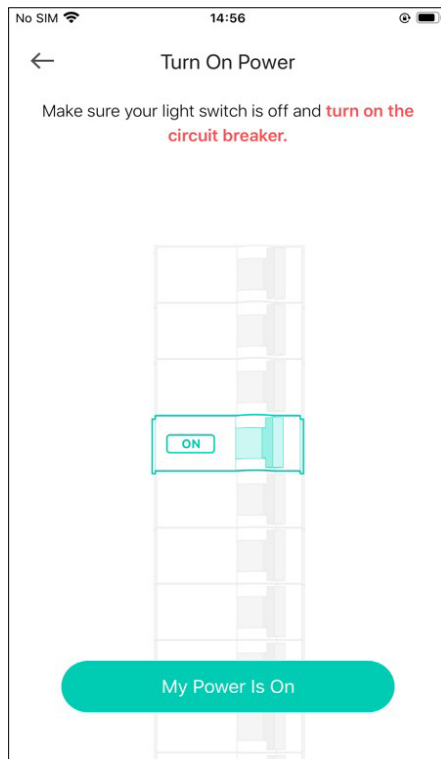

6. Use a voltage detector to find the energized wire, this is the **Line** wire. The other wire is the **Load** wire. Then label the Line and Load wire.

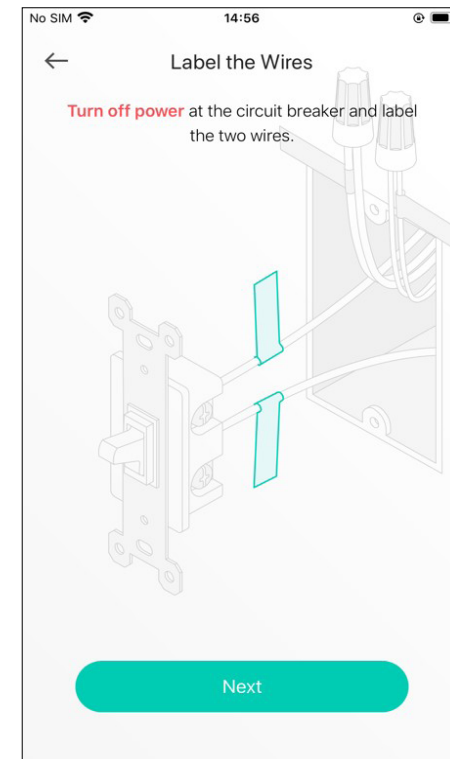
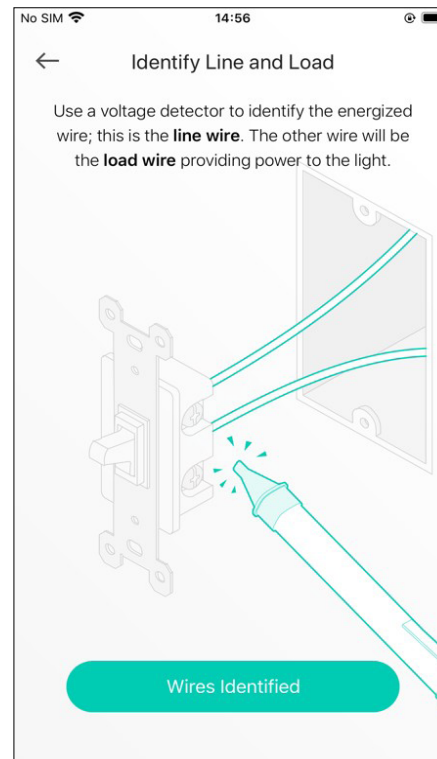

## 4. Install the Dimmer Switch

7. Turn off power again.

Then connect the wires.

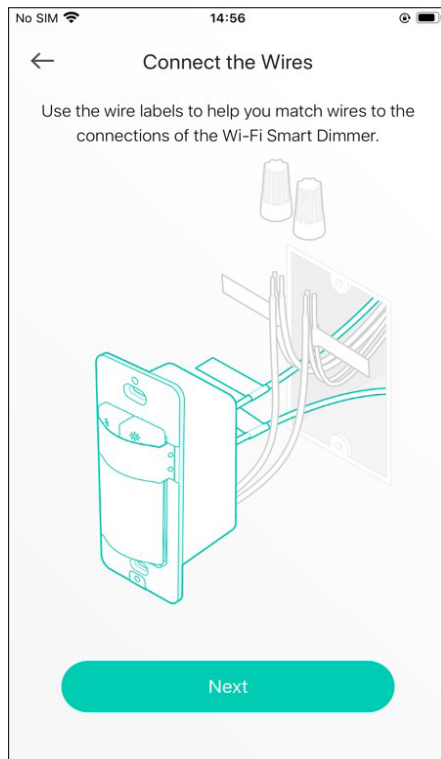

8. Install the dimmer switch and then attach the wallplate.

Turn on power again.

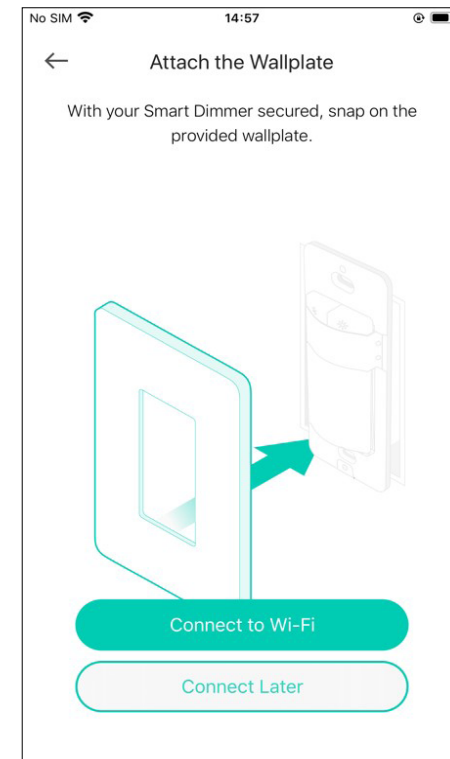
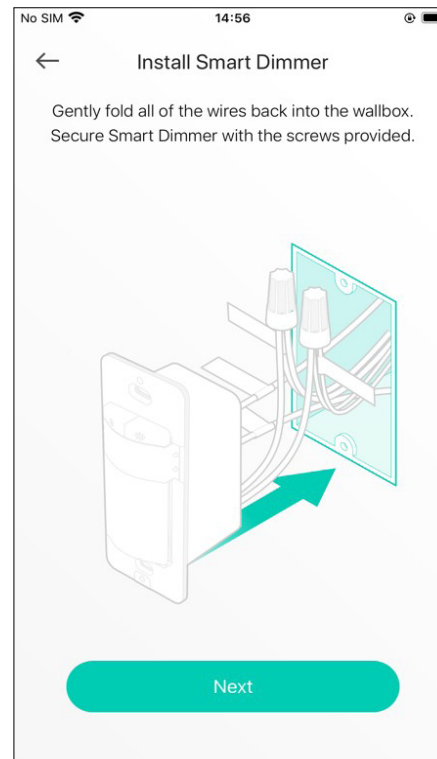

## 5. Set Up the Dimmer Switch

After installation, follow step-by-step app instructions to complete the setup.

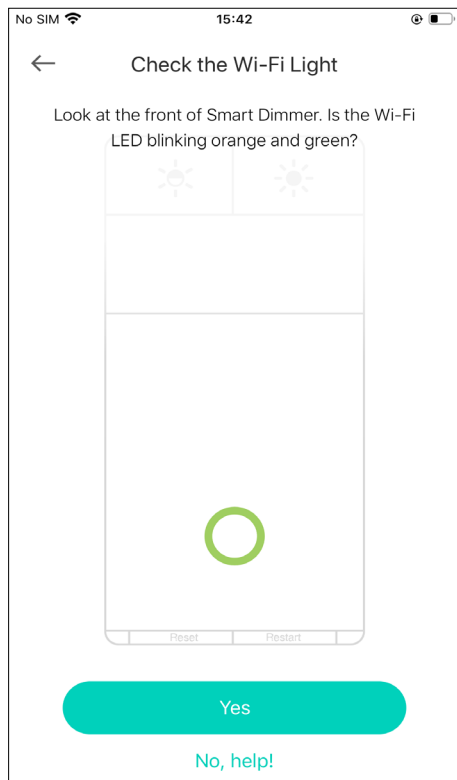

# Main Device Controls

After you successfully set up your Smart Dimmer Switch, you will see the home page of the Kasa Smart app. Here you can view and manage all devices that you've added to Kasa. Tap your dimmer switch to control and manage it.

## Home Page

You can see all your Kasa devices listed in the Home page.

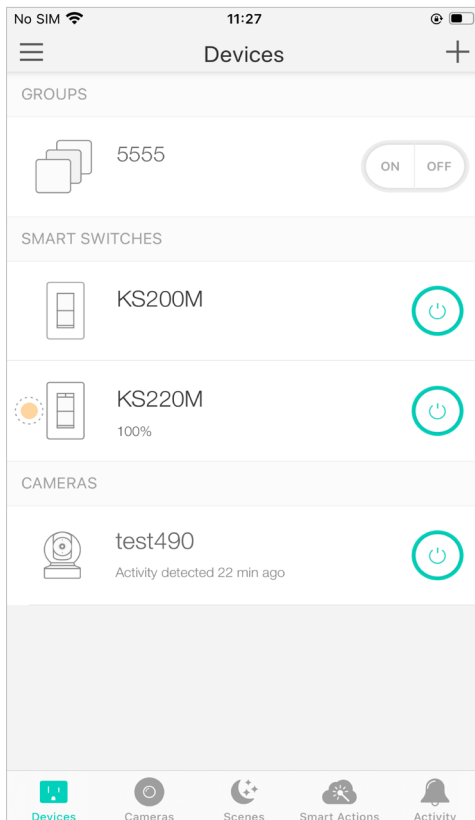

## Turn on/off the dimmer switch

Turn on/off your Smart Dimmer Switch quickly by tapping the on/off switch in the home page. Tapping the device to enter its Status page, you can also check or change its status.

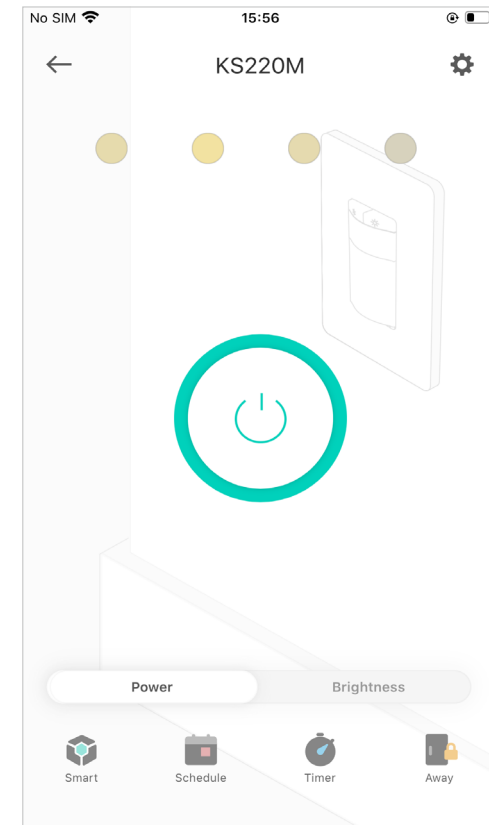
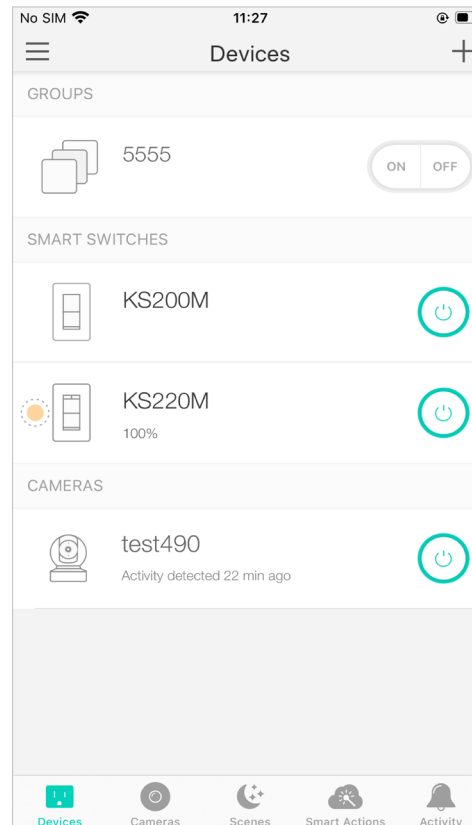

# Adjust Brightness

Adjust the brightness of your light from 1% to 100% to have the perfect atmosphere for any activities.

Go to the status page and tap the **Brightness** tab. Your light will change brightness to the value you set.

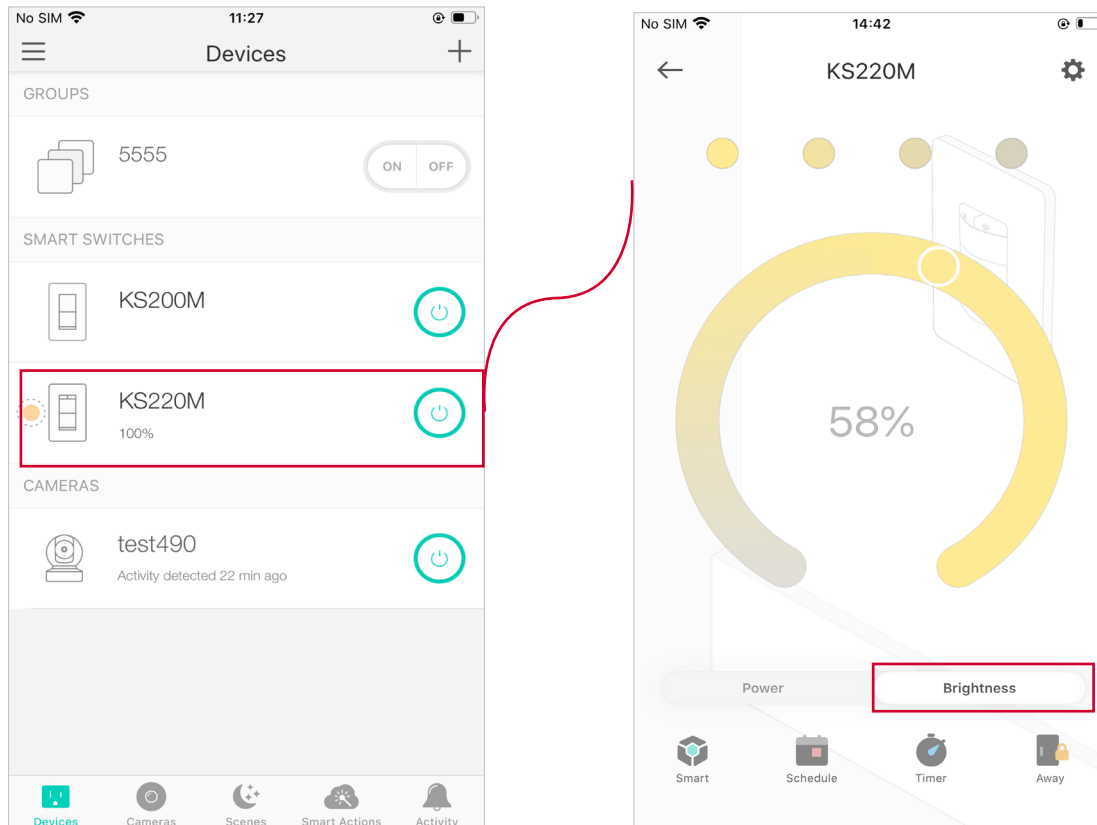

# Set Preset Brightness

Set preset brightness levels so you can switch to the desired brightness with just one tap. You can set up to 4 preset brightness levels.

1. Go to the status page and tap the [Brightness](#) tab. Tap the circle on the top and choose a brightness. A preset brightness is set successfully.

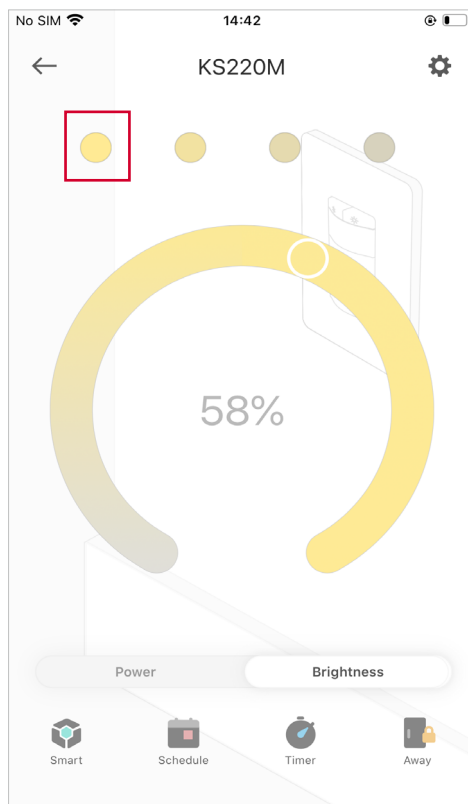

2. Change the preset brightness.

Tap a preset, then tap  beside it. A pop up message will appear in the bottom. Choose another brightness level and tap [Save](#).

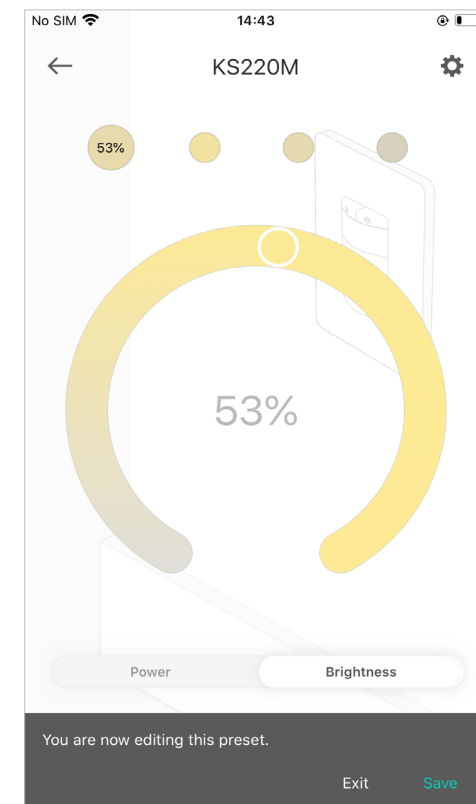
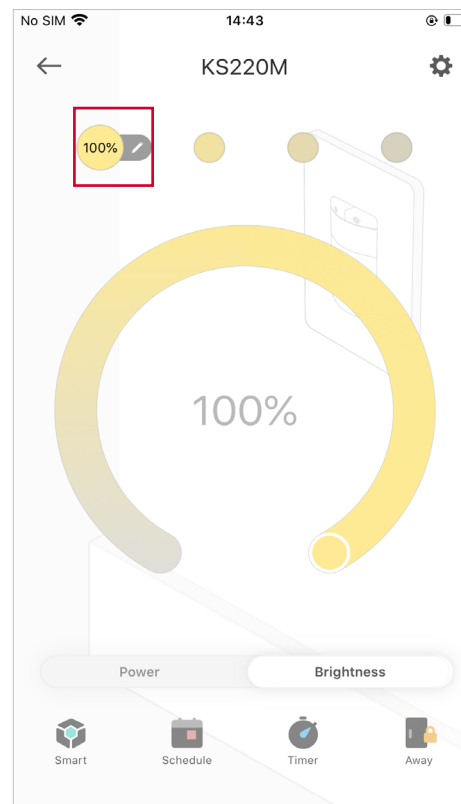

# Configure Smart Control

**Smart Control:** Set different light triggers to enjoy effortless control of your dimmer switch with the built-in ambient light sensor and motion sensor. For example, you want your light to turn on automatically when you go to the bathroom at night.

1. Tap  in the status page.

2. Tap [Create Rule](#).

3. Tap [Add Time](#) to add an effective period of time for your Smart Control to take effect.

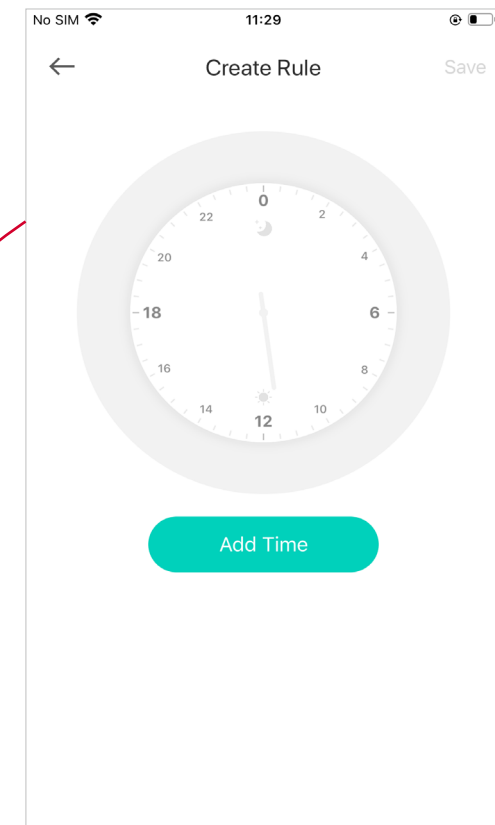
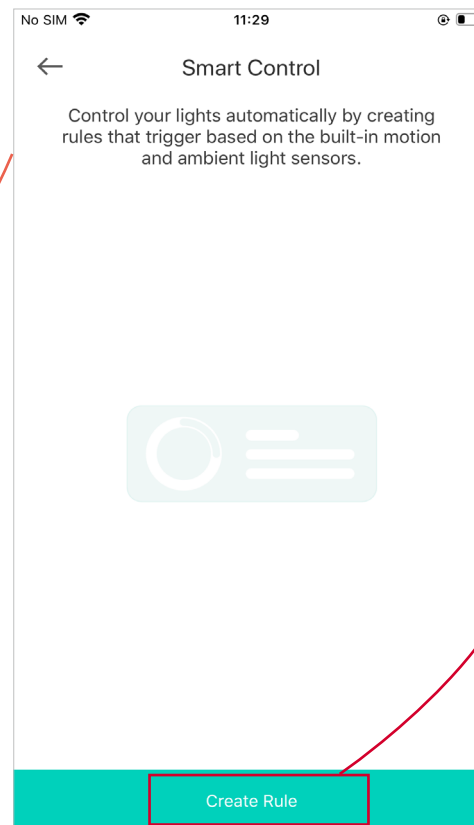
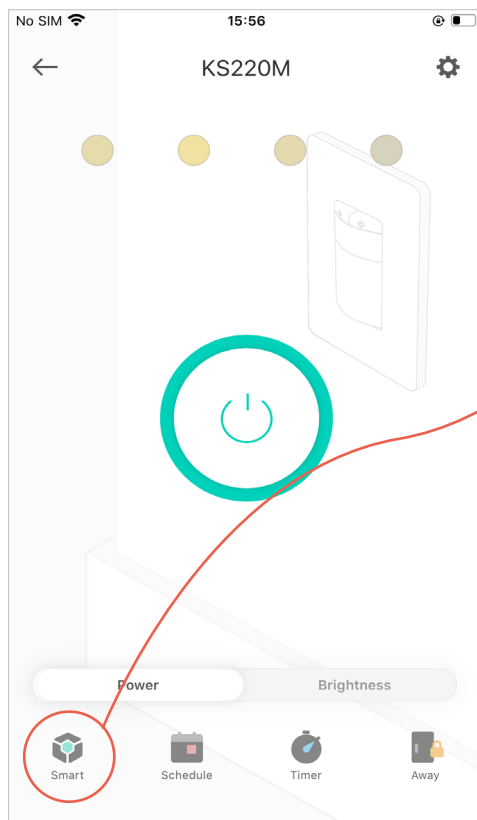

4. A time period appears automatically. Drag the end points or the whole segment to adjust time, or enter the start and end time. The specific rule settings are listed down below.

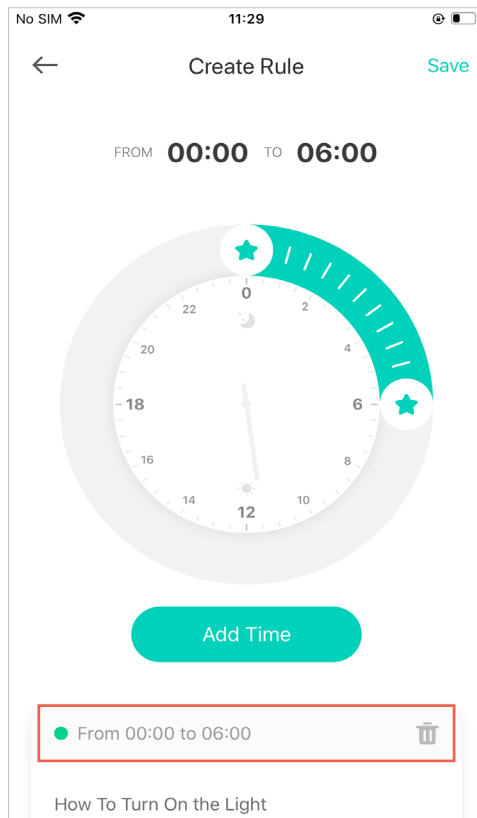

5. Slide up to see the rule settings. Tap to change the settings.

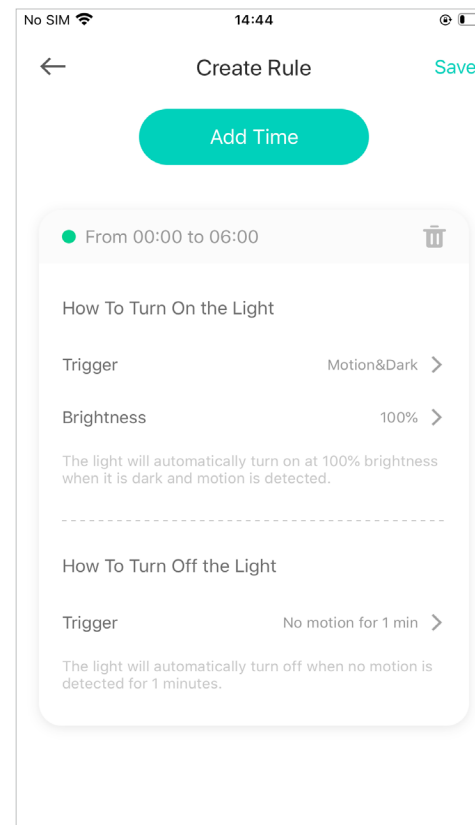



6. Set the trigger that turns on your light during the set time period.

**Manual Only:** Only turn light on manually.

**Motion Detected:** Turn on light automatically when motion is detected. See ["Customize Motion Sensor Settings"](#) to change motion sensor settings.

**Motion Detected When It's Dark:** Turn on light automatically when motion is detected and it is dark. See ["Customize Ambient Light Sensor Settings"](#) to change ambiance settings.

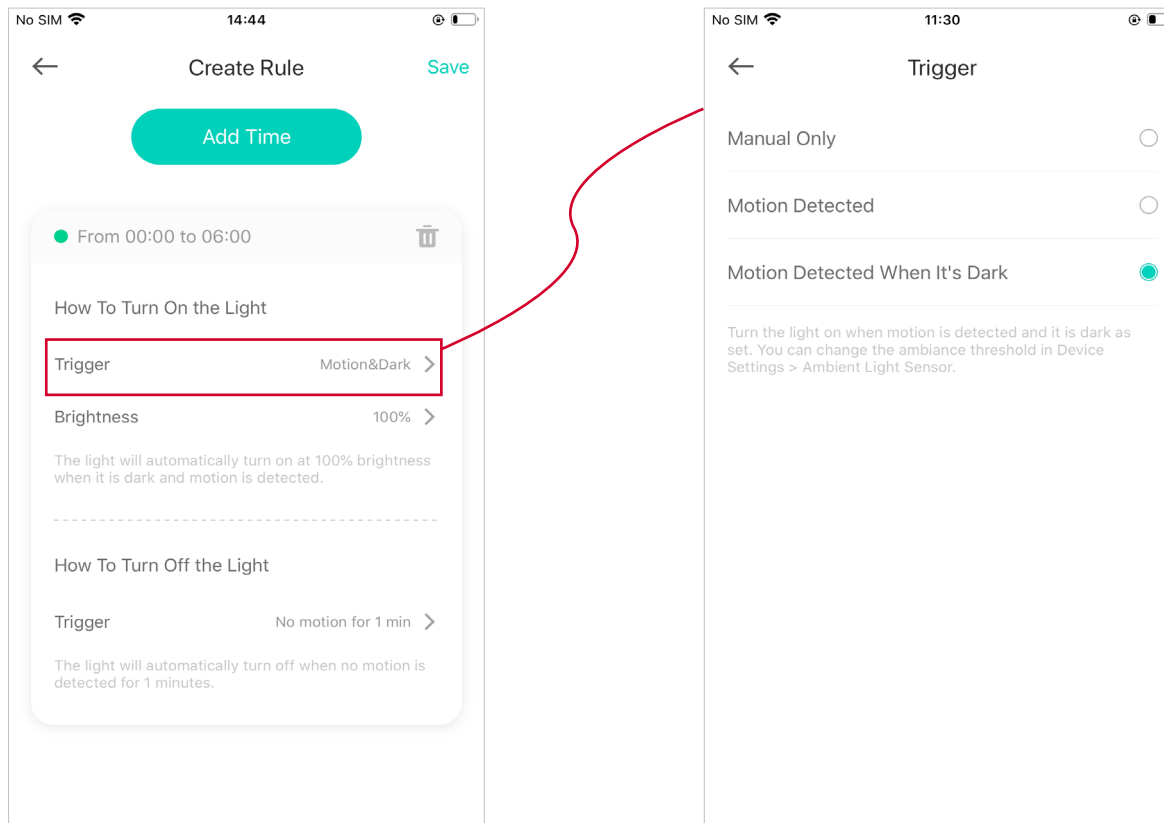

7. Set the brightness that you want your light to turn on to.

**Brightness:** Select an exact brightness value.

**Last "On" State:** Return to the brightness when the light was last on.

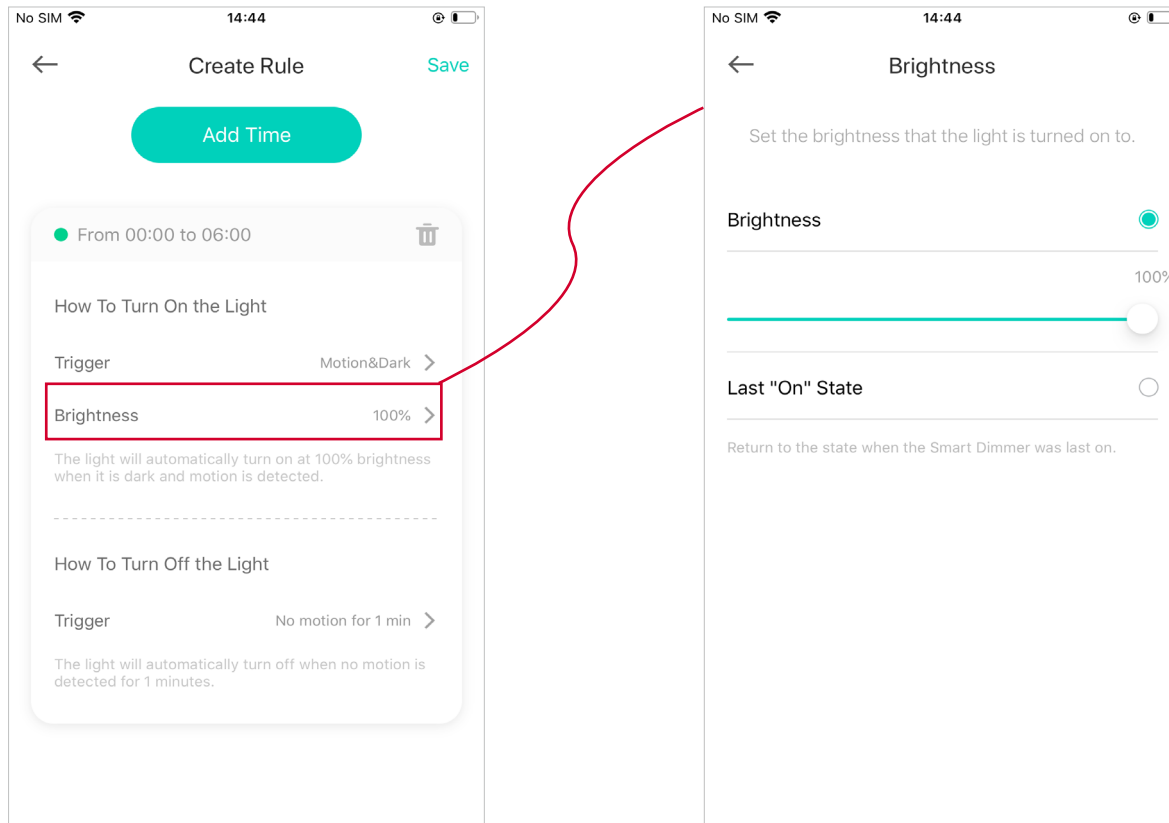

8. Set the trigger that turns off your light during the set time period.

**Manual Only:** Only turn the light off manually.

**No motion detected:** Choose a time period, and the light will be off automatically if no motion is detected during the selected time period.

No need to worry that your light will stay on.

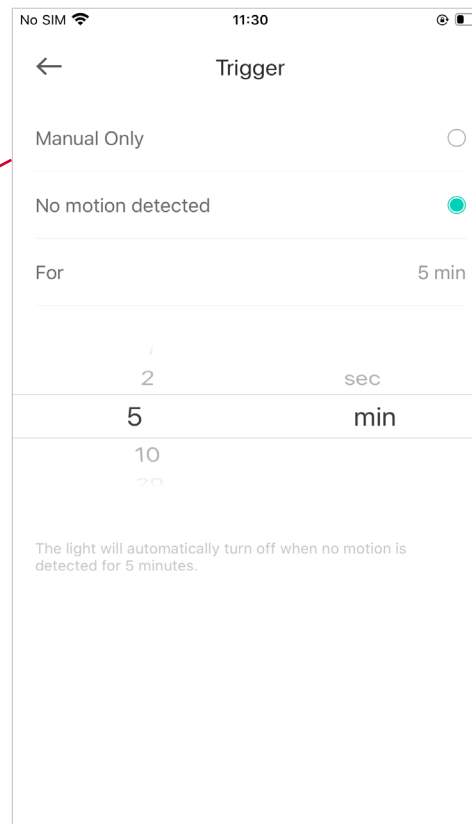
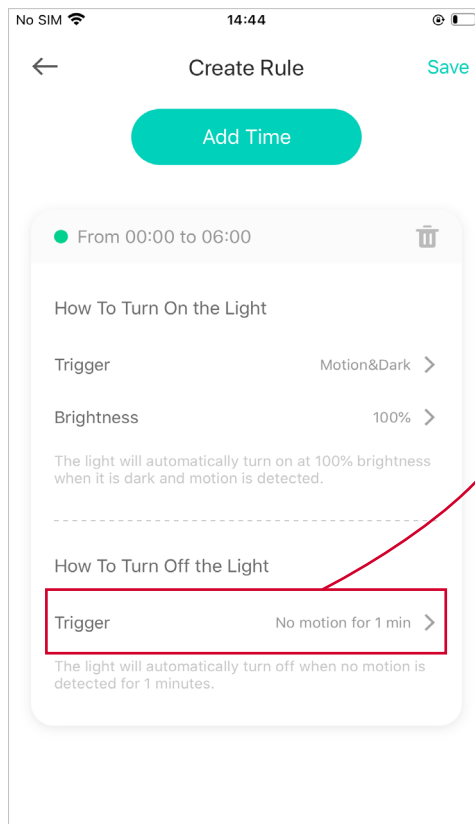

9. Tap **Add Time** to add more effective time periods and customize its settings if you want. Then tap **Save** on the top right corner to save your Smart Control rules.

Note: Smart Control can work differently in different time periods and repeats every day.

10. Change rule settings.

Tap **Edit Rule** to change the settings of each time period.

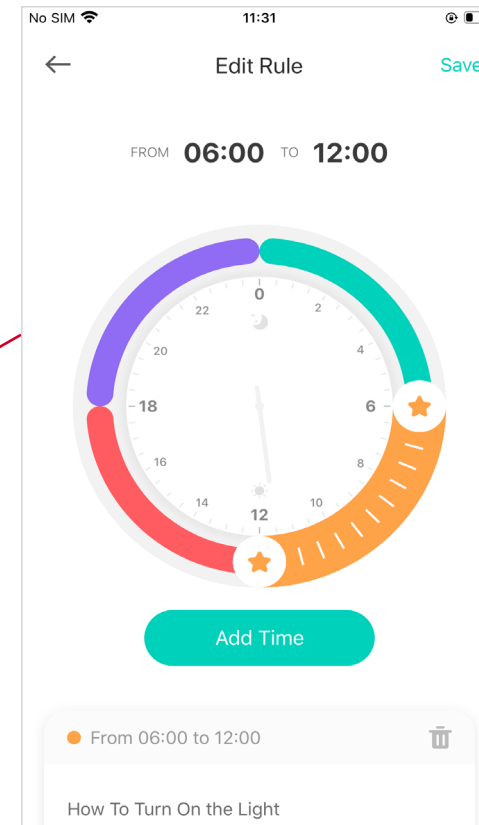
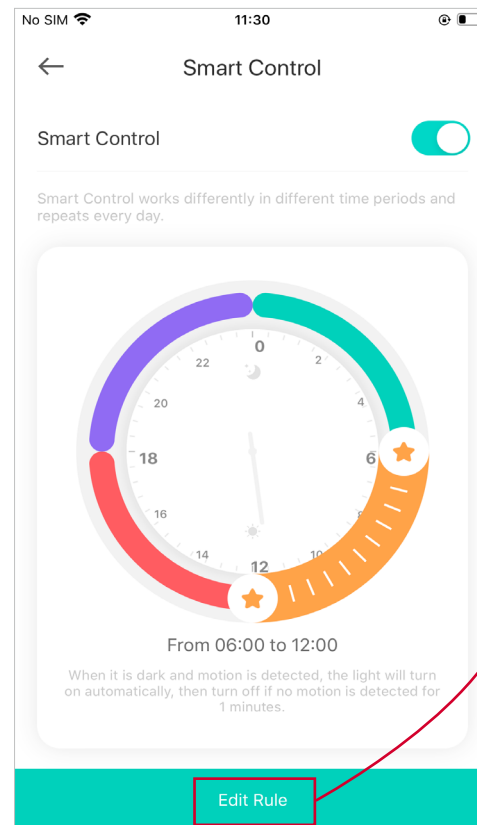
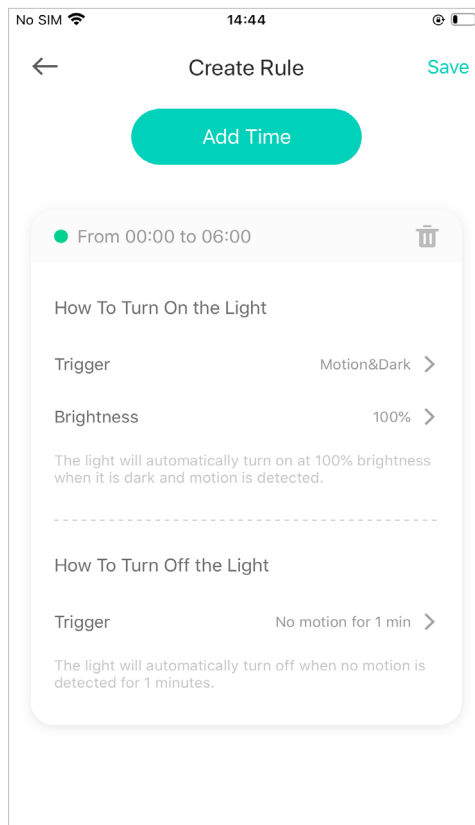

11. Turn the Smart Control off in one tap.

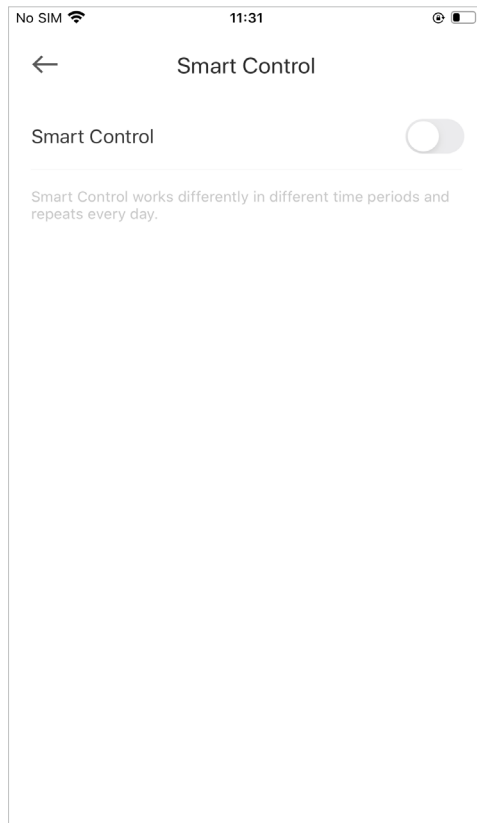

12. Delete the Smart Control.

Tap [Edit Rule](#), then slide up, and tap [Delete](#) at the bottom.

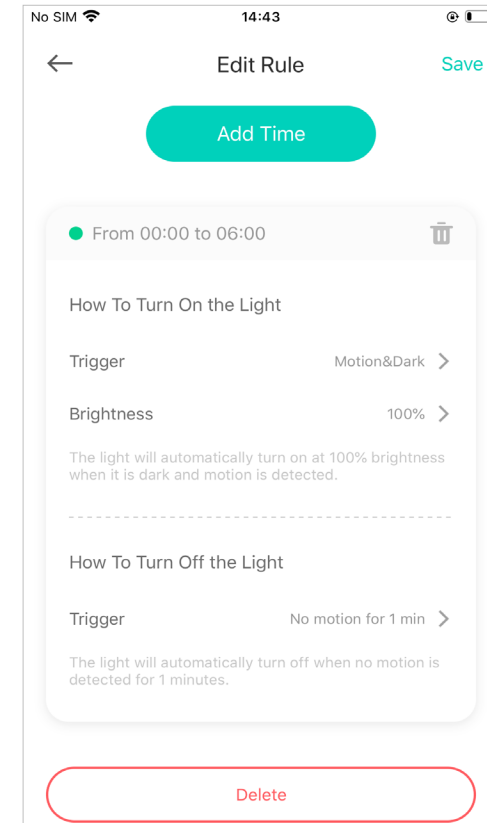
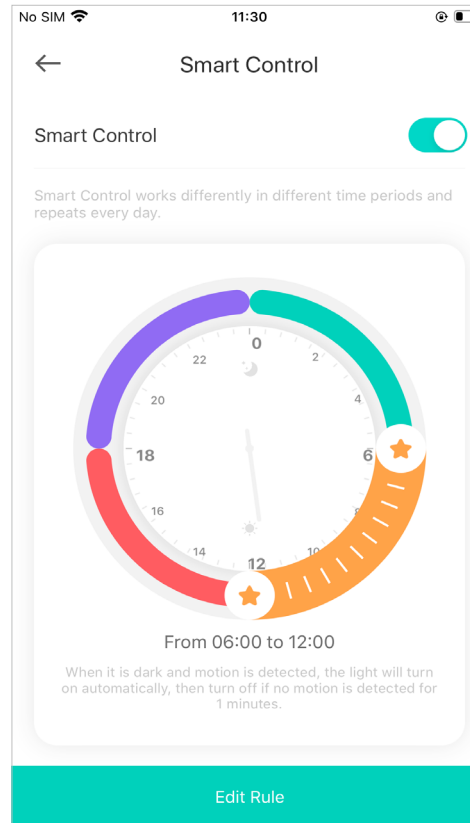

# Set Schedules

**Schedule:** Set schedules to automatically turn on/off the light at set times according to your daily routine.

1. Tap your Smart Dimmer Switch in the Home page, and then tap  .

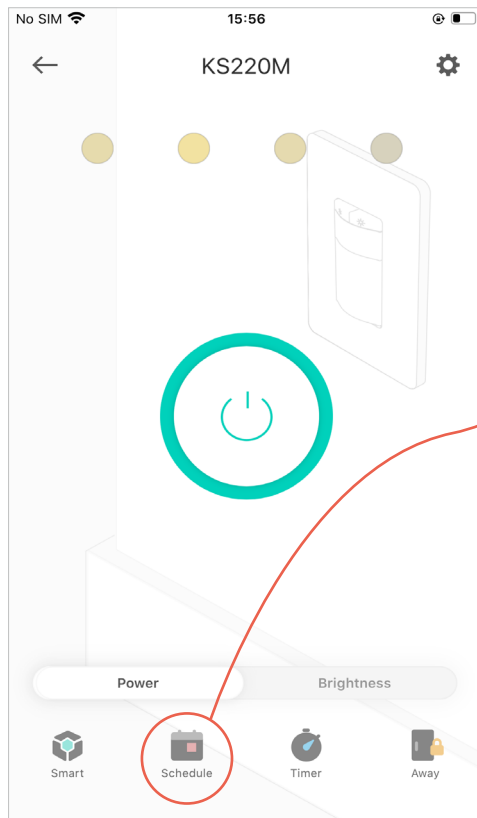

2. Tap + on the top right corner.

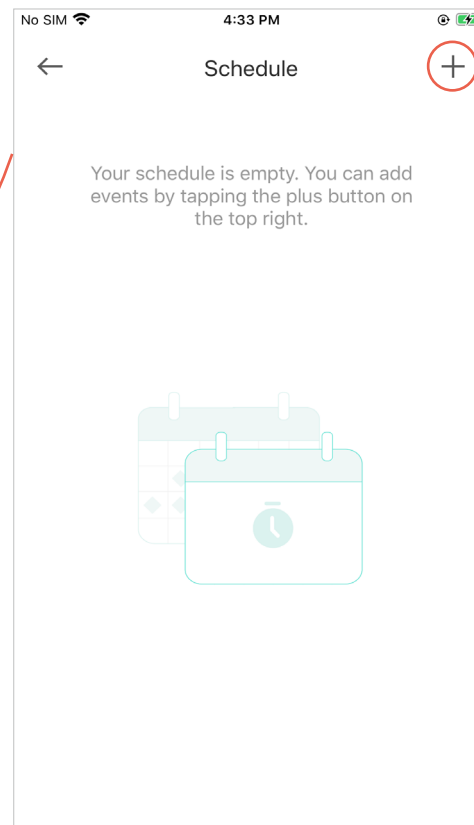

3. Choose an action that you want your light to do, for example, simply turn on/off at certain time, or turn on at a preset brightness.

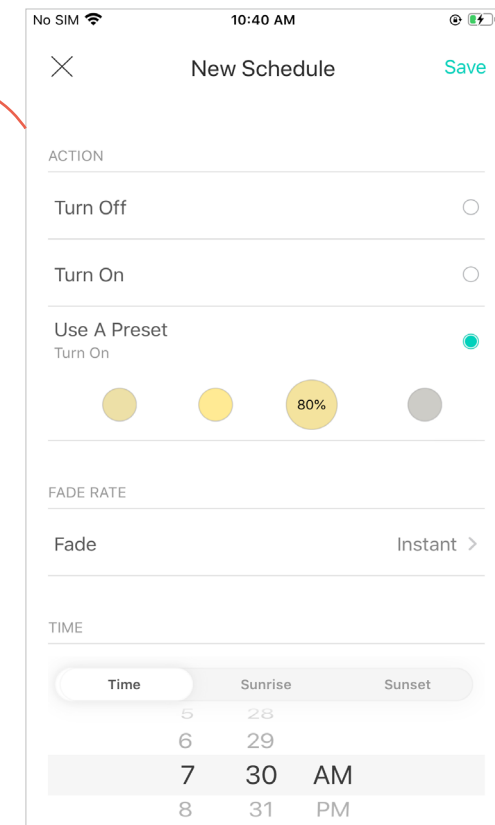

4. Set fade rate, i.e., how long you would like your light to fade in or fade out after your schedule starts.

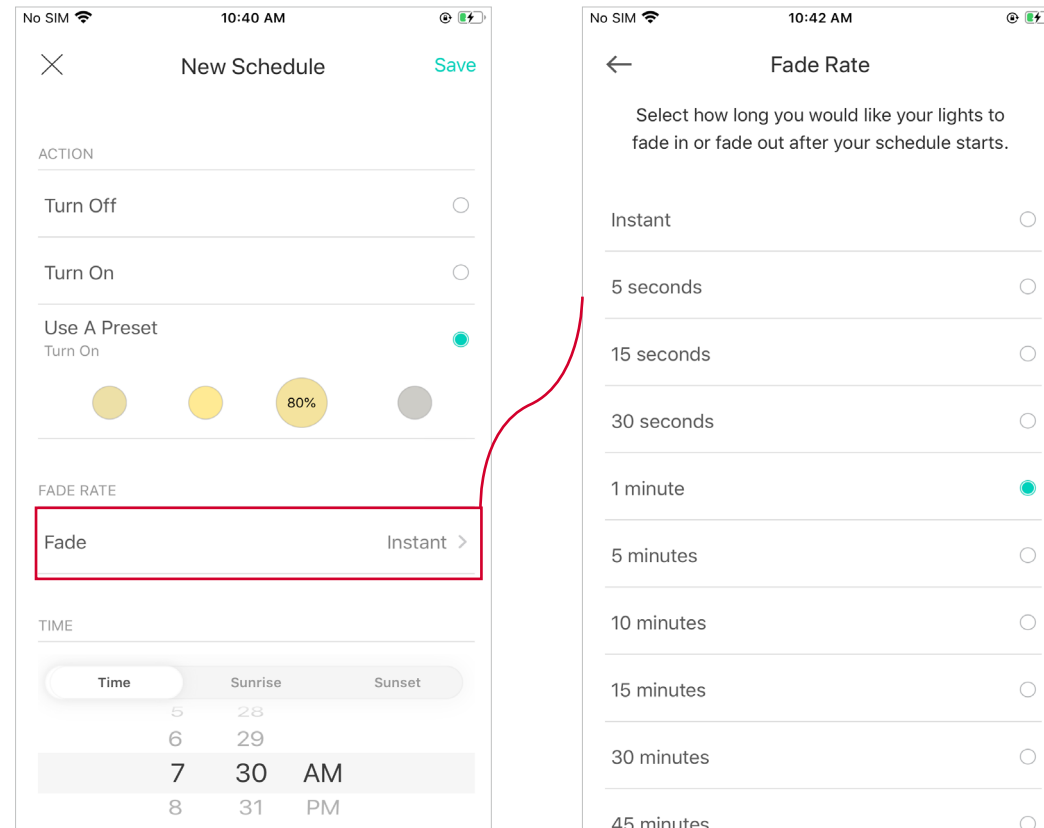

5. Select the time and repeating frequency at which you want your schedule to run.

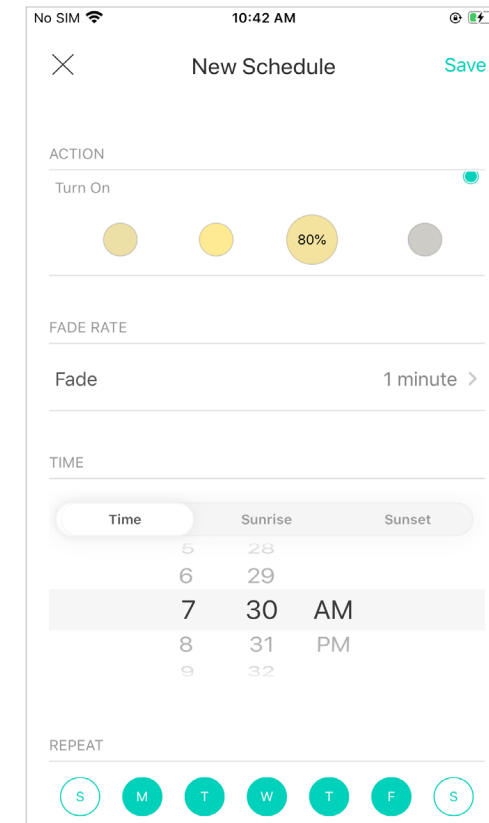

5. Tap [Save](#) and you'll see your schedule listed in the [Schedule](#) Page. Now your light will be turned on to 80% brightness at 7:30 AM every weekday.

You can add more schedules following the same steps.





# Set Timer

**Timer:** Set the timer for your light to automatically turn on/off after the time ends.

1. Tap your Smart Dimmer Switch in the Home page, and then tap  .

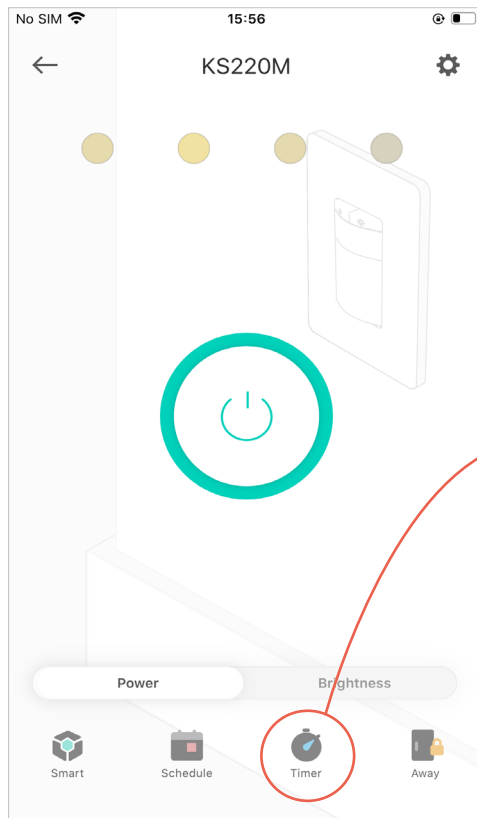

2. Set the time after which the light will be automatically turned on/off.

For example, when I turn on the light, I want it to be off after 30 minutes.

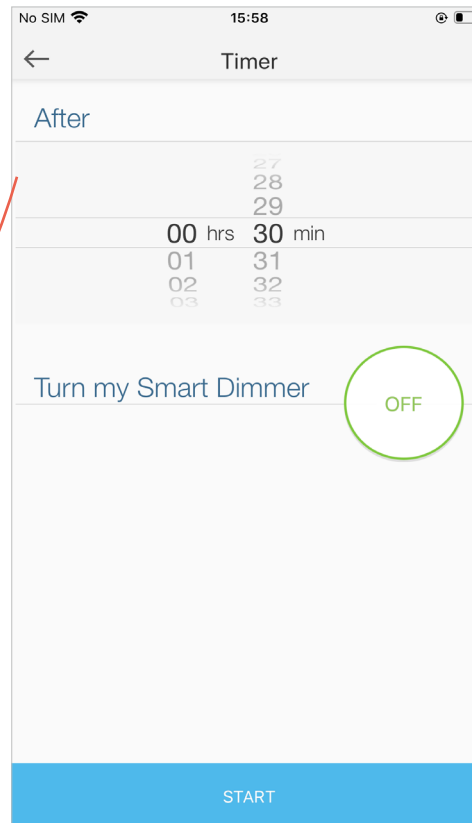

2. Tap **START** and you'll see the timer is counting down. Tap **Stop** to stop the Timer at any time.

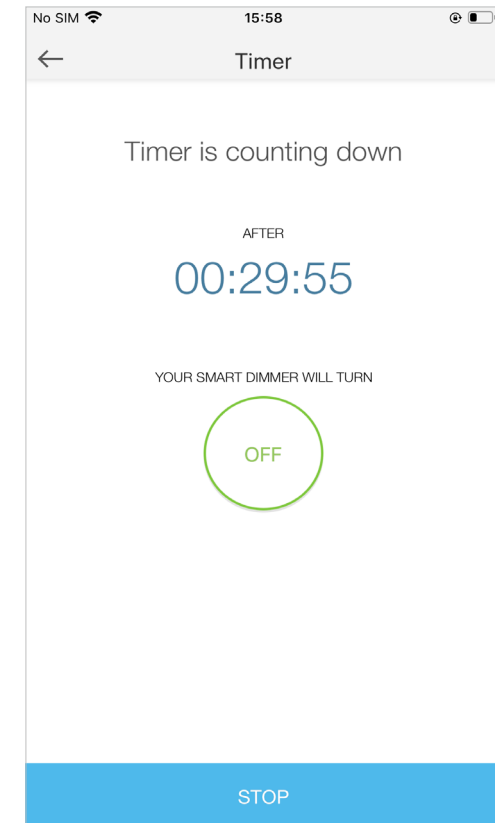

# Set Away Mode

**Away Mode:** Set Away Mode for your light to turn on/off the light automatically at random intervals while you are away to make the appearance that someone is at home.

1. Tap your Smart Dimmer Switch in the Home page, and then tap .

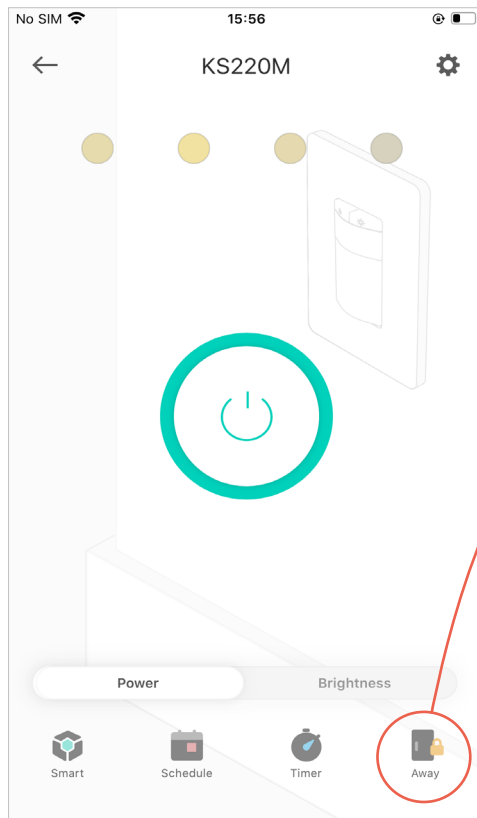

2. Set the start and end time during which the light will be automatically turned on and off at random intervals, and the repeating frequency.

**e.g.** I want the light to turn on and off between 7:00 PM to 11:50 PM every Friday and Saturday.

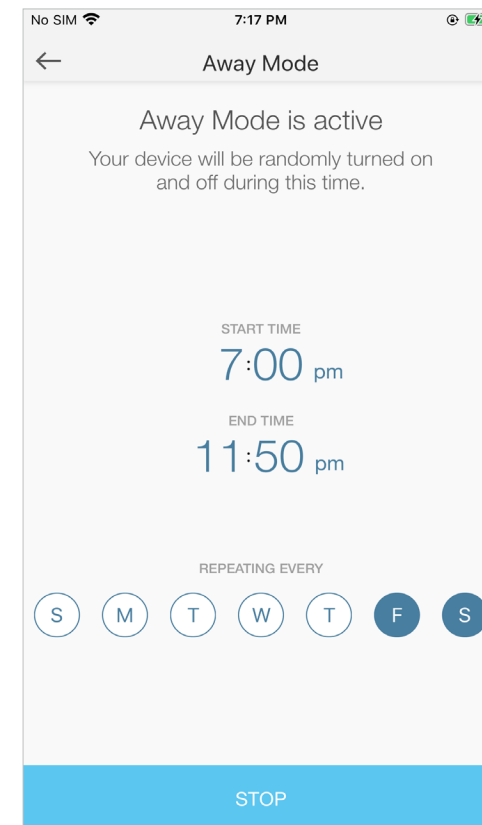
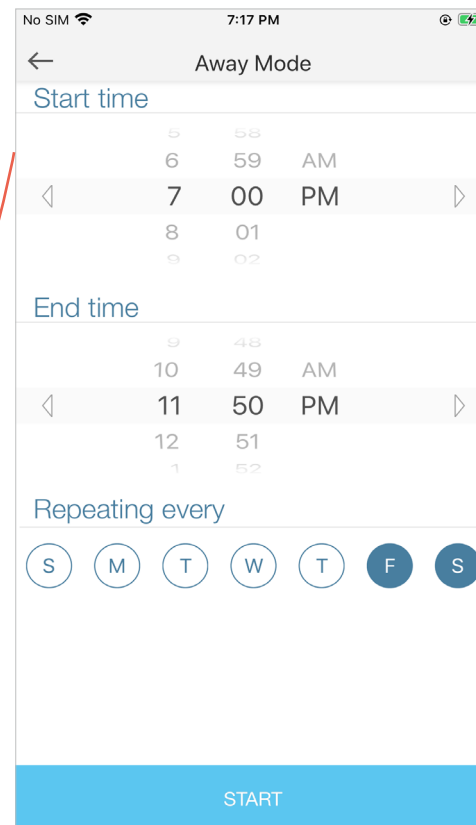

# Manage Device Settings

You can change the settings in the [Device Settings](#) page.

Tap your Smart Dimmer Switch in the Home page and then tap  to enter the [Device Settings](#) page.

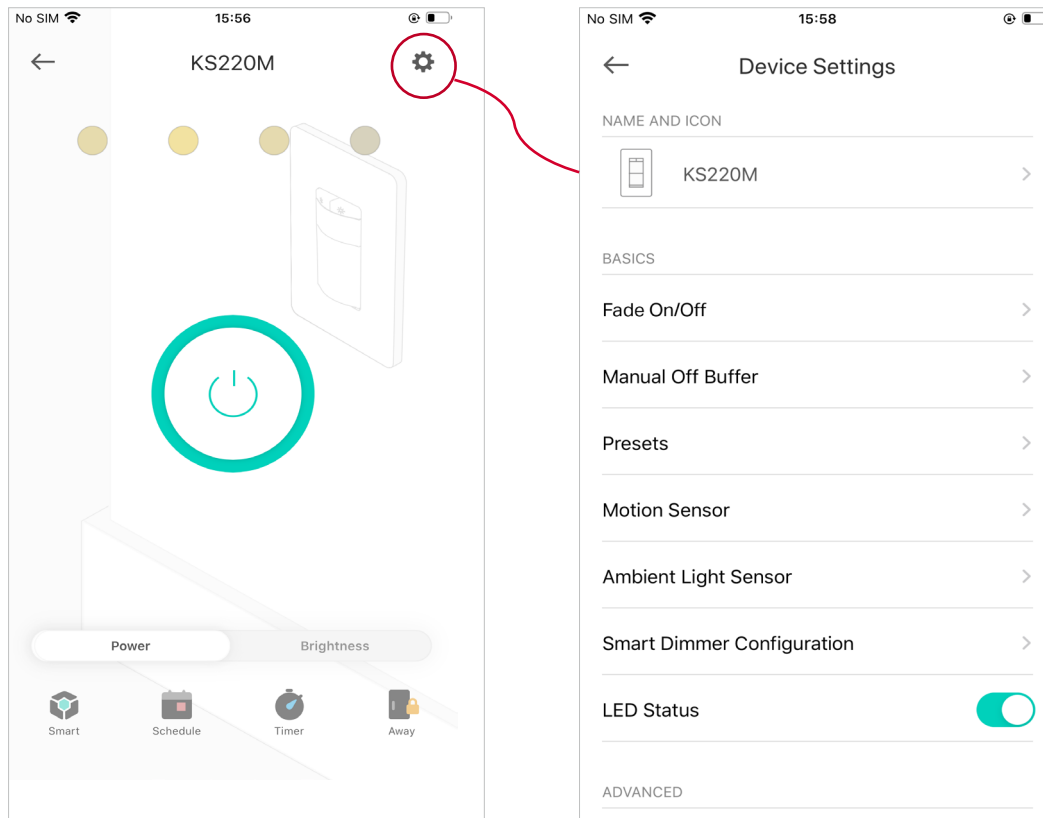

## Change Device Name & Icon

Change the name and icon of the dimmer switch.

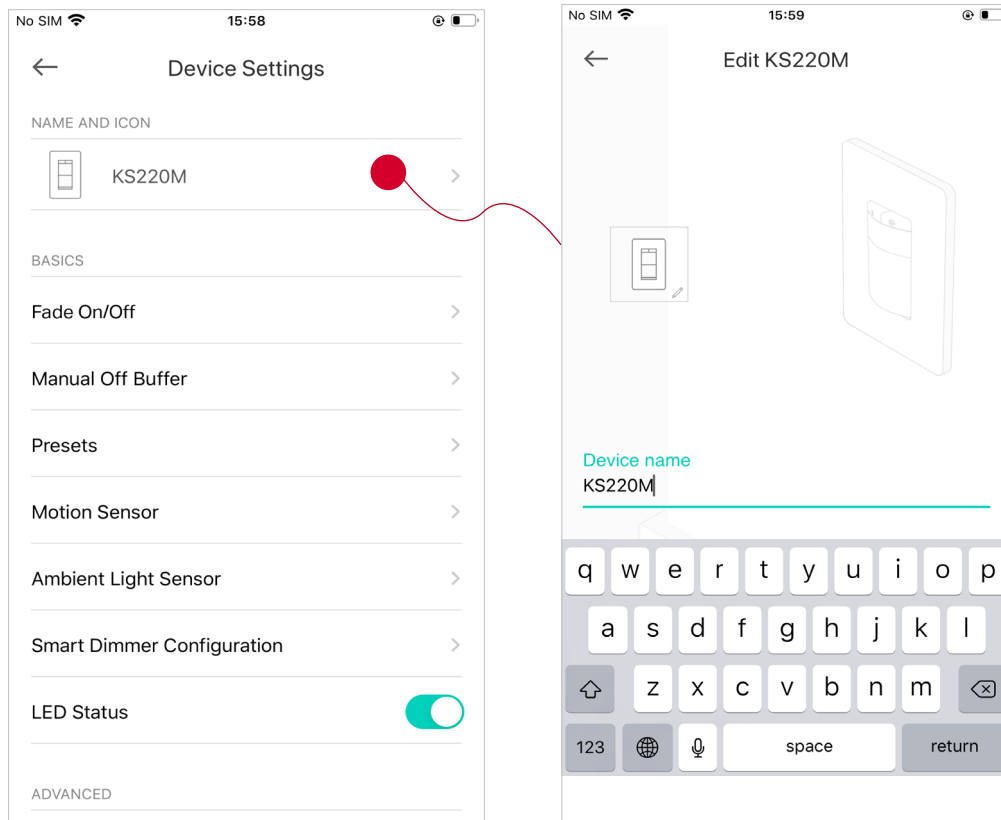

## Fade On/Off

Set [Fade On/Off](#) to slowly turn the light on and off. You can set the duration for the light to turn on or off.

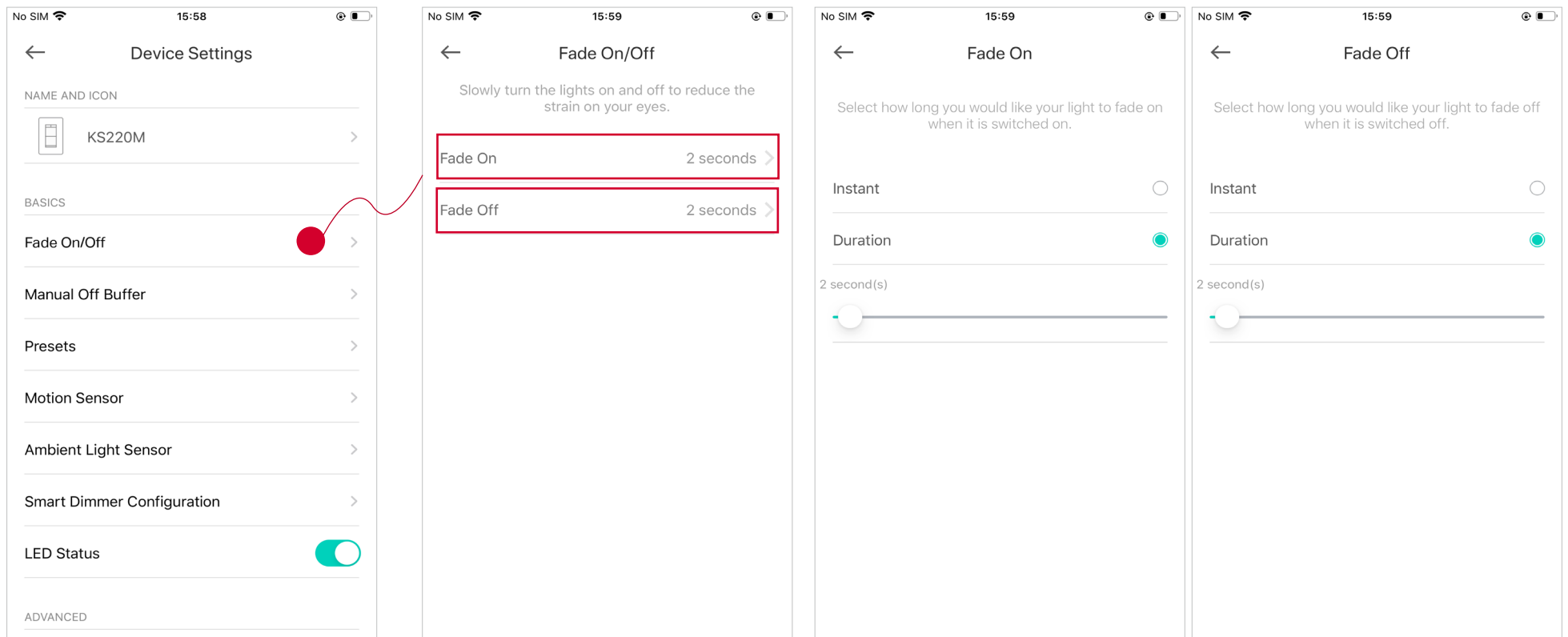

## Manual Off Buffer

If you have set [Smart Control](#) for your light to be automatically turned on when motion is detected (or when motion is detected and it's dark), you don't want your steps to trigger the light on immediately after you manually turn off the light. Then you can set a buffer time before the [Smart Control](#) will activate to give you time to leave the room.

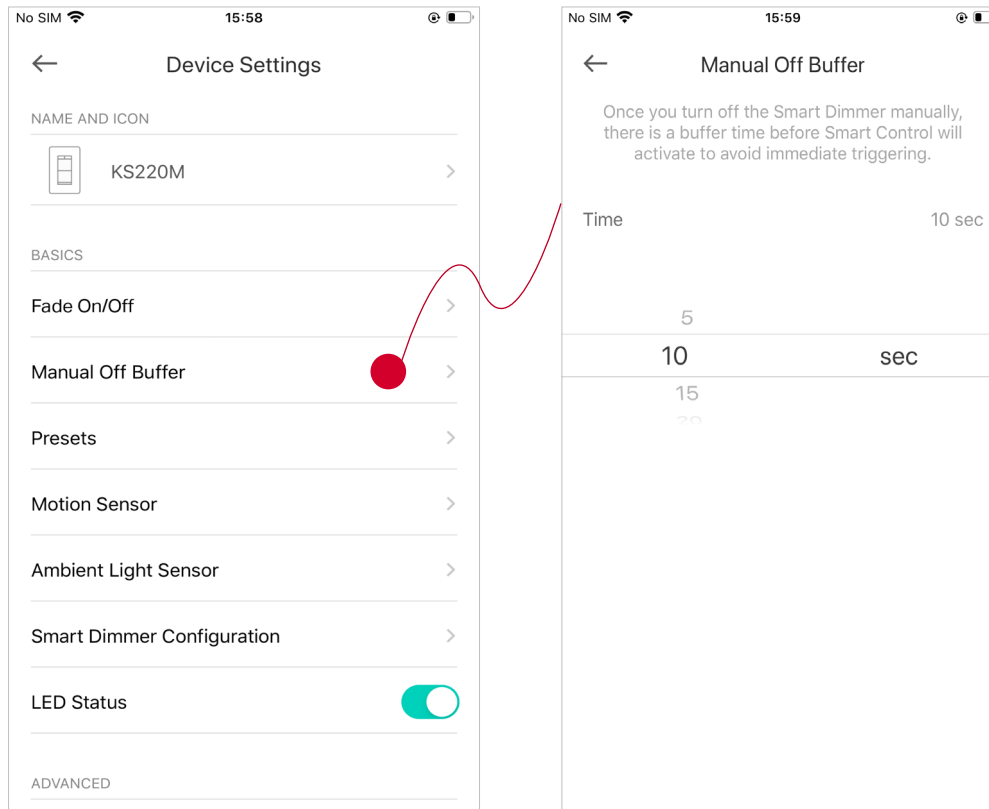

## Presets

Set presets to quickly switch to the desired light effect.

Set gentle off, which turns your light slowly, or set a preset brightness. Note that the preset brightness levels are the same as what shown in status page.

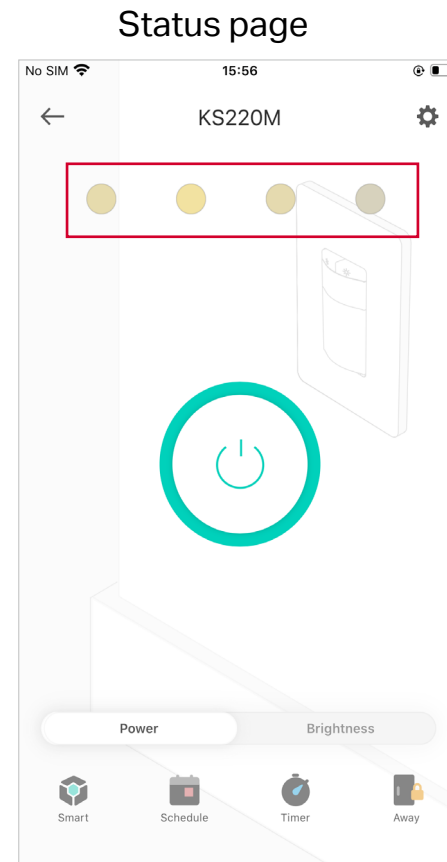
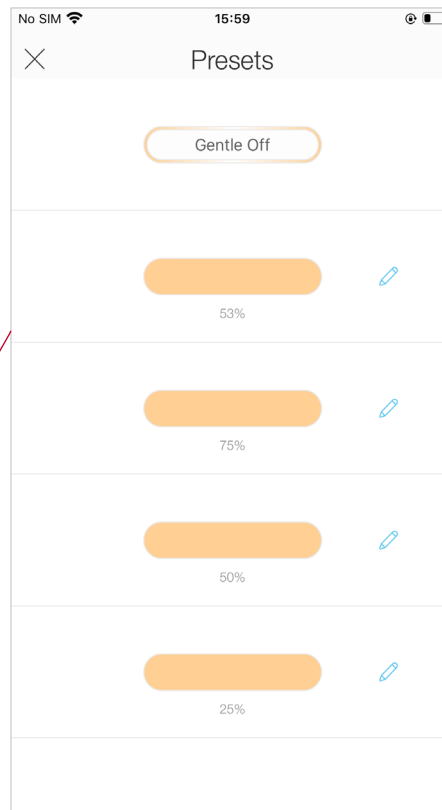
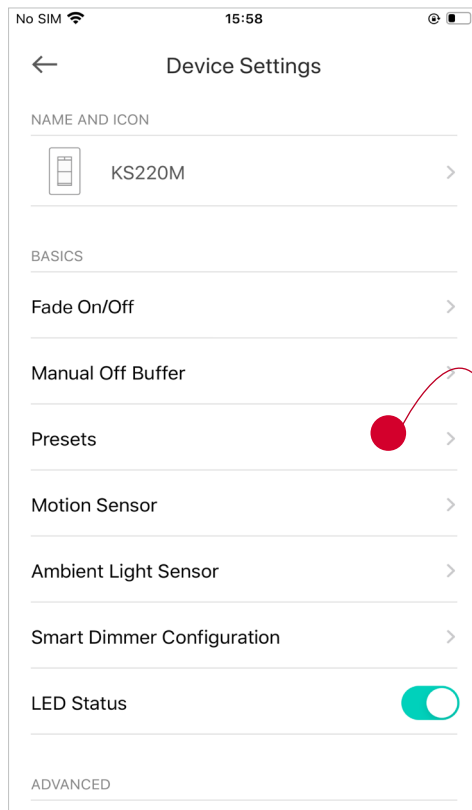

## Customize Motion Sensor Settings

**Motion Sensor** is enabled by default. If you have set Smart Control and chosen the motion trigger, your light will be triggered on when motion is detected during the time period you set. You can change the sensitivity of the motion sensor.

If **Motion Sensor** is turned off, then the motion trigger for your Smart Control cannot work.

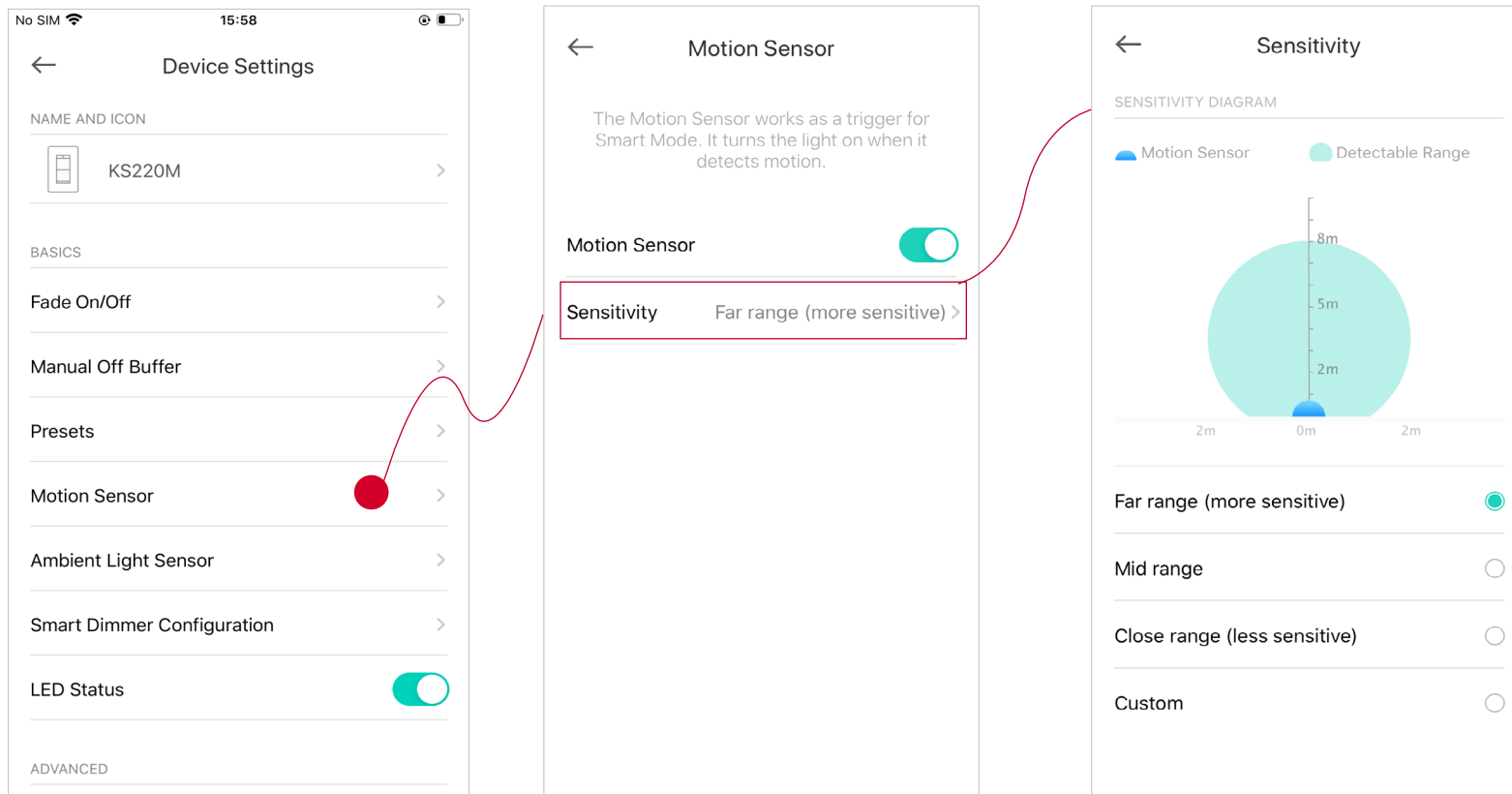



## Customize Ambient Light Sensor Settings

It is enabled by default. If you have set Smart Control and chosen the trigger [Motion Detected When It's Dark](#), your light will be triggered on when ambient setting is reached and motion is detected. Preset ambient brightness in different environment is provided and can be changed. [Current Ambiance](#) is detected by your dimmer switch, which is a reference for you to adjust the preset ambient values.

If [Ambient Light Sensor](#) is turned off, then the darkness trigger for your Smart Control cannot work, but the motion trigger still works.

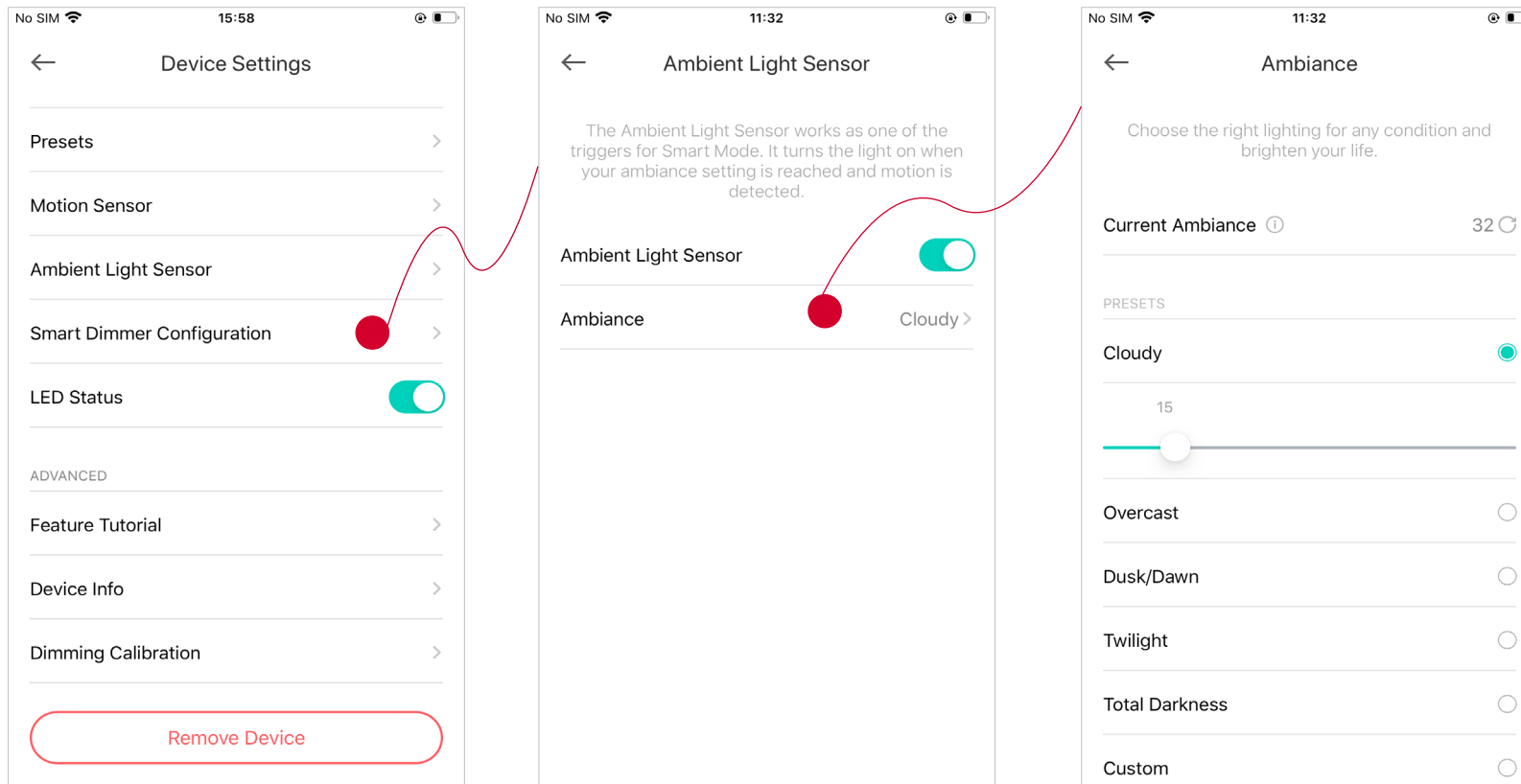

## Change Smart Dimmer Configuration Settings

Set the effects you want your light to show when you double tap or long press your dimmer switch.

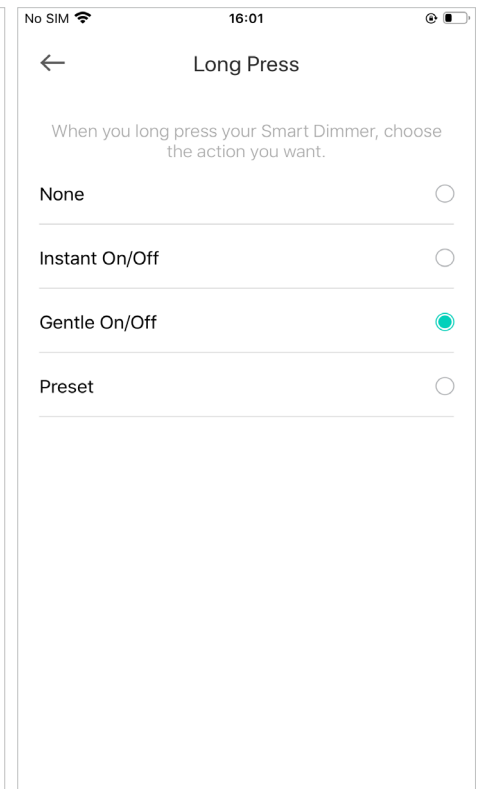
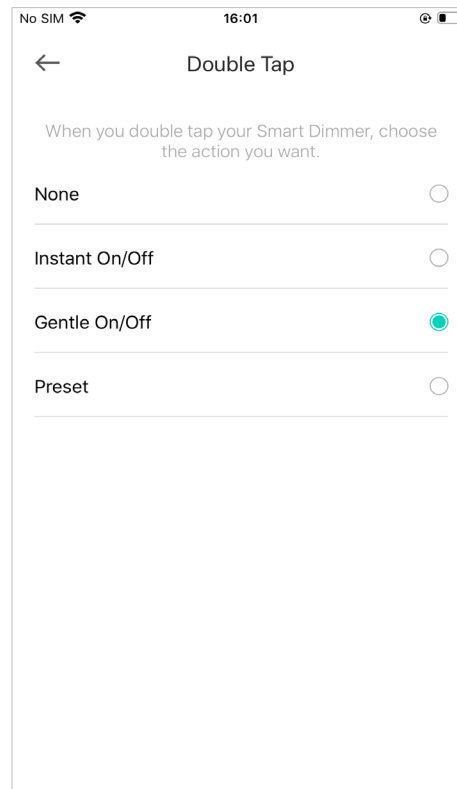
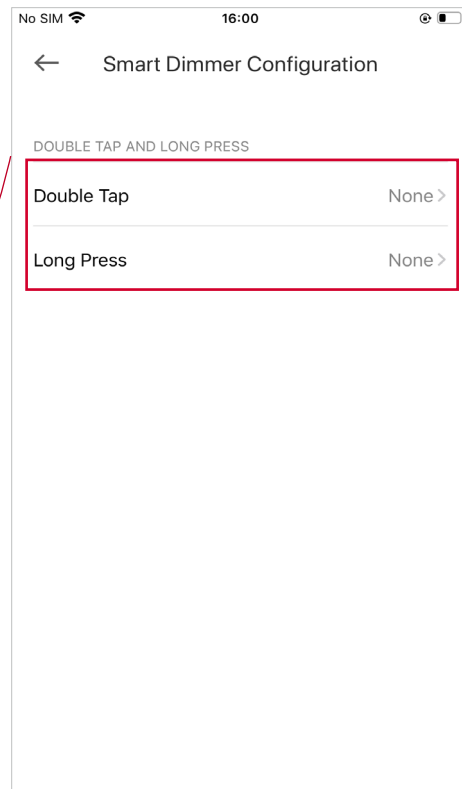
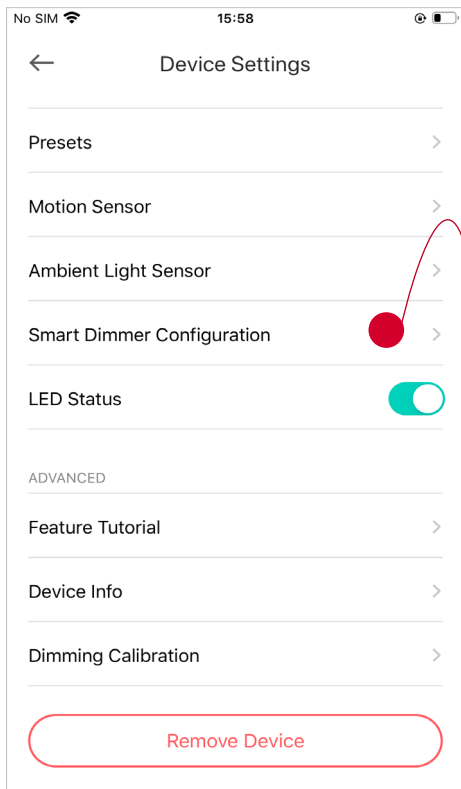

## Turn On/Off LED

When turned off, you cannot tell the status of your dimmer switch from the LED.

If you have set the dimmer switch to be off if no motion is detected for a specific time period, the LED of the dimmer switch will flash as a sign when it's about to be off. Turning off [LED Status](#) will disable that feature.

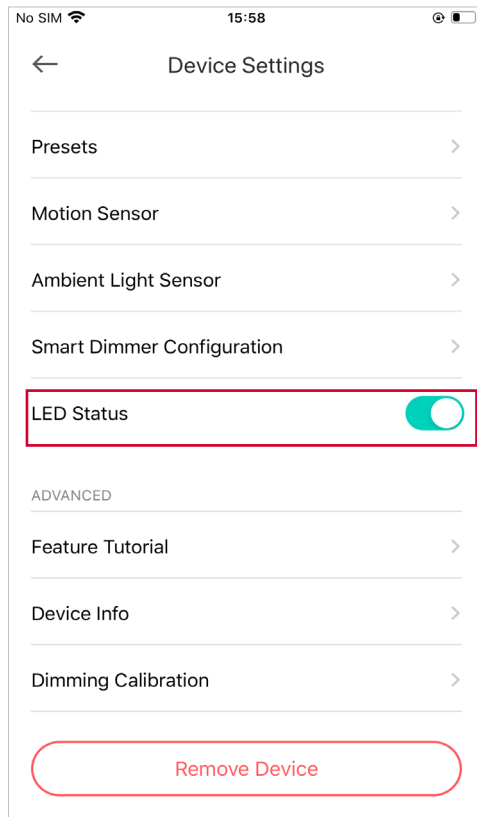

## Dimming Calibration

Calibrate your light to avoid flickering.

Test the dimming range of your dimmer switch by slowly reducing the brightness of your light until you find the minimum level of brightness.

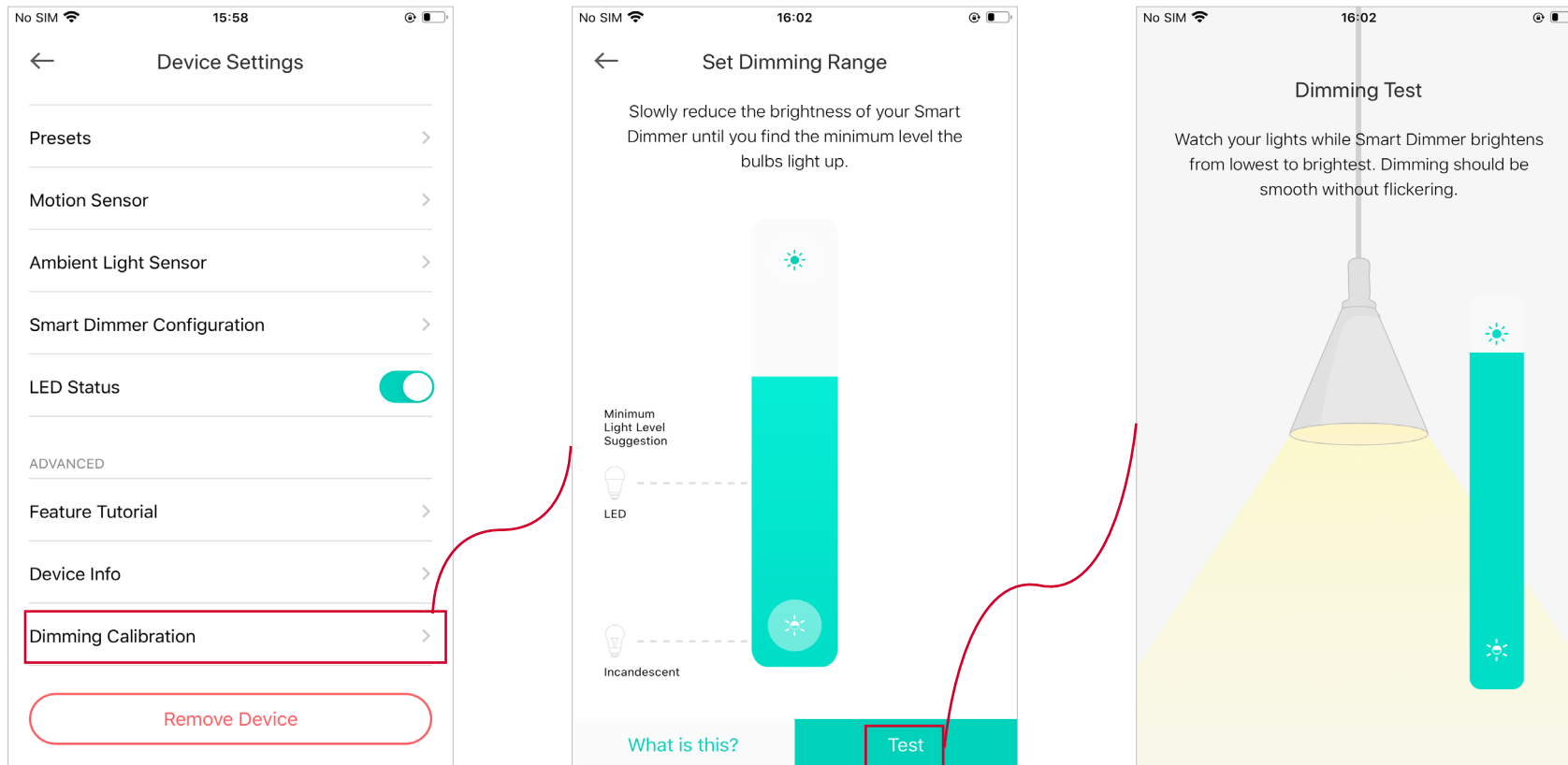

# Reset Your Smart Dimmer Switch

There are three methods to reset your Smart Dimmer Switch.

## Method 1

Swipe left any of your Smart Dimmer Switch and tap [Delete](#). Then tap [Remove Device](#). Your Smart Dimmer Switch will be removed from your Kasa account and restored to factory settings.

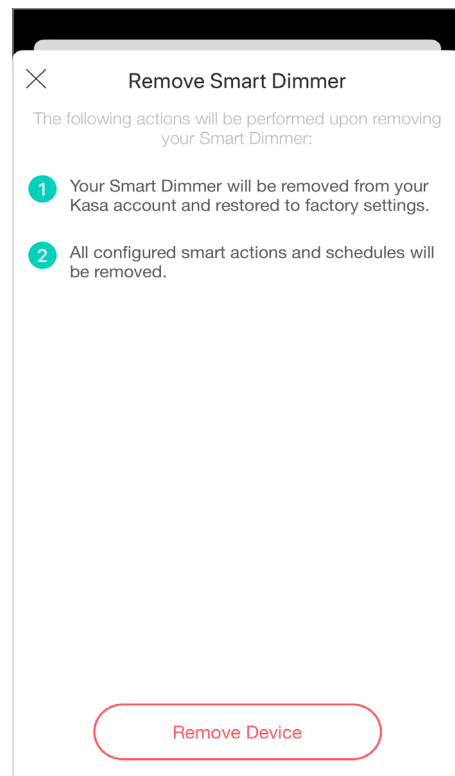
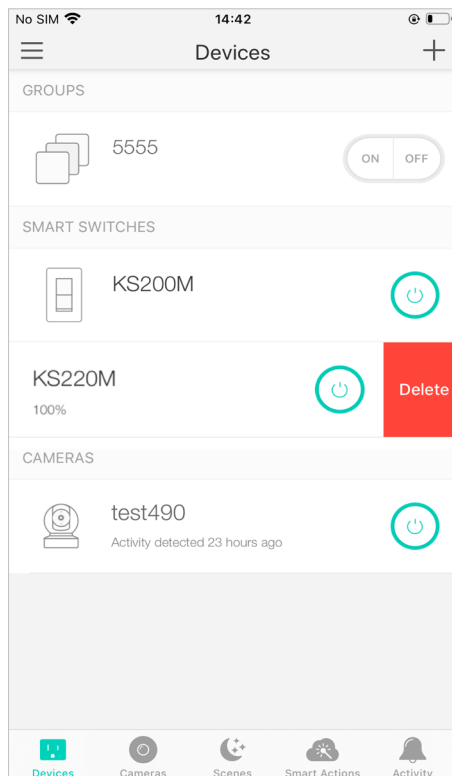

## Method 2

Tap your Smart Dimmer Switch and go to the [Devices Settings](#) page. Then tap [Remove Device](#) in the bottom. Your Smart Dimmer Switch will be removed from your Kasa account and restored to factory settings.

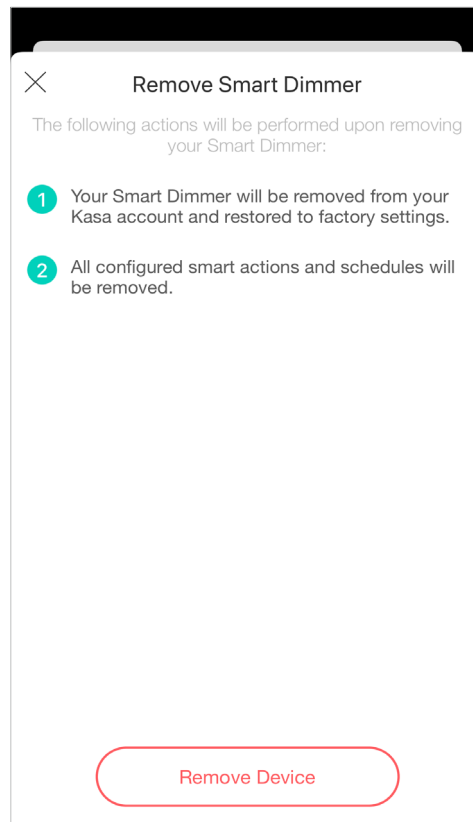
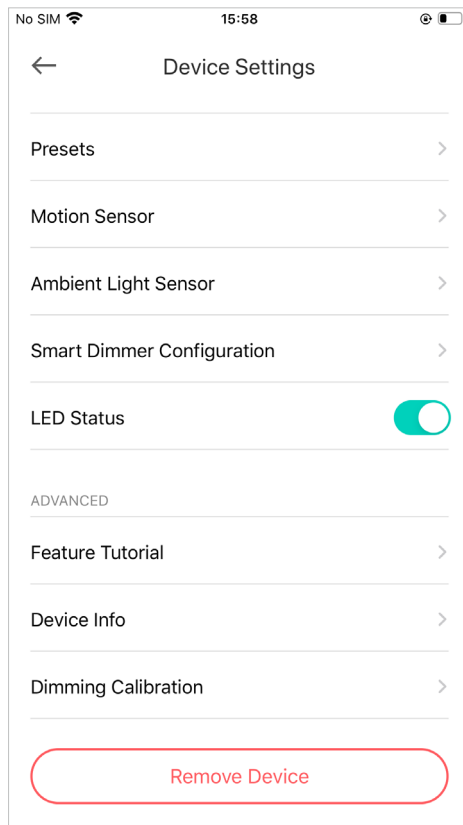

### Method 3

Press and hold the [Reset](#) button on the panel of the dimmer switch for **10s** to restore your it to factory default settings.  
Press and hold the [Reset](#) button on the panel of the dimmer switch for **5s** to reset Wi-Fi while keeping previous settings.

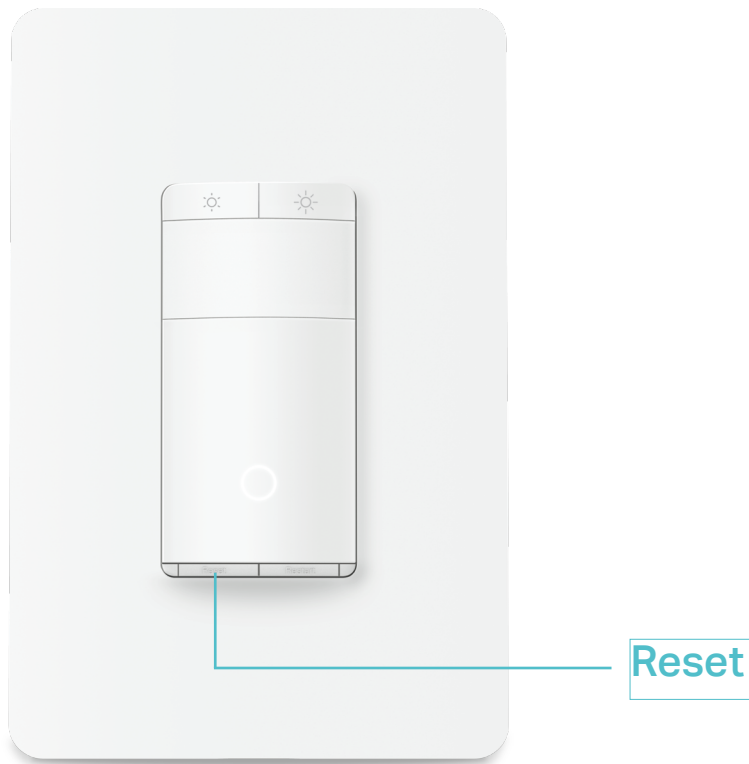

# Create Groups

With groups, you can control multiple devices simultaneously. This page allows you to add your Smart Dimmer Switch and your other Kasa smart devices to a group for unified management.

## 1. Create groups for your Smart Light Switch

1. Tap the (+) button in the Home page of the Kasa Smart app, and select [Group](#).

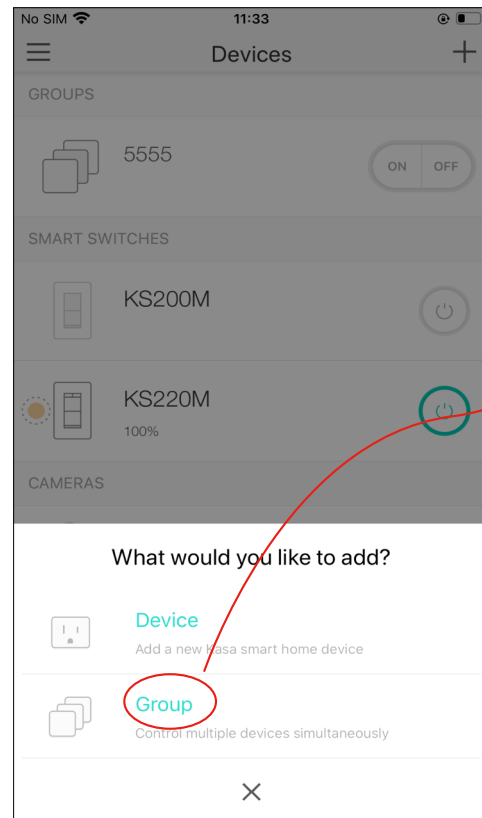

2. Select your Smart Dimmer Switch and other Kasa smart devices and tap [Save](#).

e.g. I want to group my Smart Dimmer Switch and Kasa smart switch to turn on/off simultaneously.

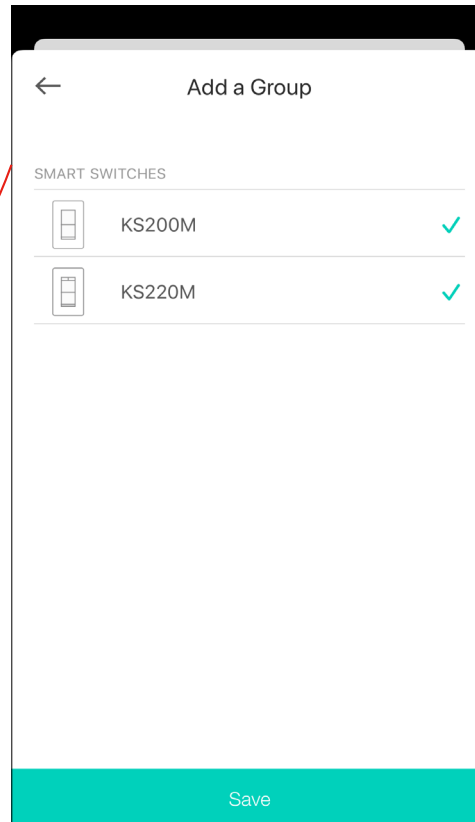

3. Name the group.

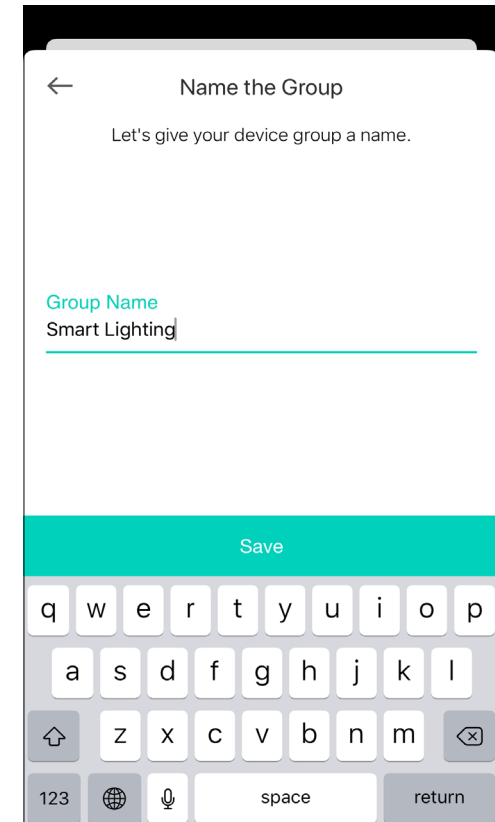



4. The created group is listed in the Home page. You can tap **ON** or **OFF** to turn on or off the devices together in the group.

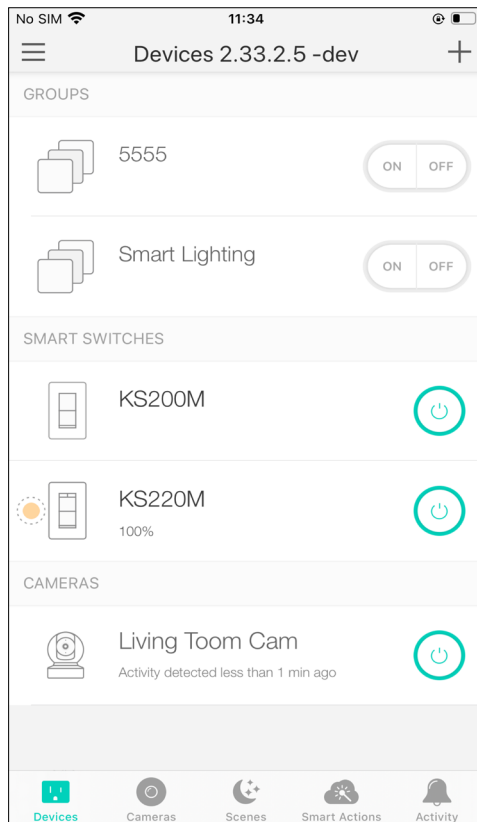

## 2. Manage the group

1. Tap the group you want to manage.

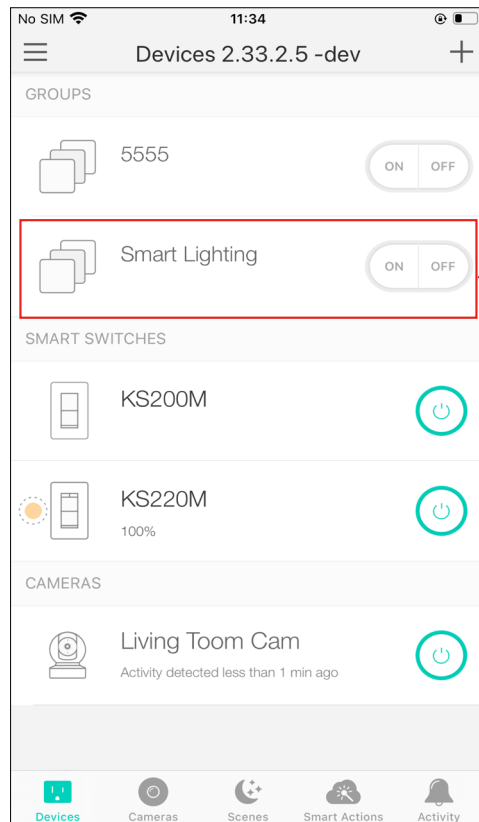

2. Turn on or off the Group in the status page.

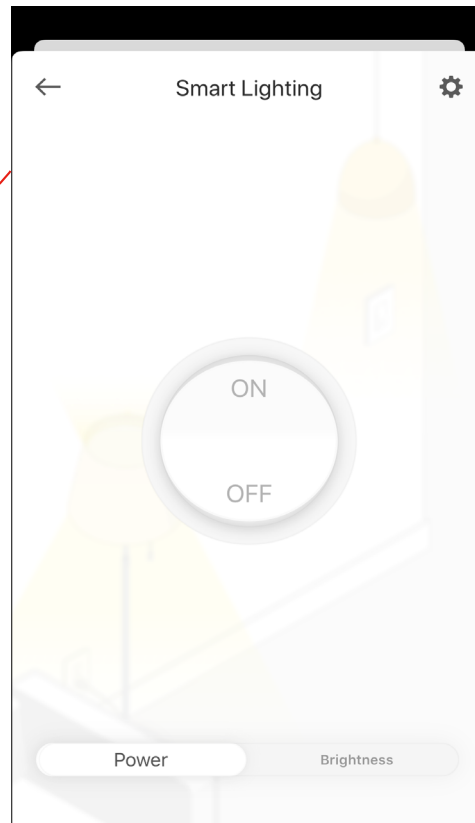

3. Tap **Brightness** to adjust the brightness of your dimmer switch.

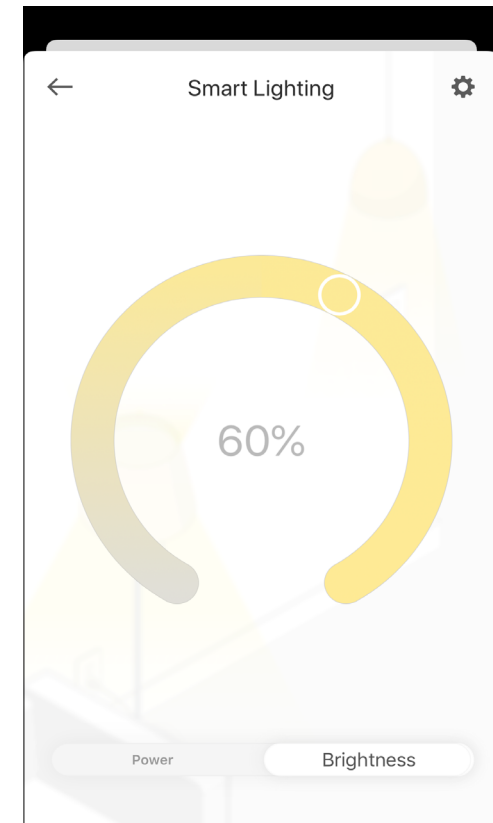

4. Tap  in the top right corner to enter the settings page. You can change the group name or devices in the group as you like.

5. Tap [Remove Group](#) if you want to remove the group from your device list. Then double confirm it. All devices in the group will remain accessible on the device list.

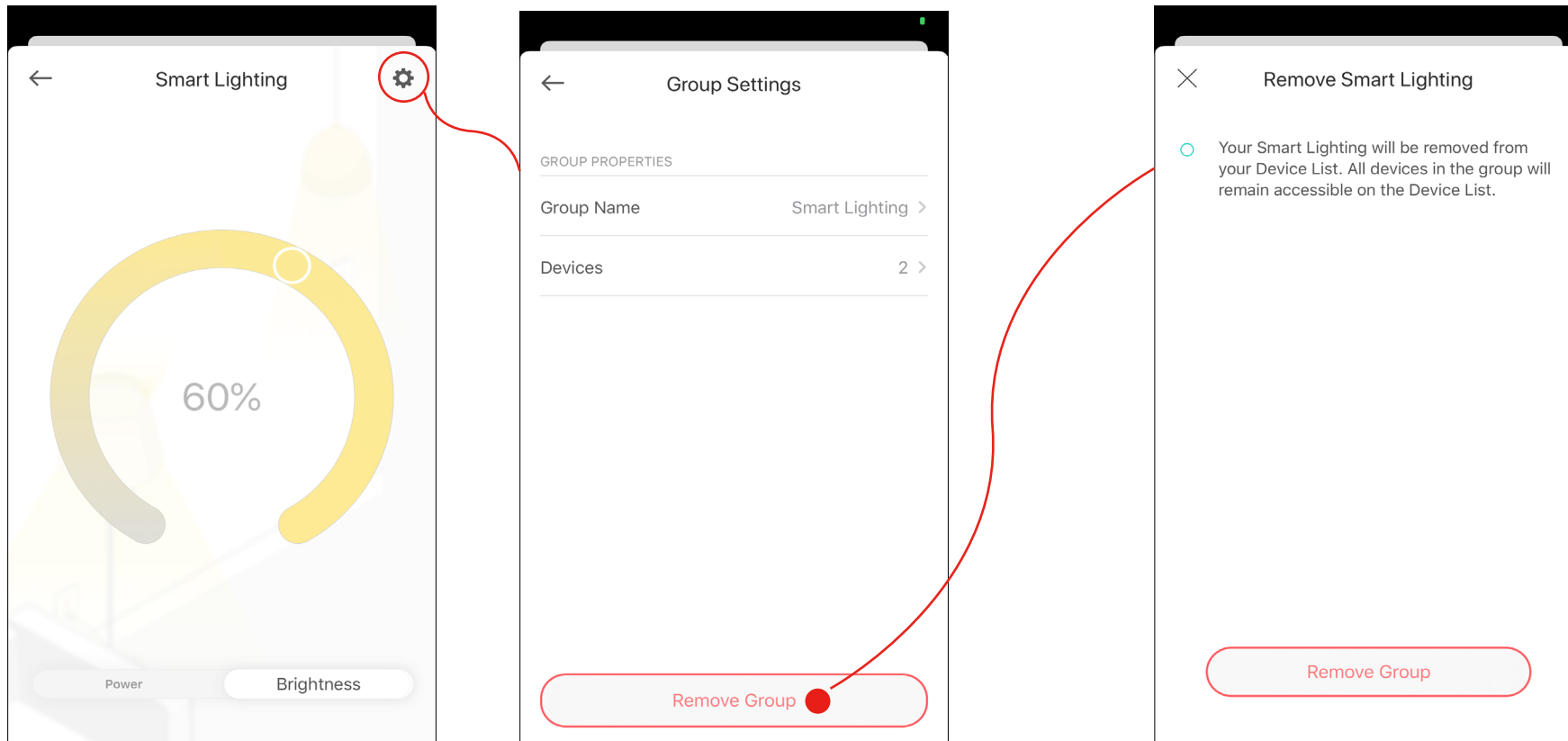

# Create Scenes

A scene is a preset group of smart devices that can be programmed, customized and activated simultaneously at the touch of a button from your smartphone or tablet, allowing you to easily set your mood, activity or fit any special occasion. To create a scene with your Smart Dimmer Switch, you need other Kasa smart devices, a smart plug for example.

1. Tap  at the bottom, then tap + at the top right corner.

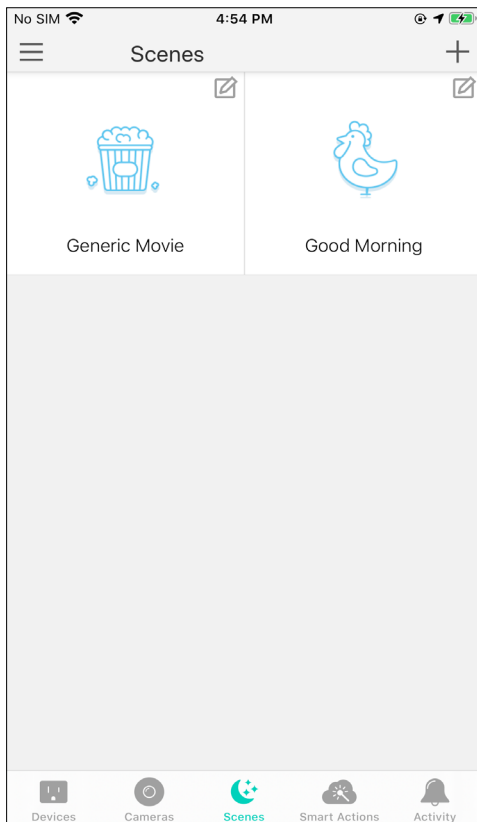

2. Select a scene or create your own scene.

**e.g.** I want to turn on the bedroom light and turn off the living room light simultaneously at night with just one tap in the Kasa Smart app .

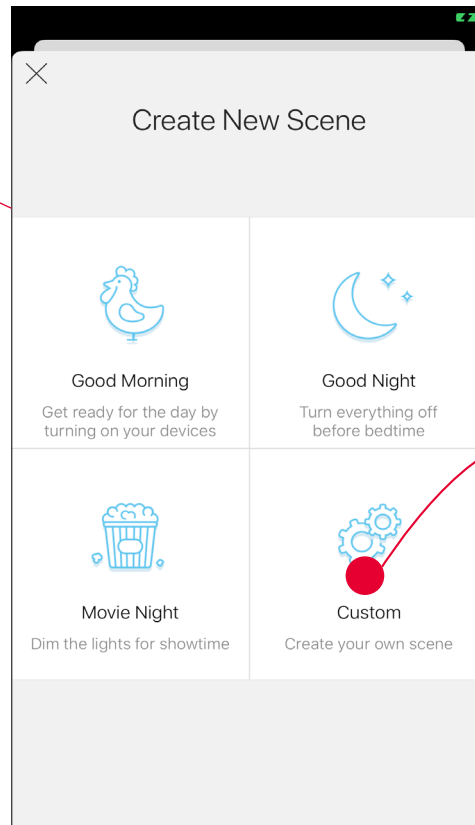

3. Select devices for the scene to work on and set their status respectively.

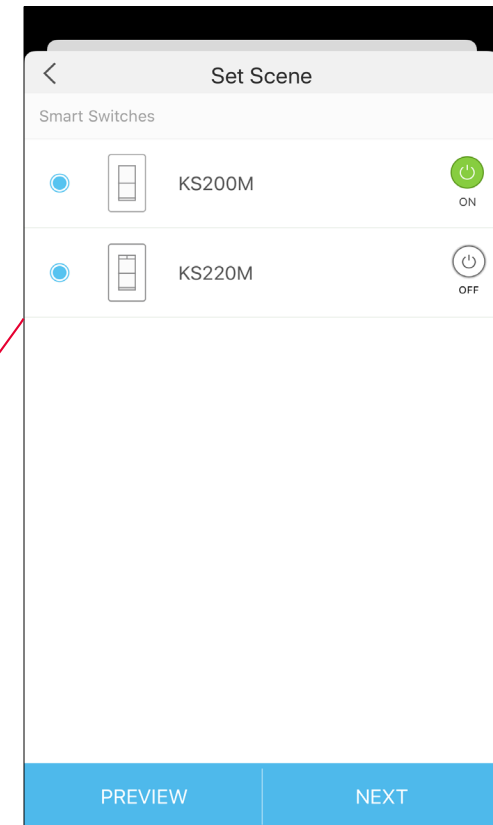

4. Pick an icon for your scene.

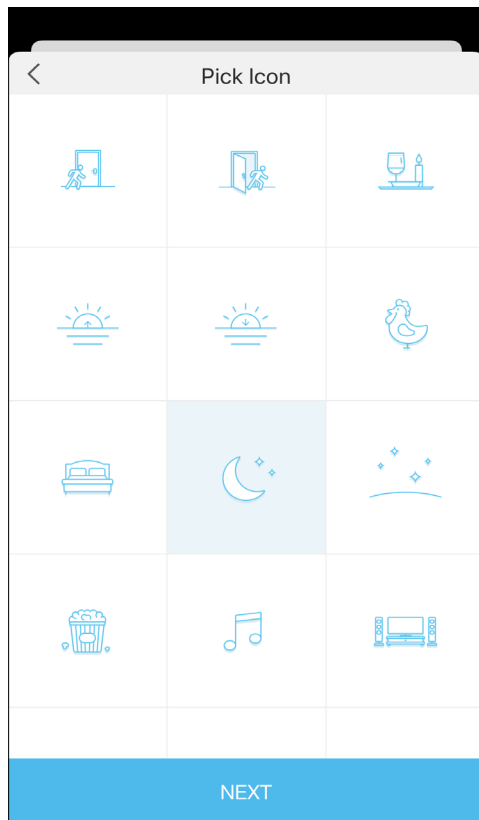

5. Name your scene.

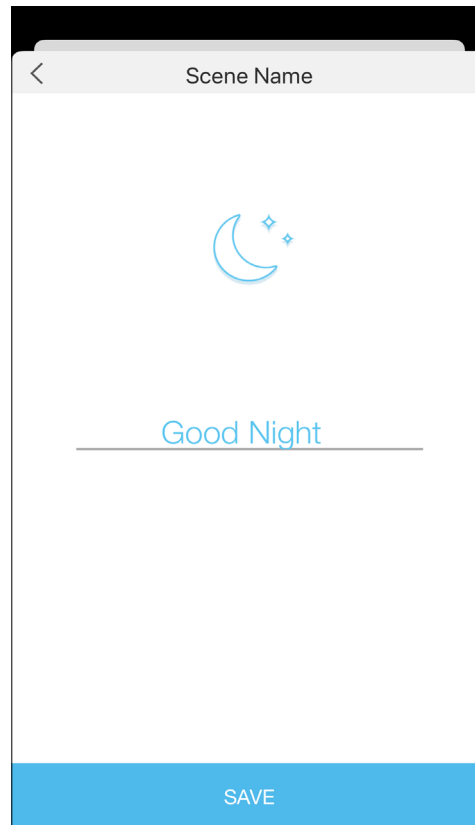

6. Your scene is created successfully. Just tap the scene to activate it.

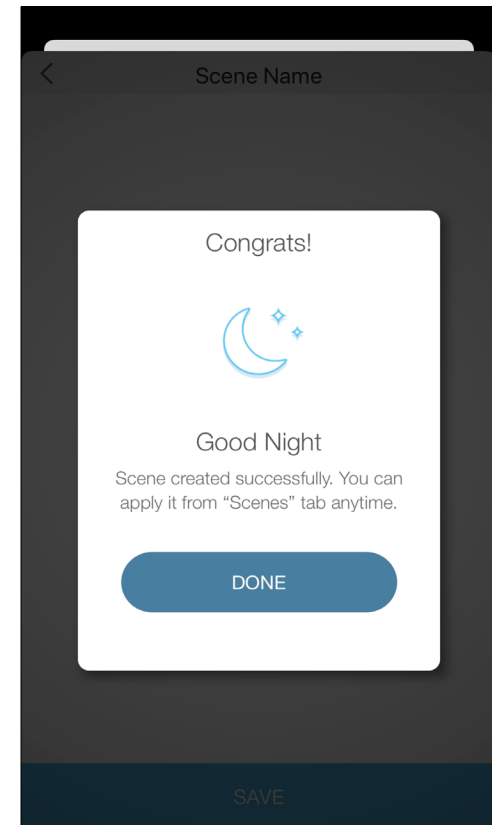

# Smart Actions

Smart Actions is a function provided that enables device interconnections and home automations. With Smart Actions, your Kasa devices can work together to create a smarter smart home. From the moment you wake up to the moment you drift asleep, Smart Actions make your home safer and more comfortable.

1. Tap  at the bottom, then tap **Add an Action.**

2. Select an automation type for your Smart Actions.

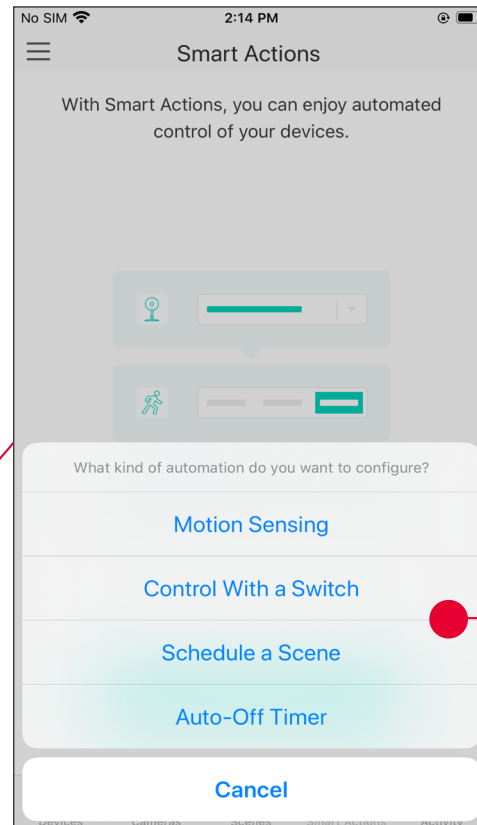
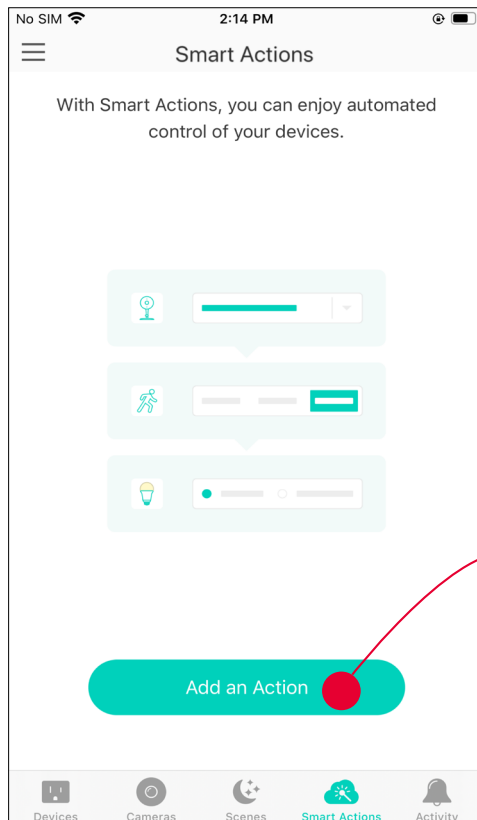

**Motion Sensing:** Take actions when a Kasa camera senses a motion.

**Control With a Switch:** Extend the Smart Switch control to other Kasa Smart devices. Turn on/off a group of devices with the Smart Switch all together.

**Schedule a Scene:** Schedule a "Scene" to be turned on automatically at the time specified.

**Auto-off Timer:** Whenever a smart device is turned on, turn it off after the designated amount of time.

## 1. Configure Motion Sensing If you already have a Kasa Camera

e.g. I want to turn the light on when my Kasa camera senses a motion.

1. Tap **Motion Sensing** then select a camera.

2. Select your Smart Dimmer Switch.

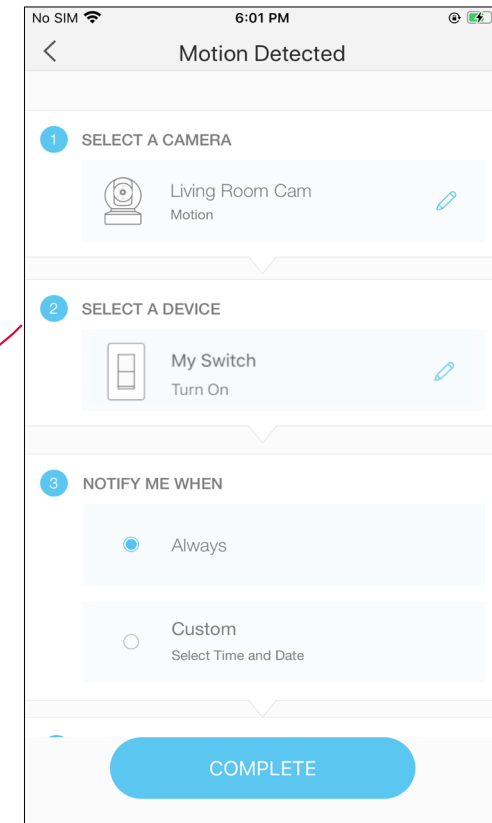
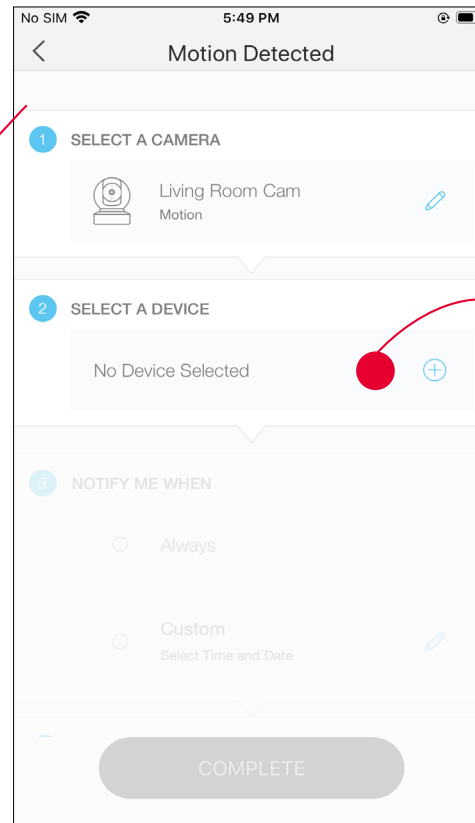
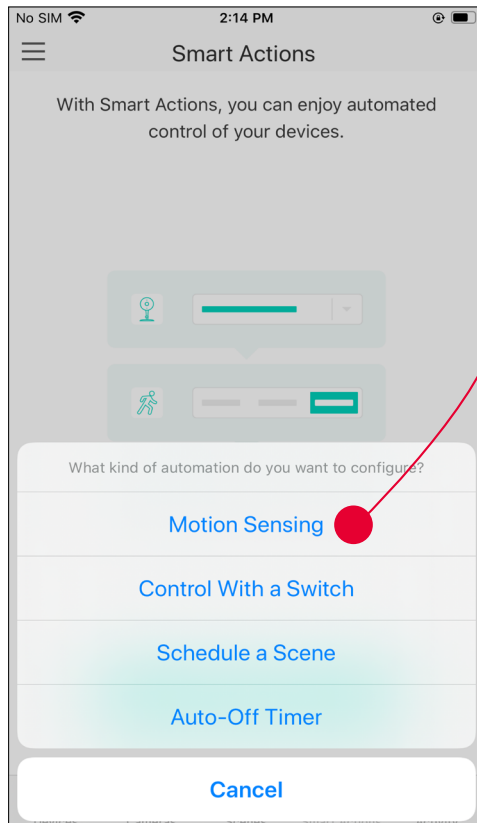

3. Set the time when you want the action to run. You can choose [Always](#) or tap [Custom](#) to choose time according to your needs.

For example: I want the motion to trigger the light on from 11:00 PM to 7:00 AM every day.

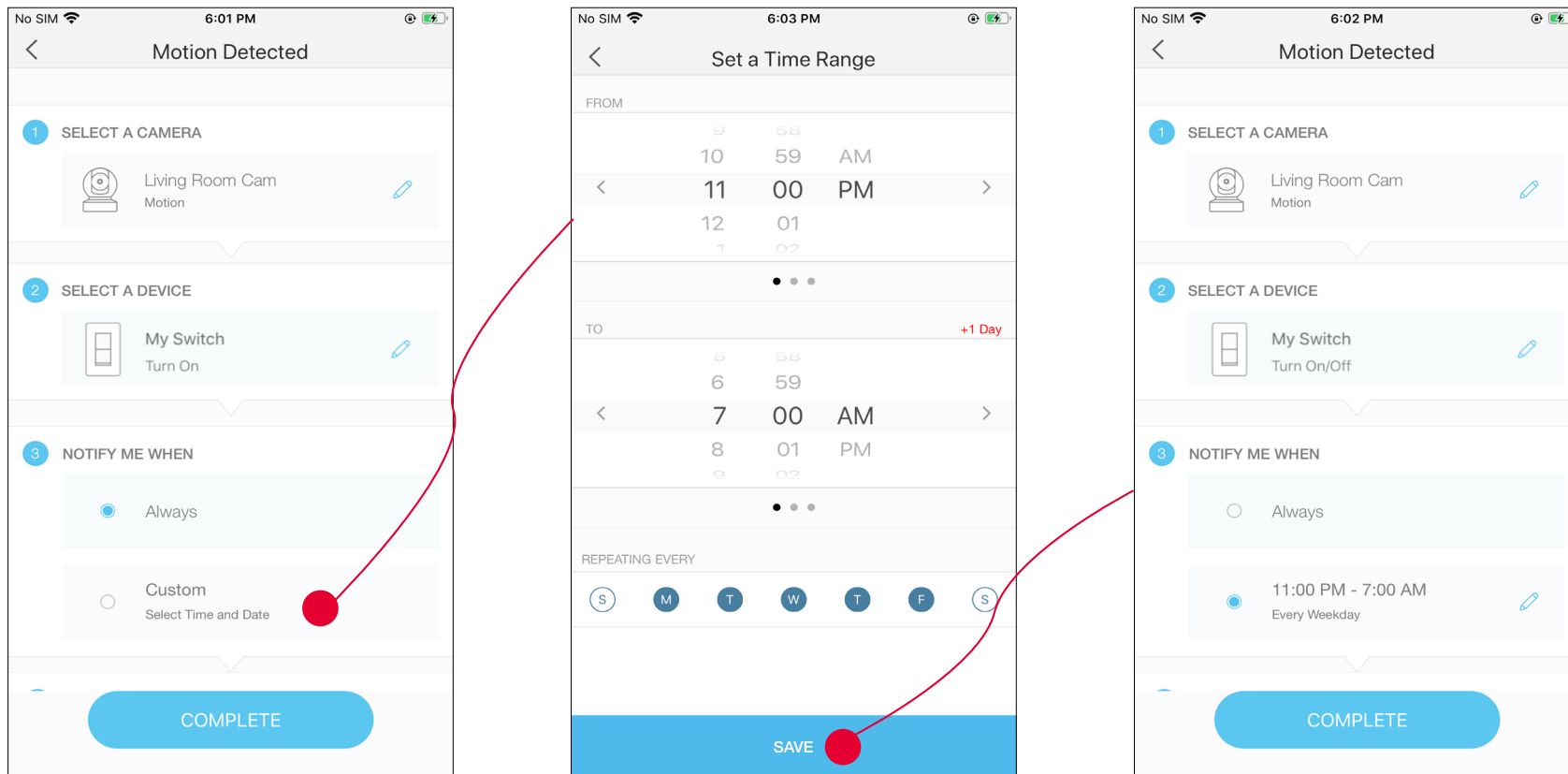



4. (Optional) Set an auto-off timer then tap **Complete**. Then your living room light will be turned off after the time you set.

5. Name your action for easy identification.

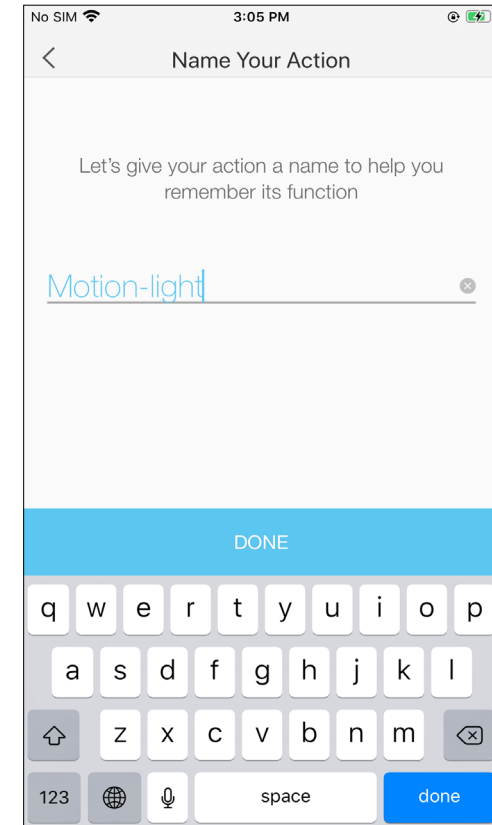
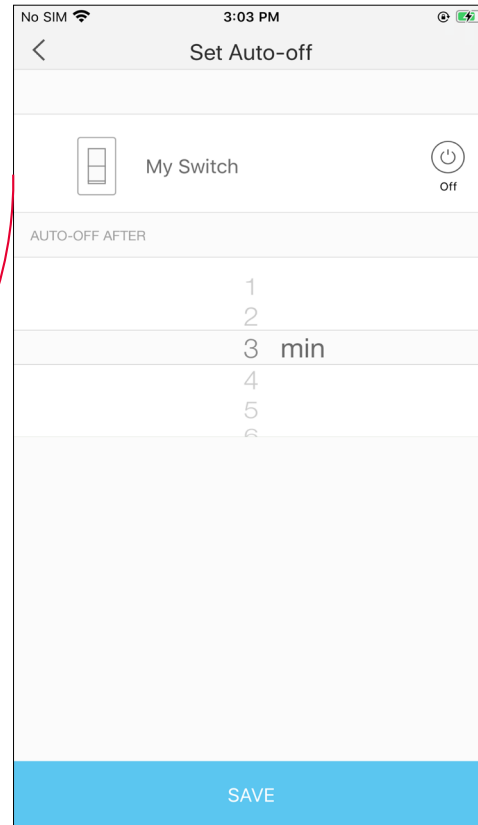
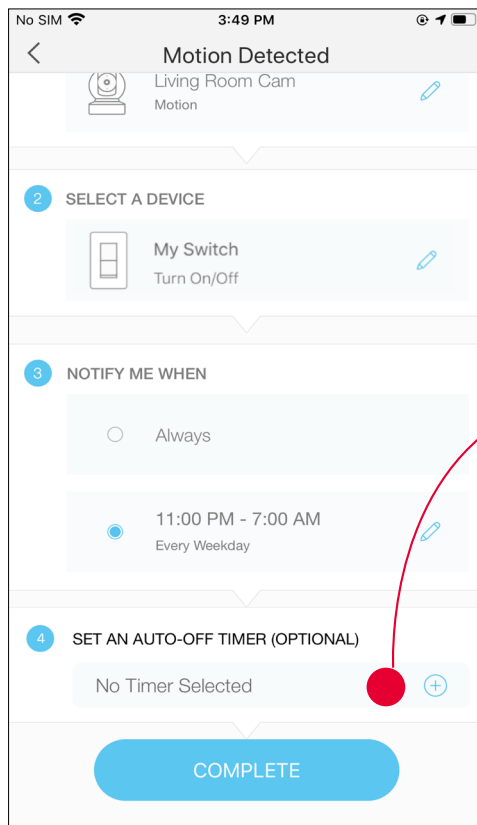

6. The Smart Action is created successfully and displayed in the Smart Actions list.

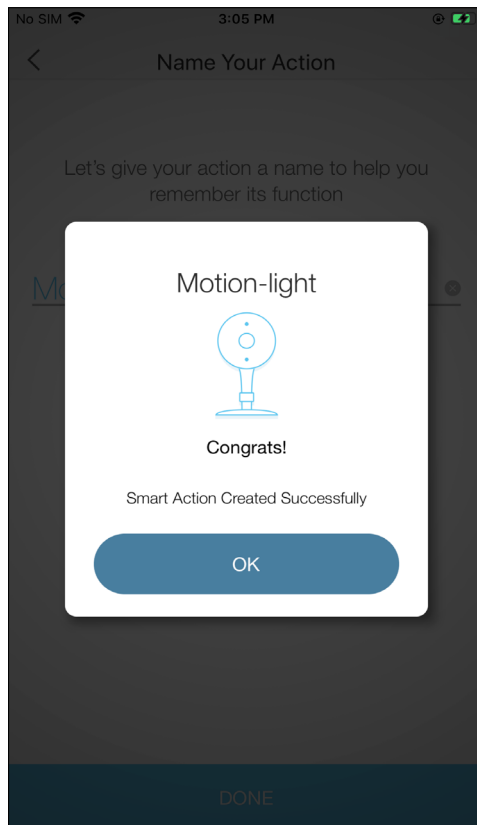

## 2. Configure Control With a Switch If you already have other Kasa smart devices

e.g. When I turn on my dimmer switch, I also want to turn on the living room light, which is plugged in my Kasa smart plug; when I turn off my dimmer switch, I also want the living room light off .

1. Tap [Control With a Switch](#).

2. Add your dimmer switch. Then select your Kasa smart plug which your living room light is plugged in.

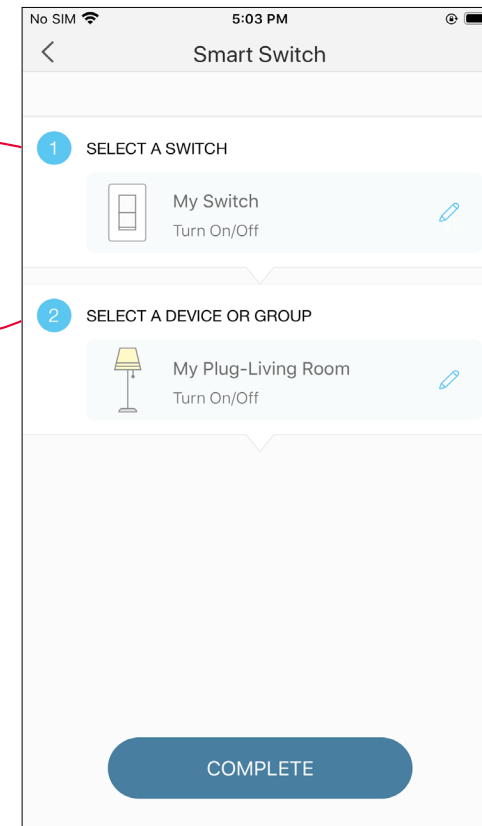
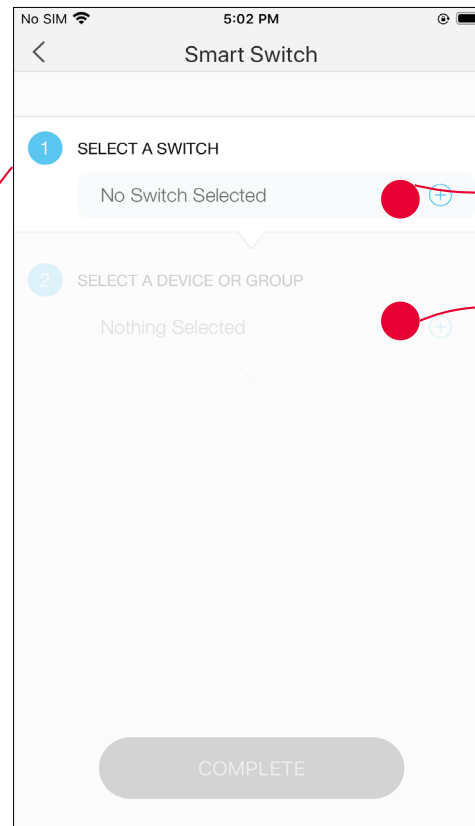
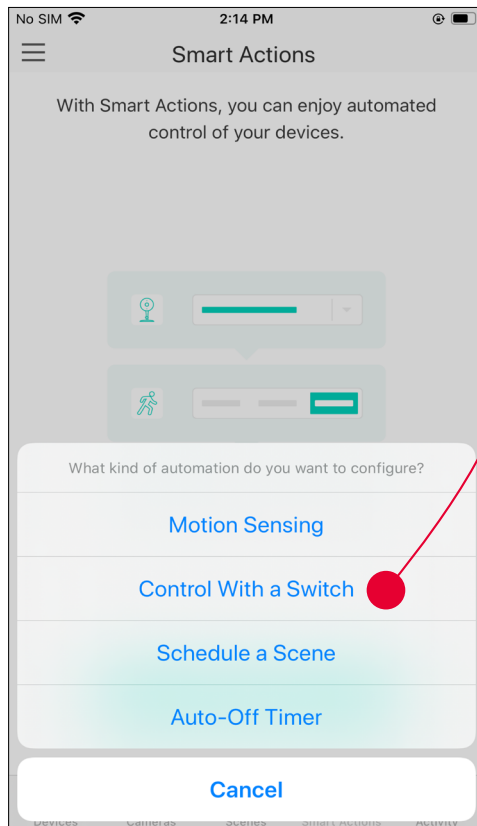

3. Name your action for easy identification.

4. Now Your Smart Action is created successfully and is displayed in the smart actions list.

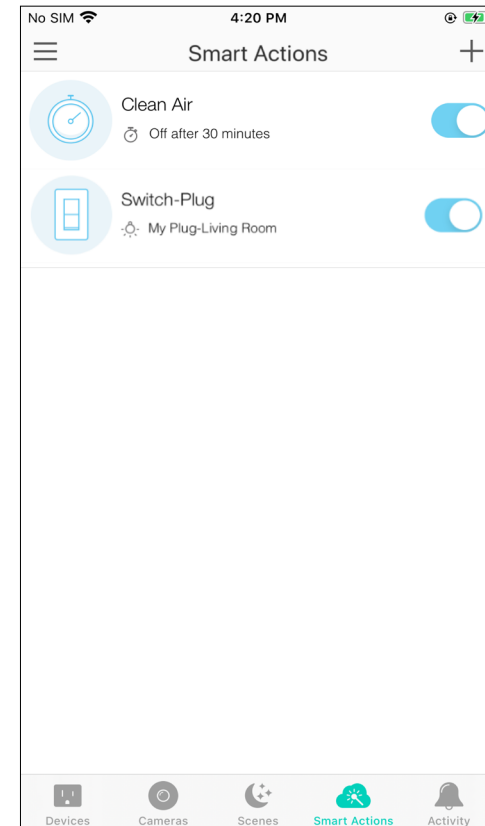
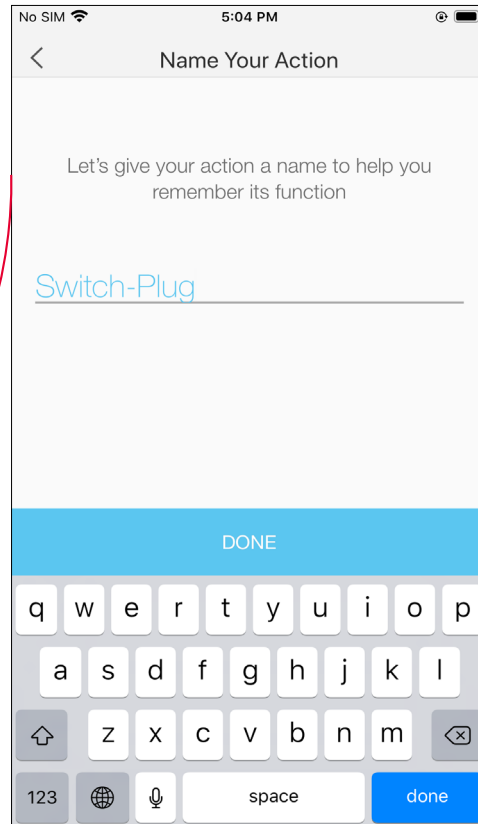
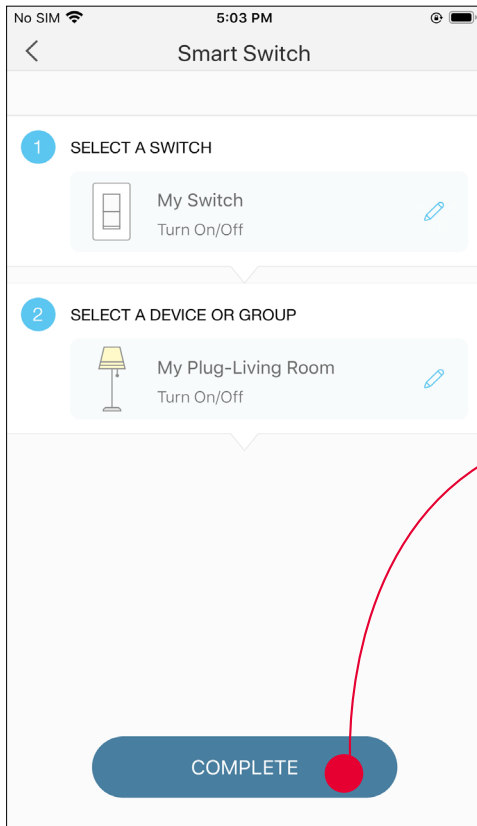

### 3. Configure Schedule a Scene

e.g. I want to turn on the scene I have created automatically at scheduled time.

1. Tap [Schedule a Scene](#) then select a scene you have created.

For example: I want to turn on my [Good Morning](#) scene, which turns on my switch and my music speaker (plugged in to a Kasa smart plug) with just a tap, at 7: 20 AM every weekday.

2. Set the time and frequency at which you want your scene to be activated.

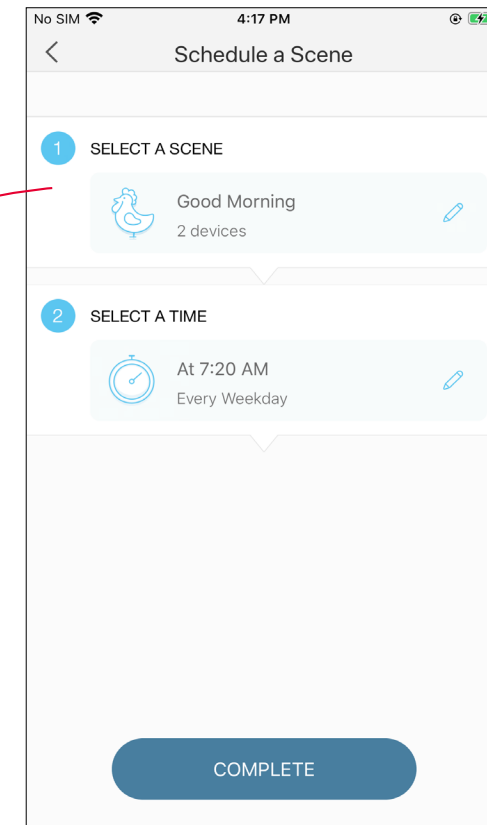
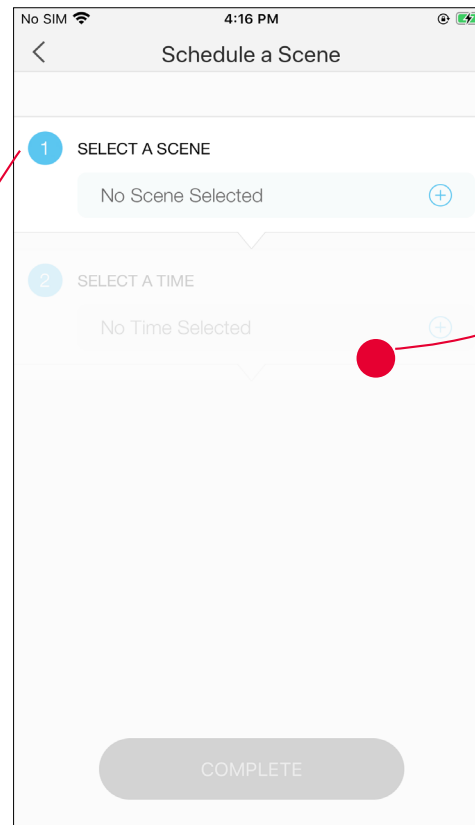
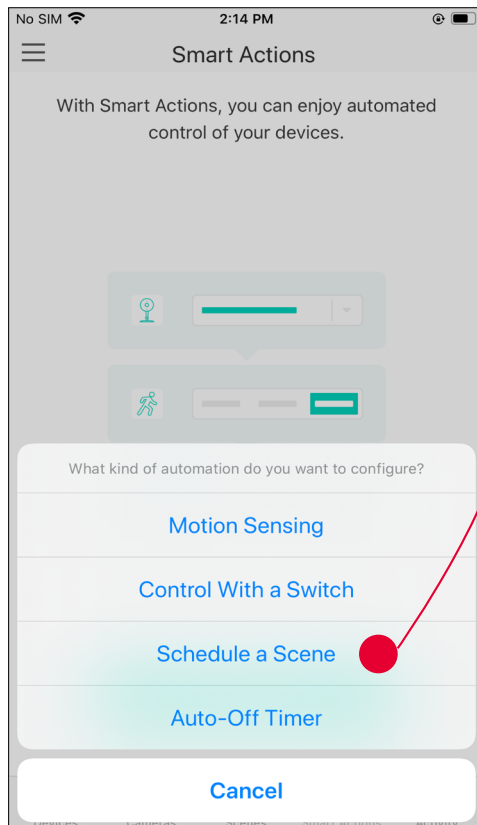

3. Name your action for easy identification.

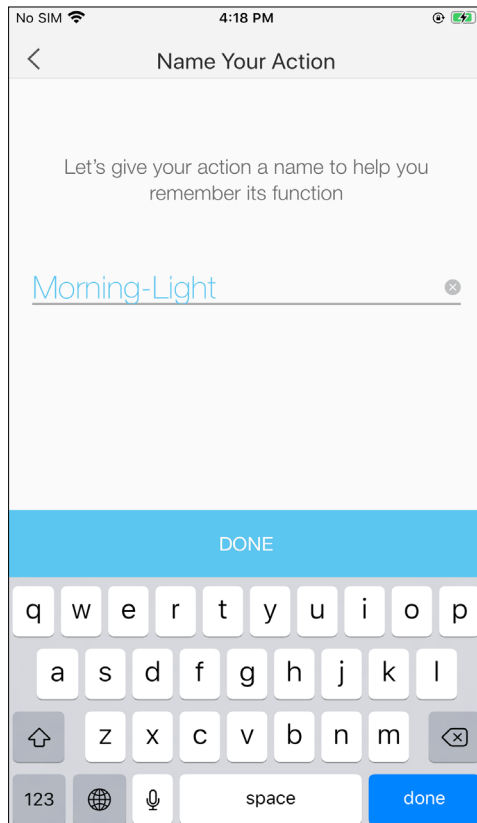

4. The Smart Action is created successfully and displayed in the Smart Actions list.

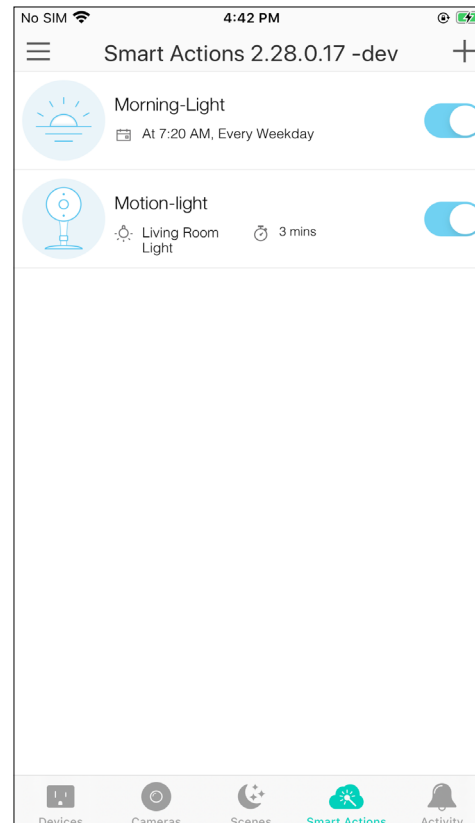

## 4. Configure Auto-Off Timer

e.g. I want to turn off my Kasa Smart Dimmer Switch after 30 minutes whenever it turns on.

1. Tap [Auto-Off Timer](#) then select your dimmer switch.

2. Set the time after which your dimmer switch will be off.

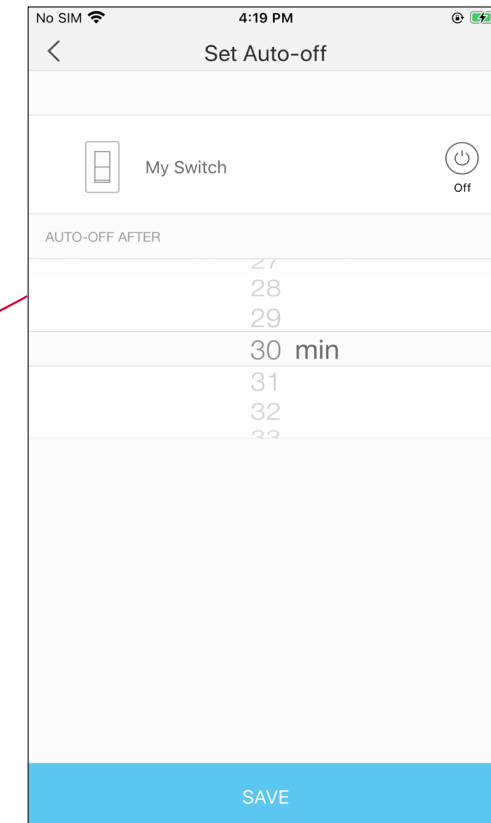
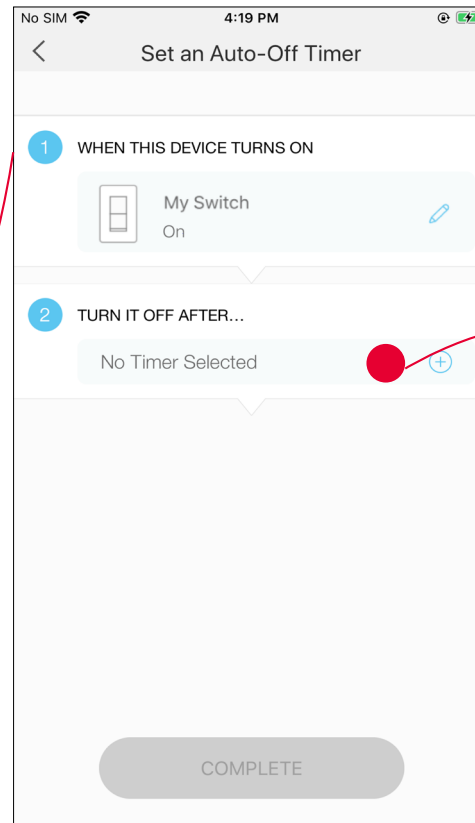
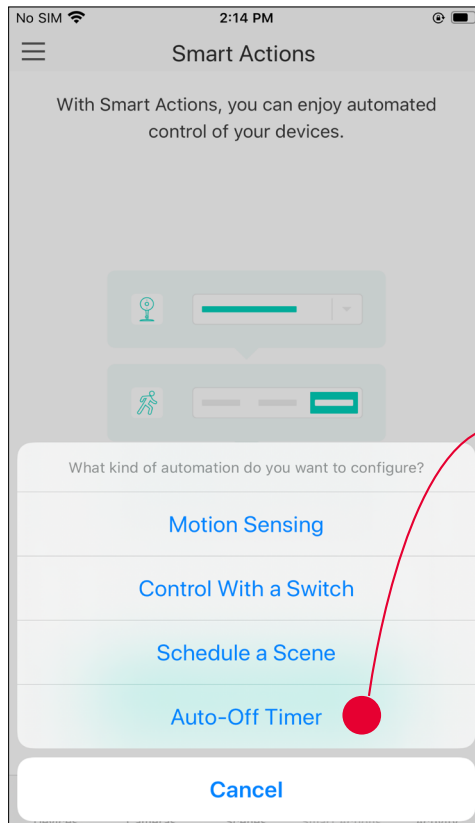

3. Name your action for easy identification.

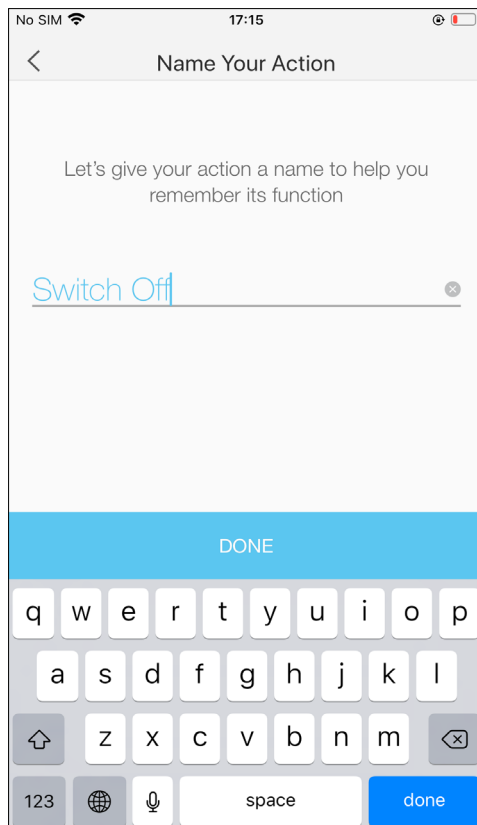

4. The Smart Action is created successfully.

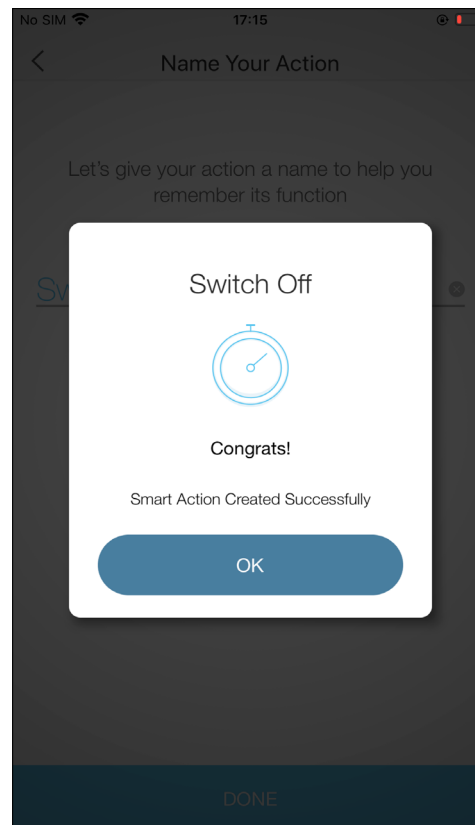



# Discover Kasa

Use the Kasa Smart app to pair your Smart Wi-Fi Power Strip with Amazon Alexa or Google Home Assistant, and enjoy a full hands-free experience. Kasa helps manage the rest of your smart home too, working with Samsung SmartThings to trigger changes when you arrive home or leave for the day.

Launch the **Kasa Smart** app. Go to the sidebar and tap **Works with Kasa**. You can choose **Amazon Alexa** / **Google Assistant** / **IFTTT** / **Samsung SmartThings** for detailed instructions.

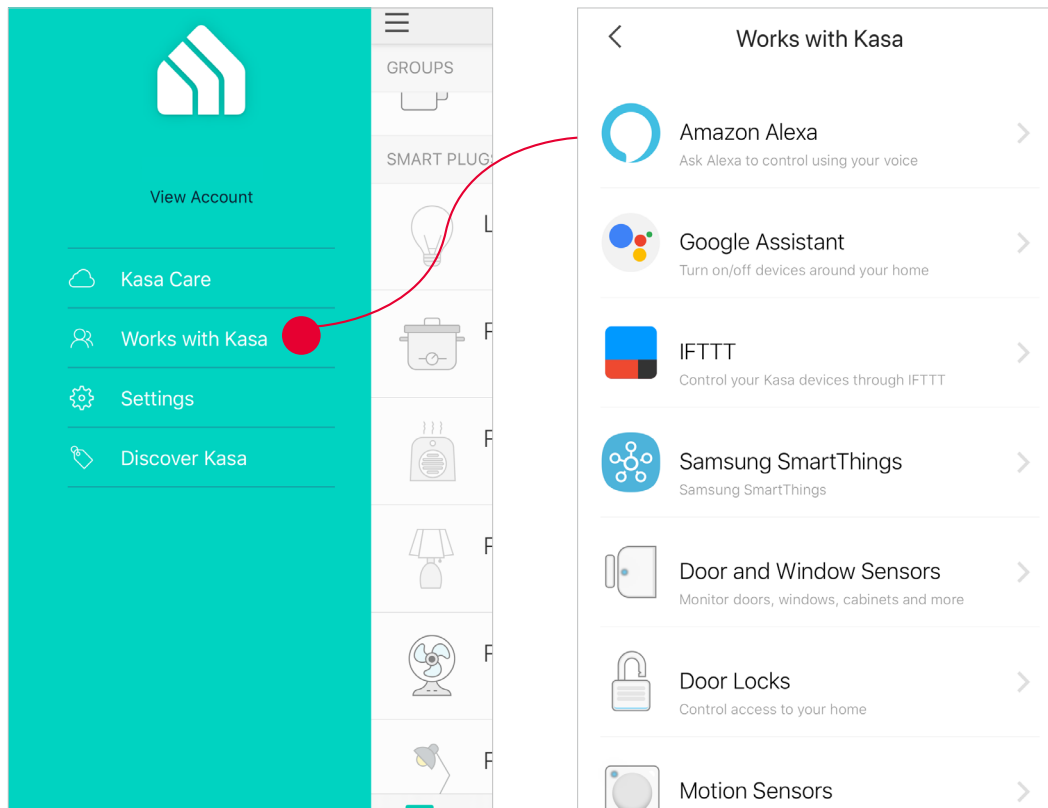

# Authentication

## FCC compliance information statement



**Product Name:** Kasa Smart Wi-Fi Dimmer Switch, Motion Activated

**Model Number:** KS220M / ES20M

**Responsible party:**

**TP-Link USA Corporation**

**Address:** 10 Mauchly, Irvine, CA 92618

**Website:** <http://www.tp-link.com/us/>

**Tel:** +1 626 333 0234

**Fax:** +1 909 527 6804

**E-mail:** [sales.usa@tp-link.com](mailto:sales.usa@tp-link.com)

This equipment has been tested and found to comply with the limits for a Class B digital device, pursuant to part 15 of the FCC Rules. These limits are designed to provide reasonable protection against harmful interference in a residential installation. This equipment generates, uses and can radiate radio frequency energy and, if not installed and used in accordance with the instructions, may cause harmful interference to radio communications. However, there is no guarantee that interference will not occur in a particular installation. If this equipment does cause harmful interference to radio or television reception, which can be determined by turning the equipment off and on, the user is encouraged to try to correct the interference by one or more of the following measures:

- Increase the separation between the equipment and receiver.
- Connect the equipment into an outlet on a circuit different from that to which the receiver is connected.
- Consult the dealer or an experienced radio/ TV technician for help.

This device complies with part 15 of the FCC Rules. Operation is subject to the following two conditions:

1. This device may not cause harmful interference.

2. This device must accept any interference received, including interference that may cause undesired operation.

Any changes or modifications not expressly approved by the party responsible for compliance could void the user's authority to operate the equipment.

Note: The manufacturer is not responsible for any radio or TV interference caused by unauthorized modifications to this equipment. Such modifications could void the user's authority to operate the equipment.

### **FCC RF Radiation Exposure Statement**

This equipment complies with FCC RF radiation exposure limits set forth for an uncontrolled environment. This device and its antenna must not be co-located or operating in conjunction with any other antenna or transmitter.

"To comply with FCC RF exposure compliance requirements, this grant is applicable to only Mobile Configurations. The antennas used for this transmitter must be installed to provide a separation distance of at least 20 cm from all persons and must not be co-located or operating in conjunction with any other antenna or transmitter."

We, **TP-Link USA Corporation**, has determined that the equipment shown as above has been shown to comply with the applicable technical standards, FCC part 15. There is no unauthorized change is made in the equipment and the equipment is properly maintained and operated.

Issue Date: 2021.07.13

## Canadian Compliance Statement

This device contains licence-exempt transmitter(s)/receiver(s) that comply with Innovation, Science and Economic Development Canada's licence-exempt RSS(s). Operation is subject to the following two conditions:

- (1) This device may not cause interference.
- (2) This device must accept any interference, including interference that may cause undesired operation of the device.

L'émetteur/récepteur exempt de licence contenu dans le présent appareil est conforme aux CNR d'Innovation, Sciences et Développement économique Canada applicables aux appareils radio exempts de licence. L'exploitation est autorisée aux deux conditions suivantes :

- 1) L'appareil ne doit pas produire de brouillage;
- 2) L'appareil doit accepter tout brouillage radioélectrique subi, même si le brouillage est susceptible d'en compromettre le fonctionnement.

## Radiation Exposure Statement:

This equipment complies with IC radiation exposure limits set forth for an uncontrolled environment. This equipment should be installed and operated with minimum distance 20cm between the radiator & your body.

## Déclaration d'exposition aux radiations:

Cet équipement est conforme aux limites d'exposition aux rayonnements IC établies pour un environnement non contrôlé. Cet équipement doit être installé et utilisé avec un minimum de 20 cm de distance entre la source de rayonnement et votre corps.

## Industry Canada Statement

CAN ICES-3 (B)/NMB-3(B)

## NCC & BSMI Notice

注意!

取得審驗證明之低功率射頻器材，非經核准，公司、商號或使用者均不得擅自變更頻率、加大功率或變更原設計之特性及功能。

低功率射頻器材之使用不得影響飛航安全及干擾合法通信；經發現有干擾現象時，應立即停用，並改善至無干擾時方得繼續使用。

前述合法通信，指依電信管理法規定作業之無線電通信。

低功率射頻器材須忍受合法通信或工業、科學及醫療用電波輻射性電機設備之干擾。

## 安全諮詢及注意事項

- 請使用原裝電源供應器或只能按照本產品注明的電源類型使用本產品。
- 清潔本產品之前請先拔掉電源線。請勿使用液體、噴霧清潔劑或濕布進行清潔。
- 注意防潮，請勿將水或其他液體潑灑到本產品上。
- 插槽與開口供通風使用，以確保本產品的操作可靠並防止過熱，請勿堵塞或覆蓋開口。
- 請勿將本產品置放於靠近熱源的地方。除非有正常的通風，否則不可放在密閉位置中。
- 不要私自拆開機殼或自行維修，如產品有故障請與原廠或代理商聯繫。

## 限用物質含有情況標示聲明書

設備名稱： Equipment name Kasa Smart Wi-Fi Dimmer Switch, Motion Activated		型號（型式）： Type designation (Type) KS220M / ES20M				
單元 Unit	限用物質及其化學符號 Restricted substances and its chemical symbols					
	鉛 Lead (Pb)	汞 Mercury (Hg)	鎘 Cadmium (Cd)	六價鉻 Hexavalent chromium (Cr+6)	多溴聯苯 Polybrominated biphenyls (PBB)	多溴二苯醚 Polybrominated diphenyl ethers (PBDE)
PCB	○	○	○	○	○	○
外殼	○	○	○	○	○	○
電源供應板	—	○	○	○	○	○
其他及其配件	—	○	○	○	○	○
<p>備考 1. “超出 0.1 wt %” 及 “超出 0.01 wt %” 係指限用物質之百分比含量超出百分比含量基準值            Note 1: “Exceeding 0.1 wt %” and “exceeding 0.01 wt %” indicate that the percentage content of the restricted substance exceeds the reference percentage value of presence condition.</p> <p>備考 2. “○” 係指該項限用物質之百分比含量未超出百分比含量基準值。            Note 2: “○” indicates that the percentage content of the restricted substance does not exceed the percentage of reference value of presence.</p> <p>備考 3. “—” 係指該項限用物質為排除項目。            Note 3: The “—” indicates that the restricted substance corresponds to the exemption.</p>						

## Safety Information

- Keep the device away from water, fire, humidity or hot environments.
- Do not attempt to disassemble, repair, or modify the device.
- Do not use the device where wireless devices are not allowed.
- The socket-outlet shall be installed near the equipment and shall be easily accessible.
- Operating temperature: 0°C ~40°C (32 °F ~104 °F )
- Storage Temperature: -40°C~60°C (-40 °F ~140 °F )



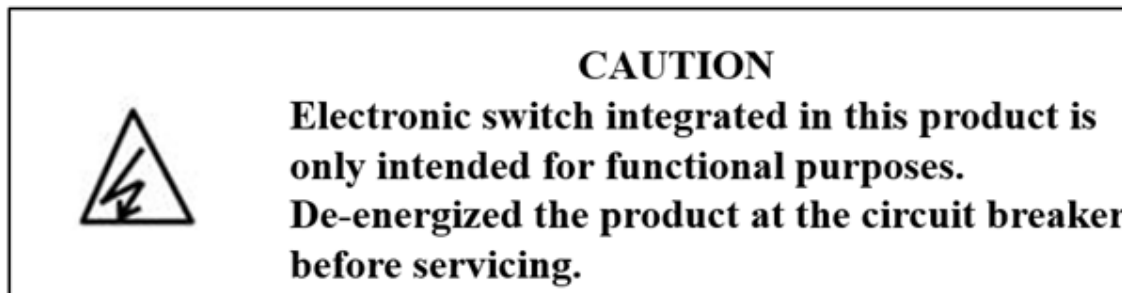

Follow all national and local safety regulations and practices. If you are uncertain or uncomfortable when performing the installation, consult a qualified electrician.

- Install only in a suitable UL or equivalent Listed outlet box.(suitable dimensions: W > 2.83in./72mm, H > 1.81in./46mm, D > 3.15in./80mm).
- CAUTION – Risk of electric Shock – More than one disconnect switch may be required to de-energize the equipment before servicing. A circuit breaker which disconnects the Live and Neutral conductor simultaneously is suitable. Ensure power is off at the circuit breaker before removing or installing any wall switch.
- Do not install the Smart Switch with wet hands or when standing on wet or damp surfaces.
- The Smart Switch must be installed and used in accordance with the National Electric Code (NEC) or your local electrical code. If you are unfamiliar with these codes and requirements, or are uncomfortable performing the installation, consult a qualified electrician.



Please read and follow the above safety information when operating the device. We cannot guarantee that no accidents or damage will occur due to improper use of the device. Please use this product with care and operate at your own risk.

## Explanation of the symbols on the product label

Symbol	Explanation
	Indoor use only
	AC voltage
	DC voltage
 	<p>RECYCLING</p> <p>This product bears the selective sorting symbol for Waste electrical and electronic equipment (WEEE). This means that this product must be handled pursuant to European directive 2012/19/EU in order to be recycled or dismantled to minimize its impact on the environment.</p> <p>User has the choice to give his product to a competent recycling organization or to the retailer when he buys a new electrical or electronic equipment.</p>