



# User Guide

Kasa Spot Pan Tilt, 24/7 Recording  
KC410S

# Contents

About This Guide .....	1	Smart Actions - Motion Sensing.....	31
Introduction .....	2	Discover Kasa.....	36
Appearance .....	3		
Insert a microSD Card.....	4		
Set Up Your Camera.....	5		
Main Device Controls .....	7		
Pan/Tilt.....	8		
Add ViewPoints.....	9		
Set Schedules .....	10		
Set 24/7 Recording .....	14		
Manage Device Settings .....	16		
Reset Your Camera .....	29		

# About This Guide

This guide provides a brief introduction to the Kasa Spot Pan Tilt and the Kasa Smart app, as well as regulatory information.

Features available in Kasa Smart may vary by model and software version. Kasa Smart availability may also vary by region or ISP. All images, steps, and descriptions in this guide are only examples and may not reflect your actual Kasa Smart experience.

## Conventions

In this guide, the following convention is used:

Convention	Description
Teal	Key information appears in teal, including management page text such as menus, items, buttons and so on.
<u>Underline</u>	Hyperlinks are in teal and underlined. You can click to redirect to a website.

## More Info

- Specifications can be found on the product page at <https://www.tp-link.com>.
- Our Technical Support and troubleshooting information can be found at <https://www.tp-link.com/support/>.
- A TP-Link Community is provided for you to discuss our products at <https://community.tp-link.com>.
- Frequently Asked Questions (FAQs) can be found at <https://www.tp-link.com/support/faq/>.

# Introduction

With the Kasa Spot Pan Tilt connected to your home network, you can get the full picture of any space in your apartment, dorm or home. With a 360° horizontal view and 113° vertical view, the Pan Tilt has everything covered. With Motion Tracking and Patrol Mode, track activity from beginning to end and set multiple distinct viewpoints for your camera to monitor at set intervals.

- **Crystal Clear Video** – Sharp and clear 4MP Full HD provides high-quality video right in the palm of your hand.
- **Pan and Tilt** – Swipe up, down, left and right on your phone to rotate and set the camera's point of view.
- **Motion Tracking** – When motion activity is detected, Kasa Spot Pan Tilt tracks and follows the subject to keep it within the camera's field of view.
- **Cloud Storage Plans** – Upgrade your Kasa Care subscription plan and enjoy video recordings for up to 30 days.
- **Patrol Mode** – Set 4 distinct viewpoints and program your pan tilt camera to keep an eye on each region at intervals of your choosing.
- **Night Vision** – Even in the dark, the camera has Night Vision up to 30 feet. Never miss a thing at night and still get the same high-quality video you're used to.
- **Instant Activity Alerts** – No need to check your Kasa Spot Pan Tilt throughout the day. Get automatic alerts when it detects motion. Take quick action when you see your pet on the couch, a roommate walking through your room, or an intruder enter your front door.
- **Two-Way Audio** - Use crisp two-way audio to communicate with nosy roommates, family or even mischievous pets.
- **Activity Zones** - Control what alerts you receive by creating up to 16 custom activity zones, at no charge, around areas that are important to you.
- **24/7 Recording** - Support continuous video recording with a SD card inserted to your Kasa Spot Pan Tilt.



# Appearance

Kasa Spot Pan Tilt has a system LED that changes color according to its status, a lens, microphone, speaker, micro USB port, a SD card slot and a RESET button. Refer below for details.

## System LED

- **Solid amber:**  
Rebooting
- **Alternating amber and green:**  
Ready for setup
- **Flashing red:**  
Connecting to Wi-Fi
- **Flashing green:**  
Connected to Wi-Fi
- **Solid green:**  
Bound to Cloud
- **Flashing amber:**  
Resetting to SoftAP/Factory mode

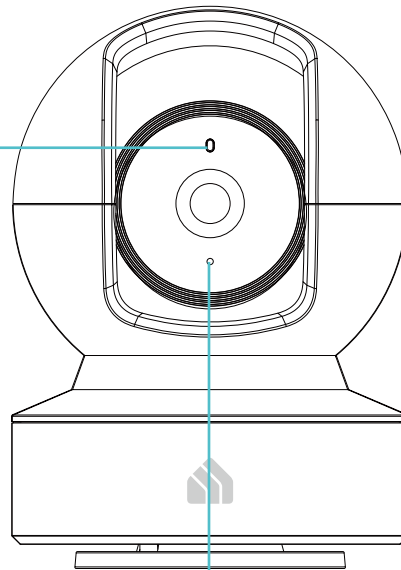

## Microphone

Built-in microphone.  
Note: Do NOT insert objects into the hole.

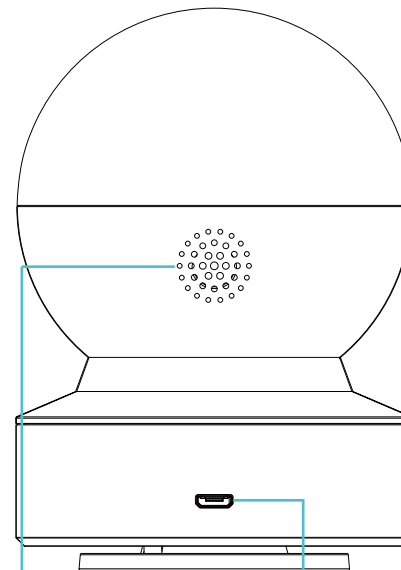

## Speaker

The sound comes out of the camera.

## Micro USB Port

Connect the power cord provided.

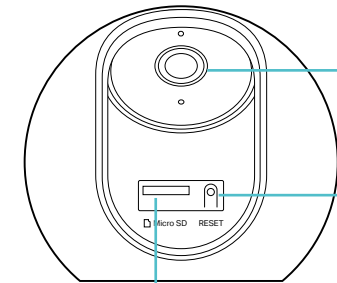

## Lens

## microSD Slot

Insert a microSD card for recording.

## RESET Button

Tilt your camera lens up to find the RESET button.

- **Press and hold for 3s to 15s:**  
Reset Wi-Fi connection
- **Press and hold for over 15s:**  
Reset to Factory mode

# Insert a microSD Card

Kasa provides options for your video recording. You can subscribe to a Kasa Care Plan to store 30-day video clips to the cloud for added backup and more beneficial functions.

Or you can save the footage continuously on a microSD card\* and play back with your Kasa Smart app. The camera will overwrite the oldest files when the microSD card memory is full. See the instructions below to insert a microSD card to your Kasa Spot.

\*Micro SD card not included.

1. Roll up the lens of your camera and find the SD card slot.
2. Holding the card in the correct orientation, carefully insert the SD card into the slot. Push in the SD card until you hear a clicking sound.

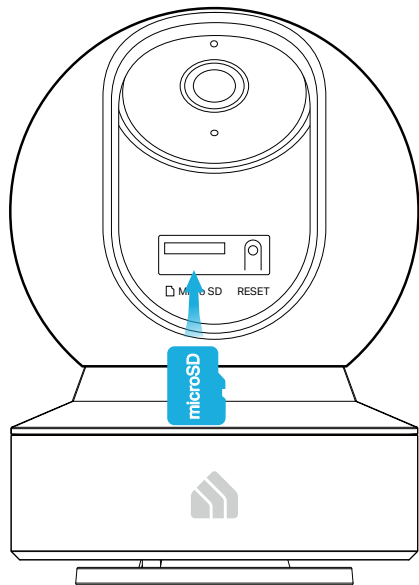

# Set Up Your Camera

Follow the steps below to get started with your new camera.

## Step 1. Download Kasa

Get the [Kasa Smart](#) app from the App Store or Google Play, or by scanning the QR code below.



## Step 2. Log In

Open the app, and log in with your TP-Link ID. If you don't have an account, create one first.

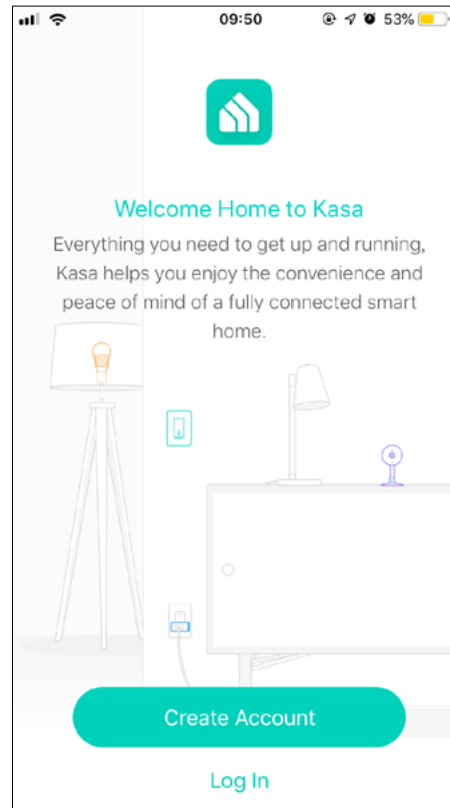

## Step 3. Start Setup

Tap the ⊕ button in the Kasa app and select [Cameras > Kasa Spot Pan Tilt](#).

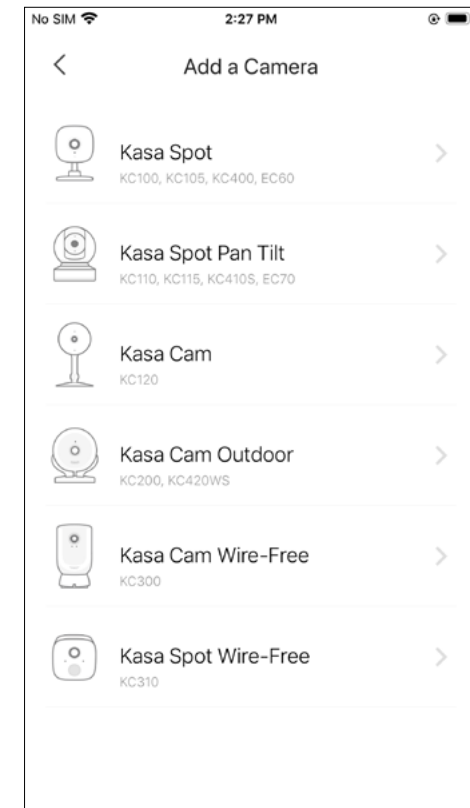

## Step 4. Configure Camera

Follow app instructions to configure your camera and add it to your home network.



## Step 5. Place Camera

Place your camera on a flat surface, or install it on a wall or ceiling with the provided indicator label and mounting screws.

- For soft surface: Directly screw the screws in.
- For cement wall: Drill two  $\phi 6$ mm holes with the help of indicator label, insert the plastic expansion tubes into holes and screw the mounting screws into the expansion tubes.

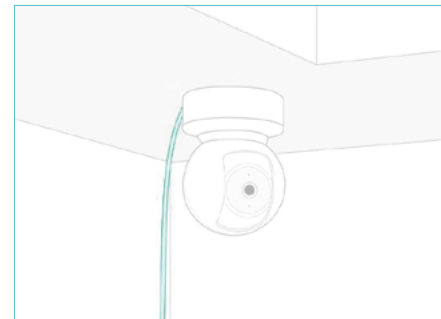
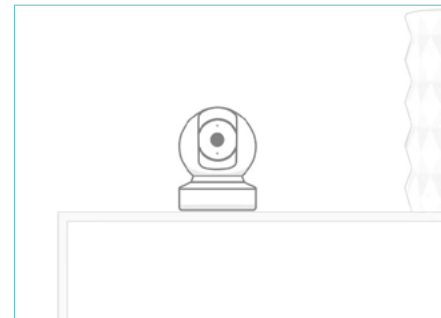

Note: Your camera might use one of the following two types of screws.

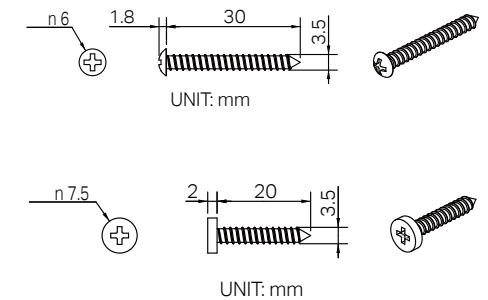



# Main Device Controls

After you successfully set up your camera, you will see the home page of the Kasa Smart app. Here you can view and manage all devices that you've added to Kasa. Tap your camera to enter the live view page and further manage it.

## Home Page

You can see all your Kasa devices listed in the Home page.

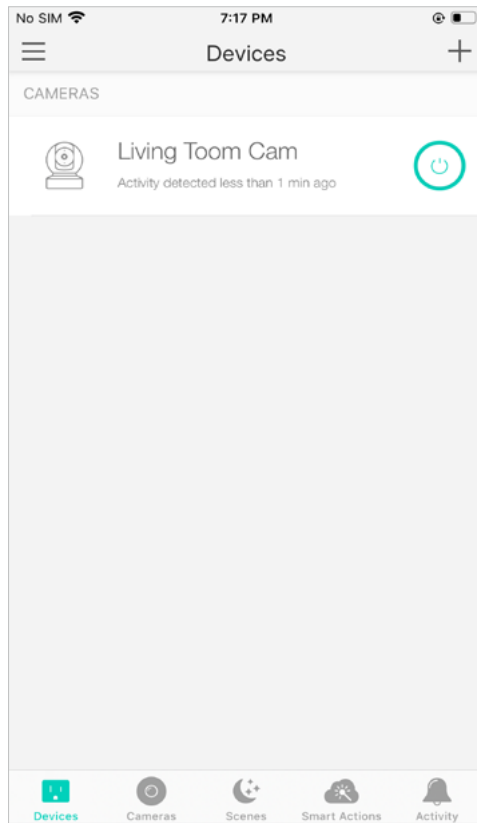

## Turn on/off your camera

Turn on/off your camera quickly by tapping the switch in the home page. If the camera is off, it means you are entering the privacy mode and cannot stream live video.

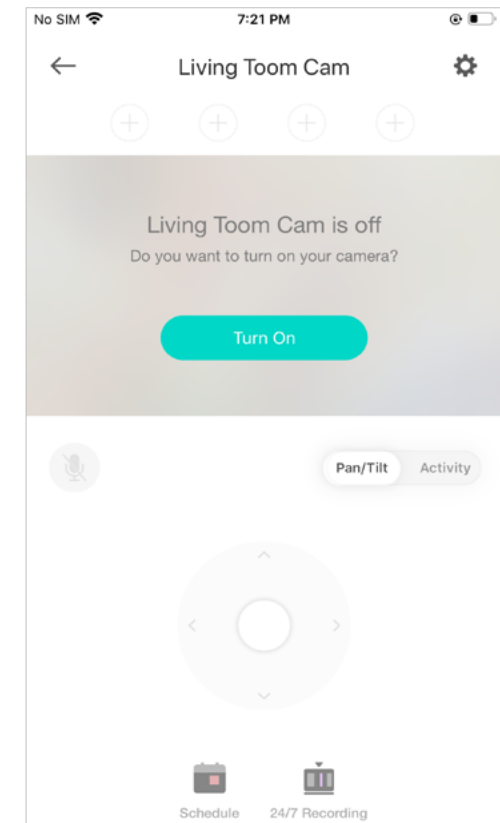
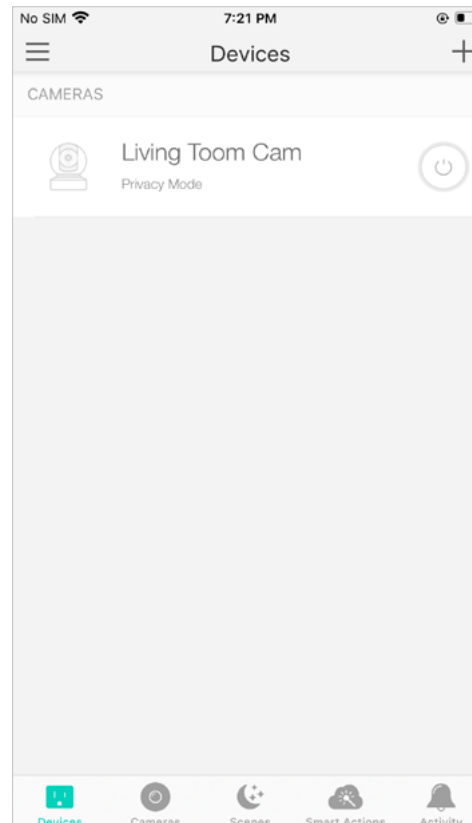

# Pan/Tilt

**Pan/Tilt:** This allows you to move your camera up / down, left / right.

1. Tap your camera in the Home page to enter the live view page.

2. Tap the arrow icon to rotate your camera as you like.

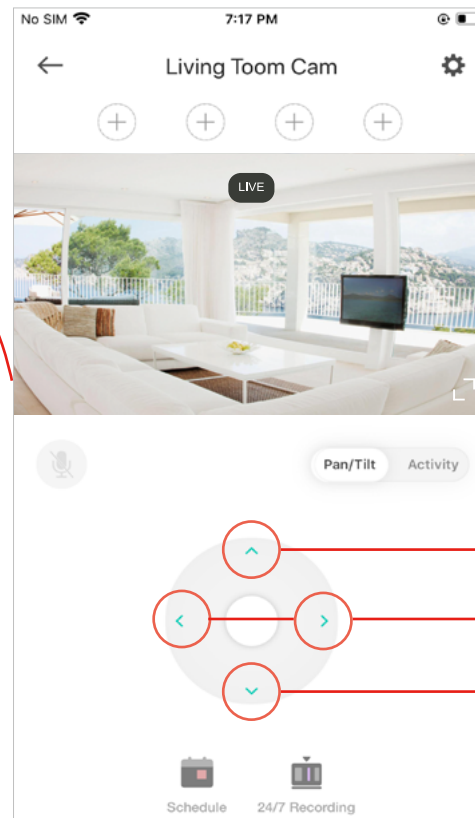
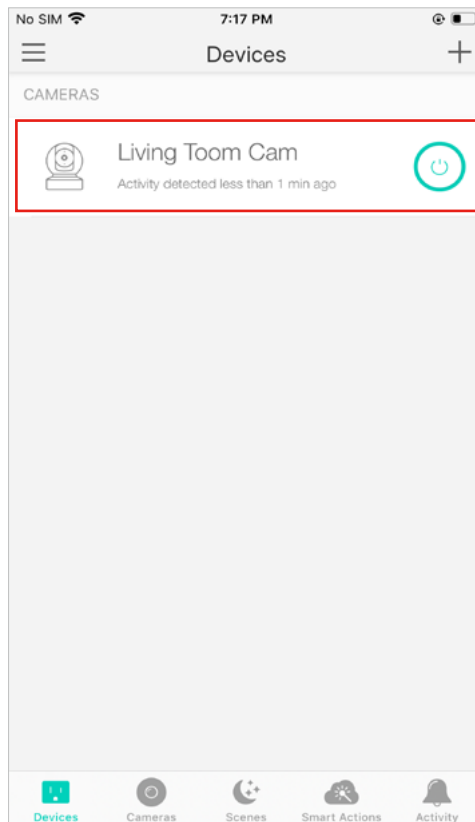

Tilt your camera up.

Tilt your camera left / right.

Tilt your camera down.

# Add View Points

**Viewpoints:** Add the spots that are most important to you, so you can easily turn your camera to the specific spot with a single tap.

1. Tap your camera in the Home page to enter the live view page.

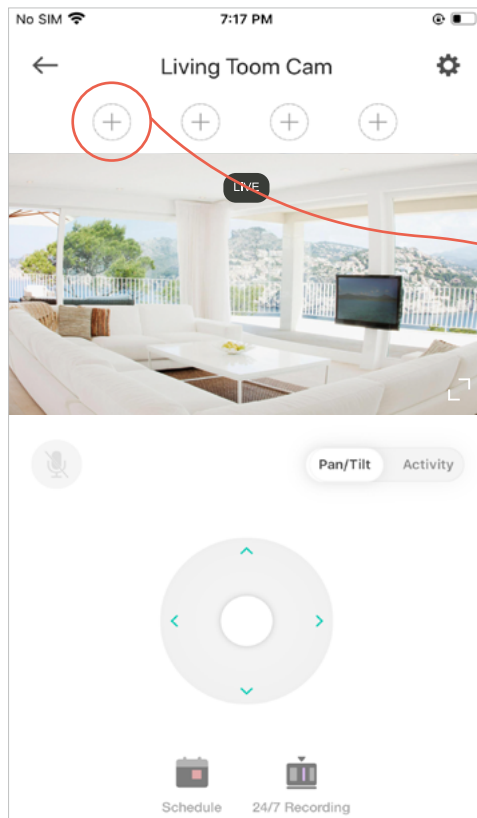

2. Rotate your camera to locate the spot that matters to you, then tap  to add it as a viewpoint.

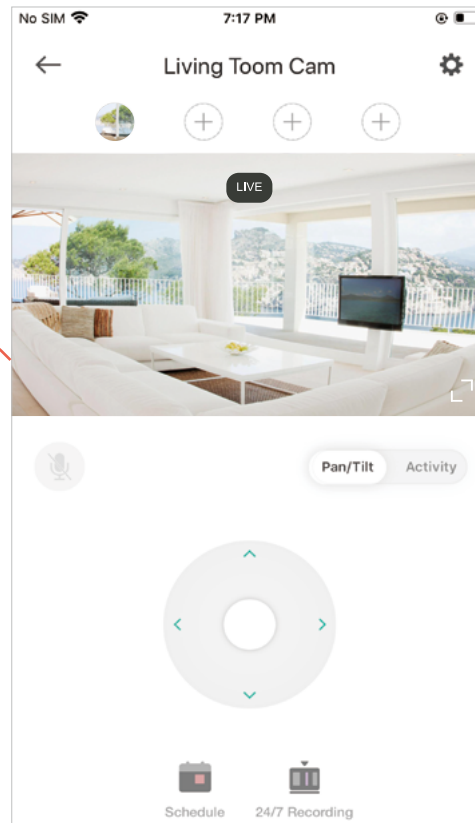

3. Follow the same steps to add other view points.

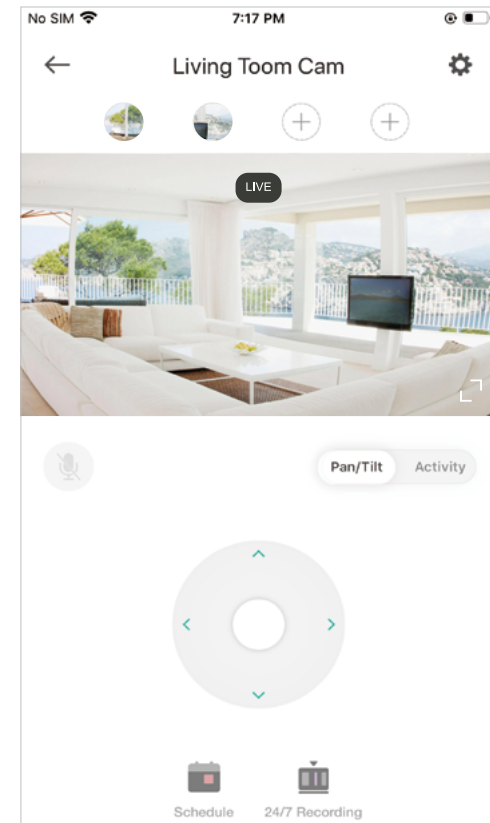

# Set Schedules

**Schedule:** Set schedules to automatically turn on/off your camera, or turn on/off patrol mode (the camera moving between your viewpoints) of your camera, at set times according to your daily routine.

## 1. Power Schedule

1. Tap your camera in the Home page to enter the live view page, and then tap  .

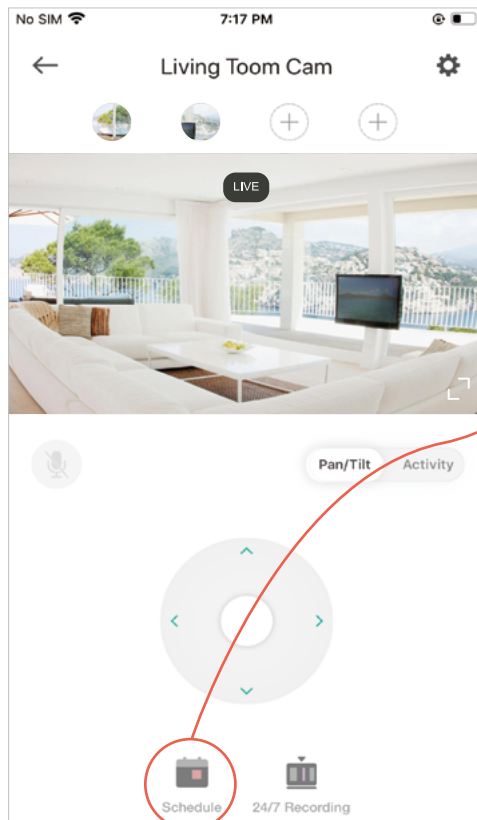

2. Tap + on the top right corner.

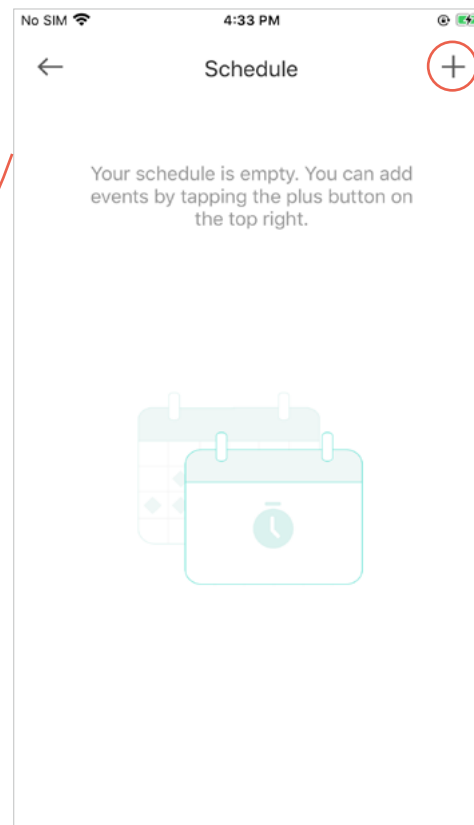

3. Select **Power**.

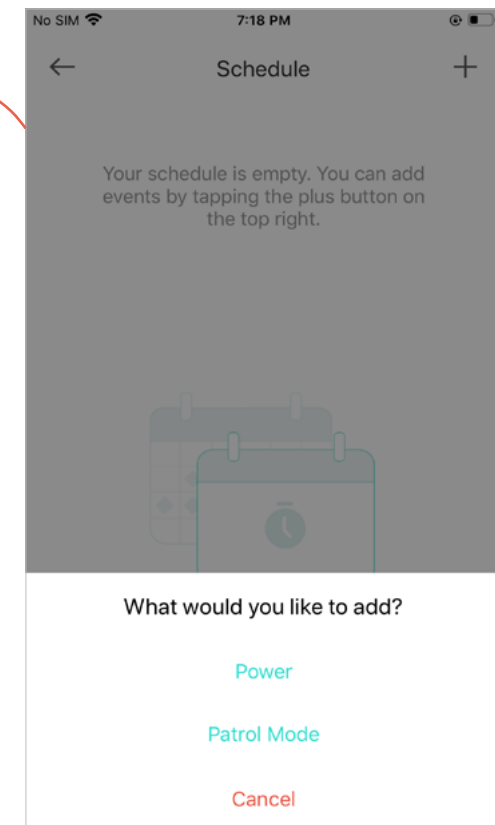

## 1. Power Schedule

4. Set a schedule to turn the camera on or off. For example, I want to turn off the camera at 8:00 PM every day.

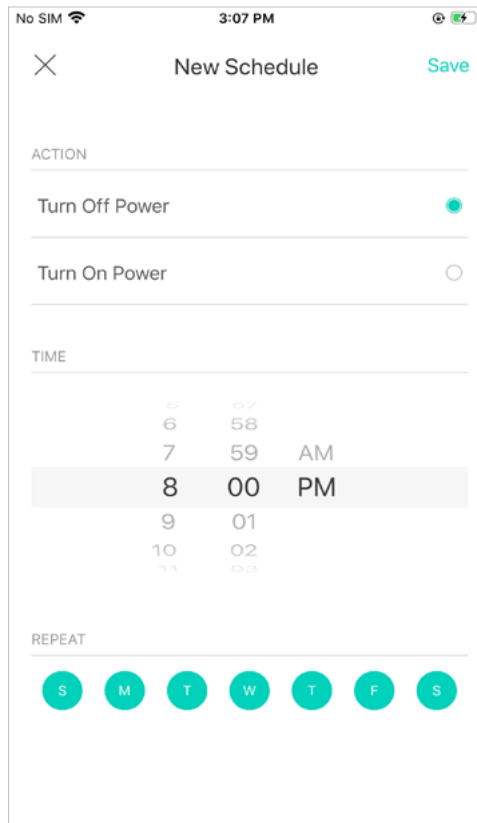

5. Tap [Save](#) and you'll see your schedule listed in the [Schedule](#) Page. You can add more schedules following the same steps.

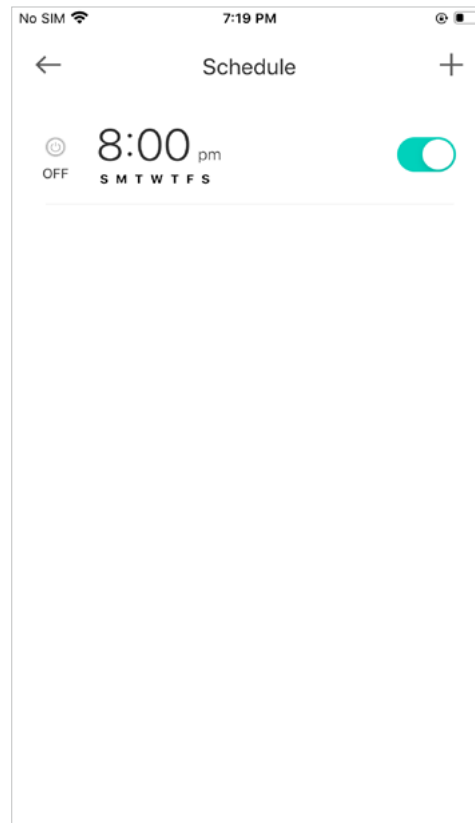

6. You can turn off your schedule any time at the [Schedule](#) page.

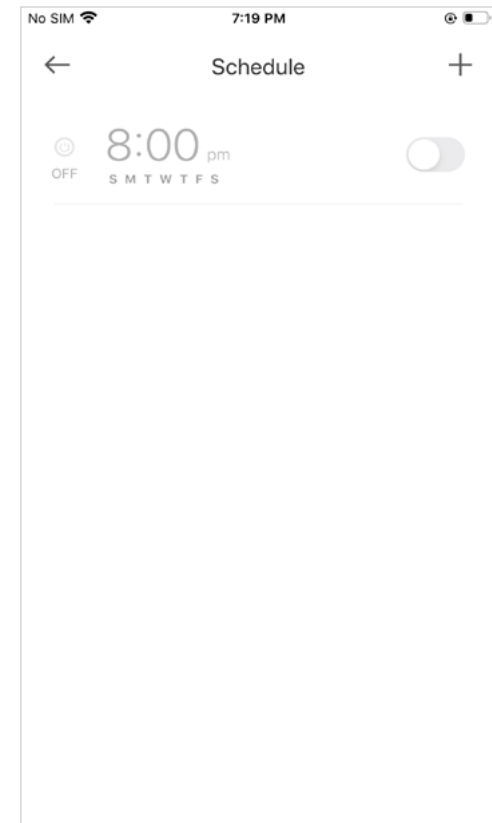

## 2. Patrol Mode Schedule

Note: You need at least two viewpoints to use the patrol mode schedule.

1. Tap your camera in the Home page to enter the live view page, and then tap  .

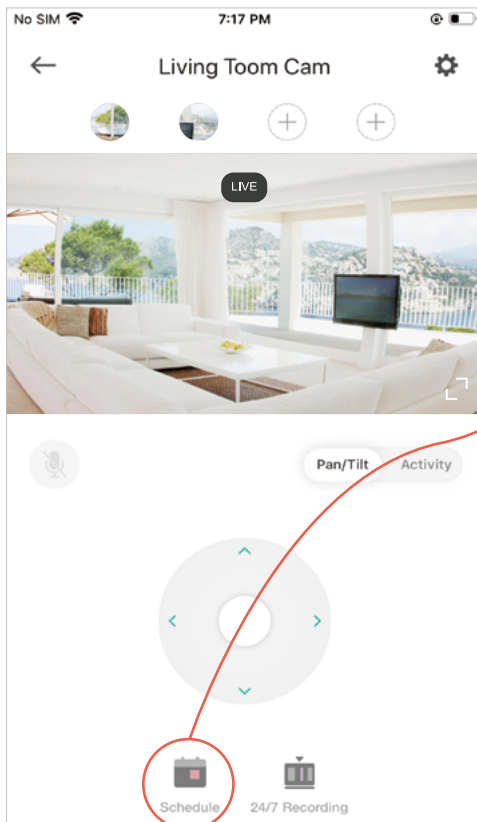

2. Tap + on the top right corner.

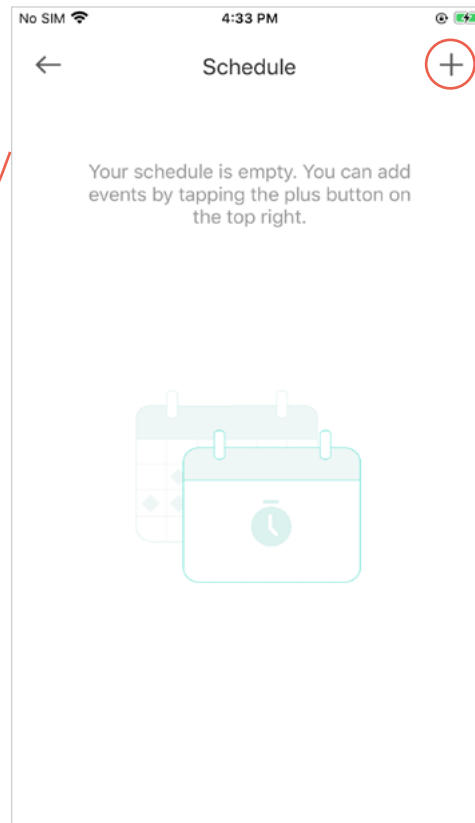

3. Select **Patrol Mode**.

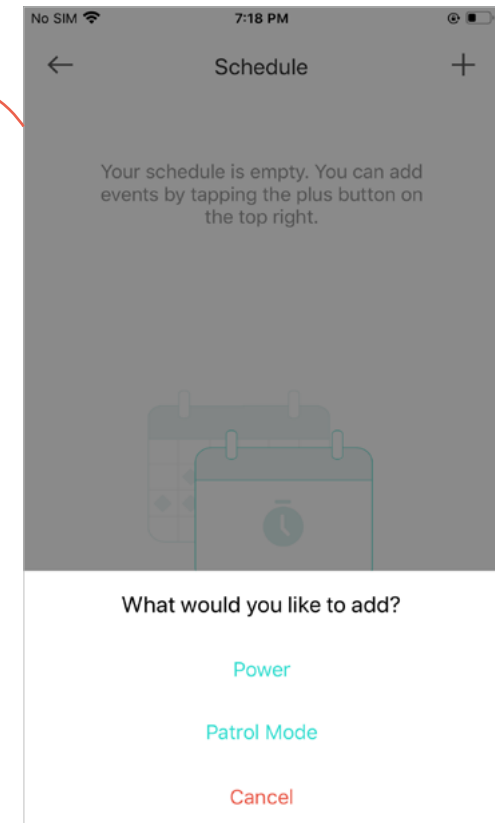

## 2. Patrol Mode Schedule

Note: You need at least two viewpoints to use the patrol mode schedule.

4. Set a schedule to turn the patrol mode on or off. For example, I want to turn on patrol mode at 9:00 AM every weekday.

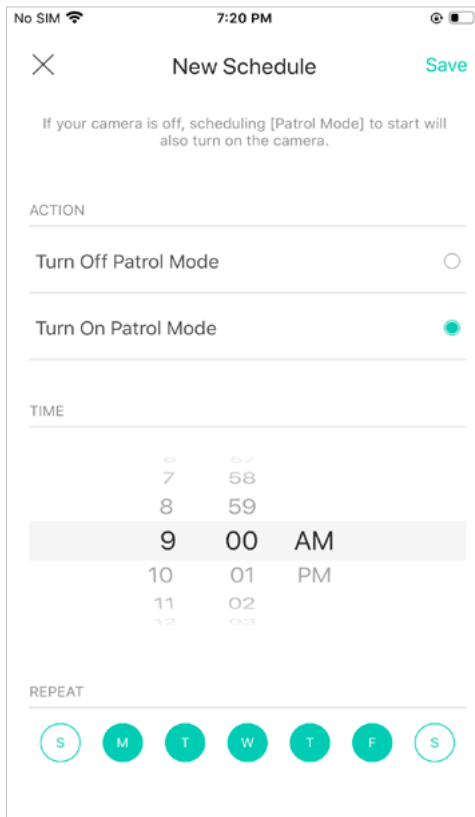

5. Tap [Save](#) and you'll see your schedule listed in the [Schedule](#) Page. You can add more schedules following the same steps.

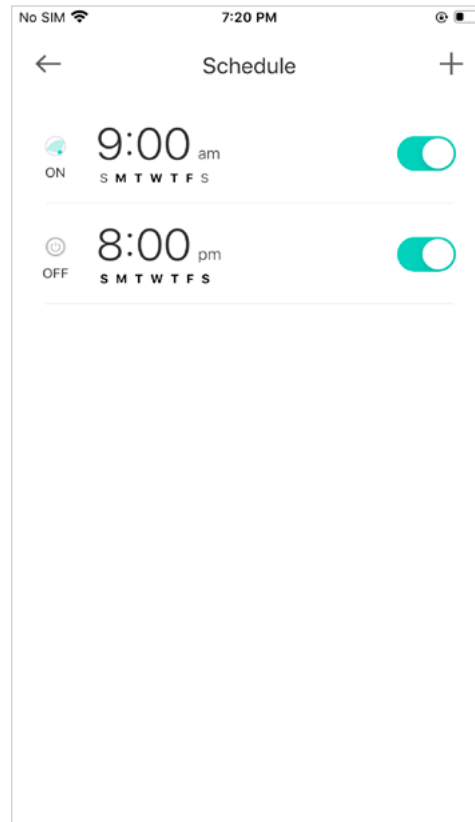

6. You can turn off your schedule any time at the [Schedule](#) page.

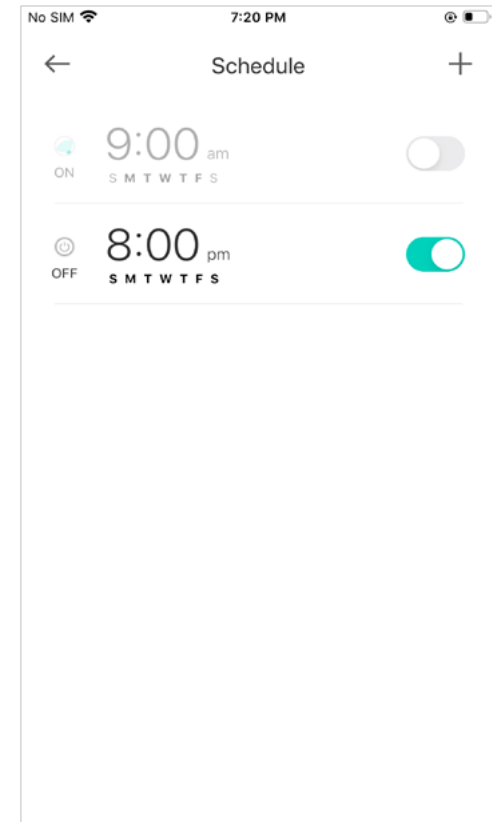

# Set 24/7 Recording

**24/7 Recording:** When 24/7 Recording is enabled, your camera record every minute of every day so you'll never miss a thing.

Note: Format your microSD card in the Kasa Smart app before using it.

1. Get to know [24/7 Recording](#).

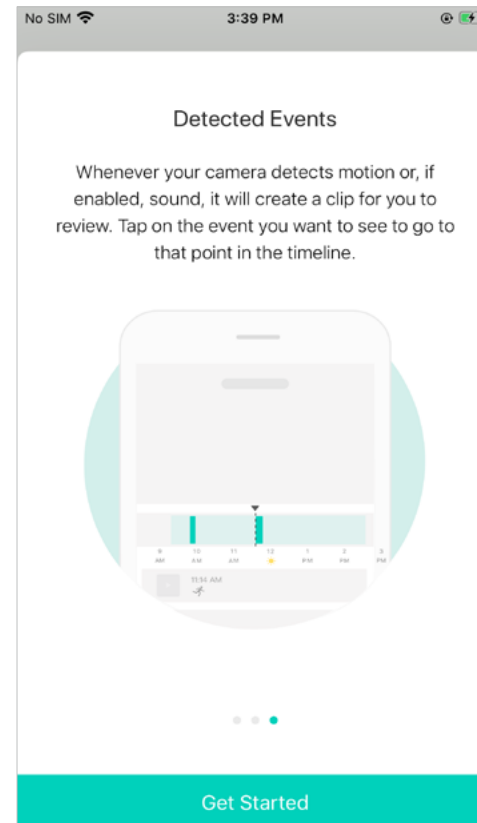
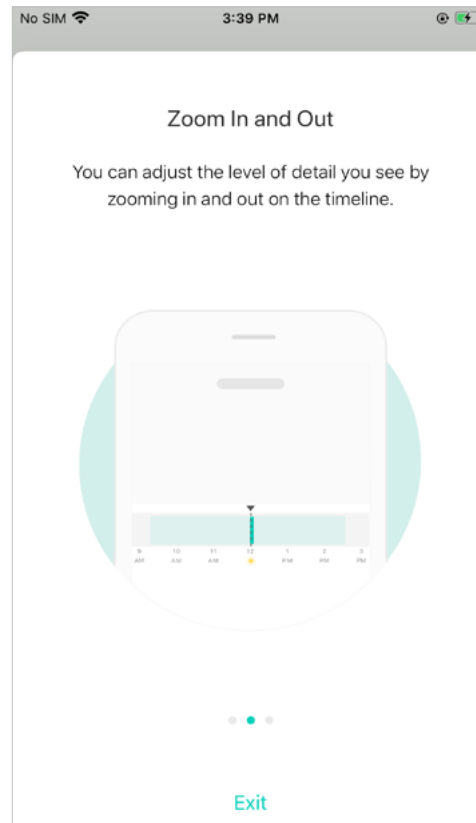
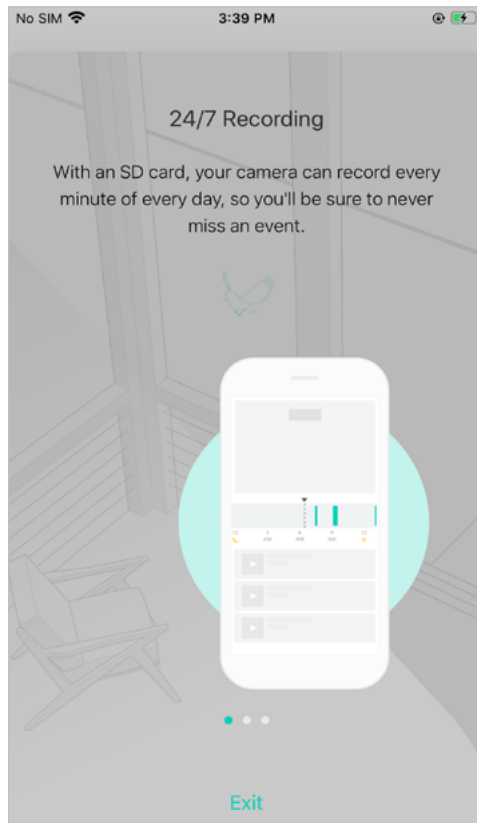





2. check the recorded videos in [24/7 Recording](#).

Tap your camera in the Home page to enter the live view page, and then

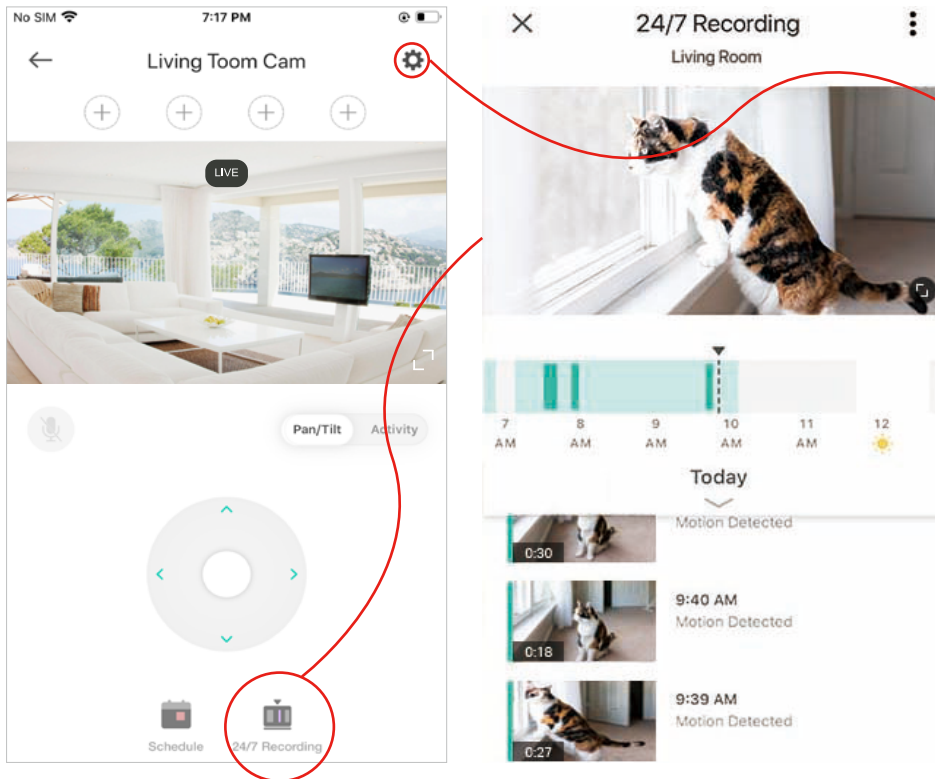
tap  .



3. Enable or disable [24/7 Recording](#).

Tap  your in the live view page and tap [24/7 Recording](#). Here you can enable or disabled the feature and check the storage of your microSD card.

**Encryption:** when enabled, all videos recorded to your SD card can only be read from this camera.

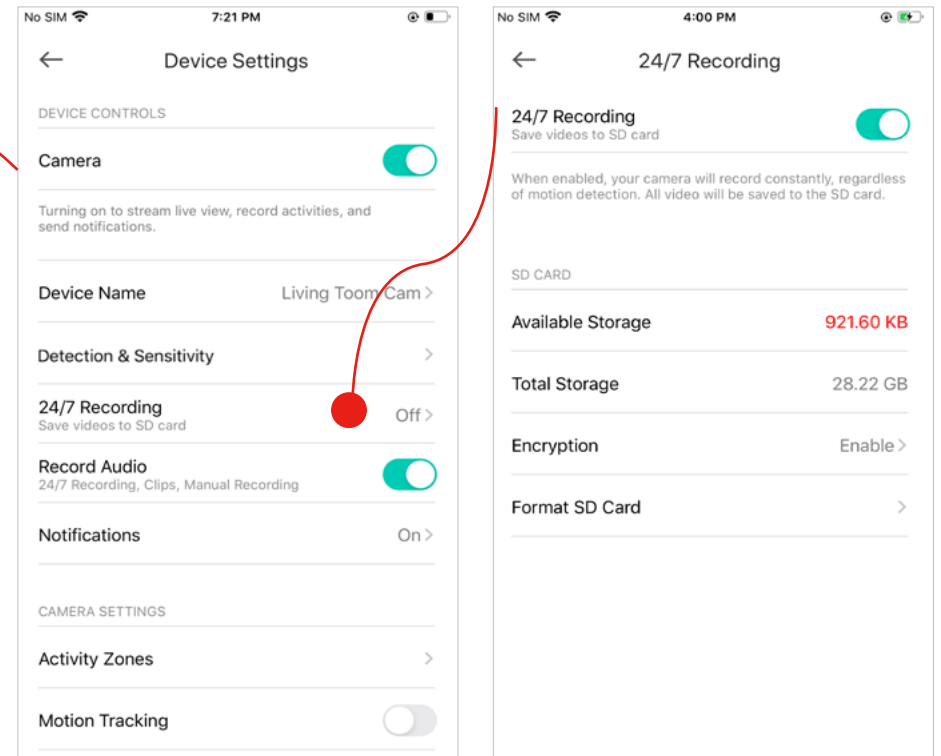

# Manage Device Settings

1. Tap your camera in the Home page to enter the live view page and then tap  .

2. Turn on or off the camera.

When turned off, it means privacy mode is enabled. You can turn the camera off when you do not want your camera to stream live view video and record videos.

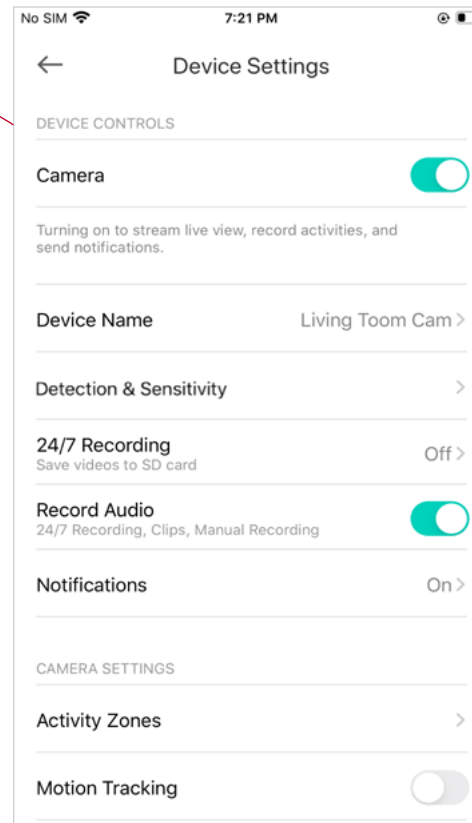
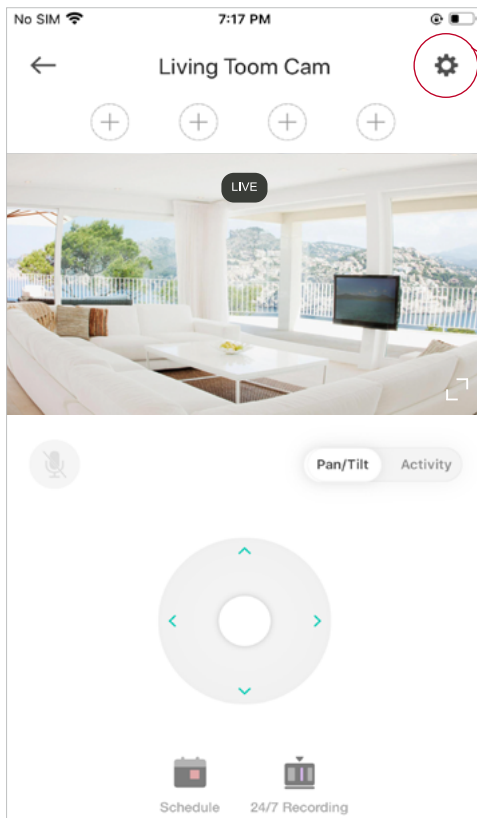

# Manage Device Settings

3. Edit device name.

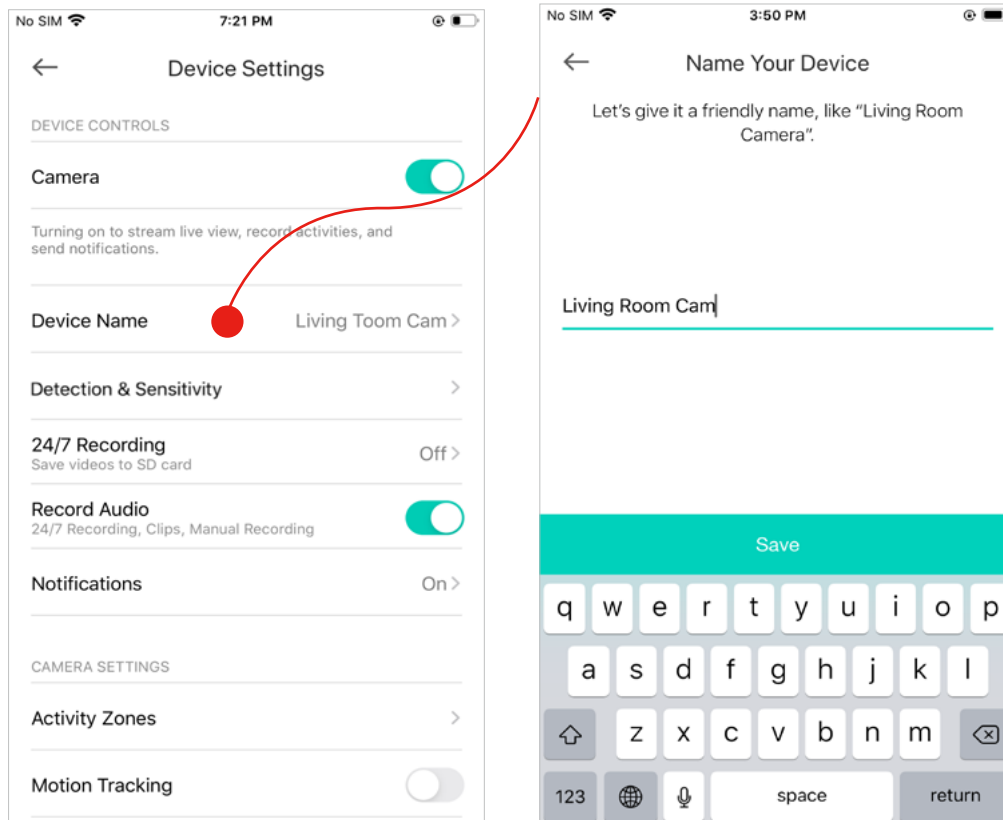

# Manage Device Settings

4. Set detection and sensitivity for recording videos.

Enable [Detect Motion](#) / [Detect Person](#) if you want your camera to record when motion / person is detected. Also set the sensitivity of detection.

Enable [Listen for Sound](#) / [Detect Baby Crying](#) if you want your camera to record when sound / baby crying is detected. Then set its sensitivity.

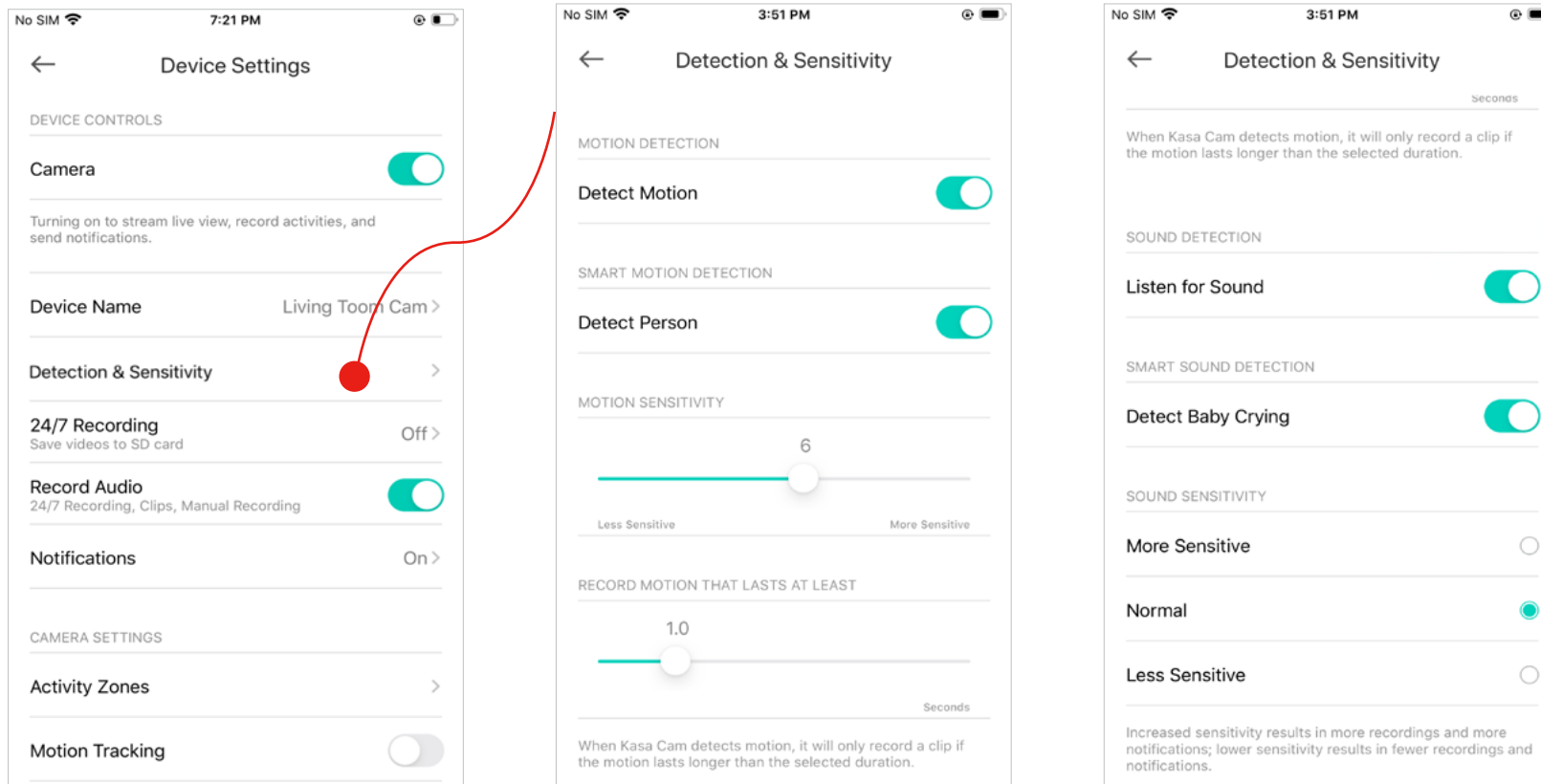

# Manage Device Settings

5. Choose whether to record audio.

Enable [Record Audio](#) if you want to also record sound during recording.

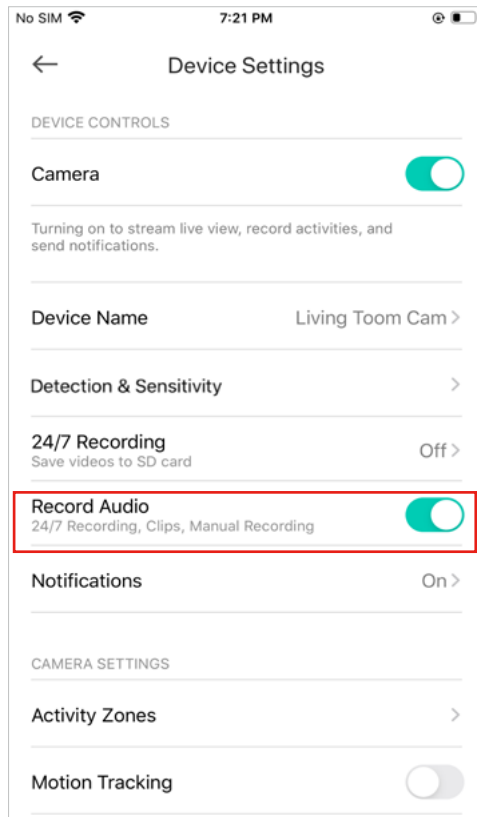

# Manage Device Settings

6. Choose whether to receive notifications.

Enable [Person Detected](#) / [Baby Crying Detected](#) / [All Other Motion & Sound](#) if you want to be notified when person / baby crying / all other motion and sound is detected. You can also select the time when you want to receive notifications.

If you don't want to be bothered by frequent notifications, enable [Automatically Limit Notifications](#).

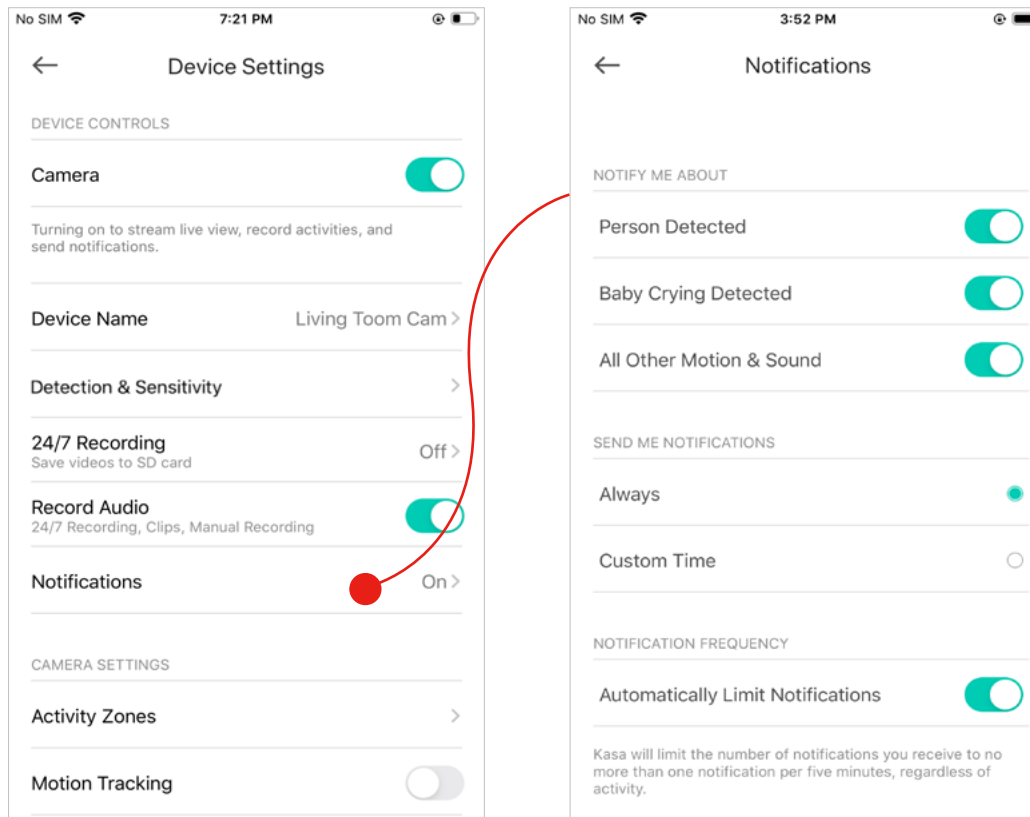

# Manage Device Settings

## 7. Set activity zones.

Control what alerts you by creating multiple custom activity zones around areas that are important to you.

You need to add viewpoints first. Then you can set activity zones in a specific viewpoint. Check how to [Add View Points](#).

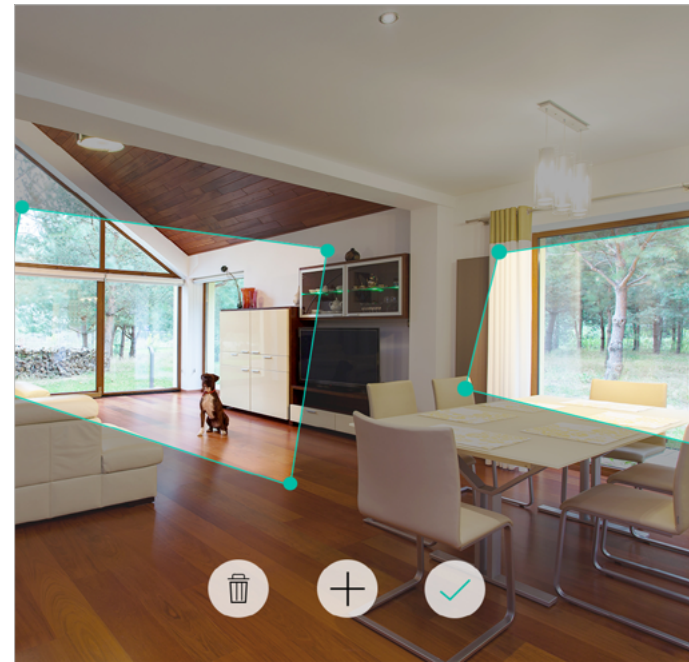
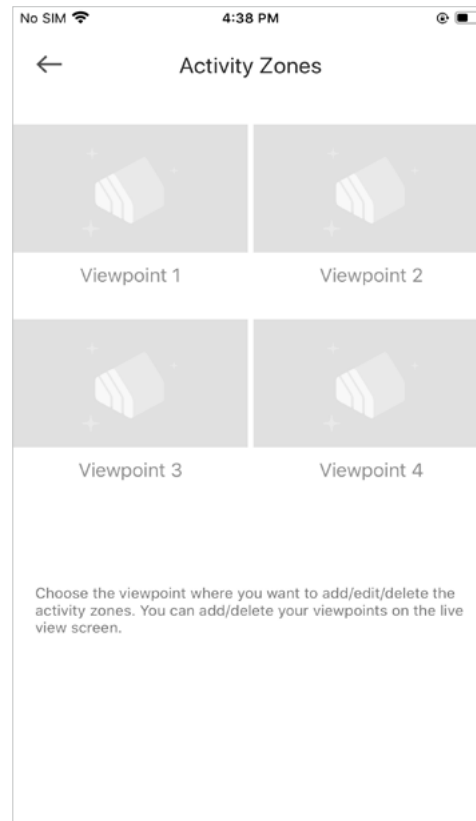
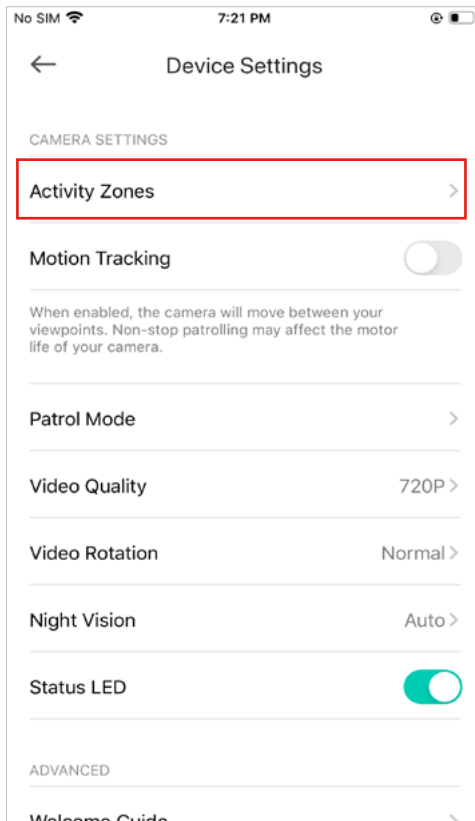

# Manage Device Settings

## 8. Motion Tracking.

When motion is detected, the camera will continue tracking the activity until it has stopped even if it is out of the camera's normal view.

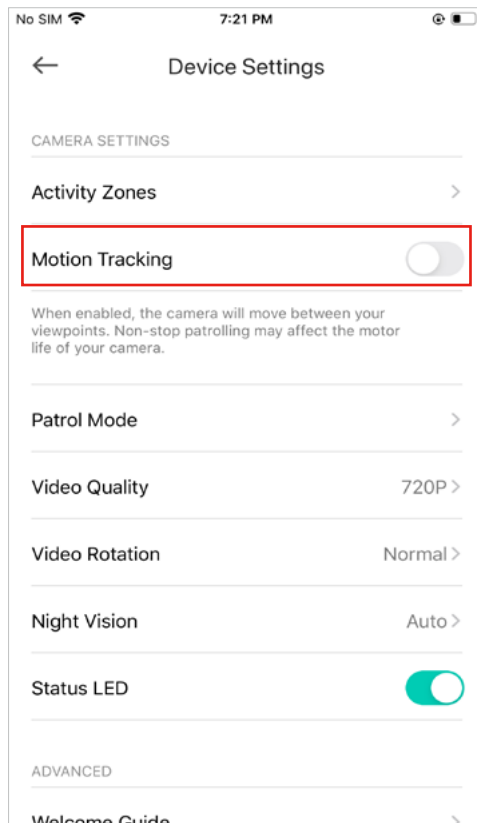



# Manage Device Settings

## 9. Patrol Mode.

Set multiple distinct viewpoints and program your camera to keep an eye on each region at custom intervals.

Check how to [Add View Points](#).

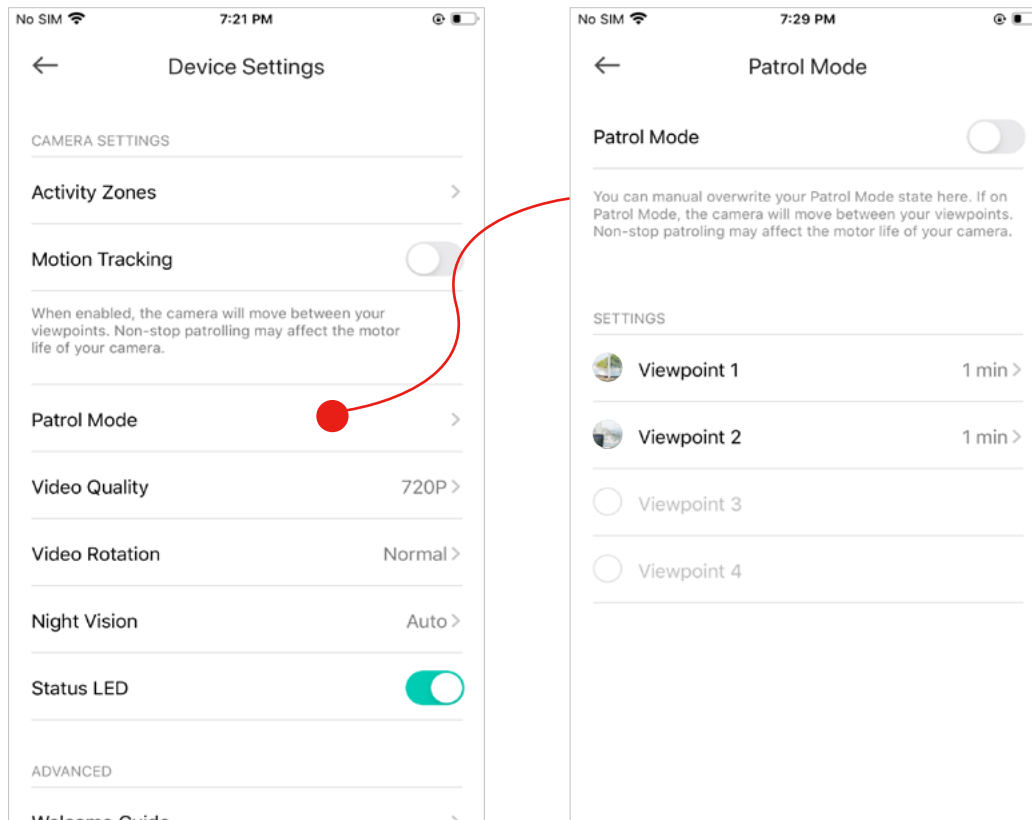

# Manage Device Settings

10. Choose the resolution for videos.

The highest quality looks better but requires faster internet connection and larger size for saving the videos.

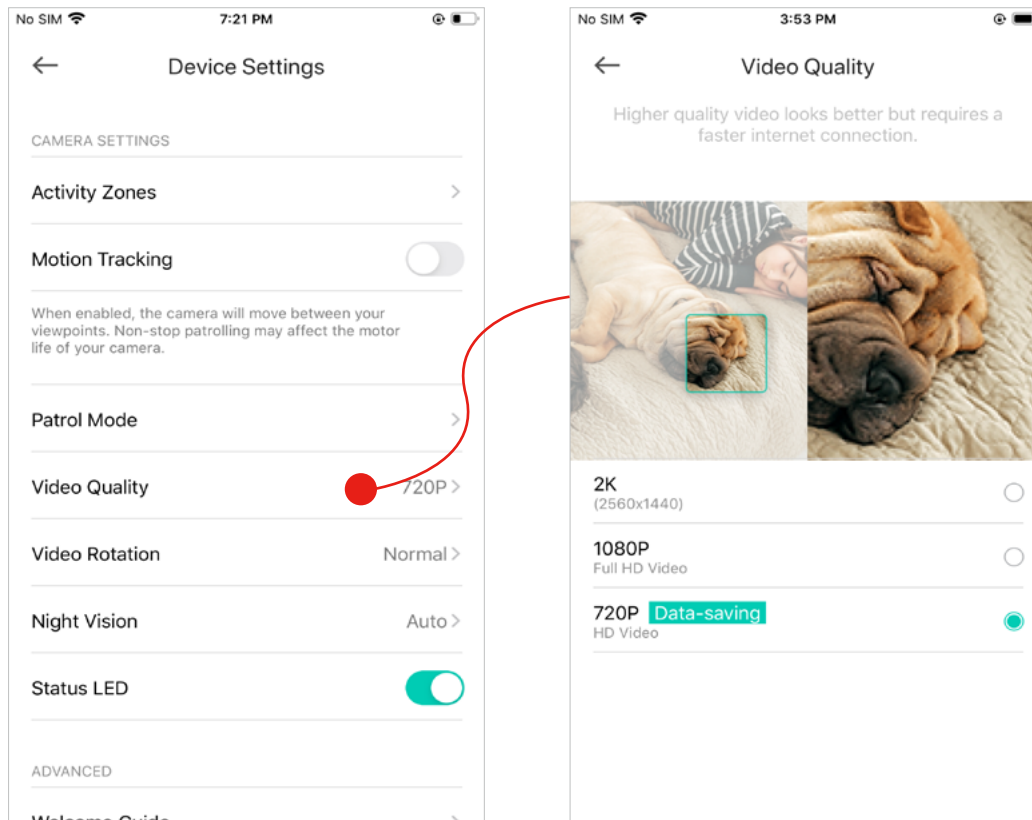

# Manage Device Settings

11. Choose whether to rotate the video.

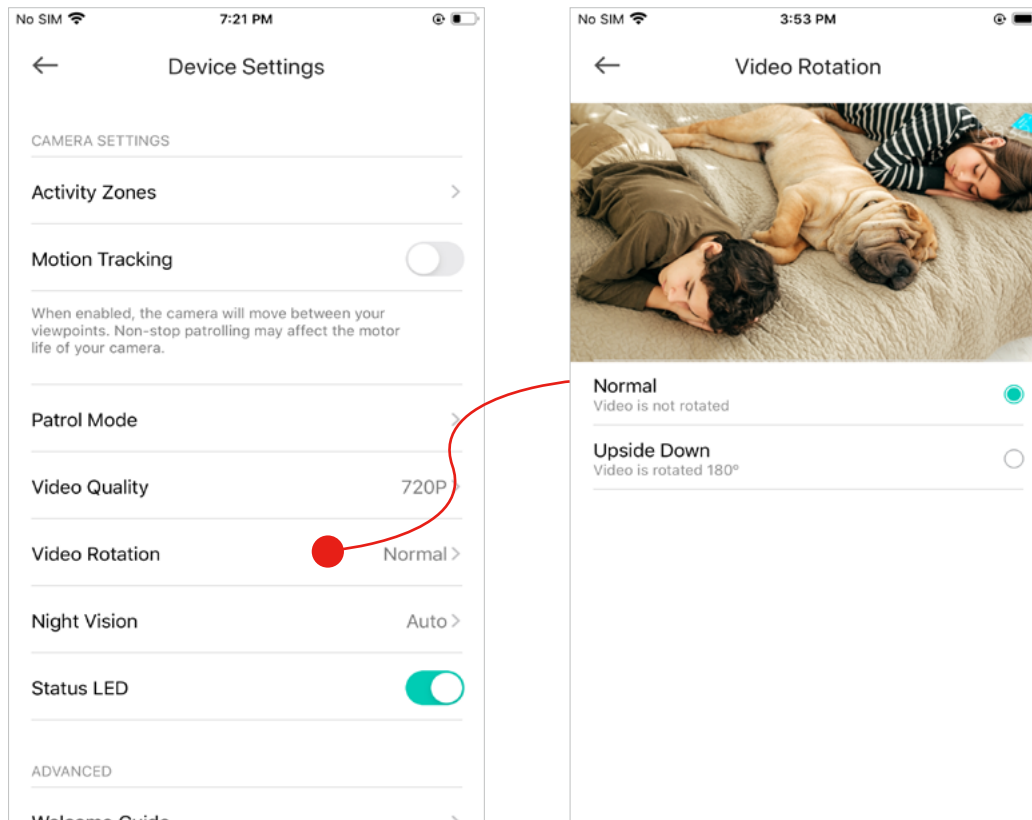

# Manage Device Settings

12. Choose when you want the night vision to be on.

Night vision allows you to see clearly at night. You can choose [Automatic](#) to turn on night vision automatically in low light conditions and turn off in daylight.

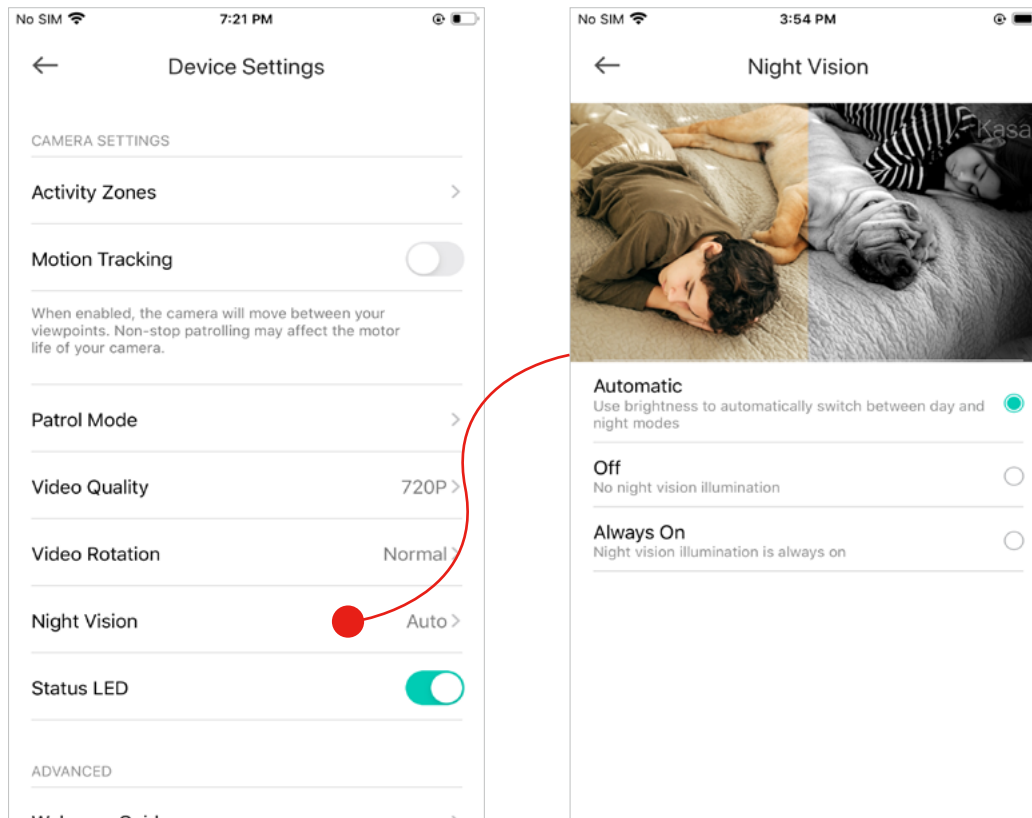

# Manage Device Settings

13. Turn on/off Status LED.

Turn on or off the status LED on the camera.

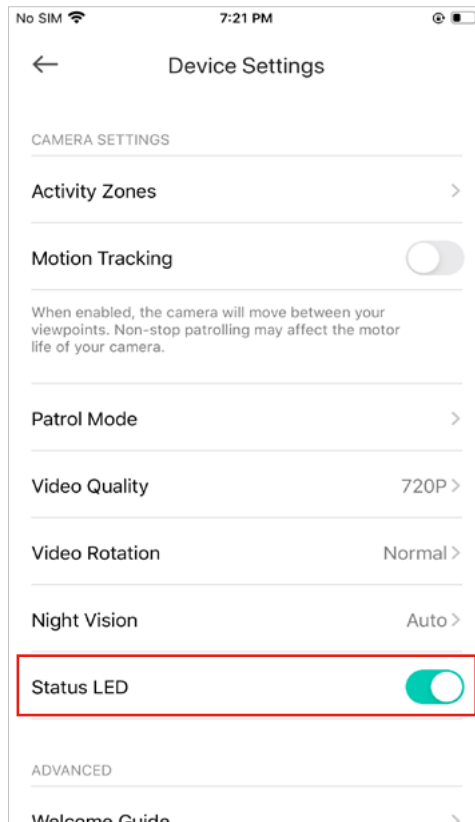

# Manage Device Settings

14. Get to know more about the wall-mount information or 24/7 recording information by tapping [Wall-Mount Guide](#) or [24/7 Recording Guide](#).

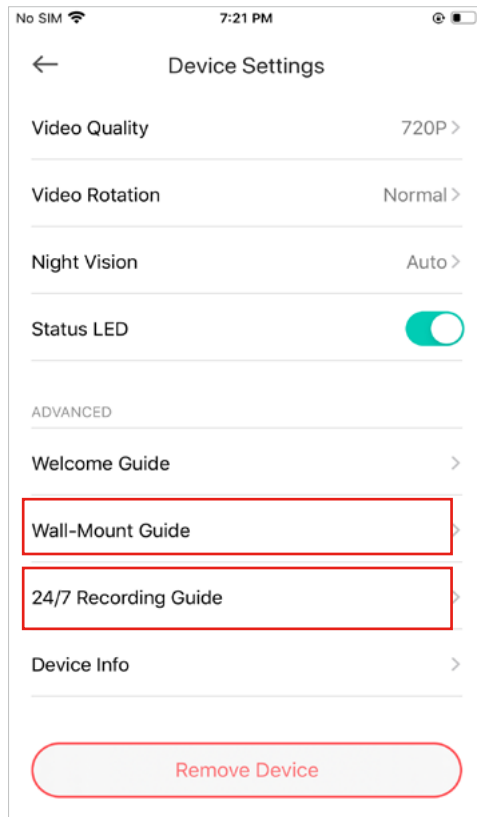

# Reset Your Camera

TP-Link provides two methods to reset your camera.

## Method 1

Swipe left your camera on the [Home](#) page and tap [Delete](#). Then tap [Remove Device](#). Your camera will be removed from your Kasa account and restored to factory settings.

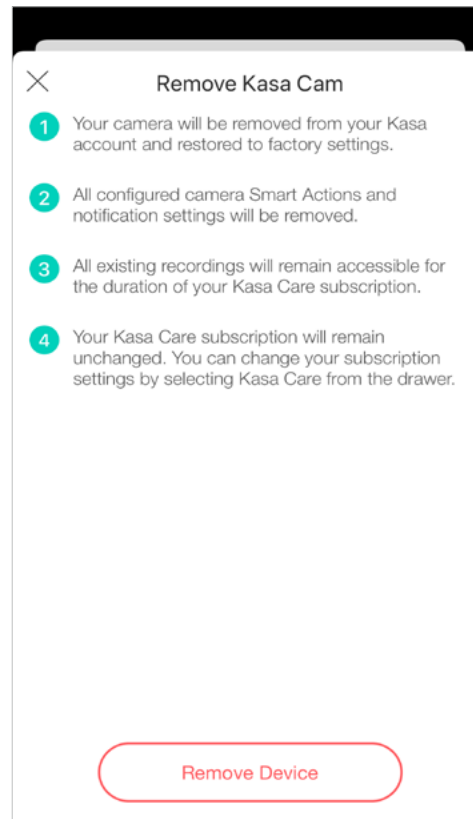
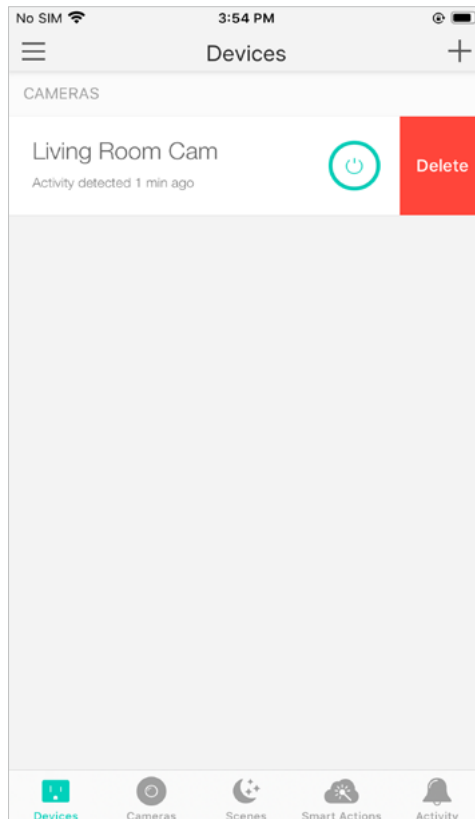

## Method 2

Tap your camera and go to the [Devices Settings](#) page. Then tap [Remove Device](#) in the bottom. Your camera will be removed from your Kasa account and restored to factory settings.

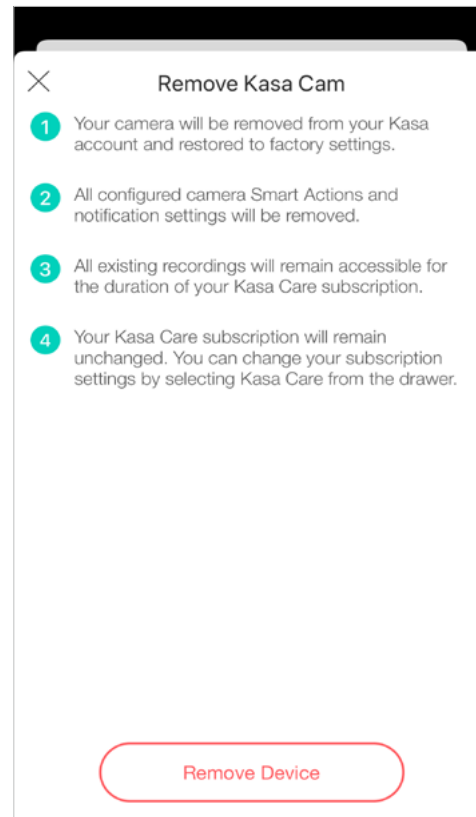
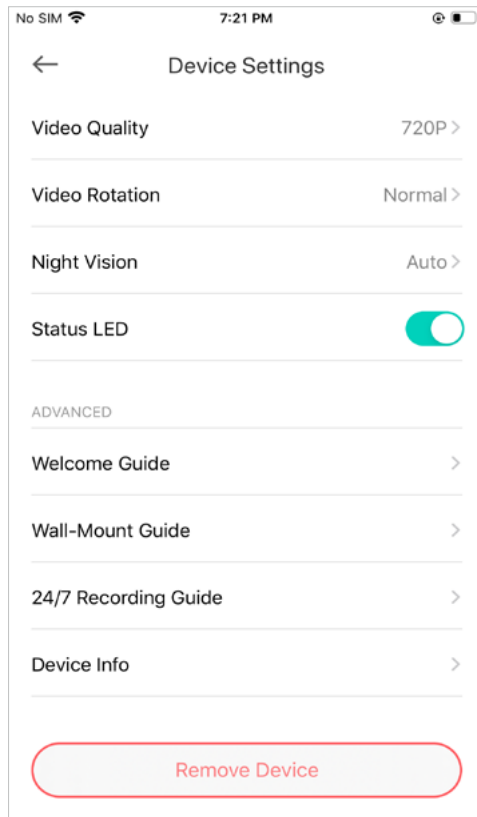



# Smart Actions - Motion Sensing

Smart Actions is a function provided that enables device interconnections and home automations. With Smart Actions, your Kasa devices can work together to create a smarter smart home. From the moment you wake up to the moment you drift asleep, Smart Actions make your home safer and more comfortable. There are four types of smart actions. For your Kasa Smart Camera, you can set Motion Sensing smart action.

1. Tap  at the bottom, then tap **Add an Action**.

2. Select an automation type for your Smart Actions. Here we choose **Motion Sensing**.

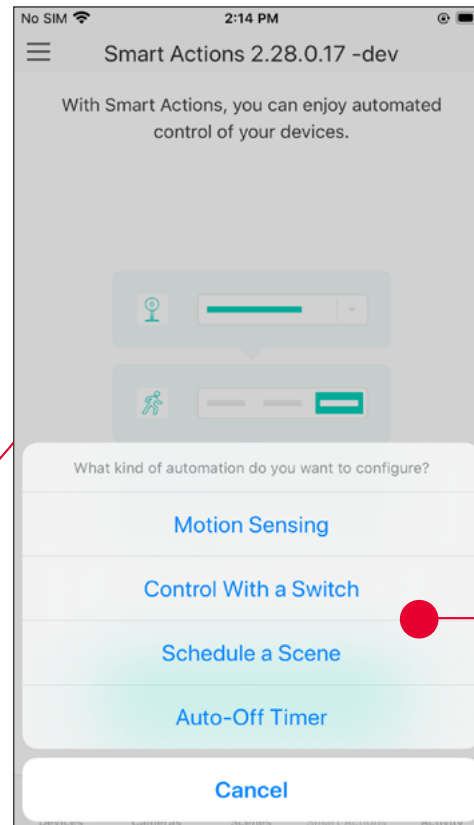
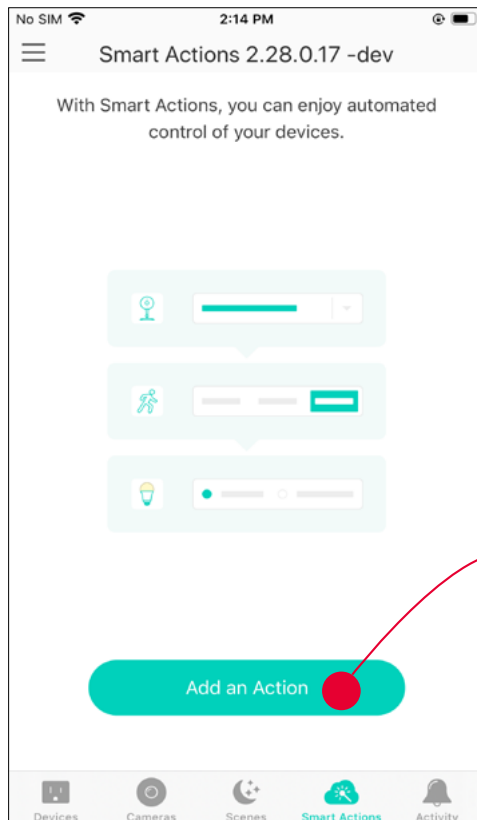

**Motion Sensing:** Take actions when a Kasa camera senses a motion.

**Control With a Switch:** Extending the Smart Switch control to other Kasa Smart devices. Turn on/off a group of devices with the Smart Switch all together.

**Schedule a Scene:** Schedule a "Scene" to be turned on automatically at the time specified.

**Auto-off Timer:** Whenever a Smart device is turned on, turn it off after the designated amount of time.

## Configure Motion Sensing if you also have another Kasa smart device

e.g.: I want to turn my living room light (plugged in my Kasa Smart Plug) on when my Kasa camera senses a motion.

1. Tap **Motion Sensing** then select a camera.

2. Select your Kasa Smart Plug in which your living room light is plugged.

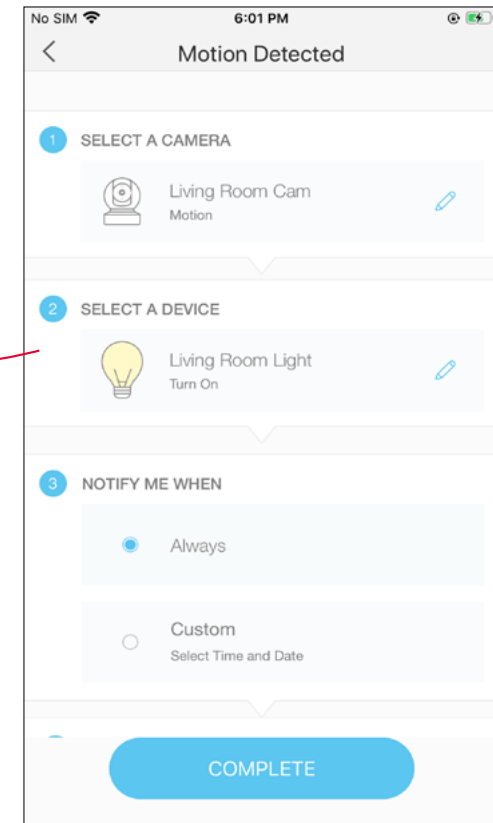
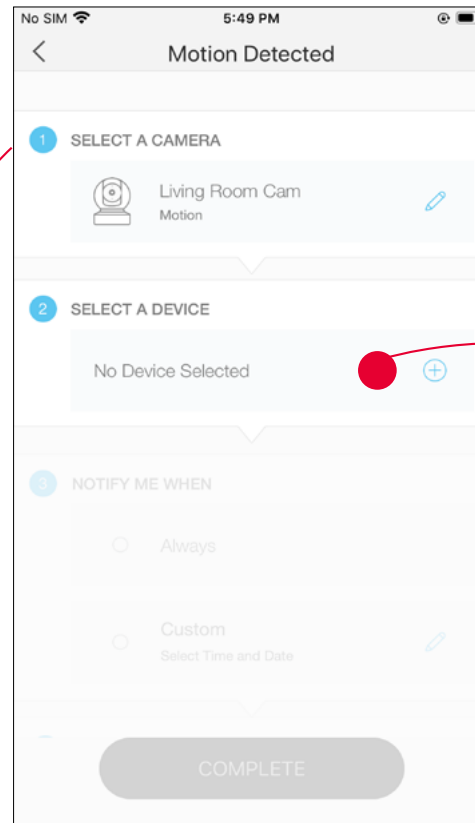
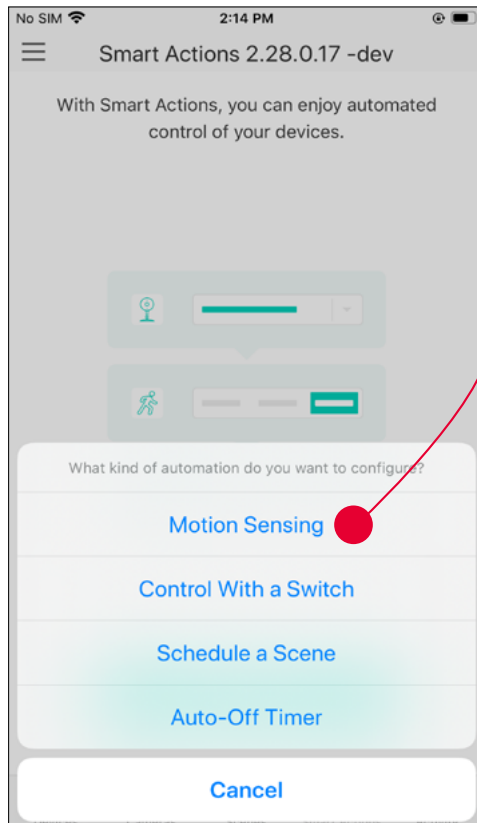

3. Set the time when you want the action to run. You can choose [Always](#) or tap [Custom](#) to choose time according to your needs.

For example: I want the motion to trigger the light on from 11:00 PM to 7:00 AM every day.

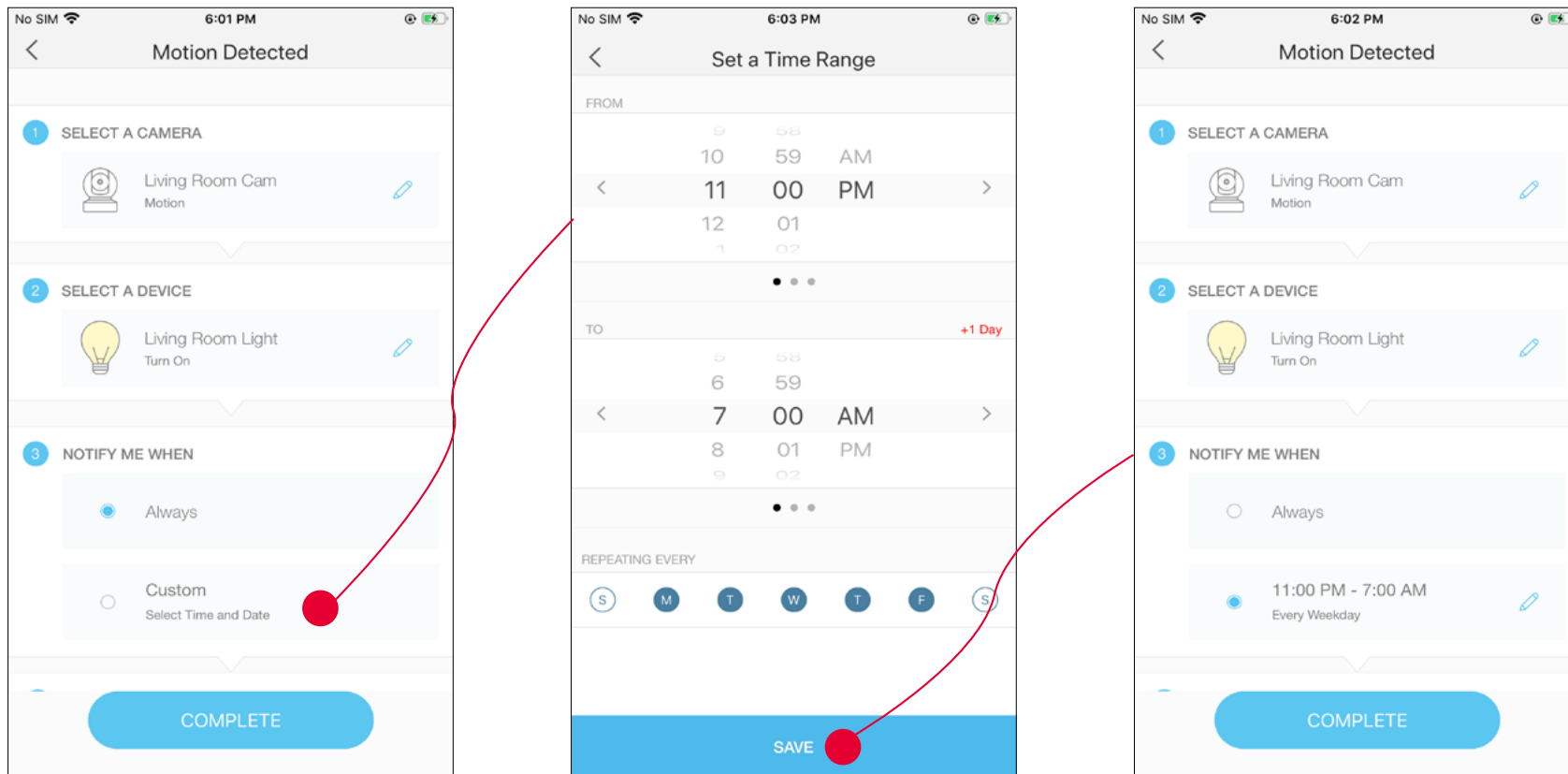

4. (Optional) Set an auto-off timer then tap **Complete**. Then your light will be turned off after the time when it is triggered on.

5. Name your action for easy identification.

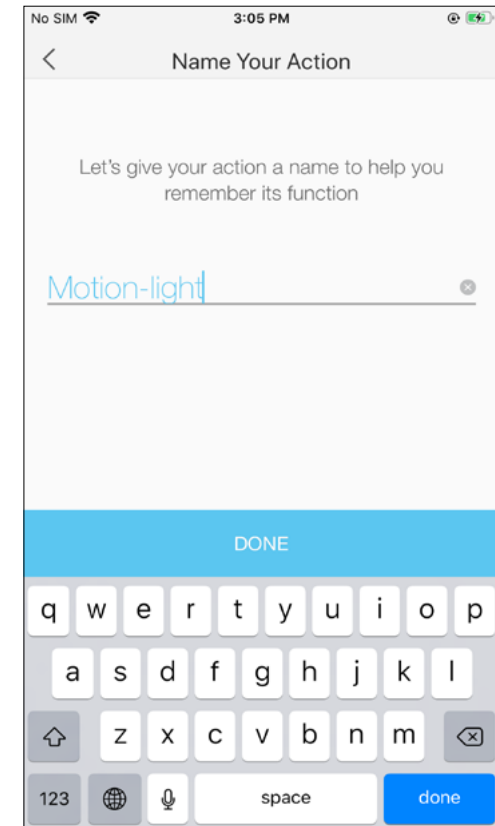
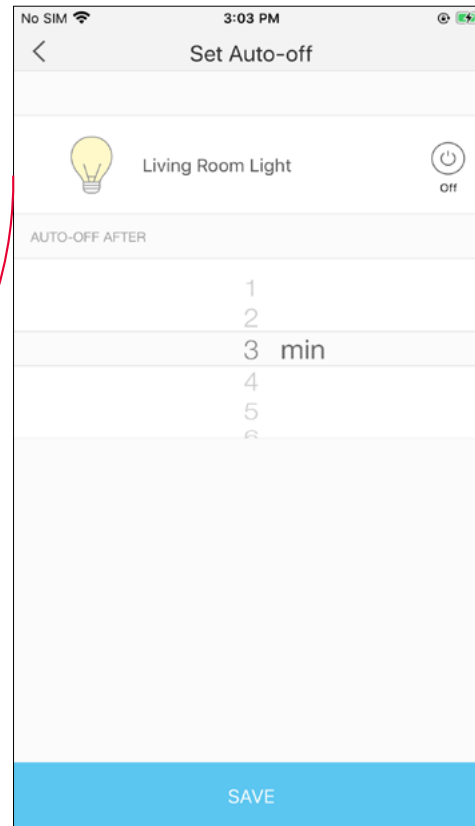
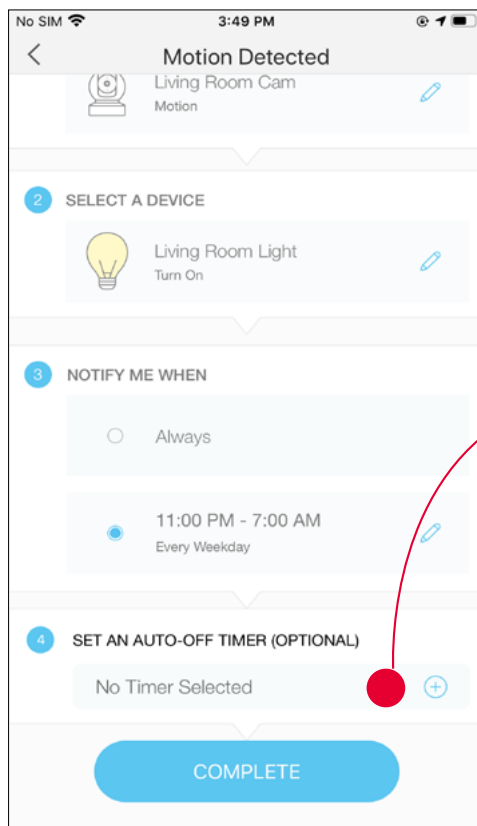

6. The Smart Action is created successfully and displayed in the Smart Actions list.

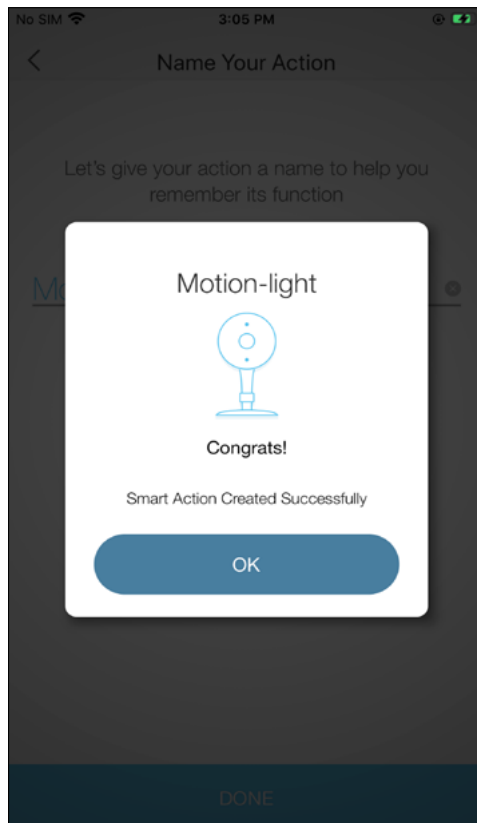

# Discover Kasa

Use the Kasa Smart app to pair your Smart Light Switch with Amazon Alexa or Google Home Assistant, and enjoy a full hands-free experience. Kasa helps manage the rest of your smart home too, working with Samsung SmartThings to trigger changes when you arrive home or leave for the day.

Launch the **Kasa Smart** app. Go to the sidebar and tap Work with Kasa. You can choose **Amazon Alexa / Google Assistant/ IFTTT / Samsung SmartThings** for detailed instructions.

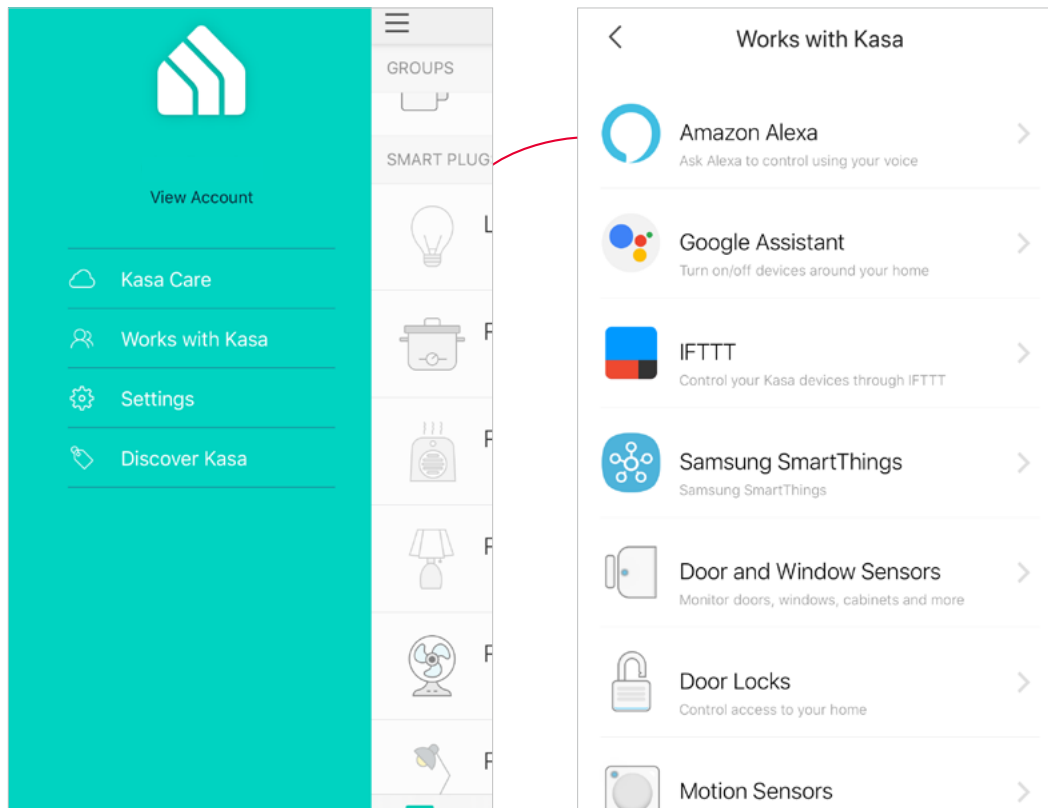

## FCC compliance information statement



**Product Name: Kasa Spot Pan Tilt, 24/7 Recording**

**Model Number: KC410S**

Component Name	Model	FCC Identifier number
AC ADAPTER	A8-501000	NA

### **Responsible Party:**

#### **TP-Link USA Corporation**

Address: 10 Mauchly, Irvine, CA 92618

Website: <https://www.tp-link.com/us/>

Tel: +1 626 333 0234

Fax: +1 909 527 6804

E-mail: [sales.usa@tp-link.com](mailto:sales.usa@tp-link.com)

This equipment has been tested and found to comply with the limits for a Class B digital device, pursuant to part 15 of the FCC Rules. These limits are designed to provide reasonable protection against harmful interference in a residential installation. This equipment generates, uses and can radiate radio frequency energy and, if not installed and used in accordance with the instructions, may cause harmful interference to radio communications. However, there is no guarantee that interference will not occur in a particular installation. If this equipment does cause harmful interference to radio or television reception, which can be determined by turning the equipment off and on, the user is encouraged to try to correct the interference by one or more of the following measures:

- Increase the separation between the equipment and receiver.
- Connect the equipment into an outlet on a circuit different from that to which the receiver is connected.
- Consult the dealer or an experienced radio/ TV technician for help.

This device complies with part 15 of the FCC Rules. Operation is subject to the following two conditions:

1. This device may not cause harmful interference.
2. This device must accept any interference received, including interference that may cause undesired operation.

Any changes or modifications not expressly approved by the party responsible for compliance could void the user's authority to operate the equipment.

Note: The manufacturer is not responsible for any radio or TV interference caused by unauthorized modifications to this equipment. Such modifications could void the user's authority to operate the equipment.

### **FCC RF Radiation Exposure Statement**

This equipment complies with FCC RF radiation exposure limits set forth for an uncontrolled environment. This device and its antenna must not be co-located or operating in conjunction with any other antenna or transmitter.

"To comply with FCC RF exposure compliance requirements, this grant is applicable to only Mobile Configurations. The antennas used for this transmitter must be installed to provide a separation distance of at least 20 cm from all persons and must not be co-located or operating in conjunction with any other antenna or transmitter."

We, **TP-Link USA Corporation**, has determined that the equipment shown as above has been shown to comply with the applicable technical standards, FCC part 15. There is no unauthorized change is made in the equipment and the equipment is properly maintained and operated.

**Issue Date:** 2021-06-21



**FCC compliance information statement**

**Product Name: AC ADAPTER**

**Model Number: 3530501354 A8-501000**

**Responsible Party:**

**TP-Link USA Corporation**

Address: 10 Mauchly, Irvine, CA 92618

Website: <https://www.tp-link.com/us/>

Tel: +1 626 333 0234

Fax: +1 909 527 6804

E-mail: [sales.usa@tp-link.com](mailto:sales.usa@tp-link.com)

This equipment has been tested and found to comply with the limits for a Class B digital device, pursuant to part 15 of the FCC Rules. These limits are designed to provide reasonable protection against harmful interference in a residential installation. This equipment generates, uses and can radiate radio frequency energy and, if not installed and used in accordance with the instructions, may cause harmful interference to radio communications. However, there is no guarantee that interference will not occur in a particular installation. If this equipment does cause harmful interference to radio or television reception, which can be determined by turning the equipment off and on, the user is encouraged to try to correct the interference by one or more of the following measures:

- Increase the separation between the equipment and receiver.
- Connect the equipment into an outlet on a circuit different from that to which the receiver is connected.
- Consult the dealer or an experienced radio/ TV technician for help.

This device complies with part 15 of the FCC Rules. Operation is subject to the following two conditions:

1. This device may not cause harmful interference.
2. This device must accept any interference received, including interference that may cause undesired operation.

Any changes or modifications not expressly approved by the party responsible for compliance could void the user's authority to operate the equipment.

Note: The manufacturer is not responsible for any radio or TV interference caused by unauthorized modifications to this equipment. Such modifications could void the user's authority to operate the equipment.

We, **TP-Link USA Corporation**, has determined that the equipment shown as above has been shown to comply with the applicable technical standards, FCC part 15. There is no unauthorized change is made in the equipment and the equipment is properly maintained and operated.

**Issue Date: 2021-06-21**

## CE Mark Warning



This is a class B product. In a domestic environment, this product may cause radio interference, in which case the user may be required to take adequate measures.

## OPERATING FREQUENCY (the maximum transmitted power)

2400 MHz -2483.5 MHz(20dBm)

## EU Declaration of Conformity

TP-Link hereby declares that the device is in compliance with the essential requirements and other relevant provisions of directives 2014/53/EU, 2009/125/EC, 2011/65/EU and (EU)2015/863.

The original EU Declaration of Conformity may be found at <https://www.tp-link.com/en/ce/>

## RF Exposure Information

This device meets the EU requirements (2014/53/EU Article 3.1a) on the limitation of exposure of the general public to electromagnetic fields by way of health protection.

The device complies with RF specifications when the device used at 20 cm from your body.

Restricted to indoor use.

## UKCA Mark



## UKCA Declaration of Conformity

TP-Link hereby declares that the device is in compliance with the essential requirements and other relevant provisions of the Radio Equipment Regulations 2017.

The original UK Declaration of Conformity may be found at <https://www.tp-link.com/support/ukca/>.

## Canadian Compliance Statement

This device contains licence-exempt transmitter(s)/receiver(s) that comply with Innovation, Science and Economic Development Canada's licence-exempt RSS(s). Operation is subject to the following two conditions:

1. This device may not cause interference.
2. This device must accept any interference, including interference that may cause undesired operation of the device.

L'émetteur/récepteur exempt de licence contenu dans le présent appareil est conforme aux CNR d'Innovation, Sciences et Développement économique Canada applicables aux appareils radio exempts de licence. L'exploitation est autorisée aux deux conditions suivantes :

1. l'appareil ne doit pas produire de brouillage;
2. l'utilisateur de l'appareil doit accepter tout brouillage radioélectrique subi, même si le brouillage est susceptible d'en compromettre le fonctionnement

## Radiation Exposure Statement:

This equipment complies with IC radiation exposure limits set forth for an uncontrolled environment. This equipment should be installed and operated with minimum distance 20cm between the radiator & your body.

## Déclaration d'exposition aux radiations:

Cet équipement est conforme aux limites d'exposition aux rayonnements IC établies pour un environnement non contrôlé. Cet équipement doit être installé et utilisé avec un minimum de 20 cm de distance entre la source de rayonnement et votre corps.

## Industry Canada Statement

CAN ICES-3 (B)/NMB-3(B)

## Korea Warning Statements:

당해 무선설비는 운용중 전파혼신 가능성이 있음.

## NCC Notice & BSMI Notice:

注意!

取得審驗證明之低功率射頻器材，非經核准，公司、商號或使用者均不得擅自變更頻率、加大功率或變更原設計之特性及功能。

低功率射頻器材之使用不得影響飛航安全及干擾合法通信；經發現有干擾現象時，應立即停用，並改善至無干擾時方得繼續使用。

前述合法通信，指依電信管理法規定作業之無線電通信。

低功率射頻器材須忍受合法通信或工業、科學及醫療用電波輻射性電機設備之干擾。

### 安全諮詢及注意事項

- 請使用原裝電源供應器或只能按照本產品注明的電源類型使用本產品。
- 清潔本產品之前請先拔掉電源線。請勿使用液體、噴霧清潔劑或濕布進行清潔。
- 注意防潮，請勿將水或其他液體潑灑到本產品上。
- 插槽與開口供通風使用，以確保本產品的操作可靠並防止過熱，請勿堵塞或覆蓋開口。
- 請勿將本產品置放於靠近熱源的地方。除非有正常的通風，否則不可放在密閉位置中。
- 不要私自拆開機殼或自行維修，如產品有故障請與原廠或代理商聯繫。

### 限用物質含有情況標示聲明書

設備名稱： Equipment name Kasa Spot Pan Tilt, 24/7 Recording		型號（型式）： Type designation (Type) KC410S				
單元 Unit	限用物質及其化學符號 Restricted substances and its chemical symbols					
	鉛 Lead (Pb)	汞 Mercury (Hg)	鎘 Cadmium (Cd)	六價鉻 Hexavalent chromium (Cr+6)	多溴聯苯 Polybrominated biphenyls (PBB)	多溴二苯醚 Polybrominated diphenyl ethers (PBDE)
PCB	○	○	○	○	○	○
外殼	○	○	○	○	○	○
電源供應器	—	○	○	○	○	○
其他及其配件	—	○	○	○	○	○

備考 1. “超出 0.1 wt %” 及 “超出 0.01 wt %” 係指限用物質之百分比含量超出百分比含量基準值  
Note 1: “Exceeding 0.1 wt %” and “exceeding 0.01 wt %” indicate that the percentage content of the restricted substance exceeds the reference percentage value of presence condition.  
備考 2. “○” 係指該項限用物質之百分比含量未超出百分比含量基準值。  
Note 2: “○” indicates that the percentage content of the restricted substance does not exceed the percentage of reference value of presence.  
備考 3. “—” 係指該項限用物質為排除項目。  
Note 3: The “—” indicates that the restricted substance corresponds to the exemption.



Продукт сертифіковано згідно з правилами системи УкрСЕПРО на відповідність вимогам нормативних документів та вимогам, що передбачені чинними законодавчими актами України.





## Safety Information

- Keep the device away from water, fire, humidity or hot environments.
- Do not attempt to disassemble, repair, or modify the device. If you need service, please contact us.
- Do not use damaged charger or USB cable to charge the device.
- Do not use any other chargers than those recommended
- Do not use the device where wireless devices are not allowed.
- Adapter shall be installed near the equipment and shall be easily accessible.
- Use only power supplies which are provided by manufacturer and in the original packing of this product. If you have any questions, please don't hesitate to contact us.
- Operating Temperature: 0°C~40°C (32°F~104°F)

Please read and follow the above safety information when operating the device. We cannot guarantee that no accidents or damage will occur due to improper use of the device. Please use this product with care and operate at your own risk.

### Explanation of the symbols on the product label

Symbol	Explanation
	DC voltage
	Indoor use only
	RECYCLING This product bears the selective sorting symbol for Waste electrical and electronic equipment (WEEE). This means that this product must be handled pursuant to European directive 2012/19/EU in order to be recycled or dismantled to minimize its impact on the environment. User has the choice to give his product to a competent recycling organization or to the retailer when he buys a new electrical or electronic equipment.