

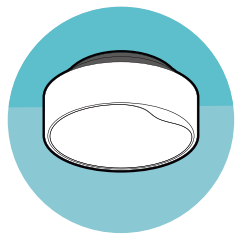

# User Guide

## AX3000 Whole Home Mesh Wi-Fi 6 AP with PoE



Ceiling Mount

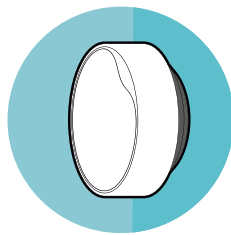

Wall Mount

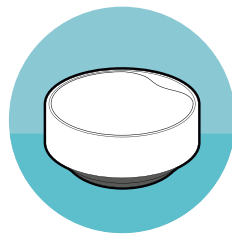

Tabletop



# Contents

About This Guide .....	1
Appearance .....	2
Power Up Your Device .....	3
Set Up Your Mesh Network .....	4
Mount Your Device .....	5
Authentication .....	9

# About This Guide

This guide provides a brief introduction to Whole Home Mesh Wi-Fi 6 AP with PoE and regulatory information. Features available in mesh device may vary by model and software version. The mesh device availability may also vary by region or ISP. All images, steps, and descriptions in this guide are only examples and may not reflect your actual mesh device experience.

## Conventions

In this guide, the following conventions are used:

Convention	Description
mesh device	Stands for Whole Home Mesh Wi-Fi 6 AP with PoE.
<u>Underline</u>	Hyperlinks are in teal and underlined. You can click to redirect to a website or a specific section.
Teal	Key information appears in teal, including management page text such as menus, items, buttons and so on.
📌 Note:	Ignoring this type of note might result in a malfunction or damage to the device.
💡 Tips:	Indicates important information that helps you make better use of your device.

## More Info

- Specific product information can be found on the product page at <https://www.tp-link.com>.
- A Technical Community is provided for you to discuss our products at <https://community.tp-link.com>.
- Our Technical Support contact information can be found at the [Help](#) center of the Aginet app and the [Contact Technical Support](#) page at <https://www.tp-link.com/support>.

## Speed/Coverage/Device Quantity Disclaimer

Maximum wireless signal rates are the physical rates derived from IEEE Standard 802.11 specifications. Actual wireless data throughput and wireless coverage, and quantity of connected devices are not guaranteed and will vary as a result of network conditions, client limitations, and environmental factors, including building materials, obstacles, volume and density of traffic, and client location.

## MU-MIMO Disclaimer

Use of MU-MIMO requires clients to also support MU-MIMO.

## IoT Compatibility Disclaimer

IoT compatibility refers only to smart devices that can be controlled via the Aginet app. Other wireless devices can still connect to mesh device for normal Wi-Fi use.

## Seamless Roaming Disclaimer

Clients need to support 802.11k/v/r and may require additional set up. Performance may vary depending on the client device.

# Appearance

Each mesh device has an LED that changes color according to its status, two 2.5 Gbps PoE ports, a power slot, and a reset button.

See the explanation below:

 Tip: The product label can be found at the bottom of the product.



**Pulse Yellow:**  
The device is starting up or resetting.

**Solid Yellow:**  
The connection quality of the device is normal.

**Pulse Blue:**  
The device is ready for setup or the device is establishing a mesh connection.

**Solid Blue:**  
The device has been set up, but the internet is unavailable.

**Pulse Green:**  
The device is upgrading firmware.

**Solid Green:**  
The device is all set up and connected to internet.

**Pulse Red:**  
The device has lost connection.

**Solid Red:**  
The device has an issue.

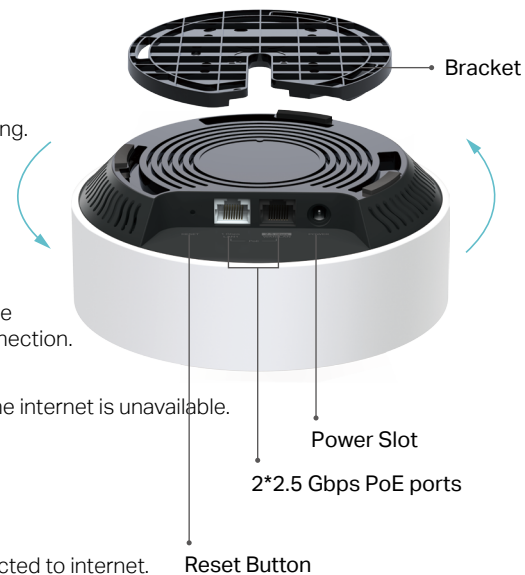

## Power Supply:

The mesh device can be powered via a power adapter or a PSE device (such as a PoE switch).

## Multi-Gig Internet Connection:

2× 2.5 Gbps ports make full use of gigabit speeds from your local ISP. PoE and WAN/LAN support meets all your internet demands.

## Reset:

Press for 1 second and release to reset mesh device to factory default settings. The light changing from pulsing yellow to solid yellow indicates a successful reset.

## Mounting Options



Ceiling Mount



Wall Mount



Tabletop

# Power Up Your Device

The mesh device can be powered via a power adapter or a PSE device (such as a PoE switch) which complies with Power Source Class 2 (PS2) or Limited Power Source (LPS) and Electrical Energy Source Class 1(ES1) of IEC 62368-1.

### Option1: Via PoE Switch (Compliant with 802.3at)

Connect an Ethernet cable from the PoE switch (compliant with 802.3at) to the mesh device's Ethernet port. The power should not be less than 18 W.

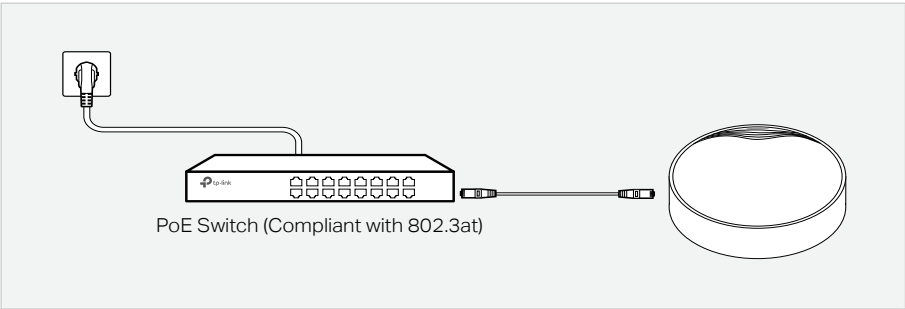

### Option2: Via Power Adapter

Plug one end of the provided power adapter into the power port of the mesh device and the other end to a standard electrical wall outlet.

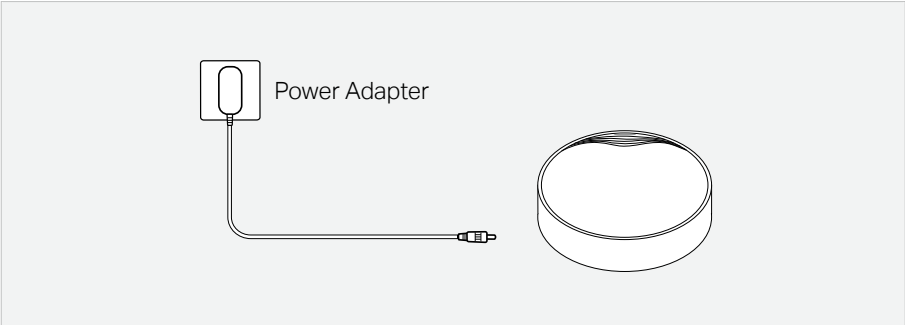

# Set Up Your Mesh Network

First let's start by setting up the mesh network. Get the TP-Link Aginet app for iOS or Android, then follow the app to walk through the setup.

## 1. Get the Aginet app

Download and install the Aginet app from Google Play or App Store, or by scanning the QR code below.

## 2. Log in with TP-Link ID

Open the app and log in with your TP-Link ID. If you don't have a TP-Link ID, create one first.

 **Tip:** If you forgot your login password, tap [Forgot Password](#). The app will help you reset your password.

## 3. Select your device type

Search for and select your device type. If you have more than one mesh device, tap the question below the search box to check how to maximize the overall network.

## 4. Plug in your mesh device

Power off your modem, connect your mesh device to the modem, then power them both on.

If you don't have a modem, connect your mesh device directly to the Ethernet outlet.

## 5. Specify your mesh device's location

Select or custom a location for your mesh device. The location will be used as the name of your mesh device.

## 6. Connect your mesh device to the internet

Select the internet connection type and enter the information. If you are not sure, contact your internet service provider.

## 7. Create your mesh Wi-Fi

Create the network name and password for your mesh device and connect to it.

## 8. Setup complete

Your mesh network is now up. You can connect your devices to the mesh network.

If you have more mesh devices, tap [+Add](#) to add them to your network.

# Mount Your Device

The mesh device can be mounted to the wall, the ceiling, or on a junction box, using the screws in the package. Choose the appropriate mounting methods.

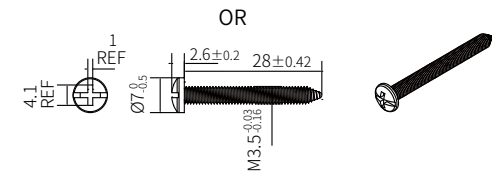
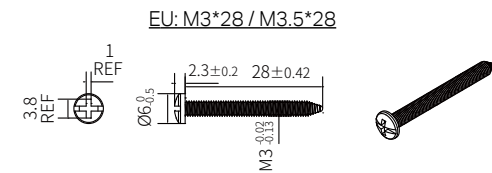
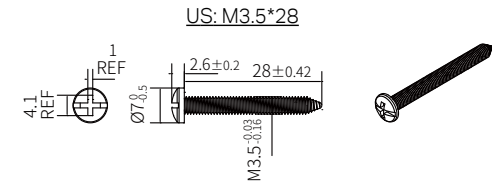
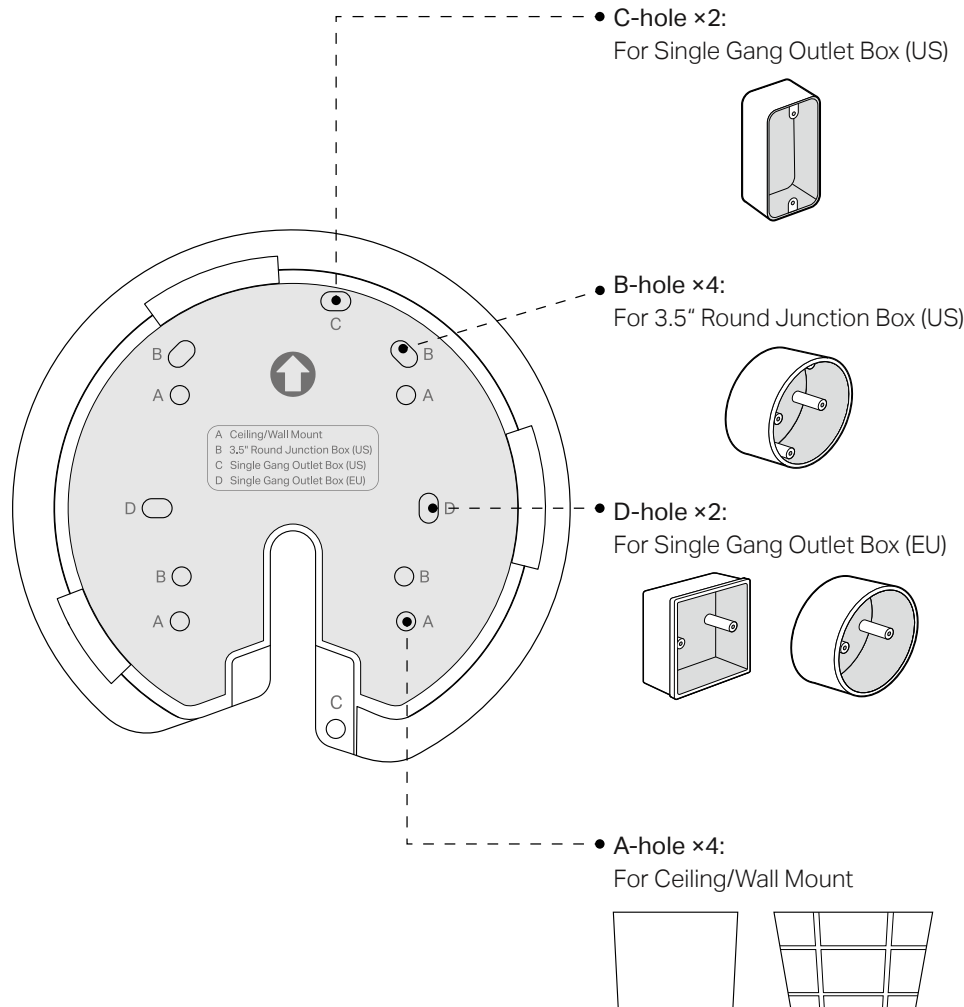

Wall Mount: ST3.5\*30

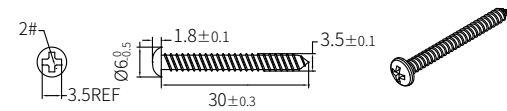

Ceiling Mount: M3\*30

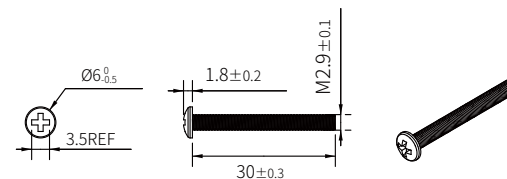

## Option 1: On the Wall/Ceiling

The mesh device can be mounted to the wall or the ceiling with the screws in the package.



Plastic Wall Anchors \*4



Self-tapping Screws \*4

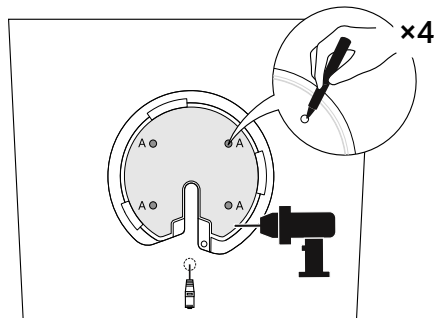

1. If your Ethernet cable feeds through the wall, position the mounting bracket above the cable hole.

Mark four positions for the screw holes and drill four 6 mm (15/64 in) diameter holes at the marked positions.

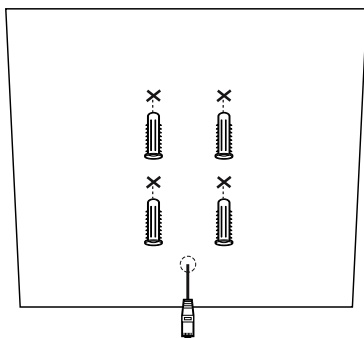

2. Insert the plastic wall anchors into the 6 mm diameter holes.

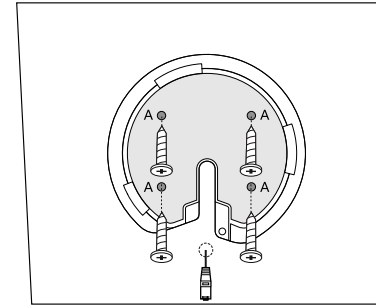

3. Secure the mounting bracket to the wall by driving the self-tapping screws into the anchors.
- Make sure the mounting bracket lies flat against the surface.

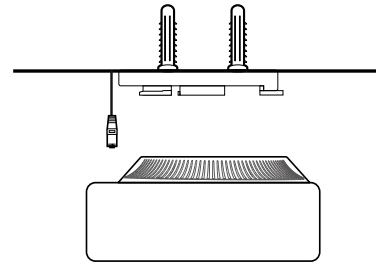

4. Connect the Ethernet cable to the Ethernet port on the mesh device.

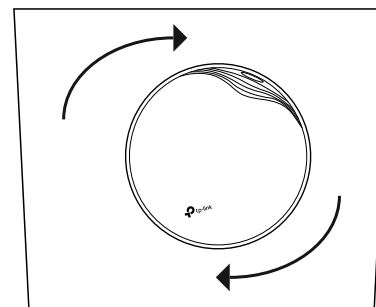

5. Orient the mesh device's LED according to the image, attach the mesh device to the mounting bracket, then rotate it clockwise until it locks into place.



## Option 2: On a Wall Junction Box

The mesh device can be mounted on a junction box. The junction box should be pre-installed with a running-in-wall Ethernet cable. Ensure that the mounting holes align to your junction box.

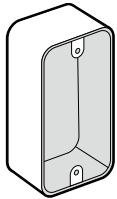

C-hole

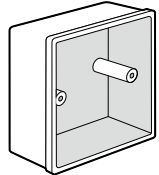

D-hole

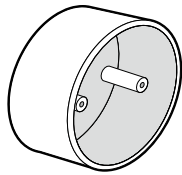

D-hole

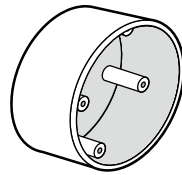

B-hole

\*Here the standard US wall junction box is used as an example.

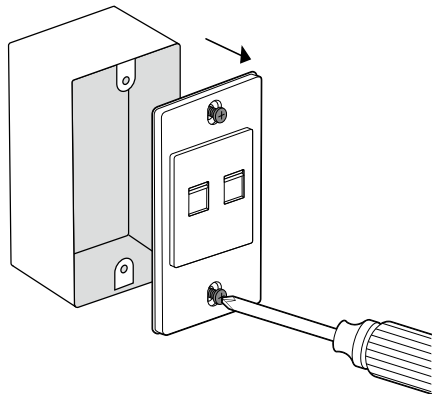

1. Detach the faceplate of the junction box with a Phillips screwdriver.

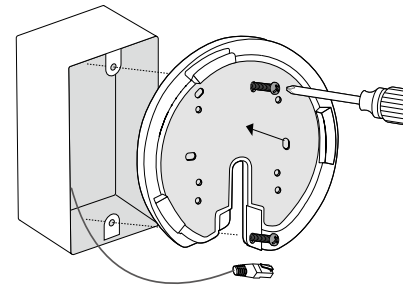

2. Feed the Ethernet cable through the mounting bracket. Insert the enclosed screws and tighten them with a Phillips screwdriver to secure the mounting bracket.

Notes:

1. Do not over tighten the screws.
2. If the enclosed screws do not fit the junction box, use the screws attached to the junction box instead.

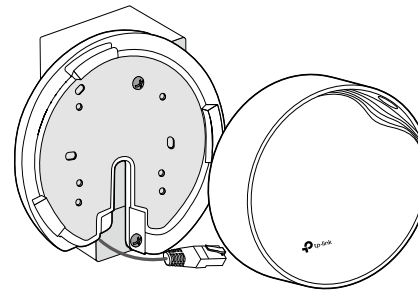

3. Connect the Ethernet cable to the Ethernet port on the mesh device.

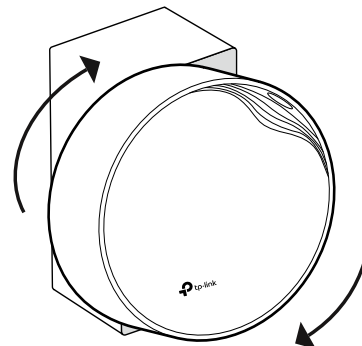

4. Orient the mesh device's LED according to the image, attach the mesh device to the mounting bracket, then rotate it clockwise until it locks into place.

## Option 3: In a Ceiling Tile

The mesh device can be installed in a ceiling tile with the screws in the package. Make sure the ceiling tile is larger than the mesh device.

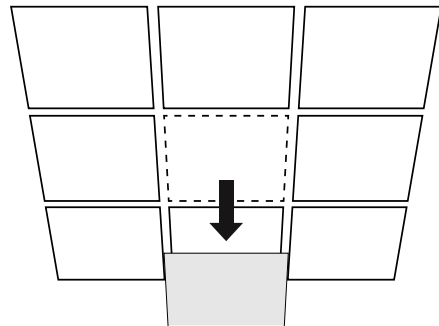

1. Remove the ceiling tile.

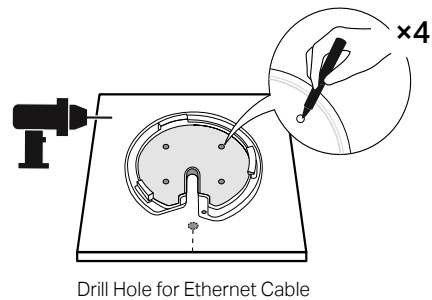

2. Place the mounting bracket in the center of the ceiling tile. Mark four positions for the screw holes and a location for the Ethernet cable hole.

Drill four 4 mm (5/32 in) diameter holes for the screws and a 25 mm (63/64 in) diameter hole for the Ethernet cable at the marked positions.

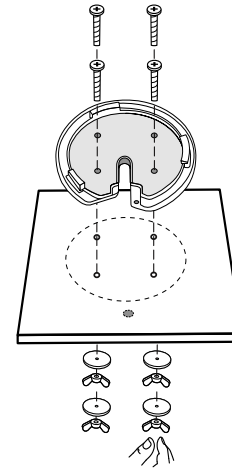

3. Secure the mounting bracket to the ceiling tile using four pan-head screws, washers, and wing nuts.

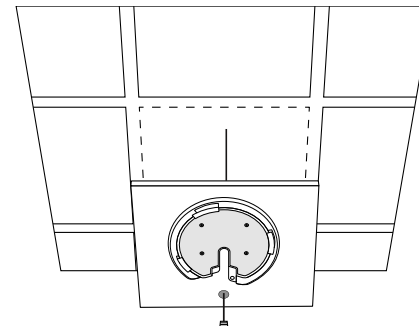

4. Feed the Ethernet cable through the hole and set the ceiling tile back into place.

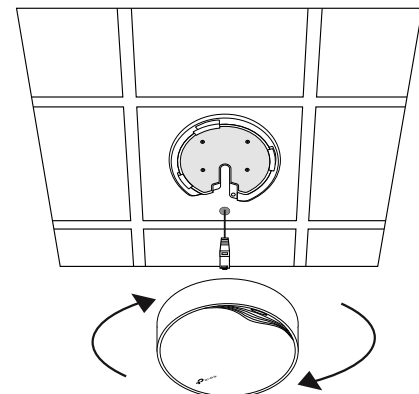

5. Orient the mesh device's LED according to the image, attach the mesh device to the mounting bracket, then rotate it clockwise until it locks into place.

# Authentication

## FCC Compliance Information Statement



**Product Name:** AX3000 Whole Home Mesh Wi-Fi 6 AP with PoE

**Model Number:** HX510-PoE

Component Name	Component Model
I.T.E POWER SUPPLY	T120150-2B4

### Responsible party:

#### TP-Link USA Corporation

Address: 10 Mauchly, Irvine, CA 92618

Website: <http://www.tp-link.com/us/>

Tel: +1 626 333 0234

Fax: +1 909 527 6804

E-mail: [sales.usa@tp-link.com](mailto:sales.usa@tp-link.com)

This equipment has been tested and found to comply with the limits for a Class B digital device, pursuant to part 15 of the FCC Rules. These limits are designed to provide reasonable protection against harmful interference in a residential installation. This equipment generates, uses and can radiate radio frequency energy and, if not installed and used in accordance with the instructions, may cause harmful interference to radio communications. However, there is no guarantee that interference will not occur in a particular installation. If this equipment does cause harmful interference to radio or television reception, which can be determined by turning the equipment off and on, the user is encouraged to try to correct the interference by one or more of the following measures:

- Reorient or relocate the receiving antenna.
- Increase the separation between the equipment and receiver.
- Connect the equipment into an outlet on a circuit different from that to which the receiver is connected.

- Consult the dealer or an experienced radio/ TV technician for help.

This device complies with part 15 of the FCC Rules. Operation is subject to the following two conditions:

1. This device may not cause harmful interference.
2. This device must accept any interference received, including interference that may cause undesired operation.

Any changes or modifications not expressly approved by the party responsible for compliance could void the user's authority to operate the equipment.

Note: The manufacturer is not responsible for any radio or TV interference caused by unauthorized modifications to this equipment. Such modifications could void the user's authority to operate the equipment.

### **FCC RF Radiation Exposure Statement**

This equipment complies with FCC RF radiation exposure limits set forth for an uncontrolled environment. This device and its antenna must not be co-located or operating in conjunction with any other antenna or transmitter.

"To comply with FCC RF exposure compliance requirements, this grant is applicable to only Mobile Configurations. The antennas used for this transmitter must be installed to provide a separation distance of at least 20 cm from all persons and must not be co-located or operating in conjunction with any other antenna or transmitter."

## FCC Compliance Information Statement



**Product Name:** I.T.E POWER SUPPLY

**Model Number:** T120150-2B4

**Responsible party:**

**TP-Link USA Corporation**

Address: 10 Mauchly, Irvine, CA 92618

Website: <http://www.tp-link.com/us/>

Tel: +1 626 333 0234

Fax: +1 909 527 6804

E-mail: [sales.usa@tp-link.com](mailto:sales.usa@tp-link.com)

This equipment has been tested and found to comply with the limits for a Class B digital device, pursuant to part 15 of the FCC Rules. These limits are designed to provide reasonable protection against harmful interference in a residential installation. This equipment generates, uses and can radiate radio frequency energy and, if not installed and used in accordance with the instructions, may cause harmful interference to radio communications. However, there is no guarantee that interference will not occur in a particular installation. If this equipment does cause harmful interference to radio or television reception, which can be determined by turning the equipment off and on, the user is encouraged to try to correct the interference by one or more of the following measures:

- Reorient or relocate the receiving antenna.
- Increase the separation between the equipment and receiver.
- Connect the equipment into an outlet on a circuit different from that to which the receiver is connected.
- Consult the dealer or an experienced radio/ TV technician for help.

This device complies with part 15 of the FCC Rules. Operation is subject to the following two conditions:

1. This device may not cause harmful interference.
2. This device must accept any interference received, including interference that may cause undesired operation.

Any changes or modifications not expressly approved by the party responsible for compliance could void the user's authority to operate the equipment.

We, TP-Link USA Corporation, has determined that the equipment shown as above has been shown to comply with the applicable technical standards, FCC part 15. There is no unauthorized change is made in the equipment and the equipment is properly maintained and operated.

Issue Date: 2023-10-08

## CE Mark Warning



This is a class B product. In a domestic environment, this product may cause radio interference, in which case the user may be required to take adequate measures.

## OPERATING FREQUENCY(the maximum transmitted power)

2400 MHz -2483.5 MHz (20dBm)

5150 MHz -5250 MHz (23dBm)

5250 MHz -5350 MHz (23dBm)

## EU Declaration of Conformity

TP-Link hereby declares that the device is in compliance with the essential requirements and other relevant provisions of directives 2014/53/EU, 2009/125/EC, 2011 /65/EU and (EU) 2015/863.

The original EU Declaration of Conformity may be found at <https://www.tp-link.com/en/support/ce/>

## RF Exposure Information

This device meets the EU requirements (2014/53/EU Article 3.1a) on the limitation of exposure of the general public to electromagnetic fields by way of health protection.

The device complies with RF specifications when the device used at 20 cm from your body.

## National restrictions

Attention: This device may only be used indoors in all EU member states and EFTA countries, and Northern Ireland.

	AT	BE	BG	CH	CY	CZ	DE	DK
	EE	EL	ES	FI	FR	HR	HU	IE
	IS	IT	LI	LT	LU	LV	MT	NL
	NO	PL	PT	RO	SE	SI	SK	UK(NI)

UKCA Mark



## UK Declaration of Conformity

TP-Link hereby declares that the device is in compliance with the essential requirements and other relevant provisions of the Radio Equipment Regulations 2017.

The original UK Declaration of Conformity may be found at <https://www.tp-link.com/support/ukca/>

## National restrictions

Attention: This device may only be used indoors in Great Britain.



## Canadian Compliance Statement

This device complies with Industry Canada license-exempt RSS standard(s). Operation is subject to the following two conditions:

1. This device may not cause interference, and
2. This device must accept any interference, including interference that may cause undesired operation of the device.

Le présent appareil est conforme aux CNR d'Industrie Canada applicables aux appareils radio exempts de licence. L'exploitation est autorisée aux deux conditions suivantes :

1. l'appareil ne doit pas produire de brouillage;
2. l'utilisateur de l'appareil doit accepter tout brouillage radioélectrique subi, même si le brouillage est susceptible d'en compromettre le fonctionnement.



### **Caution:**

The device for operation in the band 5150–5250 MHz is only for indoor use to reduce the potential for harmful interference to co-channel mobile satellite systems;

DFS (Dynamic Frequency Selection) products that operate in the bands 5250- 5350 MHz.

### **Avertissement:**

Le dispositif fonctionnant dans la bande 5150-5250 MHz est réservé uniquement pour une utilisation à l'intérieur afin de réduire les risques de brouillage préjudiciable aux systèmes de satellites mobiles utilisant les mêmes canaux;

Les produits utilisant la technique d'atténuation DFS (sélection dynamique des fréquences) sur les bandes 5250- 5350 MHz.

### **Radiation Exposure Statement:**

This equipment complies with IC radiation exposure limits set forth for an uncontrolled environment. This equipment should be installed and operated with minimum distance 20cm between the radiator & your body.

### **Déclaration d'exposition aux radiations:**

Cet équipement est conforme aux limites d'exposition aux rayonnements IC établies pour un environnement non contrôlé. Cet équipement doit être installé et utilisé avec un minimum de 20 cm de distance entre la source de rayonnement et votre corps.

### **Industry Canada Statement**

CAN ICES-3 (B)/NMB-3(B)

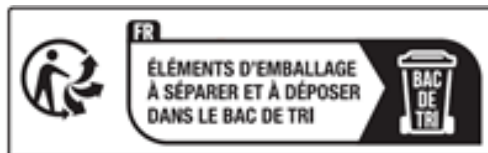

### **Korea Warning Statements:**

당해 무선설비는 운용중 전파혼신 가능성이 있음.

## NCC Notice & BSMI Notice:

注意!

取得審驗證明之低功率射頻器材，非經核准，公司、商號或使用者均不得擅自變更頻率、加大功率或變更原設計之特性及功能。

低功率射頻器材之使用不得影響飛航安全及干擾合法通信；經發現有干擾現象時，應立即停用，並改善至無干擾時方得繼續使用。

前述合法通信，指依電信管理法規定作業之無線電通信。

低功率射頻器材須忍受合法通信或工業、科學及醫療用電波輻射性電機設備之干擾。

應避免影響附近雷達系統之操作。

## 安全諮詢及注意事項

- 請使用原裝電源供應器或只能按照本產品注明的電源類型使用本產品。
- 清潔本產品之前請先切斷電源。請勿使用液體、噴霧清潔劑或濕布進行清潔。
- 注意防潮，請勿將水或其他液體潑灑到本產品上。
- 插槽與開口供通風使用，以確保本產品的操作可靠並防止過熱，請勿堵塞或覆蓋開口。
- 請勿將本產品置放於靠近熱源的地方。除非有正常的通風，否則不可放在密閉位置中。
- 不要私自拆開機殼或自行維修，如產品有故障請與原廠或代理商聯繫。

## 限用物質含有情況標示聲明書

設備名稱： Equipment name:		型號（型式）： Type designation (Type)				
AX3000 Whole Home Mesh Wi-Fi 6 AP with PoE		HX510-PoE				
單元 Unit	限用物質及其化學符號 Restricted substances and its chemical symbols					
	鉛 Lead (Pb)	汞 Mercury (Hg)	鎘 Cadmium (Cd)	六價鉻 Hexavalent chromium (Cr <sup>+6</sup> )	多溴聯苯 Polybrominated biphenyls (PBB)	多溴二苯醚 Polybrominated diphenyl ethers (PBDE)
PCB	○	○	○	○	○	○

外殼	○	○	○	○	○	○
電源供應器	—	○	○	○	○	○
其他及其配件	—	○	○	○	○	○

備考1. 超出0.1 wt %” 及 “超出0.01 wt %” 系指限用物質之百分比含量超出百分比含量基準值。

Note 1: “Exceeding 0.1 wt %” and “exceeding 0.01 wt %” indicate that the percentage content of the restricted substance exceeds the reference percentage value of presence condition.

備考2. “○” 系指該項限用物質之百分比含量未超出百分比含量基準值。

Note 2: “○” indicates that the percentage content of the restricted substance does not exceed the percentage of reference value of presence.

備考3. “—” 系指該項限用物質為排除項目。

Note 3: The “—” indicates that the restricted substance corresponds to the exemption.



Продукт сертифіковано згідно с правилами системи УкрСЕПРО на відповідність вимогам нормативних документів та вимогам, що передбачені чинними законодавчими актами України.



#### Safety Information









- Keep the device away from water, fire, humidity or hot environments.
- Do not attempt to disassemble, repair, or modify the device. If you need service, please contact us.
- Do not use damaged charger or USB cable to charge the device.
- Do not use any other chargers than those recommended.
- Do not use the device where wireless devices are not allowed.
- Adapter shall be installed near the equipment and shall be easily accessible.
- This product uses radios and other components that emit electromagnetic fields. Electromagnetic fields and magnets may interfere with pacemakers and other implanted medical devices. Always keep the product and its power adapter more than 15 cm (6 inches) away from any

pacemakers or other implanted medical devices. If you suspect your product is interfering with your pacemaker or any other implanted medical device, turn off your product and consult your physician for information specific to your medical device.

- Use only power supplies which are provided by manufacturer and in the original packing of this product. If you have any questions, please don't hesitate to contact us.
- Operating Temperature: 0°C~40°C (32°F~104°F)

Please read and follow the above safety information when operating the device. We cannot guarantee that no accidents or damage will occur due to improper use of the device. Please use this product with care and operate at your own risk.

### Explanation of the symbols on the product label

Symbol	Explanation
	Alternating current
	DC voltage
	Caution
	Operator's manual
	Indoor use only
	Class II equipment
	Energy efficiency Marking
	Polarity of d.c. power connector
	<p>RECYCLING</p> <p>This product bears the selective sorting symbol for Waste electrical and electronic equipment (WEEE). This means that this product must be handled pursuant to European directive 2012/19/EU in order to be recycled or dismantled to minimize its impact on the environment.</p> <p>User has the choice to give his product to a competent recycling organization or to the retailer when he buys a new electrical or electronic equipment.</p>