

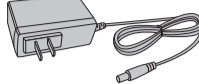

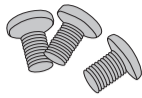

Quick Installation Guide

Network Video Recorder

*Images may differ from actual products.

1 Package Contents

<p>Network Video Recorder</p> 	<p>Power Adapter</p> 	<p>HDD Screws</p> 
<p>Mouse</p> 	<p>Quick Installation Guide</p> 	<p>Rubber Feet (for some models)</p> 

2 Product Overview

Front Panel

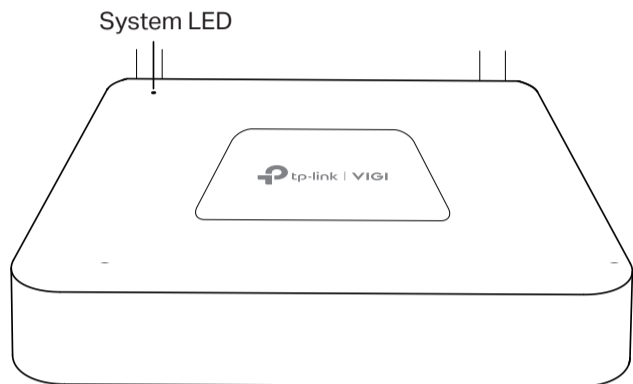

LED	Indication
System	On: System is running normally. Off: System is running abnormally.

Back Panel

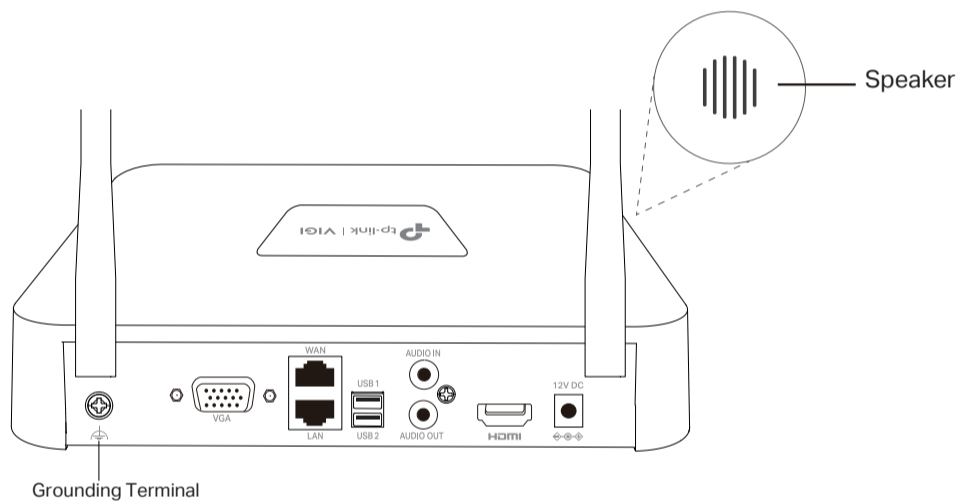

Interface	Description
WAN	RJ45 10/100Mbps self-adaptive Ethernet port. For connecting to internet.
LAN	RJ45 10/100Mbps self-adaptive Ethernet port. For connecting PC or other wired devices.
USB	2 USB ports for additional devices such as USB mouse, USB storage device, and USB keyboard.
AUDIO IN / AUDIO OUT	Connector for audio input and output. Note: Audio input only supports microphones with power supply.
HDMI	Output port for high-definition audio and video signals. Connect your monitor to this port if it uses HDMI connection.
VGA	Output port for analog video signals. Connect your monitor to this port if it uses VGA connection.
POWER	Connector for power input.

3 Hard Drive Installation

When installing for the first time, please prepare a 3.5-inch hard disk drive (HDD). It is recommended to use the HDD of surveillance or enterprise level. Before installation, please disconnect the power from the network video recorder (NVR).

1. Press and hold the side cover button to remove the side cover.

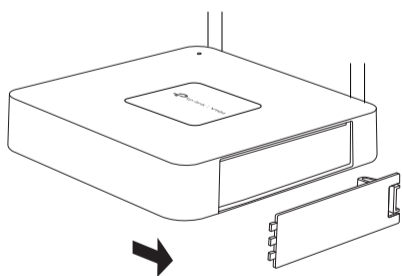

3. Fasten the screws to secure the HDD according to the actual HDD screw holes. Stick the rubber feet.

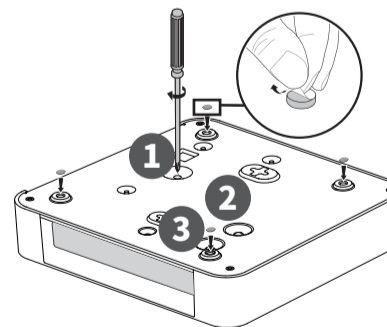

2. Push the HDD and insert it into the hard disk slot.

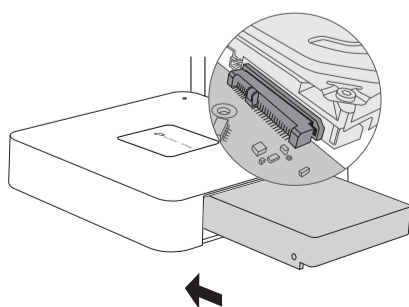

4. Install back the side cover.

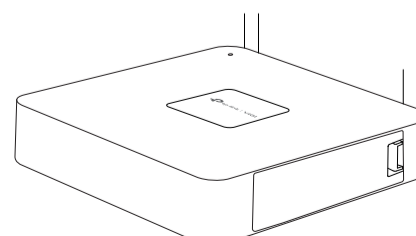

4 Hardware Connection

Follow the steps below to complete the hardware connection.

1. Connect your monitor to the HDMI or VGA port according to the connection port it supports.
2. Connect your monitor to a power source.
3. Connect the WAN port of the NVR to the internet with an Ethernet cable.
4. Connect the provided USB Mouse to the USB Interface of the NVR.
5. Connect the power adapter to the NVR.

⚠ Cautions

- If you want to turn off the NVR after installing the hard drive, right click on the Live View screen and click the Power button  on **Main Menu** of your monitor. Do not unplug it directly.
- The input voltage should match the power requirements of the NVR.
- The Speaker on the NVR may be triggered when no hard drive is installed or the hard drive in the NVR hasn't been initialized. You can turn it off in **Event-Exception Detection-Disk Exception**.

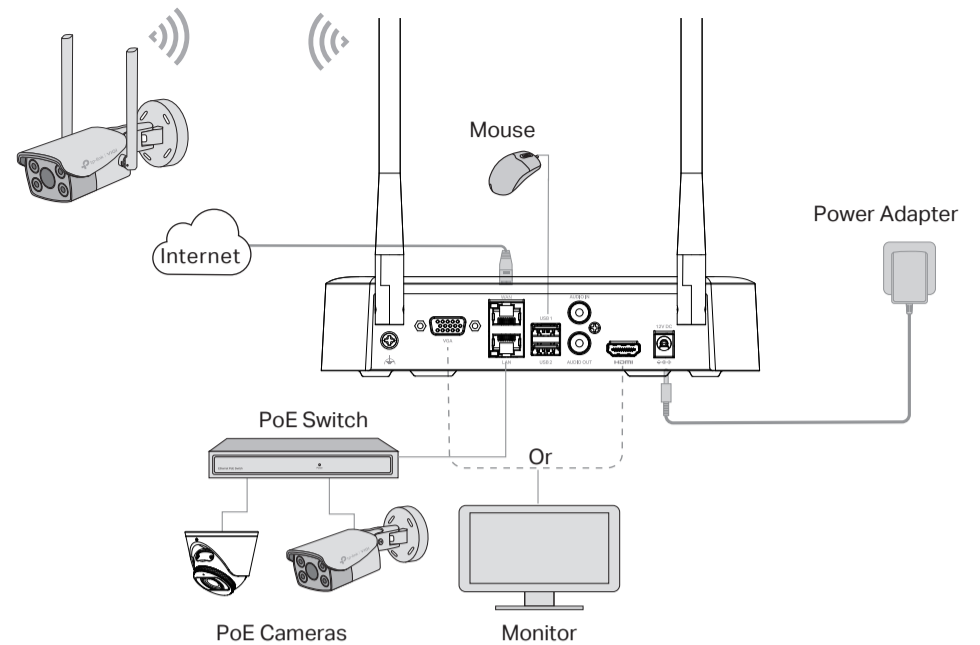

5 Configuration

NVR can add and manage cameras in batches.

The NVR supports One-Click Wi-Fi IPC Addition. Simply pair your Wi-Fi cameras to VIGI NVR with Wi-Fi for a quick wireless surveillance system deployment.

1. Power on the uninitialized VIGI Wi-Fi camera.
Note: For a wired camera, connect it to the NVR's LAN port.
2. Turn on the monitor and you will enter the NVR's GUI. Confirm the basic information and change the information if needed. Configure the account settings which will be used for future logins and adding cameras. You will also see that all cameras in the network listed.
Note: You can change the Operation Mode and configure the NVR's network settings to connect it to the internet.
3. Click Next, the camera will be added automatically, and follow the steps to complete the setup.

Note:

1. Only VIGI Wi-Fi cameras support One-Click Wi-Fi IPC Addition
2. One-Click Wi-Fi IPC Addition requires that the Wi-Fi camera is not initialized or connected to the other network devices via Ethernet cable.
3. If you don't want to use smart initialization, you can follow the setup wizard to add cameras in your network and complete the setup.

(Optional) Bind your NVR to a TP-Link ID for remote access and management.

- a. Right click on the Live View screen and click **Settings**.
- b. Click **Cloud Services** on the top, enter your TP-Link ID and password, and click **Bind**.

Note:

- Make sure your NVR can get access to the internet before binding.
- If you don't have a TP-Link ID, sign up first.
- If your NVR fails to connect to the internet, please refer to **FAQ-Q3**.
- For more instructions, please refer to the NVR's User Guide.

If you want to add a camera after Quick Setup, please follow the steps below:

1. Right click on the Live View screen and click **Add Camera**.
2. Select a camera and click + to add your camera directly. If you have disabled **Plug and Play** on your NVR, please create a password or use the preset password for your unset camera.

Note:

- The password preset for cameras in **Quick Setup** will be applied to your unset cameras.
- If your cameras have been activated, use the previous passwords to add and manage the cameras.
- If you can't find your camera, refer to **FAQ-Q2**.

More Management Methods

Method 1: Via a Web Browser

View live video and modify NVR settings via a web browser.

1. Connect the PC to the NVR by connecting to NVR's LAN port or using the default SSID printed on the product label.
2. Open a web browser and enter **https://NVR's IP address** (https://192.168.253.240 by default).
3. Configure the internet connection type to connect the NVR to internet.
4. Follow the step-by-step web instructions to initialize the NVR and add cameras.

Method 2: Via the TP-Link VIGI App

After connecting the NVR to the internet, you can remotely view live video, manage NVR, and get instant alerts.

1. Download and install the **TP-Link VIGI** app.



2. Open the app and log in with your TP-Link ID. If you don't have an account, sign up first.
3. Tap the + button on the top right and follow the app instructions to add your NVR.

Frequently Asked Questions

Q1. What should I do if no cameras are found?

- A1. Refresh to discover your cameras again.
- A2. Make sure the cameras are powered on.
- A3. Make sure your cameras and NVR or computer are in the same network.
- A4. Try to add your cameras manually.

Q2. What should I do if my NVR fails to connect to the internet?

- A1. Check if the internet is working properly.
- A2. Make sure your NVR is in the same network segment as your network devices, or select **Auto** as the mode to configure the NVR to obtain a dynamic IP address. For more details, please refer to the NVR's User Guide.

If you have more questions, please visit <https://www.tp-link.com/support/faq/2850/>.

EU Declaration of Conformity

TP-Link hereby declares that the device is in compliance with the essential requirements and other relevant provisions of directives 2014/53/EU, 2009/125/EC, 2011/65/EU and (EU) 2015/863.

The original EU declaration of conformity may be found at <https://www.tp-link.com/en/support/ce/>.

UK Declaration of Conformity

TP-Link hereby declares that the device is in compliance with the essential requirements and other relevant provisions of the Radio Equipment Regulations 2017.

The original UK declaration of conformity may be found at <https://www.tp-link.com/support/ukca/>.

For technical support, the user guide and other information, please visit <https://www.tp-link.com/support>, or simply scan the QR code.

To ask questions, find answers, and communicate with TP-Link users or engineers, please visit <https://community.tp-link.com> to join TP-Link Community.

The terms HDMI, HDMI High-Definition Multimedia Interface, HDMI trade dress and the HDMI Logos are trademarks or registered trademarks of HDMI Licensing Administrator, Inc.



Safety Information

- This device is restricted to indoor use only.
- Keep the device away from water, fire, humidity or hot environments.
- Do not attempt to disassemble, repair, or modify the device. If you need service, please contact us.
- Do not use damaged charger or USB cable to charge the device.
- Do not use any other chargers than those recommended.
- Adapter shall be installed near the equipment and shall be easily accessible.
- Do not use the device where wireless devices are not allowed.
- Use only power supplies which are provided by manufacturer and in the original packing of this product. If you have any questions, please don't hesitate to contact us.
- Avoid disposal of a battery into fire or a hot oven, or mechanically crushing or cutting of a battery, that can result in an explosion.
- Place the device with its bottom surface downward. Install it at stable places, and prevent it from falling.
- The power adapter must be used indoors. Make sure that the temperature of the power adapter is within 0-40°C.
- **CAUTION: RISK OF EXPLOSION IF BATTERY IS REPLACED BY AN INCORRECT TYPE. DISPOSE OF USED BATTERIES ACCORDING TO THE INSTRUCTIONS.**

*Some devices may be incompatible, such as wireless mouse.

Please read and follow the above safety information when operating the device. We cannot guarantee that no accidents or damage will occur due to improper use of the device. Please use this product with care and operate at your own risk.

CAUTION!

Avoid replacement of a battery with an incorrect type that can defeat a safeguard.

Avoid disposal of a battery into fire or a hot oven, or mechanically crushing or cutting of a battery, that can result in an explosion. Do not leave a battery in an extremely high temperature surrounding environment that can result in an explosion or the leakage of flammable liquid or gas; Do not leave a battery subjected to extremely low air pressure that may result in an explosion or the leakage of flammable liquid or gas.

CAUTION: Do not ingest battery, Chemical Burn Hazard

This product contains a coin/button cell battery. If the coin/button cell battery is swallowed, it can cause severe internal burns in just 2 hours and can lead to death.

Keep new and used batteries away from children.

If the battery compartment does not close securely, stop using the product and keep it away from children.

If you think batteries might have been swallowed or placed inside any part of the body, seek immediate medical attention.

This equipment is not suitable for use in locations where children are likely to be present, such as family environment, school, children's playground and so on.